

JVC



DVD PLAYER & VIDEO CASSETTE RECORDER

HR-XVS20E

FIRST
See
AUTO SET UP
on **PAGE 14**

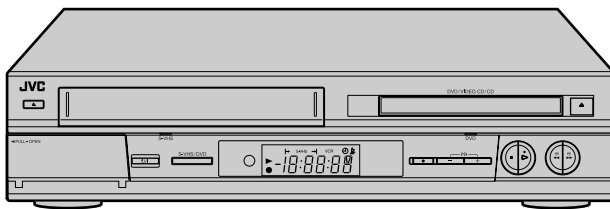

SHOWVIEW®

Hi-Fi **SVHS**
625

Super VHS ET

DVD
VIDEO™

dts
DIGITAL OUT

DOLBY
DIGITAL

COMPACT
disc
DIGITAL VIDEO

COMPACT
disc
DIGITAL AUDIO

3D
3D-PHONIC

INSTRUCTIONS

LPT0757-001A

EN

Safety Precautions

The rating plate and the safety caution are on the rear of the unit.

WARNING: DANGEROUS VOLTAGE INSIDE

WARNING: TO PREVENT FIRE OR SHOCK HAZARD, DO NOT EXPOSE THIS UNIT TO RAIN OR MOISTURE.

CAUTION

- When you are not using the unit for a long period of time, it is recommended that you disconnect the power cord from the mains outlet.
- Dangerous voltage inside. Refer internal servicing to qualified service personnel. To prevent electric shock or fire hazard, remove the power cord from the mains outlet prior to connecting or disconnecting any signal lead or aerial.

CAUTION

A DVD/VCR IS A CLASS 1 LASER PRODUCT. HOWEVER THIS DVD/VCR USES A VISIBLE LASER BEAM WHICH COULD CAUSE HAZARDOUS RADIATION EXPOSURE IF DIRECTED. BE SURE TO OPERATE THE UNIT CORRECTLY AS INSTRUCTED. WHEN THIS DVD/VCR IS PLUGGED INTO THE WALL OUTLET, DO NOT PLACE YOUR EYES CLOSE TO THE OPENING OF THE DISC TRAY AND OTHER OPENINGS TO LOOK INTO THE INSIDE OF THIS DVD/VCR.

USE OF CONTROLS OR ADJUSTMENTS OR PERFORMANCE OF PROCEDURES OTHER THAN THOSE SPECIFIED HEREIN MAY RESULT IN HAZARDOUS RADIATION EXPOSURE.

DO NOT OPEN COVERS AND DO NOT REPAIR YOURSELF. REFER SERVICING TO QUALIFIED PERSONNEL.

WARNING (S-VHS deck only)

There are two different types of SECAM colour systems: SECAM-L, used in FRANCE (also called SECAM-West), and SECAM-B, used in Eastern European countries (also called SECAM-East).

1. This unit can also receive SECAM-B colour television signals for recording and playback.
2. Recordings made of SECAM-B television signals produce monochrome pictures if played back on a video recorder of SECAM-L standard, or do not produce normal colour pictures if played back on a PAL video recorder with SECAM-B system incorporated (even if the TV set is SECAM-compatible).
3. SECAM-L prerecorded cassettes or recordings made with a SECAM-L video recorder produce monochrome pictures when played back with this unit.
4. This unit cannot be used for the SECAM-L standard. Use a SECAM-L recorder to record SECAM-L signals.

IMPORTANT

- Please read the various precautions on pages 2 and 3 before installing or operating the unit.
- It should be noted that it may be unlawful to re-record pre-recorded tapes, DVDs, or discs without the consent of the owner of copyright in the sound or video recording, broadcast or cable programme and in any literary, dramatic, musical, or artistic work embodied therein.

Use only discs marked with the following.



DVD
(8 cm /12 cm disc)



Video CDs
(8 cm /12 cm disc)



Audio CDs
(8 cm /12 cm disc)



- Manufactured under license from Dolby Laboratories. "Dolby" and the double-D symbol are trademarks of Dolby Laboratories. Confidential unpublished works.
- "DTS" and "DTS Digital Out" are trademarks of Digital Theater System, Inc.
- Cassettes marked "S-VHS" and "VHS" can be used with this unit. However, S-VHS recordings are possible only with cassettes marked "S-VHS".
By using the S-VHS ET function, it is possible to record and play back with S-VHS picture quality on VHS cassettes with this unit.
- SHOWVIEW is a registered trademark of Gemstar Development Corporation. The SHOWVIEW system is manufactured under licence from Gemstar Development Corporation.
- This product incorporates copyright protection technology that is protected by method claims of certain U.S. patents and other intellectual property rights owned by Macrovision Corporation and other rights owners. Use of this copyright protection technology must be authorized by Macrovision Corporation, and is intended for home and other limited viewing users only unless otherwise authorized by Macrovision Corporation. Reverse engineering or disassembly is prohibited.

For Italy:

"It is declared that this product, brand JVC, conforms to the Ministry Decree n. 548 of 28 Aug.'95 published in the Official Gazette of the Italian Republic n. 301 of 28 Dec.'95"

The STANDBY/ON ϕ /I button does not completely shut off mains power from the unit, but switches operating current on and off. " ϕ " shows electrical power standby and "I" shows ON.

Video tapes recorded with this unit in the LP/EP (Long Play/Extended Play) mode cannot be played back on a single-speed video recorder. (S-VHS deck only)

When the equipment is installed in a cabinet or a shelf, make sure that it has sufficient space on all sides to allow for ventilation (10 cm or more on both sides, on top and at the rear.)

When discarding batteries, environmental problems must be considered and the local rules or laws governing the disposal of these batteries must be followed strictly.

Failure to heed the following precautions may result in damage to the unit, remote control or video cassette.

1. DO NOT place the unit —

- in an environment prone to extreme temperatures or humidity.
- in direct sunlight.
- in a dusty environment.
- in an environment where strong magnetic fields are generated.
- on a surface that is unstable or subject to vibration.

2. DO NOT block the unit's ventilation openings or holes.

(If the ventilation openings or holes are blocked by a newspaper or cloth, etc., the heat may not be able to get out.)

3. DO NOT place heavy objects on the unit or remote control.

4. DO NOT place anything which might spill on top of the unit or remote control.

(If water or liquid is allowed to enter this equipment, fire or electric shock may be caused.)

5. DO NOT expose the apparatus to dripping or splashing.

6. DO NOT use this equipment in a bathroom or places with water. Also DO NOT place any containers filled with water or liquids (such as cosmetics or medicines, flower vases, potted plants, cups, etc.) on top of this unit.

7. DO NOT place any naked flame sources, such as lighted candles, on the apparatus.

8. AVOID violent shocks to the unit during transport.

MOISTURE CONDENSATION

Moisture in the air will condense on the unit when you move it from a cold place to a warm place, or under extremely humid conditions—just as water droplets form in the surface of a glass filled with cold liquid. Moisture condensation on the head drum will cause damage to the tape. In conditions where condensation may occur, keep the unit turned on for a few hours to let the moisture dry.

ATTENTION

To mobile phone users:

Using a mobile phone in the vicinity of the unit may cause picture vibration on the TV screen or change the screen to a blue back display.

On placing the unit:







Some TVs or other appliances generates strong magnetic fields. Do not place such appliance on top of the unit as it may cause picture disturbance.

SAFETY FIRST	2	EDITING (S-VHS DECK)	58
Safety Precautions	2	Edit From A Camcorder	58
DISC INFORMATION	5	Edit To Or From Another Video Recorder	59
About Discs	5	Output/Input Set	60
INDEX	8	Dubbing (from DVD to S-VHS)	62
INSTALLING YOUR NEW UNIT	12	EDITING (DVD DECK)	63
Basic Connections	12	Digital Audio Dubbing	63
INITIAL SETTINGS	13	REMOTE CONTROL	64
Auto Set Up	13	Remote Control Functions	64
Preset Download	15	SYSTEM CONNECTIONS	66
Monitor Set (DVD deck)	17	Connecting To A Satellite Receiver	66
Language	18	Connecting/Using A Decoder	68
T-V LINK	21	Connecting To A Dolby Digital Decoder or An Amplifier With A Built-in DTS (DVD deck only)	69
T-V Link Functions	21	SUBSIDIARY SETTINGS	70
OPERATIONS ON S-VHS DECK	22	Mode Set (S-VHS deck)	70
Basic Playback	22	Mode Set (DVD deck)	75
Playback Features	23	Tuner Set	78
Basic Recording	26	Clock Set	84
Recording Features	27	Video Channel Set	86
B.E.S.T. Picture System	29	TROUBLESHOOTING	87
SHOWVIEW® Timer Programming	30	QUESTIONS AND ANSWERS	91
Express Timer Programming	32	SPECIFICATIONS	92
Automatic Satellite Programme Recording	35	LIST OF TERMS	93
OPERATIONS ON DVD DECK	36		
Basic Playback	36		
Playback Features	37		
Playback Features with Play Set Up Menu	45		
Parental Lock	50		
About MP3 Disc	54		
Basic Playback	55		
Playback Features with Play Set Up menu	56		

About Discs

Playable Discs

You can use the discs with the following logos for playback only.

<p>DVD VIDEO</p> 	<p>Video CD</p> 
<p>Music CD</p>  <p>CD-DA files</p>	<p>CD-R</p>  <p>CD-DA/MP3 files</p>
<p>CD-RW</p>  <p>CD-DA/MP3 files</p>	<p>CD-ROM</p>  <p>MP3 files</p>

- Discs other than the above cannot be played back.
- DVD video discs have a region number. Discs whose region number includes "ALL" or "2" can be played back on this unit.
- Operation and audio quality of this unit is not guaranteed for discs that do not conform to the Compact Disc specification (CD-DA).
Before you play back a CD, check for the CD logo and read the notes on the package to confirm that it conforms to the Compact Disc specification.
- Depending on the intentions of the author of the software, recording conditions of DVD discs and Video CD discs may be restricted. Since this unit plays back discs according to the intentions of the author of the software as indicated on the disc, some functions may not operate as commanded.
- When switching from the first layer to the second layer of double-layered DVD VIDEO discs, the image and sound may be momentarily distorted. This is not a malfunction.

Unplayable Discs

The following types of discs cannot be played using this unit. Do not attempt to play back any kind of disc that is damaged (cracked, warped, or repaired with adhesive tape) or discs in unusual shapes (heart-shaped, octagonal, or other forms). If such discs are accidentally played back, it may cause noise that can lead to speaker damage.

- CD-ROM discs (including PHOTO-CD and CD-G)
- DVD AUDIO discs
- Super Audio CDs (SACD)
- 1.3-GB double density CDs (DDCD)
- High density CDs (HDCD)

The following discs also cannot be played back.

- Discs which have a region number other than "2"
- DVD+RW formatted discs
- DVD-RW formatted discs
- DVD-RAM
- DVD-R







Region Number

The world is divided into 6 regions for DVD VIDEO discs. DVD VIDEO discs are assigned a region number to indicate which region they may be played back in. A disc cannot be played back on this unit unless the region number of the disc matches that of the unit. The region number for this unit is "2". Only discs whose region number includes "2" can be played back such as shown below.

Examples of DVD VIDEO labels which can be played back using this unit.







Marks of discs in this instruction manual

	Allows operation with a DVD VIDEO disc.		Allows operation with a CD-R/RW disc.
	Allows operation with a Video CD disc.		Allows operation with a disc including MP3 files.
	Allows operation with a Audio CD disc.		Allows operation with a CD-ROM disc.



DVD VIDEO Marks

Sometimes marks are printed on a DVD disc and/or on its packaging to indicate information regarding the contents and functions of a disc. Check marks indicating the contents and functions of a disc. Note, however, that in some cases a disc may not include a mark even for a function it supports.

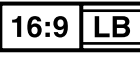
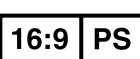
Marks related to video

Mark	Description
	Number of subtitles
	Number of angles
	Recorded under the standard 4:3 aspect ratio
	Screen includes black bands at top and bottom of image which has a standard 4:3 aspect ratio (letter box)
	Video playback is in Wide video mode (16:9) on wide televisions, but in letter box on televisions with standard 4:3 aspect ratio.
	Video playback is in Wide video mode (16:9) on wide televisions, but pan and scan is used on televisions with standard 4:3 aspect ratio (either the left or right side of the image is cut-out).

Marks related to audio

Mark	Description
	Number of audio tracks
	Dolby Digital mark Dolby Laboratories has developed a digital surround system for the home. This mark indicates that you may enjoy 5.1-channel audio (front left and right, center, rear left and right, and a channel for LFE (Low-Frequency Effects)).
	DTS (Digital Theater System) You can enjoy DTS audio if you connect the amplifier with a built-in DTS decoder to the DIGITAL AUDIO OUT connector of the unit.

File Structure of Discs

DVD VIDEO

Typically, DVD VIDEO discs are made up of larger units called "titles". Each title has a number (title number) that can be used to select desired titles. Titles are further divided into units called "chapters". Each chapter has a number (chapter number) that can also be used to select desired chapters. Note that some discs are not divided into titles and chapters.

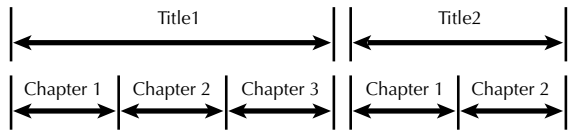

Audio CD/Video CD

Typically, Audio CD discs are divided into separate tracks each containing one song. Each track is assigned a number. For example, the third track is Track 3. The same is true for Video CD discs.

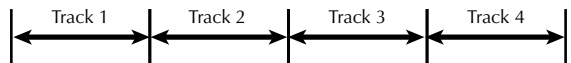

NOTE:

Video CD discs that support Playback Control (PBC)

The still image or motion image which follows a menu screen is called a "scene". Each scene has a scene number.

For more details, refer to "Locating a desired scene using the menu of the Video CD with PBC" (☞ p. 37).

Placing a Disc

1 Open the disc tray.

Press ▲ on the DVD deck to open the disc tray.

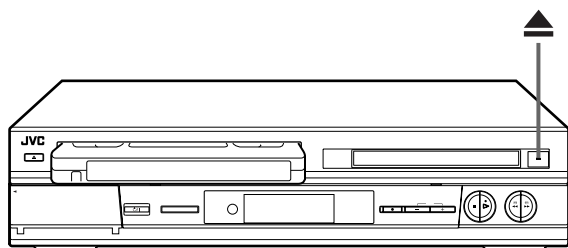

- Pressing the button again closes the disc tray.
- Do not block the disc tray with your hand while it is opening or closing as this may result in hardware failure.
- Do not place unplayable discs or any object other than a disc in the disc tray.
- Do not press down strongly on the disc tray or place any heavy objects on it.

2 Place the disc.

Place the disc in the disc tray with the label side facing up.

- Since disc size changes depending on the disc to be played back, be sure to correctly align the disc with the grooves for its size. If the disc is not in its groove, it may be scratched or otherwise damaged.
- To insert an 8 cm disc, place it according to the inner groove.

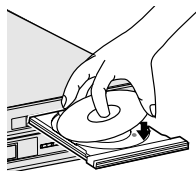

Care and Handling of Discs

How to handle discs

When handling a disc, do not touch the surface of the disc. Since discs are made of plastic, they are easily damaged. If a disc gets dirty, dusty, scratched or warped, the images and sound will not be picked up correctly, and such a disc may cause the unit to malfunction.

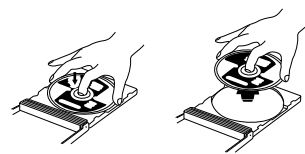

Label side

Do not damage the label side, stick paper to or use any adhesive on its surface.

Storage

Make sure that discs are kept in their cases. If discs are piled on top of one another without their protective cases, they can be damaged. Do not put discs in a location where they may be exposed to direct sunlight, or in a place where the humidity or temperature is high. Avoid leaving discs in your car!

Maintenance of discs

If there are fingerprints or other dirt adhering to a disc, wipe with a soft dry cloth, moving from the center outwards. If a disc is difficult to clean, wipe with a cloth moistened with water. Never use record cleaners, petrol, alcohol or any anti-static agents.



CAUTION

Sometimes during playback, noise or images may be garbled. This is sometimes due to the disc. (It may not be up to industry standards.)

These symptoms are caused by the discs, not by the malfunction of the unit.

FRONT VIEW

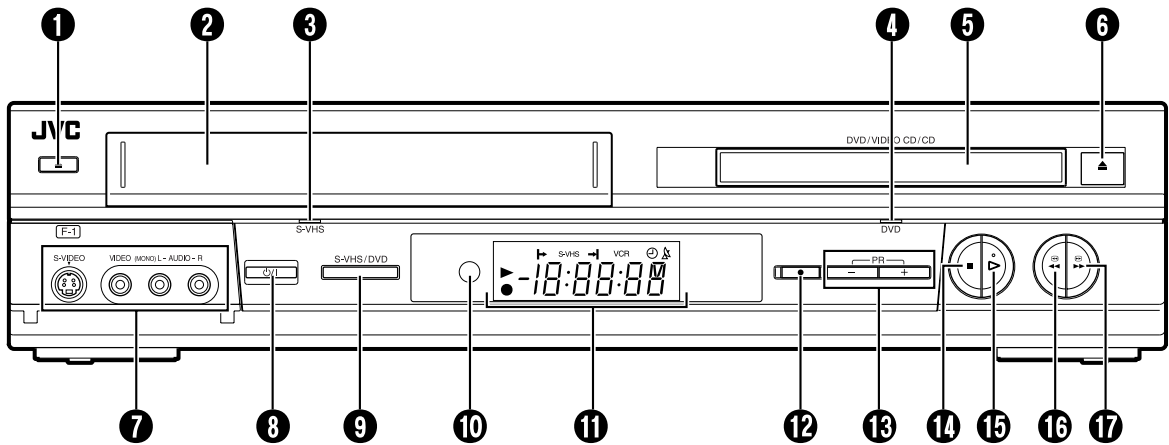

- ❶ S-VHS Eject Button (▲) ☞ pg. 22, 26
- ❷ S-VHS Cassette Loading Slot
- ❸ S-VHS Indicator ☞ pg. 22, 26
- ❹ DVD Indicator ☞ pg. 36
- ❺ Disc Tray
- ❻ DVD Eject Button (▲) ☞ pg. 36
- ❼ S-video/Video/Audio Input Connectors (S-VIDEO/VIDEO/AUDIO) ☞ pg. 58
- ❽ STANDBY/ON Button (⏻/⏻) ☞ pg. 13
- ❾ S-VHS/DVD Button ☞ pg. 22, 26, 36
- ❿ Infrared Beam Receiving Window
- ⓫ Front Display Panel ☞ pg. 9
- ⓬ Record Button (●) ☞ pg. 26
- ⓭ Programme Button (PR +/-) ☞ pg. 26
- ⓮ Stop Button (■) ☞ pg. 22, 26, 36
- ⓯ Play Button (▶) ☞ pg. 22, 36
- ⓰ Rewind Button (◀◀) ☞ pg. 22, 23, 38
- ⓱ Fast Forward Button (▶▶) ☞ pg. 22, 23, 38

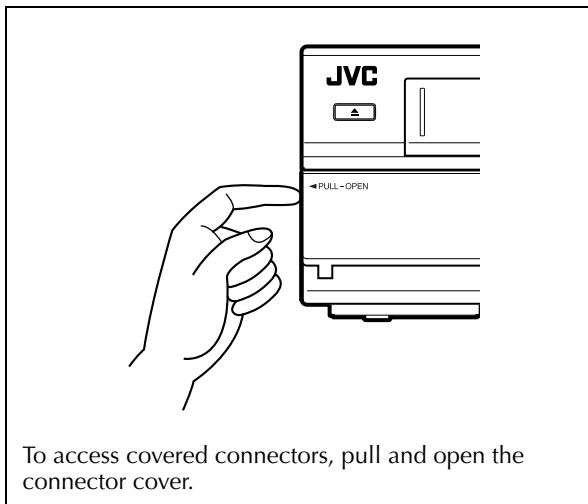

REAR VIEW

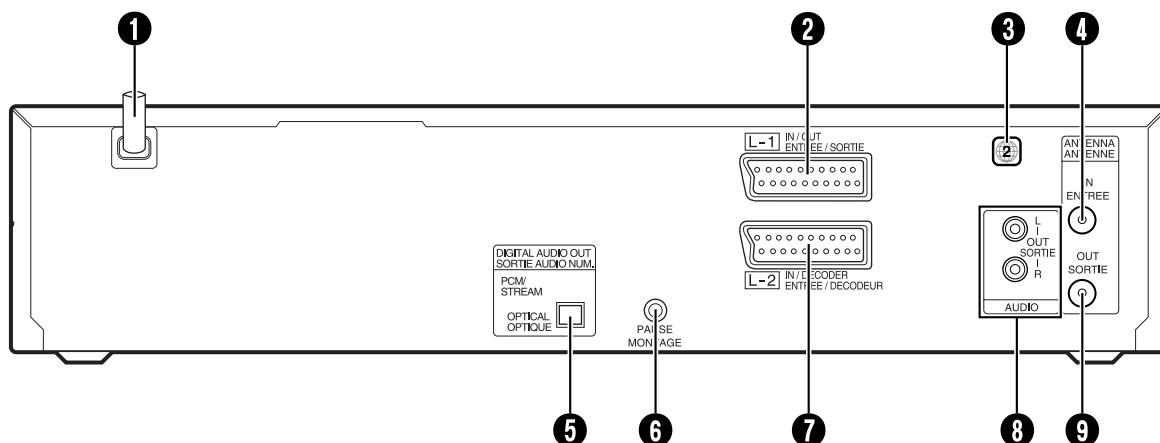

- ❶ Mains Power Cord ☞ pg. 12
- ❷ L-1 Input/Output Connector (L-1 IN/OUT) ☞ pg. 12, 59, 66, 67
- ❸ Region Number Label ☞ pg. 5
- ❹ Antenna Input Connector (ANTENNA IN) ☞ pg. 12
- ❺ Digital Audio Output Connector (DIGITAL AUDIO OUT) ☞ pg. 63
- ❻ Remote Pause Connector (PAUSE) ☞ pg. 58
- ❼ L-2 Input/Decoder Connector (L-2 IN/DECODER) ☞ pg. 59, 66, 67
- ❽ Audio Output Connectors (AUDIO OUT (L/R))
- ❾ Antenna Output Connector (ANTENNA OUT) ☞ pg. 12

FRONT DISPLAY PANEL

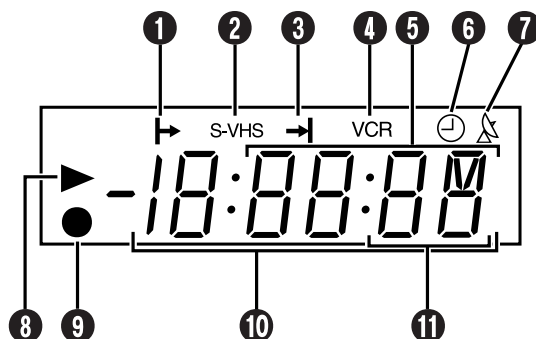

- ❶ Start Time Indicator (▶) (S-VHS deck only) ☞ pg. 32
- ❷ S-VHS Indicator (S-VHS deck only) ☞ pg. 71, 73
- ❸ Stop Time Indicator (▶|) (S-VHS deck only) ☞ pg. 32
- ❹ VCR Indicator (S-VHS deck only) ☞ pg. 27
- ❺ Channel/Clock Remain Display (S-VHS deck only) ☞ pg. 28
Mode Display (L-1, L-2, F-1, S-1 or SAT*) (S-VHS deck only)
* When "L-2 SELECT" is set to "SAT" (☞ pg. 61), "SAT" appears instead of "L-2".
- ❻ "Timer" Indicator (S-VHS deck only) ☞ pg. 31, 33
- ❼ Automatic Satellite Programme Recording Indicator (⚡) (S-VHS deck only) ☞ pg. 35
- ❽ Play Indicator
- ❾ Record Indicator (S-VHS deck only)
- ❿ Multi-information window* (DVD deck) Counter Display (S-VHS deck)
* The current group/title/track/chapter number(s), time and status information.
- ⓫ Tape Speed (SP/LP/EP) (S-VHS deck only) ☞ pg. 26

ON-SCREEN DISPLAY (S-VHS deck)

When "O.S.D." is set to "ON" (☞ pg. 72), various operational indicators appear on the TV screen. For On-screen display for DVD deck, refer to "Checking the DVD function status" (☞ pg. 44).

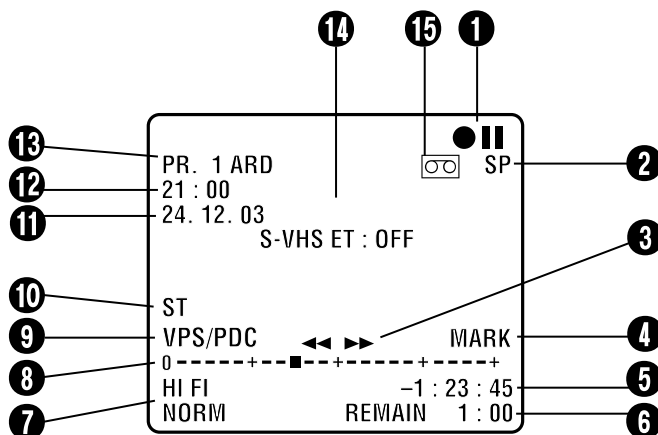

- ❶ Operation Mode Indicators
- ❷ Tape Speed (SP/LP/EP)
- ❸ Tape Direction
- ❹ Index Mark Indicator (MARK) ☞ pg. 26
- ❺ Counter Display
- ❻ Tape Remaining Time Indicator ☞ pg. 28
- ❼ Audio Mode Display ☞ pg. 25
- ❽ Tape Position Indicator
- ❹ VPS/PDC Indicator ☞ pg. 31, 33
- ❺ Type of Broadcast ☞ pg. 28
- ❻ Current Day/Month/Year
- ❼ Clock Display
- ❽ Channel Position Number and Station Name/Auxiliary Input Indicator (L-1, L-2, F-1, S-1 or SAT*)
- * When "L-2 SELECT" is set to "SAT" (☞ pg. 61), "SAT" appears instead of "L-2".
- ❹ S-VHS ET Indicator (S-VHS ET : ON/S-VHS ET : OFF) ☞ pg. 71
- ❽ "Cassette Loaded" Mark

The tape position indicator appears on the TV screen when you press ◀◀ or ▶▶ from the Stop mode or perform an Index Search. (☞ pg. 24) The position of "■" in relation to "0" (beginning) or "+" (end) shows you where you are on the tape.

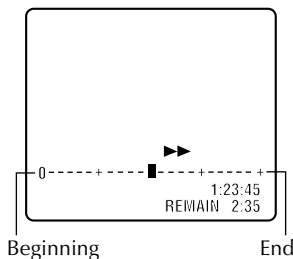

NOTE:

Depending on the type of tape being used, the tape position indicator may not appear correctly.

REMOTE CONTROL

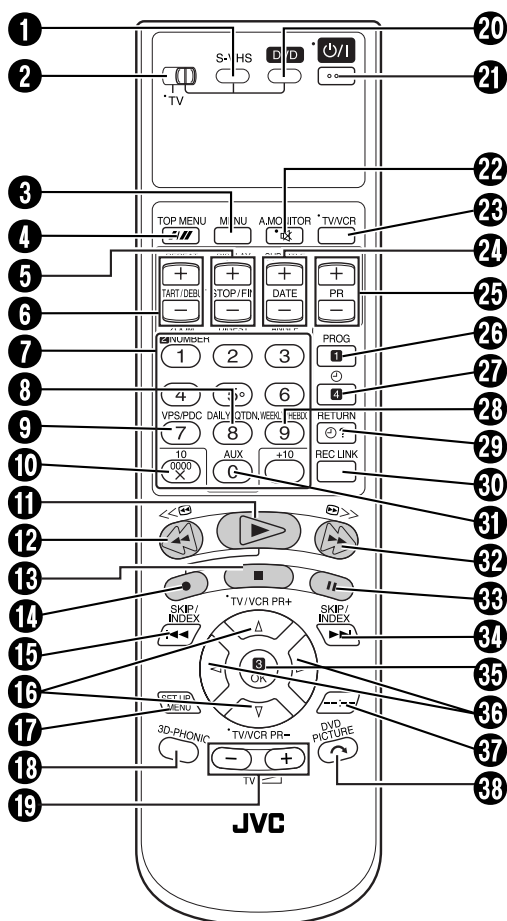

- 10 Reset Button (0000) ☞ pg. 28
- Cancel Button (X) ☞ pg. 34
- 11 Play Button (▶) ☞ pg. 22, 36
- 12 Rewind Button (◀◀) ☞ pg. 22, 23, 38
- 13 Stop Button (■) ☞ pg. 22, 26, 36
- 14 Record Button (●) ☞ pg. 26
- 15 Reverse Skip/Index Button (◀◀) ☞ pg. 24, 36
- 16 △▽ Button ☞ pg. 13
- TV/VCR Programme Button (TV/VCR PR +/-) ☞ pg. 65
- 17 Set Up Menu Button (SET UP MENU) ☞ pg. 17
- 18 3D-PHONIC Button ☞ pg. 43
- 19 TV Volume Button (TV ▲+/-) ☞ pg. 65
- 20 DVD Button ☞ pg. 36
- 21 STANDBY/ON Button (⏻/⏻) ☞ pg. 13
- 22 TV Muting Button (🔇) ☞ pg. 65
- Audio Monitor Button (A.MONITOR) ☞ pg. 25
- 23 TV/VCR Button ☞ pg. 27
- 24 Date Button (DATE +/-) ☞ pg. 32
- Subtitle Button (SUB TITLE) ☞ pg. 39
- Angle Button (ANGLE) ☞ pg. 40
- 25 Programme Button (PR +/-) ☞ pg. 26
- 26 Programming Button (PROG) ☞ pg. 30, 32
- 27 Timer Button (⌚) ☞ pg. 31, 33
- 28 Weekly Button (WEEKLY) ☞ pg. 31, 33
- 29 Programme Check Button (⌚ ?) ☞ pg. 34
- 30 Automatic Satellite Programming Button (REC LINK) ☞ pg. 35
- 31 Auxiliary Button (AUX) ☞ pg. 58
- 32 Fast Forward Button (▶▶) ☞ pg. 22, 23, 38
- 33 Pause Button (⏸) ☞ pg. 23, 26
- 34 Forward Skip/Index Button (▶▶) ☞ pg. 24, 36
- 35 OK Button ☞ pg. 14
- 36 ◀ ▶ Button ☞ pg. 17
- 37 Display Button (---) ☞ pg. 28
- 38 Skip Search Button (↶) ☞ pg. 24
- DVD Picture Button (DVD PICTURE) ☞ pg. 43

The glow-in-the-dark buttons shown in grey on the illustration above are helpful when using the remote control in darkened rooms.

Buttons with a small dot on the left side of the name can also be used to operate your TV. (☞ pg. 65)

- 1 S-VHS Button ☞ pg. 22, 26
- 2 TV/S-VHS/DVD switch ☞ pg. 17
- 3 Menu Button (MENU) ☞ pg. 37
- 4 Auto Tracking Button (///) ☞ pg. 25
- SP/LP/EP Button ☞ pg. 26
- Top Menu Button (TOP MENU) ☞ pg. 37
- 5 Stop Time Button (STOP +/-) ☞ pg. 32
- Display Button (DISPLAY) ☞ pg. 44
- Digest Button (DIGEST) ☞ pg. 42
- 6 Start Time Button (START +/-) ☞ pg. 32
- Repeat Button (REPEAT) ☞ pg. 46 – 49, 56 – 57
- Zooming Button (ZOOM) ☞ pg. 41
- 7 Number Keys ☞ pg. 26, 30, 55
- 8 Daily Button (DAILY) ☞ pg. 31, 33
- 9 VPS/PDC Button ☞ pg. 31, 33

How To Use

The remote control can operate most of your unit's functions, as well as basic functions of TV sets of JVC and other brands. (☞ pg. 65)

- Point the remote control toward the receiving window.
- The maximum operating distance of the remote control is about 8 m.

NOTES:

- When inserting the batteries, be sure to insert in the correct directions as indicated under the battery cover.
- If the remote control doesn't work properly, remove its batteries, wait a short time, replace the batteries and then try again.

Basic Connections

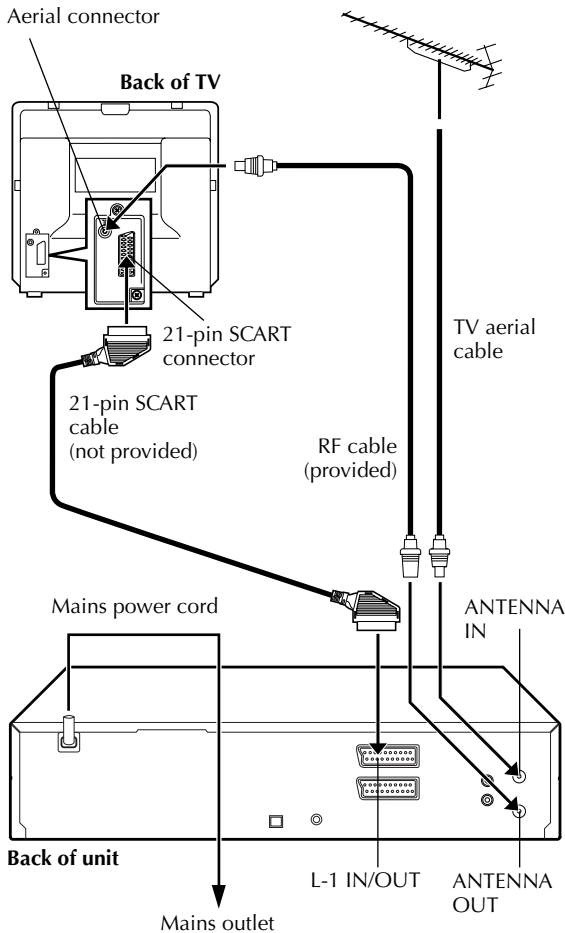

Make AV connection if your TV has a 21-pin AV input connector (SCART) in order to reduce the possibility of interference. With AV connection, you can enjoy stereo playback of video tapes if you are using a stereo TV. In addition, if you connect the unit to the TV's RGB connectors, set the output mode for the L-1 IN/OUT connector so that the RGB signal is output from the unit. When the DVD deck is selected, press and hold **■** until the desired mode appears on the front display panel.

YC: Select when your TV is compatible with the Y/C signal. Y/C signal is output from the unit. Also set "L-1 OUTPUT" to "S-VIDEO". (☞ pg. 60)

RGB: Select when your TV is compatible with the RGB signal. RGB signal is output from the unit.

NOTES:

- Set your TV to the VIDEO (or AV), Y/C, or RGB mode according to the type of your TV's SCART connector.
- For switching the TV's mode, refer to the instruction manual of your television.

It's essential that your unit be properly connected.

THESE STEPS MUST BE COMPLETED BEFORE ANY VIDEO OPERATION CAN BE PERFORMED.

1 Check the contents.

Make sure the package contains all of the accessories listed in "SPECIFICATIONS" on page 92.

2 Situate the unit.

Place the unit on a stable, horizontal surface.

3 Connect the unit to TV.

The connection method you use depends on the type of TV you have.

RF Connection

■ To connect to a TV with NO AV input connectors —

- 1 Disconnect the TV aerial cable from the TV.
- 2 Connect the TV aerial cable to the ANTENNA IN connector on the rear panel of the unit.
- 3 Connect the provided RF cable between the ANTENNA OUT connector on the rear panel of the unit and the TV's aerial connector.

AV Connection

■ To connect to a TV with AV input connectors —

- 1 Connect the aerial, unit and TV as per "RF Connection".
- 2 Connect an optional 21-pin SCART cable between the L-1 IN/OUT connector on the rear panel of the unit and the TV's 21-pin SCART connector.
- 3 Set the output mode for the L-1 IN/OUT connector depending on type of your TV. (☞ left column)

4 Connect the unit to mains.

Plug the end of the mains power cord into a mains outlet.

After the connection is completed, perform "Auto Set Up" on page 13.

Auto Set Up



Auto Channel Set/Auto Clock Set/ Auto Guide Program Number Set

After the P/I button on the unit or remote control is pressed for the first time to power on the unit, by simply selecting your country*, the Auto Set Up function sets the tuner channels, clock** and Guide Program numbers automatically.

* If you live in Belgium (BELGIUM) or Switzerland (SUISSE), you also need to select your language.

** If you live in Hungary (MAGYARORSZÁG), Czech Republic (ČESKÁ REPUBLIKA), Poland (POLSKA) or other countries in Eastern Europe (OTHER EASTERN EUROPE), set the clock manually.

Before starting, make sure of the following:

- The TV aerial cable should be connected to the unit.
- The unit's mains power cord should be connected to a mains outlet.
- The TV should be set to its AV mode (with AV connection  pg. 12) or UHF channel 36 (with RF connection  pg. 12).
- Slide the TV/S-VHS/DVD switch to the right.

1 Turn on the unit.

Press P/I on the unit or remote control. The Country Set display appears on the TV screen.

NOTE:

If you have connected your TV to the unit with RF connection and the on-screen display appearing on UHF channel 36 looks distorted, perform "Video Channel Set" on page 86.



2 Select your country.

Press Δ/∇ to move the highlight bar (pointer) to your country's name.

(Example) DEUTSCHLAND is selected.



NOTES:

- If you have selected BELGIUM or SUISSE, go to step 3.
- If you have selected MAGYARORSZÁG, ČESKÁ REPUBLIKA, POLSKA or OTHER EASTERN EUROPE, press **OK**. The Clock Set screen appears. Set the clock manually ( pg. 84), then go to step 4.
- If you have selected any other country name, go to step 4.

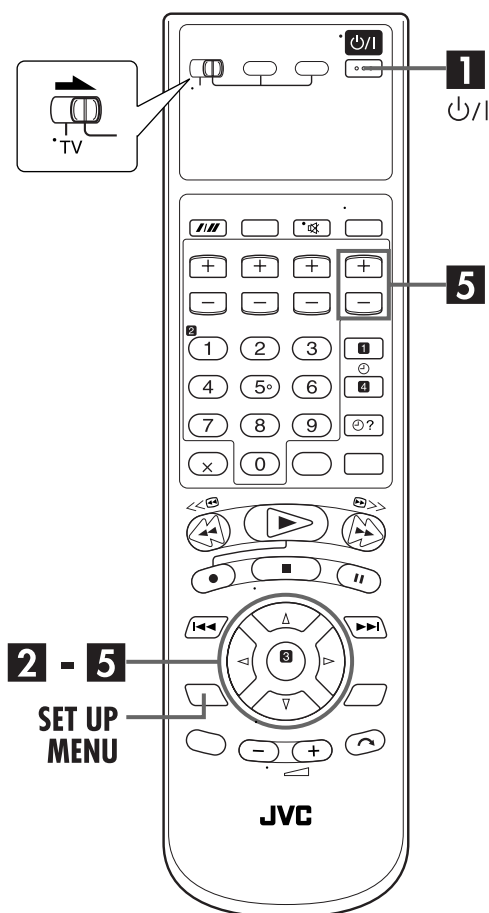

3 Select the language.

Press **OK**. The Language Set display appears on the TV screen.

Press \triangle / ∇ to move the highlight bar (pointer) to the language of your choice.

(Example) DEUTSCH is selected.



NOTE:

The selected language is only available on the screen for S-VHS deck.

Set manually the on-screen language for the DVD deck.

(\mathcal{C} pg. 19)

4 Perform Auto Set Up.

Press **OK**. The AUTO SET/T-V LINK display appears on the front display panel and/or on the TV screen.

On the front display panel

Press \triangle / ∇ to select "Auto" and press **OK** or \triangleright .

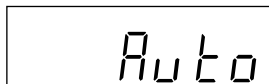

On the on-screen display

Press \triangle / ∇ to move the highlight bar (pointer) to "AUTO SET" and press **OK** or \triangleright .

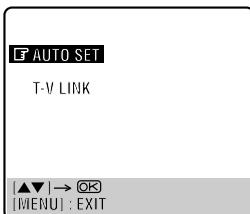

"Auto" blinks on the front display panel; do NOT press any button on the unit or remote control until the front display panel shows either the display as illustrated in step 5 or "--:--" as illustrated on page 16.

- If you are using the on-screen display, the AUTO SET screen will appear. As Auto Set Up progresses, the "■" mark on the TV screen moves from left to right.

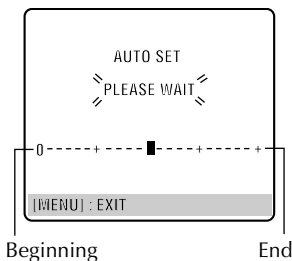

- When you have connected the unit to a TV offering T-V Link via a fully-wired 21-pin SCART cable (\mathcal{C} pg. 12) and the TV is turned on, the unit automatically performs the Preset Download (\mathcal{C} pg. 15) even if you select "Auto" or "AUTO SET" for Auto Set Up function.

5 Confirm/Set video channel.

With RF Connection

The video channel that is shown on the display panel is your video channel. Press **OK**.

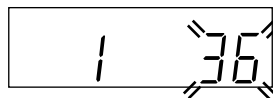

- If you have selected MAGYARORSZÁG, ČESKÁ REPUBLIKA, POLSKA or OTHER EASTERN EUROPE in step 2 on page 13, "2" appears instead of "1".



- To view picture signals from the unit, set your TV to the video channel.

With AV Connection

Press **PR** – until the display panel shows "1 --" (or "2 --"). Now the video channel is set to off. Then press **OK**.

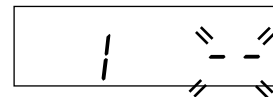

- To view picture signals from the unit, set your TV to its AV mode.

ATTENTION

Once you have performed Auto Set Up, even if the unit's memory backup has expired, all the stored stations and their Guide Program numbers remain in the unit's memory and the unit will not perform Auto Set Up again. The unit performs only Auto Clock Set when the unit is turned on.

If you have moved to a different area, perform each setting as required.

- Video channel setting (for RF connection users) (\mathcal{C} pg. 86)
 - Tuner setting (\mathcal{C} pg. 78)
 - Clock setting (\mathcal{C} pg. 84)
- If a new station starts broadcasting in your area, perform tuner setting (\mathcal{C} pg. 78) and, if necessary, video channel setting (\mathcal{C} pg. 86).

NOTES:

- In the area where no TV station transmits a PDC (Programme Delivery Control) signal, the unit can perform neither Auto Clock Set nor Auto Guide Program Number Set.
- If there is a power cut, or if you press $\mathcal{O}/1$ or **SET UP MENU** while Auto Set Up is in progress, Auto Set Up will be interrupted; be sure to turn off the unit power once and try again from step 1.
- Auto Clock Set may not function properly depending on the reception condition.
- If no sound accompanies the picture or the audio sounds unnatural on some channels that have been stored by Auto Set Up, the TV system setting for those channels may be incorrect. Select the appropriate TV system for those channels. (\mathcal{C} pg. 81, "INFORMATION")

After "Auto Set Up" is completed, perform "Monitor Set (DVD deck)" on page 17.

Preset Download

Auto Channel Set by Downloading from TV/Auto Clock Set/Auto Guide Program Number Set

ATTENTION

You can use this function only with a TV offering T-V Link, etc.* Be sure to use a fully-wired 21-pin SCART cable.
* Compatible with TVs offering T-V Link, EasyLink, Megaloc, SMARTLINK, Q-Link or DATA LOGIC via fully-wired 21-pin SCART cable. The degree of compatibility and available functions may differ by system.

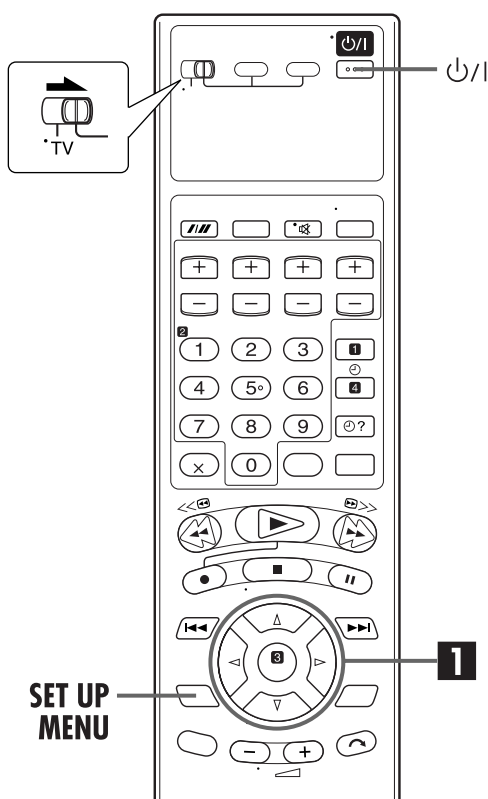

If you have connected the unit to your TV via the AV connection (☞ pg. 12), the unit will automatically perform Preset Download instead of the Auto Set Up in step 4 on page 14. After downloading, the unit sets the clock and Guide Program numbers automatically.

- Slide the TV/S-VHS/DVD switch to the right.
- Perform steps 1 to 3 of "Auto Set Up" on page 13 before continuing.

1 Perform Preset Download.

Press **OK**. The AUTO SET/T-V LINK display appears on the front display panel and/or on the TV screen.

On the front display panel

Press Δ / ∇ to select "CH --" and press **OK** or \triangleright .

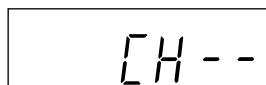

On the on-screen display

Press Δ / ∇ to move the highlight bar (pointer) to "T-V LINK" and press **OK** or \triangleright .



Preset positions on the front display panel increase from "CH1"; do NOT press any button on the unit or remote control until the front display panel shows clock time, "(CH) 1" or "--:--" as illustrated on page 16.

- If you are using the on-screen display, the T-V LINK screen will appear. Then the GUIDE PROG SET screen will appear during Guide Program Number Set. When Preset Download is completed, "COMPLETED" appears for about 5 seconds, then the normal screen appears.
- If you press any button on the unit or remote control while downloading is in progress, it will be interrupted.

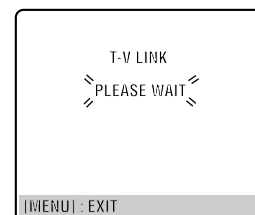

2 Set the video channel.

Set the video channel to off manually. (☞ pg. 86)

After "Preset Download" is completed, perform "Monitor Set (DVD deck)" on page 17.

NOTES:

- For details, refer to the instruction manual of your TV.
- In the area where no TV station transmits a PDC (Programme Delivery Control) signal, the unit can perform neither Auto Clock Set nor Auto Guide Program Number Set.
- If there is a power cut, or if you press P/| or **SET UP MENU** while downloading or set up is in progress, it will be interrupted; be sure to turn off the unit power once and try again from the beginning.
- Auto Clock Set may not function properly depending on the reception condition.
- On this unit, the characters available for station names (ID) are A-Z, 0-9, -, *, + and _ (space). Some names of downloaded stations may differ from those of your TV. (☞ pg. 82)

Results of Auto Set Up/Presets Download appear on the front display panel

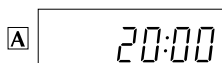

If both Auto Channel Set and Auto Clock Set have been performed successfully, the correct current time is displayed.

Turn on the TV and select its video channel or AV mode, then make sure that all necessary stations have been stored in the unit's memory by using the **PR** button(s).

- If station names (ID – pg. 83) have also been stored in the unit's memory, the station name will be displayed at the top left corner of the TV screen for about 5 seconds when the unit is tuned to a different station.
- If you want to set the tuner manually such as to add or skip channels, to change channel positions, or to set or change station names, see pages 80 – 83.



If Auto Channel Set has succeeded but Auto Clock Set has not, "1" (channel position) is displayed.

1 Turn on the TV and select its video channel or AV mode, then make sure that all necessary stations have been stored in the unit's memory by using the **PR** button(s).

- If station names (ID – pg. 83) have also been stored in the unit's memory, the station name will be displayed at the top left corner of the TV screen for about 5 seconds when the unit is tuned to a different station.
- If you want to set the tuner manually such as to add or skip channels, to change channel positions, or to set or change station names, see pages 80 – 83.

2 Perform "Clock Set" on page 84.

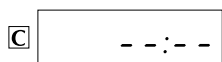

If both Auto Channel Set and Auto Clock Set have failed, "--:--" is displayed.

Make sure the cables are connected properly and turn off the unit's power once, then turn the unit's power back on again.

The Country Set display appears on the TV screen; perform "Auto Set Up" on page 13 or "Preset Download" on page 15 again.

IMPORTANT

- To check if the Guide Program numbers have been set correctly, perform the SHOWVIEW Timer Programming. (pg. 30) (S-VHS deck only)
- In certain reception conditions, station names may not be stored correctly, and auto Guide Program Number Set may not work properly. If the Guide Program numbers are not set properly when you timer-record a TV programme using the SHOWVIEW system, the unit will record a TV programme of a different station. When programming the timer using the SHOWVIEW system, be sure to check the desired channel is selected correctly. (pg. 30, "SHOWVIEW" Timer Programming") (S-VHS deck only)
- Your unit memorizes all detected stations even if reception of some of them is poor. You can delete those stations with an unacceptable picture. (pg. 81, "Delete A Channel")

INFORMATION

Language for the on-screen display (S-VHS deck)

Auto Set Up also selects the language automatically for the on-screen display depending on the Country setting you have made in step 2 on page 13 (unless you have selected BELGIUM or SUISSE), as shown below.

SUOMI	→ SUOMI	DANMARK	→ DANSK	NEDERLAND	→ NEDERLANDS
PORTUGAL	→ ENGLISH	ÖSTERREICH	→ DEUTSCH	GREECE	→ ENGLISH
DEUTSCHLAND	→ DEUTSCH	ČESKÁ REPUBLIKA	→ ČEŠTINA	OTHER WESTERN EUROPE	→ ENGLISH
POLSKA	→ POLSKI	ITALIA	→ ITALIANO	OTHER EASTERN EUROPE	→ ENGLISH
NORGE	→ NORSK	MAGYARORSZÁG	→ MAGYAR		
SVERIGE	→ SVENSKA	ESPAÑA	→ CASTELLANO		

If you want to change the language setting manually, see "On-screen Language Set (S-VHS deck)" on page 18.

Language for the on-screen display (DVD deck)

Set manually the on-screen language for the DVD deck. (pg. 19)

Just Clock

Your unit is equipped with the Just Clock function which provides accurate time keeping through automatic adjustments at regular intervals, by reading data from a PDC signal. If you want to take advantage of this function, simply set it to "ON". (pg. 84, "Just Clock")

Monitor Set

(DVD deck)

You can select the monitor type depending the TV used when you play back DVD VIDEO discs recorded for wide-screen TVs.

- Turn on the TV and select the video channel (or AV mode).
- Slide the **TV/S-VHS/DVD** switch to the right.

1 Turn on the unit.

Press \odot /I.

2 Select the DVD deck.

On the unit

Press **S-VHS/DVD** repeatedly so that the DVD indicator lights up.

On the remote control

Press **DVD** so that the DVD indicator lights up.

3 Access the DVD menu screen.

- 1 Press **SET UP MENU**.
- 2 Press $\triangleleft \triangleright$ to move the arrow to "DISPLAY".

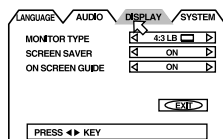

4 Select the mode.

Press $\triangle \nabla$ to move the arrow to "MONITOR TYPE".

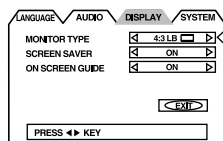

5 Select the mode setting.

Press $\triangleleft \triangleright$ to select the desired setting.

6 Return to the normal screen.

Press **SET UP MENU**.

* The default setting is **bold** in the table below.

MONITOR TYPE

- 16:9 WIDE:** Select this when you connect the unit to a wide-screen TV with 16:9 aspect ratio. The unit automatically adjusts the screen width of the output signal correctly when playing back a 4:3 image source.
- 4:3PS:** Select this when you connect the unit to a TV with 4:3 aspect ratio. When you play back a 16:9 image recorded on a DVD VIDEO disc, the left and right sides of the image are automatically cut off. Depending on the disc, it may not be possible to play back in this mode. In that case, set to "4:3LB".
- 4:3LB:** Select this when you connect the unit to a TV with 4:3 aspect ratio. When you play back a 16:9 image recorded on a DVD VIDEO disc, it is displayed with black bands at the top and bottom of the screen.

Pan&Scan/Letter Box

In general, DVD VIDEO disc are produced for a wide-screen TV with 16:9 aspect ratio. Material with this ratio will not fit to a TV with 4:3 aspect ratio. There are two styles to display the image, "Pan&Scan" (PS) and "Letter Box" (LB).

Pan&Scan

The right and left side of the image are cut off. The image fills the screen.



Letter Box

Black bands appear at the top and bottom of the image. The image itself appears in 16:9 aspect ratio.



Language

- Turn on the TV and select the video channel (or AV mode).
- Slide the TV/S-VHS/DVD switch to the right.

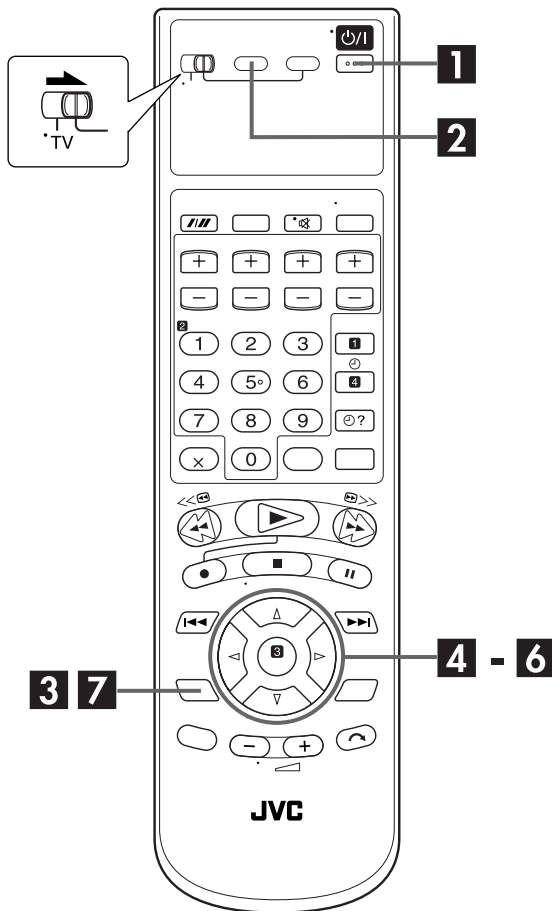

On-screen Language Set (S-VHS deck)

This S-VHS deck offers you the choice to view on-screen messages in 13 different languages. Though Auto Set Up selects the language automatically (pg. 16), you can change the language setting manually as required.

1 Turn on the unit.

Press ψ /I.

2 Select the S-VHS deck.

On the unit

Press S-VHS/DVD repeatedly so that the S-VHS indicator lights up.

On the remote control

Press S-VHS so that the S-VHS indicator lights up.

3 Access the Main Menu screen.

Press SET UP MENU.

4 Access the Country Set screen.

Press \triangle / ∇ to move the highlight bar (pointer) to "AUTO CH SET", then press OK or \triangleright .

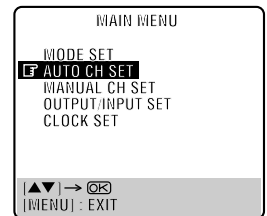

5 Select your country.

Press \triangle / ∇ to move the highlight bar (pointer) to your country's name, then press OK or \triangleright .

6 Select the language.

Press \triangle / ∇ to move the highlight bar (pointer) to the language of your choice.

- You do not have to press OK; pressing OK enters AUTO SET/T-V LINK screen.



7 Return to the normal screen.

Press SET UP MENU.

On-screen Language Set (DVD deck)

This DVD deck offers you the choice to view on-screen messages in 3 different languages. You can change the language setting manually as required.

1 Turn on the unit.

Press ϕ /I.

2 Select the DVD deck.

On the unit

Press **S-VHS/DVD** repeatedly so that the DVD indicator lights up.

On the remote control

Press **DVD** so that the DVD indicator lights up.

3 Access the DVD menu screen.

- 1 Press **SET UP MENU**.
- 2 Press $\triangleleft \triangleright$ to move the arrow to "LANGUAGE".

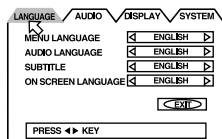

4 Select the mode.

Press $\triangle \nabla$ to move the arrow to "ON SCREEN LANGUAGE".

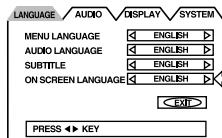

5 Select the mode setting.

Press $\triangleleft \triangleright$ to select the desired setting.

6 Return to the normal screen.

Press **SET UP MENU**.

Menu/Audio/Subtitle Language Set (DVD deck only)

Some DVD discs contain the DVD menu display, audio, subtitle in the multiple languages. With these discs, you can set the default language as you like.

- The procedure shows how to set "MENU LANGUAGE" on the DVD menu screen as an example.

1 Turn on the unit.

Press ϕ /I.

2 Select the DVD deck.

On the unit

Press **S-VHS/DVD** repeatedly so that the DVD indicator lights up.

On the remote control

Press **DVD** so that the DVD indicator lights up.

3 Access the DVD menu screen.

- 1 Press **SET UP MENU**.
- 2 Press $\triangleleft \triangleright$ to move the arrow to "LANGUAGE".

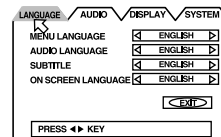

4 Select the mode.

Press $\triangle \nabla$ to move the arrow to "MENU LANGUAGE".

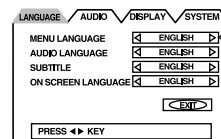

5 Select the mode setting.

Press $\triangleleft \triangleright$ to select the desired setting.

- See "Language Code List" (☞ pg. 20).

6 Return to the normal screen.

Press **SET UP MENU**.

NOTE:

When the selected language is not available on the disc, the disc's default menu language is played back.

Language Code List

AA	Afar	IK	Inupiak	RN	Kirundi
AB	Abkhazian	IN	Indonesian	RO	Rumanian
AF	Afrikaans	IS	Icelandic	RU	Russian
AM	Ameharic	IW	Hebrew	RW	Kinyarwanda
AR	Arabic	JI	Yiddish	SA	Sanskrit
AS	Assamese	JW	Javanese	SD	Sindhi
AY	Aymara	KA	Georgian	SG	Sangho
AZ	Azerbaijani	KK	Kazakh	SH	Serbo-Croatian
BA	Bashkir	KL	Greenlandic	SI	Singhalese
BE	Byelorussian	KM	Cambodian	SK	Slovak
BG	Bulgarian	KN	Kannada	SL	Slovenian
BH	Bihari	KO	Korean (KOR)	SM	Samoaian
BI	Bislama	KS	Kashmiri	SN	Shona
BN	Bengali, Bangla	KU	Kurdish	SO	Somali
BO	Tibetan	KY	Kirghiz	SQ	Albanian
BR	Breton	LA	Latin	SR	Serbian
CA	Catalan	LN	Lingala	SS	Siswati
CO	Corsican	LO	Laothian	ST	Sesotho
CS	Czech	LT	Lithuanian	SU	Sundanese
CY	Welsh	LV	Latvian, Lettish	SV	Swedish
DA	Danish	MG	Malagasy	SW	Swahili
DZ	Bhutani	MI	Maori	TA	Tamil
EL	Greek	MK	Macedonian	TE	Telugu
EO	Esperanto	ML	Malayalam	TG	Tajik
ET	Estonian	MN	Mongolian	TH	Thai
EU	Basque	MO	Moldavian	TI	Tigrinya
FA	Persian	MR	Marathi	TK	Turkmen
FI	Finnish	MS	Malay (MAY)	TL	Tagalog
FJ	Fiji	MT	Maltese	TN	Setswana
FO	Faroese	MY	Burmese	TO	Tonga
FY	Frisian	NA	Nauru	TR	Turkish
GA	Irish	NE	Nepali	TS	Tsonga
GD	Scots Gaelic	NL	Dutch	TT	Tatar
GL	Galician	NO	Norwegian	TW	Twi
GN	Guarani	OC	Occitan	UK	Ukrainian
GU	Gujarati	OM	(Afan) Oromo	UR	Urdu
HA	Hausa	OR	Oriya	UZ	Uzbek
HI	Hindi	PA	Panjabi	VI	Vietnamese
HR	Croatian	PL	Polish	VO	Volapuk
HU	Hungarian	PS	Pashto, Pushto	WO	Wolof
HY	Armenian	PT	Portuguese	XH	Xhosa
IA	Interlingua	QU	Quechua	YO	Yoruba
IE	Interlingue	RM	Rhaeto-Romance	ZU	Zulu

T-V Link Functions

When you connect the unit to your TV via a fully-wired 21-pin SCART cable (☞ pg. 12), the following functions are available. You can use these functions only with a TV offering T-V Link, etc.*

For details, refer to the instruction manual of your TV.

* Compatible with TVs offering T-V Link, EasyLink, Megalogic, SMARTLINK, Q-Link or DATA LOGIC via fully-wired 21-pin SCART cable. The degree of compatibility and available functions may differ by system.

TV Auto Power On

The TV will turn on and be set to its AV mode automatically whenever you play a tape.

For details, refer to the instruction manual of your TV.

VCR Auto Standby

You can use your TV's remote control to turn off the unit.

For details, refer to the instruction manual of your TV.

Direct Rec (S-VHS deck only)

You can easily start recording the programme that you are watching on your TV. When you use this function, set "DIRECT REC" to "ON". (☞ pg. 72)

Basic Playback

- Turn on the TV and select the video channel (or AV mode).
- Slide the TV/S-VHS/DVD switch to the right.

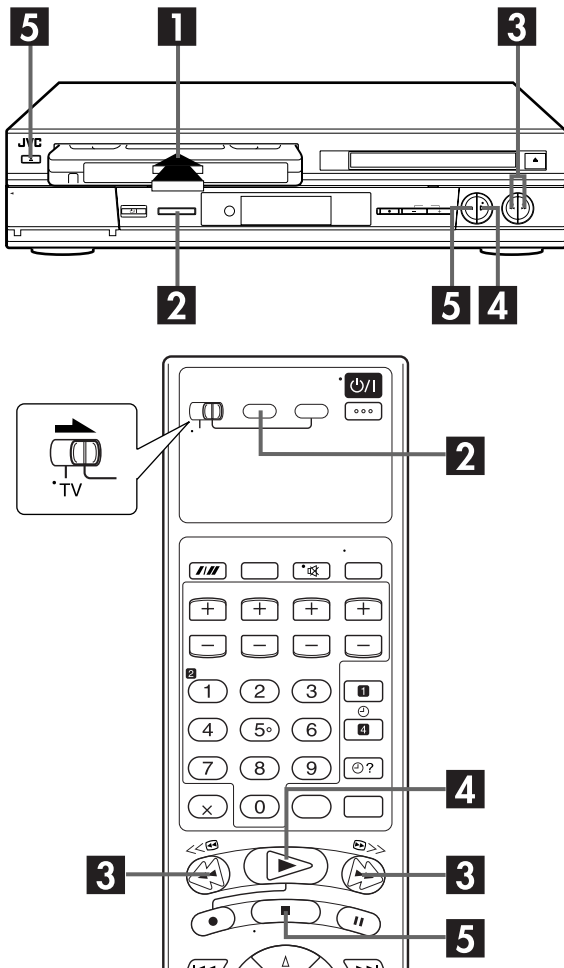

Clean the video heads using a dry cleaning cassette — ECL-3F — when:

- Rough, poor picture appears while a tape is played back.
- The picture is unclear or no picture appears.
- "USE CLEANING CASSETTE" appears on the screen (only with "O.S.D." set to "ON"). (☞ pg. 72)

NOTE:

The heads get dirty in the following cases:

- in an environment prone to extreme temperature or humidity
- in a dusty environment
- flaw, dirt or mold on video tapes
- continuous usage for a long time

1 Load a cassette.

Make sure the window side is up, the rear label side is facing you and the arrow on the front of the cassette is pointed toward the unit.

- Do not apply too much pressure when inserting.
- If the record safety tab has been removed, playback begins automatically.
- The unit's power comes on automatically and the counter is reset to 0:00:00.

2 Select the S-VHS deck.

On the unit

Press S-VHS/DVD repeatedly so that the S-VHS indicator lights up.

On the remote control

Press S-VHS so that the S-VHS indicator lights up.

3 Find the programme start point.

If the tape is advanced past the start point, press ◀◀. To go forward, press ▶▶.

4 Start playback.

Press ▶. "bEst" appears blinking on the front display panel during automatic tracking. (☞ pg. 29)

5 Stop playback.

Press ■. Then press ▲ on the S-VHS deck to remove the cassette.

Usable cassettes

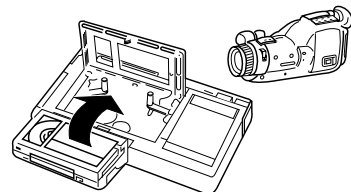

- Compact VHS camcorder recordings can be played on this unit. Simply place the recorded cassette into a VHS Cassette Adapter and it can be used just like any full-sized VHS cassette.
- This unit can record on regular VHS and Super VHS cassettes. While only VHS signals can be recorded on regular VHS cassettes*, both VHS and Super VHS signals can be recorded and played back using Super VHS cassettes.

* By using the S-VHS ET function, it is possible to record and play back with S-VHS picture quality on VHS cassettes with this unit.

Playback Features

- Turn on the TV and select the video channel (or AV mode).
- Slide the TV/S-VHS/DVD switch to the right.

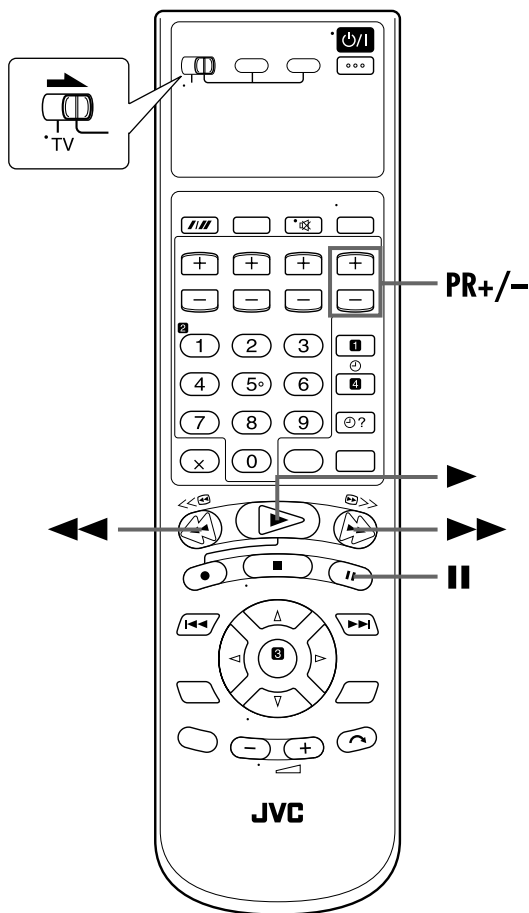

Still Picture/Frame-By-Frame Playback

1 Pause during playback.

Press **II**.

- If there is vertical jitter, press **PR +/-** on the remote control to correct the picture.

2 Activate frame-by-frame playback.

Press **II**.

Slow Motion

During still picture, press and hold **II** for 2 seconds, then release. Press **II** and release again to return to still picture.

NOTE:

During slow motion playback, some noise may appear on the TV screen. Press **PR +** or **-** on the remote control to eliminate the noises.

High-Speed (Turbo) Search

During playback, press **▶▶** for forward high-speed search, or **◀◀** for reverse high-speed search.

To resume normal playback, press **▶**.

ATTENTION

- Picture may not appear during high-speed search with an LP/EP-recorded tape.
- Noise may appear or the picture may appear distorted with an EP-recorded tape during still, slow motion, frame-by-frame playback or variable speed search.
- In the high-speed search, still, slow motion or frame-by-frame playback mode, the picture will be distorted, and there will be a loss of colour.

Index Search

Your unit automatically marks index codes at the beginning of each recording. This function gives you quick access to any one of 9 index codes in either direction.

NOTE:

Before starting, make sure the unit is in the Stop mode.

Activate Index Search.

Press \lll or \ggg . " $\lll 1$ " or " $\ggg 1$ " is displayed on the TV screen and search begins in the corresponding direction.

- To access index codes 2 through 9, press \lll or \ggg repeatedly until the correct index number is displayed.

Example:

To locate the beginning of B from the current position, press \lll twice.

To locate the beginning of D from the current position, press \ggg once.

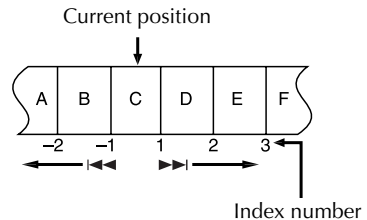

- When the specified index code is located, playback begins automatically.

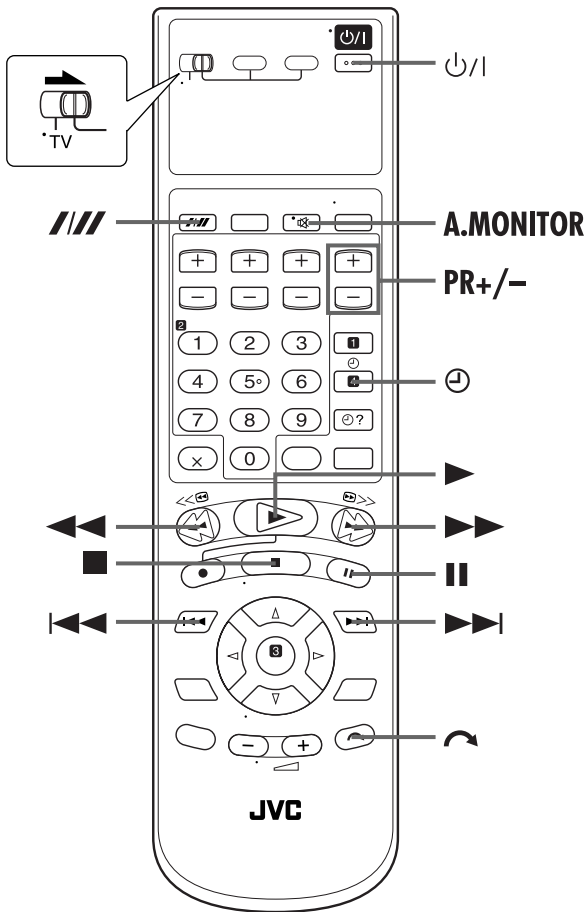

Skip Search

During playback, press \curvearrowright 1 to 4 times to skip over unwanted sections.

Each press initiates a 30-second period of fast-motion playback. Normal playback resumes automatically.

To resume normal playback during a Skip Search, press \blacktriangleright .

Next Function Memory

The Next Function Memory “tells” the unit what to do after rewinding. Before continuing, make sure the unit is in the Stop mode.

- a- For Automatic Start Of Playback
Press ◀◀, then press ▶ within 2 seconds.
- b- For Automatic Power Off
Press ◀◀, then press ⏻ within 2 seconds.
- c- For Automatic Timer Standby
Press ◀◀, then press ⏸ (TIMER) within 2 seconds.
- d- For Automatic Cassette Ejection After Tape Rewind
Press ◀◀, then press ▲ within 2 seconds.

Repeat Playback

Your unit can automatically play back the whole tape 100 times repeatedly.

1 Start playback.

Press ▶.

2 Activate Repeat Playback.

Press ▶ and hold for over 5 seconds, then release.

- The Play indicator (▷) on the front display panel blinks slowly.
- After playing back a tape 100 times, the unit stops automatically.

3 Stop Repeat Playback.

Press ■ at any time.

- Pressing ▶, ◀◀, ▶▶ or || also stops Repeat Playback.

NOTE:

Repeat playback is not possible with a cassette recorded in EP mode.

Manual Tracking

Your unit is equipped with automatic tracking control. During playback, you can override this and adjust the tracking manually by pressing the PR buttons.

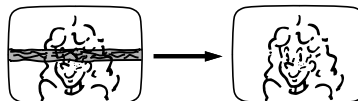

1 Override automatic tracking.

During playback, press **PR** on the remote control.

2 Adjust the tracking manually.

Press **PR +** or **-** on the remote control.

- Press **PR** again to return to automatic tracking.

NOTE:

When a new tape is inserted, the unit enters the automatic tracking mode automatically.

Soundtrack Selection

Your unit is capable of recording three soundtracks (HI-FI L, HI-FI R and NORM) and will play back the one you select.

During Playback

Pressing **A.MONITOR** changes the soundtrack as follows:

TRACK	USE
On-Screen Display	
HI FI L ▶ ▶ R	For Hi-Fi stereo tapes
HI FI L ▶	For main audio of Bilingual tapes
HI FI ▶ ▶ R	For sub audio of Bilingual tapes
NORM	For audio-dubbed tapes
HI FI NORM	For audio-dubbed tapes

NOTES:

- “HI FI L ▶ ▶ R” should normally be selected. In this mode, Hi-Fi stereo tapes are played back in stereo, and the normal audio track is played back automatically for tapes with only normal audio.
- For instructions on recording stereo and bilingual programmes, refer to page 28.
- “O.S.D.” must be set to “ON” or the on-screen displays will not appear. (ⓘ pg. 72)

Basic Recording

- Turn on the TV and select the video channel (or AV mode).
- Slide the TV/S-VHS/DVD switch to the right.

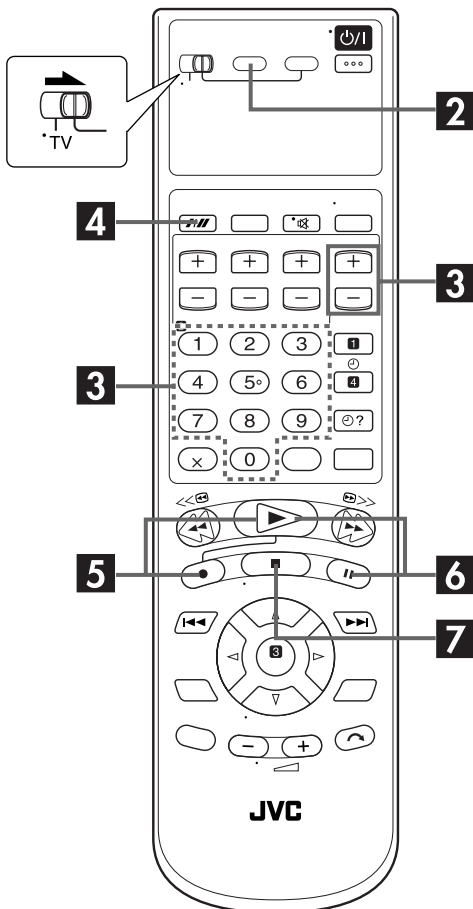
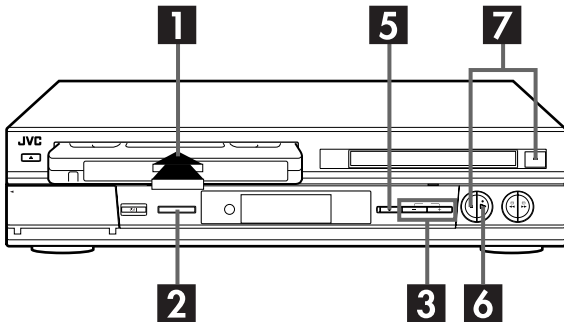

1 Load a cassette.

Insert a cassette with the record safety tab intact.

- The unit's power comes on automatically and the counter is reset to 0:00:00.

2 Select the S-VHS deck.

On the unit

Press **S-VHS/DVD** repeatedly so that the S-VHS indicator lights up.

On the remote control

Press **S-VHS** so that the S-VHS indicator lights up.

3 Choose a programme.

Press **PR +/-** or the **number keys** to select the channel you wish to record.

4 Set the tape speed.

Press **SP/LP/EP (////)**. The current setting appears on the front display panel or TV screen. Press **SP/LP/EP (////)** again to change the setting while the tape speed is displayed on the TV screen.

- In EP mode, the recording time is extended three times.
- If you record a programme in EP mode on the unit, it is recommended to play back the EP-recorded tape on the unit.
- It is not possible to select EP mode if "COLOUR SYSTEM" is set to "MESECAM". (☞ pg. 74)

5 Start recording.

Press and hold **●** and press **▶** on the remote control, or press **●** on the unit.

- If "O.S.D." is set to "ON" (☞ pg. 72), "MARK" blinks on the screen while an index code is being marked.
- When "DIRECT REC" is set to "ON" (☞ pg. 72), if you press any button just after pressing **●** on the unit (or **●** and **▶** on the remote control), the unit may not function properly.

B.E.S.T. takes place at the beginning of both the first SP and the first LP (or EP) recording after inserting the cassette. (☞ pg. 29)

If "DIRECT REC" is set to "ON", the programme that appears on the TV screen will be recorded. (☞ pg. 72)

6 Pause/Resume recording.

Press **II**. Press **▶** to resume recording.

- You can select channel during the Record Pause mode.

7 Stop recording.

Press **■**. Then press **▲** on the S-VHS deck to remove the cassette.

Recording Features

- Turn on the TV and select the video channel (or AV mode).
- Slide the **TV/S-VHS/DVD** switch to the right.

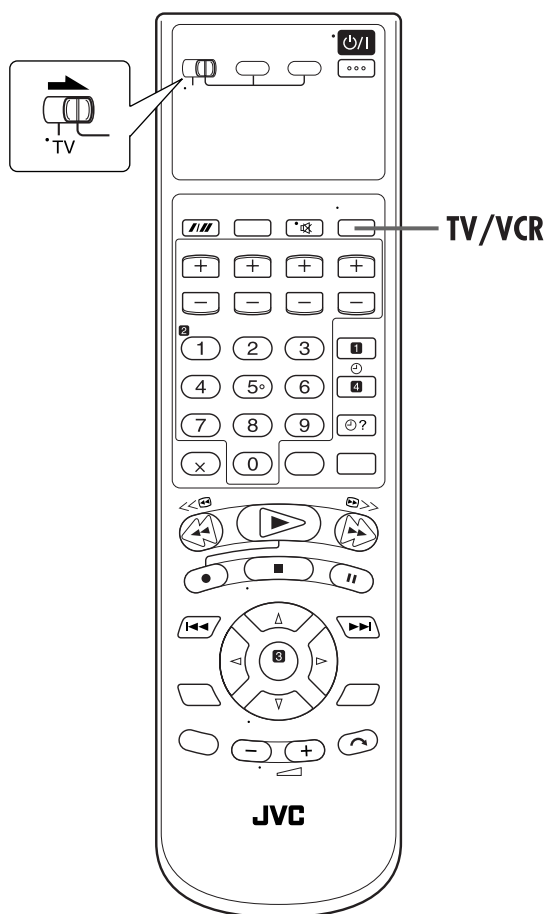
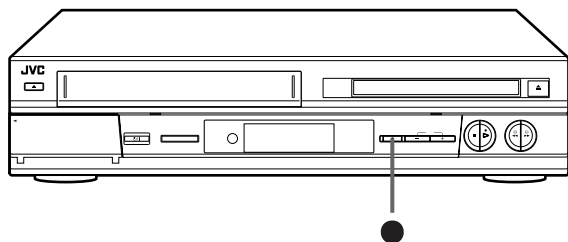

Record One Programme While Watching Another

If your unit is connected to the TV via the AV connection, press **TV/VCR**. The unit's VCR indicator and the TV broadcast being recorded disappear. Once recording is in progress, all you need to do is to set the channel controls on the TV for the station you wish to view.

- The programme selected with the TV's channel controls appears on the TV screen, while the one selected with the unit's **PR** buttons is recorded on the tape.
- If a decoder is connected to the unit (pg. 68), you can select a scrambled channel as well with the TV channel controls.

Instant Timer Recording (ITR)

This easy method lets you record for from 30 minutes to 6 hours (selectable in 30-min. increments), and shuts the unit off after recording is finished.

1 Start recording.

Press ● on the unit.

2 Engage the ITR mode.

Press ● again. "○" blinks and "0:30" appears on the front display panel.

3 Set the recording duration.

If you want to record for more than 30 minutes, press ● to extend the time. Each press extends recording time by 30 minutes.

NOTE:

You can only perform ITR using the ● button on the unit's front panel.

Accidental erasure prevention

To prevent accidental recording on a recorded cassette, remove its safety tab. To record on it later, cover the hole with adhesive tape.

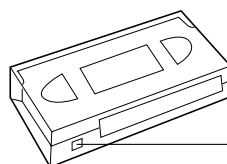

Record safety tab

Receiving Stereo and Bilingual Programmes

Your unit is equipped with a Sound-Multiplex decoder (A2) and a Digital stereo sound decoder (NICAM) making reception of stereo and bilingual broadcasts possible. When the channel is changed, the type of broadcast being received will be displayed on the TV screen for a few seconds.

Type of Broadcast Being Received	On-screen Display
A2 Stereo	ST
A2 Bilingual	BIL.
Regular Monaural	(none)
NICAM Stereo	ST NICAM
NICAM Bilingual	BIL. NICAM
NICAM Monaural	NICAM

- To listen to a stereo programme, press **A.MONITOR** until "HIFI L R" appears on the TV screen.
- To listen to a bilingual programme, press **A.MONITOR** until "HIFI L R" or "HIFI R" appears on the TV screen.
- To listen to the standard (Regular Monaural) audio while receiving a NICAM broadcast, press **A.MONITOR** until "NORM" appears on the TV screen.

NOTE:

"O.S.D." must be set to "ON", or the on-screen displays will not appear. (pg. 72)

To Record Stereo and Bilingual Programmes (A2)

Stereo programmes are automatically recorded in stereo on the Hi-Fi audio track (with the normal audio track recording mixed L and R channel sound).

- Bilingual programmes are automatically recorded in bilingual on the Hi-Fi audio track. The main soundtrack will be recorded on the normal audio track.

To Record NICAM Stereo and Bilingual Programmes

The NICAM audio programme will be recorded on the Hi-Fi audio track, and the standard audio programme will be recorded on the normal audio track.

NOTES:

- If the quality of stereo sound being received is poor, the broadcast will be received in monaural with better quality.
- Before playing back a programme recorded in stereo, or a bilingual programme, refer to "Soundtrack Selection" on page 25.

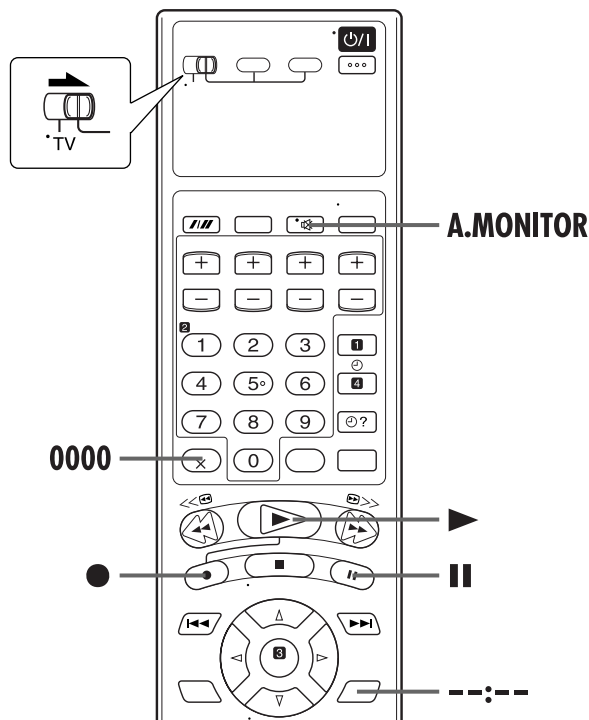

Elapsed Recording Time Indication

1 Set the counter display.

Press **--:--** until a counter reading appears on the front display panel.

- The front display panel shows the counter reading with ":" lit.

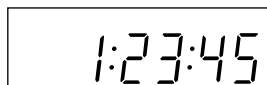

2 Reset the counter.

Press **0000** before starting recording or playback.

- The counter is reset to "0:00:00" and shows the exact elapsed time as the tape runs. You can check the exact time of a recording or playback.

Tape Remaining Time

Press **--:--** until the time remaining on the tape appears.

- The front display panel shows the tape remaining time with ":" blinking.
- By pressing the **--:--** button, you can change display to show the channel position*, clock time, counter reading or tape remaining time.



* Channel position is not displayed during playback.

NOTE:

Depending on the type of tape being used, the tape remaining time reading may not appear right away, or is not correct.

"--:--" may sometimes appear, or the display may blink on occasion.

B.E.S.T. Picture System

The B.E.S.T. (Biconditional Equalised Signal Tracking) system checks the condition of the tape in use during playback and recording, and compensates to provide the highest-possible playback and recording pictures. You can set "B.E.S.T." to "ON" or "OFF" to your preference. (☞ pg. 71)

Playback

The unit assesses the quality of the tape once you initiate playback.

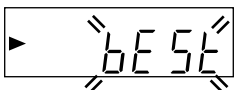

- The unit adjusts the playback picture quality based on the quality of the tape in use.
- B.E.S.T. is active during automatic tracking. "bEST" appears blinking on the front display panel.

NOTES:

- When watching a tape recorded with "B.E.S.T." set to "ON", it is recommended that you leave B.E.S.T. on during playback as well.
- When watching a rental tape or one recorded on another video recorder, or when using this unit as the player for editing, set B.E.S.T. to your preference. (☞ pg. 71)
- "bEST" only appears at the beginning of automatic tracking. Even though it doesn't appear after that, the B.E.S.T. function is operative.

Recording

The unit assesses the quality of the tape once you initiate recording.

DURING B.E.S.T.

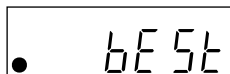

B.E.S.T. COMPLETE

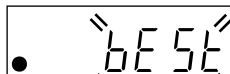

- The unit spends approximately 7 seconds assessing the condition of the tape, then begins recording.

NOTES:

- The B.E.S.T. system works for both SP and LP (or EP) modes only after a tape has been inserted and the Record mode is first initiated. It does not work during recording.
- The B.E.S.T. system does not work while Automatic Satellite Programme Recording is in progress. (☞ pg. 35)
- In the case of timer recordings, the B.E.S.T. system works before recording is initiated.
- Once the cassette is ejected, the B.E.S.T. data is cancelled. The next time the cassette is used for recording, B.E.S.T. is re-performed.
- Pressing the unit's ● button while "bEST" is displayed does not start Instant Timer Recording. (☞ pg. 27)

ATTENTION

Since the B.E.S.T. system works before recording actually starts, there is a delay of approximately 7 seconds after ● and ► on the remote control are pressed, or ● on the unit is pressed. To make sure you record the desired scene or programme in its entirety, first perform the following steps:

- 1 Press and hold ■ and press ● to engage the Record Pause mode.
- The unit then automatically checks the condition of the tape and, after approximately 7 seconds, re-enters Record Pause mode.
- 2 Press ► to start recording.

If you want to bypass the B.E.S.T. system and begin recording immediately, set "B.E.S.T." to "OFF". (☞ pg. 71)

SHOWVIEW® Timer Programming

With the SHOWVIEW system, timer programming is greatly simplified because each TV programme has a corresponding code number which your unit is able to recognize.

Before performing the SHOWVIEW Timer Programming:

- Make sure that the unit's built-in clock is set properly.
- Insert a cassette with the safety tab in place. The unit will come on automatically.
- Turn on the TV and select the video channel (or AV mode).
- Slide the TV/S-VHS/DVD switch to the right.

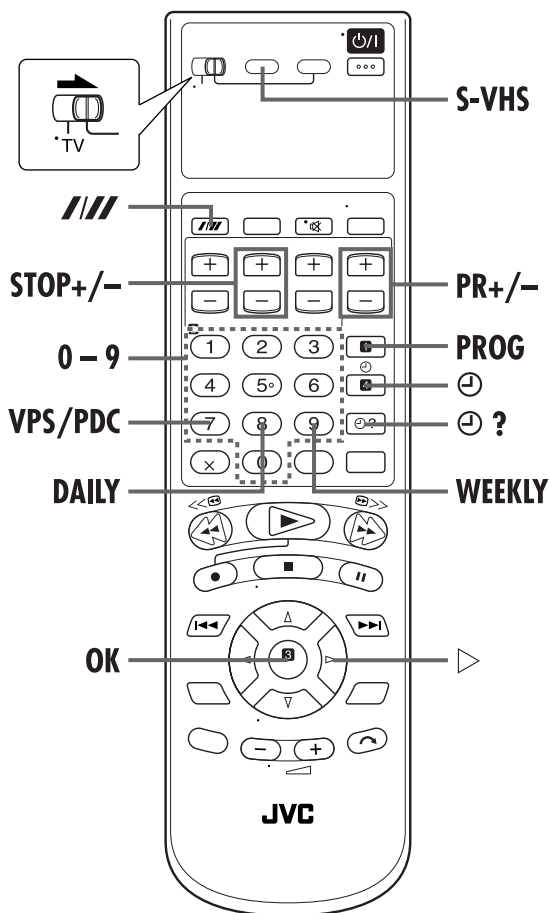

1 Select the S-VHS deck.

On the unit

Press **S-VHS/DVD** repeatedly so that the S-VHS indicator lights up.

On the remote control

Press **S-VHS** so that the S-VHS indicator lights up.

2 Access the SHOWVIEW screen.

Press **PROG.**

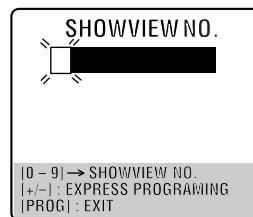

The front display panel looks like this:

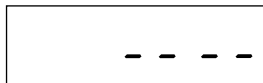

3 Enter the SHOWVIEW number.

Press the **number keys** to enter the SHOWVIEW number of a programme you wish to record.

- If you make a mistake, press **X** and input the correct number.



The SHOWVIEW number you enter appears on the front display panel with only a 4-digit number:

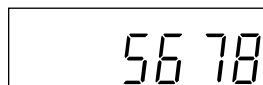

4 Access the SHOWVIEW Program screen.

Press **OK**, then the SHOWVIEW Program screen appears (if you're just starting out, "P1" appears).

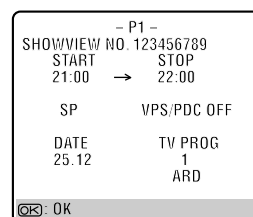

The front display panel shows the programme number. Pressing **⊕ ?** changes the display to the programme start time, the stop time, the date, the tape speed then the channel position.

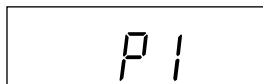

IMPORTANT

Make sure the channel position number you wish to record is displayed; if not, or "TV PROG" shows "--", see steps 2 - 3 of "Guide Program Number Set" on page 31 and set the Guide Program number correctly.

- If the number you entered is invalid, "ERROR" appears on the TV screen and "Err" appears on the front display panel. Press **X** and input a valid SHOWVIEW number.

5 Set the tape speed.

Press **SP/LP/EP (///)**.



- It is not possible to select EP mode if "COLOUR SYSTEM" is set to "MESECAM". (☞ pg. 74)

6 Set the VPS/PDC mode.

Press **VPS/PDC (number key "7")** to select "ON" or "OFF".

- If "VPS/PDC ON" is displayed on the TV screen, "VPS/PDC" is set to "ON".
 - If "VPS/PDC OFF" is displayed on the TV screen, "VPS/PDC" is set to "OFF".
- ☞ "VPS/PDC Recording" on page 33.

7 Return to the normal screen.

Press **PROG** or **OK**. "PROGRAM COMPLETED" appears on the TV screen for about 5 seconds, then the normal screen appears.

- Repeat steps 2 – 7 for each additional programme.

8 Engage the unit's timer mode.

Press **⊖ (TIMER)**. The unit turns off automatically and "⊖" appears on the front display panel.

- To disengage the timer mode, press **⊖ (TIMER)** again.

NOTES:

- To Change The Stop Time:
 - press **STOP +/-** after pressing **OK** in step 4. You can compensate for anticipated programme schedule delays.
- To Timer-Record Weekly Or Daily Serials:
 - after pressing **OK** in step 4, press **WEEKLY (number key "9")** for weekly serials or **DAILY (number key "8")** for daily serials (Monday — Friday). Either "WEEKLY" or "DAILY" appears on the TV screen. Pressing the button again makes the corresponding indication disappear.
- You can programme this unit to timer-record as many as 8 programmes. If you try to programme the unit to record a ninth, "PROGRAM FULL" appears on the TV screen and "FULL" appears on the front display panel. To record the extra programme, you must first cancel any unnecessary programmes. (☞ pg. 34)
- If there is a conflict in the timer schedule and one programme overlaps with another, the programme starting earlier or programme with the lower programme number will be recorded.

Satellite Receiver Users

To timer-record a satellite broadcast using the SHOWVIEW system:

- Set "L-2 SELECT" to "A/V". (☞ pg. 61)
- Perform steps 1 – 8.
- Set the satellite receiver to the appropriate channel before the selected programme begins.
- Leave the satellite receiver's power on.

ATTENTION

Guide Program Number

"Guide Program number" refers to the assigned TV station numbers, according to broadcast area, for the SHOWVIEW timer recording. The Guide Program numbers can be found in most TV listings.

If the Guide Program numbers are not set properly when you timer-record a TV programme using the SHOWVIEW system, the unit will record a TV programme of a different station. When programming the timer using the SHOWVIEW system, be sure to check the desired channel is selected correctly. Set the Guide Program numbers only in the following cases:

- When timer-programming with the SHOWVIEW system, the channel position, where the station you wish to record is received on your unit, is not selected.

OR

- When timer-programming with the SHOWVIEW system, "TV PROG" shows "– –".

OR

- When you add a channel after Auto Set Up, Preset Download or Auto Channel Set has taken place.

OR

- When you wish to timer-record a satellite programme with the SHOWVIEW system.

Guide Program Number Set

- Perform steps 1 – 4 of "SHOWVIEW® Timer Programming" (☞ pg. 30).
- Press **PR +/-** to input the channel position number on which your unit receives the station, then press **OK** or **▷** to set the Guide Program number.
- Perform steps 5 – 8.

Express Timer Programming

If you do not know the SHOWVIEW number for the programme you wish to record, use the following procedure to set your unit to timer-record the programme.

Before performing Express Timer Programming:

- Make sure that the unit's built-in clock is set properly.
- Insert a cassette with the safety tab in place. The unit will come on automatically.
- Turn on the TV and select the video channel (or AV mode).
- Slide the TV/S-VHS/DVD switch to the right.

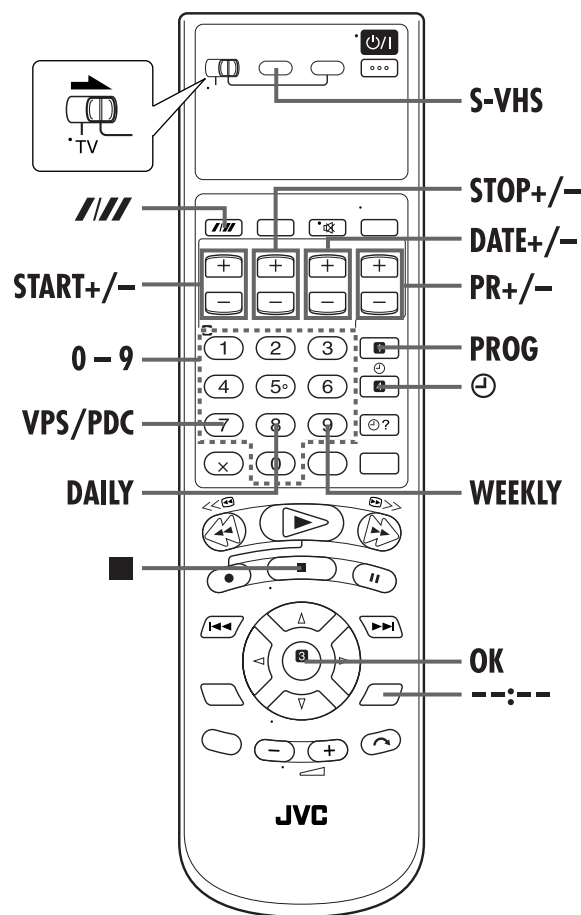

Example: To timer-record the programme from 21:00 to 22:00 on 25th December, on channel 1.

1 Select the S-VHS deck.

On the unit

Press **S-VHS/DVD** repeatedly so that the S-VHS indicator lights up.

On the remote control

Press **S-VHS** so that the S-VHS indicator lights up.

2 Access the SHOWVIEW screen.

Press **PROG.**

3 Access the Programme screen.

Press **START +/-**. (If you're just starting out, "P1" appears.)

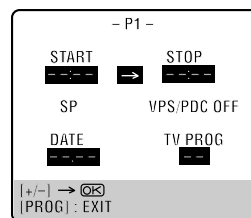

The front display panel looks like this:

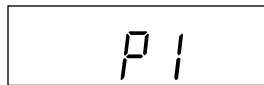

4 Enter the programme start time.

Press **START +/-** to enter the time you want recording to start.

- Press and hold **START +/-** to move in 30-minute increments, or press and release repeatedly to move 1 minute at a time.

The front display panel looks like this:

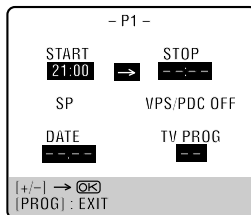
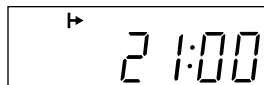

5 Enter the programme stop time.

Press **STOP +/-** to enter the time you want recording to stop.

- Press and hold **STOP +/-** to move in 30-minute increments, or press and release repeatedly to move 1 minute at a time.

6 Enter the programme date.

Press **DATE +/-**.

- The current date appears on the TV screen. The date you enter appears in its place.

7 Enter the channel position.

Press **PR +/-**.

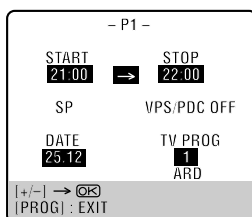

8 Set the tape speed.

Press **SP/LP/EP (///)**.



- It is not possible to select EP mode if "COLOUR SYSTEM" is set to "MESECAM". (☞ pg. 74)

9 Set the VPS/PDC mode.

Press **VPS/PDC (number key "7")** to select "ON" or "OFF".

- If "VPS/PDC ON" is displayed on the TV screen, "VPS/PDC" is set to "ON".
 - If "VPS/PDC OFF" is displayed on the TV screen, "VPS/PDC" is set to "OFF".
- ☞ "VPS/PDC Recording" in the right column

10 Return to the normal screen.

Press **PROG** or **OK**. "PROGRAM COMPLETED" appears on the TV screen for about 5 seconds, then the normal screen appears.

- Repeat steps 2 – 10 for each additional programme.

11 Engage the unit's timer mode.

Press **⊖ (TIMER)**. The unit turns off automatically and "⊖" appears on the front display panel.

- To disengage the timer mode, press **⊖ (TIMER)** again.

To Timer-Record Weekly Or Daily Serials:

— anytime during steps 2 through 9, press **WEEKLY (number key "9")** for weekly serials or **DAILY (number key "8")** for daily serials (Monday – Friday). Either "WEEKLY" or "DAILY" appears on the TV screen. Pressing the button again makes the corresponding indication disappear.

NOTES:

- You can programme this unit to timer-record as many as 8 programmes. If you try to programme the unit to record a ninth, "PROGRAM FULL" appears on the TV screen and "FULL" appears on the front display panel. To record the extra programme, you must first cancel any unnecessary programmes. (☞ pg. 34)
- If there is a conflict in the timer schedule and one programme overlaps with another, the programme starting earlier or programme with the lower programme number will be recorded.

Satellite Receiver Users

To timer-record a satellite broadcast using Express Timer Programming:

- Set "L-2 SELECT" to "AV". (☞ pg. 61)
- Perform steps 1 – 11. Enter "L-2" for the channel position in step 7.
- Set the satellite receiver to the appropriate channel before the selected programme begins.
- Leave the satellite receiver's power on.

VPS/PDC Recording

Now available from some TV stations, PDC (Programme Delivery Control) and VPS (Video Programme System) are service designed to assure safe, accurate timer recording. With this system, special code signals are transmitted together with the audio/video signals. These code signals control your unit and have precedence over the advertised times you may have preset into the timer. This means that your unit will start and stop recording when the preset TV programmes actually start and end — even if the broadcast time of a preset TV programme is changed.

NOTES:

- When you use Express Timer Programming, set the start time (VPS or PDC time) exactly as advertised in the TV listing. A different time than advertised will result in no recording.
- VPS/PDC recording is also possible when a satellite receiver or a cable system is connected to L-2 IN/DECODER connector on your unit.
- VPS/PDC recording is also possible via the L-1 IN/OUT connector.

How to check if the station being received transmits a VPS/PDC signal

- Press **--:--** until the channel position appears on the front display panel.
- Hold down **START +** for about 5 seconds. "VPS/PDC" appears blinking on the TV screen. If a VPS/PDC signal is detected from the station, "VPS/PDC" will stop blinking. If no VPS/PDC signal is detected from the station, "VPS/PDC" will blink at a slower rate.
- Press **--:--** or **START +** again to return to normal display.

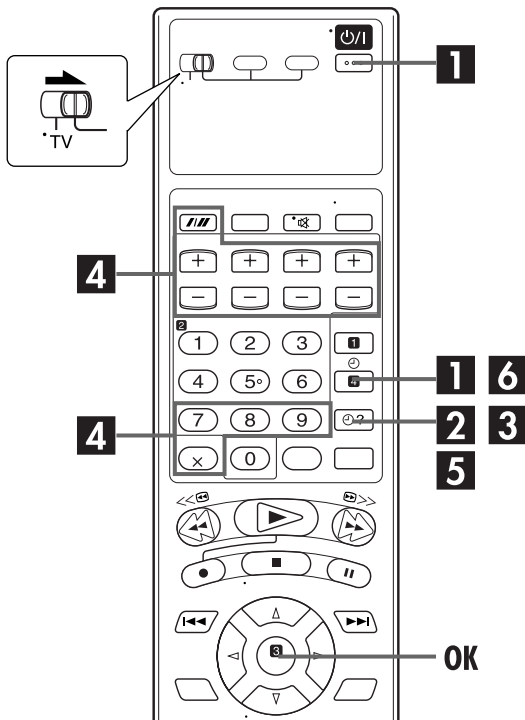

Check, cancel and change programmes

1 Disengage the timer mode.

Press **⊖** (TIMER), then press **⏻**.

2 Access the Programme Check screen/display.

Press **⊖ ?**.

	START	STOP	CH	DATE
1	8:00	10:00	3	24.12
2	10:00	10:45	2	25.12
3	11:30	13:00	1	25.12
4				
5				
6				
7				
8				

⊖ ? | NEXT

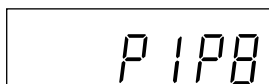

3 Access the Programme screen/display.

Press **⊖ ?** again to check more information. Each time you press **⊖ ?**, the next programme's information appears.

- P1 -	
START	STOP
8:00	10:00
SP	VPS/PDC OFF
DATE	TV PROG
24.12	8
	WDR

⊖ ? | NEXT

The front display panel shows the programme number. Pressing **OK** changes the display to the programme start time, the stop time, the date, the tape speed then the channel position.



To cancel or change a programme

4 Cancel or change a programme.

Press **×** to cancel a programme. To change programme settings, press the appropriate button: **START +/-**, **STOP +/-**, **DATE +/-**, **PR +/-**, **VPS/PDC** (number key "7"), **DAILY** (number key "8"), **WEEKLY** (number key "9") and/or **SP/LP/EP** (///).

5 Return to the normal screen/display.

Press **⊖ ?** as many times as necessary. If there are still some programmes remaining, go on to step 6.

6 Return to the timer mode.

Press **⊖** (TIMER).

NOTE:

You can also check the programmes on the front display panel even if the unit's power is off (unless the unit is in the Power Save mode pg. 73) or the unit is in the Timer mode; however, it is not possible to cancel or change the programmes.

Automatic Satellite Programme Recording

This function allows you to automatically record a satellite programme which is timer-programmed on your external satellite receiver. Connect a satellite receiver to the unit's L-2 IN/DECODER connector and programme the timer on the satellite receiver. The unit starts or stops recording by the signals input from the satellite receiver. After recording, the unit's power shuts off automatically.

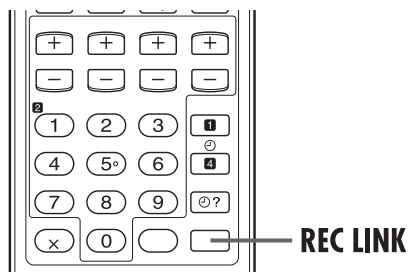
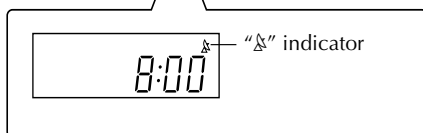
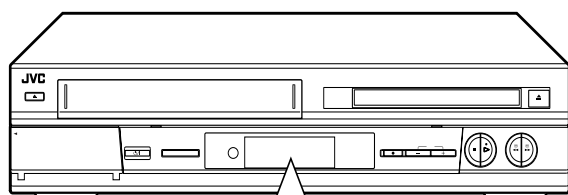

ATTENTION

- Be sure not to turn on the satellite receiver before the programme is executed; otherwise, the unit will start recording when the satellite receiver's power is turned on.
- If you have connected another appliance other than a satellite receiver to the L-2 IN/DECODER connector, be sure not to engage the Automatic Satellite Programme Recording mode; otherwise, the unit will start recording when the connected appliance's power is turned on.
- Automatic Satellite Programme Recording and timer-recording cannot be done at the same time.

Before performing the following steps:

- Make sure the satellite receiver is connected to the unit's L-2 IN/DECODER connector. (☞ pg. 66, 67)
- Programme the timer on the satellite receiver.
- Insert a cassette with the safety tab in place.
- Slide the TV/S-VHS/DVD switch to the right.

1 Select the S-VHS deck.

On the unit

Press **S-VHS/DVD** repeatedly so that the S-VHS indicator lights up.

On the remote control

Press **S-VHS** so that the S-VHS indicator lights up.

2 Select the L-2 SELECT mode.

Set "L-2 SELECT" to "A/V" or "SAT". (☞ pg. 61)

- When you select "SAT", refer to "IMPORTANT" on page 66.

3 Set the tape speed.

Press **SP/LP/EP (///)**.

- It is not possible to select EP mode if "COLOUR SYSTEM" is set to "MESECAM". (☞ pg. 74)

4 Engage the Automatic Satellite Programme Recording mode.

Press and hold **REC LINK** for about 2 seconds. The "S-VHS" indicator lights up and the unit turns off automatically.

NOTES:

- To disengage the Automatic Satellite Programme Recording mode, press **REC LINK**. The "S-VHS" indicator goes off.
- If the unit's power is off, it is not possible to engage the Automatic Satellite Programme Recording mode.
- In step 4, if the "S-VHS" indicator does not light but instead blinks quickly even though your satellite receiver's power is off, Automatic Satellite Programme Recording will not work properly with that satellite receiver*. If this is the case, perform "Express Timer Programming" (☞ pg. 32) to timer-record a satellite programme.
* Some satellite receivers output signals even if the power is off. Automatic Satellite Programme Recording is not possible with those satellite receivers.
- The "S-VHS" indicator blinks while Automatic Satellite Programme Recording is in progress.
- For timer programming of the satellite receiver, refer to the instruction manual of the satellite receiver.
- Automatic Satellite Programme Recording is not possible if your satellite receiver does not have a timer.
- Pressing the unit's **⏻** button while Automatic Satellite Programme Recording is in progress turns off the unit's power and disengages the Automatic Satellite Programme Recording mode.
- If there are more than one satellite programmes you wish to record with Automatic Satellite Programme Recording, it is not possible to set different tape speeds for each programme.
- Depending on the type of satellite receiver, the unit may not record a slight portion of the beginning of the programme or may record slightly longer than the actual length of the programme.
- If you engage the Automatic Satellite Programme Recording mode when the satellite receiver's power is on, the unit will not start Automatic Satellite Programme Recording even though the "S-VHS" indicator blinks. When the satellite receiver shuts off once and is turned back on again, the unit starts recording.
- You can also record a programme from your cable system in the same way if the system has a timer.
- The B.E.S.T. system (☞ pg. 29) does not work while Automatic Satellite Programme Recording is in progress.
- Just Clock (☞ pg. 84) does not work when the Automatic Satellite Programme Recording mode is engaged.

Basic Playback



- Turn on the TV and select the video channel (or AV mode).
- Slide the **TV/S-VHS/DVD** switch to the right.

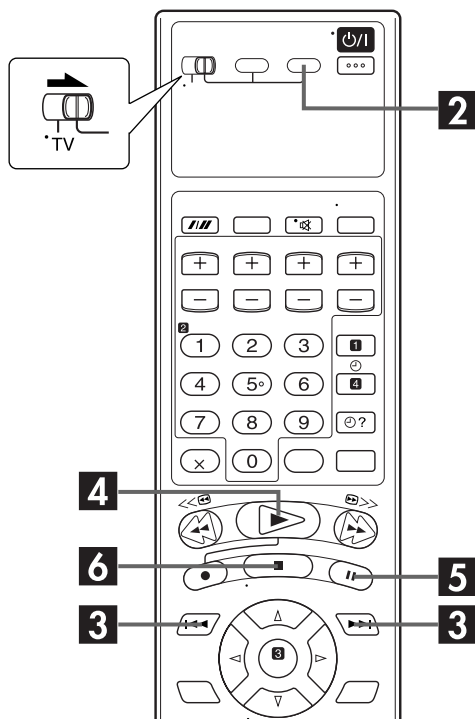
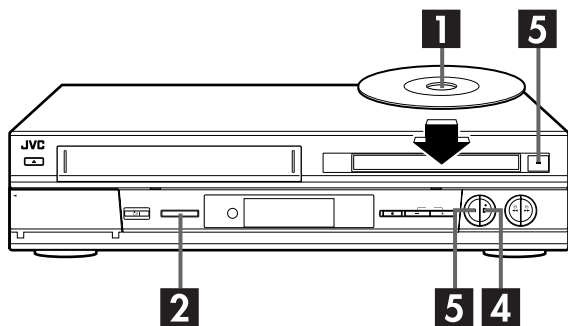

ATTENTION

- You can not use the DVD deck when the S-VHS deck is in the Automatic Satellite Programme standby and recording mode.
- You can use the DVD deck when the S-VHS deck is in the timer standby mode.

To play back a MP3 disc, see pages 54 – 57.

1 Load the disc.

- 1 Press **▲** on the DVD deck to open the disc tray.
 - The unit's power comes on automatically.
- 2 Place the disc in the disc tray.
 - For details, refer to "Placing a Disc" (pg. 7).
- 3 Press **▲** on the DVD deck to close the disc tray.
 - Pressing **▶** also close the disc tray.
 - Playback begins automatically if the auto-playback DVD disc is loaded.

2 Select the DVD deck.

On the unit

Press **S-VHS/DVD** repeatedly so that the DVD indicator lights up.

On the remote control

Press **DVD** so that the DVD indicator lights up.

3 Select the item.

Press **◀◀** to locate the beginning of the previous item, and press **▶▶** to locate the beginning of the next item.

4 Start playback.

Press **▶**.

- It may take a few seconds to start playback.
- If you load a DVD disc whose region code does not match the DVD deck, "REGION CODE ERROR!" appears on the TV screen. For detail, refer to "Region Number" (pg. 5).
- If "The DISC can't play now!" appears on the TV screen, refer to "Parental Lock" (pg. 50).
- With Video CD discs with PBC control or some DVD discs, the menu display may appear on the TV screen after starting playback. In this case, select an item which you want to play back from the menu. Otherwise, the playback cannot go forward. Refer to "Locating a desired scene using the menu of the Video CD with PBC" (pg. 37) or "Locating a desired scene using the DVD menu" (pg. 37).

5 Pause playback.

Press **⏸**.

- To resume normal playback, press **▶**.

6 Stop playback.

Press **■**. Press **▲** on the DVD deck to open the disc tray, then remove the disc.

- Pressing **▶** resume playback from the position where you stop playback. For details, see "Resume Function" on page 39.

NOTE:

When you press **▲** while the unit is turned off, the unit's power comes on and the disc tray opens automatically.

Playback Features

- Turn on the TV and select the video channel (or AV mode).
- Slide the TV/S-VHS/DVD switch to the right.

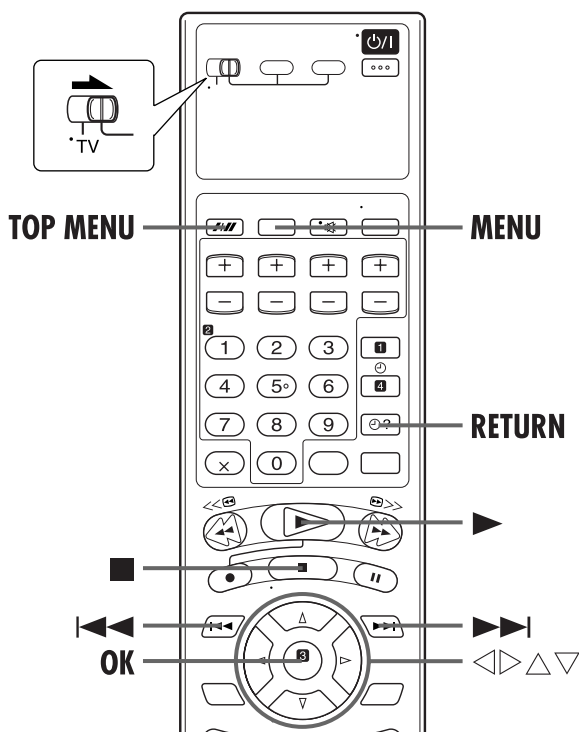

Playback Control (PBC) Function

— Locating a desired scene using the menu of the Video CD with PBC



Some Video CD discs supports the PBC function. PBC is an abbreviation of "PlayBack Control." A Video CD disc recorded with PBC has its own menus, such as a list of the songs of the disc. You can locate a specific scene by using the menu.

1 Access the PBC menu.

In stop mode

Press **▶**.

During playback

Press **TOP MENU**.

- "Pbc" appears on the front display panel.

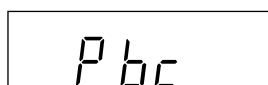
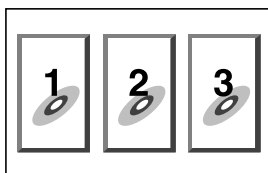

2 Start playback.

Press the appropriate **number keys**.

- The unit starts playback of the selected item.
- When "NEXT" or "PREVIOUS" appears on the TV screen: Pressing **▶▶** advances to the next page. Pressing **◀◀** returns to the previous page.
- You can return to the menu by pressing **RETURN**.
- The method of the operation is different depending on the disc.

NOTES:

- You can also activate the PBC function using the Play Set Up menu. (pg. 48)
- If you want to playback a PBC-compatible Video CD disc without activating the PBC function, start playback by using the **number keys** instead of the **▶** button.
- To activate the PBC function when a PBC-compatible Video CD disc is being played back without the PBC function, press **TOP MENU**, or press **■** then press **▶**.

Locating a desired scene using the DVD menu



DVD VIDEO discs may have two types of the menus; top menu and disc menu.

Top menu

DVD discs generally have their own menus which show the disc contents. These menus contain various items such as titles of a movie, names of songs, or artist information. You can locate a desired scene by using the top menu displayed on the TV screen. Press **TOP MENU** to access the top menu.

Disc menu

DVD discs have the disc menu to select subtitle and audio language etc. for each title. Press **MENU** to access the disc menu.

1 Access the DVD menu.

Press **TOP MENU** or **MENU**.

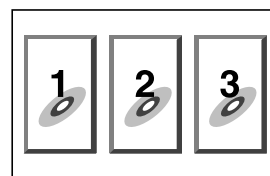

Example:

2 Start playback.

Press **◀◀** or **▶▶** to select a desired item, then press **OK**.

- It may be possible to select the desired item using the **number keys** depending on the disc.

NOTE:

When "◻" appears on the TV screen in step 1, the disc does not have a top menu or disc menu.

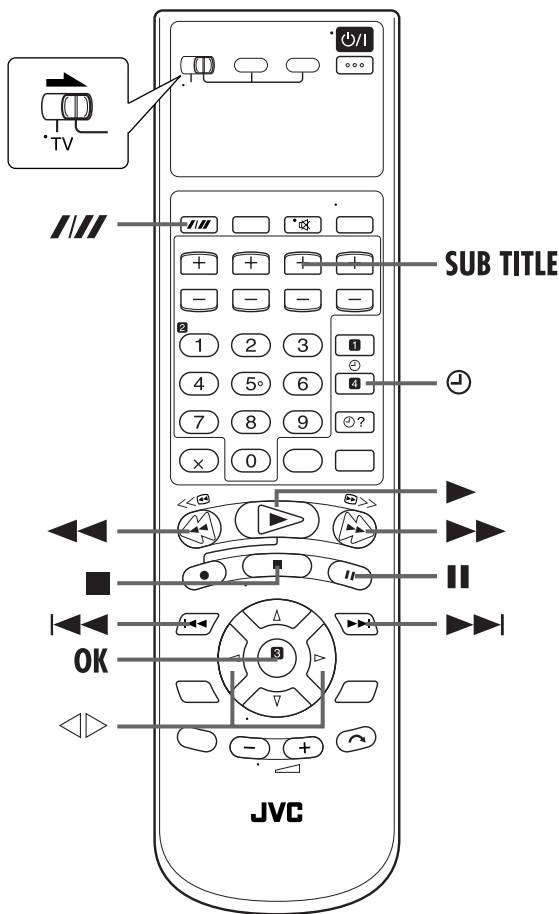

Locating the start point of the item or skip the item



Press ◀◀ or ▶▶ during playback.

Example:

To locate the beginning of item B from the current position, press ◀◀ twice.

To locate the beginning of item D from the current position, press ▶▶ once.

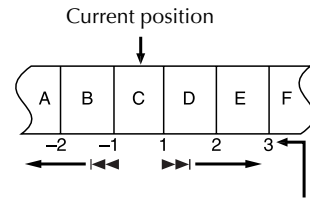

The number you press the button

- When the specified item is located, playback begins automatically.

High-Speed Search



During playback, press ▶▶ for forward high-speed search, or ◀◀ for reverse high-speed search.

- To resume normal playback, press ▶.

OR

During playback, press and hold ▶▶ for forward high-speed search, or press and hold ◀◀ for reverse high-speed search.

- To resume normal playback, release ◀◀ or ▶▶.

Still Picture/Frame-By-Frame Playback



1 Pause during playback.

Press **II**.

2 Activate frame-by-frame playback.

Press **II**.

- When you press and hold **II** for more than 2 seconds, the unit enters in strobe playback pause mode. (pg. 39). To cancel strobe playback mode, press and hold **II** for more than 2 seconds again.

- To resume normal playback, press ▶.

Slow Motion



During still picture, press ◀◀ or ▶▶.

- The speed changes for each direction by pressing ◀◀ or ▶▶ repeatedly.
- To resume normal playback, press ▶.

Resume Function



It is possible to memorize the position where you stop playback and resume playback from that position.

- Be sure to set "RESUME" to "ON". (☞ pg. 77)

1 Memorize the resume point.

Press ■.

- The unit enters Resume Stop mode and memorise the position where you stop playback as the resume point.
- "rESUM" appears on the front display panel.

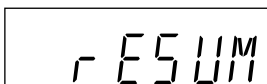

- To clear the resume point:

- Press ⏻ to turn off the unit.
- Eject the disc.
- Press ■ in stop mode.
- Set "RESUME" to "OFF". (☞ pg. 77)

2 Resume playback.

Press ▶. The unit start playback from the resume point.

- "rESUM" appears on the front display panel.

Strobe Playback

— To display continuous still pictures



During playback, press and hold ■ for more than 2 seconds at the point you want to view as continuous photographs.

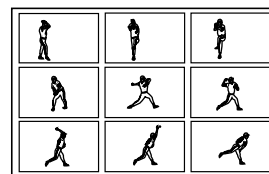

- 9 continuous still pictures appear on the TV screen.
- While the 9 still pictures are shown, pressing ■ will pause the Strobe playback. After pausing, each time you press ■, the still picture advances frame-by-frame.
- Pressing ▶ while the 9 still pictures are shown will advance pictures in normal playback speed.
- To return to normal playback, press and hold ■ for more than 2 seconds.

NOTES:

- During the operation above, audio is not played back.
- When playing back NTSC discs, the 9 still pictures may appear vertically distorted, or a stripe may appear at the bottom of the screen. This is not a malfunction.

Subtitle Selection



You can select subtitle language.

1 Access the selection menu.

Press SUB TITLE during playback.

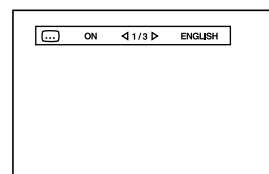

2 Select the subtitle language.

Press ◁▷ to select your desired subtitle language, then press OK.

- Each time you press SUB TITLE, the subtitle display is switch to on and off.
- Each time you press ◁▷, the subtitle language changes.
- The selection menu disappears automatically if you do not change the selection for 5 seconds.

NOTE:

When "⊗" appears on the TV screen in step 1, subtitle language is not recorded.

Angle Selection (A)



You can enjoy a variety of scene angles if the DVD VIDEO disc contains "multi-angle" parts, where multiple cameras were used to shoot the same scene from different angles.

If the disc contains "multi-angle" parts, "A" appears on the TV screen at the beginning of the "multi-angle" part when "ON SCREEN GUIDE" is set to "ON".

1 Access the selection menu.

Press **ANGLE** during playback.

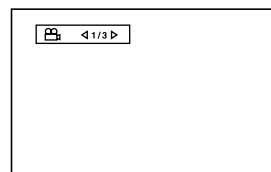

2 Select the angle.

Press **ANGLE** or $\triangleleft \triangleright$ to select the desired angle, then press **OK**.

- Each time you press **ANGLE** or $\triangleleft \triangleright$, the angle changes.
- The selection menu disappears automatically if you do not change the selection for 5 seconds.

NOTE:

When "A" appears on the TV screen in step 1, the current scene is not recorded from multiple angles.

Angle Selection (B)



1 Access the angle list.

Press and hold **ANGLE** for more than 1 second.

- Up to 9 camera angles recorded on the disc appear on the TV screen

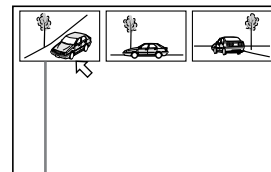

The selected camera angle

2 Select the angle.

Press $\triangle \nabla \triangleleft \triangleright$ to select the desired angle, then press **OK**.

NOTES:

- When "A" appears on the TV screen in step 1, the current scene is not recorded from multiple angles.
- During the operation above, audio is not played back.

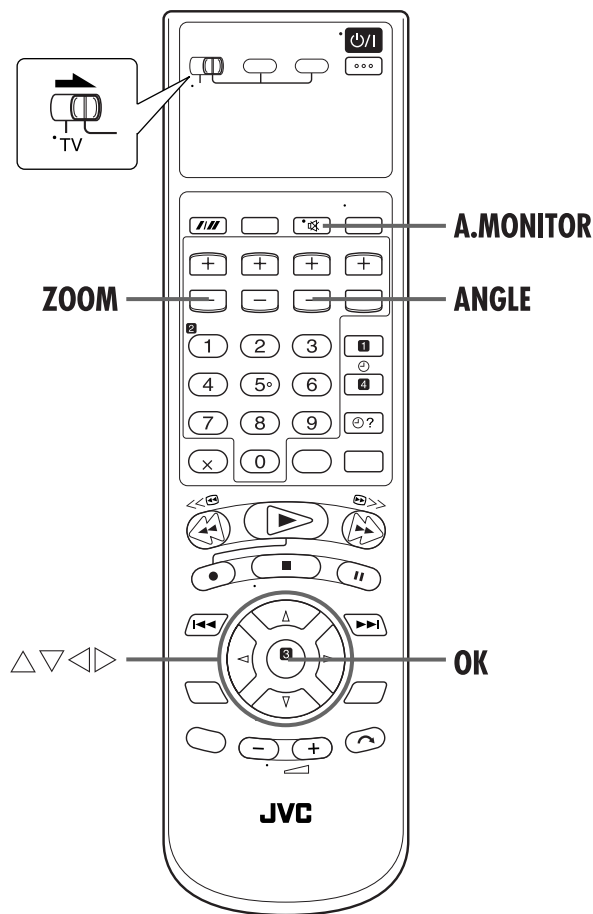

Audio Selection



Some DVD discs contain the multiple audio.
You can select the audio language of movies (DVD VIDEO) or select to enjoy karaoke with or without the vocal (Video CD).

1 Access the selection menu.

Press **A.MONITOR** during playback.

2 Select the audio.

Press **A.MONITOR** or $\triangleleft \triangleright$, then press **OK**.

- The selection menu disappears automatically if you do not change the selection for 5 seconds.

For DVD VIDEO

Each time you press **A.MONITOR** or $\triangleleft \triangleright$, the audio language or sound changes.

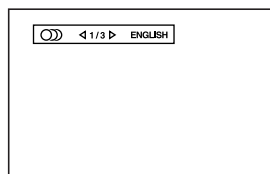

For Video CD

Each time you press **A.MONITOR** or $\triangleleft \triangleright$, the playback audio changes.

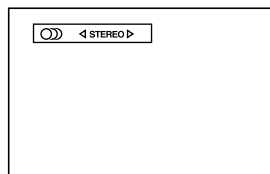

Zooming



Press **ZOOM** during playback.

- The unit zooms in to the centre part of the scene to produce a double-sized image.
- While zoomed, the picture may look coarse or distorted.

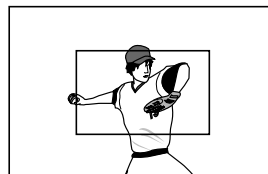

Press $\triangle \nabla \triangleleft \triangleright$ to move the zoomed-in scene.

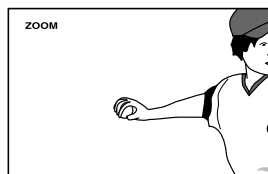

- To resume normal playback, press **ZOOM** again.

Digest



The unit can display the opening scene of each title or chapter (DVD VIDEO) or each track (Video CD). You can select a desired scene from those displayed on the TV screen.

For DVD VIDEO

In stop mode or during playback

For Video CD

In stop mode or during playback without PBC function

1 Access the digest screen.

Press **DIGEST**.

- Up to 9 opening scenes appear.

• DVD VIDEO

In stop mode, the opening scene of each title appears on the TV screen.

During playback, the opening scene of each chapter in the current title appears on the TV screen.

• Video CD

In stop mode or during playback, the opening scene of each track appears on the TV screen.



2 Start playback.

Press $\Delta \nabla \triangleleft \triangleright$ to move the arrow to the desired scene, then press **OK**.

- If there are more than 9 scenes, the digest screen will have more than one page. In this case, pressing $\triangleright \triangleright$ advances to the next page, while pressing $\triangleleft \triangleleft$ returns to the previous page.



Selected scene

- When the lower right scene is selected, pressing \triangleright advances to the next page if available. Similarly, when the upper left scene is selected, pressing \triangleleft returns to the previous page (if available).

NOTE:

With some discs, it may take some time until all the scenes appear on the screen depending on the contents.

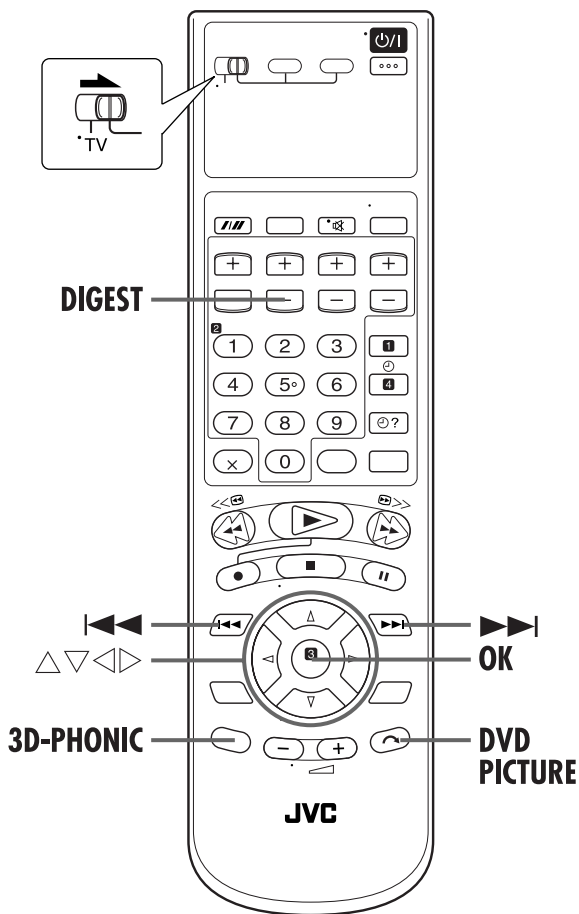

3D Phonic



3D Phonic function allows you to get a simulated surround effect from your stereo system. You can enjoy the vertical surround sound with your 2-channel stereo system.

1 Access the selection menu.

Press **3D-PHONIC** during playback.

- The current setting appears on the top left corner of the TV screen.

2 Select the mode.

Press **3D-PHONIC** repeatedly, then press **OK**.

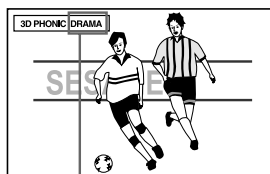

Selected mode

- Each time you press **3D-PHONIC**, the setting changes as follows:
ACTION→DRAMA→THEATER→OFF→(Back to the beginning)

ACTION:	Suitable for action movies and sports programs in which sounds dynamically move.
DRAMA:	Provides the natural and warm sound. You can enjoy movies in a relaxed mood.
THEATER:	You can enjoy sound effects like in a major theater in Hollywood.
OFF:	No effect

- The selection menu disappears automatically if you do not change the selection for 5 seconds.

NOTES:

- The 3D Phonic function works correctly only when playing back a DVD VIDEO disc recorded in the Dolby Digital format. With other sources, you cannot get any effect if you activate 3D Phonic function.
- When playing back a DVD VIDEO disc recorded with the Dolby Digital that does not contain the rear signal, you cannot get a correct 3D Phonic sound even if you activate 3D Phonic function.
- The 3D Phonic function does not affect the Dolby Digital bitstream signal from the DIGITAL AUDIO OUT connector.
- When you use the 3D Phonic function, it is not possible to set "DOWN MIX" or "COMPRESSION". (pg. 76)
- To turn off the 3D Phonic display manually, press **OK**.
- With a Video CD disc, if the Audio setting is set to L or R, you cannot activate the 3D Phonic function and the 3D Phonic mode is fixed to off.
- Conversely, when the 3D Phonic function is activated, changing the audio setting to L or R from STEREO cancels the 3D Phonic function.

Theater Mode

— Adjusting the picture quality



1 Access the selection menu.

Press **DVD PICTURE** during playback.

- The current setting appears on the top left corner of the TV screen.

2 Select the mode.

Press **DVD PICTURE** repeatedly.

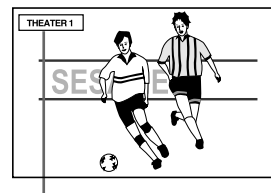

Selected mode

- Each time you press **DVD PICTURE**, the theater mode changes as follows:
THEATER1→THEATER2→THEATER3→THEATER OFF
→(Back to the beginning)
- "THEATER OFF" is the normal position. Select higher numbers to enhance the effect. Playback will be more subdued, with a lower brightness level.
- The selection menu disappears automatically if you do not change the selection for 5 seconds.

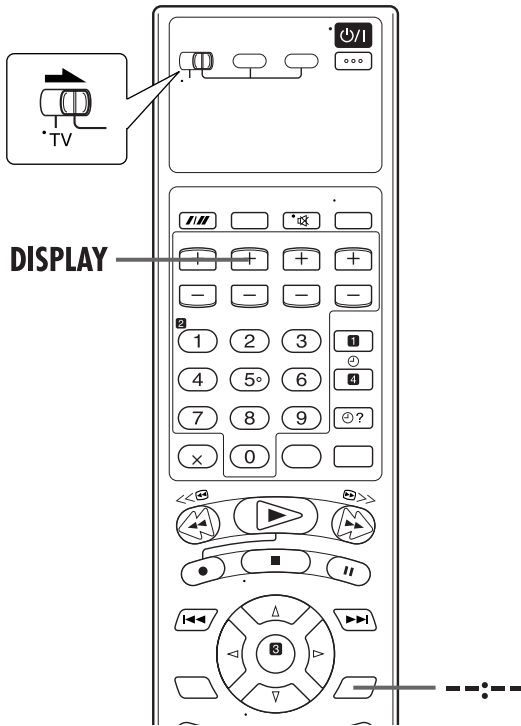

DVD VIDEO

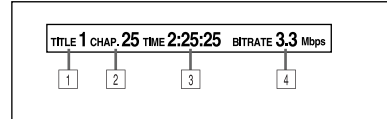

- 1 Current title number
- 2 Current chapter number
- 3 Elapsed time
- 4 Transmission rate

Video CD played back with PBC

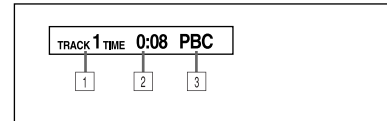

- 1 Current track number
- 2 Elapsed time
- 3 PBC playback indication

Audio CD, Video CD played back without PBC

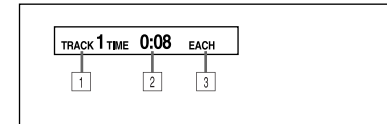

- 1 Current track number
- 2 Elapsed time
- 3 Current track elapsed time

Checking the DVD function status



Press **DISPLAY** during playback repeatedly until the disc status appears on the TV screen.

- The current selections of the camera angle, audio language and subtitle language are displayed.
- To return to the normal screen, press **DISPLAY** repeatedly.

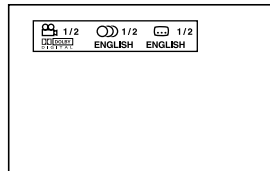

To change information on the front display panel

The disc time information also appears on the front display panel.

Each time you press **--:--**, the display changes as follows:

DVD VIDEO

Current title/Current chapter ↔ Elapsed time

Video CD/Audio CD

Number of tracks/Current track ↔ Elapsed time

Example: display for DVD VIDEO disc

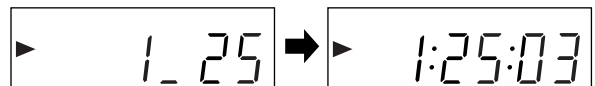

Disc Time Information



Press **DISPLAY** during playback repeatedly until the disc time information appears on the TV screen.

- To return to the normal screen, press **DISPLAY**.

Playback Features with Play Set Up Menu



Play Set Up Menu allows you the various playback operations. Press **REPEAT** to access the Play Set Up menu while the disc is in the disc tray.

- Turn on the TV and select the video channel (or AV mode).
- Slide the **TV/S-VHS/DVD** switch to the right.

In stop mode

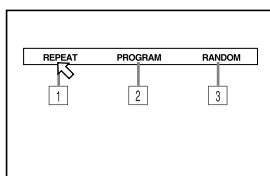

- 1 Repeat Playback
- 2 Programme Playback
- 3 Random Playback

During playback

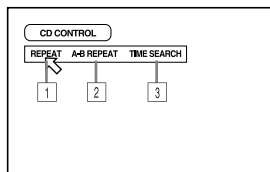
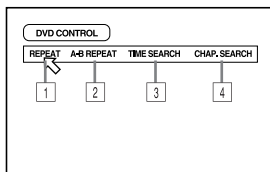

- 1 Repeat Playback
- 2 A-B Repeat Playback
- 3 Time Search
- 4 Chapter Search
- 5 PBC Playback

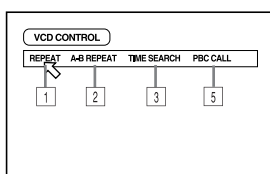

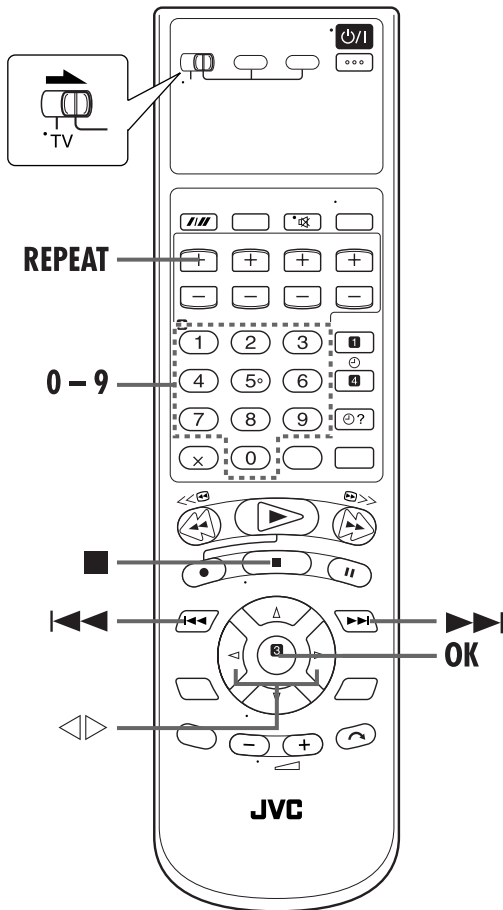

Repeat Playback



You can repeat playback as you like according to the type of disc.

1 Access the Play Set Up menu.

Press **REPEAT** during playback of the item you want to repeat.

2 Select the mode.

- 1 Press \triangleleft \triangleright to move the arrow to "REPEAT", then press **OK**.
- 2 Press **OK** repeatedly to select the appropriate mode.

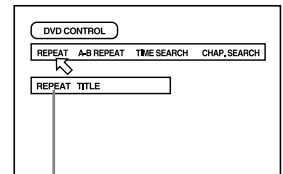

Selected mode

- Each time you press **OK**, the mode changes as follows:

DVD VIDEO

REPEAT TITLE → REPEAT CHAPTER → No indication → (Back to the beginning)

REPEAT TITLE:	The current title is played back repeatedly.
REPEAT CHAPTER:	The current chapter is played back repeatedly.
No indication (off):	Each title and chapter is played back once.

Video CD/CD

REPEAT ALL → REPEAT 1 → No indication → (Back to the beginning)

REPEAT ALL:	All tracks are played back repeatedly.
REPEAT 1:	The current track is played back repeatedly.
No indication (off):	Each track is played back once.

- To clear the Play Set Up menu, press **REPEAT**.
- To stop Repeat Playback, press **■**.
- To cancel Repeat Playback, press **REPEAT** repeatedly so that "REPEAT ALL" or "REPEAT 1" disappear from the TV screen.

NOTES:

- Repeat Playback is not possible with a Video CD with PBC function.
- Repeat Playback may not work properly depending on the type of disc being used.

A-B Repeat Playback



You can repeat the desired part.

1 Access the Play Set Up menu.

Press **REPEAT** during playback of the item you want to repeat.

2 Select the mode.

Press $\triangleleft \triangleright$ to move the arrow to "A-B REPEAT", then press **OK**.

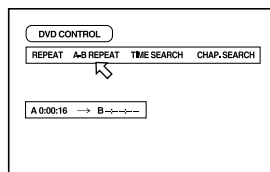

3 Set the "A" (start) point.

Press **OK** at the point where you want the Repeat Playback to start.

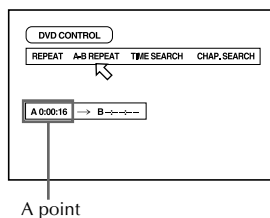

4 Set the "B" (end) point.

Press **OK** again at the point where you want the Repeat Playback to end. The unit locates "A" point and repeats playback between "A" and "B" point.

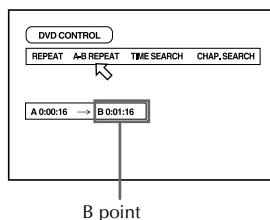

- To clear the Play Set Up menu, press **REPEAT**.
- To stop A-B Repeat Playback, press **■**.
- You can also stop Repeat Playback by pressing **OK**, or pressing $\triangleleft \triangleleft$ or $\triangleright \triangleright$.

NOTES:

- A-B Repeat Playback may not work properly depending on the type of disc being used.
- The subtitles recorded around A-B point may not appear.
- The end of the item will be set as "B" point if the end of the item reached before you set the "B" point.

Chapter Search



You can start playback the desired chapter.

1 Access the Play Set Up menu.

Press **REPEAT** during playback.

2 Select the mode.

Press $\triangleleft \triangleright$ to move the arrow to "CHAP. SEARCH", then press **OK**.

3 Select the chapter.

Press the appropriate **number keys** to select the desired chapter, then press **OK**. The unit starts playback from the selected chapter.

- If you have selected a wrong selection, press **X**, then select the correct number again.

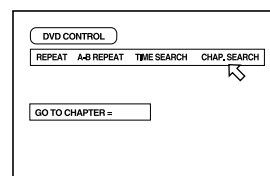

Examples:

- To select track 5, press the **number key "5"**.
- To select track 15, press the **number key "1"** and **"5"**.
- To select track 25, press **number key "2"** twice, then **"5"**.
- It is not possible to use the **number key "+10"**.

If you have specified a wrong selection

Press the appropriate **number keys** again.

- To clear the Play Set Up menu, press **REPEAT**.

NOTES:

- When "⊗" is displayed on the TV screen in step **3**, the chapter you have selected is not contained in the disc, or chapter search does not work on the disc.
- Chapter Search starts automatically when you select the desired chapter in step **3** depending on the disc.

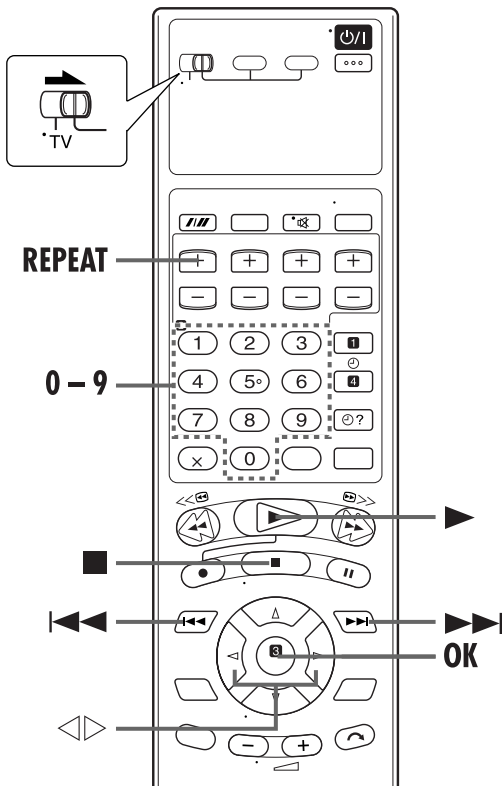

3 Enter the time.

Press the appropriate **number keys** to enter the desired time, then press **OK**.

- The DVD deck starts playback from the selected point.

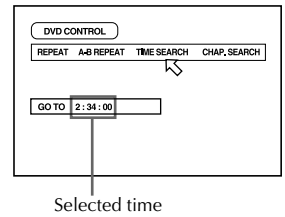

Examples: To play back from 1(H):30(M):00(S): Press the **number key** "1", "3", "0", "0", "0" then press **OK**.

- To clear the Play Set Up menu, press **REPEAT**.

NOTES:

- When "∞" is displayed on the TV screen in step 3, you have selected a point that exceeds the recording time of the disc.
- Some DVD VIDEO discs do not contain time information, and it is no possible to use the Time Search function. In such a case, "∞" is displayed on the TV screen as well.
- Time Search does not work while you play back the Video CD with the PBC Function. (pg. 37, right column)

Playback Control (PBC) Function



You can reactivate the PBC function when you play back a PBC-compatible Video CD disc without PBC function.

Time Search



You can play back a disc from the desired point by specifying the elapsed time from the beginning of the current title (for DVD VIDEO) or the disc (for Audio CD/Video CD) using the Time Search.

1 Access the Play Set Up menu.

Press **REPEAT** during playback.

2 Select the mode.

Press $\triangleleft \triangleright$ to move the arrow to "TIME SEARCH", then press **OK**.

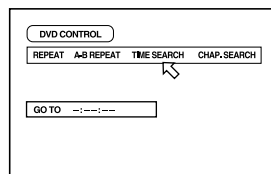

1 Access the Play Set Up menu.

Press **REPEAT** during playback.

2 Select the mode.

Press $\triangleleft \triangleright$ to move the arrow to "PBC CALL", then press **OK**.

Programme Playback



You can play back up to 99 tracks in the desired order.

1 Access the Play Set Up menu.

Press **REPEAT** in stop mode.

2 Select the mode.

Press \triangleleft \triangleright to move the arrow to "PROGRAM", then press **OK**.

- The programme table appears under the Play Set Up menu.

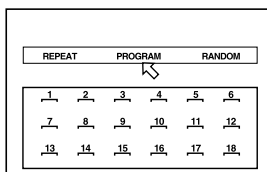

3 Select the tracks in the desired order.

Press the appropriate **number key** to select the tracks.

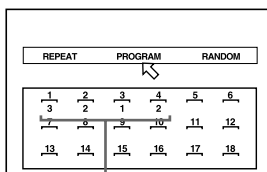

The programmed order number is shown under each program number.

Examples:

- To select track 5, press the **number key "5"**.
- To select track 15, press the **number key "+10"** and "5".
- To select track 25, press **number key "+10"** twice, then "5".

If you have specified a wrong selection

Press **■**. The last selection programmed is erased.

4 Start playback.

Press **▶**. Playback starts in the selected order.

- When all of the programmed tracks have been played back, Programme Playback stops, but the programmed information remains.
- To clear the Play Set Up menu, press **REPEAT**.
- To stop Programme Playback, press **■**.
- To add Program, perform steps **1** – **3**.
- To cancel programming, press **■** in stop mode.
- During Programme Playback, pressing **▶▶** skip to the next selection of the programme. Pressing **◀◀** returns to the beginning of the current selection.

NOTES:

- Programme Playback is not possible depending on the type of disc.
- By pressing **REPEAT** during Program Playback to display the program table on the TV screen, the program number currently being playback is displayed in yellow.

Random Playback



You can play back all the tracks on the disc in random order.

1 Access the Play Set Up menu.

Press **REPEAT** in stop mode.

2 Select the mode.

Press \triangleleft \triangleright to move the arrow to "RANDOM", then press **OK**.

Playback starts in random order.

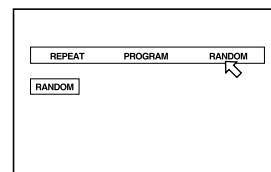

- To clear the Play Set Up menu, press **REPEAT**.
- To stop Random Playback, press **■**.
- To cancel Random Playback, press **■** twice.

NOTE:

The same track will not be played back more than once during Random Playback.

Parental Lock

This function restricts playback of DVD VIDEO discs which contain violent (and other) scenes according to the level set by the user. For example, if a movie which includes violent scenes supports the parental lock feature, such scenes which you do not want to let children view can be cut or replaced with other scenes.

- Turn on the TV and select the video channel (or AV mode).
- Slide the TV/S-VHS/DVD switch to the right.

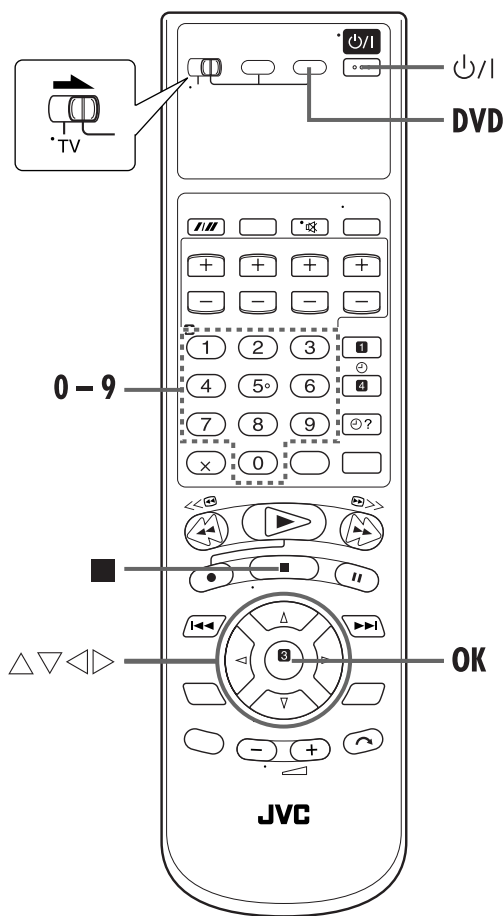

To set Parental Lock for the first time

1 Turn on the unit.

Press $\odot/1$.

2 Select the DVD deck.

On the unit

Press **S-VHS/DVD** repeatedly so that the DVD indicator lights up.

On the remote control

Press **DVD** so that the DVD indicator lights up.

3 Access the Parental Lock screen.

Press and hold \blacksquare , then press **OK**.

4 Select the country code.

Press $\triangleleft \triangleright$ to select the desired country code, then press **OK**.

- See "Country/Area Code List" (pg. 52).

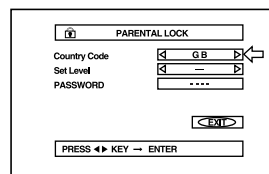

5 Select the set level.

Press $\triangleleft \triangleright$ to select the desired level, then press **OK**.

- "1" is the strictest level. "--" means no restriction. Discs rated higher than the selected level are restricted.
- You cannot play back the discs rated higher than the selected level.

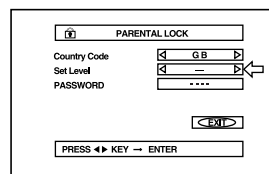

6 Enter the password.

Press the appropriate **number keys** to enter 4-digit password, then press **OK**.

- If you make a mistake, enter the correct password again.

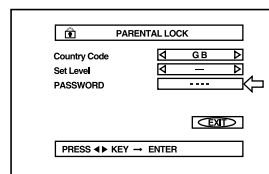

7 Return to the normal screen.

Press **OK**.

To change the settings

You can change the Parental lock settings later.

1 Access the Parental Lock screen.

Press and hold **■** in stop mode, then press **OK**.

2 Enter the password.

Press the appropriate **number keys** to enter 4-digit password, then press **OK**.

- The arrow moves to "Country Code" if you enter the correct password.
- If you enter the wrong password, "WRONG! RETRY..." appears on the TV screen. Enter the correct password.

3 Change the country code.

Press **< >** to select the country code, then press **OK**.

- See "Country/Area Code List" (pg. 52).
- When you change the country code, you must select the set level.

4 Change the set level.

Press **< >** to select the desired level, then press **OK**.

5 Enter your new password.

Press the appropriate **number keys** to enter 4-digit password, then press **OK**.

- The password entered in the this step becomes the new password. If you do not change the password, enter the same password as in the step **2**.
- Even if you want to change only the country code and/or set level, do not forget to enter the password after changing the country code and/or set level. Otherwise, the new country code and/or set level will not become effective.

6 Return to the normal screen.

Press **OK**.

NOTES:

- When you enter the wrong password more than 3 times in step **2** above, the arrow moves to "EXIT" automatically and **< >** does not work.
- If you forget your password, enter "8888" in step **2**.

To temporarily release the Parental Lock

When you set the parental level strictly, some discs may not be played back at all. When you insert such a disc and try to play back it, the following Parental Lock screen appears on the TV screen, asking you whether you want the Parental Lock to be temporarily released or not.

1 Access the password screen.

- 1 Place the disc in the disc tray.

- If the disc rated higher than the selected set level, the following screen appears.

- 2 Press **△ ∇** to move the arrow to "YES", then press **OK**.

- If you select "NO", you cannot play back that disc.

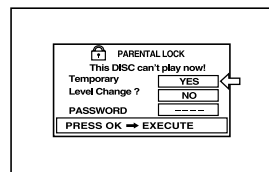

2 Enter the password.

Press the appropriate **number keys** to enter 4-digit password, then press **OK**.

- If you enter the wrong password, "WRONG! RETRY..." appears on the TV screen. Enter the correct password.
- If you enter the correct password, the Parental lock is released and the unit starts playback.

NOTES:

- When you enter the wrong password more than 3 times in step **2** above, the arrow moves to "NO" automatically and **△ ∇** do not work. In such a case, press **OK**, then press **▲** to remove the disc.
- If you forget your password, enter "8888" in step **2**.

Country/Area Code List

AD	Andorra
AE	United Arab Emirates
AF	Afghanistan
AG	Antigua and Barbuda
AI	Anguilla
AL	Albania
AM	Armenia
AN	Netherlands Antilles
AO	Angola
AQ	Antarctica
AR	Argentina
AS	American Samoa
AT	Austria
AU	Australia
AW	Aruba
AZ	Azerbaijan
BA	Bosnia and Herzegovina
BB	Barbados
BD	Bangladesh
BE	Belgium
BF	Burkina Faso
BG	Bulgaria
BH	Bahrain
BI	Burundi
BJ	Benin
BM	Bermuda
BN	Brunei Darussalam
BO	Bolivia
BR	Brazil
BS	Bahamas
BT	Bhutan
BV	Bouvet Island
BW	Botswana
BY	Belarus
BZ	Belize
CA	Canada
CC	Cocos (Keeling) Islands
CF	Central African Republic
CG	Congo
CH	Switzerland
CI	Côte d'Ivoire
CK	Cook Islands
CL	Chile
CM	Cameroon
CN	China
CO	Colombia
CR	Costa Rica
CU	Cuba
CV	Cape Verde
CX	Christmas Island
CY	Cyprus
CZ	Czech Republic
DE	Germany
DJ	Djibouti
DK	Denmark
DM	Dominica
DO	Dominican Republic
DZ	Algeria
EC	Ecuador
EE	Estonia
EG	Egypt
EH	Western Sahara
ER	Eritrea

ES	Spain
ET	Ethiopia
FI	Finland
FJ	Fiji
FK	Falkland Islands (Malvinas)
FM	Micronesia (Federated States of)
FO	Faroe Islands
FR	France
FX	France, Metropolitan
GA	Gabon
GB	United Kingdom
GD	Grenada
GE	Georgia
GF	French Guiana
GH	Ghana
GI	Gibraltar
GL	Greenland
GM	Gambia
GN	Guinea
GP	Guadeloupe
GQ	Equatorial Guinea
GR	Greece
GS	South Georgia and the South Sandwich Islands
GT	Guatemala
GU	Guam
GW	Guinea-Bissau
GY	Guyana
HK	Hong Kong
HM	Heard Island and McDonald Islands
HN	Honduras
HR	Croatia
HT	Haiti
HU	Hungary
ID	Indonesia
IE	Ireland
IL	Israel
IN	India
IO	British Indian Ocean Territory
IQ	Iraq
IR	Iran (Islamic Republic of)
IS	Iceland
IT	Italy
JM	Jamaica
JO	Jordan
JP	Japan
KE	Kenya
KG	Kyrgyzstan
KH	Cambodia
KI	Kiribati
KM	Comoros
KN	Saint Kitts and Nevis
KP	Korea, Democratic People's Republic of
KR	Korea, Republic of
KW	Kuwait
KY	Cayman Islands
KZ	Kazakhstan
LA	Lao People's Democratic Republic

LC	Saint Lucia
LI	Liechtenstein
LK	Sri Lanka
LR	Liberia
LS	Lesotho
LT	Lithuania
LU	Luxembourg
LV	Latvia
LY	Libyan Arab Jamahiriya
MA	Morocco
MC	Monaco
MD	Moldova, Republic of
MG	Madagascar
MH	Marshall Islands
ML	Mali
MM	Myanmar
MN	Mongolia
MO	Macau
MP	Northern Mariana Islands
MQ	Martinique
MR	Mauritania
MS	Montserrat
MT	Malta
MU	Mauritius
MV	Maldives
MW	Malawi
MX	Mexico
MY	Malaysia
MZ	Mozambique
NA	Namibia
NC	New Caledonia
NE	Niger
NF	Norfolk Island
NG	Nigeria
NI	Nicaragua
NL	Netherlands
NO	Norway
NP	Nepal
NR	Nauru
NU	Niue
NZ	New Zealand
OM	Oman
PA	Panama
PE	Peru
PF	French Polynesia
PG	Papua New Guinea
PH	Philippines
PK	Pakistan
PL	Poland
PM	Saint Pierre and Miquelon
PN	Pitcairn
PR	Puerto Rico
PT	Portugal
PW	Palau
PY	Paraguay
QA	Qatar
RE	Réunion
RO	Romania
RU	Russian Federation
RW	Rwanda

SB	Solomon Islands
SC	Seychelles
SD	Sudan
SE	Sweden
SG	Singapore
SH	Saint Helena
SI	Slovenia
SJ	Svalbard and Jan Mayen
SK	Slovakia
SL	Sierra Leone
SM	San Marino
SN	Senegal
SO	Somalia
SR	Suriname
ST	Sao Tome and Principe
SV	El Salvador
SY	Syrian Arab Republic
SZ	Swaziland
TC	Turks and Caicos Islands
TD	Chad
TF	French Southern Territories
TG	Togo
TH	Thailand
TJ	Tajikistan
TK	Tokelau
TM	Turkmenistan
TN	Tunisia
TO	Tonga
TP	East Timor
TR	Turkey
TT	Trinidad and Tobago
TV	Tuvalu
TW	Taiwan
TZ	Tanzania, United Republic of
UA	Ukraine
UG	Uganda
UM	United States Minor Outlying Islands
US	United States
UY	Uruguay
UZ	Uzbekistan
VA	Vatican City State (Holy See)
VC	Saint Vincent and the Grenadines
VE	Venezuela
VG	Virgin Islands (British)
VI	Virgin Islands (U.S.)
VN	Vietnam
VU	Vanuatu
WF	Wallis and Futuna Islands
WS	Samoa
YE	Yemen
YT	Mayotte
YU	Yugoslavia
ZA	South Africa
ZM	Zambia
ZR	Zaire
ZW	Zimbabwe

About MP3 Disc



This unit can playback CD discs recorded by the MP3 format (we refer to those discs as MP3 discs in this manual).

Operations for MP3 discs are similar to those for Audio CD discs, though there are some restrictions and differences.

What is MP3?

MP3 is the abbreviation of "MPEG1 Audio Layer 3." MPEG Audio is a compression specification that compresses the audio portion only. This image compression method is used in DVD or Video CD, etc. The audio data has been compressed into about 1/10.

On an MP3 disc, each material (song) is recorded on each Track (file), which usually belongs to a Group (folder).

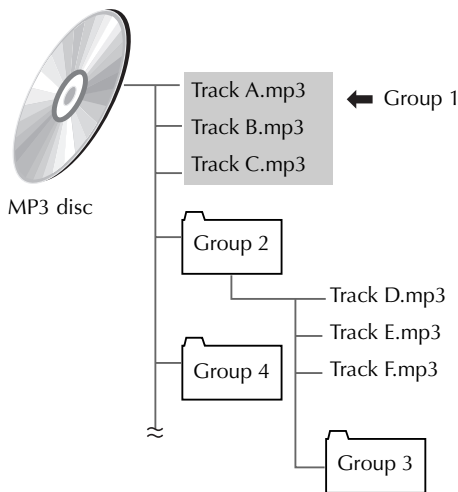

This unit can recognize up to 99 Groups and up to 254 Tracks per Group, however, the number of Tracks to be played back on a disc is limited to 1023.

If a disc includes more than 1023 Tracks, the unit stops detecting Tracks when the number of detected Tracks reaches 1023 and ignores the subsequent Tracks. The unit also ignores any non-MP3 file in the disc.

NOTES for making a private MP3 disc using a CD-R/CD-RW disc:

- Select "ISO9660" as the disc format.
- Do not select the "multi-session" recording.
- Finalize the disc.

NOTES:

- Because of the disc characteristics or recording condition, some discs may not be played back or it takes time to start playback.
- The unit does not support "packet writing" discs.
- If there are any Tracks (files) which are stored on a disc directly and do not belong to any Group (directory), the unit recognized them as belonging to an independent Group.
- The unit does not output a digital audio signal from DIGITAL AUDIO OUT connector when playing back an MP3 disc.
- The unit plays back Groups/Tracks on an MP3 disc in the alphabetical order.
- For example, if there are three title Groups [one], [two] and [three] on a disc, the playback order is [one], [three] then [two]. Tracks in a Group are played back in the same way.
- Therefore, an MP3 disc on the market may be played back in the different order from the order printed on its sleeve.

Disc Time Information

Press **DISPLAY** during playback repeatedly until the disc time information appears on the TV screen.

- To return to the normal screen, press **DISPLAY**.

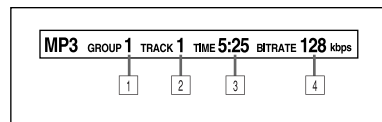

- 1 Current group number
- 2 Current track number
- 3 Elapsed time
- 4 Transmission rate

To change information on the front display panel

The disc time information also appears on the front display panel.

Each time you press **-->**, the display changes as follows:

Current group/Current track ↔ Elapsed time

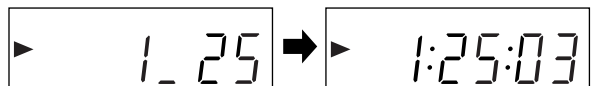

Basic Playback

- Turn on the TV and select the video channel (or AV mode).
- Slide the **TV/S-VHS/DVD** switch to the right.

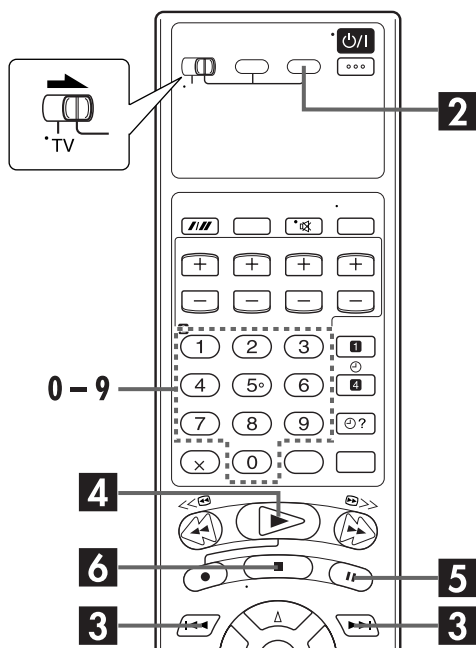

1 Load the disc.

- 1 Press **▲** on the DVD deck to open the disc tray.
- The unit's power comes on automatically.
- 2 Place the disc in the disc tray.
- For details, refer to "Placing a Disc" (pg. 7).
- 3 Press **▲** on the DVD deck to close the disc tray.
- Pressing **▶** also close the disc tray.

2 Select the DVD deck.

On the unit

Press **S-VHS/DVD** repeatedly so that the DVD indicator lights up.

On the remote control

Press **DVD** so that the DVD indicator lights up.

3 Select the track.

Press **◀◀** to locate the beginning of the previous track, and press **▶▶** to locate the beginning of the next track.

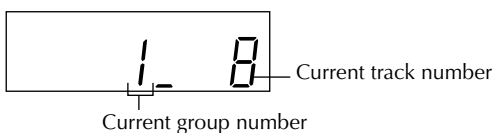

- You can skip a track across a group. Press **▶▶** to skip to the first track of the next group when the last track of the current group is selected.

4 Start playback.

Press **▶**.

5 Pause playback.

Press **⏸**.

- To resume normal playback, press **▶**.

6 Stop playback.

Press **■**. Press **▲** on the DVD deck to open the disc tray, then remove the disc.

NOTE:

▶, **■**, **⏸**, **◀◀** and **▶▶** buttons function the same as with Audio CD discs, however, **◀◀** or **▶▶** does not function for MP3 playback.

Track/group selection

Track selection

Perform steps below during playback.

Group selection

Perform steps below in stop mode.

To select a 1- or 2-digit track/group

Press the appropriate **number keys** to select the track/group number.

Examples:

- To select track 5, press the **number key "5"**.
- To select track 15, press the **number key "+10"** and **"5"**.
- To select track 25, press **number key "+10"** twice, then **"5"**.

To select a 3-digit track

- 1 Press and hold the **number key "+10"** for more than 2 seconds during playback.
- "**_ _**" appears on the front display panel.



- 2 Press the appropriate **number keys** to select the desired track number directly.

Examples:

To select track 254: press and hold the **number key "+10"** for more than 2 seconds, then press **number key "2"**, **"5"** and **"4"**.

Playback Features with Play Set Up menu

- Turn on the TV and select the video channel (or AV mode).
- Slide the **TV/S-VHS/DVD** switch to the right.

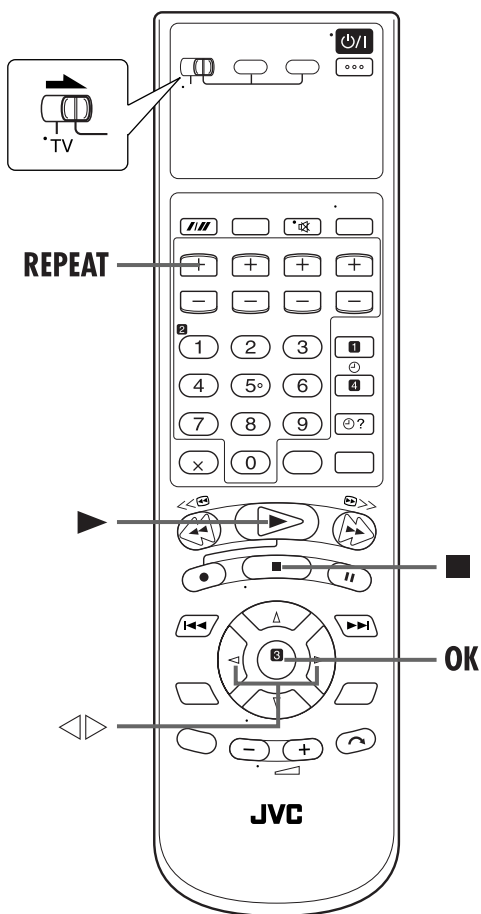

Programme Playback

You can play back groups on an MP3 disc in the desired order.

1 Access the Play Set Up menu.

Press **REPEAT** in stop mode.

2 Select the mode.

Press \triangleleft \triangleright to move the arrow to "PROGRAM", then press **OK**.

- The programme table appears under the Play Set Up menu.

REPEAT			PROGRAM			RANDOM		
1	2	3	4	5	6			
7	8	9	10	11	12			
13	14	15	16	17	18			

3 Select the groups in the desired order.

Press the appropriate **number keys** to select the group.

- Refer to "Track/group selection" on page 55.
- Up to 18 groups can be programmed.
- You may select the same group more than once.

REPEAT			PROGRAM			RANDOM		
1	2	3	4	5	6			
7	8	9	10	11	12			
13	14	15	16	17	18			

The programmed order number is shown under each program number.

If you have specified a wrong selection

Press **■**. The last selection programmed is erased.

4 Start playback.

Press **▶**. Playback starts in the selected order.

- When all of the programmed tracks have been played back, Programme Playback stops, but the programmed information remains.
- To clear the Play Set Up menu, press **REPEAT**.
- To stop Programme Playback, press **■**.
- To cancel programming, press **■** in stop mode.
- You can also quit Programme Playback in the following cases:
 - Press **▲** to open the disc tray.
 - Turn on the unit.

NOTES:

- You cannot play back tracks in a group in the desired order.
- By pressing **REPEAT** during Program Playback to display the program table on the TV screen, the program number currently being playback is displayed in yellow.

Random Playback

You can playback groups on an MP3 disc in random order.

1 Access the Play Set Up menu.

Press **REPEAT** in stop mode.

2 Select the mode.

Press \triangleleft \triangleright to move the arrow to "RANDOM", then press **OK**.

Playback starts in random order.

- The playback order of tracks in a group does not change during Random Playback.
- To stop Random Playback, press **■**.
- To cancel Random Playback, press **REPEAT** repeatedly so that "RANDOM" disappears from the TV screen.
- You can also quit Random Playback in the following cases:
 - Press \blacktriangle to open the disc tray.
 - Turn on the unit.

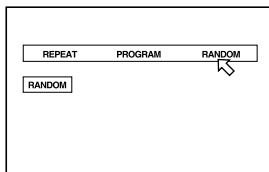

Repeat Playback

You can repeat playback of the current group or all groups.

1 Access the Play Set Up menu.

Press **REPEAT** during playback.

2 Select the mode.

- 1 Press \triangleleft \triangleright to move the arrow to "REPEAT", then press **OK**.
- 2 Press **OK** repeatedly to select the appropriate mode.

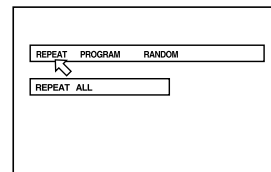

- Each time you press **OK**, the mode changes as follows: REPEAT ALL → REPEAT 1 → No indication → (Back to the beginning)

REPEAT ALL:	All tracks are played back repeatedly.
REPEAT 1:	The current track is played back repeatedly.
No indication (off):	Each track is played back once.

- To stop Repeat Playback, press **■**.
- To cancel Repeat Playback, press **REPEAT** repeatedly until "REPEAT ALL" or "REPEAT 1" disappear from the TV screen.
- You can also quit Repeat Playback in the following cases:
 - Press \blacktriangle to open the disc tray.
 - Turn on the unit.

Edit From A Camcorder

1 If the camcorder has no S-VIDEO output connector:

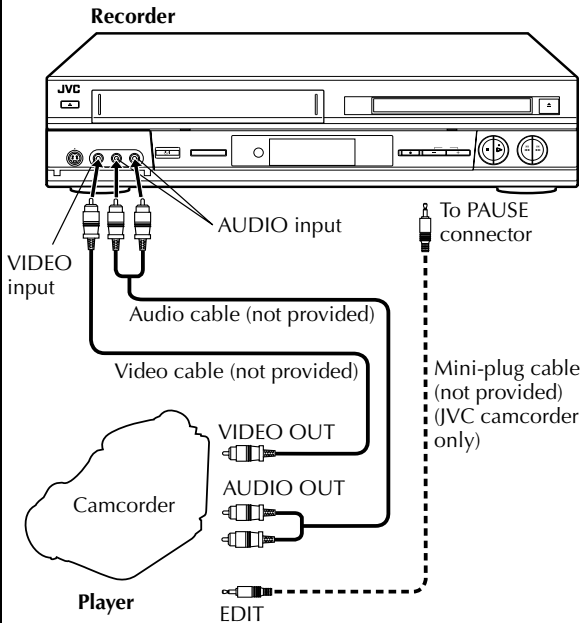

2 If the camcorder has an S-VIDEO output connector:

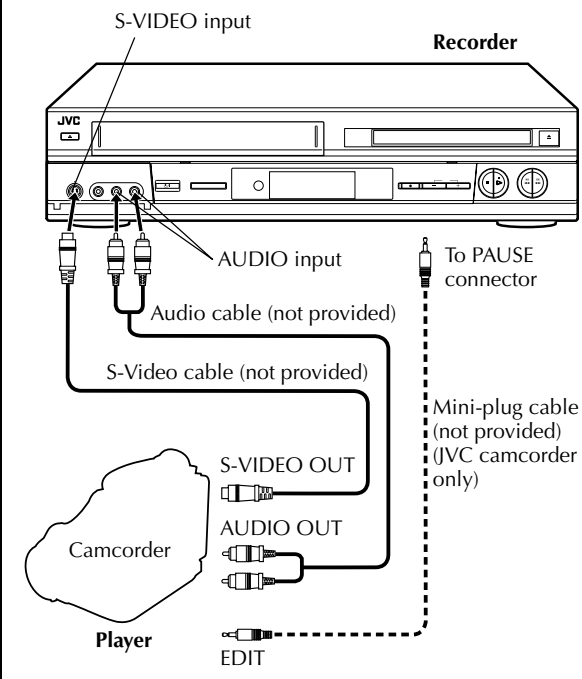

You can use a camcorder as the source player and your unit as the recording deck.

Slide the **TV/S-VHS/DVD** switch to the right.

1 Make connections.

- 1 If the camcorder has no S-VIDEO output connector:
 - connect the camcorder's AUDIO OUT and VIDEO OUT connectors to the unit's front panel AUDIO and VIDEO input connectors.
 - 2 If the camcorder has an S-VIDEO output connector:
 - connect the camcorder's AUDIO OUT and S-VIDEO OUT connectors to the unit's front panel AUDIO and S-VIDEO input connectors.
- When using a monaural camcorder, connect its AUDIO OUT connector to the AUDIO L input connector on your unit.
 - When a Master Edit Control-equipped JVC camcorder is used, the camcorder is capable of controlling the unit. Refer to the camcorder's instruction manual for operating procedure.

2 Select the S-VHS deck.

On the unit

Press **S-VHS/DVD** repeatedly so that the S-VHS indicator lights up.

On the remote control

Press **S-VHS** so that the S-VHS indicator lights up.

3 Set the unit's input mode.

Press **AUX** (number key "0") and/or **PR** to select "F-1" for the AUDIO and VIDEO input connectors, or "S-1" for the AUDIO and S-VIDEO input connectors, depending on the connectors being used.

4 Set the edit mode.

See "PICTURE CONTROL" on page 71.

5 Start the camcorder.

Engage the Play mode of the camcorder.

6 Start the unit.

Engage the Record mode of the unit.

NOTES:

- All necessary cables can be obtained from your dealer.
- When you select "EDIT" to dub tapes in step 4, be sure to select "AUTO" (or "NORM" when "B.E.S.T." is set to "OFF") after you finish dubbing the tapes.

Edit To Or From Another Video Recorder

You can use your unit as the source player or as the recording deck.

Slide the **TV/S-VHS/DVD** switch to the right.

1 Make connections.

Connect the player's 21-pin SCART connector to the unit's 21-pin SCART connector as illustrated.

- 1 When using your unit as the source player:
 - connect its L-1 IN/OUT connector to the recording deck.
 - 2 When using your unit as the recording deck:
 - connect its L-1 IN/OUT or L-2 IN/DECODER connector to the source player.
- If another recorder is compatible with the Y/C signal:
 - when using your unit as the source player, set "L-1 OUTPUT" to "S-VIDEO". (☞ pg. 60)
 - when using your unit as the recording deck, set "L-2 INPUT" to "S-VIDEO". (☞ pg. 61)

2 Select the S-VHS deck.

On the unit

Press **S-VHS/DVD** repeatedly so that the S-VHS indicator lights up.

On the remote control

Press **S-VHS** so that the S-VHS indicator lights up.

3 Set the input mode of recording deck.

With this unit, press **AUX** (number key "0") and/or **PR** to select "L-1" for the L-1 IN/OUT connector, or "L-2" for the L-2 IN/DECODER connector, depending on the connector being used.

- When using another recorder as the recording deck, refer to its instruction manual.
- When using the L-2 IN/DECODER connector, set "L-2 SELECT" to "AV". (☞ pg. 61)

4 Set the edit mode.

See "PICTURE CONTROL" on page 71.

5 Start the source player.

Engage the Play mode of the source player.

6 Start the recording deck.

Engage the Record mode of the recording deck.

NOTES:

- All necessary cables can be obtained from your dealer.
- For Y/C signal input/output, be sure to use a 21-pin SCART cable that is compatible with the Y/C signal.
- When you select "EDIT" to dub tapes in step 4, be sure to select "AUTO" (or "NORM" when "B.E.S.T." is set to "OFF") after you finish dubbing the tapes.
- When you use this unit as the source player for editing, be sure to set "O.S.D." to "OFF" before starting. (☞ pg. 72)
- If you are using another recorder with S-Video and Audio output connectors, connect its S-Video and Audio output connectors to this unit's front panel S-VIDEO and AUDIO input connectors. Then, set the unit's input mode to "S-1" in step 4.

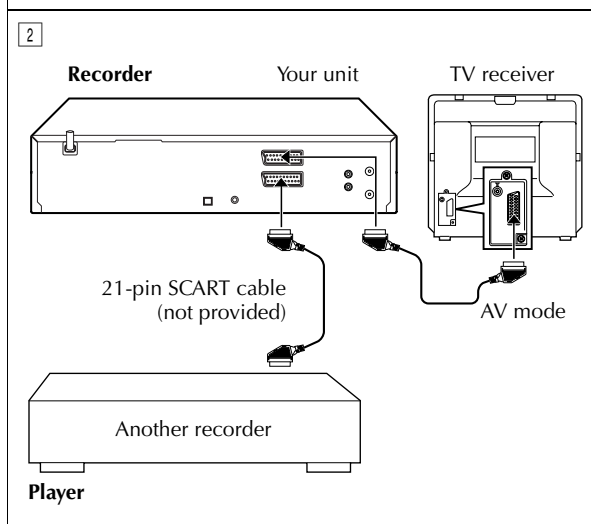
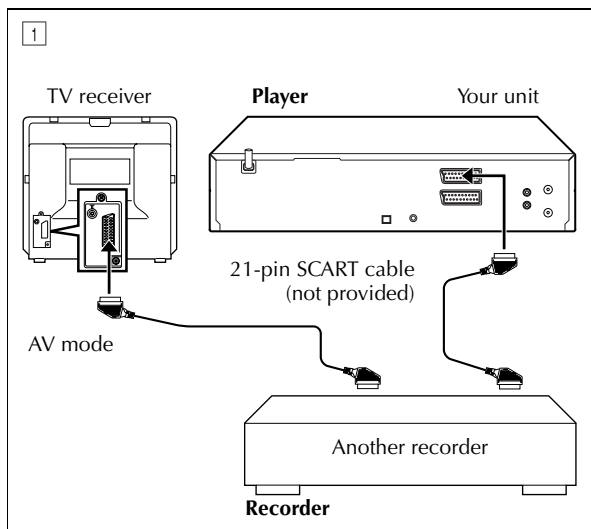

Advantages of S-VHS video recorders

You can edit from VHS to S-VHS, S-VHS to VHS, or, from S-VHS to S-VHS.

- From VHS to S-VHS: Record VHS playback signals in the S-VHS mode. Although the picture quality is inherently limited by that of the original, the edited tape has better picture quality than those made by VHS-to-VHS editing.
- From S-VHS to VHS: Because the picture quality of the source material is very high, the edited tape has better picture quality than those made by VHS-to-VHS editing.
- From S-VHS to S-VHS: All signals will be transferred with minimum degradation.

Output/Input Set

- Turn on the TV and select the video channel (or AV mode).
- Slide the TV/S-VHS/DVD switch to the right.

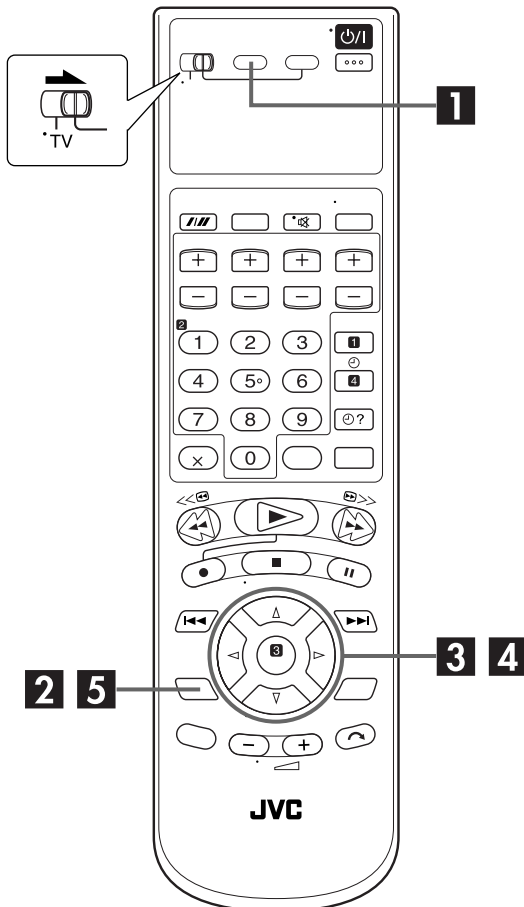

L-1 Output Setting (L-1 OUTPUT)

Set "L-1 OUTPUT" to the appropriate mode depending on the type of appliance connected to the unit's L-1 IN/OUT connector.

1 Select the S-VHS deck.

On the unit

Press **S-VHS/DVD** repeatedly so that the S-VHS indicator lights up.

On the remote control

Press **S-VHS** so that the S-VHS indicator lights up.

2 Access the Main Menu screen.

Press **SET UP MENU**.

3 Access the Output/Input Set screen.

Press Δ / ∇ to move the highlight bar (pointer) to "OUTPUT/INPUT SET", then press **OK** or \triangleright .

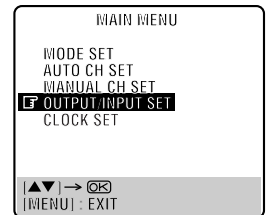

4 Select the output mode for the L-1 IN/OUT connector.

Press Δ / ∇ to move the highlight bar (pointer) to "L-1 OUTPUT". Then, press **OK** or \triangleright to select the appropriate setting.

* The default setting is **bold** in the table below.

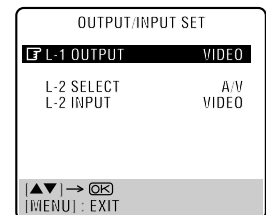

■ L-1 OUTPUT

VIDEO: If a connected appliance's input is compatible only with regular video signals, set to "VIDEO".

S-VIDEO: If a connected appliance's input is compatible with Y/C signals, set to "S-VIDEO". You can obtain high-quality S-VHS picture. (For connection, be sure to use a 21-pin SCART cable that is compatible with the Y/C signal.)

5 Return to the normal screen.

Press **SET UP MENU**.

NOTE:

It is not possible to set the input mode for the L-1 IN/OUT connector. The input for this connector is only compatible with the composite signal.

L-2 Select and L-2 Input Setting (L-2 SELECT and L-2 INPUT)

Set "L-2 SELECT" to the appropriate mode depending on the type of appliance connected to the unit's L-2 IN/DECODER connector. Set "L-2 INPUT" to the appropriate mode depending on the output signals of the connected appliance.

Perform steps **1** and **2** of "L-1 Output Setting (L-1 OUTPUT)" on page 60.

1 Select the input mode for the L-2 IN/DECODER connector.

Press Δ / ∇ to move the highlight bar (pointer) to "L-2 SELECT" or "L-2 INPUT". Then, press **OK** or \triangleright to select the appropriate setting.

* The default setting is **bold** in the table below.

OUTPUT/INPUT SET	
L-1 OUTPUT	VIDEO
L-2 SELECT	A/V
L-2 INPUT	VIDEO

\blacktriangle \blacktriangledown \rightarrow **OK**
MENU : EXIT

■ L-2 SELECT

A/V: To use this unit as the recording deck with the player connected to the L-2 IN/DECODER connector, or to use the satellite receiver connected to the L-2 IN/DECODER connector.

DECODER: To use a decoder connected to the L-2 IN/DECODER connector.

SAT: To view a satellite programme with the TV set while the unit is turned off. (pg. 66)

■ L-2 INPUT

VIDEO: If a connected appliance's output is compatible only with regular video signals, set to "VIDEO".

S-VIDEO: If a connected appliance's output is compatible with Y/C signals, set to "S-VIDEO". You can obtain high-quality S-VHS picture. (For connection, be sure to use a 21-pin SCART cable that is compatible with the Y/C signal.)

NOTES:

- If you have a satellite receiver or a decoder connected to the L-2 IN/DECODER connector, be sure to set "L-2 SELECT" back to appropriate mode after editing.
- If you are not connecting a satellite receiver or a decoder to the L-2 IN/DECODER connector, leave "L-2 SELECT" set to "A/V".
- The default setting is "A/V"; if the unit's memory backup has expired due to a power cut or because the AC was removed from the unit, "A/V" will be automatically selected when the power is restored to the unit. If you are using a satellite receiver or a decoder, be sure to set "L-2 SELECT" back to appropriate mode.
- When "L-2 SELECT" is set to "SAT", "SAT" or "SAT" appears on TV screen or front display panel instead of "L-2".
- If "L-2 SELECT" is set to "DECODER", it is impossible to set "L-2 INPUT" to "S-VIDEO".
- If "L-1 OUTPUT" is set to "S-VIDEO", it is impossible to set "L-2 SELECT" to "DECODER".

2 Return to the normal screen.

Press **SET UP MENU**.

Dubbing

(from DVD to S-VHS)

- Turn on the TV and select the video channel (or AV mode).
- Slide the TV/S-VHS/DVD switch to the right.

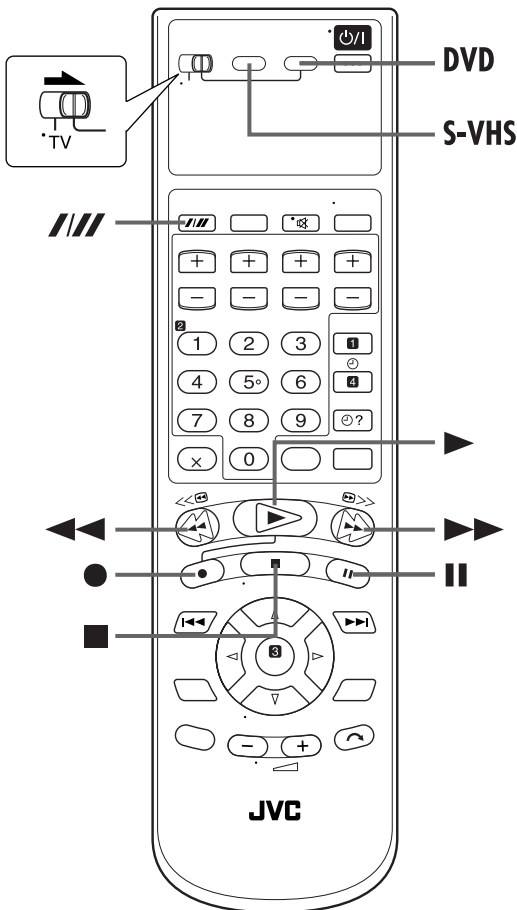

You can dub selected scenes from the DVD disc to a cassette, starting and stopping wherever you wish. However, it is not possible to dub the copy-protected disc.

1 Load a cassette and place a disc.

For the S-VHS deck

Insert a cassette with the record safety tab intact.

For the DVD deck

- 1 Press **▲** on the DVD deck to open the disc tray.
- 2 Place the disc in the disc tray.
- 3 Press **▲** on the DVD deck to close the disc tray.

2 Prepare the S-VHS deck for dubbing.

- 1 Press **S-VHS**.
- 2 Press **///** to select recording speed.
- 3 Search for the point where you want to start dubbing by pressing **▶**, **▶▶** or **◀◀** then press **■**.

3 Prepare the DVD deck for dubbing.

- 1 Press **DVD**.
- 2 Search for the point where you want to start dubbing by pressing **▶**, **▶▶** or **◀◀**.
- 3 Press **⏸** to pause playback a little before the start point.
- 4 Press and hold **●**, then press **⏸**.
 - "dub" blinks on the front display panel.

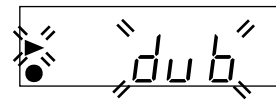

4 Start dubbing.

Press **▶** to start playback.

5 End dubbing.

Press **■**.

NOTES:

- Set "ON SCREEN GUIDE" to "OFF" (pg. 77) if you do not want to record the on-screen display for DVD discs during dubbing.
- There may be a discrepancy of several seconds between where you intend editing to start, and where it actually starts.
- The superimposed indication during the operation or dubbing is not recorded.

Digital Audio Dubbing

- Turn on the TV and select the video channel (or AV mode).
- Slide the TV/S-VHS/DVD switch to the right.

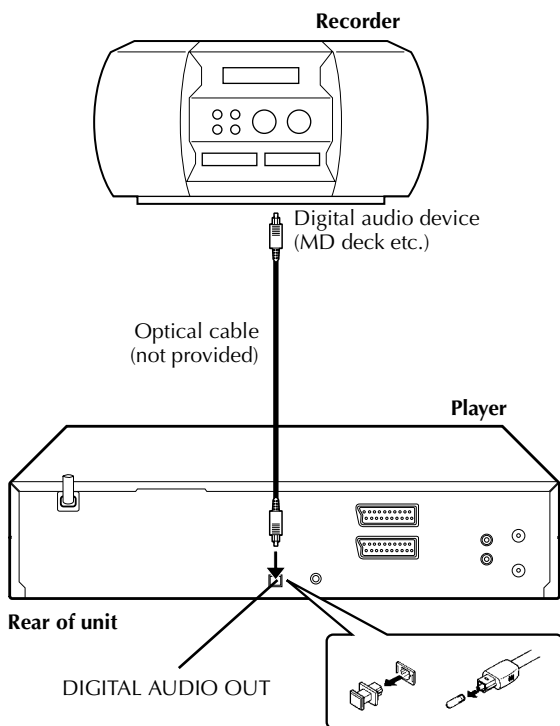

Note for connection:
Remove the connector cover from the unit and remove the protection cap from the cable.

You can dub selected audio from the DVD or Audio CD disc to a MD etc.

However, it is not possible to dub the copy-protected disc.

Example: Dubbing to a MD

1 Make connections.

Connect the optical cable between the unit and the digital audio device.

2 Place a disc and load a MD.

For the DVD deck

- 1 Press **▲** on the DVD deck to open the disc tray.
- 2 Place the disc in the disc tray.
- 3 Press **▲** on the DVD deck to close the disc tray.

For the digital audio device

Insert a MD.

3 Prepare the DVD deck for dubbing.

- 1 Press **DVD** and select the audio to be dubbed.
- 2 Search for the point where you want to start dubbing by pressing **▶**, **▶▶** or **◀◀** then press **■**.
- 3 Press **◀◀** a little, then press **▶** to start playback.
- 4 Press **||** to pause playback a little before the start point.

4 Prepare the audio device for dubbing.

Select the input mode.

5 Start dubbing.

- 1 Press **▶** to start playback on the DVD deck.
- 2 Start recording on the audio device.

6 End dubbing.

Press **■** on the audio device. Then press **■** to stop playback on the DVD deck.

NOTE:

There may be a discrepancy of several seconds between where you intend editing to start, and where it actually starts.

Remote Control Functions

Remote A/B/C/D Code Switching

The remote control is capable of controlling four JVC video units independently. Each of units can respond to one of four codes (A, B, C or D). The remote control is preset to send A code signals because your unit is initially set to respond to A code signals. You can easily modify your unit to respond to B, C or D code signals.

Before performing the following steps:
Slide the TV/S-VHS/DVD switch to the right.

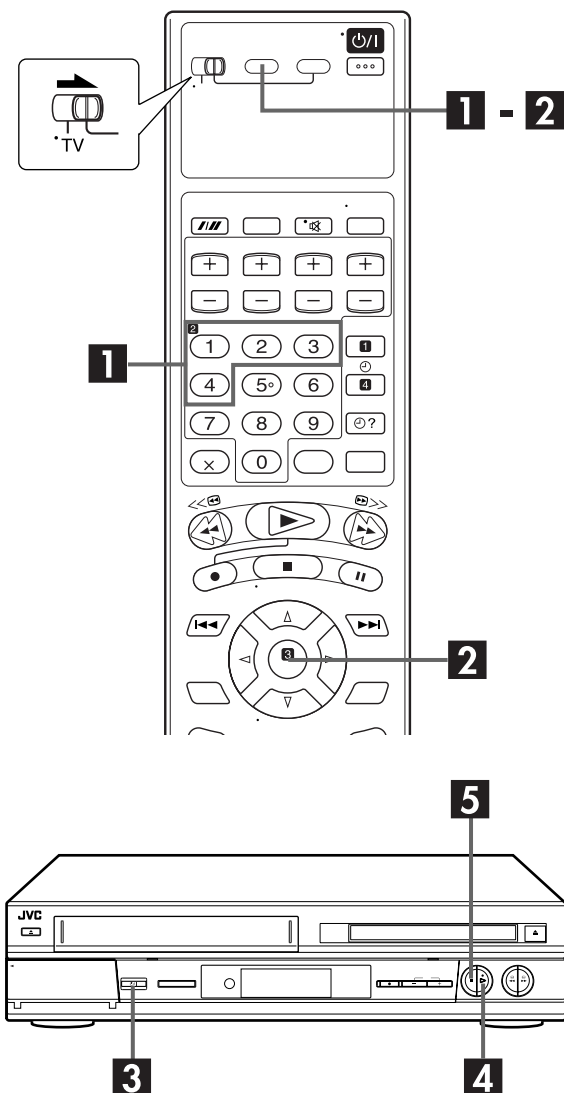

On the remote control

Keep pressing S-VHS down during steps **1** - **2**.

1 Change the remote control code.

Press the **number key "1"** for A, **"2"** for B, **"3"** for C or **"4"** for D.

2 Set the remote control code.

Press **OK** to set the code.

On the unit

3 Turn off the unit.

Press **⏻/I**.

4 Display the code.

Press **▶** on the unit for over 5 seconds while the unit is turned off. The code currently set appears on the front display panel.

- If the code displayed on the front display panel is different from the code set on the remote control, go to step **5**.

5 Change the unit's code.

Press **■** on the remote control. The code currently set on the remote control will be applied to the unit.

NOTE:

When "POWER SAVE" is set to "ON" (ⓘ pg. 73), it is impossible to change the remote code.

TV Multi-Brand Remote Control

Your remote control can operate the basic functions of your TV set. In addition to JVC TVs, other manufacturer's TVs can also be controlled.

Before performing the following steps:

- Turn off the TV using its remote control.
- Slide the TV/S-VHS/DVD switch to the right.

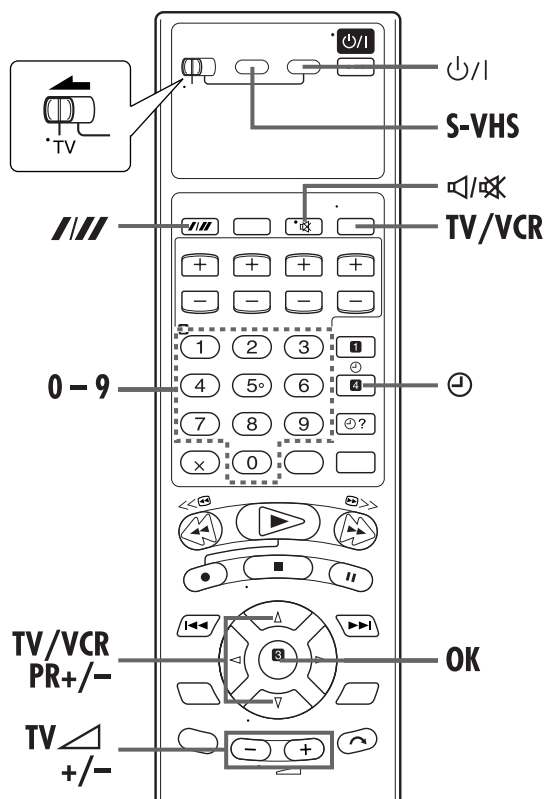

IMPORTANT

Although the provided remote control unit is compatible with JVC televisions, as well as many other models, it may not work with your TV, or in some instances, may have limited function capability.

Control Your TV Using Additional Buttons

Use the **number keys**, and the **///** button, **X** button or **⊖** button to select the TV's channel.

- With televisions under Code 01, 02, 07, 10, 11, 14, 20, 23, 24, 25, 27, 33 or 35, the **///** button corresponds to the 1-digit/2-digit entry switching button (often labelled - / -) of your TV's remote control.
- With televisions under Code 01, 28, 29 or 34, the **X** button corresponds to the 10 + button, and the **⊖** button corresponds to the 20 + button of your TV's remote control.

NOTE:

The way these buttons are used is determined by your TV. Use these buttons as instructed for your TV's remote control.

1 Set the TV brand code.

Keep pressing **S-VHS** down during step **1**.

Enter your TV's brand code using the **number keys**, then press **OK**.

Press **⏻** on the unit's remote control to turn on the TV and try operations (see step **2**).

- Once you have set the remote control to operate the TV, you do not have to repeat this step until you replace your remote control's batteries.
- Some brands of TV have more than one code. If the TV does not function with one code, try entering another.

2 Operate the TV.

Press the corresponding button: **⏻**, **TV/VCR**, **TV/VCR PR +/-**, **TV ▲+/-** (Volume), **⏻** (TV Muting), **number keys**.

- For some brands of TV, you must press **OK** after having pressed the **number keys**.

BRAND NAME	CODE
JVC	01, 23, 24, 25
BLAUPUNKT	19
BRANDT	26
FERGUSON	27
FINLUX	30
FUNAI	32
LG/GOLDSTAR	18
GRAETZ	28
GRUNDIG	19
HITACHI	10
ITT	28
LUXOR	28
MITSUBISHI	03
MIVAR	29
NEC	20
NOKIA	31
NORDMENDE	26
PANASONIC	11
PHILIPS	02
SABA	26
SALORA	28
SAMSUNG	02, 12, 33, 34, 35
SELECO	28
SHARP	06
SONY	07
TELEAVIA	26
TELEFUNKEN	26
THOMSON	26
TOSHIBA	14

Connecting To A Satellite Receiver

Simple Connections

This is an example of simple connection if your TV has one 21-pin AV input (SCART) connector. Connect the satellite receiver to the L-2 IN/DECODER connector, then connect the L-1 IN/OUT connector to the TV's connector.

NOTES:

- Set "L-2 SELECT" to "A/V". (☞ pg. 61)
- You can use Automatic Satellite Programme Recording function (☞ pg. 35) with this connection. (S-VHS deck only)
- To record a programme via the satellite receiver, select L-2 mode by pressing **AUX (number key "0")** and/or **PR** so that "L-2" appears on the front display panel. (S-VHS deck only)
- For details, refer to the instruction manual of the satellite receiver.

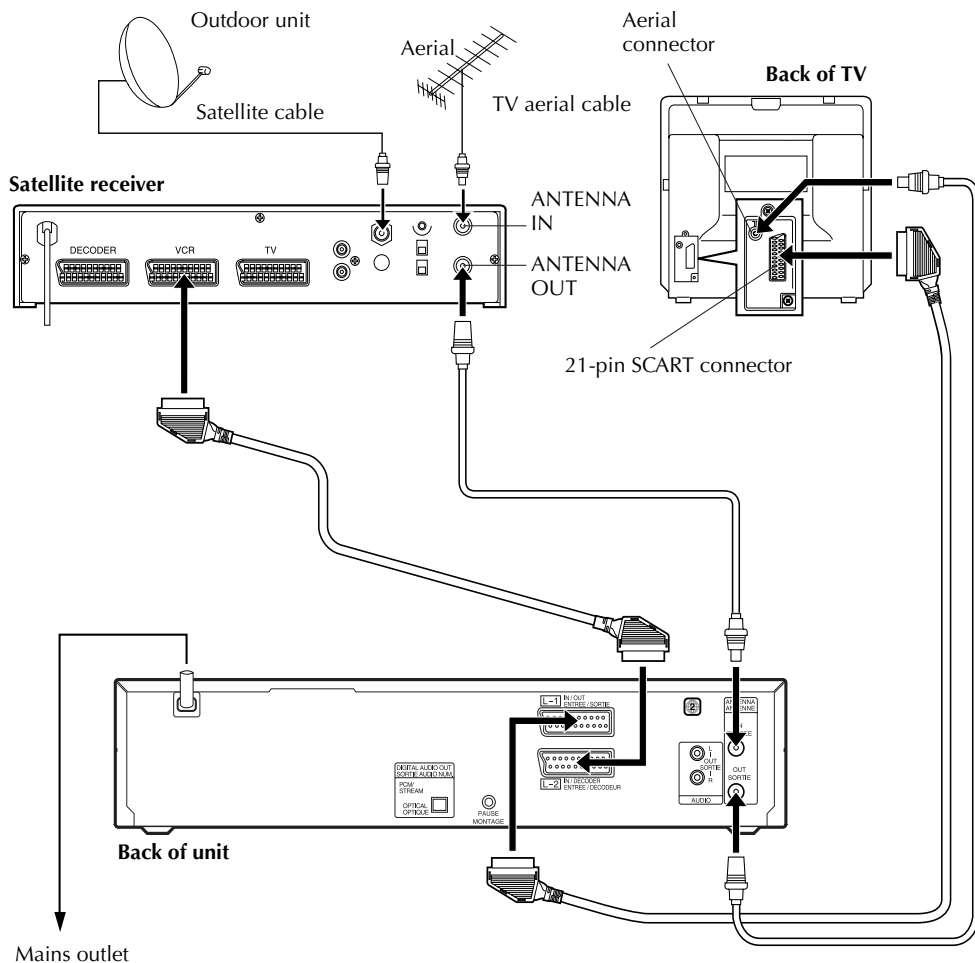

IMPORTANT

When you set "L-2 SELECT" to "SAT" (☞ pg. 61), it is possible to view a satellite broadcast with the TV set to its AV mode even if the unit is turned off. When the unit is in Stop mode or recording, press **TV/VCR** on the remote control to turn off the VCR indicator on the front display panel.

- If you turn on the unit when the satellite receiver's power is off, nothing appears on the TV screen. In this case, turn on the satellite receiver, or set the TV to its TV mode, or press **TV/VCR** on the remote control to set the unit to the video mode.

Perfect Connections

This is an example of recommended connection if your TV has two 21-pin AV input (SCART) connectors.

Connect the decoder to the satellite receiver's connector if you have a decoder, L-1 IN/OUT connector to TV's connector, and L-2 IN/DECODER connector to the satellite receiver's connector. Then connect the satellite receiver and TV.

NOTES:

- Set "L-2 SELECT" to "AV". (☞ pg. 61)
- You can use Automatic Satellite Programme Recording function (☞ pg. 35) with this connection. (S-VHS deck only)
- To record a programme via the satellite receiver, select L-2 mode by pressing **AUX (number key "0")** and/or **PR** so that "L-2" appears on the front display panel. (S-VHS deck only)
- To receive a scrambled broadcast, descramble the signal with the decoder connected to the satellite receiver.
- For details, refer to the instruction manual of the satellite receiver and decoder.

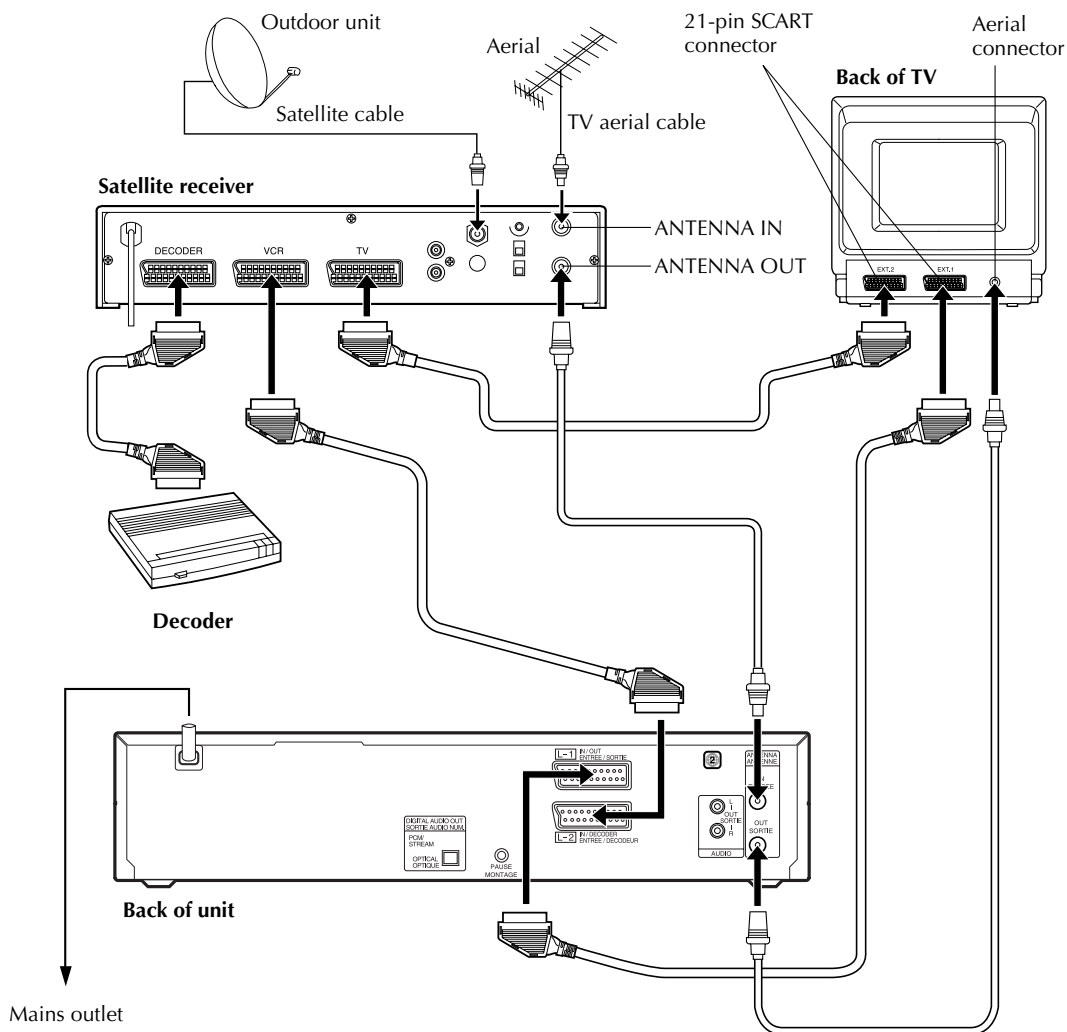

Connecting/Using A Decoder

The L-2 IN/DECODER connector can be used as an input connector for an external decoder (descrambler). Simply connect a decoder and you can enjoy the variety of programming that is available through scrambled channels.

1 Select the input mode.

Set "L-2 SELECT" to "DECODER". (☞ pg. 61)

2 Connect the decoder.

Connect your unit's L-2 IN/DECODER connector to the decoder's 21-pin SCART connector using a 21-pin SCART cable.

3 Set the tuner.

Perform the procedure as described in "When Receiving A Scrambled Broadcast" on page 81.

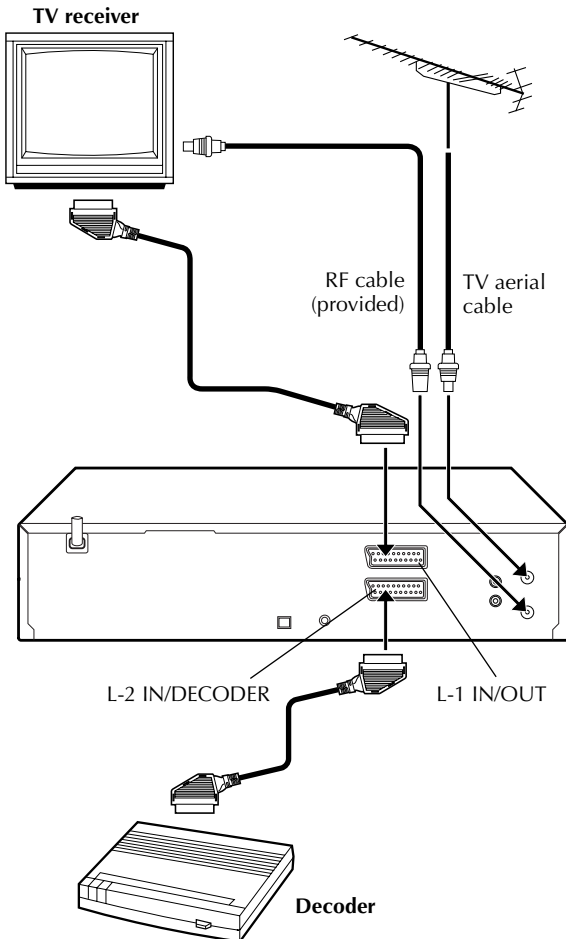

Connecting To A Dolby Digital Decoder or An Amplifier With A Built-in DTS

(DVD deck only)

These instructions enable you to connect your unit to dolby digital decoder or amplifier with a built-in DTS.

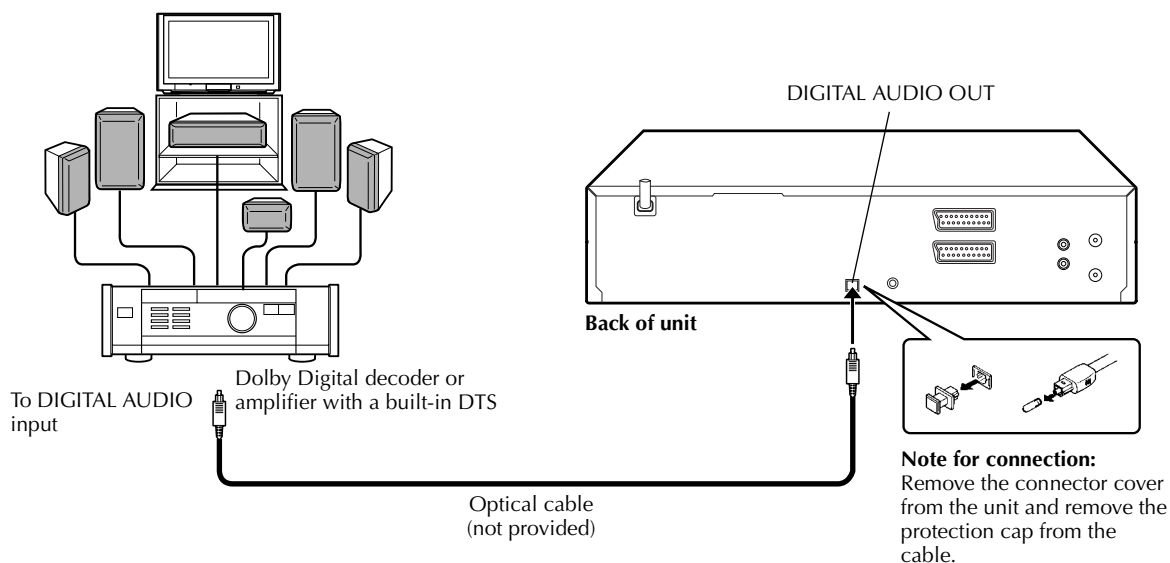

Make connections.

Connect the optical cable between the unit and the Dolby Digital decoder or amplifier with a built-in DTS.

NOTES:

- For Dolby digital sound, set "DIGITAL AUDIO OUTPUT" to "DOLBY DIGITAL/PCM". (☞ pg. 76)
- For DTS sound, set "DIGITAL AUDIO OUTPUT" to "STREAM/PCM". (☞ pg. 76)

CAUTIONS:

- This unit has a dynamic range of more than 80 dB with regards to its Hi-Fi audio capability. It is recommended that you check the maximum level if you are going to listen to the Hi-Fi audio signals through a stereo amplifier. A sudden surge in the input level to the speakers may damage them.
- Some speakers and televisions are specially shielded to prevent television interference. If both are of the non-shielded type, do not place the speakers adjacent to the TV set as this can adversely affect the video playback picture.

Mode Set

(S-VHS deck)

- Turn on the TV and select the video channel (or AV mode).
- Slide the TV/S-VHS/DVD switch to the right.

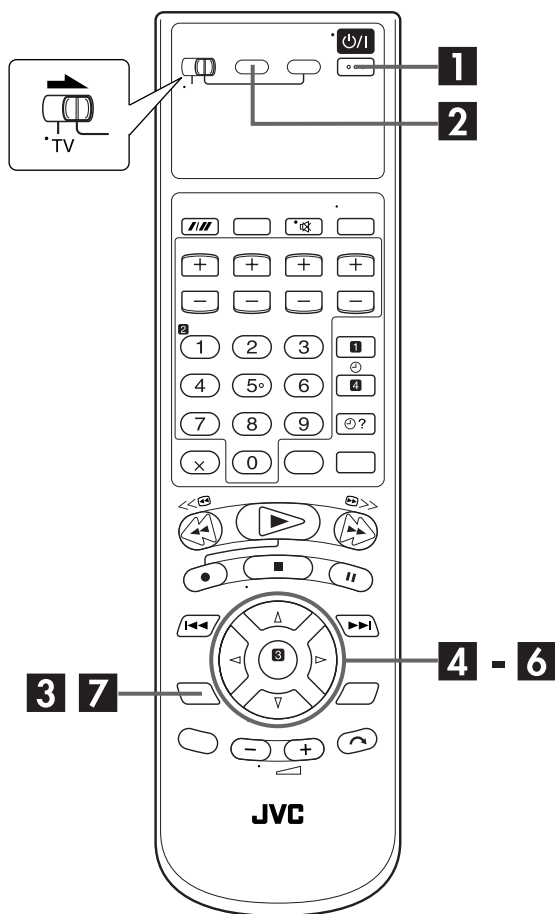

You can change various mode settings on the Mode Set screen by following the procedure described below.

- For each mode setting, see pages 71 to 74.

1 Turn on the unit.

Press /I.

2 Select the S-VHS deck.

On the unit

Press S-VHS/DVD repeatedly so that the S-VHS indicator lights up.

On the remote control

Press S-VHS so that the S-VHS indicator lights up.

3 Access the Main Menu screen.

Press SET UP MENU.

4 Access the Mode Set screen.

Press to move the highlight bar (pointer) to "MODE SET", then press or .

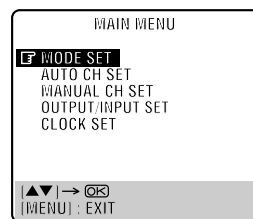

5 Select the mode.

Press to move the highlight bar (pointer) to the item you want to change.

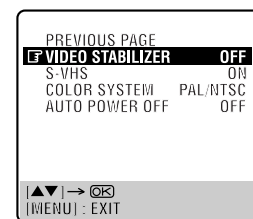
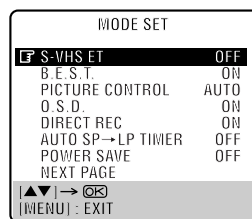

6 Select the mode setting.

Press or .

7 Return to the normal screen.

Press SET UP MENU.

* The default setting is **bold** in the table below.

<p>■ S-VHS ET ON OFF</p>	<p>You can record in SP mode on VHS cassettes with S-VHS picture quality. Tapes recorded using this function can be played back on a recorder equipped with the S-VHS ET function. When this function is set to "ON", the S-VHS indicator lights up on the front display panel.</p> <p>NOTES:</p> <ul style="list-style-type: none"> • You can activate the S-VHS ET function only before you start recording on a VHS cassette. • Before recording, make sure that "B.E.S.T." is set to "ON". (☞ below) • You cannot activate the S-VHS ET function: <ul style="list-style-type: none"> — while recording is in progress. — while timer-recording or Instant Timer Recording (☞ pg. 27, 30, 32) is in progress. — while B.E.S.T. (☞ pg. 29) is in progress. • The S-VHS ET function does not work: <ul style="list-style-type: none"> — with S-VHS cassettes. — with recordings in LP mode. • To keep the highest quality recording and playback pictures over a long period of time, S-VHS recording on S-VHS cassettes is recommended. • Use of high grade tapes is recommended for S-VHS ET recordings. On some tapes, picture quality will not improve even if the S-VHS ET function is used. Check the recording quality before you start important recordings. • You can play back a tape recorded using the S-VHS ET function on most of S-VHS recorders and of VHS recorders equipped with SQPB (S-VHS QUASI PLAYBACK) function. (Notice some recorders are not compatible with the S-VHS ET function.) • While playing back a tape recorded using the S-VHS ET function on some recorders, noise may appear. (If playback picture becomes blurred or interrupted, use a cleaning cassette.) • In the high-speed search, still, slow-motion or frame-by-frame playback modes (☞ pg. 23, 24), noise may appear. If these modes are performed frequently on a tape recorded using the S-VHS ET function, the tape may be damaged and the picture may be deteriorated.
<p>■ B.E.S.T. ON OFF</p>	<p>You can set the B.E.S.T. (Biconditional Equalised Signal Tracking) system to "ON" or "OFF". (☞ pg. 29)</p>
<p>■ PICTURE CONTROL AUTO EDIT SOFT</p>	<p>This feature helps you to adjust the playback picture quality according to your preference. Normally select "AUTO".</p> <p>AUTO: Provides the optimised picture benefits of the B.E.S.T. Picture System.</p> <p>EDIT: Minimizes picture degradation during editing (recording and playback).</p> <p>SOFT: Reduces image coarseness when viewing overplayed tapes containing a lot of noise.</p> <p>NOTES:</p> <ul style="list-style-type: none"> • When you select "EDIT" or "SOFT", the selected mode will not change until you select another mode. • When you select "EDIT" to dub tapes, be sure to select "AUTO" after you finish dubbing the tapes. • When "B.E.S.T." is "OFF", "PICTURE CONTROL" switches automatically from "AUTO" to "NORM".

* The default setting is **bold** in the table below.

<p>■ O.S.D. ON OFF</p>	<p>When this function is set to "ON", various operational indicators appear on the TV screen. Messages appear in the selected language. (☞ pg. 14, 18)</p> <p>NOTES:</p> <ul style="list-style-type: none"> • When you use this unit as the source player for editing, be sure to set "O.S.D." to "OFF" before starting. • During playback, the operation mode indicators may be disturbed depending on the type of tape being used. 						
<p>■ DIRECT REC ON OFF</p>	<p>When this function is set to "ON", you can easily start recording the programme that you are watching on your TV. Press and hold ● and press ► on the remote control, or press ● on the unit.</p> <p>NOTES:</p> <ul style="list-style-type: none"> • When you use the Direct Rec function, be sure to use a TV offering T-V LINK, etc. and connect a fully-wired 21-pin SCART cable between the unit and the TV. (☞ pg. 12) • If "DIRECT REC" is set to "OFF", the ● button functions as described in "Basic Recording" (☞ pg. 26). • During the Direct Rec, "--" appears on the front display panel. • When "DIRECT REC" is set to "ON", if you press any button just after pressing ● on the unit (or ● and ► on the remote control), the unit may not function properly. 						
<p>■ AUTO SP→LP TIMER ON OFF</p>	<p>When this function is set to "ON", the unit automatically switches to LP mode to allow complete recording if there is not enough tape to record the entire programme while timer-recording in SP mode.</p> <p>For Example: Recording a programme of 210 minutes in length onto a 180-minute tape</p> <table border="1" data-bbox="491 929 1081 1012"> <tr> <td style="text-align: center;">Approximately 150 minutes</td> <td style="text-align: center;">Approximately 60 minutes</td> </tr> <tr> <td style="text-align: center;">SP mode</td> <td style="text-align: center;">LP mode</td> </tr> <tr> <td colspan="2" style="text-align: center;">Total 210 minutes</td> </tr> </table> <p>Make sure you set this function to "ON", before the timer-recording starts.</p> <p>NOTES:</p> <ul style="list-style-type: none"> • If you have programmed the unit to timer-record 2 or more programmes, the second programme and those thereafter may not fit on the tape if you set "AUTO SP→LP TIMER" to "ON". In this case, make sure the mode is not engaged, then set the tape speed manually during timer programming. • In order to ensure that the recording fits on the tape, this feature may leave a slight non-recorded section at the end of the tape. • There may be some noise and sound disturbance at the point on the tape where the unit switches from SP to LP mode. • The Auto SP→LP Timer feature is not available during ITR (Instant Timer Recording), and the feature will not work properly with any tapes longer than E-180, or with some tapes of shorter lengths. • If you perform timer recording with both VPS/PDC and the Auto SP→LP Timer activated, and the programme goes beyond its originally scheduled length, there may be times when the programme cannot be recorded in its entirety. 	Approximately 150 minutes	Approximately 60 minutes	SP mode	LP mode	Total 210 minutes	
Approximately 150 minutes	Approximately 60 minutes						
SP mode	LP mode						
Total 210 minutes							

* The default setting is **bold** in the table below.

<p>■ POWER SAVE ON OFF</p>	<p>When this function is set to "ON", you can reduce the power consumption while the unit is turned off.</p> <p>NOTES:</p> <ul style="list-style-type: none"> ● During Power Save mode: <ul style="list-style-type: none"> — the front display panel will be turned off. — the Just Clock function (ⓘ pg. 84) does not work. — the picture may be distorted momentarily when you turn on/off the unit. ● Power Save does not work when: <ul style="list-style-type: none"> — the unit is in the Timer mode. — the unit's power is turned off after timer-recording or Instant Timer Recording. — the Automatic Satellite Programme Recording mode is engaged. (ⓘ pg. 35) — "L-2 SELECT" is set to "DECODER" or "SAT". (ⓘ pg. 61)
<p>■ VIDEO STABILIZER ON OFF</p>	<p>When this function is set to "ON", you can automatically correct vertical vibration in the picture when playing back unstable recordings made on another recorder.</p> <p>NOTES:</p> <ul style="list-style-type: none"> ● When you finish viewing a tape, be sure to set this function to "OFF". ● Regardless of the setting, this function has no effect during recording and during special effects playback. ● The on-screen display may jitter vertically when this function is set to "ON". ● To watch recordings with close-caption, set this function to "OFF".
<p>■ S-VHS ON OFF</p>	<p>Your unit can record in S-VHS (Super VHS), S-VHS ET or VHS.</p> <ul style="list-style-type: none"> ● To record in S-VHS: Set "S-VHS" to "ON". Then, insert a cassette marked "S-VHS". The S-VHS indicator lights up on the front display panel. The S-VHS recording mode is selected. ● To record in S-VHS ET on a VHS cassette: Set "S-VHS ET" to "ON". (ⓘ pg. 71) Then, insert a cassette marked "VHS". The S-VHS indicator lights up on the front display panel. ● To record in VHS: Insert a cassette marked "VHS". Set "S-VHS ET" to "OFF". (ⓘ pg. 71) The VHS recording mode is automatically selected regardless of the "S-VHS" mode setting. ● To record in VHS on an S-VHS cassette: Insert a cassette marked "S-VHS". The S-VHS indicator lights up on the front display panel. Then, set "S-VHS" to "OFF". The S-VHS indicator goes off. The VHS recording mode is selected. <p>NOTE: When playing back a tape that has been recorded in S-VHS or S-VHS ET, the S-VHS indicator lights up on the front display panel regardless of the "S-VHS" mode setting.</p>

* The default setting is **bold** in the table below.

<p>■ COLOUR SYSTEM PAL/NTSC MESECAM</p>	<p>You can play back PAL, NTSC and MESECAM tapes, or record PAL and SECAM* signals on this unit. Select the appropriate colour system. <i>* SECAM signals will be recorded as MESECAM on this unit; MESECAM is the designation for tapes with SECAM signals that have been recorded on a MESECAM-compatible PAL video cassette recorder.</i></p> <p>PAL/NTSC: To record PAL signals, or play back a PAL or NTSC tape. MESECAM: To record SECAM signals, or play back a MESECAM tape.</p> <p>NOTES:</p> <ul style="list-style-type: none"> ● It is not possible to record in S-VHS if “MESECAM” is selected. The recording mode is forced to change to VHS. ● If “MESECAM” is selected when the tape speed is set to EP mode, the tape speed will be forced to change to LP mode. ● It is not possible to select EP mode if “MESECAM” is selected. <p>About NTSC Playback</p> <ul style="list-style-type: none"> ● Some TVs shrink the picture vertically and place black bars at the top and bottom of the TV screen. This is not a malfunction on the part of either the unit or the TV. ● The picture may roll up and down. This can be corrected using the V-HOLD control found on some TVs. (This cannot be corrected if the TV does not have a V-HOLD control.) ● The counter and tape remaining time readings will be incorrect. ● During search, still, or frame-by-frame playback, the picture will be distorted, and there may be a loss of colour. ● Depending on the type of TV, the top and bottom portions of superimposed displays may be cut off during NTSC playback.
<p>■ AUTO POWER OFF 3H OFF</p>	<p>When this function is set to “3H”, the unit is turned off automatically if no operation is done within 3 hours. “AUTO POWER OFF IN 3 MIN” appears on the screen 3 minutes before the unit is turned off.</p>

Mode Set

(DVD deck)

- Turn on the TV and select the video channel (or AV mode).
- Slide the TV/S-VHS/DVD switch to the right.

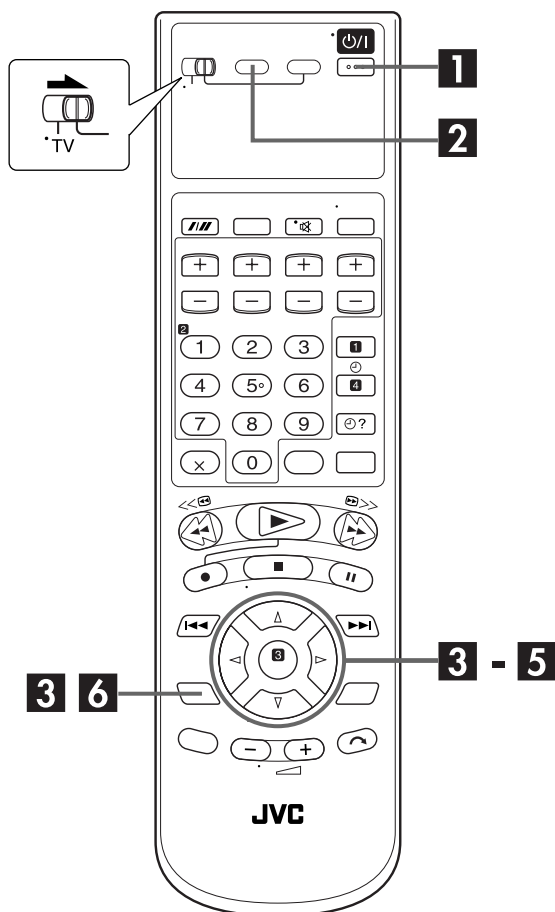

You can change various mode settings on the Mode Set screen by following the procedure described below.

- For each mode setting, see pages 76 to 77.

LANGUAGE	MENU LANGUAGE (☞ pg. 19) AUDIO LANGUAGE (☞ pg. 19) SUBTITLE (☞ pg. 19) ON SCREEN LANGUAGE (☞ pg. 19)
AUDIO	DIGITAL AUDIO OUTPUT (☞ pg. 76) DOWN MIX (☞ pg. 76) COMPRESSION (☞ pg. 76)
DISPLAY	MONITOR TYPE (☞ pg. 17) SCREEN SAVER (☞ pg. 77) ON SCREEN GUIDE (☞ pg. 77)
SYSTEM	RESUME (☞ pg. 77)

- The procedure shows how to set "RESUME" to "ON" on the DVD menu screen as an example.

1 Turn on the unit.

Press **⏻/I**.

2 Select the DVD deck.

On the unit

Press **S-VHS/DVD** repeatedly so that the DVD indicator lights up.

On the remote control

Press **DVD** so that the DVD indicator lights up.

3 Access the DVD menu screen.

- 1 Press **SET UP MENU**.
- 2 Press **◀▶** to move the arrow to "SYSTEM".

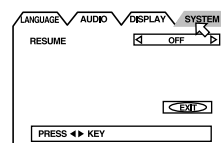

4 Select the mode.

Press **△▽** to move the arrow to "RESUME".

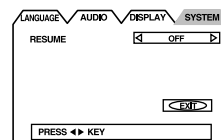

5 Select the mode setting.

Press **◀▶** to select "ON".

6 Return to the normal screen.

Press **SET UP MENU**.

Audio Settings

* The default setting is **bold** in the table below.

<p>■ DIGITAL AUDIO OUTPUT PCM ONLY DOLBY DIGITAL/PCM STREAM/PCM</p>	<p>Set to the appropriate mode according to the type of the device connected to DIGITAL AUDIO OUT connector on the rear of unit. It is not necessary to set this mode when you connect no device to DIGITAL AUDIO OUTconnector.</p> <p>PCM ONLY: Select this when you connect the unit's DIGITAL AUDIO OUT connector to the linear PCM digital input connector of other audio device.</p> <p>DOLBY DIGITAL/PCM: Select this when you connect the unit's DIGITAL AUDIO OUT connector to the digital input connector of a Dolby Digital decoder or an amplifier with a built-in Dolby Digital decoder.</p> <p>STREAM/PCM: Select this when you connect the unit's DIGITAL AUDIO OUT connector to the digital input connector of an amplifier with a built-in DTS, Dolby Digital, or MPEG multichannel decoder.</p>
<p>■ DOWN MIX Lt/Rt Lo/Ro</p>	<p>Set to the appropriate mode according to your audio system when you play back a DVD VIDEO disc recorded with surround multichannel audio. This setting affects only the analogue audio output signal from the AUDIO OUT connectors when playing back a DVD VIDEO disc recorded with surround multichannel audio.</p> <p>Lt/Rt: Select this when you enjoy multichannel surround audio by connecting the unit's DIGITAL AUDIO OUT connector to a surround decoder or an internal amplifier.</p> <p>Lo/Ro: Select this when you enjoy conventional 2-channel stereo audio by connecting the unit's DIGITAL AUDIO OUT connector to a stereo amplifier/receiver or TV, or when you dub audio of a DVD VIDEO disc recorded with surround audio to your MD, cassette, etc.</p> <p>NOTE: The "DOWN MIX" function does not work when the 3D Phonic function is activated. (☞ pg. 43)</p>
<p>■ COMPRESSION ON OFF</p>	<p>When this function is set to "ON", you can compress the dynamic range (the difference between the loudest and quietest audio signals) of the sound. This function is available with DVD VIDEO discs recorded with the Dolby Digital format.</p> <p>ON: Audio is played back with the dynamic range compressed. OFF: Audio is played back as it was recorded.</p> <p>NOTES:</p> <ul style="list-style-type: none"> ● It is recommended to set to "ON" when you enjoy surround sound at night. ● The "COMPRESSION" function works only when playing back a disc recorded with Dolby Digital format. The setting is not effective for other discs. ● The "COMPRESSION" function does not work when the 3D phonic function is activated. (☞ pg. 43)

Playback discs	Output		
	STREAM/PCM	DOLBY DIGITAL/PCM	PCM ONLY
DVD VIDEO with 48/44.1 kHz, 16/20/24 bit linear PCM	48/44.1 kHz, 16/20/24 bit linear PCM		
DVD VIDEO with 96/88.2 kHz linear PCM	No output		
DVD VIDEO with DTS	DTS bitstream	48 kHz, 16 bit stereo linear PCM	
DVD VIDEO with Dolby Digital	Dolby Digital bitstream		48 kHz, 16 bit stereo linear PCM
Audio CD/Video CD	44.1 kHz, 16 bit stereo linear PCM		
Audio CD with DTS	DTS bitstream		

NOTES:

- The unit is not equipped with the DTS decoding function.
- When you play back a DVD VIDEO or Audio CD disc with DTS, use a DTS decoder to get correct signals from your speakers. Never use the unit's analog output connectors, which output incorrect signals that may damage your speakers.
- If you connect the analog outputs and digital outputs simultaneously, be sure to select the source of the amplifier correctly, or set the level control of the amplifier connected to the analog outputs to minimum.

Display Settings* The default setting is **bold** in the table below.

■ SCREEN SAVER ON OFF	<p>The TV screen may be burned out if a static picture is displayed for a long time. When this function is set to "ON", the unit automatically activates the screen saver function if a static picture, such as an on-screen display or menu is displayed for over 5 minutes.</p> <p>NOTE: This function is not available for Audio CDs and MP3 discs.</p>
■ ON SCREEN GUIDE ON OFF	<p>When this function is set to "ON", the unit can display "on-screen guide" icons or characters which shows the conditions of the unit or disc.</p>

System Settings* The default setting is **bold** in the table below.

■ RESUME ON OFF	<p>When this function is set to "ON", you can use the resume function. (☞ pg. 39)</p> <p>ON: You can start playback from the resume point if it is memorized.</p> <p>OFF: You cannot use the resume function.</p> <p>NOTE: This function is not available for Audio CDs and MP3 discs.</p>
--------------------------------------------	---------------------------------------------------------------------------------------------------------------------------------------------------------------------------------------------------------------------------------------------------------------------------------------------------------------------

Tuner Set

- Turn on the TV and select the video channel (or AV mode).
- Slide the TV/S-VHS/DVD switch to the right.

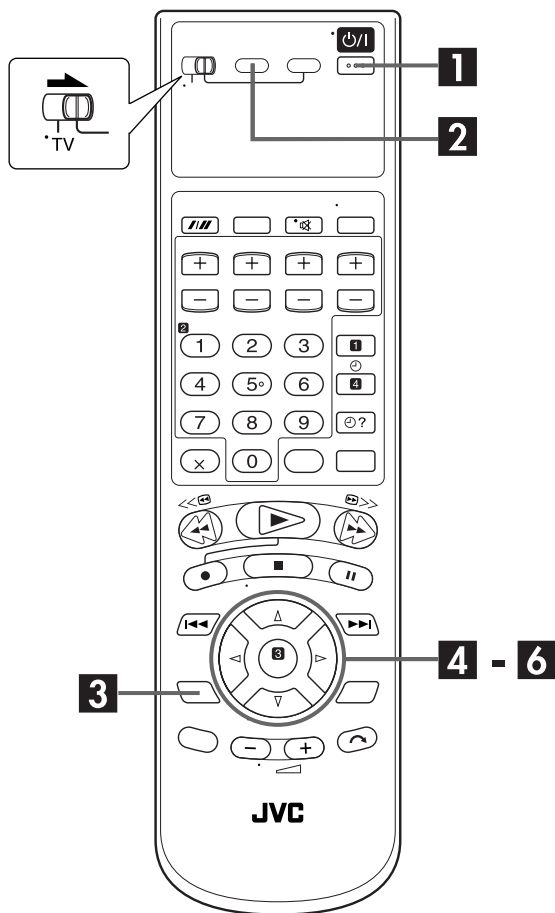

IMPORTANT

Perform the following steps only if —
 — Auto Channel Set has not been set correctly by Auto Set Up or by Preset Download. (pg. 13, 15)
 — you have moved to a different area or if a new station starts broadcasting in your area.

Your unit needs to memorize all necessary stations in channel positions in order to record TV programmes. Auto Channel Set automatically assigns all receivable stations in your area to call them up by using the **PR** buttons without going through any vacant channels.

Auto Channel Set

1 Turn on the unit.

Press **⏻/I**.

2 Select the S-VHS deck.

On the unit

Press **S-VHS/DVD** repeatedly so that the S-VHS indicator lights up.

On the remote control

Press **S-VHS** so that the S-VHS indicator lights up.

3 Access the Main Menu screen.

Press **SET UP MENU**.

4 Access the Auto Channel Set screen.

Press **△▽** to move the highlight bar (pointer) to "AUTO CH SET", then press **OK** or **▷**.

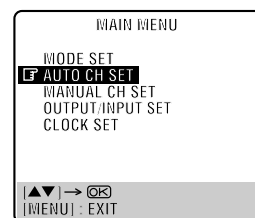

5 Select your country.

Press **△▽** to move the highlight bar (pointer) to your country's name, then press **OK** or **▷**.

6 Select the language.

Press **△▽** to move the highlight bar (pointer) to the language of your choice.

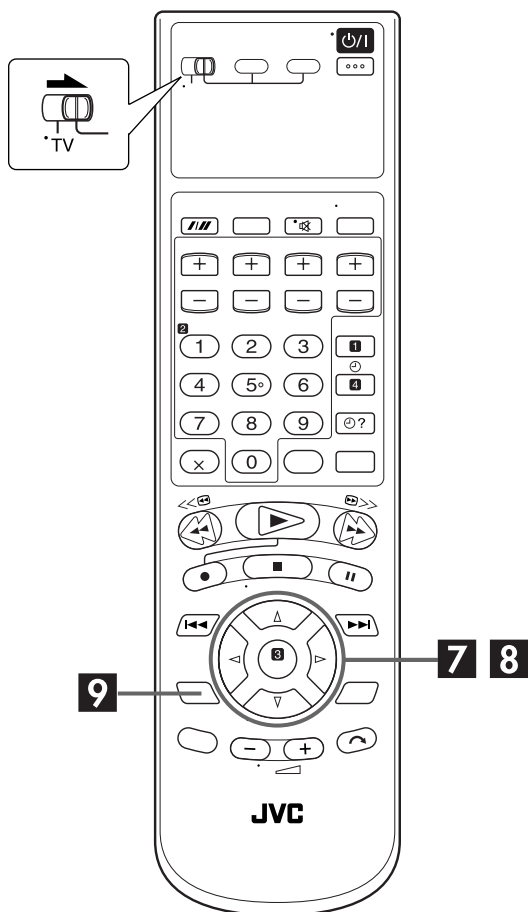

IMPORTANT

- In certain reception conditions, station names may not be stored correctly, and Auto Guide Program Number Set may not work properly. If the Guide Program numbers are not set properly when you timer-record a TV programme using the SHOWVIEW system, the unit will record a TV programme of a different station. When programming the timer using the SHOWVIEW system, be sure to check the desired channel is selected correctly. (☞ pg. 30, "SHOWVIEW" Timer Programming") (S-VHS deck only)
- Your unit memorizes all detected stations even if reception of some of them is poor. You can delete those stations with an unacceptable picture. (☞ pg. 81, "Delete A Channel")

NOTES:

- Fine tuning is performed automatically during Auto Channel Set. If you want to perform tuning manually, refer to page 82.
- If you perform Auto Channel Set when the aerial cable is not connected properly, "SCAN COMPLETED -NO SIGNAL-" appears on the TV screen in step 8. When this happens, make sure of the aerial connection and press **OK**; Auto Channel Set will take place again.
- If no sound accompanies the picture or the audio sounds unnatural on some channels that have been stored by Auto Set Up, the TV system setting for those channels may be incorrect. Select the appropriate TV system for those channels. (☞ pg. 81, "INFORMATION")

7 Perform Auto Channel Set.

Press **OK** twice.

- When you have connected the unit to a TV offering T-V Link via a fully-wired 21-pin SCART cable (☞ pg. 12), the unit automatically performs the Preset Download and the T-V LINK screen will appear. (☞ pg. 15)

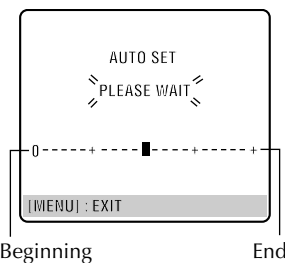

- The Auto Set screen appears, and remains on screen while the unit searches for receivable stations.

As Auto Channel Set progresses, the "■" mark on the TV screen moves from left to right. Wait until the TV screen as shown in step 8 appears.

8 View the Confirmation screen.

After "SCAN COMPLETED" is displayed on the TV screen for about 5 seconds, the Confirmation screen looking like the one to the right appears. The stations your unit located appear on a Confirmation screen — channel positions (PR),

PR	CH	ID	PR	CH	ID
01	25	ARD	08	C26	E-SP
02	C08	SKY1	09	55	WEST
03	10	ZDF	10	C24	SAT1
04	C65	RAI1	11	C23	OSF
05	C31	BBC1	12		
06	C32	BBC2	13		
07	C33	3SAT	14		

▲▼◀▶ : EDIT
 → [X] : DELETE
 [MENU] : EXIT

channels (CH) and station names (ID – ☞ pg. 83). The blueback screen and the programme currently being broadcast by the blinking station appear alternately for 8 seconds each. To view the next page, use the Δ ∇ \triangleleft \triangleright button on the remote control.

- The stations located in the selected country appear at the top of the list.
- The Guide Program numbers will also be set automatically during Auto Channel Set.

9 Return to the normal screen.

Press **SET UP MENU**.

- Using the Confirmation screen, you can skip or add channel positions, enter station names and perform other operations. Refer to pages 80 – 82 for the procedures.
- Depending on reception conditions, the stations may not be stored in order, and the station names may not be stored correctly.
- For information on scrambled broadcasts, refer to page 81.

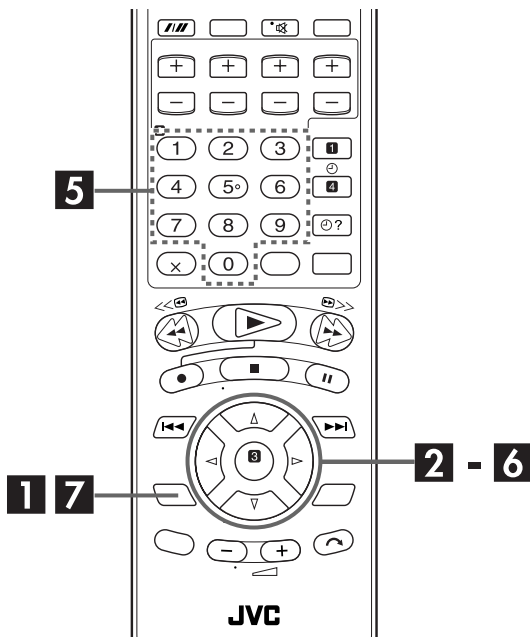

Manual Channel Set

Store channels that were not stored during Auto Set Up (pg. 13), Preset Download (pg. 15) or Auto Channel Set (pg. 78).

1 Access the Main Menu screen.

Press **SET UP MENU**.

2 Access the Confirmation screen.

Press Δ / ∇ to move the highlight bar (pointer) to "MANUAL CH SET", then press **OK** or \triangleright . The Confirmation screen appears.

3 Select the channel position.

Press Δ / ∇ / \triangleleft / \triangleright until an open position in which you want to store a channel begins blinking, then press **OK**. The Manual Channel Set screen appears.

(Example) To store in position 12.

PR	CH	ID	PR	CH	ID
01	25	ARD	08	C26	E-SP
02	C08	SKY1	09	55	WEST
03	10	ZDF	10	C24	SAT1
04	C65	RAI1	11	C23	OSF
05	C31	BBC1	12	---	---
06	C32	BBC2	13	---	---
07	C33	3SAT	14	---	---

Navigation options shown below the table:

- Δ / ∇ / \triangleleft / \triangleright : SELECT
- \leftarrow / \rightarrow : CURSOR
- OK** : OK
- W** : EXIT

The blueback screen and the programme currently being broadcast by the selected channel appear alternately for 8 seconds each.

4 Select the band.

Press Δ / ∇ to change the band between CH (regular) and CC (cable), then press \triangleright .

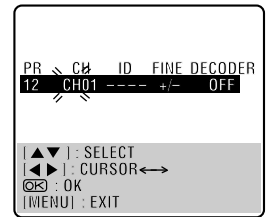

5 Input the channel.

Press the **number keys** to input the channel number you want to store.

- Input "0" before any single number entries.
- To input the registered station name (ID - pg. 83), press Δ / ∇ until "----" (ID setting) begins blinking, then press Δ / ∇ .
- For fine tuning adjustment, press \triangleright until "+/-" begins blinking, then press Δ / ∇ . While tuning, "+" or "-" appears.
- When storing a channel that sends scrambled broadcasts, press \triangleright until "OFF" (Decoder setting) blinks, then press Δ / ∇ to set "DECODER" to "ON" ("OFF" is the default setting).
- When "L-2 SELECT" is set to "AV" or "SAT", the "DECODER" setting cannot be changed. (pg. 61)

6 Enter new channel information.

Press **OK** and the Confirmation screen appears.

- Repeat steps 3 - 6 as necessary.

7 Close the Confirmation screen.

Press **SET UP MENU**.

- To change positions, see "Change Station Channel Position" (pg. 81).
- If you wish to set station names other than the ones registered in your unit, see "Set Stations (B)" (pg. 82).

ATTENTION

Guide Program numbers are not set when channels are stored manually. (pg. 31, "ATTENTION — Guide Program Number Set")

Delete A Channel

Perform steps **1** and **2** of "Manual Channel Set" on page 80 to access the Confirmation screen before continuing.

1 Select the item.

Press $\Delta \nabla \triangleleft \triangleright$ until the item you want to delete begins blinking.

2 Delete a channel.

Press **X**.

- The item directly beneath the cancelled one moves up one line.
- Repeat steps **1** and **2** as necessary.

3 Close the Confirmation screen.

Press **SET UP MENU**.

Change Station Channel Position

Perform steps **1** and **2** of "Manual Channel Set" on page 80 to access the Confirmation screen before continuing.

1 Select the item.

Press $\Delta \nabla \triangleleft \triangleright$ until the item you want to move begins blinking. Then press **OK** and the station name (ID) and its channel (CH) number begin blinking.

2 Select the new position.

Press $\Delta \nabla \triangleleft \triangleright$ to move the station to the new channel position, then press **OK**.

Example: If you moved the station in position 4 to position 2, the stations originally in positions 2 and 3 each move down one space.

PR	CH	ID	PR	CH	ID
01	25	ARD	08	C26	E-SP
02	C08	SKY1	09	55	WEST
03	10	ZDF	10	C24	SAT1
04	C65	RAI1	11	C23	OSF
05	C31	BBC1	12	C25	ESPN
06	C32	BBC2	13	----	----
07	C33	3SAT	14	----	----

➔

PR	CH	ID	PR	CH	ID
01	25	ARD	08	C26	E-SP
02	C65	RAI1	09	55	WEST
03	C08	SKY1	10	C24	SAT1
04	10	ZDF	11	C23	OSF
05	C31	BBC1	12	C25	ESPN
06	C32	BBC2	13	----	----
07	C33	3SAT	14	----	----

- Repeat steps **1** and **2** as necessary.

3 Close the Confirmation screen.

Press **SET UP MENU**.

When Receiving A Scrambled Broadcast

1 Select the decoder mode.

Set "L-2 SELECT" to "DECODER". (☞ pg. 61)

2 Access the Confirmation screen.

Perform steps **1** and **2** of "Manual Channel Set" on page 80.

3 Select the position.

Press $\Delta \nabla \triangleleft \triangleright$ to select the channel position broadcasting scrambled programmes, then press **OK** twice.

4 Change the decoder setting.

Press \triangleright until "OFF" (decoder setting) begins blinking, and set it to "ON" by pressing $\Delta \nabla$.

5 Return to the Confirmation screen.

Press **OK**.

- Repeat steps **3** – **5** as necessary.

6 Close the Confirmation screen.

Press **SET UP MENU**.

INFORMATION

If you live in Eastern Europe, "TV SYSTEM" setting appears instead of "DECODER" setting on the Manual Channel Set screen. When you can see the picture but can hear no audio, select appropriate TV system (D/K or B/G). Normally, TV programmes are broadcasted as follows.

For Eastern Europe : D/K

For Western Europe : B/G

- 1 Select a country in Eastern Europe in step **5** on page 78.
- 2 Press \triangleright until the TV system (D/K or B/G) blinking on the Manual Channel Set screen in step **4** on page 80.
- 3 Press $\Delta \nabla$ to select appropriate TV System (D/K or B/G).

Set Stations (A)

Set station names that are registered in your unit.

Perform steps **1** and **2** of "Manual Channel Set" on page 80 to access the Confirmation screen before continuing.

1 Select the item.

Press $\Delta \nabla \triangleleft \triangleright$ until the item you want begins blinking.

2 Access the Manual Channel Set screen.

Press **OK** twice.

3 Select the new station.

Press \triangleright until the station name (ID) begins blinking, then press $\Delta \nabla$ until the new station's name (ID) you want to store begins blinking. Registered station names (see pg. 83) appear as you press $\Delta \nabla$.

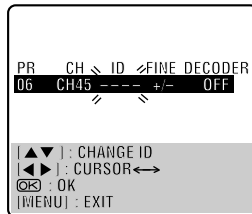

4 Switch the stations.

Press **OK**.

- The Confirmation screen appears.
- Repeat steps **1** – **4** as necessary.

5 Close the Confirmation screen.

Press **SET UP MENU**.

Set Stations (B)

Set station names other than the ones registered in your unit.

Perform steps **1** and **2** of "Manual Channel Set" on page 80 to access the Confirmation screen and then perform steps **1** and **2** of "Set Stations (A)" above before continuing.

1 Select the character for station name.

Press \triangleright until the first letter of the station name begins blinking.

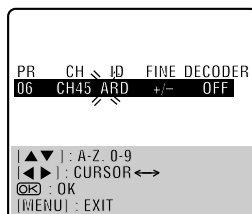

2 Enter the new character.

Press $\Delta \nabla$ to cycle through the characters (A–Z, 0–9, –, *, +, _ (space)) and stop when the desired character is indicated, then press \triangleright to enter. Enter the remaining characters the same way (maximum of 4). After entering all characters, press **OK**.

- The Confirmation screen appears.
- If you make a mistake, press \triangleleft until the incorrect character begins blinking. Then enter the correct character by pressing $\Delta \nabla$.

3 Close the Confirmation screen.

Press **SET UP MENU**.

NOTE:

The characters available for the station name (ID) are A–Z, 0–9, –, *, +, _ (space) (maximum of 4).

Fine-Tuning Channels Already Stored

Perform steps **1** and **2** of "Manual Channel Set" on page 80 to access the Confirmation screen before continuing.

1 Select the channel to fine-tune.

Press $\Delta \nabla \triangleleft \triangleright$ until the channel you want to tune begins blinking.

2 Access the Manual Channel Set screen.

Press **OK** twice. The Manual Channel Set screen appears.

3 Perform tuning.

Press \triangleright until "+/-" begins blinking, then press $\Delta \nabla$ until the picture is its clearest. Then press **OK**.

- The Confirmation screen appears.
- Repeat steps **1** – **3** as necessary.

4 Close the Confirmation screen.

Press **SET UP MENU**.

TV Station And ID List

ID*	STATION NAME
1000	TV1000
3SAT	3SAT
9LIV	9LIVE
AB3	AB3
ADLT	ADULT
ANIM	Animal Planet
ANT3	ANTENA3
ARD	ARD
ARTE	ARTE
ATV	ATV
B1	BERLIN 1
BBC	BBC GROUP
BBC1	BBC1
BBC2	BBC2
BBCW	BBCW
BIO+	TV BIO+
BLOO	BLOOMBERG
BR3	BAYERN3
C+	CANAL PLUS
C1	PORTUGUSES
C9	C9
CAN5	CANALES
CANV	KETNET CANVAS
CANZ	KANAAL Z
CH4	CHANNEL4
CH5	CHANNEL5
CHLD	CHILD
CINE	CINEMA
CLUB	TELECLUB
CMT	CMT
CNN	CNN
CSUR	ANDALUCIA
CT1	CT 1
CT2	CT 2
DISC	DISCOVERY
DK1	TV Denmark 1
DK2	TV Denmark 2
DK4	Denmark 4
DR1	DR TV
DR2	DR2
DSF	DSF
DUNA	DUNA TV
ETB1	ETB1
ETB2	ETB2
ETV	Game/Shop/Music
EUNW	EURO NEWS
EURO	EURONEWS
EUSP	EUROSPORTS
FEMM	FEMMAN
FILM	FILM
FNET	FILMNET
FR2	France2
FR3	France3
FR5	France5
GALA	GALAVISION
HBO	HBO
HR3	HESSEN3
HSEU	HSEU
INFO	INFO-KANAL
ITA1	ITALIA1
ITA7	ITALIA7
ITV1	ITV

ID*	STATION NAME
JIM	JIM TV
JSTV	JSTV
KA2	KA2
KAB1	KABEL1
KAN2	KANAL2
KAN5	KANAL5
KBH	Kbh. Kanal
KIKA	Kinder kanal
LA7	LA7
LIB	Liberty TV
LOCA	LOCAL
M6	M6
MBC	MBR
MCM	MCM
MDR	MDR
MOVE	MOVIE
MTV	MTV
MTV1	MTV1
MTV2	MTV2
MTV3	MTV3
NGEO	NGEO
N24	News 24
N3	NORD3
N-TV	N-TV
NBC	NBC SUPER
NDR	NDR
NED1	NED1
NED2	NED2
NED3	NED3
NET5	Net 5
NEWS	
NICK	NICKELODEON
NOVA	NOVA TV
NRK1	NRK
NRK2	NRK2
ODE	ODEON
ORF1	ORF1
ORF2	ORF2
PHOE	PHOENIX
POLS	POLST
PREM	PREMIERE
PRIM	PRIMA TV
PRO7	PRO7
RAI1	RAI1
RAI2	RAI2
RAI3	RAI3
RET4	RETE4
RTB1	TELE21
RTB2	RTBF 2
RTL	RTL
RTL2	RTL2
RTL4	RTL4
RTL5	RTL5
RTL7	RTL7
RTLK	RTL KLUB
RTP	RTP
RTV4	RTV4
SAT1	SAT1
SBS6	SBS
SERV	Service
SF1	SF1
SF2	SF2

ID*	STATION NAME
SHOW	SHOW
SIC	SOCIEDADE
SKY	SKY CHANNEL
SKYN	SKY NEWS
SPEK	SPEKTRUM
SPRT	SPORT
SRTL	SUPER RTL
STAR	STAR-TV
SVT1	SVT1
SVT2	SVT2
SV24	News
SWR	SUEDWEST3
TCC	TCC
TCM	TCM
TELE	TELE
TELE5	TELE5
TF1	TF1
TM	TM
TMC	TELEMONTECARLO
TMF	TMF
TNT	TNT INT
TRT	TRT INT
TSI1	TSI
TSI2	TSI2
TSR1	TSR
TSR2	TSR2
TV1	BRTN TV1
TV2	TV2
TV2Z	TV2 Z
TV3	TV3
TV3+	TV3 plus
TV4	TV4
TV5	TV5
TV6	TV6
TV8	TV8
TVE1	TVE1
TVE2	TVE2
TVG	TV GALICIA
TVI	TV INDEPENDENT
TVN	TV NORGE
TVN24	TVN24
TVP1	TVP1
TVP2	TVP2
TV P	TV Polonia
V8	V8
VCR	VIDEO
VH-1	VH-1
VIT	VIT
VIVA	VIVA
VIV2	VIVA2
VMTV	VIDEO MUSIC
VOX	VOX
VSAT	VIASAT3
VT4	VT4
VTM	VTM
WDR3	West3
WRLD	WRLD
YLE1	YLE1
YLE2	YLE2
YORN	YORIN
ZDF	ZDF
ZTV	ZTV

* The "ID" abbreviation is what is shown on-screen in lieu of the station name. The "ID" abbreviation is listed in the Confirmation screen and is displayed on the TV screen when the unit is tuned to a different station.

Clock Set

- Turn on the TV and select the video channel (or AV mode).
- Slide the TV/S-VHS/DVD switch to the right.

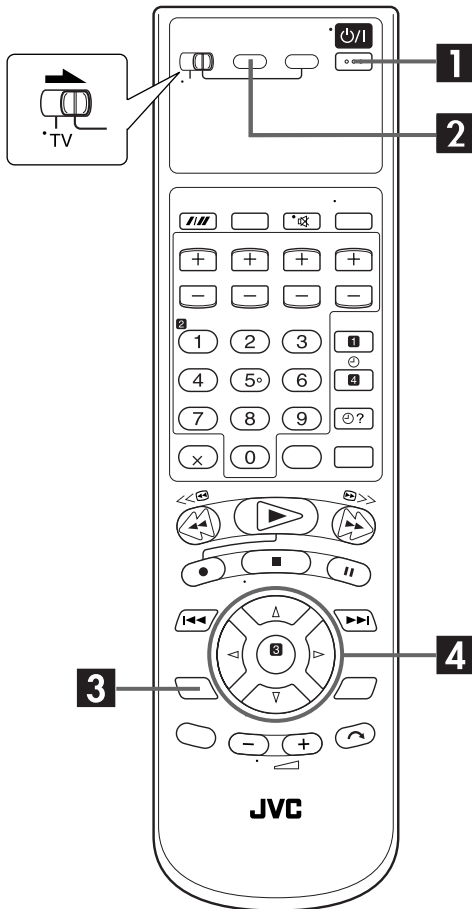

Just Clock

The Just Clock function provides accurate time keeping through automatic adjustments at regular intervals, by reading data from a PDC signal.

The Just Clock option can be set "ON" or "OFF" at the Clock Set screen (the default setting is "OFF"). Press **OK** until the Just Clock setting begins blinking, then press Δ / ∇ to change the setting.

IMPORTANT: If you turn off Just Clock, the accuracy of your unit's built-in clock may be reduced, which could adversely effect timer recording. We recommend you to keep Just Clock on. In cases where the clock setting data from a PDC signal is incorrect, however, you are advised to keep Just Clock set to "OFF".

IMPORTANT

If you performed Auto Set Up (pg. 13) or Preset Download (pg. 15), without ever having set the clock previously, the unit's built-in clock is also set automatically. Perform the following steps only if —
—Auto Clock Set has not been performed correctly by Auto Set Up or Preset Download.

OR

—you want to change Just Clock setting. (pg. "Just Clock" in the left column)

1 Turn on the unit.

Press power/I .

2 Select the S-VHS deck.

On the unit

Press **S-VHS/DVD** repeatedly so that the S-VHS indicator lights up.

On the remote control

Press **S-VHS** so that the S-VHS indicator lights up.

3 Access the Main Menu screen.

Press **SET UP MENU**.

4 Access the Clock Set screen.

Press Δ / ∇ to move the highlight bar (pointer) to "CLOCK SET", then press **OK** or \triangleright . The Clock Set screen appears.

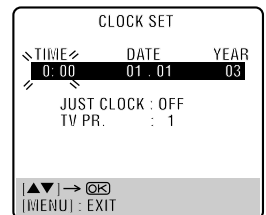
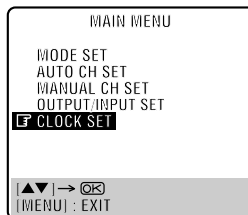

NOTE:

When you have selected MAGYARORSZÁG, ČESKÁ REPUBLIKA, POLSKA or OTHER EASTERN EUROPE for the country setting (pg. 13, 18), you cannot use Just Clock function. Skip steps **6** and **7** on page 85.

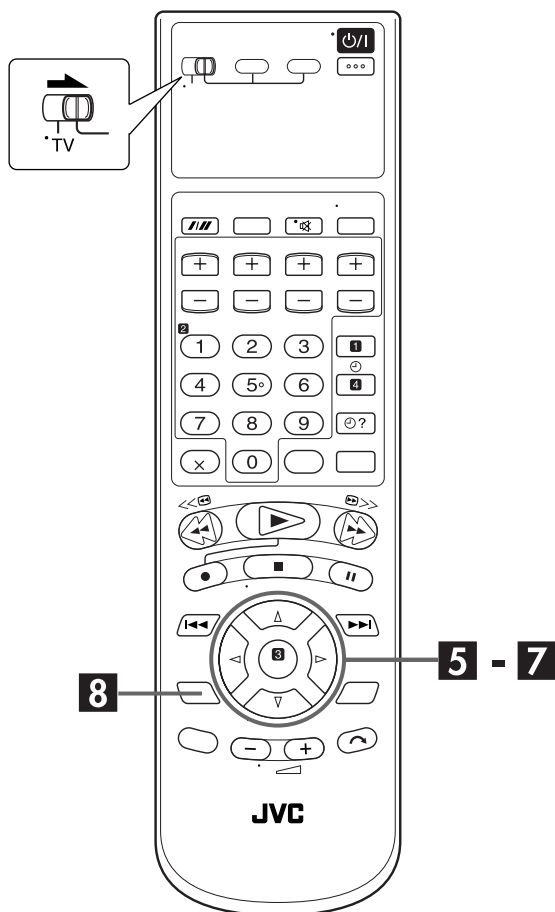

5 Set the date and time.

Press Δ / ∇ to set the time, then press **OK** or \triangleright . The "DATE" display begins blinking. Repeat the same procedure to set the date and year.

- When you set the time, press and hold Δ / ∇ to change the time by 30 minutes.
- When you set the date, press and hold Δ / ∇ to change the date by 15 days.

6 Set Just Clock.

The default setting is "OFF". Set as desired by pressing Δ / ∇ , then press **OK** or \triangleright .

- For the Just clock function, refer to "Just Clock" on page 84.
- If you set to "OFF", you can disregard the next step as you won't be able to receive regular clock adjustments.

7 Set the source channel position for clock data.

The unit is preset to receive clock setting and adjustment data from channel position 1.

Press Δ / ∇ to set the channel position to the number representing the station transmitting clock setting data, then press **OK** or \triangleright .

8 Start the clock operation.

Press **SET UP MENU**.

NOTES:

- Just Clock (when set to "ON") adjusts the unit's built-in clock every hour, except for 23:00, 0:00, 1:00 and 2:00.
- Just Clock is not effective when:
 - the unit's power is on.
 - the unit is in the Timer mode. (S-VHS deck only)
 - a difference of more than 3 minutes exists between the built-in clock's time and the actual time.
 - the unit is in the Automatic Satellite Programme Recording mode. (pg. 35) (S-VHS deck only)
 - the unit is in the Power Save mode. (pg. 73) (S-VHS deck only)
 - "L-2 SELECT" is set to "SAT". (pg. 61) (S-VHS deck only)
- If Just Clock is set to "ON", the unit's clock is automatically adjusted at the start/end of Summer Time.
- Just Clock may not function properly depending on the reception condition.

Video Channel Set

Video channel (RF output channel) is the channel on which your TV receives picture and sound signals from the unit through the RF cable.

IMPORTANT

Perform the following steps only if —

- Video Channel Set has not been done correctly by the Auto Set Up function (☞ pg. 13),
- interference appears in the TV picture after you have moved to a different area or a new station has started broadcasting in your area.
- you change the connection between your unit and TV from RF connection to AV connection, or vice versa.

If you have connected the unit to your TV via the AV connection (☞ pg. 12), since you do not need the video channel you have to set the video channel to off.

If you have connected the unit to your TV via the RF connection (☞ pg. 12), you have to set the correct video channel.

Before performing the following steps:

Make sure the unit's power is off and there is no cassette inserted in the unit.

1 Access the Video Channel Set mode.

Hold down **1** on the unit until the front display panel shows the following.

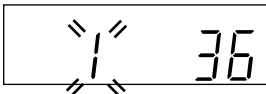

2 Set the RF output system.

The blinking number on the display indicates the RF output system of your country.

- If you have selected MAGYARORSZÁG, ČESKÁ REPUBLIKA, POLSKA or OTHER EASTERN EUROPE for the country setting (☞ pg. 13, 18), press **△▽** to set to "2".
- For other countries, set to "1". Then press **OK**. (1: B/G 2: D/K)

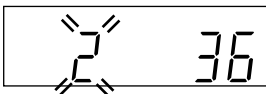

3 Set the video channel.

With AV Connection

Press **PR -** until the front display panel shows "1 - -" (or "2 - -").

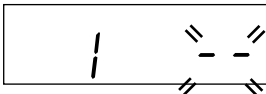

- Now the video channel is set to off.

With RF Connection

Press **PR +** or **-** to set the unit to a vacant channel between 22 and 69 which is not occupied by any local station in your area.

(Example) If channel 50 is available in your area



Then set your TV to UHF channel 50.

- If the two vertical white bars appear clearly on the TV screen as shown to the right, go to step **4**.
- If the two vertical white bars do not appear clearly, re-set the unit to another vacant channel and try again.

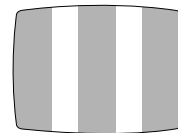

NOTES:

- If you set the unit to a channel which is occupied by a local station or has neighbouring channels that are occupied by local stations, the picture reception quality will be affected and some interference noise will appear on the TV screen. Be sure to select a vacant channel which has no broadcast on neighbouring channels.
- If you cannot obtain the two vertical white bars clearly with any channel between 22 and 69, consult your JVC dealer.

4 Exit the Video Channel Set mode.

Press **OK** on the remote control.

With AV Connection

To view picture signals from the unit, set your TV to its AV mode.

With RF Connection

The channel on which the TV screen in step **3** appears clearly is your video channel.

To view picture signals from the unit, set your TV to the video channel.

Before requesting service for a problem, use this chart and see if you can repair the trouble yourself. Small problems are often easily corrected, and this can save you the trouble of sending your unit off for repair.

POWER

SYMPTOM	POSSIBLE CAUSE	CORRECTIVE ACTION
1. No power is supplied to the unit.	<ul style="list-style-type: none"> The mains power cord is disconnected. 	Connect the mains power cord.
2. The remote control won't function.	<ul style="list-style-type: none"> The batteries are discharged. 	Replace the dead batteries with new ones.

TAPE TRANSPORT (S-VHS deck)

SYMPTOM	POSSIBLE CAUSE	CORRECTIVE ACTION
1. During recording, the tape does not run. "O" lights up and the channel display blinks on the front display panel.	<ul style="list-style-type: none"> The unit is in the Record Pause mode. 	Press ► to resume recording.
2. The tape will not rewind or fast-forward.	<ul style="list-style-type: none"> The tape is already fully rewound or fast-forwarded. 	Check the cassette.

PLAYBACK (S-VHS deck)

SYMPTOM	POSSIBLE CAUSE	CORRECTIVE ACTION
1. The playback picture does not appear while the tape is running.	<ul style="list-style-type: none"> If you are using the RF connection, <ul style="list-style-type: none"> the TV receiver's channel selector is not set to the video channel. the unit's video channel has not been correctly set. If you are using the AV connection, the TV receiver is not set to the AV mode. 	<p>If you are using the RF connection,</p> <ul style="list-style-type: none"> set the TV receiver to the video channel. perform "Video Channel Set" (☞ pg. 86). <p>If you are using the AV connection, set the TV to its AV mode.</p>
2. Noise appears during visual search.	<ul style="list-style-type: none"> This is normal. 	
3. Noise appears during normal playback.	<ul style="list-style-type: none"> The automatic tracking mode is engaged. 	Try manual tracking. (☞ pg. 25)
4. The playback picture is blurred or interrupted while TV broadcasts are clear or "USE CLEANING CASSETTE" message appears on the screen.	<ul style="list-style-type: none"> The video heads may be dirty. 	Use a dry cleaning cassette ECL-3F, or consult your JVC dealer.
5. Breaks are noticeable in Hi-Fi soundtrack.	<ul style="list-style-type: none"> The automatic tracking mode is engaged. 	Try manual tracking. (☞ pg. 25)

PLAYBACK (DVD deck)

SYMPTOM	POSSIBLE CAUSE	CORRECTIVE ACTION
1. The button do not work.	<ul style="list-style-type: none"> ● The operation is prohibited on the placed disc. 	—
2. The DVD deck can not be operated.	<ul style="list-style-type: none"> ● The DVD deck is not selected. 	<p>On the unit Press S-VHS/DVD repeatedly so that the DVD indicator lights up.</p> <p>On the remote control Press DVD so that the DVD indicator lights up.</p>
3. "⊗" appears on the TV screen.	<ul style="list-style-type: none"> ● The operation is prohibited on the placed disc. 	—
4. "REGION CODE ERROR!" appears on the TV screen.	<ul style="list-style-type: none"> ● The disc's region number does not match that of the unit. 	Use the discs whose region number includes "ALL" or "2". (☞ pg. 5)
5. The disc cannot be played back.	<ul style="list-style-type: none"> ● The disc's region number does not match that of the unit. ● This type of the disc cannot be played back. ● The disc is not placed properly. ● The Parental Lock is engaged, and the placed disc is rated higher than the set level. 	<p>Use the discs whose region number includes "ALL" or "2". (☞ pg. 5)</p> <p>See "Unplayable Discs" (☞ pg. 5).</p> <p>Remove the disc, then place the disc properly in the disc tray. (☞ pg. 7, "Placing a Disc")</p> <p>Release the Parental Lock temporarily (☞ pg. 51), or change the set level (☞ pg. 51).</p>
6. The language is not played back as you set.	<ul style="list-style-type: none"> ● The disc does not contain the language you set. 	—
7. Changing audio/subtitle language is not possible.	<ul style="list-style-type: none"> ● The disc does not contain the audio/subtitle in the multiple languages. 	With some discs, the language should be set on the top menu. (☞ pg. 37)
8. The subtitles do not appears on the TV screen.	<ul style="list-style-type: none"> ● The disc does not contain the subtitles. ● The subtitle display is set to off. ● A-B Repeat Playback is in progress. (☞ pg. 47) 	<p>—</p> <p>Set the subtitles display to on. (☞ pg. 39)</p> <p>The subtitles recorded around A-B point may not appear.</p>
9. Angle cannot be changed.	<ul style="list-style-type: none"> ● The scene is not recorded from the multiple angles. 	—

RECORDING (S-VHS deck)

SYMPTOM	POSSIBLE CAUSE	CORRECTIVE ACTION
1. Recording cannot be started.	<ul style="list-style-type: none"> There is no cassette loaded, or the cassette loaded has had its record safety tab removed. 	Insert a cassette, or using adhesive tape, cover the hole where the tab was removed.
2. TV broadcasts cannot be recorded.	<ul style="list-style-type: none"> "L-1", "L-2", "F-1" or "S-1" has been selected as the input mode. 	Set to the desired channel.
3. Tape-to-tape editing is not possible.	<ul style="list-style-type: none"> The source (another video recorder, camcorder) has not been properly connected. All necessary power switches have not been turned on. The input mode is not correct. 	<p>Confirm that the source is properly connected.</p> <p>Confirm that all units' power switches are turned on.</p> <p>Set the input mode to "L-1", "L-2", "F-1" or "S-1".</p>
4. Camcorder recording is not possible.	<ul style="list-style-type: none"> The camcorder has not been properly connected. The input mode is not correct. 	<p>Confirm that the camcorder is properly connected.</p> <p>Set the input mode to "L-1", "L-2", "F-1" or "S-1".</p>
5. "○" and "▷" on the front display panel won't stop blinking.	<ul style="list-style-type: none"> The end of the tape was reached during recording. 	The programme may not have been recorded in its entirety. Next time make sure you have enough time on the tape to record the entire programme.

TIMER RECORDING (S-VHS deck)

SYMPTOM	POSSIBLE CAUSE	CORRECTIVE ACTION
1. Timer recording won't work.	<ul style="list-style-type: none"> The clock and/or the timer have been set incorrectly. The timer is not engaged. 	<p>Re-perform the clock and/or timer settings.</p> <p>Press ⊕ (TIMER) and confirm that "⊕" is displayed on the front display panel.</p>
2. Timer programming is not possible.	<ul style="list-style-type: none"> Timer recording is in progress. 	Timer programming can't be performed while a timer recording is in progress. Wait until it finishes.
3. "⊕" on the front display panel won't stop blinking.	<ul style="list-style-type: none"> The timer is engaged but there's no cassette loaded. 	Load a cassette with the record safety tab intact.
4. "⊕", "○" and "▷" on the front display panel won't stop blinking.	<ul style="list-style-type: none"> The loaded cassette has had its record safety tab removed. The end of the tape was reached during timer recording. 	<p>Remove the cassette and cover the hole with adhesive tape, or insert a cassette with the record safety tab intact.</p> <p>The programme may not have been recorded in its entirety. Next time make sure you have enough time on the tape to record the entire programme.</p>
5. "⊕" blinks for 10 seconds and the Timer mode is disengaged.	<ul style="list-style-type: none"> ⊕ (TIMER) has been pressed when there are no programs in memory, or the timer record information has been programmed incorrectly. 	Check the programmed data and re-program as necessary, then press ⊕ (TIMER) again.
6. The SHOWVIEW system does not timer-record properly.	<ul style="list-style-type: none"> The unit's channel positions have been set incorrectly. 	Refer to "Guide Program Number Set" (☞ pg. 31) and re-perform the procedure.
7. "○" and "▷" on the front display panel won't stop blinking.	<ul style="list-style-type: none"> The end of the tape was reached during Instant Timer Recording. 	The programme may not have been recorded in its entirety. Next time make sure you have enough time on the tape to record the entire programme.

TIMER RECORDING (S-VHS deck) (cont.)

SYMPTOM	POSSIBLE CAUSE	CORRECTIVE ACTION
8. "△", "○" and "▷" on the front display panel won't stop blinking.	<ul style="list-style-type: none"> • The loaded cassette has had its record safety tab removed. • The end of the tape was reached during Automatic Satellite Programme Recording. 	<p>Remove the cassette and cover the hole with adhesive tape, or insert a cassette with the record safety tab intact.</p> <p>The programme may not have been recorded in its entirety. Next time make sure you have enough time on the tape to record the entire programme.</p>

OTHER PROBLEMS

SYMPTOM	POSSIBLE CAUSE	CORRECTIVE ACTION
1. The image of TV broadcast appears distorted on the TV screen.	<ul style="list-style-type: none"> • The unit leaves turned on and the DVD deck is selected. 	Turn off the unit, or press S-VHS to select the S-VHS deck, then press TV/VCR so that the VCR indicator disappears from the front display panel.
2. Whistling or howling is heard from the TV during camcorder recording.	<ul style="list-style-type: none"> • The camcorder's microphone is too close to the TV. • The TV's volume is too high. 	<p>Position the camcorder so its microphone is away from the TV.</p> <p>Turn the TV's volume down.</p>
3. When scanning channels, some of them are skipped over.	<ul style="list-style-type: none"> • Those channels have been designated to be skipped. 	If you need the skipped channels, restore them. (☞ pg. 80)
4. The channel cannot be changed.	<ul style="list-style-type: none"> • Recording is in progress. 	Press II to pause the recording, change channels, then press ▶ to resume recording.
5. Channel settings that were made manually seem to have changed or disappeared.	<ul style="list-style-type: none"> • After the manual settings were made, Auto Channel Set was performed. 	Perform manual setting again.
6. No channels are stored in the unit's memory.	<ul style="list-style-type: none"> • The TV aerial cable was not connected to the unit when Auto Set Up was performed. • The fully-wired 21-pin SCART cable was not connected between TV and the unit when Preset Download was performed. 	<p>Turn off the unit once and connect the TV aerial cable to the unit properly, then turn on the unit again. Then perform Auto Set Up again. (☞ pg. 13)</p> <p>Turn off the unit once and connect the fully-wired 21-pin SCART cable to the unit properly, then turn on the unit again. Then perform Preset Download again. (☞ pg. 15)</p>

ATTENTION

This unit contains microcomputers. External electronic noise or interference could cause malfunctioning. In such cases, switch the unit off and unplug the mains power cord. Then plug it in again and turn the unit on. Take out the cassette. After checking the cassette, operate the unit as usual.

PLAYBACK

- Q. What happens if the end of the tape is reached during playback or search?**
- A. The tape is automatically rewound to the beginning.
- Q. During search, slow, still and frame-by-frame playback, I can't hear any audio. What's the problem?**
- A. This is normal.
- Q. Can the unit indefinitely remain in the still mode?**
- A. No. It stops automatically after 5 minutes to protect the heads.
- Q. When returning from variable-speed search to normal playback, the picture is disturbed. Should I be concerned about this?**
- A. No, it is normal.
- Q. Noise bar appear during variable-speed search. What's the problem?**
- A. This is normal.
- Q. Sometimes, during Index Search, the unit can't find the programme I want to see. Why not?**
- A. There may be index codes too close together.

RECORDING

- Q. When I pause and then resume a recording, the end of the recording before the pause is overlapped by the beginning of the continuation of recording. Why does this happen?**
- A. This is normal. It reduces distortion at the pause and resume points.
- Q. Can the unit indefinitely remain in the Record-Pause mode?**
- A. No. The unit goes to its Stop mode automatically after 5 minutes to protect the heads.
- Q. What happens if the tape runs out during recording?**
- A. The unit stops recording, and "○" and "▷" on the front display panel won't stop blinking.

TIMER RECORDING

- Q. "○" and "⊖" remain lit on the front display panel. Is there a problem?**
- A. No. This is a normal condition for a timer recording in progress.
- Q. Can I programme the timer while I'm watching a tape or a TV broadcast?**
- A. You won't see the picture as it is replaced by the on-screen menu, but the audio from the programme or tape you're viewing can be heard.

GENERAL

Power requirement	: AC 220 V – 240 V~, 50 Hz/60 Hz
Power consumption	
Power on	: 28 W
Power off	: 5.0 W
Temperature	
Operating	: 5°C to 40°C
Storage	: -20°C to 60°C
Operating position	: Horizontal only
Dimensions (WxHxD)	
	: 435 mm x 98 mm x 357 mm
Weight	: 4.8 kg
Format	: S-VHS/VHS PAL standard
Maximum recording time	
(SP)	: 240 min. with E-240 video cassette
(LP)	: 480 min. with E-240 video cassette
(EP)	: 720 min. with E-240 video cassette

VIDEO/AUDIO (S-VHS deck)

Signal system	: PAL-type colour signal and CCIR monochrome signal, 625 lines 50 fields
Recording system	: DA4 (Double Azimuth) head helical scan system
Signal-to-noise ratio	: 45 dB
Horizontal resolution	
(SP/LP)	: 250 lines (VHS) 400 lines (S-VHS)
(EP)	: 220 lines (VHS) 350 lines (S-VHS)
Frequency range	: 70 Hz to 10,000 Hz (Normal audio) 20 Hz to 20,000 Hz (Hi-Fi audio)
Input/Output	: 21-pin SCART connectors: IN/OUT x 1, IN/DECODER x 1 RCA connectors: VIDEO IN x 1, AUDIO IN x 1, AUDIO OUT x 1 S-Video connector: IN x 1

VIDEO/AUDIO (DVD deck)

Signal system	: PAL
Applicable disc	: DVD (12 cm, 8 cm) CD (12 cm, 8 cm)
Audio characteristics	
DVD	: 4 Hz – 22 KHz
Frequency response	
CD	: 4 Hz – 20 KHz
S/N Ratio	: 90 dB
Harmonic distortion	
	: 0.1 %
Wow and flutter	: Below Measurable Level
Dynamic range	: 90 dB
Output	
Audio	: (RCA) 2 Vrms, 1 Kohm
Digital Audio	: 0.5 Vp-p/75 ohm
Pickup	
CD	
Wavelength	: 775 – 805 nm
Maximum output power	: 0.5 mW
DVD	
Wavelength	: 640 – 660 nm
Maximum output power	: 1.0 mW

TUNER/TIMER (S-VHS deck)

TV channel storage capacity	: 99 positions (+AUX position)
Tuning system	: Frequency synthesized tuner
Channel coverage	: VHF 47 MHz – 89 MHz/ 104 MHz – 300 MHz/ 302 MHz – 470 MHz UHF 470 MHz – 862 MHz
Aerial output	: UHF channels 22 – 69 (Adjustable)
Memory backup time	: Approx. 10 min.

ACCESSORIES

Provided accessories	
	: RF cable, Infrared remote control unit, "R6" battery x 2

Specifications shown are for SP mode unless otherwise specified.

E.& O.E. Design and specifications subject to change without notice.

A		I	
A-B Repeat Playback	47	INDEX	8
About Discs		Index Search	24
MP3	54	Instant Timer Recording (ITR)	27
Placing a Disc	7	J	
Playable Discs	5	Just Clock	16, 84
Region Number	5	L	
Unplayable Discs	5	L-1 OUTPUT	60
Angle Selection (A)	40	L-2 INPUT	61
Angle Selection (B)	40	L-2 SELECT	61
Audio Selection	41	Language	
Auto Channel Set	78	Language Code List	20
Auto Set Up	13	Menu/Audio/Subtitle Language Set	
Automatic Satellite Programme Recording	35	(DVD deck only)	19
C		On-screen Language Set (DVD deck)	19
Change Station Channel Position	81	On-screen Language Set (S-VHS deck)	18
Chapter Search	47	Letter Box	17
Check, cancel and change programmes	34	Locating the start point of the item or skip the item	38
Checking the DVD function status	44	M	
Clock Set	84	Manual Channel Set	80
Connecting To A Dolby Digital Decoder or		Manual Tracking	25
An Amplifier With A Built-in DTS	69	Mode Set (DVD deck)	
Connecting To A Satellite Receiver	66	AUDIO LANGUAGE	19
Connecting/Using A Decoder	68	COMPRESSION	76
D		DIGITAL AUDIO OUT	76
Delete A Channel	81	DOWN MIX	76
Digest	42	MENU LANGUAGE	19
Digital Audio Dubbing	63	MONITOR TYPE	17
Disc menu	37	ON SCREEN GUIDE	77
Disc Time Information	44, 54	ON SCREEN LANGUAGE	19
Dubbing (from DVD to S-VHS)	62	RESUME	77
E		SCREEN SAVER	77
EDITING (DVD DECK)		SUBTITLE	19
Digital Audio Dubbing	63	Mode Set (S-VHS deck)	
EDITING (S-VHS DECK)		AUTO POWER OFF	74
Dubbing (from DVD to S-VHS)	62	AUTO SP→LP TIMER	72
Edit From A Camcorder	58	B.E.S.T.	29, 71
Edit To Or From Another Video Recorder	59	COLOUR SYSTEM	74
Elapsed Recording Time Indication	28	DIRECT REC	72
Express Timer Programming	32	O.S.D.	72
F		PICTURE CONTROL	71
Fine-Tuning Channels Already Stored	82	POWER SAVE	73
G		S-VHS	73
Guide Program Number Set	31	S-VHS ET	71, 73
H		VIDEO STABILIZER	73
High-Speed (Turbo) Search	23	Monitor Set (DVD deck)	
High-Speed Search	38	MONITOR TYPE	17

N		V	
Next Function Memory	25	Video Channel Set	86
O		VPS/PDC Recording	33
OPERATIONS ON DVD DECK	36 – 57	W	
OPERATIONS ON S-VHS DECK	22 – 35	When Receiving A Scrambled Broadcast	81
Output/Input Set	60	Z	
L-1 OUTPUT	60	Zooming	41
L-2 INPUT	61		
L-2 SELECT	61	3D Phonic	43
P			
Pan&Scan	17		
Parental Lock			
Country/Area Code List	52		
To change the settings	51		
To set Parental Lock for the first time	50		
To temporarily release the Parental Lock	51		
Playback (DVD deck)	36 – 49		
Playback (MP3)	55 – 57		
Playback (S-VHS deck)	22 – 25		
Playback Control (PBC) Function	37, 48		
Preset Download	15		
Programme Playback	49, 56		
R			
Random Playback	49, 57		
Record One Programme While Watching			
Another	27		
Recording	26 – 29		
Region Number	5		
Remote Control Functions	64		
Repeat Playback	25, 46, 57		
Resume Function	39		
S			
Set Stations (A)	82		
Set Stations (B)	82		
SHOWVIEW® Timer Programming	30		
Skip Search	24		
Slow Motion	23, 39		
Soundtrack Selection	25		
Still Picture/Frame-By-Frame Playback	23, 38		
Strobe Playback	39		
Subtitle Selection	39		
S-VHS	59		
T			
Tape Position Indicator	10		
Tape Remaining Time	28		
Theater Mode	43		
Time Search	48		
Timer Recording	30 – 35		
Timer Warning Display	10		
Top menu	37		
Track/group selection	55		
Tuner Set	78 – 83		
T-V LINK	21		
TV Station And ID List	83		



Free Manuals Download Website

<http://myh66.com>

<http://usermanuals.us>

<http://www.somanuals.com>

<http://www.4manuals.cc>

<http://www.manual-lib.com>

<http://www.404manual.com>

<http://www.luxmanual.com>

<http://aubethermostatmanual.com>

Golf course search by state

<http://golfingnear.com>

Email search by domain

<http://emailbydomain.com>

Auto manuals search

<http://auto.somanuals.com>

TV manuals search

<http://tv.somanuals.com>