

# JVC

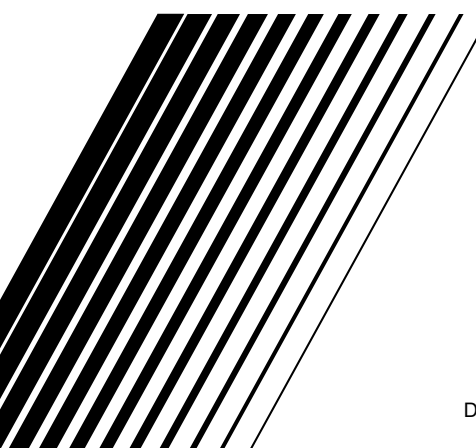

## DVD PLAYER/MEMORY CARD READER **XV-NP1SL**

Before operation	2
Preparations	3
Basic operations	8
Advanced operations	13
Audio/Video files playback	21
Changing the initial settings	26
Additional information	31



## INSTRUCTIONS

### For Customer Use:

Enter below the Model No. and Serial No. which are located on the rear, bottom or side of the cabinet. Retain this information for future reference.

Model No. \_\_\_\_\_

Serial No \_\_\_\_\_

LET0234-001A

[J/UJ]

# Warnings, Cautions and Others

## Mises en garde, précautions et indications diverses

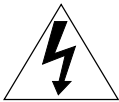

The lightning flash with arrowhead symbol, within an equilateral triangle is intended to alert the user to the presence of uninsulated "dangerous voltage" within the product's enclosure that may be of sufficient magnitude to constitute a risk of electric shock to persons.



The exclamation point within an equilateral triangle is intended to alert the user to the presence of important operating and maintenance (servicing) instructions in the literature accompanying the appliance.

### For U.S.A.

This equipment has been tested and found to comply with the limits for a Class B digital device, pursuant to part 15 of the FCC Rules. These limits are designed to provide reasonable protection against harmful interference in a residential installation.

This equipment generates, uses and can radiate radio frequency energy and, if not installed and used in accordance with the instructions, may cause harmful interference to radio communications. However, there is no guarantee that interference will not occur in a particular installation. If this equipment does cause harmful interference to radio or television reception, which can be determined by turning the equipment off and on, the user is encouraged to try to correct the interference by one or more of the following measures:

Reorient or relocate the receiving antenna.

Increase the separation between the equipment and receiver.

Connect the equipment into an outlet on a circuit different from that to which the receiver is connected.

Consult the dealer or an experienced radio/TV technician for help.

**WARNING: TO REDUCE THE RISK OF FIRE OR ELECTRIC SHOCK, DO NOT EXPOSE THIS APPLIANCE TO RAIN OR MOISTURE.**

### For Canada/pour le Canada

**CAUTION:** TO PREVENT ELECTRIC SHOCK, MATCH WIDE BLADE OF PLUG TO WIDE SLOT, FULLY INSERT

**ATTENTION:** POUR EVITER LES CHOCS ELECTRIQUES, INTRODUIRE LA LAME LA PLUS LARGE DE LA FICHE DANS LA BORNE CORRESPONDANTE DE LA PRISE ET POUSSER JUSQU'AU FOND

### For Canada / Pour le Canada

THIS DIGITAL APPARATUS DOES NOT EXCEED THE CLASS B LIMITS FOR RADIO NOISE EMISSIONS FORM DIGITAL APPARATUS AS SET OUT IN THE INTERFERENCE-CAUSING EQUIPMENT STANDARD ENTITLED "DIGITAL APPARATUS," ICES-003 OF THE DEPARTMENT OF COMMUNICATIONS.

CET APPAREIL NUMERIQUE RESPECTE LES LIMITES DE BRUITS RADIOELECTRIQUES APPLICABLES AUX APPAREILS NUMERIQUES DE CLASSE B PRESCRITES DANS LA NORME SUR LE MATERIEL BROUILLEUR: "APPAREILS NUMERIQUES", NMB-003 EDICTEE PAR LE MINISTRE DES COMMUNICATIONS.

### CAUTION

To reduce the risk of electrical shocks, fire, etc.:

1. Do not remove screws, covers or cabinet.
2. Do not expose this appliance to rain or moisture.

### ATTENTION

Afin d'éviter tout risque d'électrocution, d'incendie, etc.:

1. Ne pas enlever les vis ni les panneaux et ne pas ouvrir le coffret de l'appareil.
2. Ne pas exposer l'appareil à la pluie ni à l'humidité.

### Caution — STANDBY/ON $\odot$ /I button!

Disconnect the mains plug to shut the power off completely (the STANDBY/ON lamp goes off). The STANDBY/ON  $\odot$ /I button in any position does not disconnect the mains line.

- When the player is on standby, the STANDBY/ON lamp lights red.
- When the player is turned on, the STANDBY/ON lamp lights green. The power can be remote controlled.

### Attention — Touche STANDBY/ON $\odot$ /I!

Déconnectez la prise d'alimentation secteur pour mettre l'appareil complètement hors tension (le témoin STANDBY/ON s'éteint). La touche STANDBY/ON  $\odot$ /I, sur n'importe quelle position, ne peut pas déconnecter l'appareil du secteur.

- Quand l'appareil est en mode de veille, le témoin STANDBY/ON est allumé en rouge.
- Quand l'appareil est sous tension, le témoin STANDBY/ON est allumé en vert.

L'alimentation peut être télécommandée.

### IMPORTANT FOR LASER PRODUCTS IMPORTANT POUR LES PRODUITS LASER

1. CLASS 1 LASER PRODUCT
  2. **DANGER:** Visible laser radiation when open and interlock failed or defeated. Avoid direct exposure to beam.
  3. **CAUTION:** Do not open the top cover. There are no user serviceable parts inside the Unit; leave all servicing to qualified service personnel.
1. PRODUIT LASER CLASSE 1
  2. **ATTENTION:** Radiation laser visible quand l'appareil est ouvert ou que le verrouillage est en panne ou désactivé. Eviter une exposition directe au rayon.
  3. **ATTENTION:** Ne pas ouvrir le couvercle du dessus. Il n'y a aucune pièce utilisable à l'intérieur. Laisser à un personnel qualifié le soin de réparer votre appareil.

### CAUTION:

- Do not block the ventilation openings or holes.  
(If the ventilation openings or holes are blocked by a newspaper or cloth, etc., the heat may not be able to get out.)
- Do not place any naked flame sources, such as lighted candles, on the apparatus.
- When discarding batteries, environmental problems must be considered and local rules or laws governing the disposal of these batteries must be followed strictly.
- Do not expose this apparatus to rain, moisture, dripping or splashing and that no objects filled with liquids, such as vases, shall be placed on the apparatus.

### ATTENTION

- Ne bloquez pas les orifices ou les trous de ventilation.  
(Si les orifices ou les trous de ventilation sont bloqués par un journal un tissu, etc., la chaleur peut ne pas être évacuée correctement de l'appareil.)
- Ne placez aucune source de flamme nue, telle qu'une bougie, sur l'appareil.
- Lors de la mise au rebut des piles, veuillez prendre en considération les problèmes de l'environnement et suivre strictement les règles et les lois locales sur la mise au rebut des piles.
- N'exposez pas cet appareil à la pluie, à l'humidité, à un égouttement ou à des éclaboussures et ne placez pas des objets remplis de liquide, tels qu'un vase, sur l'appareil.

## Supplied accessories

Check that you have all the following accessories supplied to you. If anything is missing, consult your dealer immediately.

- Audio/video cable (Yellow/White/Red) (× 1)
- Remote control unit (× 1)
- R6P(SUM-3)/AA(15F) battery (× 2)
- AC power plug adaptor (× 1) (for PX model ONLY)

## About this manual

- The display window information and OSD (On Screen Display) menu items are put in brackets [ ] in the operation procedures.
- Usable disc(s) for each operation/function is (are) referred to by the icons;



## Precautions

### Notes on the power cord

- When you are away on travel or otherwise for an extended period of time, remove the plug from the wall outlet. A small amount of power (2.7 W; 3.0 W for PX model) is always consumed while the power cord is connected to the wall outlet.
- When unplugging the player from the wall outlet, always pull the plug, not the power cord.
- Do not handle the power cord with wet hands!

### Avoid moisture, water and dust

- Do not place the player in moist or dusty places.
- If water gets inside the player, turn off the power and remove the plug from the wall outlet, then consult your dealer. Using the player in this state may cause a fire or electrical shock.

### Avoid high temperatures

- Do not expose the player to direct sunlight or place it near a heating device.

### Notes on installation

- Select a place which is level, dry and neither too hot nor too cold between 5° C and 35° C (41° F and 95° F).
- Leave sufficient distance between the player and the TV.
- Do not install the player in a place subject to vibrations.
- Do not put heavy objects on the player.

### To prevent malfunction of the player

- There are no user-serviceable parts inside. If anything goes wrong, unplug the power cord and consult your dealer.
- Do not insert any metallic objects, such as wires, hairpins, coins, etc. into the player.
- Do not block the vents. Blocking the vents may damage the player.

### To clean the cabinet

- Use a soft cloth. Follow the relevant instructions on the use of chemically-coated cloths.
- Do not use benzene, thinner or other organic solvents and disinfectants. These may cause deformation or discoloring.

## Table of contents

Supplied accessories.....	1
About this manual .....	1
Precautions .....	1
Table of contents.....	1

## Before operation..... 2

About playable media .....	2
----------------------------	---

## Preparations .....

Connections.....	3
Using the remote control unit.....	6
Care and handling of discs .....	6

## Basic operations .....

Turning on/off the player.....	8
Initial setup .....	8
Basic playback.....	9
Resuming playback .....	10
Various speed playback .....	11
Locating the beginning of a scene or song.....	12

## Advanced operations..... 13

Playing from a specific position .....	13
Changing the playback order.....	15
Repeat playback.....	16
Changing the language, sound and scene angle .....	17
Special picture/sound effect .....	18
Menu bar functions .....	19

## Audio/Video files playback..... 21

Outline .....	21
Basic operations .....	22
Direct selection for JPEG files .....	23
Repeat playback.....	23
Slide show playback .....	24
Music slide show playback .....	25
Changing the picture of the opening display .....	25

## Changing the initial settings .....

Selecting preferences.....	26
Limiting playback by children.....	29

## Additional information .....





Names of parts and controls.....	31
AV COMPU LINK remote control system .....	33
Troubleshooting .....	34
Specifications .....	35
Appendix A: Country/Area code list for Parental Lock.....	36
Appendix B: Table of languages and their abbreviations .....	37
Appendix C: Digital output signal chart.....	37
Appendix D: Glossary.....	38

# Before operation

## About playable media

### Playable disc types

Discs with the following marks can be played back on the player.

DVD VIDEO	SVCD	Video CD	Audio CD
			

The DVD Logo is a trademark.

The player can also play back the following discs:

- DVD-R and DVD-RW discs written in the DVD VIDEO format and finalized.
- CD-R and CD-RW discs written in the SVCD, Video CD or Audio CD format and finalized.
- CD-R and CD-RW discs written in MP3/WMA/JPEG/MPEG-4 in accordance with the "ISO 9660" format. (For details, see page 21.)

#### NOTE

If a disc gets dirty, scratched or warped, or due to the disc characteristics or recording conditions, it may take considerable time for the player to read the content, or the player may not be able to play back such discs.

The player can play back audio signals recorded in MIX-MODE CD, CD-G, CD-EXTRA and CD TEXT.

### Region code of DVD VIDEO

This player can play back DVD VIDEO discs whose region code numbers include "1."

Examples of playable DVD VIDEO discs:



#### NOTE

The player's region code is printed on the rear of the player.

### Color system format

This player accommodates the NTSC system, and also can play back discs recorded with PAL system whose Region Code numbers include "1."

Note that the PAL video signal on a disc is converted to an NTSC signal and output.

### Digital audio formats

The player supports the following digital audio formats (see page 38 "Glossary" for descriptions of each audio format):

Linear PCM, Dolby Digital, DTS (Digital Theater Systems)

#### NOTE

Depending on the player's [DIGITAL AUDIO OUTPUT] setting, digital audio signals may not be output as they are recorded on the disc. See "DIGITAL AUDIO OUTPUT" on page 28 for details.

### Notes on discs

- With some DVD VIDEO discs, the player starts playback automatically after inserting the disc.
- The image may be sometimes poor or noisy due to defects in the disc itself.
- With some discs, operations described in this manual may not be possible.

### Unplayable discs

The player does not play back discs listed below. If you try to play back these discs, noise may generate causing damage to speakers.

- DVD-RW discs written in the VR format
- DVD-ROM, DVD-RAM, DVD AUDIO, CD-ROM, PHOTO CD, SACD

In addition, the player does not play:

- Unfinalized discs
- Discs of irregular shape or discs with tape, seals or paste on either the label side or playback side. Playing back these discs may damage the player.

### Playable memory cards

This player has two types of the exclusive insertion slot for the memory cards; one is the 4 in 1 slot for SD card (SD), Multi Media Card (MMC), SmartMedia (SM), and Memory Stick (MS), the other for CompactFlash (CF).

You can play back the following files:

- MP3, WMA, JPEG, and MPEG-4 (simple profile/asf format)

### Requirements for memory cards

- Format: Fat 12/16
- Voltage type: 5 V type is available except SmartMedia.
- Storage type: Up to 128 MB (256 MB type is also available for only SD card and CompactFlash).
- Protection: Secure MMC card and Magic Gate Memory Stick are not available.
- For CompactFlash: Type I
- For Memory Stick: Memory Stick Pro is not available.

#### NOTES

- The playback order may differ from that of the other device such as a digital still/video camera.
- The memory cards initialized by PC are not available.
- The player may be unable to play back some CompactFlash which are available for the high speed reading/writing.
- The player may be unable to play back some memory cards due to their characteristics or recording conditions.
- Memory cards are precision instruments. DO NOT impact, bend, drop, or wet them.

SD, Secure SD, MultiMediaCard, SmartMedia, CompactFlash, Memory Stick are trademarks of their respective product companies.

#### Notes on copyright

Check the copyright laws in your country before recording from DVD VIDEO, SVCD, Video CD, Audio CD, MP3, WMA, JPEG, and MPEG-4 discs.

Recording of copyrighted material may infringe copyright laws.

This product incorporates copyright protection technology that is protected by method claims of certain U.S. patents and other intellectual property rights owned by Macrovision Corporation and other rights owners. Use of this copyright protection technology must be authorized by Macrovision Corporation, and is intended for home and other limited viewing uses only unless otherwise authorized by Macrovision Corporation. Reverse engineering or disassembly is prohibited.

# Preparations

## Connections

Before using the player, connect the player to a TV and/or amplifier.

### Before making connections

- Do not connect the AC power cord until all other connections have been made.
- Connect VIDEO OUT of the player directly to the video input of your TV. Connecting VIDEO OUT of the player to a TV via a VCR may cause a monitor problem when playing back a copy-protected disc. You may also have a monitor problem when connecting the player to an integrated TV/Video system.

#### NOTE

If your TV has an AV COMPU LINK terminal, you can use the AV COMPU LINK function. See "AV COMPU LINK remote control system" on page 33 for details.

- In the following description, "TV" may be substituted with "monitor" or "projector."
- Terminal names used for other components may be different from those used in the following description.

## Connecting to a TV

The following sections A to C describe TV connections where only a TV is connected to the player so that you will hear audio from the TV.

#### NOTE

If your TV has a monaural audio input instead of stereo, you need to use an optional audio cable which converts stereo audio output to monaural.

Preparations

### A Connecting to a conventional TV

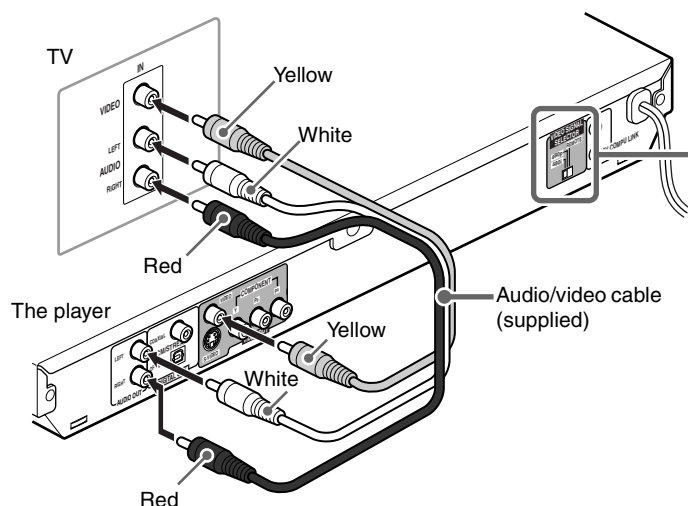

Set the VIDEO SIGNAL SELECTOR to "480i."

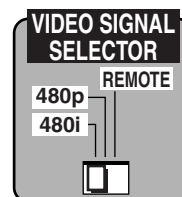

### B Connecting to a TV with an S-video jack

If your TV has an S-VIDEO input, you can get better picture quality by connecting it with the S-VIDEO output of the player using an S-video cable instead of connecting the video input of the TV to the VIDEO jack of the player.

#### NOTE

When using the S-VIDEO output jack, do not connect the COMPONENT VIDEO OUT jacks on the player.

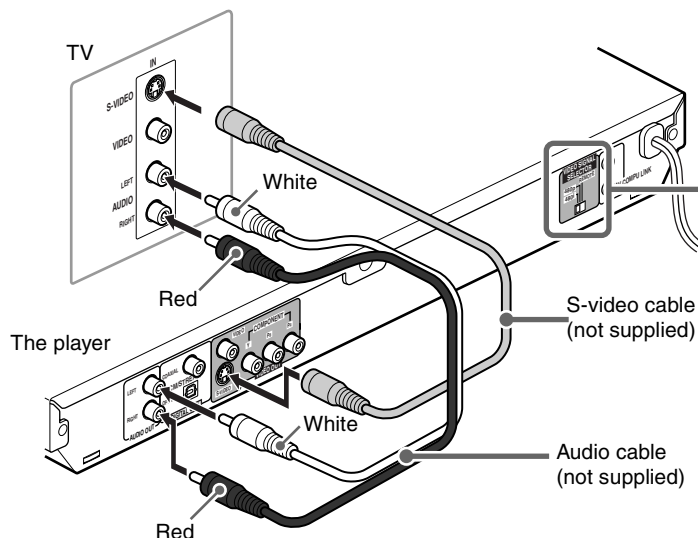

Set the VIDEO SIGNAL SELECTOR to "480i."

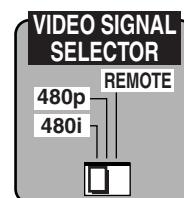

## Preparations

### © Connecting to a TV with component jacks.

You can enjoy picture of high-fidelity color reproduction by connecting the COMPONENT VIDEO OUT jacks on the player to your TV.

#### NOTES

- Connect "Y" to "Y", "PB" to "PB" (C<sub>B</sub>), "PR" to "PR" (C<sub>R</sub>) correctly.
- If your TV has component video input jacks of BNC type, use an adapter which converts a pin jack to a BNC jack (not supplied).

#### Progressive scan video playback available

In the Progressive scanning mode, you can enjoy high quality picture with less flickers when the COMPONENT VIDEO OUT jacks are connected to a TV or monitor that supports the progressive video input.

#### About the scanning mode

Depending on the material source format, DVD VIDEO discs can be classified into two types; film source and video source (note that some DVD VIDEO discs contain both film source and video source). Film sources are recorded as 24-frame-per-second information, while (NTSC) video sources are recorded as 30-frame-per-second (60-field-per-second interlaced) information.

When the player plays back a film source material, uninterlaced progressive output signals are created using the original information. When a video source material is played back, the player interleaves lines between the interlaced lines on each to create the interpolated picture and outputs as the progressive signal.

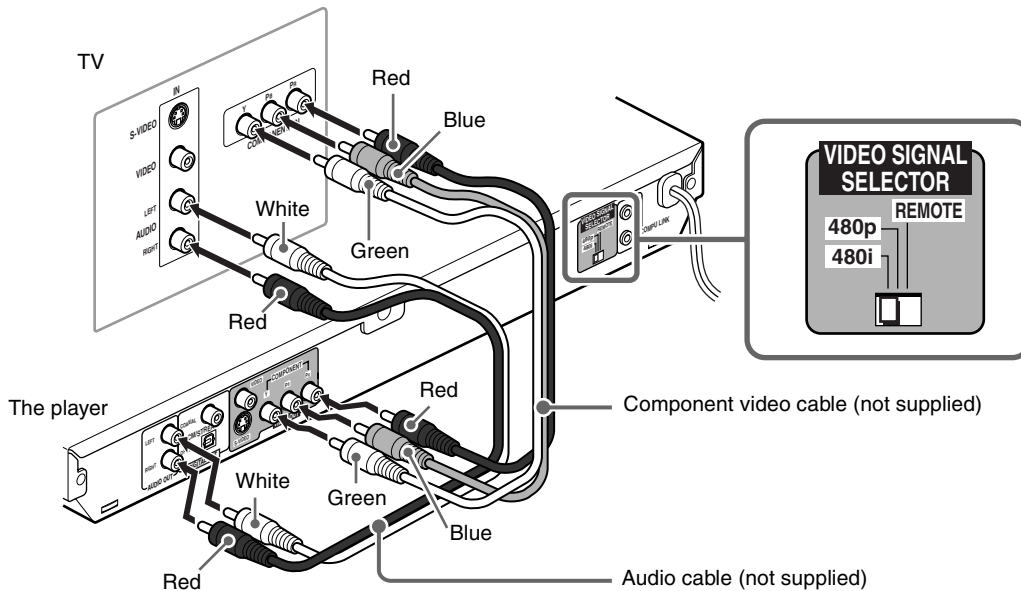

#### Selecting the VIDEO SIGNAL SELECTOR position

- If your television equipped with component jacks does not support the progressive scanning mode  
Set the VIDEO SIGNAL SELECTOR to "480i."
- If your television equipped with component jacks supports the progressive scanning mode  
Set the VIDEO SIGNAL SELECTOR to "480p."
- If you want to select the scanning mode between the interlace and progressive modes (depending on the source condition, or when connecting more than one television, etc.)  
Set the VIDEO SIGNAL SELECTOR to "REMOTE."  
Thus you can select the mode from the remote control unit.

#### NOTE

You must change the VIDEO SIGNAL SELECTOR position while the player power is off. Otherwise, the changed setting is not effective.

#### Activating the Progressive scanning mode using the remote control unit

When the player is turned on and the VIDEO SIGNAL SELECTOR is set to "REMOTE," press and hold down VFP - PROGRESSIVE SCAN for a few seconds. The scanning mode switches between the Progressive scanning and Interlaced scanning modes.

When the scanning mode is set to the Progressive mode, the PROGRESSIVE indicator on the front panel turns on. Depending on the [PICTURE SOURCE] setting on the [PICTURE] preference display (see page 27) and whether the current DVD VIDEO disc is film-source or video-source, the color of the indicator differs, as shown in the table below.

Setting of [PICTURE SOURCE]	Source type of DVD VIDEO	
	Film source	Video source
AUTO	Green	Red
FILM	Green	Green
VIDEO (NORMAL)/ (ACTIVE)	Red	Red

\* While stopped in the Progressive scanning mode, the PROGRESSIVE indicator is lit in red regardless of the [PICTURE SOURCE] selection.

#### NOTES

- The Progressive scanning mode works only when you connect the player's COMPONENT VIDEO OUT jacks to a progressive TV.
- There are some progressive TV and High-Definition TV sets that are not fully compatible with the player, resulting in the unnatural picture when playing back a DVD VIDEO disc in the Progressive scanning mode. In such a case, use the Interlaced scanning mode. To check the compatibility of your TV set, contact your local JVC customer service center.
- All JVC progressive TV and High-Definition TV sets are fully compatible with the player (Example: AV-61S902).

## Connecting to optional audio equipment

### Connecting to a stereo audio amplifier/receiver

Connect the player's AUDIO OUT (LEFT/RIGHT) jacks to any line-level inputs (such as AUX, DVD, CD, etc.) of an audio amplifier or receiver.

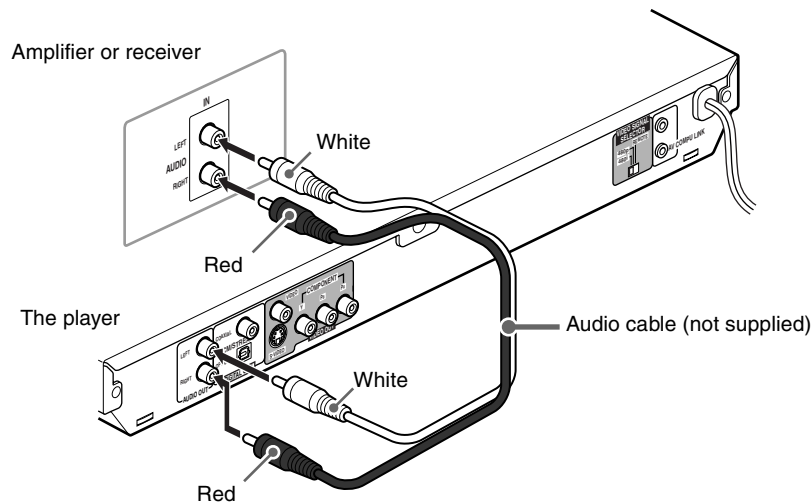

### Connecting to a digital audio device

You can enjoy sound of enhanced quality by connecting the player's DIGITAL OUT (either OPTICAL or COAXIAL) jack to a digital input of an amplifier, etc., using an optical or coaxial digital cable. The digital audio signal on a disc will be transferred directly from the player. If the connected digital audio equipment is a Dolby Digital or DTS decoder or an amplifier with a built-in decoder, you can enjoy high-quality surround sound.

#### NOTES

- Connect the player and the digital audio device by using either an optical digital cable or a coaxial digital cable.
- It is not recommended to use the digital jacks for dubbing. When recording the sounds (DVD VIDEO, SVCD, Video CD or Audio CD) played back on the player, record them through the analog jacks.
- Depending on the disc, no signal may be output from the DIGITAL OUT. Make an analog connection in this case.
- Set **[DIGITAL AUDIO OUTPUT]** in the **[AUDIO]** preference display correctly according to the connected digital audio equipment. If setting made for **[DIGITAL AUDIO OUTPUT]** is incorrect, loud noise may be generated causing damage to the speakers (see page 28).

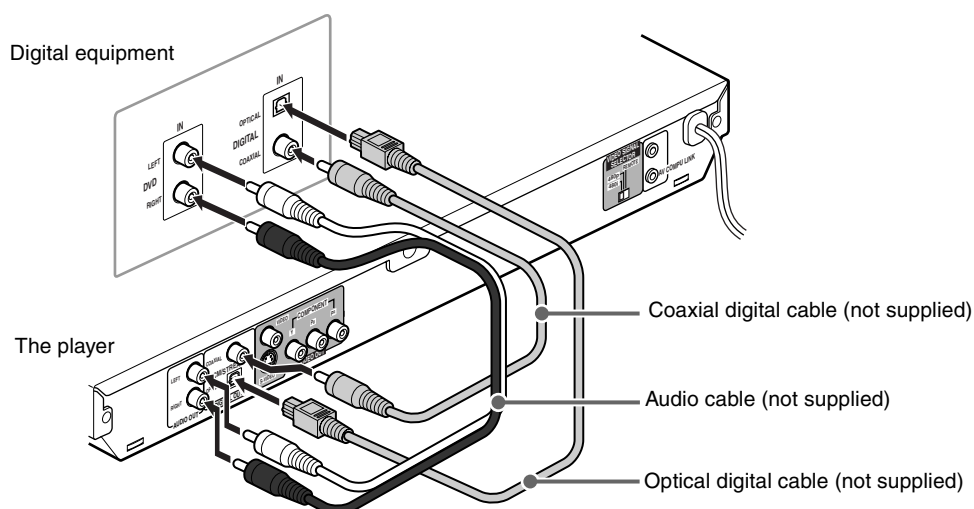

## Preparations

### Connecting the power cord

When all the audio/video connections have been made, connect the AC power plug to the wall outlet. Make sure that the plugs are inserted firmly.

The STANDBY indicator lights in red.

#### NOTE

(ONLY for PX model)

Use the supplied AC power plug adaptor when inserting the larger plug to the wall outlet.



#### Warning

- Disconnect the power cord:
  - if you are not going to use the player for a long time.
  - before cleaning the player.
  - before moving the player.
- Do not:
  - connect or disconnect the power cord with wet hands.
  - pull the power cord when disconnecting it, as this may damage the cord and cause fire, electric shock, or other accidents.



#### Caution

- Do not alter, twist or pull the power cord, or put anything heavy on it, which may cause fire, electric shock, or other accidents.
- If the cord is damaged, consult a dealer and have the power cord replaced with a new one.

### Using the remote control unit

#### To install batteries

Open the compartment cover, and place the two supplied R6P (SUM-3)/AA(15F) batteries in the remote control unit according to the polarity markings (“+” and “-”) inside the compartment. Then replace the cover.

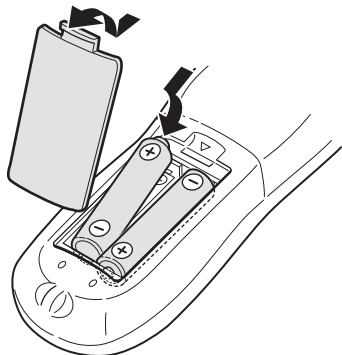

The batteries will last about six months with normal use. If the functions of the remote control unit become erratic, replace the batteries.

#### Precautions of the safe use of batteries

Observe the following precautions for the safe use of batteries. If they are used improperly their lives will be shortened, they may burst or their contents may leak.

- Remove the batteries from the remote control unit if it is not going to be used for a long period of time.
- Remove dead batteries and dispose of them properly.
- Never leave dead batteries lying around, take them apart, mix them with other refuse, or throw them into an incinerator.
- Never touch liquid that has leaked out of a battery.
- Do not mix new and old batteries, or batteries of different types, when replacing them.

### Remote sensor

Point the top of the remote control unit toward the remote sensor as directly as possible. If you operate it from a diagonal position, the operating range (approx. 5 m) may be shorter.

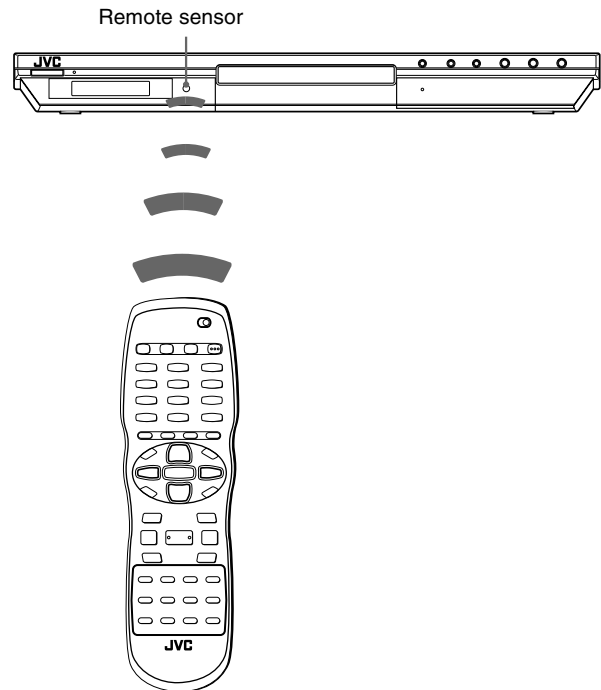

### Care and handling of discs

If a disc gets dirty, dusty, scratched or warped, playback sound and picture may be deteriorated. Take proper precautions when handling discs.

#### Handling

- Do not touch the surface of the disc.
- Do not damage, stick paper to, or use any adhesive on either the label side or playback side.

#### Storing discs

- Keep discs in their cases. If discs are piled on top of one another without their protective cases, they can be damaged.
- Do not put discs in a location where they may be exposed to direct sunlight, or where the humidity or temperature is high. Avoid leaving discs in a car!

#### Cleaning discs

- Wipe with a soft dry cloth, moving from the center outwards. If a disc is difficult to clean, wipe with a cloth moistened with water.

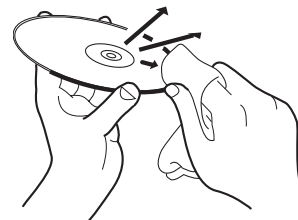

- Never use record cleaners, petrol, alcohol or any anti-static agents.



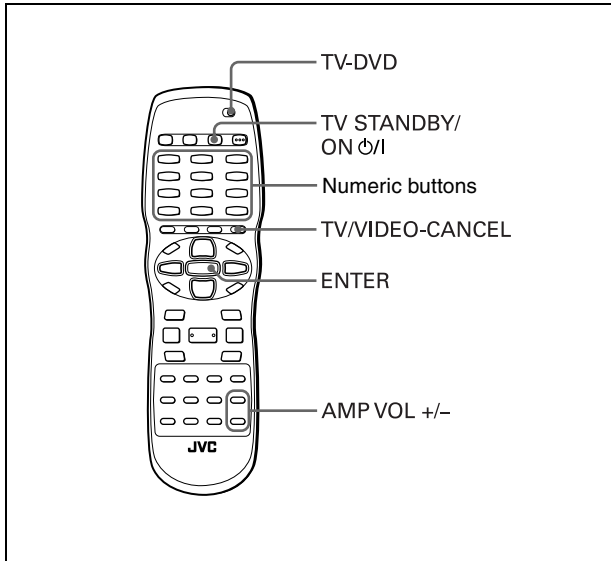

## To use the remote control unit for TV operation

### Setting the remote control signal for operating your TV

**1** Set the TV - DVD switch to "TV."

**2** While holding down TV/VIDEO - CANCEL, enter the manufacturer code of your TV listed below by using the numeric buttons (0 to 9), and then press ENTER.

**Example:**

To enter the manufacturer code "01": Press "0," "1," then ENTER.

**Manufacturer code list**

Manufacturer	No.	Manufacturer	No.
AIWA	36	MIVAR	29
BEIJING	22	NEC	20
CCE	02	NOBLEX	22
CHANGHONG	34	NOKIA	31
DAEWOO	17, 37	PANASONIC	04, 11
FERGUSON	27	PEONY	34, 38, 39
FINLUX	30	PHILCO	10, 17, 21
FUNAI	32	PHILIPS	02
GRADIENTE	15, 20	RCA	05
GRUNDIG	19	SAMSUNG	12, 33, 34, 35
HITACHI	10		
ITT	28	SANYO	13, 16
JINXING	38	SEARS	13
JVC	01, 23, 24, 25	SHARP	06
		SONY	07
KONKA	40	TCL	41
LG (GOLDSTAR)	18	THOMSON	26
MAGNAVOX	02	TOSHIBA	08, 14
MITSUBISHI	03	ZENITH	09

**3** Release TV/VIDEO - CANCEL.

**4** Try to operate the TV by pressing TV STANDBY/ON OFF.

If your TV turns on or off, you have successfully set the control signal.

**NOTES**

- When you purchased the player the manufacturer code is set to "JVC" (01).
- If there is more than one code listed for the manufacturer of your TV, try them one by one until you succeed.

### Operating the TV

Set the TV - DVD switch on the remote control unit to "TV."



The following buttons can be used for operating the TV.

	Turns the TV on or off.
	Switches the TV input mode between TV and VIDEO.
	Selects the TV channels directly. *For some TVs, pressing "+10" functions as the "100+," while "10" functions as the ENTER button if your TV requires pressing the ENTER button after selecting a channel number.
	Mutes the TV sound.
	Changes the TV channels.
	Adjusts the TV sound volume.

### To control the volume of a JVC's amplifier or receiver

Pressing the AMP VOL + button raises the audio volume of a JVC's amplifier or receiver, while pressing the - button lowers the volume.

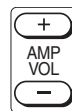

Preparations

# Basic operations

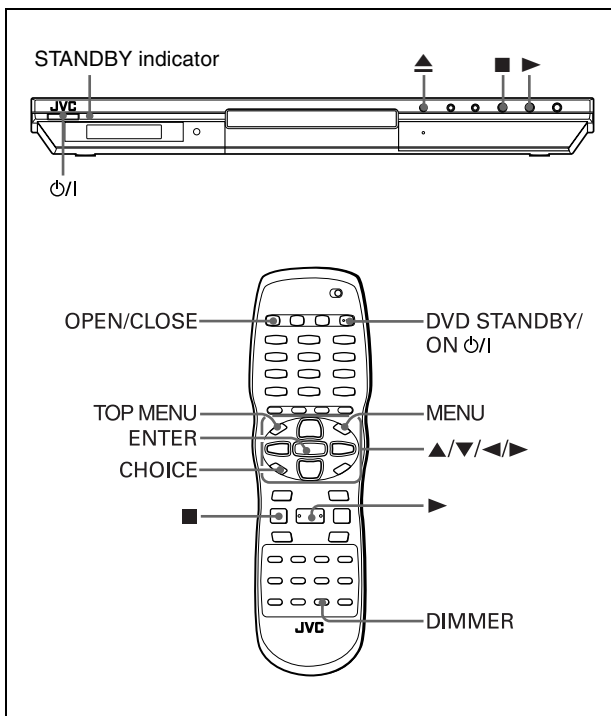

## NOTE



Make sure that the TV - DVD switch on the remote control unit is set to "DVD" when using the  $\blacktriangle/\blacktriangledown/\blacktriangleleft/\blacktriangleright$  and numeric buttons for controlling the player.

## About invalid operation icon

When you press a button, and if the player does not accept its operation,  $\odot$  appears on your TV screen. Operations are occasionally unacceptable even if  $\odot$  is not displayed. Note that some operations may not be accepted. For example, some discs may not allow rapid advance/reverse or slow-motion playback.

## Turning on/off the player

**Press DVD STANDBY/ON  $\odot/\text{I}$  on the remote control unit or press  $\odot/\text{I}$  on the front panel.**

The STANDBY/ON indicator on the front panel, which lights in red during standby, lights in green. The left and right sides of the display window are illuminated.

The opening display appears on the TV screen, and the following messages may appear at the bottom of the opening display.

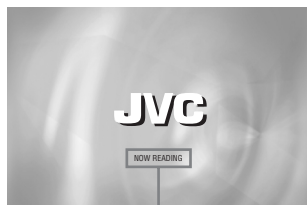

Message area

- NOW READING (The player is reading the disc information.)
- REGION CODE ERROR! (The region code of the DVD VIDEO disc does not match the player. The disc cannot be played back.)
- CANNOT READ THIS DISC

- OPEN
- CLOSE
- NO DISC

## NOTES

- Even if you turn off the player, the player is not disconnected from the AC power source as long as it is connected to the wall outlet. This state is called standby mode. In this state, the player consumes a very small amount of power.
- You can change the picture of the opening display. (See page 25.)

## Initial setup

You can set the display language, TV monitor type and digital output before using the player, by following the procedure below.

### 1 Press CHOICE for a few seconds to bring up the first page of the DVD PLAYER SET UP display.

The pull-down menu of the [ON SCREEN LANGUAGE] is already open.

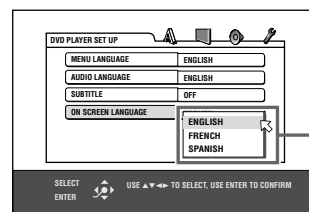

ON SCREEN LANGUAGE options

### 2 Press $\blacktriangle/\blacktriangledown$ to select the desired language.

You can select the on-screen language for the preference displays, etc. from among ENGLISH, FRENCH, and SPANISH.

### 3 Press ENTER.

The second page is shown, in which the pull-down menu of the [MONITOR TYPE] is already open.

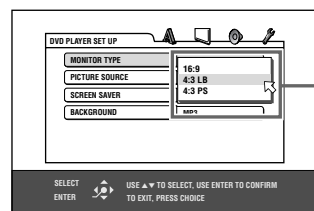

MONITOR TYPE options

### 4 Press $\blacktriangle/\blacktriangledown$ to select the desired monitor type.

For a normal (conventional) TV, select [4:3 LB] or [4:3 PS]. For a wide-screen TV, select [16:9]. (See page 27.)

**5 Press ENTER.**

The third page is shown, in which the pull-down menu of the [DIGITAL AUDIO OUTPUT] is already open.

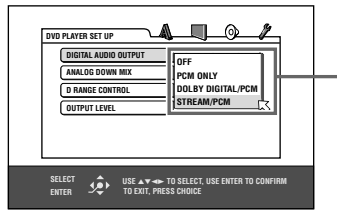

DIGITAL AUDIO OUTPUT options

**6 Press ▲/▼ to select a desired output signal type.**

Set this item correctly when you connect the player to an external surround decoder or D/A converter. See "DIGITAL AUDIO OUTPUT" on page 28. (If you do not connect the player to such a device, you do not have to set this item.)

- When connecting to other digital device, select [PCM ONLY].
- When connecting to a Dolby Digital decoder, select [DOLBY DIGITAL/PCM].
- When connecting to a Dolby Digital decoder/DTS decoder/MPEG decoder, select [STREAM/PCM].

**7 Press ENTER.**

The TV screen returns to the opening display.

**To change the brightness of the display window**

Press DIMMER on the remote control unit.

You can select the display window brightness from three levels, or off.

If the brightness is set to off, nothing will be shown on the display. In this case, the illumination lamp on the front panel is also turned off.

**Basic playback**

**1** Press ▲ (or OPEN/CLOSE on the remote control unit) to open the disc tray.

**2** Place a disc in the disc tray.

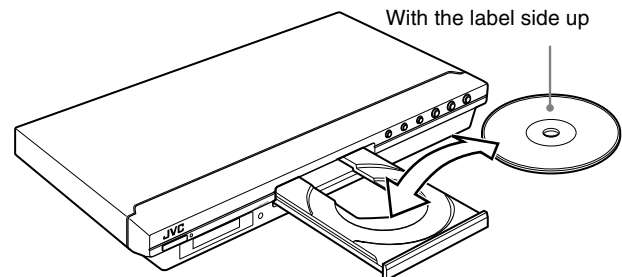

- To insert an 8-cm disc, place it in the inner recess.

**3 Press ►.**

The player starts playback from the beginning.

**If a menu is shown on the TV screen**

When inserting a DVD VIDEO, SVCD or Video CD disc, a menu may be shown on the TV screen. From the menu, you can select a desired item to be played back.

**For DVD VIDEO**

- 1 Press ▲/▼/◀/▶ to select a desired item.
- 2 Press ENTER.

The player starts playback of the selected item.

**For SVCD/Video CD**

Press the numeric buttons to select a desired item. The player starts playback of the selected item.

**NOTES**

- Do not insert an unplayable disc. (See page 2.)
- When inserting a disc on the disc tray, be sure to position the disc inside the recess. Otherwise, the disc may be damaged when the disc tray is closed, or you may not be able to remove the disc from the player.

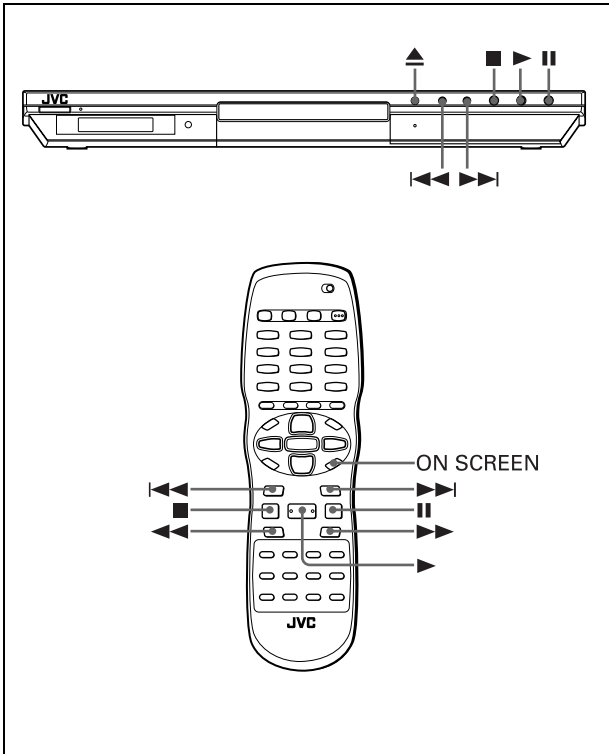

## About On-screen guide icons

You may see the following icons displayed over the picture. They have the following meanings.

- : Appears at the beginning of a scene recorded from multiple angles (see page 17).
- : Appears at the beginning of a scene recorded with multiple audio languages (see page 17).
- : Appears at the beginning of a scene recorded with multiple subtitle languages (see page 17).

## Resuming playback



The player can memorize the position on a disc where you interrupt playback, and resume playback from that position later. There are three resume modes; ON, OFF and DISC RESUME. The mode is initially set to ON when you purchased the player.

- You can select the mode using the preference display (see page 28).

### When the resume mode is “ON”

When you press ■, the player stops playback and memorizes the interrupted position. The TV screen shows “RESUME STOP” and the RESUME indicator lights up in the display window.

The memory of the interrupted position is not cleared if you turn off the player.

When you turn off the player after setting the resume function, simply press ▶. The player is turned on, and playback starts from the interrupted position.

Note that the memory is cleared if you open the disc tray.

### When the resume mode is “DISC RESUME”

When you press ■, the player stops playback and memorizes the interrupted position. The TV screen shows “RESUME STOP” and the RESUME indicator lights up in the display window.

The memory of the interrupted position is not cleared if you open the disc tray or turn off the player.

### Hint

The player memorizes interrupted positions for the last 30 discs played. Storing a new interrupted position will erase the interrupted position stored for the first disc.

### To clear the memory

Press ■ while the disc is stopped.

## To check the playback status

You can see the current selection number (the title/chapter number for DVD VIDEO or track number for SVCD/Video CD/Audio CD), time information (the track or chapter time while stopped, or elapsed track or chapter time during playback) and the transport status (stop, playback, pause, etc.) on the TV screen.

### Press ON SCREEN.

Example: for DVD VIDEO

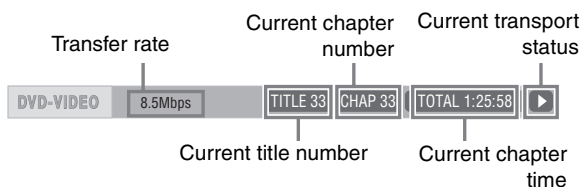

Note that pressing ON SCREEN again brings up the menu bar under the status bar, from which you can access various functions. See page 19 for details about the menu bar.

### To turn off the status bar

Press ON SCREEN repeatedly until the status bar goes off.

## To stop playback completely

Press ■.

### Hint

If you press ▲ during playback, the player stops playback and opens the disc tray.

## To stop playback temporarily

Press II.

To resume playback, press ▶. (See the following item.)

## To resume playback

### When the resume mode is “ON”

**While the disc you interrupted playback is still on the disc tray, press ►.**

The player resumes playback from the position where playback was interrupted. The TV screen shows “RESUME PLAY.”

#### To play back from the beginning

Press ■ before pressing ► to start playback.

### When the resume mode is “DISC RESUME”

**1 Press ▲ to insert a disc for which the player has stored an interrupted position.**

The TV screen shows “RESUME STOP.”

**2 Press ►.**

The TV screen shows “RESUME PLAY” and the player resumes playback from the position where playback was interrupted.

#### To play back from the beginning

After inserting the disc, press ■ before pressing ► to start playback.

#### NOTES

- If you change the [RESUME] setting from [DISC RESUME] to [OFF] or [ON], you cannot resume playback of a disc whose “resuming” position is stored. However, when you again set [RESUME] to [DISC RESUME], you will then be able to resume playback of the disc.
- When you resume playback, set the [RESUME] setting to [DISC RESUME] before removing a loaded disc.
- If you interrupt the playback of a disc for which an interrupted position has already been stored, the memory will be updated with the new interrupted position.
- For a double-sided DVD VIDEO disc, the player regards each side as a different disc. Therefore, to resume playback of such a disc, the disc must be inserted with the same side down.
- When the player memorizes an interrupted point for a disc, it also memorizes Audio, Subtitle and Angle settings.
- The player may not resume playback exactly from the interrupted point. In the case of an SVCD/Video CD disc with PBC function, the player may resume playback from a point slightly earlier or later than the point where playback was interrupted.
- When you change Video CD playback mode to program or random play, the memory of the interrupted position goes off, then the player cannot resume playback.
- Pressing DVD/CARD cancels the memory of the interrupted position of the playback.

## Various speed playback

### To advance or reverse playback rapidly while monitoring



**During playback, press ►► or ◀◀ on the remote control unit.**

You can select from 2 times (1.5 times for only the forward playback of DVD VIDEO), 5 times, 20 times and 60 times (for DVD VIDEO only) normal speed. Pressing ► returns the player to normal playback.

**During playback, hold down ►►► or ◀◀◀.**

Playback is advanced or reversed at 5 times normal speed.

#### NOTE

During rapid playback, the sound will be muted except when playing an Audio CD, and when playing a DVD VIDEO at 1.5 times normal speed. For Audio CD discs, the sound will be heard intermittently.

## x1.5 Quick Playback with sound



When you select 1.5 times normal speed playback, the disc is played back with sound.

- The subtitle does not go off.
- The sound may be heard intermittently.
- If the sound of a DVD VIDEO disc is recorded in Dolby Digital or DTS format, stereo linear PCM signals are output. With some DVD VIDEO discs, the sound quality and volume may alter, or the sound may be out of tune.
- To switch from rapid reverse playback to x1.5 Quick Playback, first press ►, then press ►► once.

## To advance a still picture frame by frame



**While paused, press II.**

Each time you press II, the still picture advances to the next frame.

Pressing ► returns to normal playback.

## To play back in slow motion



You can select from 1/32 times, 1/16 times, 1/4 times and 1/2 times normal speed.

**During playback, press II, then press ►► (to play forward slow motion), or ◀◀ (to play reverse slow motion, for DVD VIDEO disc only).**

Pressing ► returns to normal playback.

#### NOTE

During slow motion playback, the sound will be muted.

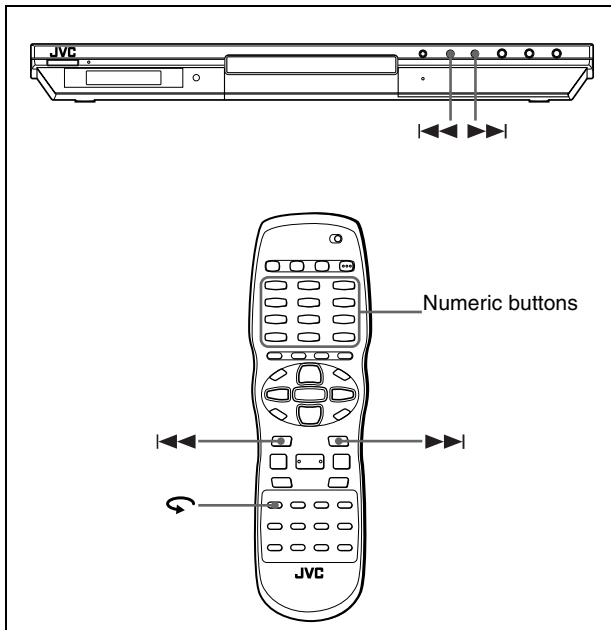

### To replay the previous scenes (One touch replay function)



During DVD VIDEO playback, press .

The playback position moves back 10 seconds before the current position.

#### NOTES

- This function works only within the same title, though it works between chapters.
- This function may not work with some DVD VIDEO discs.

## Locating the beginning of a scene or song



For DVD VIDEO: During playback, you can skip a chapter or title, depending on the disc configuration.

For SVCD/Video CD: During playback without PBC function, you can skip a track.

For Audio CD: During playback or while in stop mode, you can skip a track.

To skip forward, press .

To skip backward, press .

### Using the numeric buttons

For DVD VIDEO/Audio CD: During playback or while in stop mode

For SVCD/Video CD: During playback without PBC function or while in stop mode

Press the numeric buttons to specify the number.

To select 5: press 5.

To select 23: press +10, +10, then 3.

To select 40: press +10, +10, +10, then 10.

The player starts playback from the beginning of the selection.

#### NOTES

- Depending on the disc type and the player status, what is specified differs:

Player status	Disc type	What is specified
While stopped	DVD VIDEO	title
	SVCD/Video CD/Audio CD	track
During playback	DVD VIDEO	chapter
	SVCD/Video CD/Audio CD	track

- During DVD VIDEO playback, if a menu is shown on the TV screen, the numeric buttons may be used for selecting an item in the menu.

#### About screen saver function

A television monitor may have an image burned into it if a static image is displayed for a long time. To prevent this, the player automatically activates the screen saver function if a static picture, such as an on-screen display or menu, is displayed for over 5 minutes.

When the screen saver function is activated, the TV screen gets darker.

Pressing any buttons will release the screen saver function. See "SCREEN SAVER" on page 27.

- When a still picture of JPEG/MPEG-4 files are played back, the screen saver function does not work.

# Advanced operations

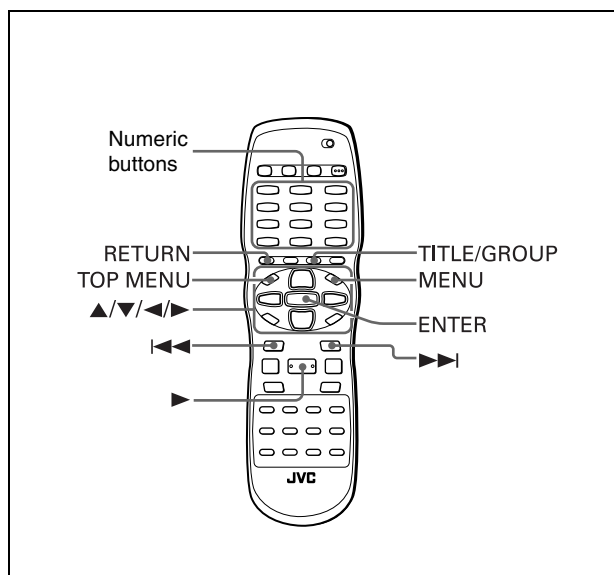

## NOTE



Make sure that the TV - DVD switch on the remote control unit is set to "DVD" when using the ▲/▼/◀/▶, numeric and TV/VIDEO - CANCEL buttons for controlling the player.

## Playing from a specific position

### Locating a desired scene from the DVD menu



DVD VIDEO discs generally have their own menus which show the disc contents. These menus contain various items such as titles of movies, names of songs, or artist information, and display them on the TV screen. You can locate a desired scene using the DVD menu.

#### 1 While a DVD VIDEO disc is inserted, press TOP MENU or MENU.

The menu appears on the TV screen.

#### 2 Press ▲/▼/◀/▶ to select a desired item, then press ENTER.

The player starts playback of the selected item.

#### Hints

- Some DVD VIDEO discs may also have a different menu which appears when MENU is pressed.
- See the instructions of each DVD VIDEO disc for its particular menu.
- With some discs, you can select items by entering the corresponding number using the numeric buttons, which may cause the player to automatically start playback.

## NOTE

The MENU button does not work while stopped.

### Locating a desired scene from the menu of a SVCD/Video CD with PBC



Some SVCD/Video CD discs support the PBC function. PBC is an abbreviation of "Playback Control." Some SVCD/Video CD discs recorded with PBC have their own menus, such as a list of the songs of the disc. You can locate a specific scene by using the PBC menu.

#### 1 In stop mode, press ►.

A disc menu appears on the TV screen.

#### 2 Press the numeric buttons to select the desired item.

To select 5: press 5.

To select 23: press +10, +10, then 3.

To select 40: press +10, +10, +10, then 10.

The player starts playback of the selected item.  
To return to the menu, press RETURN.

#### Hint

If something like [NEXT] or [PREVIOUS] appears on the TV screen, pressing ► advances to the next page, and pressing ◀ returns to the previous page.

### About PBC (Playback Control)

Some SVCD/Video CD discs support the PBC function. The PBC function allows you to enjoy menu-driven operation and high-resolution still images which have a resolution four times greater than moving pictures.

- To play a PBC-compatible SVCD/Video CD disc without activating the PBC function, press the numeric buttons instead of ► to start playback.
- To activate the PBC function again, press ■ to stop playback, then press ►.

### Specifying a desired title



#### 1 During playback, press TITLE/GROUP.

[--] is shown in the title display area of the display window.

#### 2 Press the numeric buttons to specify a title to be played.

To select 5: press 5.

To select 23: press +10, +10, then 3.

To select 40: press +10, +10, +10, then 10.

The player starts playback from the specified title.

## NOTE

This function may not work with some DVD VIDEO discs.

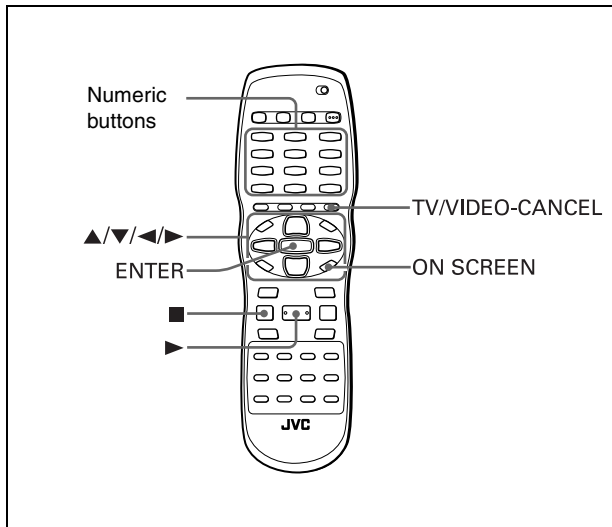

## Locating a desired position in the current title or track (Time search)



You can play a disc from the desired position by specifying the time from the beginning of the current title (for DVD VIDEO) or the disc (for SVCD/Video CD/Audio CD).

For DVD VIDEO/Audio CD: During playback  
 For SVCD/Video CD: In any condition except SVCD/Video CD playback with PBC

### 1 Press ON SCREEN twice.

The menu bar appears on the TV screen.

### 2 Press ◀▶ to move ↻ to ⏪, then press ENTER.

The pull-down menu for entering time appears.

#### Screen example for DVD VIDEO

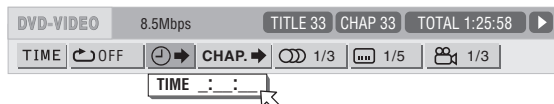

#### Screen example for Audio CD

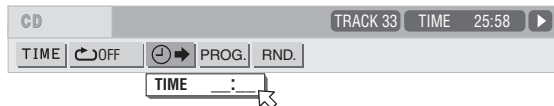

### 3 Press the numeric buttons (0 to 9) to enter the desired time.

The specified time is displayed in the pull-down menu.

#### Example (for DVD VIDEO)

To play back from 2(H):34(M):00(S)  
 Press 2, 3, then 4.

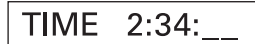

#### Example (for SVCD/Video CD/Audio CD)

To play back from 23(M):40(S)  
 Press 2, 3, then 4.



You do not have to press "0" to enter the trailing zeros (for the last two digits in the example above).

#### To correct a mistake

Press ◀ repeatedly to move back to the digit where you entered a wrong number, and reenter the correct one.

### 4 Press ENTER.

The player starts playback from the specified time.

### To dismiss the menu bar

Press ON SCREEN.

#### Hint

"10" and "+10" buttons are not used with this function.

#### NOTES

- Some DVD VIDEO discs do not contain time information, and the time search function cannot be used.
- The time search function cannot be used during program playback.



## Changing the playback order

### To play back in a specific order (Program play)



By programming tracks, you can play up to 99 tracks in any order. You may program the same track more than once.

#### 1 In stop mode, press ON SCREEN twice.

The menu bar appears on the TV screen.

#### 2 Press ◀▶ to move ⏏ to PROG.

Screen example for Audio CD

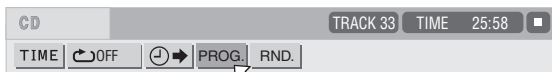

#### 3 Press ENTER.

The program table appears.

The PRGM indicator lights up in the display window.

#### 4 Press the numeric buttons to specify tracks in the desired order.

To select 5: press 5.

To select 23: press +10, +10, then 3.

To select 40: press +10, +10, +10, then 10.

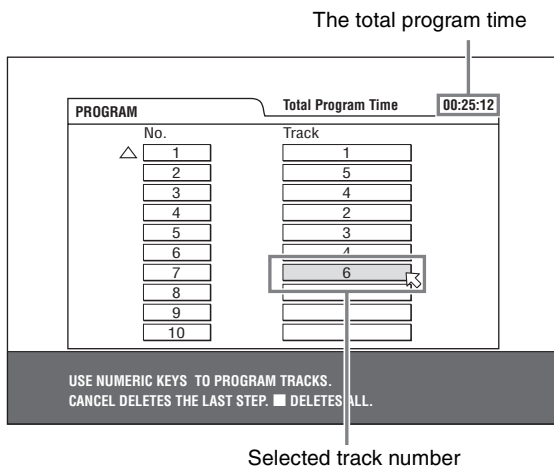

#### To correct the program

Press ▲/▼ to move ⏏ to the track to be corrected, then press TV/VIDEO - CANCEL. The track is erased and the subsequent programmed tracks move up. Pressing ■ clears all the programmed tracks.

#### 5 Press ▶ to start program playback.

With an Audio CD disc, the program table remains on the TV screen during program playback. (Pressing ON SCREEN brings up the status bar.)

When all of the programmed tracks have finished playback, the player stops and the program table appears again. Note that the program remains.

- During program playback, you cannot edit the program contents.

### To check the program contents

During playback, press ■. Playback stops and the program table is shown.

When the player is playing back an Audio CD and the program table is not shown, you can bring up the table by carrying out steps 1 to 3.

During SVCD/Video CD playback, you can check the program contents via the menu bar.

### To stop program playback

Press ■.

### To clear the program

While stopped and the program table is shown, press ■.

### To exit the program mode

After clearing the program, press ON SCREEN.

#### NOTES

- When the disc tray is opened or the player is turned off, the program is cleared.
- During AUDIO CD playback, you can select previous or next tracks by pressing ▶▶/◀◀.
- During VCD/SVCD playback, you cannot search for the portion on the discs by pressing ▶▶/◀◀.
- During program playback, you can repeat playback.

### To play back in random order (Random play)



#### 1 In stop mode, press ON SCREEN twice.

The menu bar appears on the TV screen.

#### 2 Press ◀▶ to move ⏏ to RND.

Screen example for Audio CD

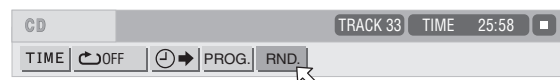

#### 3 Press ENTER.

The player starts random playback.

With an SVCD/Video CD disc, the menu bar is automatically dismissed.

During random playback, the RND indicator lights up in the display window.

After playing all tracks of the disc, the player stops the disc and exits the random playback mode.

### To stop and quit random playback

Press ■. The player stops playback and exits the random playback mode.

#### NOTES

- During random playback, you can repeat playback.
- Random playback mode will be canceled in the following cases:
  - When ejecting the loaded disc
  - When the Control screen appears on the TV
  - When turning off the power

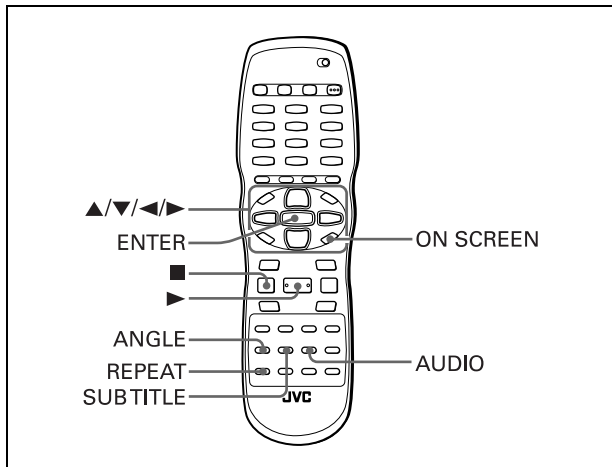

## Repeat playback

### To repeat the current selection or all tracks



For DVD VIDEO: During playback  
For SVCD/Video CD/Audio CD: In any condition except SVCD/  
Video CD playback with PBC

#### Press REPEAT.

If you press REPEAT in stop mode, press ► to start playback.

Each time you press REPEAT, the repeat mode cycles among All repeat, Repeat 1 and off.

The indication on the display window shows the selected repeat mode.

: Repeats the current title for DVD VIDEO or all tracks for SVCD/Video CD/Audio CD.

1: Repeats the current chapter for DVD VIDEO or the current track for SVCD/Video CD/Audio CD.

**No indication:** The repeat mode is off.

A window which indicates the current repeat mode will be displayed on the TV screen. The mode indication on the window is same as the one on the menu bar.

(Repeat mode example on the TV screen)

CHAP

### To stop repeat playback

Press ■.

When a DVD VIDEO disc is set, the unit stops playback and quits the repeat mode.

When an SVCD, Video CD or Audio CD disc is set, the unit stops playback but does not quit the repeat mode.

### To quit repeat playback

Press REPEAT until the repeat mode indicator goes off in the display window.

#### Hint

When the program playback mode is active with an SVCD, Video CD or Audio CD, the repeat mode changes in the same manner.

Note, however, that in the " " mode the player repeats all the programmed tracks instead of all tracks on the disc.

### To repeat a desired part (A-B repeat playback)



#### First make sure:

- The player is in playback mode except SVCD/Video CD playback with PBC.

#### 1 Press ON SCREEN twice.

The menu bar appears on the TV screen.

#### 2 Press ◀/▶ to move to , then press ENTER.

The pull-down menu for repeat mode selection appears.

#### 3 Press ▲/▼ to select [A-B].

#### 4 Press ENTER at the beginning of the part you want to repeat (point A).

The pull down menu disappears.

The repeat icon shows A- .

#### 5 Press ENTER at the end of the part you want to repeat (point B).

The repeat icon shows A-B .

The player locates "A" and starts repeat playback between "A" and "B."

The indicator lights in the display window.

### To quit A-B repeat playback

Press ◀/▶ to move to A-B , and press ENTER. The A-B repeat mode turns off, then normal playback continues.

#### NOTE

The A and B points must be set in the same title/chapter/track.

## Changing the language, sound and scene angle

### To select the subtitle language (SUBTITLE)



Some DVD VIDEO and SVCD discs contain more than one subtitle language. You can choose a desired one from them.

#### Hint

At the beginning of the part where the subtitles are recorded,  appears on the TV screen (except when the [ON SCREEN GUIDE] preference is set to [OFF]).

#### 1 During playback, press SUBTITLE.

The subtitle selection window appears on the TV screen.

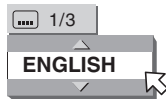

#### 2 Press ▲/▼ or SUBTITLE to select the subtitle.

Each time you press ▲/▼ or SUBTITLE, the subtitle language changes.

#### 3 Press ENTER.

Subtitles are displayed in the selected language. The subtitle selection window is dismissed.

#### NOTES

- An SVCD disc can have up to four subtitles. Pressing ▲/▼ cycles through those channels regardless of whether the subtitles are recorded or not.
- The subtitle selection window will automatically disappear if you do not change the subtitle for several seconds.
- For DVD VIDEO, the selected language may be abbreviated on the TV screen. See "Appendix B: Table of languages and their abbreviations" on page 37.

### To change the audio language or sound (AUDIO)



The audio selection setting allows you to change the audio language of a movie.

#### Hint

At the beginning of the part where multiple audio tracks are recorded,  appears on the TV screen (except when the [ON SCREEN GUIDE] preference is set to [OFF]).

#### 1 During playback, press AUDIO.

The audio selection window appears on the TV screen.

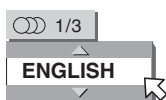

#### 2 Press ▲/▼ or AUDIO to select the desired audio.

Each time you press ▲/▼ or AUDIO, the audio changes.

For DVD VIDEO (example)



For SVCD

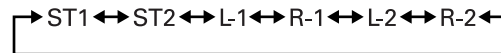

For Video CD



#### 3 Press ENTER.

You can hear the selected audio. The audio selection window is dismissed.

#### NOTES

- The audio selection window will automatically disappear if you do not change the audio for several seconds.
- For DVD VIDEO, the selected language may be abbreviated on the TV screen. See "Appendix B: Table of languages and their abbreviations" on page 37.

### To select a scene angle of DVD VIDEO (ANGLE)



You can enjoy a variety of scene angles if the DVD VIDEO disc contains "multi-angle" parts, where multiple cameras were used to shoot the same scene from different angles.

#### Hint

At the beginning of a "multi-angle" part,  appears on the TV screen (except when the [ON SCREEN GUIDE] preference is set to [OFF]).

#### 1 During playback, press ANGLE.

The angle selection window appears on the TV screen.

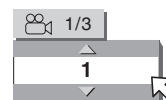

#### 2 Press ▲/▼ or ANGLE to select the desired angle.

Each time you press ▲/▼ or ANGLE, the angle changes.

#### 3 Press ENTER.

You can see the picture from the selected angle. The angle selection window is dismissed.

#### NOTE

The angle selection window will automatically disappear if you do not change the angle for several seconds.

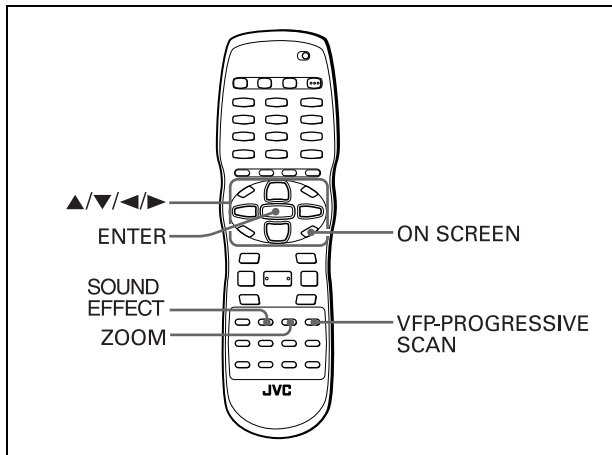

## Special picture/sound effect

### To zoom in pictures



#### 1 During playback or while paused, press ZOOM.

Pressing ZOOM causes the player to zoom in on the image. Each time you press ZOOM, the magnification is changed (1.5, 2 and 4 times).

#### 2 Press ▲/▼/◀/▶ to move the zoomed position.

### To return to the normal playback

Select the normal size by pressing ZOOM repeatedly.

#### NOTE

While zoomed, the picture may look coarse.

### To adjust the picture character (VFP)



The VFP (Video Fine Processor) function allows you to adjust the picture character according to the type of programming, picture tone or personal preferences.

#### 1 During playback, press VFP - PROGRESSIVE SCAN.

The VFP mode selection window appears on the TV screen.

- If you press the VFP-PROGRESSIVE button too long, the button works for changing the scanning mode (see page 4) instead of the VFP function.

#### 2 Press ◀/▶ to select the desired preset.

Each time you press the button, the VFP mode changes as follows.

Set the video type most suitable to the current program or the room conditions.

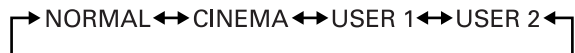

Selected preset

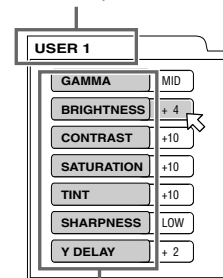

Parameter

[NORMAL]: for watching TV in a general room.

[CINEMA]: for watching a movie software in a room with suppressed light.

[USER 1] [USER 2]: you can adjust parameters that affect the picture character and store the settings as a user preset. See the next step.

#### 3 To define a user setting, press ▲/▼ to select a parameter to be edited from the following.

- **GAMMA**  
Adjust this if the neutral color is bright or dark. The brightness of dark and bright portion is maintained. Available range: LOW/MID/HIGH.
- **BRIGHTNESS**  
Adjust this if the picture is bright or dark on the whole. Available range: -16 (darkest) to +16 (brightest).
- **CONTRAST**  
Adjust this if the far and near position is unnatural. Available range: -12 to +12.
- **SATURATION**  
Adjust this if the picture is whitish or blackish. Available range: -16 (blackest) to +16 (whitest).
- **TINT**  
Adjust this if the appearance of flesh tone is unnatural. Available range: -16 to +16.
- **SHARPNESS**  
Adjust this if the picture is indistinct. Available range: LOW/HIGH.
- **Y DELAY**  
Adjust this if the picture looks separately/overlapped. Available range: -2 to +2.

#### 4 Press ENTER.

A window for setting parameters appears.



Selected parameter

#### 5 Press ▲/▼ to adjust the level of the parameter.

The higher value enhances the effect for each item other than "GAMMA" and "SHARPNESS."

#### 6 Press ENTER.

Repeat steps 3 to 6 if you want to set other parameters.

### To dismiss the VFP mode selection window

Press VFP - PROGRESSIVE SCAN.

#### NOTE

The window for VFP mode selection and parameter setting disappears if no operation is made for about 10 seconds.

### To change sound field (SOUND EFFECT)



Using the Sound Effect function, you can change the sound field.

#### 1 During playback, press SOUND EFFECT.

The Sound Effect indication appears on the TV screen.

#### 2 Press SOUND EFFECT to select the desired mode.

Each time you press the button, the Sound Effect mode changes as follows:

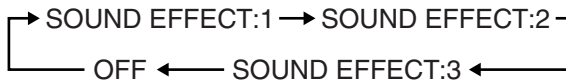

- As the value becomes bigger, the Sound Effect works stronger.

### To deactivate the Sound Effect

Press SOUND EFFECT repeatedly until "OFF" appears on the TV screen.

#### NOTE

The Sound Effect indication disappears if no operation is made for about few seconds.

## Menu bar functions

### To bring up the menu bar

#### 1 When a disc is inserted, press ON SCREEN.

A status bar for the type of disc inserted will appear on the TV screen.

See page 10 for details about the status bar.

#### 2 Press ON SCREEN again.

A menu bar for the type of disc inserted will appear under the status bar.

(for DVD VIDEO)



(for SVCD)

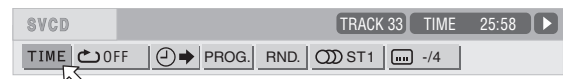

(for Video CD)

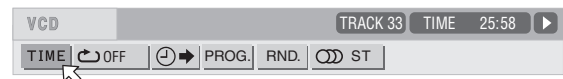

(for Audio CD)

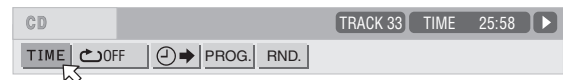

### To dismiss the menu bar and status bar

Press ON SCREEN.

## Basic operation procedure

#### 1 Press to select the icon you want to work with.

The selected icon is pointed by .

#### 2 Press ENTER.

With many icons, an appropriate pull-down window appears, however, there are some exceptions.

#### NOTES

- A mark or text on the menu icon for the function or mode currently selected is shown in green.
- Some functions are not available during playback. (You cannot move to the associated icon when it is not available.)

### Menu bar functions for DVD VIDEO

#### Time mode selection

During playback, selects the time mode shown in the display window and in the status bar.

Press ENTER to select the time mode from the following.

- TOTAL: Current title elapsed time
- T.REM: Current title remaining time
- TIME: Current chapter elapsed time
- REM: Current chapter remaining time

#### Repeat mode (See also page 16)

Selects the repeat mode during playback.

1. Open the pull-down window.
2. Press ▲/▼ to select the repeat mode from the following.
  - CHAPTER: Current chapter repeat
  - TITLE: Current title repeat
  - A-B: A-B repeat
  - OFF: Repeat mode deactivated
3. Press ENTER to make the selected repeat function active.

#### Time search (See also page 14)

Specifies a time from the beginning of the current title as the point from which to begin playback.

#### Chapter search

During playback, specifies a desired chapter to be played back from.

1. Open the pull-down window.
2. Press numeric buttons (0 to 9) to enter a desired chapter number. (For example, to specify "10," press 1, then 0.)
3. Press ENTER to begin playback from the specified chapter.

#### Audio selection (See also page 17)

During playback, selects the audio language or sound track.

1. Open the pull-down window.
2. Press ▲/▼ to select a desired audio language or sound track.
3. Press ENTER to begin playback with the selected audio.

#### Subtitle selection (See also page 17)

During playback, selects the subtitle language.

1. Open the pull-down window.
2. Press ▲/▼ to select a desired subtitle language.
3. Press ENTER to begin playback with the selected subtitle.

#### Angle selection (See also page 17)

During playback, selects a desired scene angle in a multi-angle part.

1. Open the pull-down window.
2. Press ▲/▼ to select a scene angle.
3. Press ENTER to begin playback with the selected scene angle.

### Menu bar functions for SVCD/Video CD/ Audio CD

#### Time mode selection

Selects the time mode shown in the display window and in the status bar.

Press ENTER to select the time mode from the following.

- TIME: Current track elapsed time
- REM: Current track remaining time (while in stop mode, current track total time)
- TOTAL: Disc elapsed time
- T.REM: Disc remaining time (while in stop mode, disc total time)

#### Repeat mode (See also page 16)

Selects the repeat mode.

1. Open the pull-down window.
2. Press ▲/▼ to select the repeat mode from the following.
  - TRACK: Current track repeat
  - ALL: All track repeat
  - A-B: A-B repeat
  - OFF: Repeat mode deactivated
3. Press ENTER to make the selected repeat function active.

#### Time search (See also page 14)

Specifies a time from the beginning of the disc as the point from which to begin playback.

#### Program playback (See also page 15)

While stopped, specifies the playback order of tracks.

#### Random playback (See also page 15)

While stopped, activates random playback.

#### Audio selection (See also page 17)

During SVCD/Video CD playback, selects the audio channel(s).

1. Open the pull-down window.
2. Press ▲/▼ to select a desired audio channel(s).
3. Press ENTER to play back with the selected audio channel(s).

#### Subtitle selection (See also page 17)

During SVCD playback, selects the subtitle.

1. Open the pull-down window.
2. Press ▲/▼ to select a desired subtitle.
3. Press ENTER to begin playback with the selected subtitle.

# Audio/Video files playback

## Outline

The player can play back MP3/WMA/JPEG/MPEG-4 (simple profile/asf file) files on either a personally recorded CD-R/RW disc and memory card, or a commercially available CD. You can select and play back files using the Control display on the TV screen.

- The player may be unable to play back the media due to the characteristics or recording conditions.

## Precautions

### About files and folders (groups) on the disc or the memory card

- Files are sometimes grouped into folders by genre, album, etc. In this manual, "group" is also referred to as "folder."
- A folder which has one or more files is regarded as a group.
- The player can detect and play back the groups which are located up to the fifth layer.
- The files in the Control display are arranged by the alphabetical order of extensions as follows: ".asf," ".jpeg," ".mp3," and ".wma."
- Time required for reading the media contents may vary for different media, depending on the numbers of folders (groups) and files recorded, etc.
- Files which do not belong to any folder are grouped into "group 1."
- The player recognizes up to 999 files per group, and up to 250 groups per disc/memory card. Files other than MP3/WMA/JPEG/MPEG-4 files also count in the 999 total.

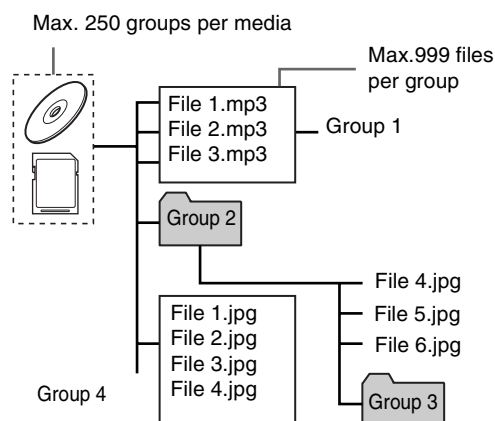

### Notes for making your own disc using a CD-R/CD-RW disc

- Use "ISO 9660" as the disc format.
- The player does not support "packet writing (UDF format)" discs.
- The player supports discs recorded with up to five multiple sessions.
- Some media may not play due to media characteristics or recording conditions.

### Notes for making files/groups

- If a file name includes even one 2-byte character, the player may not show the file name correctly.
- The player supports up to 12 characters as the group/file names.
- The player can only recognize files with one of the following extensions, which can be in any combination of upper and lower case:
  - For MP3 files, ".MP3," ".mp3."
  - For WMA files, ".WMA," ".wma,"
  - For JPEG files, ".JPG," ".JPEG," ".jpg," ".jpeg."
  - For MPEG-4 files, ".ASF," ".asf."
- **For MP3 files:**
  - It is recommended that you record your material at a 44.1 kHz sampling rate, using the 128 kbps data transfer rate.
  - ID 3 Tag is not available.
  - MP3i and MP3 Pro are not available.
- **For WMA files:**
  - WMA Tag is not available.
  - Make sure that the copyright feature is set to off.
  - We recommend you to record your material at a bit rate of 64 kbps or higher.
  - The player supports WMA files recorded with a bit rate of 48 kbps or higher. The player cannot play back WMA files recorded with a bit rate under 48 kbps.
- **For JPEG files:**
  - We recommend you to record your material at a 640 x 480 pixel resolution.
  - This player supports the baseline JPEG format.
  - The player does not support a baseline-formatted picture of more than 5120 x 3413 pixels. Make sure that the pictures pixel size is 5120 x 3413 pixels or less.
  - This player cannot play back a progressive JPEG file of more than 2048 x 1536 pixels.
- **For MPEG-4 files:**
  - This player supports the type of simple profile and asf as MPEG-4 files.
  - The player can play back simple profile recorded not on a PC but on a digital still/video camera.
  - The size of the playback screen will be the same size as it is recorded.
  - Some recorded files may not be able to be played back depending on file characteristics, kind of digital still/video cameras, or recording conditions.

# Audio/Video files playback

## Notes for inserting and removing memory cards

- Before you insert a memory card into a card slot, open the door on the front panel and make sure of the slot type and the direction of insertion as illustrated.
- Always use the single type of memory card at a time.
- Before removing a memory card during playback, stop the playback.
- **When playing back a disc, the electrostatic noise may restart the playback from the beginning.**

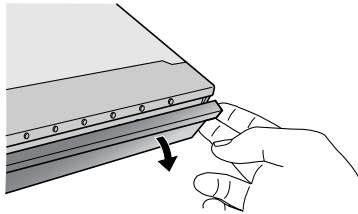

Press here to remove the inserted CompactFlash with the player held.

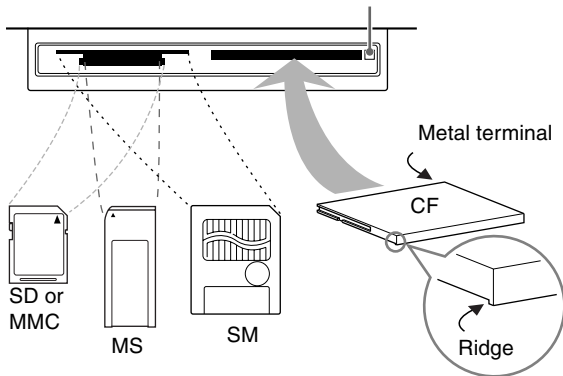

- When inserting or removing a memory card, hold the player firmly.

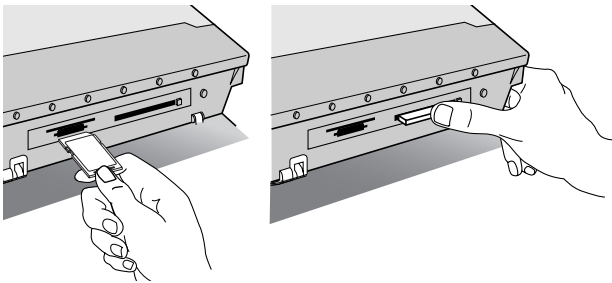

- While a memory card is inserted, keep the door on the front panel open.
- Close the door after removing memory cards.

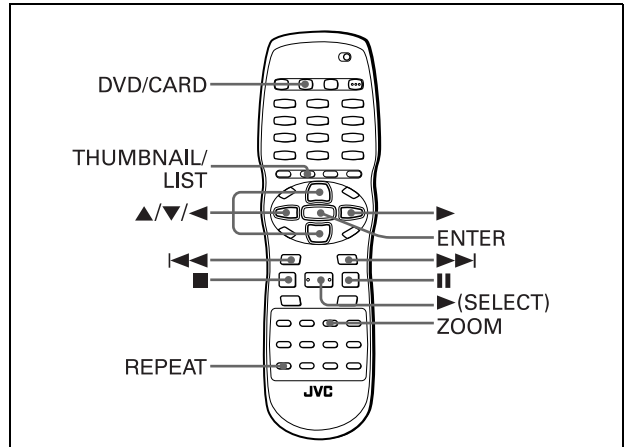

### NOTE



Make sure that the TV - DVD switch on the remote control unit is set to "DVD" when using the  $\blacktriangle/\blacktriangledown/\blacktriangleleft/\blacktriangleright$  and numeric buttons for controlling the player.

## Basic operations

When you insert a disc or memory card with groups and files, the Control display that shows the contents of the medium automatically appears on the TV screen. You can specify and play back the desired group/file from the Control display using the following procedure.

- 1 Make sure that the cursor bar is in the left (group) column on the Control display.**

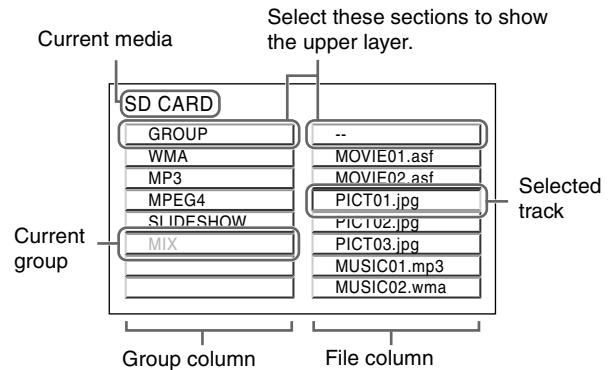

- If it is in the right column, press  $\blacktriangleleft$  to move it to the left column.
- If you want to select the other medium while both a disc and memory cards are inserted, press DVD/CARD before starting playback. When the player accesses a memory card, the DVD/CARD lamp on the front panel lights up

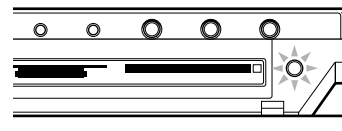



**2 Press ▲/▼ to move the bar to a desired group, then press ENTER.**

- In the right column, files in the selected group are shown.

**3 Press ▲/▼ to select the desired file, then press ENTER.**

- The desired file is played back.
- When you press ► (SELECT), the continuous playback starts from the selected file.
  - You can change the files on the list by pressing ◀◀/▶▶.

**To pause playback**

Press II.  
Pressing ► resumes normal playback.

**To reverse or advance playback rapidly**

- Press ◀◀/▶▶ during playback of MP3/WMA/MPEG-4.
- For MP3/WMA: Each time you press ◀◀ or (▶▶), the player reverses (or advances) playback, rapidly changing the playback speed as follows: x2, x4, x6, and x8.
  - For MPEG-4: The playback speed of MPEG-4 files depends on the files' characteristics.

**To zoom in a picture**

- Press ZOOM.  
"ZOOM..." appears on the TV.
- Each time you press ZOOM, the magnification is changed—1.5, 2 times, and 4 times for JPEG file; 2 times, and 4 times for MPEG-4 file.
  - The four-time magnification may not work for some MPEG-4 files according to their resolutions.
  - Pressing ▲/▼/◀/▶ moves the zoomed position during playback of JPEG file.
- To cancel the zoom function, select the normal size by pressing ZOOM repeatedly.

**To rotate/reflect a still picture**

- While the still picture is played back:
- Pressing ► rotates the picture by 90° clockwise.
  - Pressing ◀ rotates the picture by 90° counterclockwise.
  - Pressing ▼ reflects the picture vertically.
  - Pressing ▲ reflects the picture horizontally.

**To stop playback**

- Press ■.  
The Control display appears on the TV.
- Removing the memory card also stops playback.

**NOTES**

- Opening the disc tray changes the player to the disc operation mode after stopping the playback and/or turning off the Control display for the memory card. In this case, automatic playback of DVD Video does not work.
- During slide show playback, you cannot rotate/reflect a picture.
- It may take time to show the Control display due to the layer configuration of the files and groups.
- The elapsed time may be incorrectly indicated on the display window due to the recording condition of the file.
- The display window cannot show the file number more than 100. When the files numbered over 100th are played back, the player re-counts file number again from 0.
- The playback information appears on the TV as follows:
  - "JPEG DATA ERROR" means that this player cannot play back the file.
  - "JPEG DATA CORRUPTED" means that the file has error but the player can play back it.
  - "NEXT" means the player skips to the next file.
  - "PREVIOUS" means the player skips to the previous file.
  - "SELECT" means the file is selected on the thumbnail screen.

**Direct selection for JPEG files**

You can select a particular JPEG file from the thumbnail screen.

**1 Press THUMBNAİL/LIST while a JPEG file is selected on the Control display.**

- The thumbnail screen appears on the TV. Up to nine thumbnails from the selected file at a time can be displayed on the screen.
- When selecting a group on the Control display, the thumbnail screen does not appear.



**2 Press ▲/▼/◀/▶ to select the desired picture on the thumbnail screen, then press ENTER.**

- The desired picture is played back.
- You can change the thumbnails by pressing ◀◀/▶▶. All the JPEG files in the single group are displayed every nine thumbnails.

**Repeat playback**

**During playback or while stopped, press REPEAT.**

- Each time you press REPEAT while a file is selected, the repeat mode changes as follows:

Control display	Display window	Function
REPEAT 1	 1	Repeats the current file.
REPEAT GROUP		Repeats all files in the current group.
REPEAT ALL		Repeats all files on the media.
No indication	The repeat mode is off.	

If you press REPEAT while stopped, you need to press ENTER or ► (SELECT) to start playback.

**To stop repeat playback**

- Press ■.  
Note that the repeat mode remains active.

**To quit repeat playback**

- During playback, press REPEAT until no repeat icon is shown on the display window.
- While stopped, press REPEAT until the repeat mode indication on the Control display goes off.

## Audio/Video files playback

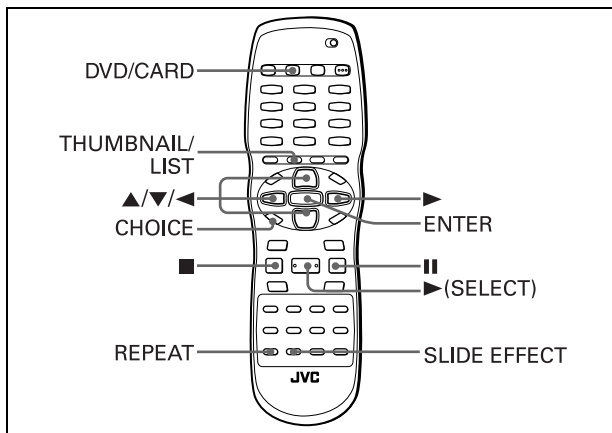

### NOTE



Make sure that the TV - DVD switch on the remote control unit is set to "DVD" when using the ▲/▼/◀/▶ and numeric buttons for controlling the player.

## Slide show playback

You can display files (still pictures) one after another automatically.

**Press ► (SELECT) while a JPEG file is selected on the Control display.**

The slide show starts from the beginning of the media.

- The display time varies in size of each file.
- When MP3/WMA files are in the same group, the music file playback starts after the slide show playback.

### To change the effect on displaying images

You can select the effect of slide show.

Press SLIDE EFFECT.

"SLIDE EFFECT MODE :." and the current mode appear on the TV screen.

- Each time you press the button, the effect is changed as follows:

Mode	Type of wipe
1	Scroll wipe 1: The next image slides in from top to bottom.
2	Scroll wipe 2: The next image slides in from bottom to top.
3	Shutter wipe 1: The next image slides in vertically from both sides to center.
4	Shutter wipe 2: The next image slides in vertically from center to both sides.
5	Blind wipe 1: The next image slides in vertically through 4 slits.
6	Slide wipe 1: The next image slides in from left to right.
7	Slide wipe 2: The next image slides in from right to left.
8	Door wipe 1: The next image slides in horizontally from both sides to center.
9	Door wipe 2: The next image slides in horizontally from center to both sides.
10	Window wipe: The next image slides in from each side to center.
11	Blind wipe 2: The next image slides in horizontally through 4 slits.
RANDOM	The player selects and applies the effect to each image randomly.
NONE	Cancels the effect.

### To stop slide show playback in the middle

Press ■.

The TV screen returns to the Control display.

- Pressing ► (SELECT) resumes slide show playback from the last picture displayed.

### To keep showing the current picture

Press II.

- Pressing ► (SELECT) resumes slide show playback.

### NOTE

During slide show playback, you cannot use the thumbnail and rotate/reflect functions.

## Music slide show playback

During slide show playback of JPEG files on the memory card, you can play back Audio CDs or MP3/WMA files as background music.

When you play back MP3/WMA files as background music, make a group containing both JPEG files and MP3/WMA files on the memory card.

- Music slide show is available for JPEG files on the single group.
- Music slide show may not work correctly for the progressive JPEG format.

### Slide show with Audio CD playback

#### 1 Insert an Audio CD.

- When a memory card is playing back (except for a slide show), playback will stop.

#### 2 Insert a memory card containing JPEG files.

The Control display of the memory card appears on the TV.

- When the memory card containing JPEG files is already selected, press DVD/CARD.

#### 3 Press ► (cursor) to show "MUSIC SLIDE SHOW" on the Control display.

- Each time you press the button, the playback mode alternates between "MUSIC SLIDE SHOW" and normal playback (no indication).

#### 4 Select a JPEG file on the Control display, then press ► (SELECT).

The first track on the Audio CD is played back and Music slide show starts.

- You can start Music slide show from the specified track on the Audio CD by pressing numeric buttons instead of ► (SELECT).
- You can change the tracks on the Audio CD by pressing ◀◀/▶▶.
- The playback of the Audio CD stops after all the JPEG files are played back.
- When a track on an Audio CD is played back as BGM, the time and track indication is not displayed on the window.

### Slide show with MP3/WMA playback

- Before starting the following procedure, remove the Audio CD from the disc tray.

#### 1 Insert a memory card containing a group with both JPEG files and MP3/WMA files.

The Control display for the media appears on the TV.

- When a memory card is already inserted, press DISC/CARD to show the Control display for that medium.

#### 2 Press ► (cursor) to show "MUSIC SLIDE SHOW" on the Control display.

- Each time you press the button, the playback mode alternates between "MUSIC SLIDE SHOW" and normal playback (no indication).

#### 3 Select JPEG file on the Control display, then press ► (SELECT).



Music slide show starts.

- The player plays back the MP3/WMA file from the beginning in the group. You can change the files by pressing ◀◀/▶▶.
- You cannot select MP3/WMA files on the other group/media as BGM.
- The playback of MP3/WMA files stops after all the JPEG files are played back.

### To repeat music slide show playback

Press REPEAT when the Control screen appears on the TV.

- Each time you press REPEAT, the repeat mode changes as follows:

Control display	Display window	Function
REPEAT 1	 1	Repeats the current JPEG file.
REPEAT GROUP		Repeats all JPEG files in the current group.
REPEAT ALL		
No indication	The repeat mode is off.	

### To stop music slide show playback in the middle

Press ⏸.

JPEG playback pauses.

When you press ⏸ again, BGM playback also pauses.

- Pressing ► (SELECT) or ⏸ resumes music slide show playback from the last picture displayed.

### To stop music slide show playback

Press ■.

## Changing the picture of the opening display

You can change and set the opening display to your favorite image. See page 28.

#### 1 Play back a JPEG file to be displayed as the opening display.

When the slide show is started, press ⏸ to pause the slide show.

#### 2 Press CHOICE and ◀/▶ to show PICTURE menu of the on-screen menu.

#### 3 Press ▲/▼ to select "BACKGROUND," then press ENTER.

#### 4 Press ▲/▼ to select "SAVE AS BACKGROUND," then press ENTER.

#### 5 Press ▲/▼ to select "YES," then press ENTER.

The player starts reading the selected JPEG file, and the opening screen is changed after reading the file.

- The previous JPEG file is overwritten by the newly saved file.

### To dismiss the menu screen

Press CHOICE.

### To resume the JVC's opening screen

Select "STANDARD" in step 4.

# Changing the initial settings

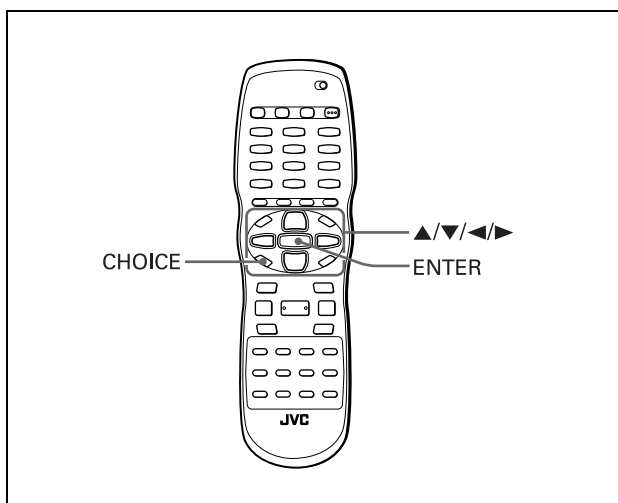

## NOTE



Make sure that the TV - DVD switch on the remote control unit is set to "DVD" when using the  $\blacktriangle/\blacktriangledown/\blacktriangleleft/\blacktriangleright$  and numeric buttons for controlling the player.

## Selecting preferences

This section refers to the settings which are already made when you purchase the player. Read this section when you want to connect this player to a wide-vision TV set, or when you want to otherwise change the settings according to your preferences and viewing environment.

## About the Preference display

The Preference display consists of the LANGUAGE, PICTURE, AUDIO and OTHERS setting displays, each having setting items.

### LANGUAGE

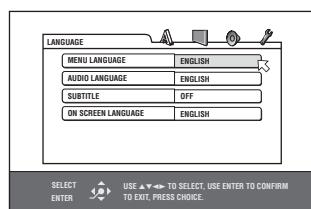

### PICTURE

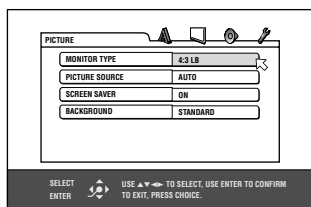

### AUDIO

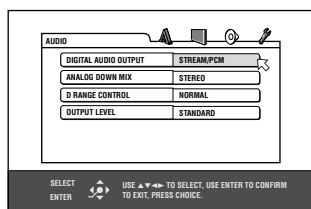

### OTHERS

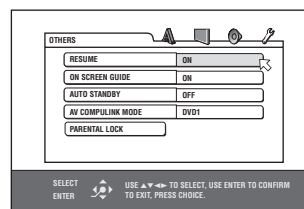

## How to set preferences

### 1 Press CHOICE.

One of the preference on-screen displays appears on the TV screen.

You can see four icons at the top right of the on-screen display for the settings.

: LANGUAGE menu

: PICTURE menu

: AUDIO menu

: OTHERS menu

### 2 Press $\blacktriangleleft/\blacktriangleright$ to select the appropriate icon.

The appropriate display appears on the TV screen.

### 3 Press $\blacktriangle/\blacktriangledown$ to move to select the item you want to edit.

The color of the selected item changes.

### 4 Press ENTER.

A pull-down menu appears over the selected item.

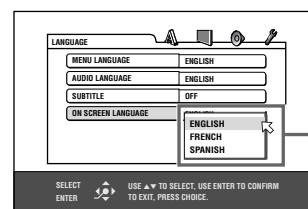

Selected item

### 5 Press $\blacktriangle/\blacktriangledown$ to select from the options then press ENTER.

The selected option is set.

- For details about each setting, see the following.

## To dismiss a preference display

Press CHOICE.

## NOTES

- While a disc containing MP3/WMA/JPEG/MPEG-4 files or a memory card is inserted, you cannot bring up any preference display.
- Some items cannot be changed during disc playback.
- When a preference display is shown on a wide TV screen, the upper and lower parts of the preference display sometimes may be cut off. If this happens, adjust the picture size control of the TV.
- When a preference display is shown, you cannot start playing back a disc.

## LANGUAGE menu

### MENU LANGUAGE

You can select the default menu language to be displayed if it is contained on a DVD VIDEO disc.

#### Setting options

**ENGLISH, SPANISH, FRENCH, CHINESE, GERMAN, ITALIAN, JAPANESE, language code from AA to ZU**

- If the disc does not have a menu in the selected language, the disc's default language will be used.
- For details about language codes, see "Appendix B: Table of languages and their abbreviations" on page 37.
- You cannot change the setting during playback.

### AUDIO LANGUAGE

You can select the default audio language to be played if it is contained on a DVD VIDEO disc.

#### Setting options

**ENGLISH, SPANISH, FRENCH, CHINESE, GERMAN, ITALIAN, JAPANESE, language code from AA to ZU**

- If the disc does not have the selected language, the disc's default language will be used.
- For details about language codes, see "Appendix B: Table of languages and their abbreviations" on page 37.
- You cannot change the setting during playback.

### SUBTITLE

You can select the default subtitle language to be displayed if it is contained on a DVD VIDEO disc.

#### Setting options

**OFF, ENGLISH, SPANISH, FRENCH, CHINESE, GERMAN, ITALIAN, JAPANESE, language code from AA to ZU**

- If the disc does not have a subtitle in the selected language, the disc's default language will be used.
- For details about language codes, see "Appendix B: Table of languages and their abbreviations" on page 37.
- You cannot change the setting during playback.

### ON SCREEN LANGUAGE

You can select the on-screen display language of the player.

#### Setting options

**ENGLISH, FRENCH, SPANISH**

- Some on-screen messages are shown in English regardless of the setting.
- You cannot change the on-screen language shown on the Control display.

## PICTURE menu

### MONITOR TYPE

You can select the monitor type to match your TV when you play back DVD VIDEO discs recorded for wide-screen televisions.

#### Setting options

**16:9, 4:3 LB, 4:3 PS**

**[16:9] (Wide television screen):** select when you connect the player to a wide-screen (16:9) TV.

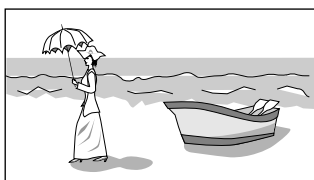

**[4:3 LB] (Letter Box conversion):** select when you connect the player to a normal (4:3) TV.

When playing back a DVD VIDEO disc recorded in wide picture format, the picture is shown with black bars at the top and bottom.



**[4:3 PS] (Pan Scan conversion):** select when you connect the player to a normal (4:3) TV.

When playing back a DVD VIDEO disc recorded in wide picture format, the picture is zoomed to fill the screen vertically, and the left and right sides of the image are chopped off.

Note, however, that the picture will be shown in the 4:3 LB mode even if you select the 4:3 PS mode depending on the disc.

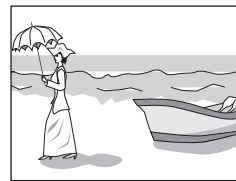

### PICTURE SOURCE

This mode selects whether the content on the disc is processed by field (video source) or by frame (film source). You can obtain optimal picture quality according to the source type to be played back by selecting an appropriate option. This setting is available for both the interlaced mode and progressive scanning mode.

#### Setting options

**VIDEO(NORMAL), VIDEO(ACTIVE), FILM, AUTO**

**[VIDEO(NORMAL)]:** select when playing back a video source disc with relatively a few movements.

**[VIDEO(ACTIVE)]:** select when playing back a video source disc with relatively a lot of movements.

**[FILM]:** select when playing back a film source disc.

**[AUTO]:** select when playing back a disc containing both video and film source materials.

The player recognizes the picture type (film or video source) of the current disc according to the disc information. Normally, select this option.

### SCREEN SAVER

You can set the screen saver function to ON or OFF. (See page 12.)

#### Setting options

**ON, OFF**

## Changing the initial settings

### BACKGROUND

You can change and set the opening display to your favorite image using this menu.

#### Setting options

##### STANDARD, USER, SAVE AS BACKGROUND

**[STANDARD]:** select when you use the JVC original image as the opening display (initial setting).

**[USER]:** select when you use your favorite image as the opening display. This item will be taken effect after you register a new image in the next item.

**[SAVE AS BACKGROUND]:** select when you register a new image. To register a new image, see "Changing the picture of the opening display" on page 25.

### AUDIO menu

#### DIGITAL AUDIO OUTPUT

To connect the player's digital output to an external device equipped with a digital input, this item must be set correctly. See "Appendix C: Digital output signal chart" on page 37 for details about the relation between the setting and output signals.

#### Setting options

##### OFF, PCM ONLY, DOLBY DIGITAL/PCM, STREAM/PCM

**[OFF]:** select when you enjoy the analog sound of DVD VIDEO as 96 kHz. No sound is outputted through the player's DIGITAL OUT terminals. When you enjoy the digital sound, do not select "OFF."

**[PCM ONLY]:** select when you connect the DIGITAL OUT jack of the player to the linear PCM digital input of other audio equipment.

**[DOLBY DIGITAL/PCM]:** select when you connect the digital input of a Dolby Digital decoder or an amplifier with a built-in Dolby Digital decoder.

When this option is selected, playing back a disc recorded by the MPEG Multichannel format outputs a linear PCM digital signal.

**[STREAM/PCM]:** select when you connect the digital input of an amplifier with a built-in DTS, MPEG Multichannel or Dolby Digital decoder, or the stand-alone unit of such a decoder.

- With some DVD VIDEO discs that are not fully copy-protected, a 20 or 24 bit digital signal may be output.
- When playing a DVD VIDEO or Audio CD disc with DTS, use a DTS decoder to get correct signals from your speakers.

#### ANALOG DOWN MIX

To correctly play the audio on a DVD VIDEO disc recorded with surround multichannel audio, you must set this item properly according to your audio system configuration.

#### Setting options

##### DOLBY SURROUND, STEREO

**[DOLBY SURROUND]:** select when listening to multichannel surround audio with the player's analog AUDIO OUT terminals connected to a surround decoder.

**[STEREO]:** select when listening to conventional two-channel stereo audio with the player's AUDIO OUT terminals connected to a stereo amplifier/receiver or television set, or in case you want to record the audio from a DVD VIDEO disc to MiniDisc, cassette, etc.

### D. RANGE CONTROL

This setting provides optimal audio quality from the analog AUDIO OUT terminals for listening to DVD VIDEO discs recorded in Dolby Digital format, at low or middle volume.

#### Setting options

##### WIDE RANGE, NORMAL, TV MODE

**[WIDE RANGE]:** when selected, audio is played back with the widest dynamic range so that you can enjoy powerful playback sound.

**[NORMAL]:** normally, select this option.

**[TV MODE]:** select if DVD VIDEO disc sound level is lower than TV program sound level. Thus you can hear sound at a lower volume clearly.

### OUTPUT LEVEL

This setting allows you to attenuate the level of the signal output from the player's analog AUDIO OUT terminals.

#### Setting options

##### STANDARD, LOW

- If the sound output from the speaker is distorted, select [LOW].

### OTHERS menu

#### RESUME

You can select the resume playback mode.

See pages 10 and 11 for details about the resume playback function.

#### Setting options

##### ON, OFF, DISC RESUME



**[ON]:** when selected, the player can resume playback of the disc from the position where playback was last interrupted, if the disc is still in the disc tray.

**[OFF]:** when selected, the resume function is deactivated.

**[DISC RESUME]:** when selected, the player can resume playback of the last 30 discs played. The player retains a memory of the interrupted positions of the last 30 discs played, even though they have been removed from the disc tray.

#### ON SCREEN GUIDE

The player can display "on-screen guide" icons or characters on the picture, which show what is happening to the disc or the player.

Example of "on-screen guide" icons:  ,  , 

#### Setting options

##### ON, OFF

**[ON]:** when selected, the on-screen guide is activated.

#### AUTO STANDBY

When the player is stopped for more than 30 minutes or 60 minutes, the player enters standby mode automatically.

#### Setting options

##### 60, 30, OFF

#### AV COMPULINK MODE

You must set this item correctly to use the AV COMPU LINK system.

#### Setting options

##### DVD1, DVD2, DVD3

- See page 33 for details about the AV COMPU LINK function.

## PARENTAL LOCK

When this option is selected, pressing ENTER on the remote control unit brings up the PARENTAL LOCK display shown below. This allows you to restrict children from playing DVD VIDEO discs.

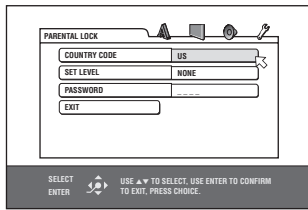

- See this page for details about the parental lock setting.

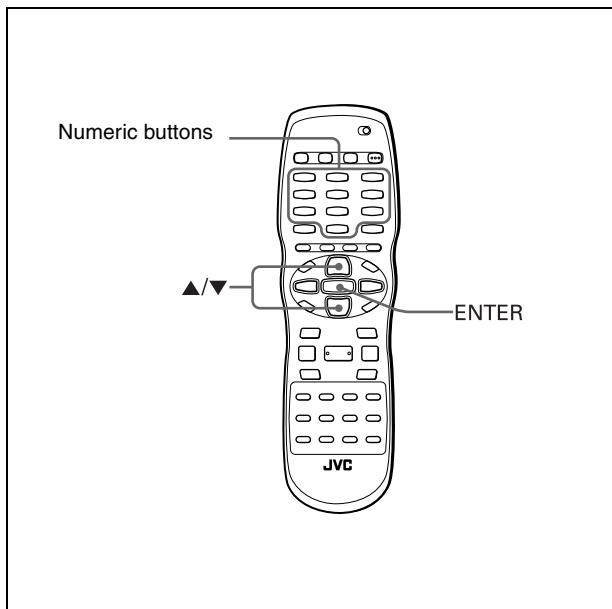

## Limiting playback by children

This function restricts playback of DVD VIDEO discs which contain violent (and other) scenes according to the level set by the user. For example, if a movie which includes violent scenes supports the parental lock feature, such scenes which you do not want to let children view can be cut or replaced with other scenes.

## To set Parental Lock for the first time



- 1 Bring up the OTHERS menu.
- 2 Press ▲/▼ to move to select [PARENTAL LOCK] then press ENTER.

The Parental Lock on-screen display appears on the TV screen.

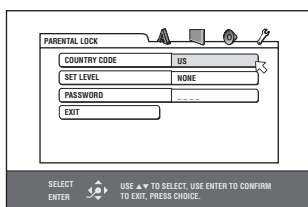

- 3 While is pointing to [COUNTRY CODE], press ENTER to bring up the pull-down menu.

- 4 Press ▲/▼ to select the country code.

Select the code of the country whose standards were used to rate the DVD VIDEO disc content.

See "Appendix A: Country/Area code list for Parental Lock" on page 36.

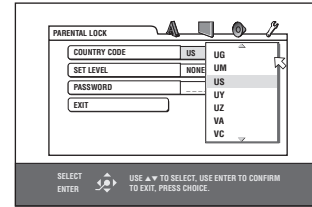

- 5 Press ENTER.

moves to [SET LEVEL].

- 6 Press ENTER to bring up the pull-down menu.

In the pull-down menu, [NONE] and levels [8] to [1] are available.

[NONE] does not restrict playback. Level [1] is the strictest level. Discs rated higher than the selected level are restricted.

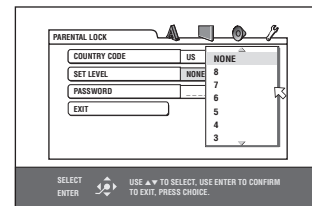

- 7 Press ▲/▼ to select a desired parental lock level, then press ENTER.

moves to [PASSWORD].

- 8 Press the numeric buttons (0 to 9) to enter a 4-digit password.

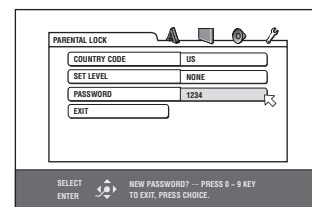

- 9 Press ENTER.

The parental lock feature is set.

moves to [EXIT]. Pressing ENTER again returns to the [OTHERS] menu of the preference display.

### Hint

If you want to change the password at step 8, do it before pressing ENTER.

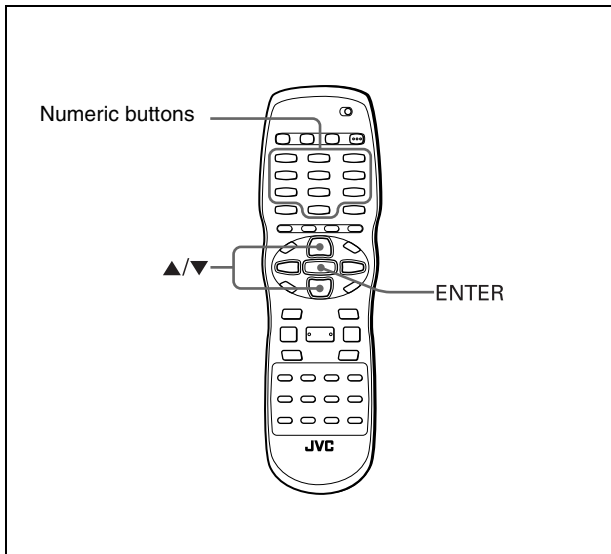

### To change the settings



You can change the parental lock settings later.

- 1 Bring up the **OTHERS** menu.
- 2 Press ▲/▼ to move to select **[PARENTAL LOCK]** and press **ENTER**.

The parental lock on-screen display appears on the TV screen.

- 3 While is pointing to **[PASSWORD]**, press the numeric buttons to enter your current 4-digit password then press **ENTER**.

moves to **[COUNTRY CODE]** if you enter the correct password.

If you enter a wrong password, "WRONG! RETRY..." appears on the TV screen, and you cannot go to the next step. If you forget your password, enter "8888." The current password is deleted and you can set a new password.

- 4 To change the **[COUNTRY CODE]** or **[SET LEVEL]**, press **ENTER** to bring up the associated pull-down menu when is pointing to the desired item.

- 5 Press ▲/▼ to select the desired option then press **ENTER**.

If you change the country code, you must reselect the parental lock level.

- 6 While is pointing to **[PASSWORD]**, press the numeric buttons to enter a 4-digit password.

The password entered in this step becomes the new password. If you want to keep the same password as before, enter the same password.

- 7 Press **ENTER**.

moves to **[EXIT]**. Pressing **ENTER** again returns to the **[OTHERS]** menu of the preference display.

#### NOTE

If you enter the wrong password more than 3 times in step 3 above, moves to **[EXIT]** automatically and ▲/▼ do not work.

### To temporarily release the Parental Lock



If the parental level is set to a strict value, some discs may not play at all.

When you insert such a disc and try to play it, the following parental lock on-screen display appears on the TV screen, asking you whether you want the parental lock to be temporarily released or not.

- 1 Press ▲/▼ to move to **[TEMPORARY RELEASE]**, then press **ENTER**.

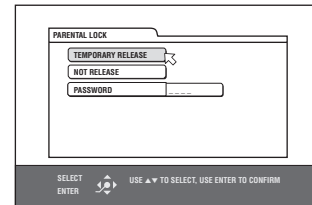

- 2 Press the numeric buttons (0 to 9) to enter your 4-digit password.

The Parental Lock is released, and the player starts playback.

If you enter a wrong password, "WRONG! RETRY..." appears on the TV screen. Enter the correct password.

#### NOTE

When you enter the wrong password 3 times at step 2 above, moves to **[NOT RELEASE]** automatically and ▲/▼ do not work.



# Additional information

## Names of parts and controls

### Front panel

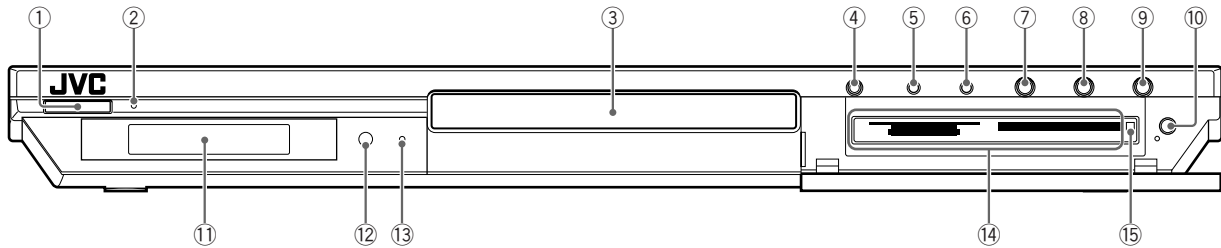

- ① ⏻ button (8)
- ② STANDBY/ON indicator (8)
- ③ Disc tray (9)
- ④ ▲ (eject) button (9)
- ⑤ ⏮ button (11, 12)
- ⑥ ⏭ button (11, 12)
- ⑦ ■ (stop) button (10, 13)
- ⑧ ▶ (play) button (9, 11)
- ⑨ ■ (pause) button (10, 11)
- ⑩ DVD/CARD button and lamp (22, 25)
- ⑪ Display window (see the illustration below)
- ⑫ Remote sensor (6)
- ⑬ PROGRESSIVE indicator (4)
- ⑭ Memory card slots (22)
- ⑮ Card eject button (22)

### Display window

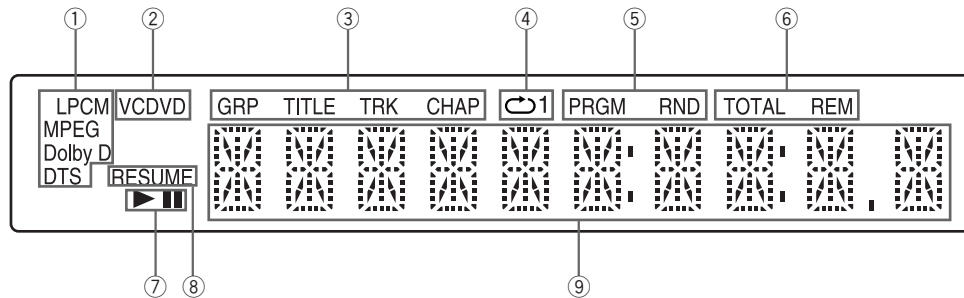

- ① Audio format indicators
- ② Disc indicator
- ③ Group/title/track/chapter indicators
- ④ Repeat mode indicator
- ⑤ Program/random indicators
- ⑥ Total time/remaining time indicators
- ⑦ ▶ (play) / ■ (pause) indicators
- ⑧ Resume indicator
- ⑨ Multi-information window

Additional information

Remote control unit

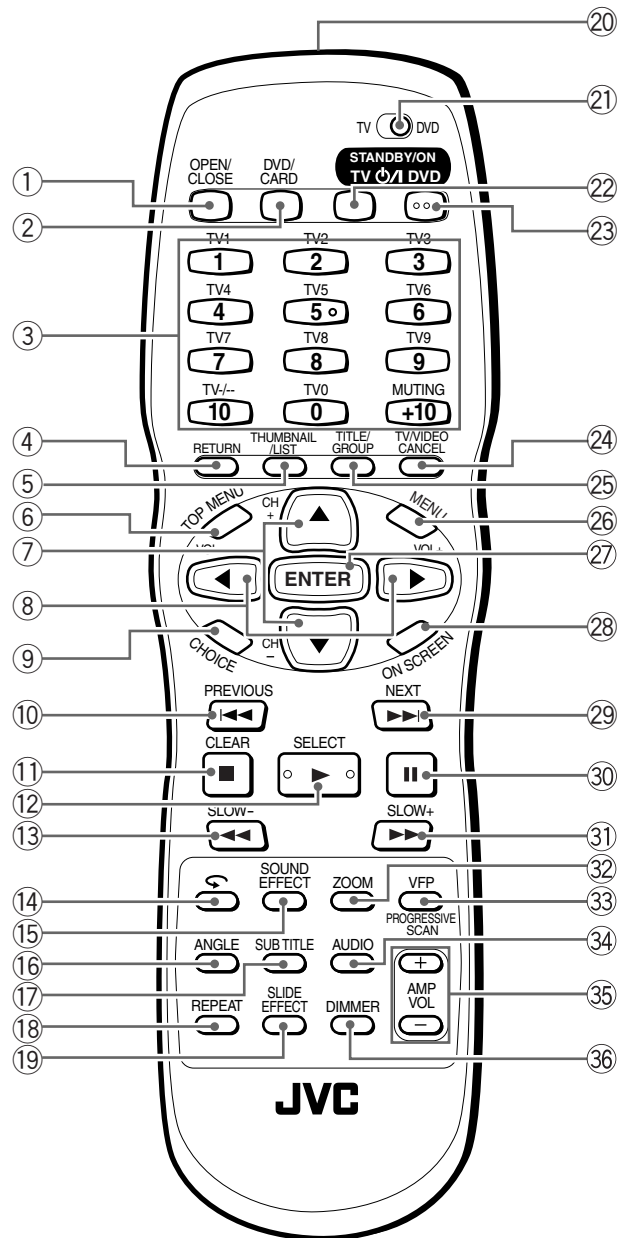

- |  |   |
|--|---|
| ① OPEN/CLOSE button (9)                                  | ⑳ Infrared signal window (6)            |
| ② DVD/CARD button (22, 25)                               | ㉑ TV - DVD switch (7, 8, 13, 22, 26)    |
| ③ Numeric buttons  | ㉒ TV STANDBY/ON ⏻/⏻ button (7)          |
| ④ RETURN button (13)                                     | ㉓ DVD STANDBY/ON ⏻/⏻ button (8)         |
| ⑤ THUMBNAIL/LIST button (23)                             | ㉔ TV/VIDEO - CANCEL button (7, 15)      |
| ⑥ TOP MENU button (13)                                   | ㉕ TITLE/GROUP button (13, 23)           |
| ⑦ Cursor selection (▲ Up, ▼ Down) - CH (+/-) buttons     | ㉖ MENU button (13)                      |
| ⑧ Cursor selection (◀ Left, ▶ Right) - VOL (+/-) buttons | ㉗ ENTER button                          |
| ⑨ CHOICE button (8, 26)                                  | ㉘ ON SCREEN button (10, 14, 16, 19)     |
| ⑩ ◀/PREVIOUS button (11, 12, 22)                         | ㉙ ▶/NEXT button (11, 12, 22)            |
| ⑪ ■/CLEAR button (10, 15, 16, 22)                        | ㉚ ⏏ button (10, 23)                     |
| ⑫ ▶/SELECT button (9, 11, 22)                            | ㉛ ▶/SLOW+ button (11)                   |
| ⑬ ◀/SLOW- button (11)                                    | ㉜ ZOOM button (18, 23)                  |
| ⑭ ⏻ button (12)  | ㉝ VFP - PROGRESSIVE SCAN button (4, 18) |
| ⑮ SOUND EFFECT button (19)                               | ㉞ AUDIO button (17)                     |
| ⑯ ANGLE button (17)                                      | ㉟ AMP VOL +/- buttons (7)               |
| ⑰ SUBTITLE button (17)                                   | ㊱ DIMMER button (9)                     |
| ⑱ REPEAT button (16, 25)                                 |   |
| ㉑ SLIDE EFFECT button (24)                               |   |

## AV COMPU LINK remote control system

The JVC AV COMPU LINK system allows you to enjoy video or audio with the simplest operation. If your video/audio player (such as a DVD player, CD player and VCR) and television or/and amplifier/receiver support the JVC AV COMPU LINK system and are tied with the JVC AV COMPU LINK cable(s), simply starting the player will automatically make all necessary settings on the television and/or amplifier/receiver to allow you to enjoy the playback.

### AV COMPU LINK

#### Connection and setup

Using an AV COMPU LINK cable, connect the AV COMPU LINK terminals of each component to one another.

- The player's AV COMPU LINK setting is controlled using the OTHERS menu in the preference display. See page 28.
- For information on the connection between a TV and a receiver, refer to the receiver's instructions.

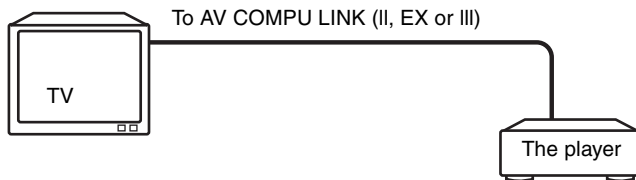

- If you connect the player to a television via AV COMPU LINK, set the player's AV COMPU LINK setting as follows.
  - When connecting to the VIDEO-1 input terminal of the television: DVD2
  - When connecting to the VIDEO-2 input terminal of the television: DVD3

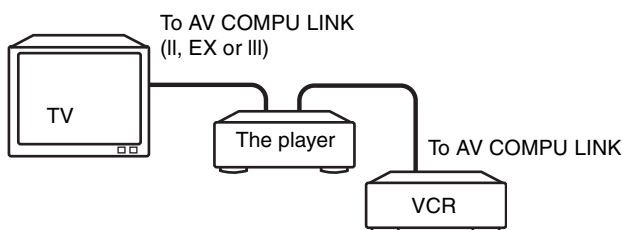

- If you connect the player to a television and VCR via AV COMPU LINK, set the VCR's Remote Control Code and the player's AV COMPU LINK setting as follows.
  - When connecting to the VIDEO-1 input terminal of the television:
    - The player's AV COMPU LINK setting: DVD2
    - VCR's Remote Control Code: B
  - When connecting to the VIDEO-2 input terminal of the television:
    - The player's AV COMPU LINK setting: DVD3
    - VCR's Remote Control Code: A

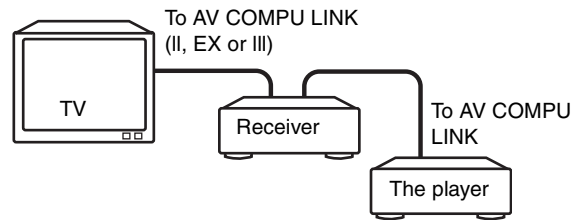

- If you connect the player to a television and receiver via AV COMPU LINK, set the player's AV COMPU LINK setting to DVD1.

#### IMPORTANT!

When you make video connection between the player and another device (such as a receiver and TV) via the composite, S-video or component jacks, as well as AV COMPU LINK connection, see also the instruction manual of the other device.

#### Notes for connection

- If you connect the player to a receiver via AV COMPU LINK in a system including a Dolby Digital decoder, some functions may not be performed automatically.
- Connect the AUDIO OUT jacks of the player to the audio input jacks of a receiver indicating "DVD." Otherwise, the system will not work correctly.
- There may be no description about connections to the player in the instruction manual of a television or VCR. However, a television or VCR with AV COMPU LINK terminals indicating "II," "EX" or "III" can be connected to the player.

#### Operation

The JVC AV COMPU LINK system allows you to enjoy video and/or audio by simply pressing Play on the source component (the component which plays back the video or audio, such as a DVD player or VCR). You do not even have to switch on power on the TV or receiver.

- 1 Turn on the main power of the television.**
- 2 Insert a disc (or tape) into the source component.**
- 3 Press ► of the source component.**

The following actions are performed automatically:

- Turning on the television power.
- Setting the source of the television to the external input (VIDEO-1 or VIDEO-2).
- Turning on receiver power.
- Setting the source of the receiver to the component which has started playback.

---

### Troubleshooting

---

#### Power

**Power does not come on.**

- ➔ Power plug is not inserted securely. Plug in securely.

---

#### Operation

**“REGION CODE ERROR!” is shown on the TV screen.**

- ➔ Region code of the inserted disc does not match the player.  
Check the region code of the disc printed on the disc jacket.

**Operation is not possible.**

- ➔ Microcomputer malfunction due to lightning or static electricity.  
Turn off the power and unplug the power cord, then connect the power cord again.
- ➔ Moisture condensation caused by a sudden change of temperature or humidity. Turn off the power, then turn it on a few hours later.
- ➔ The disc does not allow the operation, or an unplayable disc is inserted. Check and replace the disc (see page 2).

**[LOCK] is displayed on the display window and the disc tray does not open.**

- ➔ When you press ▲ while pressing down ■ on the player in standby mode, the tray lock function is activated. The disc tray cannot be opened or closed in this status. To release this status, press ▲ while pressing down ■ on the player in standby mode.

---

#### Picture

**Picture is noisy.**

- ➔ The player is connected to a VCR directly and the copyguard function is activated. Connect the player so that the picture signal flows directly to the TV.
- ➔ With some discs, the picture may be blurred when [PICTURE SOURCE] is set to [FILM] or [AUTO]. Set [PICTURE SOURCE] to [VIDEO(NORMAL)] or [VIDEO(ACTIVE)].

**Picture is distorted when using COMPONENT VIDEO OUT or S-VIDEO output jack(s).**

- ➔ Both the component connection and S-video connection are made. Disconnect the unused one.

---

#### Audio

**DVD VIDEO disc playback sound level is lower than TV broadcast sound level.**

- ➔ Set the [D.RANGE CONTROL] preference to [TV MODE] (see page 28).

**Analog audio output is distorted.**

- ➔ Set the [OUTPUT LEVEL] preference to [LOW] (see page 28).

**The digital sound is not outputted through the player's DIGITAL OUT terminals.**

- ➔ Set the [DIGITAL AUDIO OUTPUT] preference to other than [OFF] (see page 28).

---

#### MP3/WMA/JPEG/MPEG-4

**No sound and/or no picture comes out.**

- ➔ MP3/WMA/MPEG-4 disc is recorded with the “packet writing (UDF format).” It cannot be played.
- ➔ Check the files you want to play back.

**Files (tracks) are not played in the recorded order.**

- ➔ This player plays the files in the alphabetic order. So, the playback order can vary.

**WMA files cannot be played back.**

- ➔ The file is copy protected.
- ➔ The file is recorded with a bit rate under 48 kbps. The player does not support such WMA files.

**MPEG-4 files cannot be played back.**

- ➔ The format of the file is not asf.

## Specifications

Specifications and appearance are subject to change without prior notice.

### General

Readable discs	DVD VIDEO, DVD-R (Video format), DVD-RW (Video format), SVCD, Video CD, Audio CD (CD-DA), CD-R/RW (CD-DA, SVCD, Video CD, MP3/WMA format, JPEG, MPEG-4)
Readable cards	SD card, Multi Media Card, Smart Media, CompactFlash, Memory Stick (MP3/WMA format, JPEG, MPEG-4)
Video format	NTSC, 480i (Interlaced scan)/480p (Progressive scan) selectable

### Other

Power requirements*	AC 120 V $\sim$ , 60 Hz
Power consumption*	12 W (POWER ON), 2.7 W (STANDBY mode)
Mass	2.1 kg (4.7 lbs)
Dimensions (W $\times$ H $\times$ D)	435 mm $\times$ 48 mm $\times$ 270.5 mm (17 <sup>-3/16</sup> inch $\times$ 1 <sup>-15/16</sup> inch $\times$ 10 <sup>-11/16</sup> inch)

### Video outputs

COMPONENT (pin jacks)	Y Output: 1.0 Vp-p (75 $\Omega$ ) P <sub>B</sub> /P <sub>R</sub> Output: 0.7 Vp-p (75 $\Omega$ )
VIDEO OUT (pin jack)	1.0 Vp-p (75 $\Omega$ )
S-VIDEO OUT (S jack)	Y Output: 1.0 Vp-p (75 $\Omega$ ) C Output: 286 mVp-p (75 $\Omega$ )
Horizontal resolution	500 lines or more

### Audio outputs

ANALOG OUT (pin jack)	2.0 Vrms (10 k $\Omega$ )
DIGITAL OUT (COAXIAL)	0.5 Vp-p (75 $\Omega$ termination)
DIGITAL OUT (OPTICAL)	-21 dBm to -15 dBm (peak)

### Audio characteristics

Frequency response	CD (sampling frequency 44.1 kHz): 2 Hz to 20 kHz DVD (sampling frequency 48 kHz): 2 Hz to 22 kHz (4 Hz to 20 kHz for DTS and Dolby Digital bitstream signals) DVD (sampling frequency 96 kHz): 2 Hz to 44 kHz
Dynamic range	16 bit: More than 98 dB 20/24 bit: More than 100 dB
Wow and flutter	Unmeasurable (less than + 0.002%)
Total harmonic distortion	less than 0.006%

**\* Notes for PX model (Check the specification indication on the rear panel.)**

Power requirements AC 110 V to 240 V  $\sim$ , 50 Hz/60 Hz  
Power consumption 12 W (POWER ON), 3 W (STANDBY mode)

- Manufactured under license from Dolby Laboratories. "Dolby" and the double-D symbol are trademarks of Dolby Laboratories.
- "DTS" and "DTS Digital Out" are trademarks of Digital Theater Systems, Inc.

Appendix A: Country/Area code list for Parental Lock

(for page 29)

AD	Andorra
AE	United Arab Emirates
AF	Afghanistan
AG	Antigua and Barbuda
AI	Anguilla
AL	Albania
AM	Armenia
AN	Netherlands Antilles
AO	Angola
AQ	Antarctica
AR	Argentina
AS	American Samoa
AT	Austria
AU	Australia
AW	Aruba
AZ	Azerbaijan
BA	Bosnia and Herzegovina
BB	Barbados
BD	Bangladesh
BE	Belgium
BF	Burkina Faso
BG	Bulgaria
BH	Bahrain
BI	Burundi
BJ	Benin
BM	Bermuda
BN	Brunei Darussalam
BO	Bolivia
BR	Brazil
BS	Bahamas
BT	Bhutan
BV	Bouvet Island
BW	Botswana
BY	Belarus
BZ	Belize
CA	Canada
CC	Cocos (Keeling) Islands
CF	Central African Republic
CG	Congo
CH	Switzerland
CI	Côte d'Ivoire
CK	Cook Islands
CL	Chile
CM	Cameroon
CN	China
CO	Colombia
CR	Costa Rica
CU	Cuba
CV	Cape Verde
CX	Christmas Island
CY	Cyprus
CZ	Czech Republic
DE	Germany
DJ	Djibouti
DK	Denmark
DM	Dominica
DO	Dominican Republic
DZ	Algeria
EC	Ecuador
EE	Estonia
EG	Egypt
EH	Western Sahara
ER	Eritrea

ES	Spain
ET	Ethiopia
FI	Finland
FJ	Fiji
FK	Falkland Islands
FM	Micronesia (Federated States of)
FO	Faroe Islands
FR	France
FX	France, Metropolitan
GA	Gabon
GB	United Kingdom
GD	Grenada
GE	Georgia
GF	French Guiana
GH	Ghana
GI	Gibraltar
GL	Greenland
GM	Gambia
GN	Guinea
GP	Guadeloupe
GQ	Equatorial Guinea
GR	Greece
GS	South Georgia and the South Sandwich
GT	Guatemala
GU	Guam
GW	Guinea-Bissau
GY	Guyana
HK	Hong Kong
HM	Heard Island and McDonald Islands
HN	Honduras
HR	Croatia
HT	Haiti
HU	Hungary
ID	Indonesia
IE	Ireland
IL	Israel
IN	India
IO	British Indian Ocean Territory
IQ	Iraq
IR	Iran (Islamic Republic of)
IS	Iceland
IT	Italy
JM	Jamaica
JO	Jordan
JP	Japan
KE	Kenya
KG	Kyrgyzstan
KH	Cambodia
KI	Kiribati
KM	Comoros
KN	Saint Kitts and Nevis
KP	Korea, Democratic People's Republic of
KR	Korea, Republic of
KW	Kuwait
KY	Cayman Islands
KZ	Kazakhstan
LA	Lao People's Democratic Republic
LB	Lebanon
LC	Saint Lucia

LI	Liechtenstein
LK	Sri Lanka
LR	Liberia
LS	Lesotho
LT	Lithuania
LU	Luxembourg
LV	Latvia
LY	Libyan Arab Jamahiriya
MA	Morocco
MC	Monaco
MD	Moldova, Republic of
MG	Madagascar
MH	Marshall Islands
ML	Mali
MM	Myanmar
MN	Mongolia
MO	Macau
MP	Northern Mariana Islands
MQ	Martinique
MR	Mauritania
MS	Montserrat
MT	Malta
MU	Mauritius
MV	Maldives
MW	Malawi
MX	Mexico
MY	Malaysia
MZ	Mozambique
NA	Namibia
NC	New Caledonia
NE	Niger
NF	Norfolk Island
NG	Nigeria
NI	Nicaragua
NL	Netherlands
NO	Norway
NP	Nepal
NR	Nauru
NU	Niue
NZ	New Zealand
OM	Oman
PA	Panama
PE	Peru
PF	French Polynesia
PG	Papua New Guinea
PH	Philippines
PK	Pakistan
PL	Poland
PM	Saint Pierre and Miquelon
PN	Pitcairn
PR	Puerto Rico
PT	Portugal
PW	Palau
PY	Paraguay
QA	Qatar
RE	Réunion
RO	Romania
RU	Russian Federation
RW	Rwanda
SA	Saudi Arabia
SB	Solomon Islands
SC	Seychelles
SD	Sudan

SE	Sweden
SG	Singapore
SH	Saint Helena
SI	Slovenia
SJ	Svalbard and Jan Mayen
SK	Slovakia
SL	Sierra Leone
SM	San Marino
SN	Senegal
SO	Somalia
SR	Suriname
ST	Sao Tome and Principe
SV	El Salvador
SY	Syrian Arab Republic
SZ	Swaziland
TC	Turks and Caicos Islands
TD	Chad
TF	French Southern Territories
TG	Togo
TH	Thailand
TJ	Tajikistan
TK	Tokelau
TM	Turkmenistan
TN	Tunisia
TO	Tonga
TP	East Timor
TR	Turkey
TT	Trinidad and Tobago
TV	Tuvalu
TW	Taiwan
TZ	Tanzania, United Republic of
UA	Ukraine
UG	Uganda
UM	United States Minor Outlying Islands
US	United States
UY	Uruguay
UZ	Uzbekistan
VA	Vatican City State (Holy See)
VC	Saint Vincent and the Grenadines
VE	Venezuela
VG	Virgin Islands (British)
VI	Virgin Islands (U.S.)
VN	Vietnam
VU	Vanuatu
WF	Wallis and Futuna Islands
WS	Samoa
YE	Yemen
YT	Mayotte
YU	Yugoslavia
ZA	South Africa
ZM	Zambia
ZR	Zaire
ZW	Zimbabwe

## Appendix B: Table of languages and their abbreviations

(for pages 17 and 27)

AA	Afar	FA	Persian	KM	Cambodian	OM	(Afan) Oromo	SU	Sundanese
AB	Abkhazian	FI	Finnish	KN	Kannada	OR	Oriya	SV	Swedish
AF	Afrikaans	FJ	Fiji	KO	Korean (KOR)	PA	Panjabi	SW	Swahili
AM	Ameharic	FO	Faroese	KS	Kashmiri	PL	Polish	TA	Tamil
AR	Arabic	FY	Frisian	KU	Kurdish	PS	Pashto, Pushto	TE	Telugu
AS	Assamese	GA	Irish	KY	Kirghiz	PT	Portuguese	TG	Tajik
AY	Aymara	GD	Scots Gaelic	LA	Latin	QU	Quechua	TH	Thai
AZ	Azerbaijani	GL	Galician	LN	Lingala	RM	Rhaeto-Romance	TI	Tigrinya
BA	Bashkir	GN	Guarani	LO	Laothian	RN	Kirundi	TK	Turkmen
BE	Byelorussian	GU	Gujarati	LT	Lithuanian	RO	Rumanian	TL	Tagalog
BG	Bulgarian	HA	Hausa	LV	Latvian, Lettish	RU	Russian	TN	Setswana
BH	Bihari	HI	Hindi	MG	Malagasy	RW	Kinyarwanda	TO	Tongan
BI	Bislama	HR	Croatian	MI	Maori	SA	Sanskrit	TR	Turkish
BN	Bengali, Bangla	HU	Hungarian	MK	Macedonian	SD	Sindhi	TS	Tsonga
BO	Tibetan	HY	Armenian	ML	Malayalam	SG	Sangho	TT	Tatar
BR	Breton	IA	Interlingua	MN	Mongolian	SH	Serbo-Croatian	TW	Twi
CA	Catalan	IE	Interlingue	MO	Moldavian	SI	Singhalese	UK	Ukrainian
CO	Corsican	IK	Inupiak	MR	Marathi	SK	Slovak	UR	Urdu
CS	Czech	IN	Indonesian	MS	Malay (MAY)	SL	Slovenian	UZ	Uzbek
CY	Welsh	IS	Icelandic	MT	Maltese	SM	Samoan	VI	Vietnamese
DA	Danish	IW	Hebrew	MY	Burmese	SN	Shona	VO	Volapuk
DZ	Bhutani	JI	Yiddish	NA	Nauru	SO	Somali	WO	Wolof
EL	Greek	JW	Javanese	NE	Nepali	SQ	Albanian	XH	Xhosa
EO	Esperanto	KA	Georgian	NL	Dutch	SR	Serbian	YO	Yoruba
ET	Estonian	KK	Kazakh	NO	Norwegian	SS	Siswati	ZU	Zulu
EU	Basque	KL	Greenlandic	OC	Occitan	ST	Sesotho		

## Appendix C: Digital output signal chart

(for page 28)

Source type	Output			
	PCM ONLY	DOLBY DIGITAL/PCM	STREAM/PCM	OFF
DVD with 48 kHz, 16/20/24 bit linear PCM	48/ kHz, 16 bit, stereo linear PCM			Cannot be outputted
DVD with 96 kHz, 16/22/24 bit linear PCM				
DVD with DTS	48kHz, 16 bit, stereo linear PCM		DTS bitstream	
DVD with Dolby Digital	48 kHz, 16 bit, stereo linear PCM	Dolby Digital bitstream		
DVD with MPEG Multichannel	48 kHz, 16 bit, stereo linear PCM		MPEG bitstream	
SVCD/Video CD/Audio CD	44.1 kHz, 16 bit, stereo linear PCM			
Audio CD with DTS	48kHz, 16 bit, stereo linear PCM		DTS bitstream	
CD-R/RW or memory card recorded MP3/WMA	Linear PCM			
CD-R/RW or memory card recorded MPEG-4	Cannot be outputted			

Additional information

# Appendix D: Glossary

### 480i/480p

Indicates the number of scanning lines and scanning format of an image signal. 480i indicates 480 scanning lines with interlace format, and 480p indicates 480 scanning lines with progressive format.

### ASF

ASF is an abbreviation of "Advanced Streaming Format," and is a data compression format for streaming developed by Microsoft Corporation. ASF can contain the various data types such as audio, video, and text.

### Aspect ratio

A ratio which defines the shape of the rectangular picture in a TV. It is the width of the picture relative to the height. A conventional TV picture is 4:3 in aspect ratio.

### Bitstream

The digital form of multichannel audio data (e.g., 5.1-channel) before it is decoded into its various channels.

### Chapter/title

Chapter is the smallest division and title is the largest division on DVD VIDEO. A chapter is a division of a title and similar to a track for Video CD or Audio CD.

### Component video

Video signals with three channels of separate information that makes up the picture. There are some types of component video, such as R/G/B and Y/C<sub>B</sub>(P<sub>B</sub>)/C<sub>R</sub>(P<sub>R</sub>).

### Composite video

A single video signal commonly used in most consumer video products that contains all luminance, color, and synchronization information.

### Dolby Digital (AC3)

A six-channel system consisting of left, center, right, left rear, right rear and LFE (Low-Frequency Effect channel, for use with a sub-woofer) channels. All processing is done in the digital domain. Not all Dolby Digital discs contain six (5.1) channels of information.

### Dolby Surround/Dolby Pro Logic

Dolby Surround records four channels of front and rear audio in two channels in a way that allows a decoder to recover the original four channels for playback. Because the audio is recorded in two channels, it can be played back naturally by a two-channel stereo system. Dolby Pro Logic introduces directional circuits in decoder-side processing (increasing the level of specific channels and lowering the level of silent channels) for greater spatial perspective, and adds a center speaker used primarily for dialog. The result is enhanced channel separation.

### Down-mix

Internal stereo mix of multichannel surround audio by a DVD player. The down-mix signals are output from stereo output connectors.

### DTS

A Digital Surround audio encoding format configured with six (5.1) channels, similar to Dolby Digital. It requires a decoder, either in the player or in an external receiver. DTS stands for Digital Theater Systems. Not all DTS discs contain six (5.1) channels of information.

### Dynamic range

The difference between the loudest and softest sounds.

### Interlaced scanning

In a conventional video system, a picture is shown on the display monitor in between lines of two halves. The Interlaced scanning system places lines of the second half of the picture in-between lines of the first half of the picture.

### JPEG

A popular file format for still image compression and storage. JPEG stands for Joint Photographic Experts Group. There are three sub-types of the JPEG format as follows.

- baseline JPEG: used for digital cameras, the web, etc.
- progressive JPEG: used for the web
- lossless JPEG: an old type, rarely used now

### Linear PCM audio

PCM stands for "pulse code modulation." Linear PCM is the usual method for digitally encoding audio without compression, and is used for the audio tracks on DVD VIDEO discs, Audio CDs, etc.

### MP3

MP3 is an audio data compression format, which stands for MPEG-1 Audio Layer 3. Using MP3, you can achieve a data reduction of about 1:10.

### MPEG-4

MPEG-4 is an audio/video data compression format, which is highly efficient and more stable than MPEG-1 and MPEG-2.

### NTSC (National television system committee)

A black and white and color television system format used in the U.S.A., Canada, Mexico and Japan.

### PAL (Phase Alternation by Line)

A color television system format used extensively in Western Europe.

### PBC

PBC stands for "Playback control" and is a method of controlling disc play for Video CDs (VCD). You are able to interact with the disc through menus.

### Progressive scanning

Progressive scanning displays all the horizontal lines of a picture at one time, as a single frame. A progressive scanning DVD player converts the interlaced (480i) video from DVD into progressive (480p) format for connection to a progressive display. It dramatically increases the vertical resolution.

### S-video

A video signal which improves picture quality over standard composite connections. Used on Super VHS, DVD, high end TV monitors, etc.

### Track

The smallest division on SVCD, Video CD and Audio CD discs.

### WMA

WMA is an abbreviation of "Windows Media Audio," and is an audio data compression format developed by Microsoft Corporation. Sound quality of data compressed using WMA is the same as that of MP3, though the WMA file size is smaller than that of MP3.





# LIMITED WARRANTY

CONSUMER VIDEO 1-90

JVC COMPANY OF AMERICA warrants this product and all parts thereof, except as set forth below ONLY TO THE ORIGINAL PURCHASER AT RETAIL to be FREE FROM DEFECTIVE MATERIALS AND WORKMANSHIP from the date of original retail purchase for the period as shown below. ("The Warranty Period")

PARTS	<b>1 YR</b>	LABOR	<b>90 DAYS</b>
-------	-------------	-------	----------------

THIS LIMITED WARRANTY IS VALID ONLY IN THE FIFTY (50) UNITED STATES, THE DISTRICT OF COLUMBIA AND IN COMMONWEALTH OF PUERTO RICO.

**WHAT WE WILL DO:**

If this product is found to be defective, JVC will repair or replace defective parts at no charge to the original owner. Such repair and replacement services shall be rendered by JVC during normal business hours at JVC authorized service centers. Parts used for replacement are warranted only for the remainder of the Warranty Period. All products and parts thereof may be brought to a JVC authorized service center on a carry-in basis except for Television sets having a screen size 25 inches and above which are covered on an in-home basis.

**WHAT YOU MUST DO FOR WARRANTY SERVICE:**

Return your product to a JVC authorized service center with a copy of your bill of sale. For your nearest JVC authorized service center, please call toll free: (800) 537-5722.

If service is not available locally, box the product carefully, preferably in the original carton, and ship, insured, with a copy of your bill of sale plus a letter of explanation of the problem to the nearest JVC Factory Service Center, the name and location of which will be given to you by the toll-free number.

If you have any questions concerning your JVC Product, please contact our Customer Relations Department.

**WHAT IS NOT COVERED:**

This limited warranty provided by JVC does not cover:

1. Products which have been subject to abuse, accident, alteration, modification, tampering, negligence, misuse, faulty installation, lack of reasonable care, or if repaired or serviced by anyone other than a service facility authorized by JVC to render such service, or if affixed to any attachment not provided with the products, or if the model number or serial number has been altered, tampered with, defaced or removed;
2. Initial installation and installation and removal for repair;
3. Operational adjustments covered in the Owner's Manual, normal maintenance, video and audio head cleaning;
4. Damage that occurs in shipment, due to act of God, and cosmetic damage;
5. Signal reception problems and failures due to line power surge;
6. Video Pick-up Tubes/CCD Image Sensor, Cartridge, Stylus (Needle) are covered for 90 days from the date of purchase;
7. Accessories;
8. Batteries (except that Rechargeable Batteries are covered for 90 days from the date of purchase);

There are no express warranties except as listed above.

THE DURATION OF ANY IMPLIED WARRANTIES, INCLUDING THE IMPLIED WARRANTY OF MERCHANTABILITY, IS LIMITED TO THE DURATION OF THE EXPRESS WARRANTY HEREIN.

JVC SHALL NOT BE LIABLE FOR THE LOSS OF USE OF THE PRODUCT, INCONVENIENCE, LOSS OR ANY OTHER DAMAGES, WHETHER DIRECT, INCIDENTAL OR CONSEQUENTIAL (INCLUDING, WITHOUT LIMITATION, DAMAGE TO TAPES, RECORDS OR DISCS) RESULTING FROM THE USE OF THIS PRODUCT, OR ARISING OUT OF ANY BREACH OF THIS WARRANTY. ALL EXPRESS AND IMPLIED WARRANTIES, INCLUDING THE WARRANTIES OF MERCHANTABILITY AND FITNESS FOR PARTICULAR PURPOSE, ARE LIMITED TO THE WARRANTY PERIOD SET FORTH ABOVE.

Some states do not allow the exclusion of incidental or consequential damages or limitations on how long an implied warranty lasts, so these limitations or exclusions may not apply to you. This warranty gives you specific legal rights and you may also have other rights which vary from state to state.

JVC COMPANY OF AMERICA                      1700 Valley Road  
 DIVISION OF JVC AMERICAS CORP.            Wayne, NJ 07470

REFURBISHED PRODUCTS CARRY A SEPARATE WARRANTY, THIS WARRANTY DOES NOT APPLY. FOR DETAILS OF REFURBISHED PRODUCT WARRANTY, PLEASE REFER TO THE REFURBISHED PRODUCT WARRANTY INFORMATION PACKAGED WITH EACH REFURBISHED PRODUCT.

**For customer use:**

Enter below the Model No. which is located either on the rear, bottom or side of the cabinet. Retain this information for future reference.

Model No. : _____	Serial No. : _____
Purchase data : _____	Name of dealer : _____

# Authorized Service Centers

---

QUALITY **JVC**<sup>®</sup> SERVICE  
*HOW TO LOCATE YOUR JVC SERVICE CENTER*  
**TOLL FREE: 1 (800) 537-5722**  
**<http://www.jvc.com>**

Dear Customer,

In order to receive the most satisfaction from your purchase, please read the instruction booklet before operating the unit. In the event that repairs are necessary, please call 1 (800)537-5722 for your nearest authorized servicer or visit our website at **[www.JVC.com](http://www.JVC.com)**

Remember to retain your Bill of Sale for Warranty Service.

---

## **Do not service the television yourself**

---

### **Caution**

To prevent electrical shock, do not open the cabinet. There are no user serviceable parts inside. Please refer to qualified service personnel for repairs.

### **Accessories**

To purchase accessories for your JVC product, please call toll free: 1 (800)882-2345 or on the web at **[www.JVC.com](http://www.JVC.com)**

---



## Free Manuals Download Website

<http://myh66.com>

<http://usermanuals.us>

<http://www.somanuals.com>

<http://www.4manuals.cc>

<http://www.manual-lib.com>

<http://www.404manual.com>

<http://www.luxmanual.com>

<http://aubethermostatmanual.com>

Golf course search by state

<http://golfingnear.com>

Email search by domain

<http://emailbydomain.com>

Auto manuals search

<http://auto.somanuals.com>

TV manuals search

<http://tv.somanuals.com>