

JVC®

U E

JVC®

DVD RECORDER

BD-X200U

INSTRUCTIONS

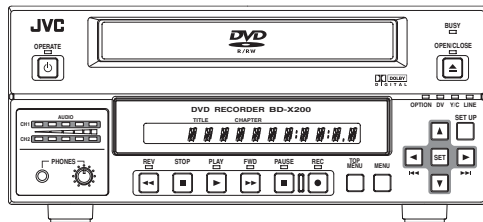

Thank you for purchasing this JVC product. Before operating this unit, please read the instructions carefully to ensure the best possible performance.

For Customer Use :

Enter below the Serial No. which is located on the bottom of the unit. Retain this information for future reference.

Model No. BD-X200U

Serial No. \_\_\_\_\_

LLT0060-001A-C

DVD RECORDER  
DVD-RECORDER  
ENREGISTREUR DE DVD  
GRABADORA DE DVD  
MASTERIZZATORE DVD

BD-X200E

INSTRUCTIONS  
BEDIENUNGSANLEITUNG  
MANUEL D'INSTRUCTIONS  
INSTRUCCIONES  
ISTRUZIONI

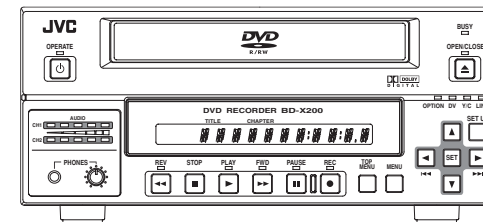

Thank you for purchasing this JVC product. Before operating this unit, please read the instructions carefully to ensure the best possible performance.

LLT0061-001A-C

English

Deutsch

Français

Español

Italiano

## IMPORTANT SAFEGUARDS

1. Read all of these instructions.
2. Save these instructions for later use.
3. All warnings on the product and in the operating instructions should be adhered to.
4. Unplug this appliance system from the wall outlet before cleaning. Do not use liquid cleaners or aerosol cleaners. Use a damp cloth for cleaning.
5. Do not use attachments not recommended by the appliance manufacturer as they may cause hazards.
6. Do not use this appliance near water - for example, near a bathtub, washbowl, kitchen sink, or laundry tub, in a wet basement, or near a swimming pool, etc.
7. Do not place this appliance on an unstable cart, stand, or table. The appliance may fall, causing serious injury to a child or adult, and serious damage to the appliance.
 

Use only with a cart or stand recommended by the manufacturer, or sold with the appliance. Wall or shelf mounting should follow the manufacturer's instructions, and should use a mounting kit approved by the manufacturer. An appliance and cart combination should be moved with care. Quick stops, excessive force, and uneven surfaces may cause the appliance and cart combination to overturn.

PORTABLE CART WARNING  
(symbol provided by RETAG)



S3125A
8. Slots and openings in the cabinet and the back or bottom are provided for ventilation, and to insure reliable operation of the appliance and to protect it from overheating, these openings must not be blocked or covered. The openings should never be blocked by placing the appliance on a bed, sofa, rug, or other similar surface. This appliance should never be placed near or over a radiator or heat register. This appliance should not be placed in a built-in installation such as a bookcase unless proper ventilation is provided.
9. This appliance should be operated only from the type of power source indicated on the marking label. If you are not sure of the type of power supplied to your home, consult your dealer or local power company. For appliance designed to operate from battery power, refer to the operating instructions.
10. This appliance system is equipped with a 3-wire grounding type plug (a plug having a third (grounding) pin). This plug will only fit into a grounding-type power outlet. This is a safety feature. If you are unable to insert the plug into the outlet, contact your electrician to replace your obsolete outlet. Do not defeat the safety purpose of the grounding plug.
11. For added protection for this product during a lightning storm, or when it is left unattended and unused for long periods of time, unplug it from the wall outlet and disconnect the antenna or cable system. This will prevent damage to the product due to lightning and power-line surges.
12. Do not allow anything to rest on the power cord. Do not locate this appliance where the cord will be abused by persons walking on it.
13. Follow all warnings and instructions marked on the appliance.
14. Do not overload wall outlets and extension cords as this can result in fire or electric shock.
15. Never push objects of any kind into this appliance through cabinet slots as they may touch dangerous voltage points or short out parts that could result in a fire or electric shock. Never spill liquid of any kind on the appliance.
16. Do not attempt to service this appliance yourself as opening or removing covers may expose you to dangerous voltage or other hazards. Refer all servicing to qualified service personnel.
17. Unplug this appliance from the wall outlet and refer servicing to qualified service personnel under the following conditions:
  - a. When the power cord or plug is damaged or frayed.
  - b. If liquid has been spilled into the appliance.
  - c. If the appliance has been exposed to rain or water.
  - d. If the appliance does not operate normally by following the operating instructions. Adjust only those controls that are covered by the operating instructions as improper adjustment of other controls may result in damage and will often require extensive work by a qualified technician to restore the appliance to normal operation.
  - e. If the appliance has been dropped or the cabinet has been damaged.
  - f. When the appliance exhibits a distinct change in performance - this indicates a need for service.
18. When replacement parts are required, be sure the service technician has used replacement parts specified by the manufacturer that have the same characteristics as the original part. Unauthorized substitutions may result in fire, electric shock, or other hazards.
19. Upon completion of any service or repairs to this appliance, ask the service technician to perform routine safety checks to determine that the appliance is in safe operating condition.

## Supplement

This apparatus is designed for rack mounting or is used close to other apparatus.

In order to keep the best performance and furthermore for electromagnetic compatibility we recommend to use cables not exceeding the following lengths:

Port	Cable	Length
Y/C	Coaxial cable	10 meters
VIDEO LINE	Coaxial cable	10 meters
AUDIO LINE	Shielded cable	10 meters
REMOTE (9P)	Shielded Twist Pair cable	5 meters
DV	Shielded Twist Pair cable	4 meters
PHONES	Shielded Twist Pair cable	5 meters
MIC	Shielded Twist Pair cable	5 meters
LAN	Shielded Twist Pair cable	10 meters
USB	Shielded Twist Pair cable	5 meters
DC 19V	Shielded cable	1.2 meters

The inrush current of this apparatus is 19 amperes.

**Caution:**

- Where there are strong electromagnetic waves or magnetism, for example near a radio or TV transmitter, transformer, motor, etc., the picture and sound may be disturbed. In such a case, please keep the apparatus away from the sources of the disturbance.

## Safety Precautions

**CAUTION**

RISK OF ELECTRIC SHOCK  
DO NOT OPEN

CAUTION: TO REDUCE THE RISK OF ELECTRIC SHOCK, DO NOT REMOVE COVER (OR BACK). NO USER-SERVICEABLE PARTS INSIDE. REFER SERVICING TO QUALIFIED SERVICE PERSONNEL.

**ATTENTION**

RISQUE D'ELECTROCUTION  
NE PAS OUVRIR

ATTENTION: POUR EVITER TOUT RISQUE D'ELECTROCUTION NE PAS OUVRIR LE BOITIER. AUCUNE PIECE INTERIEURE N'EST A REGLER PAR L'UTILISATEUR. SE REFERER A UN AGENT QUALIFIE EN CAS DE PROBLEME.

The lightning flash with arrowhead symbol, within an equilateral triangle is intended to alert the user to the presence of uninsulated "dangerous voltage" within the product's enclosure that may be of sufficient magnitude to constitute a risk of electric shock to persons.

Le symbole de l'éclair à l'intérieur d'un triangle équilatéral est destiné à alerter l'utilisateur sur la présence d'une "tension dangereuse" non isolée dans le boîtier du produit. Cette tension est suffisante pour provoquer l'électrocution de personnes.

The exclamation point within an equilateral triangle is intended to alert the user to the presence of important operating and maintenance (servicing) instructions in the literature accompanying the appliance.

Le point d'exclamation à l'intérieur d'un triangle équilatéral est destiné à alerter l'utilisateur sur la présence d'opérations d'entretien importantes au sujet desquelles des renseignements se trouvent dans le manuel d'instructions.

\*Ces symboles ne sont utilisés qu'aux Etats-Unis.

**WARNING:**  
TO REDUCE THE RISK OF FIRE OR ELECTRIC SHOCK, DO NOT EXPOSE THIS APPLIANCE TO RAIN OR MOISTURE.

This unit should be used with 120 V AC only.

**CAUTION:**  
To prevent electric shocks and fire hazards, DO NOT use any other power source.

**Note:**  
The rating plate (serial number plate) is on the bottom of the unit.

**INFORMATION**  
This equipment has been tested and found to comply with the limits for a Class A digital device, pursuant to Part 15 of the FCC Rules. These limits are designed to provide reasonable protection against harmful interference when the equipment is operated in a commercial environment. This equipment generates, uses, and can radiate radio frequency energy and, if not installed and used in accordance with the instruction manual, may cause harmful interference to radio communications. Operation of this equipment in a residential area is likely to cause harmful interference in which case the user will be required to correct the interference at his own expense.

**CAUTION**  
CHANGES OR MODIFICATIONS NOT APPROVED BY JVC COULD VOID USER'S AUTHORITY TO OPERATE THE EQUIPMENT.

This Class A digital apparatus meets all requirements of the Canadian Interference-Causing Equipment Regulations.

**AVERTISSEMENT:**  
POUR EVITER LES RISQUES D'INCENDIE OU D'ELECTRO-CUTION, NE PAS EXPOSER L'APPAREIL A L'HUMIDITE OU A LA PLUIE.

Ce magnétoscope ne doit être utilisé que sur du courant alternatif en 120V.

**ATTENTION:**  
Afin d'éviter tout resque d'incendie ou d'électrocution, ne pas utiliser d'autres sources d'alimentation électrique.

**REMARQUE:**  
La plaque d'identification (numéro de série) se trouve sur le panneau arrière de l'appareil.

**WARNING:**  
The battery used in the BD-X200U must be replaced by a JVC authorized service dealer only.

Cet appareil numérique de la classe A respecte toutes les exigences du Règlement sur le matériel brouilleur du Canada.

## SAFETY PRECAUTIONS

**Warning Notice**  
**FOR YOUR SAFETY (Australia)**

1. Insert this plug only into effectively earthed three-pin power outlet.
2. If any doubt exists regarding the earthing, consult a qualified electrician.
3. Extension cord, if used, must be three-core correctly wired.

**IMPORTANT (In the United Kingdom)**  
**Mains Supply (AC 230 V `)**  
**WARNING – THIS APPARATUS**  
**MUST BE EARTHED**

The wires in this mains lead are coloured in accordance with the following code:  
GREEN-and-YELLOW : EARTH  
BLUE : NEUTRAL  
BROWN : LIVE

As the colours of the wires in the mains lead of this apparatus may not correspond with the coloured markings identifying the terminals in your plug, proceed as follows.

The wire which is coloured GREEN-AND-YELLOW must be connected to the terminal in the plug which is marked with the letter E or by the safety earth symbol  $\oplus$  or coloured GREEN or GREEN-AND-YELLOW. The wire which is coloured BLUE must be connected to the terminal which is marked with the letter N or which is coloured BLACK. The wire which is coloured BROWN must be connected to the terminal which is marked with the letter L or coloured RED.

**POWER SYSTEM**  
**Connection to the mains supply**  
This unit operates on voltage of 220 V to 240 V AC, 50 Hz/60 Hz.

**WARNING:**  
**TO REDUCE THE RISK OF FIRE OR ELECTRIC SHOCK, DO NOT EXPOSE THIS APPLIANCE TO RAIN OR MOISTURE.**

**CAUTION**  
To prevent electric shock, do not open the cabinet. No user serviceable parts inside. Refer servicing to qualified service personnel.

**WARNING**  
This is a Class A product. In a domestic environment this product may cause radio interference in which case the user may be required to take adequate measures.

**Note:**  
The rating plate and the safety caution are on the bottom of the unit.

The OPERATE button does not completely shut off mains power from the unit, but switches operating current on and off.

**WARNING**  
It should be noted that it may be unlawful to re-record pre-recorded tapes, records, or discs without the consent of the owner of copyright in the sound or video recording, broadcast, or cable programme and in any literary, dramatic, musical or artistic work embodied therein.

**Caution for AC Mains Lead**

**FOR YOUR SAFETY PLEASE READ THE FOLLOWING TEXT CAREFULLY.**  
This product is equipped with 2 types of AC cable. One is for continental Europe, etc. and the other one is only for U.K.  
Appropriate mains cable must be used in each local area, since the other type of mains cable is not suitable.

**FOR CONTINENTAL EUROPE, ETC.**  
Not to be used in the U.K.

**FOR U.K. ONLY**  
If the plug supplied is not suitable for your socket outlet, it should be cut off and appropriate one fitted.

**Thank you for purchasing  
this JVC BD-X200 DVD Recorder.**

**Main Features**

- Recording of DVD-R and DVD-RW (video mode only).
- Composite video, YC separate, and DV signals are supported as video inputs; furthermore, analog or DV signals are supported as audio inputs.
- A keyboard and mouse can be used as an alternative to front panel buttons.
- When the BD-X200 is connected to an RS-422A compatible VCR, RS-422 control can be used to carry out synchronous recording of the VCR's video and audio to a DVD.
- Synchronous recording of video and audio from a DV camera or video player to a DVD can also be carried out.
- The DV IN/OUT terminal can be used to record audio and video from a non-linear editor to a DVD.
- The title and chapter menus can be created either automatically or manually.
- This DVD recorder features a LAN terminal. Accordingly, two of these recorders can be connected using LAN (CAT 5) cables to perform master-to-receiver dubbing.

**Trademarks & Copyrights**

- Dolby and the Double "D" symbols are trademarks of Dolby Laboratories.
- The copying, broadcasting, screening, or rental of copyrighted material without the authorization of the copyright holder is prohibited by law.

**Copyright Protection Technology**

This DVD recorder utilizes copyright protection technology and is protected by US patents and intellectual property as owned by Macrovision and other copyright holders. The permission of Macrovision is required in order to use this copyright protection technology, and except in situations where special permission has been granted by that company, said technology is restricted to domestic usage and for certain other viewing purposes. The disassembly and/or modification of this DVD recorder is also prohibited.

**Copyrights**

- The recording, dubbing, or playing of software containing a copyright protection signal is not possible on this DVD recorder.
- The usage of audio or video discs created using this DVD recorder either for financial gain or in broadcasting for widespread viewing may result in the legally-enforceable rights of the copyright holder being infringed.
- Unless the permission of the copyright holder has been obtained, audio or video discs created using this DVD recorder are to be used for personal enjoyment only.

**Contents**

<b>Introduction</b>	
Overview of BD-X200 Functions .....	4
Precautions for DVD Recorder Use .....	5
Precautions for Disc Usage .....	6
Details Regarding Discs .....	7
<b>Component Names &amp; Functions</b>	
Front Panel .....	9
Rear Panel .....	12
<b>LCD Display and On-Screen Content</b>	
LCD Display .....	14
On-Screen Content .....	16
Status Messages .....	16
Disc Status .....	18
Event Messages .....	19
Alarm Messages .....	20
<b>Preparation</b>	
Signal Connections .....	21
Power Connections .....	23
Turning the Power On & Off .....	24
Inserting & Removing Discs .....	25
Using a Keyboard & Mouse .....	26
Setting & Displaying the Date & Time .....	27

**Settings & Controls for Recording**

DVD Recording .....	29
Preparing a Disc for Recording .....	30
Pre-Recording Settings .....	31
Selecting & Confirming Input Signals .....	32
Setting the Encoding Format for Audio & Video .....	33
Adjusting of Audio Recording Levels .....	35
Checking the Video Input .....	36
Selecting Styles for Title & Chapter Menu .....	37

**Recording**

Recording Sequence .....	38
Recording with the Front Panel .....	39
Inserting Chapter Marks Manually or Automatically .....	40
Using a Keyboard & Mouse to Control Recording .....	41
Finalizing (for playback on this and other DVD players) .....	42

**Title & Chapter Menu Settings**

BD-X200 Title & Chapter Menus .....	43
Selecting and Changing Styles for Title & Chapter Menus .....	44
Easymenu: Freeware for Editing Menu Templates .....	46
Changing Chapter Menus (THUMBNAIL EDIT screen) .....	47
Changing & Naming Thumbnails for Chapter Menus .....	48
Changing & Checking Chapter Menu Styles .....	50
Ending the Editing of Chapter Menus .....	52
Changing & Checking Title Menu Styles & Names .....	53

**Playback**

Playing Discs .....	57
Fast & Slow Playback .....	58
Playing the Previous or Next Chapter .....	58

**Synchronous Recording**

Recording Playback Signals From a VCR with RS-422A .....	59
Recording Playback Signals From a DV Camera or VCR .....	63
Recording Video & Audio From a Non-Linear Editor .....	64
In, Out & Chapter Points from External Edit Lists .....	68
Recording Operations Using a DV Camera Trigger .....	69

**DVD Dubbing**

Dubbing DVDs Using the LAN Terminal .....	70
---	----

**Setup Menu**

Setup Menu Configuration .....	74
Setting the Setup Menu .....	75
Restoring to Default Settings .....	75
Setup Menus .....	76
DISC MENU Screen .....	77
INPUT SELECT MENU screen .....	77
SYSTEM MENU Screen .....	78
PRESET STYLE MENU screen .....	79
RECORDER MENU Screen .....	80
REMOTE MENU screen .....	82
DISPLAY MENU screen .....	83
CLOCK ADJUST MENU screen .....	84
DUBBING screen .....	84
NETWORK MENU Screen .....	85

**Others**

Troubleshooting .....	85
Specifications .....	86

# Introduction

## Overview of BD-X200 Functions

### ■ Video and audio signals from this DVD recorder's input terminals can be recorded to DVD-R or DVD-RW (video mode only). (☞ Page 29)

The types of signals that can be used are as follows.  
Video: Composite video, YC separate, or DV signals (including audio)  
Audio: Analog audio or DV signals (including video)

### ■ A wide range of recording methods are supported. The appropriate method is to be selected in accordance with the intended mode of use.

- The REC, PAUSE, and STOP buttons on the front panel can be used for standard operations. (☞ Page 39)
- Recording operations can be carried out using the REC CONTROL panel. Furthermore, a keyboard and mouse can also be used when recording via this panel. (☞ Page 41)
- The BD-X200 features an RS-422A terminal. When it is connected to an RS-422A compatible VCR, therefore, RS-422 control can be used to carry out synchronous recording of the VCR's video and audio to a DVD. (Various menu settings are required.) Synchro-recording is carried out from the REMOTE CONTROL screen. (☞ Page 59)
- When a digital video camera or a DV player is connected to the BD-X200 using a DV cable, and when this DVD recorder is setup as the master device for DV control (using menu settings), synchronous recording of any video and/or audio signals from the DV player can be carried out to a DVD. Synchro-recording is carried out from the REMOTE CONTROL screen. (☞ Page 63)
- The DV IN/OUT terminal can be used to record audio and video from a non-linear editor to a DVD. In such a case, the BD-X200 must be setup as the control slave (using menu settings). The DVD recorder will be controlled by the non-linear editor in this type of setup. (☞ Page 64)

### ■ The title and chapter menus can be created either automatically or manually. (☞ Page 43)

Five different patterns have been provided as display styles for the title and chapter menus. Each of these patterns is characterized by different thumbnail characteristics (i.e., number, position, and size) and background images displayed on the title and chapter menu screens.

When a display style is selected during the recording of content to a DVD, the BD-X200 will automatically create the title and chapter menus in accordance with this style.

The PRESET STYLE MENU screen can be used to modify the thumbnail and background display characteristics of each of the display styles.

In addition, the THUMBNAIL EDIT screen and the CHAPTER MENU EDIT screen can be used to modify the display style and thumbnail images for chapter menus, and also to input chapter names and comments. The input of names or comments is carried out using a keyboard connected to one of the recorder's USB terminals.

The TITLE MENU EDIT screen can be used to modify the display style for the title menu and to enter title names.

### ■ DVD dubbing can be carried out using the LAN terminal.

This terminal allows two BD-X200 DVD recorders to be connected using a LAN cable, and the recorders can then operate as master and receiver devices during the dubbing of DVDs. (☞ Page 70)

### ■ The BD-X200 can be used to play discs that it has created. (☞ Page 57)

In this way, it is possible to inspect the content of discs finalized using this DVD recorder.

- Once a disc has been finalized, it can also be played on other DVD players.

## Precautions for DVD Recorder Use

### ■ Storage & Usage Locations

The storage and usage of this DVD recorder in the following types of location should be avoided.

- Areas at temperatures which deviate by a significant degree above or below the permitted service temperature range (i.e., 5°C to 35°C).
- Areas at humidities which deviate by a significant degree above or below the permitted service humidity range (i.e., 20% to 80% RH).
- Areas where a large amount of dust or sand is present.
- Areas where the DVD recorder may come into contact with oily smoke or steam, such as in kitchens or in their immediate vicinity.
- Areas that are unstable or where significant vibration occurs.
- Areas where condensation occurs readily.
- Areas where strong magnetic fields are generated by transformers, motors, or the like.
- Areas where transceivers, mobile phones, and other wireless-communication devices are present.
- Areas that are subjected to X-ray irradiation or where corrosive gases are present. (This precaution must be strictly observed.)

### ■ Handling

- Ensure that this DVD recorder is placed on a flat, horizontal surface for use.
- Do not place heavy objects such as a monitor on top of the DVD recorder.
- Do not insert foreign objects into the disc tray opening.
- Be careful not to get your fingers clamped when loading the disc to prevent injury.
- Do not block the fan's ventilation holes.
- Avoid knocking or dropping this DVD recorder.
- When the DVD recorder is to be moved, ensure that any DVD it contains is removed in advance.
- If the DVD recorder is not to be used for an extended period of time, please disconnect the AC adaptor to avoid wasting electricity.

### ■ Cleaning the Exterior (with the power off)

Use a soft cloth when cleaning the outside of this DVD recorder.

Do not use paint thinners or organic solvents as cleaning agents.

Failure to observe these precautions can result in discoloration or melting of exterior surfaces.

When stubborn dirt is present, wipe away using a cloth soaked in a dilute neutral solvent.

### ■ Always use the AC adaptor provided with this DVD recorder.

### ■ Always use the power cord provided with this DVD recorder.

The usage of a different type of cord or a damaged cord can result in the outbreak of fire or electric shocks.

### ■ The power cord or the AC adaptor supplied with this DVD recorder should not be used with any other device.

### ■ Before connecting the BD-X200 to other devices, turn those devices off and then carry out setup procedures as described in the corresponding user's manuals.

### ■ The DVD drive unit is an expendable part. Although the service life of the DVD drive unit differs depending on the usage environment of the customer, replacement every 1000 hours as a guide is recommended. (☞ Page 78 "TOTAL RECORDING TIME")

## Precautions Regarding Condensation

### ■ Condensation

When cold water is poured into a glass and droplets of water form on its outer surface, this moisture is referred to as "condensation".

### ■ When condensation occurs

Condensation can cause water droplets to adhere to the DVD recorder's internal lens, thus making normal operation impossible.

### ■ Condensation occurs easily in the following situations, and the appropriate care should be taken.

- When the DVD recorder is moved from a cold location into a warm room.
- When the room containing the DVD is rapidly heated.
- When an air conditioner's air duct is pointing straight at the DVD recorder.

■ In situations where it is likely that condensation will occur, remove any DVD that may be present in the BD-X200 and then turn the power on. As the interior heats up, condensation will be less likely to occur.

■ Condensation is a principal cause of the inability to play discs and other similar problems. In this type of situation, allow the DVD recorder to remain inactive with its power on for several hours. If the problem persists after this period of time has elapsed, contact either the store where the BD-X200 was purchased or your nearest JVC Authorized dealer.

## Extended Periods of Inactivity

Performance may deteriorate over extended periods of inactivity; for this reason, the power should be turned on and the DVD recorder should be operated at regular intervals.

## Compensation for Damaged Content

■ JVC accepts no responsibility whatsoever for damages incurred as a result of an inability to play or record audio and video content in the rare event that this DVD recorder, a DVD-R, or a DVD-RW fails to operate correctly.

■ It is recommended that discs containing important content be backed up at regular intervals (i.e., on a yearly basis). Although digital signals do not deteriorate, storage environments can have an effect on a disc's aging characteristics, and this may result in an inability to play or record.

■ If a disc should break, there will be no way to recover data from it.

■ Proper playback of discs recorded using this DVD recorder on all devices is not guaranteed.

# Introduction

## Precautions for Disc Usage

### Care of Discs to Ensure High-Quality Playback

■ Fingerprints, dust, or any other similar contamination of the surface of a disc can lead to distortion in the playback of recorded video and audio. For this reason, it is good practice to wipe each disc with a soft cloth before use.

#### ■ Looking After Discs

- Using a soft cloth, wipe the disc gently from the inside to the outside.



- If stubborn dirt is present on the surface of a disc, wipe first using a slightly wet cloth and then using a dry cloth.
- Paint thinners, organic solvents, analog record cleaning agents, anti-static sprays, and the like must never be used. Failure to observe this precaution can lead to discs being permanently damaged.

#### ■ Handling Discs

- Removing a disc
- Placing a disc in its case



- Correct method for holding a disc



Your hands or fingers should not come into contact with the recording surface when holding a disc.

### Additional Notes on Disc Handling

- Never wipe a disc using paint thinners, organic solvents, alcohol, or record-cleaning fluid.
- Do not use disc protectors or scratch guards.
- Stickers and other types of paper label should not be applied.
- Do not use discs from which stickers or labels have been removed.
- Do not use discs on which illustrations or text has been printed using a commercially-available label printer. First create a disc using the unit before printing.
- The use of non-circular discs (i.e., heart or rectangular shaped), warped discs, and cracked discs can lead to breakage of the DVD recorder.



### Storing Discs

- Avoid storing discs in any of the following locations.
  - Areas with high levels of humidity or dust, or areas where mold is present.
  - Areas exposed to direct sunlight or close to heating equipment.
  - Vehicle interiors during summer months.
- Take care to avoid dropping or knocking discs.
- Place discs in cases and stack these cases for storage.
- Discs can be deformed or cracked as a result of stacking, leaning, or dropping when not inside a case.

## Details Regarding Discs

### Discs for Recording & Playback

The following shows the discs that can be recorded to and played using this DVD recorder, in addition to the corresponding display marks or logos.

DVD-R 	12 cm: 4.7 GB General Version 2.0 (video mode)
DVD-RW 	12 cm: 4.7 GB Version 1.1 or later (video mode)

\* Certain characteristics and properties of DVD-Rs and DVD-RWs can render them unsuitable for recording or playback.

#### Recommended manufacturers

DVD-R : JVC, Maxell, TDK 1x, 2x, 4x  
DVD-RW : JVC, TDK 1x, 2x

### DVD-R & DVD-RW Details

**DVD-R** : Only discs that conform with DVD-R Standard 2.0 (video mode) can be used.

**DVD-RW** : Discs of Version 1.1 or later can be used. Although Version 1.1 of the DVD-RW Standards allows the selection of either video mode or VR mode for recording, this DVD recorder performs recording in video mode only.

\* Version 1.0 of the DVD-RW Standards does not support video-mode recording, and for this reason, the corresponding discs cannot be used.

In terms of recording characteristics, DVD-R and DVD-RW (video mode) differ as follows.

#### ■ DVD-R

- Each disc can be recorded only one. Accordingly, these discs are recommended for use in archiving or long-term storage.
- Once a disc has been finalized, it can also be played on other DVD players.

#### ■ DVD-RW (video mode):

- After viewing a disc, all data can be erased and it can be used to record new content.
- Once a disc has been finalized, it can also be played on other DVD players.

### Finalizing

When a DVD-R or a DVD-RW (video mode) has been finalized, it can be played in the same way as any other DVD using a standard DVD player. (☞ Page 42)

■ **Recording to unused sections of a disc and the modification of titles or display styles can be carried out as required before a disc is finalized.**

- In the case of both DVD-Rs and DVD-RWs, it is impossible to overwrite previously recorded content with new data, even if the disc in question has not yet been finalized. The deletion of specific sections of data is also impossible.
- Regardless of whether or not finalization has been carried out, it will not be possible to use this DVD recorder to record new content to a DVD-R or DVD-RW that has been recorded using other devices.

■ **Once a disc has been finalized, it can be used as a standard DVD and its recorded audio and video can be played on this and other DVD players.**

- After finalizing, a disc's titles can be selected from the top menu.
- Additional recording will not be possible after finalizing.
- Although a finalized disc may in principle be played on other DVD players, certain characteristics of the disc and its recording conditions may make this impossible.

### Playing Discs on the BD-X200

The BD-X200 is capable of playing any discs that it has created and finalized.

- The following conditions may occur when attempting to play discs recorded using other devices on this DVD recorder.
  - Inability to play
  - Block-type noise (i.e., mosaic)
  - Interruptions in audio and/or video
  - Unintentional stopping during playback
- Commercially-available DVD-Videos and DVD-ROMs cannot be used.



## Introduction

### Details Regarding Discs (continued)

#### DVD Data Configuration

Generally speaking, the content recorded on a DVD is separated into large units referred to as "titles". A unique number called a "title number" is assigned to each of these titles, and as a result, any title can be immediately accessed using its title number. In addition, each title can be divided into smaller units referred to as "chapters". Similarly, a unique number called a "chapter number" is assigned to each of these chapters, and this allows any chapter to be immediately accessed using its chapter number.

Each recording made to a DVD-R or DVD-RW (video mode) is stored as a single title. In this, each pressing of the STOP button to leave Recording mode constitutes a different recording. (This action is also referred to as "title closing".)

Whenever the PAUSE button is pressed to pause recording, a chapter mark is inserted into the current title. It is also possible to insert chapter marks to partition titles at the desired points by pressing the REC button while recording. In addition, your BD-X200 can also be used to automatically insert chapter marks at regular intervals. (CHAPTER CREATION menu settings will be required for this function.)

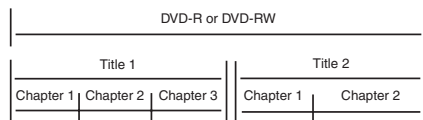

- Before a title is closed, it will be possible to modify the style used for chapter menu display, to change the thumbnails used, and to input thumbnail names.
- Before a disc is finalized, it will be possible to modify the style used for the title menu and to input title names.

#### Region Codes

One of six numbers referred to as "region codes" is assigned to DVD content to control the global regions in which this content may be viewed. If a DVD's region code does not correspond to the region code of the DVD player being used, it will not be possible to play the disc.

- This DVD recorder assigns the region code "ALL" to the discs that it records.
- It will not be possible to play discs to which region codes have been assigned.

#### Screen Sizes

This DVD recorder is capable of recording video content for wide-screen TVs (i.e., with a 16:9 aspect ratio).

In addition, signals for normal content with a 4:3 aspect ratio, for squeezed content (i.e., where the left and right are compressed), and for letterbox content (i.e., where the top and bottom of the screen are black) can be recorded as is.

- Thumbnail creation method for use in the title/chapter menu during wide-signal input can be selected in THUMBNAIL FORM of the RECORDER (2/2) menu screen. (☞ Page 81)

## Component Names & Functions

### Front Panel

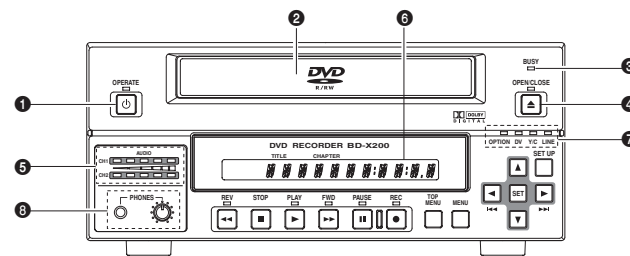

#### 1 OPERATE button and indicator

- This button is used to turn on the DVD recorder and to make it ready for use. When pressed a second time, this button turns off the DVD recorder.
- The indicator's lighting condition depends on the condition of the DVD recorder and can be one of the following.
  - Lit in green : The DVD recorder's power is on.
  - Lit in red : The DVD recorder's power is off.
  - Flashing in red : An error has occurred.

#### Notes

- The OPERATE button will have no effect if pressed while the DVD recorder is in either Recording or Recording Pause mode. This is also the case when performing finalizing, erasing, or dubbing.
- The DVD recorder continues to use a small amount of power even after it has been turned off using the OPERATE button. If it will not be used for an extended period of time, please disconnect the AC adaptor to avoid wasting electricity.
- Do not disconnect the DC cord or power cord when in Operate On mode as this can result in the DVD recorder being damaged.
- Malfunction may occur when switching to OPERATE ON while pressing a key on a connected USB keyboard.

#### 2 Disc tray

The purpose of the disc tray is to hold DVDs.

This tray opens automatically when the OPEN/CLOSE button is pressed. In addition, the OPEN/CLOSE button can be pressed again to close the tray.

#### Notes

- Do not push the disc tray as it is opening or closing.
- Do not place objects other than discs on the disc tray.
- Do not press down on the disc tray

#### 3 BUSY indicator

This indicator flashes when the DVD recorder is in Recording Pause mode or when it is performing time-consuming operations such as title closing, finalizing, and erasing. None of the DVD recorder's buttons will have any effect if pressed while the BUSY indicator is flashing.

#### 4 OPEN/CLOSE button and indicator

This button is used to open and close the disc tray.

In addition, the OPEN/CLOSE indicator is lit up while the disc tray is opening, and also when it is open.

#### Note

The OPEN/CLOSE button will have no effect if pressed while the DVD recorder is in either Recording or Recording Pause mode. This is also the case when performing finalizing, erasing, or dubbing.

#### 5 Audio level indicator

These meters are used to indicate the current level of audio on Channel 1 and Channel 2.

Specifically, the audio level meters indicate the audio recording levels when the DVD recorder is in Recording mode, and the audio playback levels when it is in Playback mode. (Adjustment of the audio recording levels: ☞ Page 35.)

#### 6 LCD display

The LCD display is used to present important information. During recording or playback, for example, the title, chapter number, and elapsed time are indicated on the LCD display. (☞ Page 14 for more details.)

#### 7 Video input indicators

##### OPTION indicator

This indicator is lit up or flashes when INPUT SELECT from the INPUT SELECT MENU screen has been set to OPTION. (This setting cannot be carried out using the DVD recorder alone.)

##### DV indicator

This indicator is lit up or flashes when INPUT SELECT from the INPUT SELECT MENU screen has been set to DV. Specifically, the indicator is lit up when an input signal is present, and it flashes when no signal is present.

##### Y/C indicator

This indicator is lit up or flashes when INPUT SELECT from the INPUT SELECT MENU screen has been set to Y/C. Specifically, the indicator is lit up when an input signal is present, and it flashes when no signal is present.

##### LINE indicator

This indicator is lit up or flashes when INPUT SELECT from the INPUT SELECT MENU screen has been set to LINE. Specifically, the indicator is lit up when an input signal is present, and it flashes when no signal is present.

#### 8 Phones jack and volume adjuster

The phones jack allows headphones to be connected to the DVD recorder for monitoring of audio levels; in addition, the headphone volume can be adjusted using the volume adjuster. Note that this adjuster has no effect on the actual recording levels.

## Component Names & Functions

### Front Panel (continued)

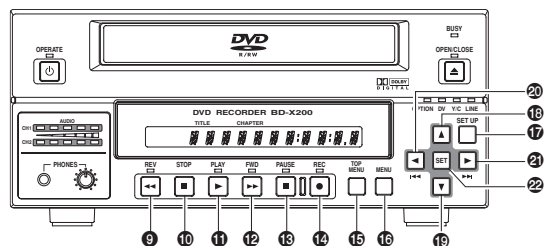

#### 9 REV button and indicator

- When this button is pressed in Playback or Fast-Forward Play mode, the DVD recorder switches to fast-reverse play. If pressed again during fast-reverse play, the REV button toggles the speed of fast-reverse between  $\times 3$  and  $\times 15$ .
- When this button is pressed in Still or Slow-Forward Play mode, the DVD recorder switches to slow-reverse play. If pressed again during slow-reverse play, the REV button toggles the speed of slow-reverse between  $\times 0.5$  and  $\times 0.06$ .
- The REV indicator is lit up during fast-reverse and slow-reverse play.

#### 10 STOP button

- This button has the following effect when pressed in Recording or Recording Pause mode. If EDIT MENU from the SYSTEM MENU screen is set to DISABLE, the DVD recorder stops recording (i.e., it performs title closing). If EDIT MENU from the SYSTEM MENU screen is set to ENABLE, the DVD recorder stops recording and the THUMBNAIL EDIT screen is displayed. It will then be possible to modify the chapter menu.
- When the STOP button is pressed in Playback mode, the DVD recorder stops playback.

#### 11 PLAY button and indicator

- If this button is pressed together with the REC button while a recordable disc is inserted into the DVD recorder, recording will be started.
- When the PLAY button is pressed in Recording Pause mode, the DVD recorder restarts recording.
- If a finalized disc has been inserted into the DVD recorder, pressing of this button will start playback.
- The PLAY indicator is lit up in Recording and Playback modes.

#### 12 FWD button and indicator

- When this button is pressed in Playback or Fast-Reverse Play mode, the DVD recorder switches to fast-forward play. If pressed again during fast-forward play, the FWD button toggles the speed of fast-forward between  $\times 3$  and  $\times 15$ .
- When this button is pressed in Still or Slow-Reverse Play mode, the DVD recorder switches to slow-forward play. If pressed again during slow-forward play, the FWD button toggles the speed of slow-forward between  $\times 0.5$  and  $\times 0.06$ .
- The FWD indicator is lit up during fast-forward and slow-forward play.

#### 13 PAUSE button and indicator

- If this button is pressed during recording, the DVD recorder switches to Recording Pause mode. A chapter mark is inserted at the corresponding point.
- If this button is pressed during playback, the DVD recorder switches to Still mode and freezes playback. If the PAUSE button is then pressed again in Still mode, the DVD recorder will advance playback by a single field.
- The PAUSE indicator is lit up in Recording Pause and Still modes.

#### 14 REC button and indicator

- If this button is pressed together with the PLAY button in Stop mode, recording will be started.
  - If the current disc is blank or title closing has been carried out, a new title will be created and recording will start at Chapter 1.
- When this button is pressed during recording, a new chapter will be setup within the continuous video data.
- If this button is pressed and held for more than 2 seconds while the DVD recorder is stopped or inserted with no disc, input signal encoded/decoded in MPEG will be output via the VIDEO OUT terminal on the rear panel. This will continue for as long as the button is held, and it allows the DVD recording quality to be confirmed. Audio will be muted at this time.
- The REC indicator is lit up in Recording and Recording Pause modes.

#### 15 TOP MENU button

- If this button is pressed while the DVD recorder is in a playback condition, the current DVD's top menu (or title menu) will be displayed on the monitor screen. If the DVD does not contain a title menu, nothing will be displayed when the TOP MENU button is pressed.

#### 16 MENU button

- If this button is pressed while the DVD recorder is in a playback condition, the chapter menu for the currently selected title will be displayed on the monitor screen. If the DVD title does not contain a chapter menu, nothing will be displayed when the MENU button is pressed.

#### 17 SET UP button

- This button can be pressed to display the Setup Menu on the monitor. A wide range of different menu settings can then be made via the Setup Menu. (See Page 74) In addition, the SET UP button can be pressed again to hide the Setup Menu.
- If the SET UP button is pressed in Recording or Recording Pause mode, setting data relevant to recording (i.e., video bit rate and audio encoding format) will be displayed on-screen. In addition, the SET UP button can be pressed again to hide this information.

#### 18 [▲] button

- This button is used to select menu items or setting values when the Setup Menu is displayed.
- If a title menu or chapter menu is displayed, this button can be used to select a menu number for playback. Specifically, pressing of this button moves the selection position upward.
- The ▲ button can be used to adjust the audio recording levels when the DVD recorder is stopped or in Recording Pause mode.
  - If AUDIO REC VOLUME MODE from the RECORDER MENU (2/2) screen is set to BOTH and this button is pressed while either the ◀ or ▶ button is being held, the audio recording level for Channel 1 will increase.
  - If AUDIO REC VOLUME MODE from the RECORDER MENU (2/2) screen is set to INDEPENDENCE and this button is pressed while the ◀ button is being held, the audio recording level for Channel 1 will increase. Similarly, if the ▲ button is pressed while the ▶ button is being held, the audio recording level for Channel 2 will increase.

#### 19 [▼] button

- This button is used to select menu items or setting values when the Setup Menu is displayed.
- If a title menu or chapter menu is displayed, this button can be used to select a menu number for playback. Specifically, pressing of this button moves the selection position downward.
- The ▼ button can be used to adjust the audio recording levels when the DVD recorder is stopped or in Recording Pause mode.
  - If AUDIO REC VOLUME MODE from the RECORDER MENU (2/2) screen is set to BOTH and this button is pressed while either the ◀ or ▶ button is being held, the audio recording levels for both Channel 1 and Channel 2 will decrease.
  - If AUDIO REC VOLUME MODE from the RECORDER MENU (2/2) screen is set to INDEPENDENCE and this button is pressed while the ◀ button is being held, the audio recording level for Channel 1 will decrease. Similarly, if the ▼ button is pressed while the ▶ button is being held, the audio recording level for Channel 2 will decrease.

#### 20 [◀] button

- If a title menu or chapter menu is displayed, this button can be used to select a menu number for playback. Specifically, pressing of this button moves the selection position to the left.
  - This button can be pressed while the DVD recorder is playing to move playback to the start of the current chapter.
- The ◀ button can be used to adjust the audio recording levels when the DVD recorder is stopped or in Recording Pause mode.
  - If AUDIO REC VOLUME MODE from the RECORDER MENU (2/2) screen is set to INDEPENDENCE and either the ▲ or ▼ button is pressed while this button is being held, the audio recording level for Channel 1 will be adjusted accordingly.
  - If AUDIO REC VOLUME MODE from the RECORDER MENU (2/2) screen is set to BOTH and either the ▲ or ▼ button is pressed while this button is being held, the audio recording levels for both Channel 1 and Channel 2 will be adjusted accordingly.
  - If this button is pressed together with the ▶ button, the audio recording levels will be returned to their default settings (i.e., unity gain).

#### 21 [▶] button

- If a title menu or chapter menu is displayed, this button can be used to select a menu number for playback. Specifically, pressing of this button moves the selection position to the right.
  - This button can be pressed while the DVD recorder is playing to move playback to the start of the next chapter.
- The ▶ button can be used to adjust the audio recording levels when the DVD recorder is stopped or in Recording Pause mode.
  - If AUDIO REC VOLUME MODE from the RECORDER MENU (2/2) screen is set to INDEPENDENCE and either the ▲ or ▼ button is pressed while this button is being held, the audio recording level for Channel 2 will be adjusted accordingly.
  - If AUDIO REC VOLUME MODE from the RECORDER MENU (2/2) screen is set to BOTH and either the ▲ or ▼ button is pressed while this button is being held, the audio recording levels for both Channel 1 and Channel 2 will be adjusted accordingly.
  - If this button is pressed together with the ◀ button, the audio recording levels will be returned to their default settings (i.e., unity gain).

#### 22 SET button

- This button is used to confirm the selection of menu items or setting values when the Setup Menu is displayed.
- When this button is pressed during normal screen display, the counter from the DVD recorder's LCD display will switch to display of either the elapsed recording/playback time or the remaining disc/title time.



## Component Names & Functions

### Rear Panel

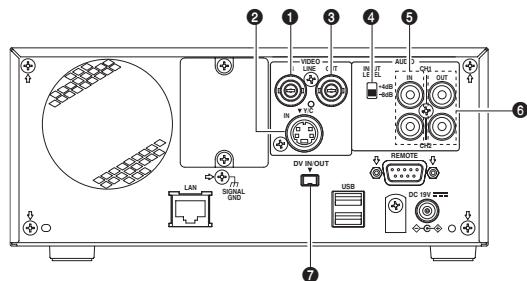

#### 1 VIDEO LINE IN terminal (BNC)

This terminal allows composite video signals to be input to the DVD recorder.

In order to select these signals for input, set INPUT SELECT from the INPUT SELECT MENU screen to LINE.

- SETUP from the SYSTEM MENU screen should be set in accordance with whether or not this input signal is a setup signal. **(U-model only)**

#### 2 VIDEO Y/C IN terminal (4-pin)

This terminal allows YC separate video signals to be input to the DVD recorder.

In order to select these signals for input, set INPUT SELECT from the INPUT SELECT MENU screen to Y/C.

- SETUP from the SYSTEM MENU screen should be set in accordance with whether or not this input signal is a setup signal. **(U-model only)**
- This terminal's specification (i.e., S1 or S2) can be selected using Y/C TERMINAL MODE from the RECORDER MENU (2/2) screen.

#### 3 VIDEO LINE OUT terminal (BNC)

This terminal is used to connect the DVD recorder to a monitor.

- When the DVD recorder is in Stop or Recording mode, the video input signal is output on the E-E screen as a composite video signal.
- If the REC button is pressed and held for at least 2 seconds while the DVD recorder is stopped, the input signal will be subjected to MPEG encode/decode processing and output via the VIDEO LINE OUT terminal. This will continue for as long as the REC button is held, and it allows the DVD recording quality to be confirmed.
- Playback from the DVD is output as a composite signal when in Playback mode.
- The Setup Menu, title menu, chapter menus, and other setting and control screens are displayed on the monitor connected to this terminal.
- Status and alarm information is also displayed on-screen. (The DISPLAY MENU screen can be used to indicate which items are to be displayed.)

#### 4 AUDIO INPUT LEVEL switch

This switch is used to set the standard level for audio input.

- +4dB : The standard level is set to +4 dB.
- 8dB : The standard level is set to -8 dB.

#### 5 AUDIO IN terminals (RCA × 2)

These terminals allow analog audio signals to be input to the DVD recorder.

- In order to select these signals for input, set INPUT SELECT from the INPUT SELECT MENU screen to LINE or Y/C.

#### 6 AUDIO OUT terminals (RCA × 2)

These terminals allow analog audio signals to be output from the DVD recorder.

- When the DVD recorder is in Stop or Recording mode, the audio input signals (i.e., E-E signals) are output via these terminals.
- Audio from the DVD is output when in Playback mode.

#### 7 DV IN/OUT terminal

This I/O terminal for digital signals conforms with IEEE1394 specifications.

As such, it allows the DVD recorder to be connected to DV cameras, DV VCRs, and non-linear editors with DV terminals.

- In order to select this terminal's audio and video signals for input, set INPUT SELECT from the INPUT SELECT MENU screen to DV.
- REMOTE SELECT from the REMOTE MENU screen is used to select a control method for this terminal as follows.
  - DV(MASTER) : The DVD recorder operates as the master device and controls a DV camera or VCR.
  - DV(SLAVE) : The DVD recorder operates as a slave device and is controlled by commands from a non-linear editor.
  - DV(TRIGGER) : The DVD recorder performs recording in response to operation of the trigger button on a camera capable of DV triggering (i.e., a GY-DV5000).

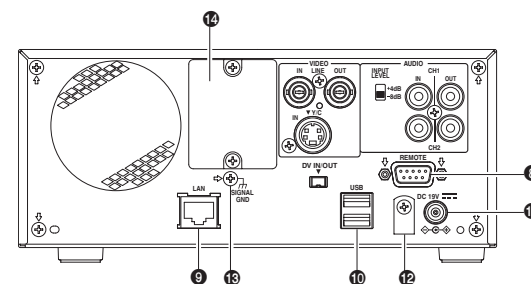

#### 8 RS-422A REMOTE terminal (D-sub 9-pin male)

This terminal is used to connect the DVD recorder to a VCR capable of being controlled via RS-422A. RS-422A control of a VCR using the RS-422A REMOTE terminal is carried out with the DVD recorder operating in Master mode.

- In order to use this terminal, set REMOTE SELECT from the REMOTE MENU screen to 9PIN(MASTER). Video and audio from the VCR can be recorded to a DVD using commands issued from the REMOTE CONTROL screen. (☞ Page 59)

#### 9 LAN terminal (RJ-45)

When two DVD recorders are used to perform DVD-to-DVD dubbing, this terminal is connected to both BD-X200s. A cable of Category 5 or better is required for this connection. A cross-type Ethernet cable is required when connecting directly to another BD-X200.

- This terminal is also used when connecting to a PC on which BD-X200 utility software for operations such as the creation of the title and chapter menus has been installed.
- Network settings must be carried out using the NETWORK MENU screen.

#### 10 USB terminals (2)

These terminals are used when connecting the DVD recorder to USB devices such as a keyboard or mouse. A keyboard and mouse can be used as an alternative to the DVD recorder's buttons when using setting and control screens. The input of text in setting screens is carried out using a keyboard.

- It is not possible to operate devices other than a keyboard or mouse by connecting them to the USB terminal.
- Set KEYBOARD STYLE from the SYSTEM MENU screen in accordance with the keyboard's input language. Recommended manufacturers: Logitech

#### 11 DC IN terminal (2-pin)

This terminal is used to provide DC at 19 V to the DVD recorder. The DC power cord from the AC adaptor (included) should be connected here.

#### Note

When power is supplied via this terminal, the OPERATE indicator on the front panel lights up in red.

#### 12 DC power cord clamp

This clamp secures the DC power cord in place, and it should always be used to prevent accidental disconnection.

#### 13 SIGNAL GND terminal

This terminal is used to ground signals.

#### 14 Optional-board slot cover

This cover is removed to allow commercially-available optional boards to be installed.

# LCD Display and On-Screen Content

## LCD Display

The following information and data is presented on the DVD recorder's LCD display.

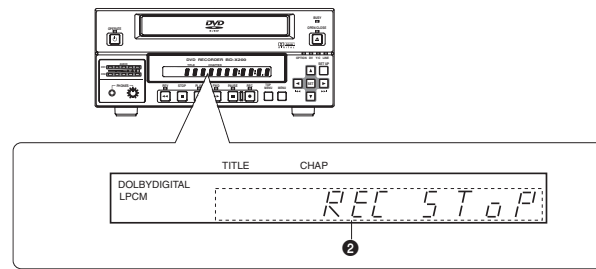
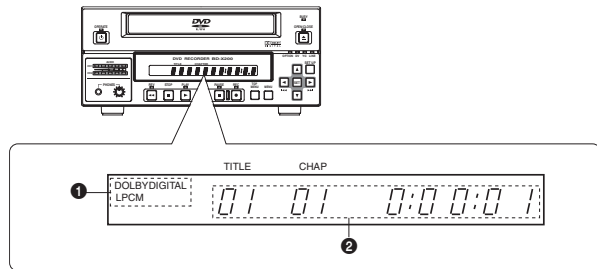

No.	Description
1	<p><b>Encoding format for audio recordings (LPCM, DOLBY DIGITAL)</b>                      Recording mode : The encoding format set using AUDIO ENCODE from the RECORDER MENU (1/2) screen is displayed.                      Playback mode : The encoding format used for audio on the current disc is displayed.</p>
2	<p>Information relevant to the current mode.</p> <p><b>Title number / Chapter number / Counter</b></p> <ul style="list-style-type: none"> <li>When in Recording mode, the LCD display indicates the title number and chapter number currently being recorded, in addition to either the elapsed title-recording time or the remaining disc space.                      The SET button can be pressed to toggle between display of the elapsed recording time and the remaining disc space in the counter area.</li> </ul> <div style="text-align: center;"> </div> <ul style="list-style-type: none"> <li>When in Playback mode, the LCD display presents the title number and chapter number currently being played, in addition to either the elapsed title-playback time or the remaining title-playback time.                      The SET button can be pressed to toggle between display of elapsed and remaining title-playback time in the counter area.</li> </ul> <p><b>Note</b>                      The remaining disc and title time depend on the amount of data comprising video, and for this reason, they should be taken as being a general indication and not an exact figure.</p>

No.	Description
2	<p><b>Indication of the current operating mode</b></p> <p>PLEASE WAIT : The DVD recorder is starting up.                      OPERATE OFF : The DVD recorder is preparing to shut down.                      NO DISC : The DVD recorder currently contains no disc.                      LOADING : A disc is being loaded into the DVD recorder.                      DVD-R : The current disc is a non-finalized DVD-R. (Approximately 3 seconds)                      DVD-RW : The current disc is a non-finalized DVD-RW. (Approximately 3 seconds)                      DVD : The current disc is a finalized DVD-R or DVD-RW. (Approximately 3 seconds)                      REC PAUSE : The DVD recorder is switching from Recording mode to Recording Pause mode.                      REC STOP : The DVD recorder is switching from Recording mode to Stop mode.                      MENU EDIT : A title menu or chapter menu is currently being edited.                      EJECT : The current disc is being ejected.                      TITLE CLOSE : The DVD recorder is performing title-close processing.                      FINALIZE : The DVD recorder is finalizing the disc.                      ERASE : The DVD recorder is erasing data from a DVD-RW disc.                      TOP MENU : The disc's top menu is being played.                      MENU : A menu is being played.                      ENCODING XX : Encoded video is being output. (XX indicates the bit rate.)</p> <p><b>Display of the Setup Menu</b>                      Menu items and setting values from the Setup Menu are displayed. (☞ Page 74)</p> <p><b>Event messages</b>                      Messages relating to incorrect operation and the like are displayed for approximately 3 seconds. (☞ Page 19)</p> <p><b>Alarm messages</b>                      Alarms are displayed when the DVD recorder cannot obey a command. (☞ Page 20)</p>

# LCD Display and On-Screen Content

## On-Screen Content

In addition to E-E and playback screens, the monitor connected to the DVD recorder's VIDEO LINE OUT terminal can display the following.

- Status messages
- Event messages
- Alarm messages
- The Setup Menu (☞ Page 74)
- Recording-operation control screens: REC CONTROL panel (☞ Page 41)  
REMOTE CONTROL screen (☞ Page 60)

## Status Messages

The DVD recorder's setting condition and operation status are indicated by status messages, and these messages are displayed on E-E or playback screens.

The DISPLAY MENU screen can be used to indicate whether or not status messages are to be displayed.

### DISPLAY MENU screen

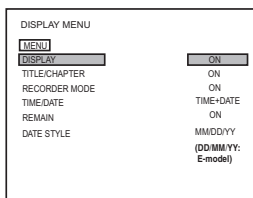

- To display status messages:  
Set **DISPLAY** from the DISPLAY MENU screen to **ON**.
- The various items of status information for display can be selected.
- If **DISPLAY** is set to **OFF**, no status information will be displayed.

### Status Messages

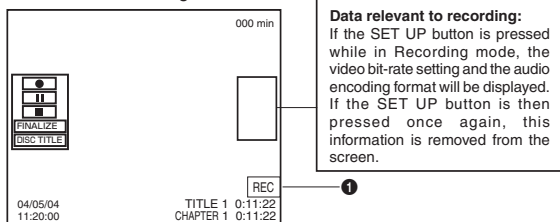

**Data relevant to recording:**  
If the SET UP button is pressed while in Recording mode, the video bit-rate setting and the audio encoding format will be displayed. If the SET UP button is then pressed once again, this information is removed from the screen.

No.	Item	Description
1	Operation Mode	<p>This area indicates the DVD recorder's current mode of operation. Use RECORDER MODE from the DISPLAY MENU screen to indicate whether or not this is to be displayed.</p> <p>NO DISC : The DVD recorder currently contains no disc.            EJECT : The current disc is being ejected.            OPE OFF : Operate Off mode            STOP : Stop mode            REC : Recording mode            REC PAUSE : Recording Pause mode            PLAY : Playback mode            STL : Still mode            FWD × 3 : Fast-forward play at 3 times normal speed            FWD × 15 : Fast-forward play at 15 times normal speed            REV × 3 : Fast-reverse play at 3 times normal speed            REV × 15 : Fast-reverse play at 15 times normal speed            SLOW FWD 0.50 : Slow-forward play at 0.5 times normal speed            SLOW FWD 0.06 : Slow-forward play at 0.06 times normal speed            SLOW REV 0.50 : Slow-reverse play at 0.5 times normal speed            SLOW REV 0.06 : Slow-reverse play at 0.06 times normal speed            LOADING : A disc is being loaded.</p>

## Status Messages (continued)

### Status Messages

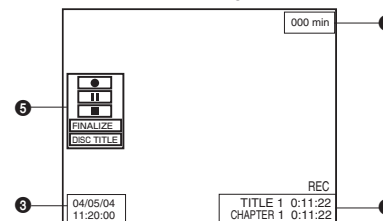

No.	Item	Description
2	Title number / Chapter number / Counter	<p>Use TITLE/CHAPTER from the DISPLAY MENU screen to indicate whether or not this is to be displayed.</p> <p>Recording mode : The title number and chapter number currently being recorded are displayed together with the elapsed title-recording time (in hours, minutes, and seconds).            Playback mode : The title number and chapter number currently being played are displayed together with the elapsed title-playback time (in hours, minutes, and seconds).</p>
3	Date / Time	<p>Use TIME/DATE from the DISPLAY MENU screen to select the way in which the date and time are displayed.</p> <p>OFF : No information is displayed.            DATE : Only the date is displayed.            TIME : Only the time is displayed.            TIME+DATE : Both date and time are displayed.</p> <p>• The date display style can be changed using DATE STYLE from the DISPLAY MENU screen.            Recording mode : The date and time from the internal clock are displayed.            Playback mode : The date and time of disc finalizing are displayed.</p>
4	Remaining time	<p>Use REMAIN from the DISPLAY MENU screen to indicate whether or not this is to be displayed.</p> <p>Recording mode : The amount of video that can still be recorded on the current disc is displayed (in minutes).            Playback mode : Not displayed            * Remaining time is to be used as a general guide, not as an exact figure.</p>
5	REC CONTROL panel	<p>Provided that a recordable disc has been inserted, this panel will be displayed whenever REC CONTROL from the REMOTE MENU screen is set to ON.            The REC CONTROL panel can be used to control recording operations. (☞ Page 41)</p>

## LCD Display and On-Screen Content

### On-Screen Content (continued)

#### Disc Status

When a disc is inserted into the DVD recorder, one of the following disc status messages is displayed on the monitor screen.

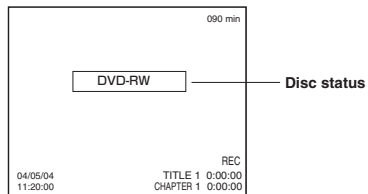

\*: The disc status is not displayed if DISPLAY from the DISPLAY MENU screen is set to OFF.

Status	Description
DVD-R	The current disc is a non-finalized DVD-R. (Approximately 3 seconds)
DVD-RW	The current disc is a non-finalized DVD-RW. (Approximately 3 seconds)
DVD	The current disc is a finalized DVD-R or DVD-RW. (Approximately 3 seconds)
INVALID DISC	The current disc is neither a DVD-R nor DVD-RW.

### Event Messages

Event messages are displayed on the DVD recorder's LCD display and on the monitor when incorrect operations are attempted. These messages will remain on-screen for approximately 3 seconds.

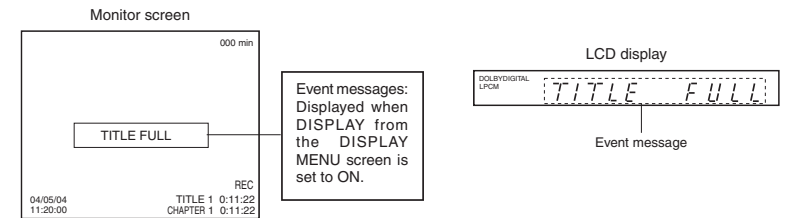

Monitor message	LCD display message	Description
INVALID TV	INVALID TV	A signal of an invalid format has been input. Alternatively, an attempt has been made to play a disc containing signals of an invalid format.
TITLE FULL	TITLE FULL	Recording was attempted on a disc already containing 99 titles.
CHAPTER FULL	CHAP FULL	An attempt was made to add a chapter to a title already containing 99 chapters.
NOT FINALIZE	NOT FINAL	An attempt was made to eject a disc before it was finalized.
————	A L-xxxx-R	Set value is displayed when changing the recording level of analog audio.
————	D L-xxxx-R	Set value is displayed when changing the recording level of digital audio.
DURATION OVER	————	Auto Edit was carried out when the remaining disc space became insufficient during RS-422A or DV remote operation.
INVALID EDL	————	An incorrect value was entered during the registration of an edit list (EDL).
EDL UNDER EDIT	————	EDL Load was carried out after starting the registration of an edit list (EDL).
NO CASSETTE	————	During RS-422A or DV remote operation, an attempt was made to control the connected VCR while it did not contain a video tape.
NOT CONNECT	————	During RS-422A or DV remote operation, a control operation was attempted while no external device was connected.
EDIT FAILURE	————	Editing could not be completed normally.

## LCD Display and On-Screen Content

### Alarm Messages

Alarm messages are displayed on the DVD recorder's LCD display and on the monitor when the recorder cannot obey a command. These messages will remain on-screen until the next operation is carried out.

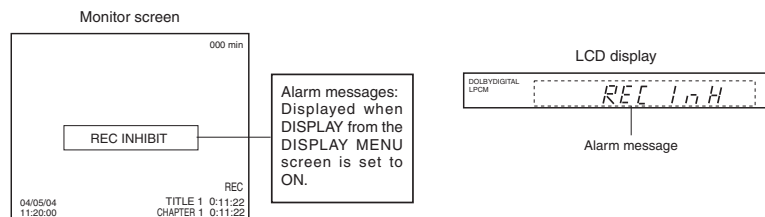

Monitor message	LCD display message	Description
INVALID DISC	INVALID DISC	The current disc is not a DVD-R or DVD-RW.
NOT X200	NOT X200	A disc recorded using a different DVD recorder was inserted or played.
REC INHIBIT	REC INH	<ul style="list-style-type: none"> <li>Recording was attempted using a disc on which no more data can be recorded.</li> <li>The current disc is a non-finalized DVD-RW to which no more data can be recorded.</li> </ul>
COPY INHIBIT	COPY INH	Recording of a copy-protected signal was attempted.
DISC FULL	DISC FULL	All remaining space on the disc is used up during recording.
CELL OVER	CELL OVER	The number of cells for a single title exceeded 255. This will be displayed when the recording time for a single title is exceeded as a result of setting ENCODE QUALITY to a low value (i.e., 4 Mbps or lower), recording content with little movement, or other similar factors. No error will be triggered when the time is within that set for the total content.
REGION CODE	REGION CODE	An attempt was made to play a disc for which a region code has been set.
OVERHEATING!	OVERHEATING	Displayed when the internal temperature of the set rises due to fan malfunction, etc. In this case, immediately turn off the power and discontinue use. The power will automatically shut down in about 20 minutes after the OVERHEATING display.

#### CAUTION

If alarm messages such as "INVALID DISC" are displayed several times when a disc recorded using the BD-X200 or a blank disc is inserted, there is a possibility that the disc itself has been damaged. In such a case, the damaged disc should be replaced with a new one.

If the alarm messages continue to appear after replacing the disc, the problem may lie within the DVD recorder, and in such a case, you are recommended to contact either the store where this BD-X200 was purchased or your nearest JVC authorized dealer.

## Preparation

### Signal Connections

#### Audio and video signals

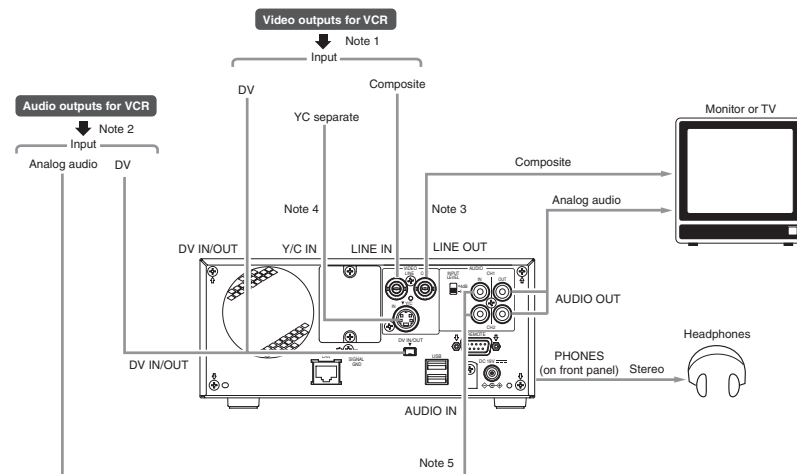

Note 1: The video signal for input is selected using INPUT SELECT from the INPUT SELECT MENU screen.

Note 2: The audio signals for input are selected using INPUT SELECT from the INPUT SELECT MENU screen.

When either LINE or Y/C is set for INPUT SELECT, the analog audio signals from the AUDIO IN terminals will be selected for input.

When DV is set for INPUT SELECT, the DV audio signals from the DV IN/OUT terminal will be selected for input.

Note 3: When the DVD recorder is in Stop or Recording mode, the video input signal is output on the E-E screen as a composite video signal.

In addition, the Setup Menu and other setting screens are also displayed on the monitor connected to this terminal. The DVD recorder's operation status and other relevant information are displayed on-screen when DISPLAY from the DISPLAY MENU screen has been set to ON.

Note 4: The Y/C IN terminal's specification (i.e., S1 or S2) can be selected using Y/C TERMINAL MODE from the RECORDER MENU (2/2) screen.

Note 5: The standard input level for audio signals input via the AUDIO IN terminals (i.e., +4 dB or -8 dB) can be selected using the AUDIO INPUT LEVEL switch on the rear panel.

## Preparation

### Signal Connections (continued)

#### ■ Control signals

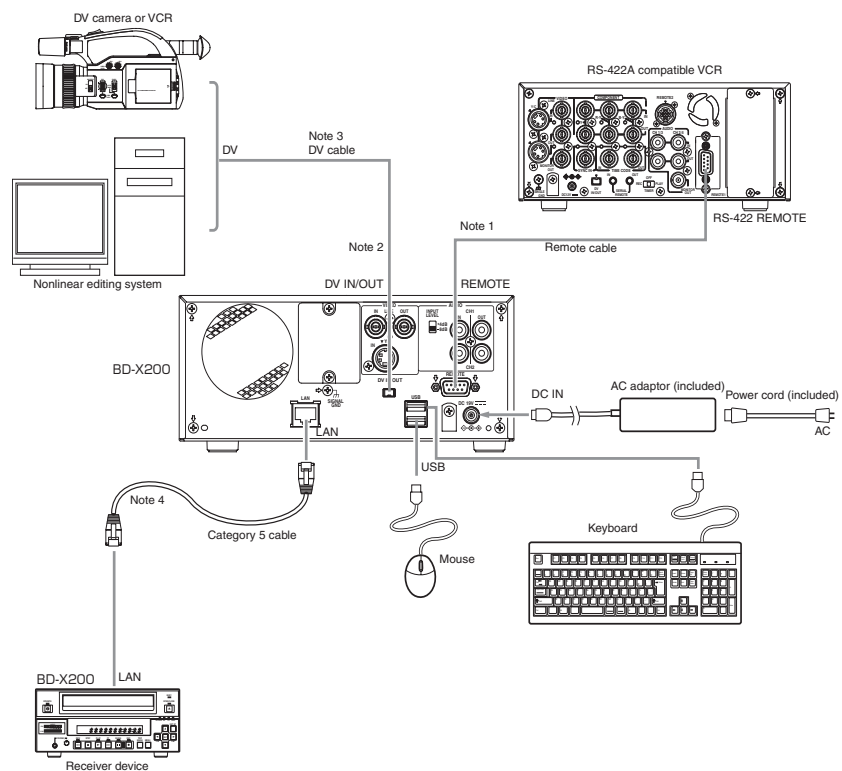

- Note 1: In order to use the RS-422A REMOTE terminal, set REMOTE SELECT from the REMOTE MENU screen to 9PIN(MASTER).
- Note 2: In order to carry out control using the DV IN/OUT terminal, make the appropriate selection using REMOTE SELECT from the REMOTE MENU screen.
- Note 3: One of the following DV cables should be used.  
 VC-VDV204 (2 m, 4P-4P) from JVC  
 VC-VDV206 (2 m, 4P-6P) from JVC
- Note 4: When connecting a secondary device directly to your BD-X200, use a Category 5, cross-wired Ethernet cable.

### Power Connections

Connect the AC adaptor (included) to the DVD recorder.

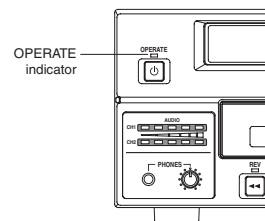
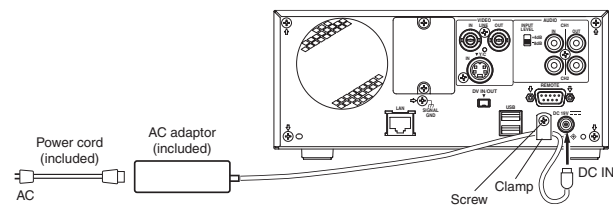

**Note**  
 A small amount of current will be required by the DVD recorder when in Operate Off mode.

1. Connect the AC adaptor's DC cord to the DVD recorder's DC IN terminal.
2. Secure the DC cord using the DC power cord clamp in order to prevent accidental disconnection.
  - ① Remove the screw and then the clamp.
  - ② Insert the DC cord into the clamp, and then secure the clamp to the DVD recorder.
3. Connect the power cord (included) to the AC adaptor's AC IN terminal.
4. Insert the power cord into an electrical outlet.
  - Power will be supplied to the DVD recorder and the OPERATE indicator will be lit up in red. (Operate Off mode)

**CAUTION**

- Always use the AC adaptor provided with the DVD recorder. The use of other power sources should be avoided.
- Do not disconnect the DC cord or power cord during recording or playback. In the case of DVD-R discs, failure to observe this precaution will result in the discs becoming unusable. In the case of DVD-RW discs, it will be necessary to erase all data from the disc and to start recording again from the beginning.



## Preparation

### Turning the Power On & Off

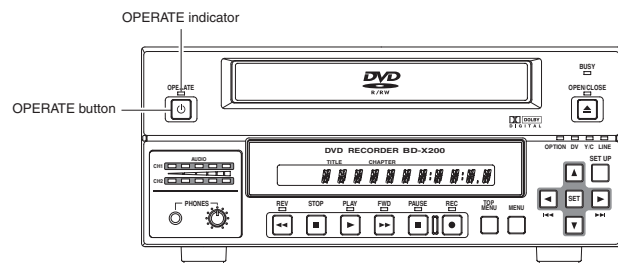

#### Turning the Power On

- While in Operate Off mode (i.e., the OPERATE indicator is lit up in red), press the OPERATE button.

- The power will turn on, the color of the OPERATE indicator will change to green, and the DVD recorder will become ready for use. (Operate On mode)

#### Note

A period of 45 seconds may pass before the DVD recorder adopts Operate On mode as it prepares for operation.

#### Turning the Power Off

- Stop the DVD recorder. (It is recommended that you eject the disc at this time.)

1. Press the OPERATE button.
  - The DVD recorder will adopt Operate Off mode and the color of the OPERATE indicator will change to red.
2. If the DVD recorder will not be used for an extended period of time, disconnect the AC adaptor.
  - Before disconnecting the AC adaptor, be sure to remove the power cord from the electrical outlet.

#### Notes

- Pressing the OPERATE button will have no effect in Recording mode or Recording Pause mode.
- Pressing this button also has no effect during finalizing, erasing, and dubbing.

### Inserting & Removing Discs

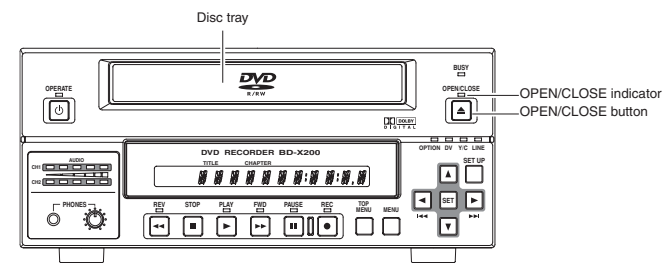

#### Inserting a Disc

- Press the OPERATE button to activate Operate On mode.

1. Press the OPEN/CLOSE button.
  - The disc tray will open automatically. While the disc tray is open, the OPEN/CLOSE indicator will be lit up.
2. Place the disc on the disc tray.

Ensure that the disc is inserted correctly into the tray's recess with the printed side facing upward.

  - Carefully place the disc in the tray so as not to hit the front panel.



3. Press the OPEN/CLOSE button.

- The disc tray will close automatically.

#### Note

When a disc is inserted, information about that disc is displayed on-screen. (☞ Page 18)

#### Removing a Disc

- Stop the DVD recorder.

1. Press the OPEN/CLOSE button.
  - The disc tray will open automatically. While the disc tray is open, the OPEN/CLOSE indicator will be lit up.
  - If the current disc has not been finalized, the message "NOT FINALIZE" will appear on both the monitor and LCD display.
2. Remove the disc from the disc tray.

Be sure to wait until the disc tray has opened fully before removing the disc.
3. Press the OPEN/CLOSE button.
  - The disc tray will close automatically.

#### Notes

- If the DVD recorder is in either Recording mode or Recording Pause mode, the disc tray will not open when the OPEN/CLOSE button is pressed.
- Pressing this button also has no effect during finalizing, erasing, and dubbing.

#### Precautions regarding the disc tray

- Do not push the disc tray as it is opening or closing.
- Do not place objects other than discs on the disc tray.
- Do not press down on the disc tray.

## Preparation

### Using a Keyboard & Mouse

Menu settings, the title and chapter settings, and other DVD recorder settings are carried out from setting screens displayed on the TV or monitor. In addition, recording operations can also be carried out from similar screens.

Although the DVD recorder's buttons are used in setting and operation screens, a keyboard and mouse can be used as an alternative.

#### ■ Connections

Connect a USB keyboard and mouse to the two USB terminals on the back of the DVD recorder.

Recommended manufacturers: Logitech

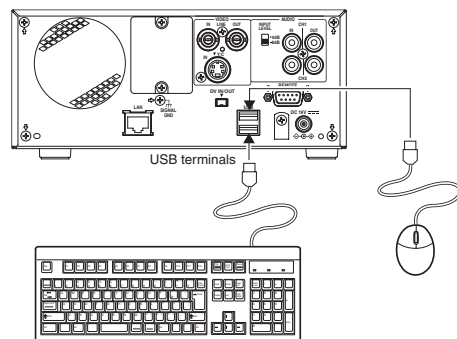

#### ■ Procedure

The following functions can be controlled using the keyboard and mouse.

Function	Front panel	Keyboard	Mouse
Selection of menu items or setting values	▶ button ◀ button ▲ button ▼ button	→ key ← key ↑ key ↓ key	Move the mouse. And then left click.
Confirmation of settings	SET button	Enter key	Left click.

#### Note

Unless otherwise specified, this user's manual describes procedures carried out from the DVD recorder itself.

The entry of names and comments for the title and chapter menus is carried out using the keyboard. (Set KEYBOARD STYLE from the SYSTEM MENU screen in accordance with the keyboard's input language.)

### Setting & Displaying the Date & Time

Use the following procedure to set the internal clock's date and time. Even when the DVD recorder's power is turned off, the clock's date and time settings are stored using the internal battery.

Note that these settings are used to write the current date and time to a disc being finalized.

The DISPLAY screen can be used to indicate whether or not the date and time are to be displayed on-screen.

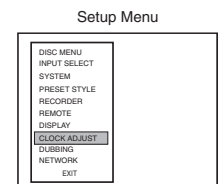
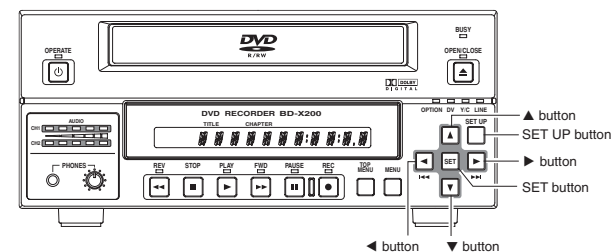

CLOCK ADJUST MENU screen

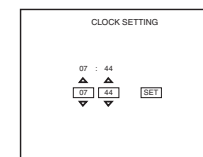
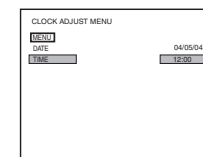
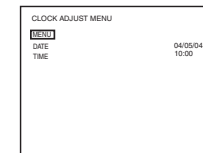

### Setting the Date and Time

Setting of the date and time is carried out using the CLOCK ADJUST MENU screen. During this procedure, the monitor connected to the VIDEO LINE OUT terminal is used to monitor the setting of data.

■ Turn on the power and ensure that the DVD recorder is stopped.

1. Press the SET UP button to display the Setup Menu.

2. Open the CLOCK ADJUST MENU screen.

- ① Use the ▲ and ▼ buttons to select CLOCK ADJUST. (The currently selected menu item is displayed as highlighted.)
- ② Press the SET button to open the CLOCK ADJUST MENU screen.

3. Set the date and time as required.

- ① Use the ▲ and ▼ buttons to select either DATE or TIME. Then press the SET button.
- ② Use the ▶ and ◀ buttons to select the digit to be changed. (The currently selected digit is displayed as highlighted text.)
- ③ Use the ▲ and ▼ buttons to change the value of the selected digit.
- ④ Repeat steps ② through ③ to make all of the required settings, and then press the SET button.

#### Note

It is not possible to set the time in units of seconds. After setting the minutes, press the SET button in sync with a time signal.

4. After completing all of the required settings, return to the Setup Menu.

To do this, use the ▲ or ▼ buttons to select MENU and then press the SET button.

5. Return to the normal screen display.

- To do this, press the SET UP button
- or
- Select EXIT from the Setup Menu and press the SET button.

## Preparation

### Setting & Displaying the Date & Time (continued)

DISPLAY MENU screen

DISPLAY MENU	
MENU	ON
DISPLAY	ON
TITLE/CHAPTER	ON
RECORDER MODE	ON
TIME/DATE	ON
REMAIN	MM/DD/YY
DATE STYLE	(DD/MM/YY: E-mode)

#### Displaying the Date and Time

Use the DISPLAY MENU screen to indicate whether or not the date and time are to be displayed on-screen and to set a display style. (☞ Page 74 for details regarding setting methods.)

#### DISPLAY MENU Screen Makeup

■ **DISPLAY:** This parameter is used to indicate whether or not data is to be displayed on-screen.

ON : Data will be displayed on-screen. The following parameters can be used to indicate which data is to be displayed.  
OFF : No data is displayed on-screen.

■ **TIME/DATE:** This parameter is used to set the way in which the date and time are displayed.

OFF : Neither date or time are displayed.  
TIME : Only the time is displayed.  
DATE : Only the date is displayed.  
TIME + DATE : Both date or time are displayed.

■ **DATE STYLE:** This parameter is used to select the way in which the date is to be displayed.

YY/MM/DD : Year, month, day  
MM/DD/YY : Month, day, year  
DD/MM/YY : Day, month, year

#### To display date and time information on-screen;

- Set DISPLAY to ON.
- Set TIME/DATE to anything other than OFF.  
Date and time information is displayed as follows.

Mode	Displayed information
Recording or Stop	The value of the internal clock
Playback	The date and time at which the current disc was finalized.

On-screen display

000 min	
REC	
TITLE 1 0:11:22	
CHAPTER 1 0:11:22	
TIME/DATE	
TIME/DATE	

## Settings & Controls for Recording

### DVD Recording

DVD recording is carried out using the following procedure.

Pre-Recording Settings	
<b>Preparation of the DVD-R or DVD-RW (video mode only).</b>	<ul style="list-style-type: none"> <li>• Insert a new DVD-R or DVD-RW (video mode), or alternatively, a similar disc that has been recorded on using the DVD recorder.</li> <li>• If the recording on a DVD-RW is to be performed once again from the beginning, erase the disc's data using ERASE from the DISC MENU screen. (☞ Page 30)</li> </ul>
<b>On-screen settings</b>	Use the setting screens to select the appropriate recording signal, setup the recording conditions, and make other necessary settings. (☞ Page 31)
<b>Adjustment of audio recording levels.</b>	Audio recording levels can be adjusted in one of two different ways. (☞ Page 35)
<b>Selection of styles for the title and chapter menus</b>	The title and chapter menus are used during playback of a disc to select the section of the disc to be viewed. A total of five different display styles have been made available for these menus, and these can be selected using the PRESET STYLE MENU screen. In addition, the DVD recorder also allows you to freely modify these display styles. (☞ Page 37)



Recording Operations (☞ Page 38)	
	<ul style="list-style-type: none"> <li>• The section between the start of recording using the REC and PLAY buttons and the end of recording using the STOP button constitutes a single recording title, and each title is assigned a unique number. A single disc can contain up to 99 different titles.</li> <li>• Each title can be separated into a number of different chapters by inserting chapter marks at the appropriate points. Unique numbers are also assigned to chapters, and a single title can contain up to 99 different chapters.</li> <li>• <b>Adding chapters</b> A chapter mark is inserted automatically whenever recording is paused. In addition, CHAPTER CREATION from the RECORDER MENU (1/2) screen can also be used to setup the automatic or manual insertion of chapter marks.</li> <li>• <b>Thumbnails</b> (i.e., the frame at the start of recording) and backgrounds are automatically created for the title and chapter menus using the style selected using PRESET STYLE. If EDIT MENU from the SYSTEM MENU screen is set to ENABLE before the start of recording, it will be possible to modify the chapter menu's style and thumbnails and to insert chapter names and comments whenever recording is stopped (i.e., whenever title closing is performed).</li> <li>• Once title closing has been carried out, it will not be possible to modify the chapter menu.</li> <li>• The REC CONTROL panel can be used to perform recording operations with a keyboard and mouse. (REC CONTROL from the REMOTE MENU screen must be set to ON.)</li> <li>• If EDIT MENU from the SYSTEM MENU screen is set to ENABLE, it will be possible to modify the title menu's style and to input title names when the disc is being finalized.</li> </ul>



Processing After Recording (☞ Page 42)	
<b>If additional recording is to be performed:</b> Press the OPEN/CLOSE button and remove the disc.	<b>If the disc is to be played on this DVD recorder or on a different DVD player:</b> Finalize the disc. To do this, select FINALIZE from the DISC MENU screen. * When a disc has been finalized, it will not be possible to record more content to it or to modify its menu styles.

## Settings & Controls for Recording

### Preparing a Disc for Recording

■ This DVD recorder is capable of recording to DVD-R and DVD-RW (in video mode).

**DVD-R** : Only discs that conform with DVD-R Standard 2.0 (video mode) can be used.

**DVD-RW** : Discs of Version 1.1 or later can be used.

Although Version 1.1 of DVD-RW standards allows the selection of video mode and VR mode for recording, this DVD recorder performs recording in video mode only.

\* Version 1.0 of the DVD-RW standards does not support video-mode recording, and for this reason, the corresponding discs cannot be used.

■ In terms of recording characteristics, DVD-R and DVD-RW (video mode) differ as follows.

**DVD-R** : Each disc can be recorded only once. Erasing of data and re-recording are not possible.

**DVD-RW (video mode)** : After viewing a disc, all data can be erased and it can be used to record new content.

The condition of the disc being used will dictate the available recording options as follows.

	Disc condition	Recording operations
DVD-R	Blank disc	New content can be recorded. A new title is created and recording starts from that title's first chapter.
	A disc recorded on using this DVD recorder but not yet finalized.	A new title is created in the unused section of the disc, and recording starts from that title's first chapter.
DVD-RW	Blank disc	New content can be recorded. A new title is created and recording starts from that title's first chapter.
	A disc recorded on using this DVD recorder but not yet finalized.	A new title is created in the unused section of the disc, and recording starts from that title's first chapter.
	A recorded disc from which data is to be erased.	Erase the recorded data (as described below), and then record new content.

#### Notes

- If data has been erased from a disc using a different DVD recorder, it may not be possible to record new content to it using this recorder. To avoid this type of situation, ensure that this DVD recorder is used to erase recorded data.
- New content cannot be recorded to discs that have been finalized.
- Regardless of whether or not finalization has been carried out, it will not be possible to use this DVD recorder to record new content to a DVD-R or DVD-RW that has been recorded on using other devices.

### Erasing All Data From a Disc

DISC MENU screen

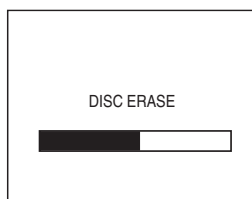
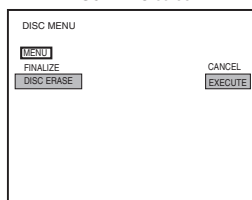

1. Insert the DVD-RW from which data is to be erased.
2. Press the SET UP button to display the Setup Menu.
3. Use the ▼ and ▲ buttons to select DISC MENU and then press the SET button.
  - The DISC MENU screen will appear.
4. Use the ▼ and ▲ buttons to select DISC ERASE and then press the SET button.
  - A list of setting values will appear.
5. Use the ▼ and ▲ buttons to select EXECUTE from the list and then press the SET button.
  - The erasing of data will begin.
    - The message "DISC ERASE" appears and the state of progress is displayed using a progress bar.
    - When all data has been erased, the progress bar will disappear.

#### CAUTION

- All of the data recorded to the disc will be erased in this process. Before starting, therefore, confirm that no important data is stored on this disc.
- Under no circumstances should the power be turned off or the power cord disconnected while data is being erased.

### Pre-Recording Settings

#### Recorder switch settings

Use the AUDIO INPUT LEVEL switch on the DVD recorder's rear panel to select the reference input level for analog audio (i.e., +4 dB or -8 dB).

■ The following screens are used to make settings relevant to recording.

(Screen setting methods: ☞ Page 75)

#### INPUT SELECT MENU screen

This screen is used to select the audio and video signals to be used.

For more details, refer to page 32.

#### SYSTEM MENU screen

##### SET UP (U-model only)

This parameter is set when an analog video signal (i.e., composite or Y/C separate) is being input to the DVD recorder. Specifically, a setting is made to reflect whether or not the input signal is a setup signal. SETUP should be set to ON if it is a setup signal, or to OFF if it is not.

##### TEST SIGNAL

Set this parameter to ON when the color bar output by the DVD recorder's internal signal generator is to be recorded.

##### EDIT MENU

This parameter indicates whether or not a screen for menu editing is to be displayed during title closing and finalizing.

**ENABLE** : The menu editing screen is to be displayed.

During title closing, this screen can be used to modify the chapter menu's style and thumbnails and also to insert chapter names. (☞ Page 47) During finalizing, the menu editing screen allows the title menu's display style to be modified. (☞ Page 53)

**DISABLE** : The menu editing screen is not to be displayed. In this case, the chapter menu is created using preset values as part of title closing when recording is ended.

#### PRESET STYLE MENU screen

This screen is used to select the arrangement and background style for thumbnails displayed on the tops menu. This DVD recorder can store eight individual style type (i.e., TYPE1 through TYPE8), and the most suitable type should be selected here.

For more details, refer to page 37.

#### RECORDER MENU screen

The RECORDER MENU screen contains two different pages of parameters.

##### RECORDER MENU (1/2) screen

###### CHAPTER CREATION

This parameter indicates whether chapters are to be created automatically or manually.

**MANUAL** : Chapters will be created manually. To create a chapter, press the REC button while recording.

**AUTO** : Chapters are to be created automatically. In this case, the DVD recorder will create chapters at the time intervals set using SET INTERVAL.

##### TOTAL CONTENT TIME

This parameter is used to make a setting relevant to the encoding (or compression) of video data.

A setting should be made here when the DVD recorder is to automatically set the bit rate based on the recording time and the remaining disc capacity. Specifically, this parameter sets the recording time.

#### ENCODE QUALITY

This parameter is used to manually set the bit rate for video data.

#### AUDIO ENCODE

This parameter is used to set the format for encoding (or compressing) audio data.

For more details regarding the encoding of audio and video, refer to pages 33, 34.

#### ASPECT

This parameter is used to set the aspect for recorded video. (AUTO, 4:3, LETTER BOX, or SQUEEZE)

#### RECORDER MENU (2/2) screen

##### Y/C TERMINAL MODE

This parameter indicates whether the Y/C IN terminal's specification is S1 or S2. (Specifically, it selects the recording method for the wide-screen discrimination signal.)

##### THUMBNAIL FORM

This parameter selects the method to be used for thumbnail conversion when recording a wide-screen signal.

##### AUDIO CHANNEL (DV)

This parameter is to be set when recording an audio signal from the DV IN/OUT terminal.

Specifically, it indicates whether the signals from channels 1 and 2 or from channels 3 and 4 are to be recorded.

##### AUDIO REC VOLUME MODE

This parameter is used to select the method for adjustment of audio recording levels. Specifically, both channels can be adjusted while maintaining the same level (BOTH), or each channel can be adjusted independently (INDEPENDENCE). For more details regarding methods for the adjustment of audio recording levels, refer to page 35.

##### DISC IN ACTION

This parameter's setting is used during the recording of discs to indicate the action to be taken when a completed (i.e., finalized) disc is inserted into this DVD recorder or a different DVD player.

**MENU** : The title menu is displayed.

**TITLE** : Playback of the main content begins.

##### TITLE END

This parameter's setting is used during the recording of discs to indicate the action to be taken when playback of a title on a completed disc has ended.

**MENU** : The title menu is displayed.

**REPEAT** : Play back from the top of the title begins.

#### REMOTE MENU screen

##### REMOTE SELECT

This parameter should be set to OFF when not controlling the DVD recorder via the RS-422A REMOTE terminal or the DV IN/OUT terminal.

Alternatively, the REMOTE CONTROL screen can be displayed by setting this to 9PIN (MASTER), DV (MASTER), or DV (SLAVE). (☞ Page 60)

##### REC CONTROL

This parameter indicates whether or not the REC CONTROL panel is to be displayed constantly on-screen when a recordable disc has been inserted.

Set this to ON when using a keyboard and/or mouse.

## Settings & Controls for Recording

### Selecting & Confirming Input Signals

The selection of audio and video input signals is carried out from the INPUT SELECT MENU screen as described below. In addition, the type of input signals that have been selected can be confirmed on the front panel.

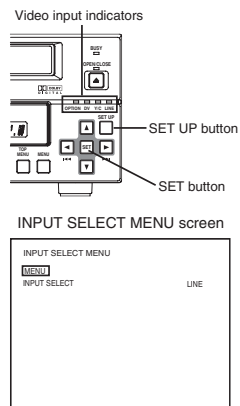

#### Selecting Input Signals

■ Stop the DVD recorder.

##### 1. Open the INPUT SELECT MENU screen.

- ① Press the SET UP button to display the Setup Menu.
- ② Select INPUT SELECT using the ▲ and ▼ buttons and then press the SET button.

##### 2. Make the required settings on the INPUT SELECT MENU screen.

- ① Select the parameter to be set using the ▲ and ▼ buttons, and then press the SET button to display a list of possible settings.
- ② Select the required setting using the ▲ and ▼ buttons, and then press the SET button to adopt this setting.

##### 3. Complete the setting process.

To do so, carry out one of the following procedures.

- Select MENU and press the SET button to return to the Setup Menu.
- Press the SET UP button to return to the normal screen display.

Item	Description
INPUT SELECT	This parameter is used to select the audio and video input signals. LINE : The composite video signal from the VIDEO LINE IN terminal and the analog audio signals from the AUDIO IN terminals are to be used. Y/C : The Y/C separate signal from the Y/C IN terminal and the analog audio signals from the AUDIO IN terminals are to be used. DV : The audio and video signals from the DV IN/OUT terminal are to be used.

#### Note

Setting of INPUT SELECT will not be possible when REMOTE SELECT from the REMOTE MENU screen has been set to DV(MASTER), DV(SLAVE), or DV(TRIGGER). DV signals will be used for input at these times.

### Confirming Input Signals



■ The type of video signals that have been selected for input can be confirmed using the video input signal indicators on the DVD recorder's front panel. Specifically, the indicator corresponding to the type of input signal selected using INPUT SELECT will be lit up or flashing.

- Lit : The selected signal is being received.
- Flashing : The selected signal is not being received.

### Setting the Encoding Format for Audio & Video

The setting of encoding formats for audio and video is carried out from the RECORDER MENU (1/2) screen as described below.

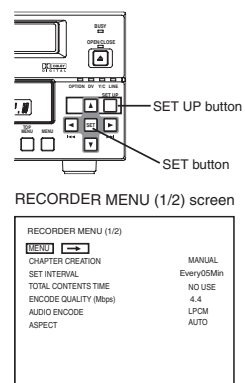

#### Setting Encoding Formats

■ Stop the DVD recorder.

##### 1. Open the RECORDER MENU (1/2) screen.

- ① Press the SET UP button to display the Setup Menu.
- ② Select RECORDER using the ▲ and ▼ buttons and then press the SET button.

##### 2. Make the required settings on the RECORDER MENU (1/2) screen.

- ① Select the parameter to be set using the ▲ and ▼ buttons, and then press the SET button to display a list of possible settings.
- ② Select the required setting using the ▲ and ▼ buttons, and then press the SET button to adopt it.

##### 3. Complete the setting process.

To do so, carry out one of the following procedures.

- Select MENU and press the SET button to return to the Setup Menu.
- Press the SET UP button to return to the normal screen display.

### Video Encoding

Item	Description
TOTAL CONTENTS TIME	If you already know the duration of the video to be recorded, this parameter can be set to the corresponding time to allow your BD-X200 to select the optimum encoding bit rate. (Make a setting in hours and minutes.) ● If the recording time is set using this parameter, ENCODE QUALITY will be set automatically, and this setting may not be modified manually. ● If this function is not to be used, set it to NO USE. When this setting is made, ENCODE QUALITY will be returned to its previous setting.
ENCODE QUALITY (Mbps)	This parameter can be set when TOTAL CONTENTS TIME has been set to NO USE. Specifically, it allows direct setting of the encoding bit rate (i.e., the amount of data per second). Large values increase the quality of the video; however, this also increases the overall data size. Setting range: The range of values that can be set depends on the audio encoding format. LPCM : 4.0 to 7.8 Mbps (in 0.2 Mbps steps) DOLBY DIGITAL : 2.0 to 9.0 Mbps (in 0.2 Mbps steps)

## Settings & Controls for Recording

### Setting the Encoding Format for Audio & Video (continued)

#### Audio Encoding

■ AUDIO ENCODE

This parameter is used to set the encoding format for audio data.

LPCM : Linear PCM encoding  
 DOLBY DIGITAL : Dolby AC3 encoding.

**Note**

If the SET UP button is pressed while in Recording mode, the video bit-rate setting and audio encoding format will be displayed on-screen. Press the SET UP button once again to hide this information.

#### Guide to Recording Times

The time available for recording on a disc will depend on the video encoding bit rate and audio encoding format that have been set. Furthermore, the more titles a disc contains, the less time will be available for recording. Use the following table as a guide to the amount of time available for recording.

Audio encoding format	Encoding bit rate							
	9 Mbps	8 Mbps	7 Mbps	6 Mbps	5 Mbps	4 Mbps	3 Mbps	2 Mbps
DOLBY DIGITAL	61 min.	68 min.	77 min.	88 min.	103 min.	125 min.	157 min.	212 min.
LPCM	—	—	67 min.	76 min.	87 min.	102 min.	—	—

## Settings & Controls for Recording

### Setting the Encoding Format for Audio & Video (continued)

#### Audio Encoding

■ AUDIO ENCODE

This parameter is used to set the encoding format for audio data.

LPCM : Linear PCM encoding  
 DOLBY DIGITAL : Dolby AC3 encoding.  
 MPEG : MPEG encoding.

**Note**

If the SET UP button is pressed while in Recording mode, the video bit-rate setting and audio encoding format will be displayed on-screen. Press the SET UP button once again to hide this information.

#### Guide to Recording Times

The time available for recording on a disc will depend on the video encoding bit rate and audio encoding format that have been set. Furthermore, the more titles a disc contains, the less time will be available for recording. Use the following table as a guide to the amount of time available for recording.

Audio encoding format	Encoding bit rate							
	9 Mbps	8 Mbps	7 Mbps	6 Mbps	5 Mbps	4 Mbps	3 Mbps	2 Mbps
DOLBY DIGITAL	62 min.	69 min.	78 min.	89 min.	105 min.	126 min.	161 min.	218 min.
MPEG	63 min.	70 min.	79 min.	91 min.	108 min.	131 min.	168 min.	231 min.
LPCM	—	—	68 min.	77 min.	88 min.	103 min.	—	—



## Adjusting of Audio Recording Levels

This DVD recorder's audio recording levels can be adjusted using two different methods, and AUDIO REC VOLUME MODE from the RECORDER MENU (2/2) screen indicates the method to be used. In addition, it is also possible to return the audio recording levels to their default settings (i.e., unity gain).

**Note:** The AUDIO INPUT LEVEL switch on the DVD recorder's rear panel can be used to select the reference input level for analog audio (i.e., +4 dB or -8 dB).

### Selecting the Adjustment Method

RECORDER MENU (2/2) screen

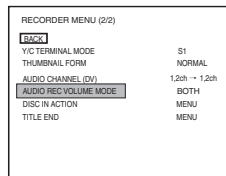

#### 1. Open the RECORDER MENU (2/2) screen.

To do this, select → button from the RECORDER MENU (1/2) screen and press the SET button.

#### 2. Make the required setting using AUDIO REC VOLUME MODE from the RECORDER MENU (2/2) screen.

**BOTH** : Audio levels are adjusted while both the CH1/CH2 are maintained at the same volume.  
**INDEPENDENCE** : The CH1/CH2 are adjusted separately.

### Adjusting the Audio Recording Levels

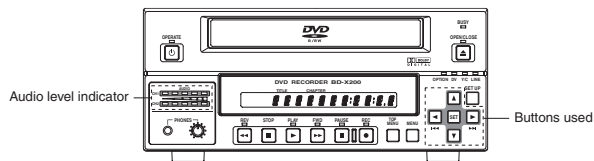

■ Return from setting screens to the normal display.

■ Recording levels can be adjusted in either Stop or Recording mode. Be sure to monitor the front panel's audio level indicator as the levels are being adjusted. Adjust the level so that the LED on the far right does not light.

Adjusting both channels together (BOTH)	Adjusting both channels separately (INDEPENDENCE)
<p>■ To raise the recording level</p> <p>Press the ▲ button while holding the ◀ or ▶ button to raise the audio recording levels for Channel 1 and Channel 2 simultaneously.</p>	<p>■ To adjust the Channel 1 level</p> <p>Press either the ▲ or ▼ button while holding the ◀ button. Pressing the ▲ button raises the recording level. Pressing the ▼ button lowers the recording level.</p>
<p>■ To lower the recording level</p> <p>Press the ▼ button while holding the ◀ or ▶ button to lower the audio recording levels for Channel 1 and Channel 2 simultaneously.</p>	<p>■ To adjust the Channel 2 level</p> <p>Press either the ▲ or ▼ button while holding the ▶ button. Pressing the ▲ button raises the recording level. Pressing the ▼ button lowers the recording level.</p>

### Returning Audio Recording Levels to Default Settings (UNITY MODE)

■ Press and hold the ◀ and ▶ buttons simultaneously to return the audio recording levels to their default settings (i.e., unity gain).  
 • Both of the audio recording levels will be fixed at the default setting.

## Settings & Controls for Recording

### Checking the Video Input

Use the monitor connected to the VIDEO LINE OUT terminal to confirm that the input video signal is as required. The following procedure will allow you to monitor the quality at which the video will be recorded to a DVD.

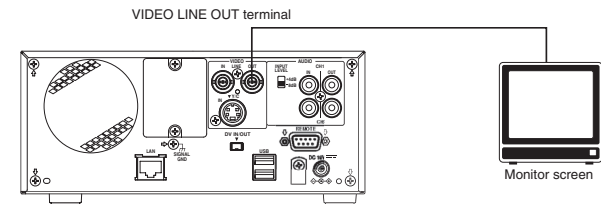

#### Signal Connections

Connect the VIDEO LINE OUT terminal to the monitor.

#### Procedure

■ Press and hold the REC button for at least 2 seconds while the DVD recorder is stopped or inserted with no disc. While this button is being held, input signal encoded/decoded in MPEG will be output via the VIDEO OUT terminal on the rear panel.  
 • This function allows the quality of the video to be confirmed before recording to a DVD.

**Note**  
 Audio will be muted at this time.

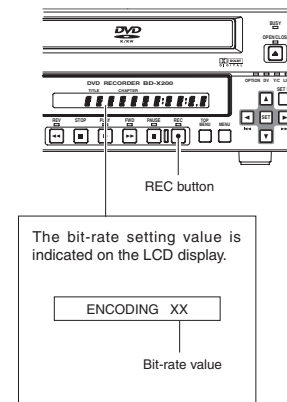

The bit-rate setting value is indicated on the LCD display.

ENCODING XX  
 Bit-rate value

## Selecting Styles for Title & Chapter Menu

Each recorded DVD contains title and chapter menus that provide information relating to its titles and chapters. Whenever recording is carried out, title numbers, chapter numbers, and thumbnails are automatically generated in order to create the title and chapter menus.

Specifically, the frames from the start of individual recordings are used as thumbnails for the title menu. In a similar way, the frames at which chapter marks have been inserted are used as thumbnails for chapter menus. (These thumbnails may be modified later on.) The title menu will become the top thumbnail of the chapter menu.

The term "style" is used to refer to a combination of thumbnail characteristics for the title and chapter menus. This DVD recorder can store eight different style types, and the PRESET STYLE MENU screen is used to indicate which of these types is to be used.

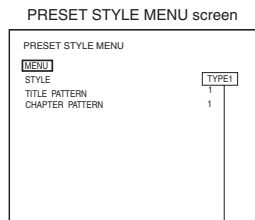
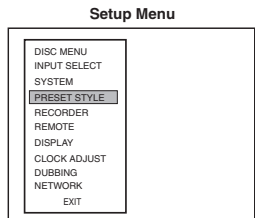

Type number

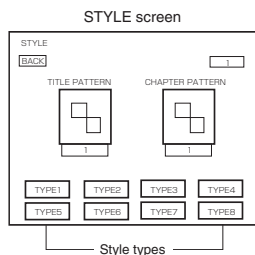

### Making Settings in the PRESET STYLE MENU screen

- Press the SET UP button to display the Setup Menu.
  - Select PRESET STYLE from the Setup Menu and then press the SET button.
    - The PRESET STYLE MENU screen will appear. Within this screen, the STYLE parameter indicates the style type currently selected for the title and chapter menus.
  - Confirm the settings for the currently selected style.
 

Select STYLE and then press the SET button to display the corresponding STYLE screen.

**TITLE PATTERN** : The display pattern currently selected for the title menu. Each display pattern uses different numbers, positions, and sizes for thumbnails, in addition to different backgrounds.

**CHAPTER PATTERN** : The display pattern currently selected for chapter menus. Each display pattern uses different numbers, positions, and sizes for thumbnails, in addition to different backgrounds.
  - Use the cursor buttons (▲, ▼, ►, and ◀) to select one of the eight style types and display the corresponding STYLE screen.
  - To use a specific style, select the corresponding type number and then press the SET button.
 

This type number will then be stored by the DVD recorder. Following this, the screen's BACK button will be highlighted. The SET button can now be pressed to return to the PRESET STYLE MENU screen.
- If BACK is used to exit the STYLE screen without the SET button being pressed for the newly selected type, the style setting will not be updated.

#### Notes

- The STYLE settings for chapter menus can be freely modified until title closing is carried out. (☞ Page 47)
- The STYLE settings for the title menu can be freely modified until the DVD is finalized. (☞ Page 53)
- Each style can be freely modified and stored in the DVD recorder's memory. In addition, it is also possible to freely select and modify display patterns (i.e., the number, position, and size of thumbnails in addition to the background). For more details regarding modification of PRESET STYLE, refer to page 43.
- In certain cases, the frames used for chapter menu thumbnails may differ slightly from the exact frames at which the corresponding chapter marks were inserted.

37

## Recording

### Recording Sequence

- Use the following sequence as a reference when performing recording.
- Input settings: ☞ Page 32.
  - Video and audio quality settings: ☞ Pages 33, 34.
  - Navigation settings (i.e., DISC IN ACTION and TITLE END): ☞ Page 81

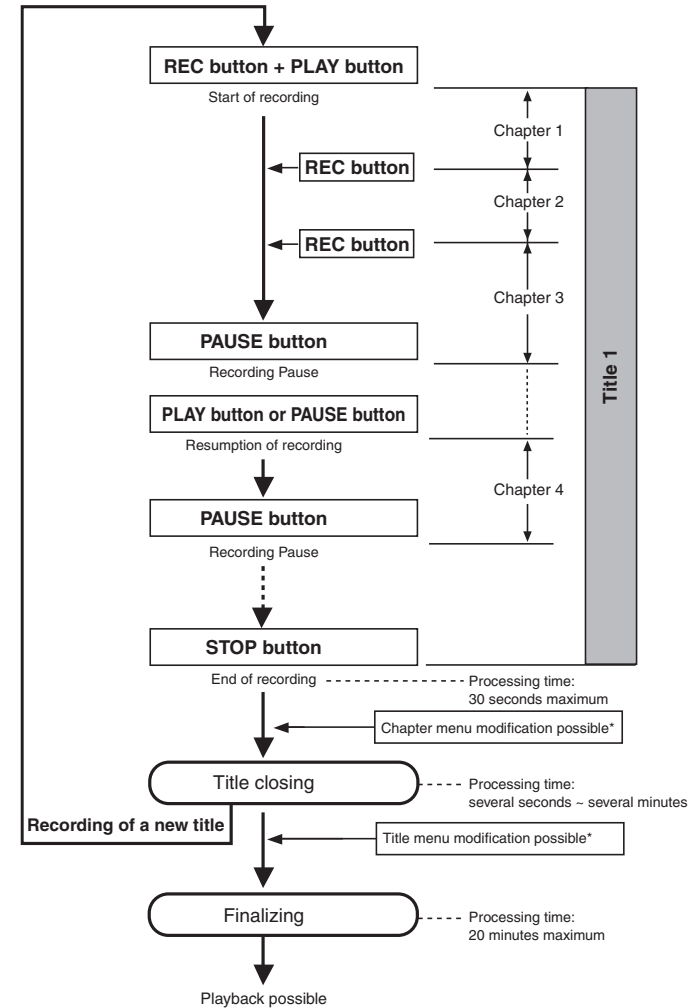

\* Title and chapter menu modification will be possible when EDIT MENU from the SYSTEM MENU screen has been set to ENABLE.

\* Playback will not be possible until a disc has been finalized.

38

## Recording with the Front Panel

BD-X200 recording operations can be carried out in two different ways — namely, using the buttons provided on the front panel and using the on-screen REC CONTROL panel. In the latter case, furthermore, recording operations can be performed using a keyboard and mouse. The following section, however, will provide a description of recording using the front panel buttons.

On a DVD, the section of video recorded between the start of recording and pressing of the STOP button to end recording is stored as a single title, and a unique title number is assigned to each of these sections. A single disc can contain up to 99 different titles. In addition, each title can be separated into a number of different chapters by inserting chapter marks at the appropriate points, and each title can contain up to 99 chapters.

Information relating to titles and chapters is stored on a disc in the form of title and chapter menus. When the disc is being played, therefore, the title and chapter menu can be used to access specific sections of stored video and audio.

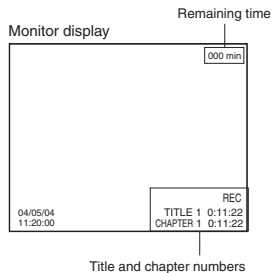
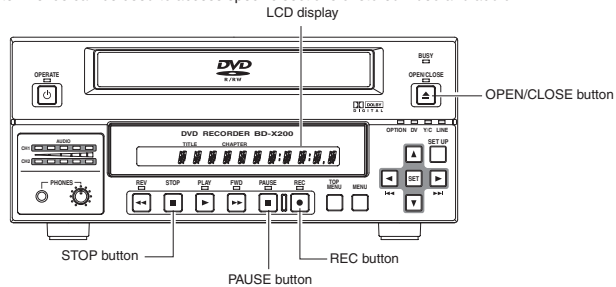

### Notes

- A maximum of 10 minutes will be required to complete title closing.
- The remaining time available for recording on a disc will be displayed on the monitor. Note that this is to be used as a general guide, not as an exact figure. (DISPLAY and REMAIN from the DISPLAY MENU screen must both be ON for this figure to be displayed.)
- During the recording process, the current title number and chapter number are displayed on the monitor. (DISPLAY and TITLE/CHAPTER from the DISPLAY MENU screen must both be ON for these numbers to be displayed.)

■ Insert a disc that can be recorded on.

**1. With the DVD recorder stopped, make all of the required settings and adjust the audio recording levels.**

**2. Start recording.**

This is done by pressing the REC and PLAY buttons simultaneously.

**3. Pause recording.**

This is done by pressing the PAUSE button.

- The DVD recorder will adopt Recording Pause mode and a chapter mark will be inserted at the current position.

A number of different methods can also be used for the manual or automatic insertion of chapter marks. (☞ Page 40)

**4. Restart recording.**

Press the PLAY or PAUSE button.

- Recording will begin once again and a new chapter will be created in the current title.

**5. End recording (i.e., close the title)**

Press the STOP button when either recording or paused.

- The action of the DVD recorder following the end of recording depends on the setting of EDIT MENU from the SYSTEM MENU screen.

DISABLE : Recording is ended and the chapter menu is created using preset settings (i.e., the title is closed).

ENABLE : The THUMBNAIL EDIT screen will appear. This screen can be used to modify the chapter menu's display style, to change the thumbnails used, to input chapter names, and to perform other similar functions. For more details, refer to page 47.

■ If additional recording is to be carried out, repeat steps 1 through 5 above.

- In such a case, the subsequent recording is stored as a new title.

## Recording

### Recording with the Front Panel (continued)

#### Note

When recording is stopped or a title is closed, the state of progress will be indicated on-screen using a progress bar.



**6. End recording and remove the disc.**

Depending on how the disc will be used, one of two different procedures is implemented at this time.

- **If more content will be recorded to the disc using this DVD recorder:** Simply press the OPEN/CLOSE button and remove the disc. (Do not finalize the disc before it is removed.)

- **If the disc is to be played on this DVD recorder or on a different DVD player:**

Finalize the disc, press the OPEN/CLOSE button, and then remove the disc. For more details regarding finalizing, refer to page 42.

### Inserting Chapter Marks Manually or Automatically

#### RECORDER MENU (1/2) screen

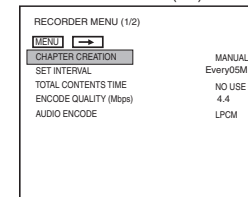

In addition to pausing the recording, a number of different manual and automatic methods can be used to insert chapter marks.

The actual method to be used is determined by CHAPTER CREATION and SET INTERVAL from the RECORDER MENU (1/2) screen.

- If chapter marks are to be inserted manually at any point, set CHAPTER CREATION to MANUAL.

Chapter marks can then be inserted by pressing the REC button while recording.

- If chapter marks are to be inserted automatically, first of all set CHAPTER CREATION to AUTO. Then use SET INTERVAL to set a time (in minutes) for chapter mark insertion.

The DVD recorder will insert chapter marks at the corresponding intervals during recording.

#### Notes

- The frame at which a chapter mark is inserted will be used for the corresponding thumbnail in the chapter menu. When EDIT MENU from the SYSTEM MENU screen is set to ENABLE, the frames used for thumbnails can be modified on the THUMBNAIL EDIT screen that appears automatically at the end of recording.
- Each title can contain up to 99 chapters.
- In certain cases, the frames used for chapter menu thumbnails may differ slightly from the exact frames at which the corresponding chapter marks were inserted.

## Using a Keyboard & Mouse to Control Recording

BD-X200 recording operations can be carried out using the REC CONTROL panel displayed on the monitor. In addition, a keyboard and mouse can also be used when working with this panel.

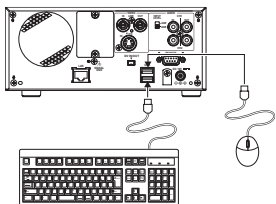

REMOTE MENU screen

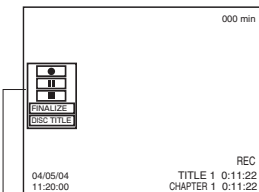
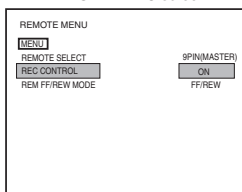

REC CONTROL panel

### Notes

- DISC TITLE from the REC CONTROL panel can be selected to allow a name to be input for the disc. This type of name proves useful when managing discs using a PC. Note that disc names are not displayed on the monitor or the DVD recorder.
- Characters allowed for the disc title are alphanumerical characters and underscore (\_) only. Space and other symbols may not be used.
- FINALIZE and DISC TITLE from the REC CONTROL panel cannot be used while recording.
- The Record (●) button from the REC CONTROL panel can be activated or clicked to insert chapter marks and thumbnails during recording.

### Signal Connections

Connect a keyboard and mouse to the USB terminals on the back of the DVD recorder.

### Settings

- If the REC CONTROL panel is to be displayed on-screen, set REC CONTROL from the REMOTE MENU screen to ON. This panel will be displayed in Stop, Recording, and Recording Pause mode.
- To open the Setup Menu, press the DVD recorder's SET UP button. It is not possible to open this screen using the keyboard or mouse.

### Procedure

#### 1. Start recording.

- Keyboard : Use the arrow keys (←, →, ↑, and ↓) to select Record (●) from the REC CONTROL panel, and then press the Enter key.
- Mouse : Move the mouse pointer to the Record (●) button and left click while the Record button selected.

#### 2. Pause recording.

- Keyboard : Use the arrow keys (←, →, ↑, and ↓) to select Pause (||) from the REC CONTROL panel, and then press the Enter key.
- Mouse : Move the mouse pointer to the Pause (||) button and left click while the Pause button is selected.

- The DVD recorder will adopt Recording Pause mode; in addition, a chapter mark and thumbnail will be inserted at the current position.

#### 3. Restart recording.

- Keyboard : Use the arrow keys (←, →, ↑, and ↓) to select either Record (●) or Pause (||) from the REC CONTROL panel, and then press the Enter key.

- Mouse : Move the mouse pointer to the Record (●) or Pause (||) button and left click while the Record or Pause button is selected.

■ Steps 2 and 3 can be repeated to create a single, partitioned title.

#### 4. End recording (i.e., close the title)

- Select Stop (■) from the REC CONTROL panel and press the Enter key.

- The action of the DVD recorder following the end of recording depends on the setting of EDIT MENU from the SYSTEM MENU screen.
- DISABLE : Recording is ended and the chapter menu is created using standard settings (i.e., the title is closed).
- ENABLE : The THUMBNAIL EDIT screen will appear. This screen can be used to modify the chapter menu's display style, to change the thumbnails used, to input chapter names, and to perform other similar functions. For more details, refer to page 47.

■ If additional recording is to be carried out, repeat steps 1 through 4 above.

- In such a case, each subsequent recording will be stored as a new title.

#### 5. End recording and remove the disc.

Depending on how the disc will be used, one of two different procedures is implemented at this time.

- If more content will be recorded to the disc using this DVD recorder: Simply press the DVD recorder's OPEN/CLOSE button and remove the disc. (Do not finalize the disc before it is removed.)

- If the disc is to be played on this DVD recorder or on a different DVD player: Use FINALIZE from the REC CONTROL panel to finalize the disc before it is ejected.

For more details regarding finalizing, refer to page 42.

## Recording

### Finalizing (for playback on this and other DVD players)

Finalize a disc recorded using this DVD recorder as described below in order to ensure that it can be played on this and other DVD players. In the case of DVD-RWs, playback will be possible on DVD players that support video mode.

#### After finalizing a disc:

- No additional recording will be possible.
- The title menu cannot be changed.
- The titles created before finalizing will be displayed as the top menu.

### Finalizing

The process of finalizing can be carried out in two different ways.

- Select DISC MENU and then FINALIZE from the Setup Menu.
- Select FINALIZE on the REC CONTROL panel when this is being used for recording.

Setup Procedure: Insert the disc to be finalized.

#### 1. If using the Setup Menu:

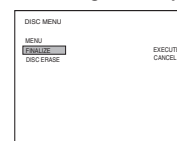

- Press the SET UP button to display the Setup Menu, and then select DISC MENU.
- Set FINALIZE from the DISC MENU screen to EXECUTE and then press the SET button.

#### 1. If using the REC CONTROL panel:

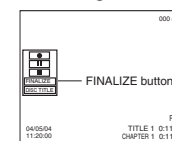

Select FINALIZE and then press the keyboard's Enter key.  
\* If operating using a mouse, left click the FINALIZE button.

#### The screen that will now be displayed depends on the setting of EDIT MENU from the SYSTEM MENU screen.

If this is set to DISABLE, a screen seeking confirmation of finalizing will appear. In this case, perform finalizing as described below.

If this is set to ENABLE, a screen for editing title menus will appear. Use this screen to confirm that the title menu is as required, to modify the display style, and to input title names. (≠ Page 53)

#### 2. Make the appropriate selection in the confirmation screen.

Confirmation screen

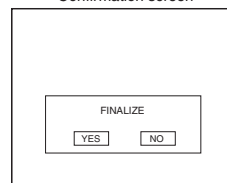

Progress screen

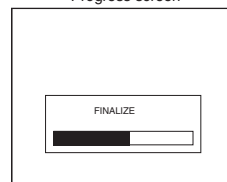

#### 1. Select YES and then press the SET button to continue finalizing.

- The finalizing process will begin.
  - A bar showing the state of progress will be displayed during finalizing.
  - The progress bar will disappear when finalization has been completed and the normal screen display will then be restored. (The REC CONTROL panel will not be displayed.)
- Select NO from the confirmation screen to cancel finalizing and return to the previous screen.

#### Notes

- A maximum of 20 minutes will be required to complete finalizing.
- When finalizing is carried out, all of the disc's recorded video and audio are stored in accordance with the DVD Video Standard; accordingly, this content can also be replayed as DVD video.
- Although a disc finalized using this DVD recorder may in principle be played on other DVD players, there is no guarantee that all of its content will be playable.
- The action to be taken by this DVD recorder when a finalized disc is inserted or when playback of a title has ended is specified by DISC IN ACTION and TITLE END respectively from the RECORDER MENU (2/2) screen. TITLE END is to be set before recording a title. DISC IN ACTION is to be set before finalizing.

# Title & Chapter Menu Settings

## BD-X200 Title & Chapter Menus

This DVD recorder can automatically create title and chapter menus in response to recording operations and can save these to the disc being recorded.

When the disc is subsequently played, these title and chapter menus can be used to access specific sections of stored video and audio.

- When recording is stopped using the STOP button or a similar action (i.e., disc closing), a title number and a thumbnail (corresponding to the frame at the start of recording) will be created to form part of the disc's title menu. A single disc can contain up to 99 different titles.
- Similarly, if a chapter mark is inserted during recording, a chapter number and a thumbnail (corresponding to the frame at the chapter mark) will be created to form part of the title's chapter menu. Chapter marks are used as targets for skipping during playback. Each title can contain up to 99 chapters.

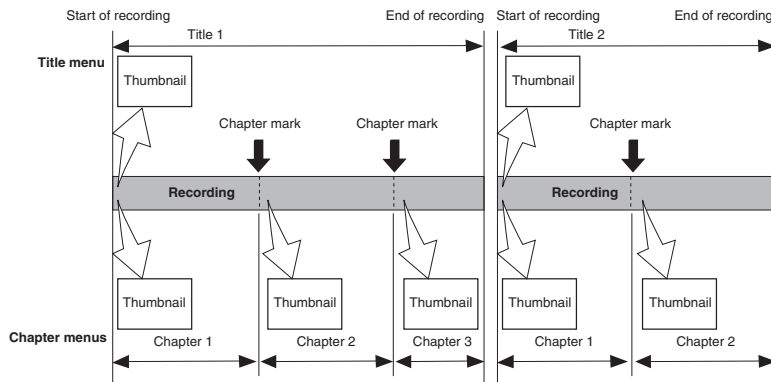

### Display Styles

A total of eight different display styles can be used with title and chapter menus. The PRESET STYLE MENU screen can be used to select the type of style to be used in the creation of title and chapter menus. In addition, each of the display styles can be modified as required. (☞ Page 45) Depending on the style used and the number of menu items, title and chapter menus may extend over more than one page.

### Notes

- This DVD recorder can store a total of six different display patterns for title and chapter menus. At the time of purchase, your BD-X200 will contain five different template files. Any of the stored display patterns can be selected to change the styles applied to each of the title and chapter menus.
- In addition, original title and chapter menus can also be created using Easy menu a freeware application for editing menu templates. (☞ Page 46)

### Modifying Chapter Menus

A chapter menu's display style and thumbnails can be edited at the end of recording (i.e., during title closing); furthermore, titles and comments for the chapter menu can also be input at this time. (EDIT MENU from the SYSTEM MENU screen must be set to ENABLE for this to be possible.)

(☞ Page 47)

### Modifying the Title Menu

The style used for the title menu and the text input for the title name may both be modified before finalizing is carried out. (EDIT MENU from the SYSTEM MENU screen must be set to ENABLE for this to be possible.)

(☞ Page 53)

### Notes

- Thumbnail of the title menu will be the top thumbnail of the chapter menu.
- Once a title is closed, it will no longer be possible to modify the chapter menu.
- No modifications whatsoever will be possible when the disc has been finalized.
- When a disc is finalized, its title menu will be used to create the top menu.
- Thumbnail creation method during wide-signal recording can be selected in THUMBNAIL FORM of the RECORDER (2/2) menu screen.

# Title & Chapter Menu Settings

## Selecting and Changing Styles for Title & Chapter Menus

Title and chapter menus are used during playback of a DVD to select a title or chapter for viewing. Your BD-X200 provides a total of eight different styles for displaying title and chapter menus. Use the following procedure during the recording process to select styles for these menus.

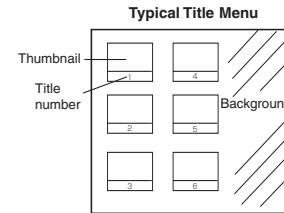

### Notes

- This DVD recorder can store a total of eight display styles, where each style is a combination of title and chapter menu display characteristics.
- The title menu can be displayed by pressing the TOP MENU button on the front panel while in Stop or Playback mode; furthermore, the chapter menu can then be opened using the MENU button.

## Confirming or Selecting a Style

Display styles can be selected and modified using the PRESET STYLE MENU screen.

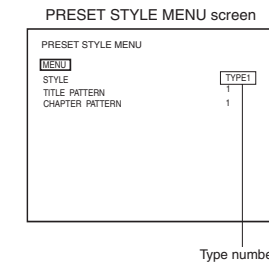

1. Press the SET UP button to display the Setup Menu, select PRESET STYLE, and then press the SET button.
  - The PRESET STYLE MENU screen will appear.

2. Confirm the settings for the currently selected style.

The STYLE parameter will display the type number of the style currently selected.

■ Select STYLE and then press the SET button to display the corresponding STYLE screen.

TITLE PATTERN : The display pattern currently selected for the title menu. Each display pattern uses different numbers, positions, and sizes for thumbnails, in addition to a different background.

CHAPTER PATTERN : The display pattern currently selected for chapter menus. Each display pattern uses different numbers, positions, and sizes for thumbnails, in addition to a different background.

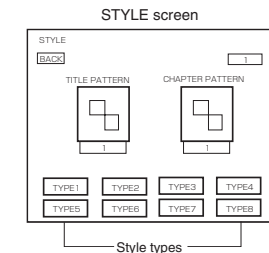

3. Use the cursor buttons (▲, ▼, ►, and ◀) to select one of the eight style types and to display the corresponding STYLE screen, containing both title and chapter patterns.

4. To use a specific style, select the corresponding type number and then press the SET button.

This type number will then be stored in the DVD recorder's memory. Following this, the screen's BACK button will be highlighted. The SET button can now be pressed to return to the PRESET STYLE MENU screen.

■ If BACK is used to exit the STYLE screen without the SET button being pressed for the newly selected type, the style setting will not be updated.

## Selecting Display Styles

The PRESET STYLE MENU screen can be used to change the styles used for displaying title and chapter menus. One of eight different types of style can be selected for each of the title and chapter menus. This DVD recorder can also store a total of six different display patterns for title and chapter menus. At the time of purchase, your BD-X200 will contain five different template files. Any of the stored display patterns can be selected to change the styles applied to each of the title and chapter menus.

PRESET STYLE MENU screen

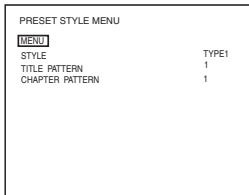

### 1. Open the PRESET STYLE MENU screen.

This screen allows patterns to be modified for the style indicated by the STYLE parameter.

TITLE PATTERN : Shows the pattern number for the current title-menu display style as indicated by the STYLE parameter.

CHAPTER PATTERN : Shows the pattern number for the current chapter-menu display style as indicated by the STYLE parameter.

When the STYLE parameter's number setting is changed, the patterns used for title and chapter menus in the new style will be displayed by TITLE PATTERN and CHAPTER PATTERN respectively.

### 2. Change the display patterns for the title and chapter menus as required.

For example, let's change the title menu's display pattern from 1 to 4. Select TITLE PATTERN from the PRESET STYLE MENU screen and press the SET button.

- The TITLE PATTERN screen will appear.

### 3. Use the cursor buttons (▶, ◀, ▲, and ▼) to select the fourth pattern on the TITLE PATTERN screen, and then press the SET button.

- The title menu's display pattern changes to No. 4, and the BACK button becomes highlighted.

### 4. With the BACK button highlighted, press the SET button and return to the PRESET STYLE MENU screen.

■ If BACK is used to exit the TITLE PATTERN screen without the SET button being pressed for the newly selected pattern, the pattern setting will not be updated.

To change the display pattern for chapter menus, select CHAPTER PATTERN from the PRESET STYLE MENU screen and then proceed in the same way as described above.

#### Note

The TITLE PATTERN screen and CHAPTER PATTERN screen show the patterns that are currently stored in your BD-X200.  
Display pattern: A combination of thumbnail characteristics (i.e., position, quantity, and size) and the type of menu background used.

## Title & Chapter Menu Settings

### Selecting and Changing Styles for Title & Chapter Menus (continued)

#### Ending Settings in the PRESET STYLE MENU Screen

PRESET STYLE MENU screen

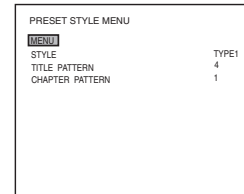

#### ■ To end settings in the PRESET STYLE MENU screen;

Select MENU and press the SET button to return to the Setup Menu.

#### ■ To end menu settings;

Either press the front panel's SET UP button or select EXIT from the Setup Menu and then press the SET button.

### Easymenu: Freeware for Editing Menu Templates

The freeware application Easymenu can be used to create original DVD menus on your PC. Menu templates created with this application can then be transferred to your BD-X200 using a network cable, thus allowing you to make imaginative and creative DVDs with the minimum of effort. Easymenu can be downloaded from the following web page. Please refer to the software manual for details regarding usage and precautions.

<http://www.jvc-victor.co.jp/english/pro/prodv/>

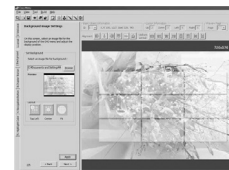

Create menu patterns on your PC

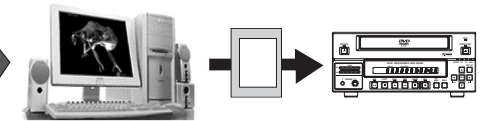

Transfer the patterns via a network

#### ■ Main Specifications (Please refer to the above-mentioned home page for the most up-to-date information.)

OS : Windows XP  
 Properties set : Thumbnail number, size, and position; background image (per page), and chapter comments.  
 Thumbnail highlighting format and color; navigation button design and layout.  
 Readable image files : BMP and JPEG  
 Layout size : 720 × 480 (NTSC)



## Changing Chapter Menus (THUMBNAIL EDIT screen)

This DVD recorder can automatically create title and chapter menus as recording operations are started and stopped. Title and chapter menus are created using the following.

- Title or chapter names : Numbers are applied based on the recording sequence.
- Chapter thumbnails : The frames at which chapter marks have been inserted are used as thumbnails.
- Title thumbnails : The frames at the start of individual recordings are used as thumbnails. As a result, a title's thumbnail is the same as that of its first chapter.
- Display style : Menus are created using the style set using the PRESET STYLE MENU screen. (Styles determine factors such as thumbnail positioning and background)

After chapter menus have been created in this way, it will be possible to modify thumbnails and styles, or to insert new names and comments.

In specific terms, the editing of chapter menus is carried out using the THUMBNAIL EDIT screen that appears when recording of a title is ended.

## Opening the THUMBNAIL EDIT screen

### SYSTEM MENU Screen

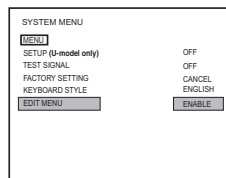

### ■ Set EDIT MENU from the SYSTEM MENU screen to ENABLE.

- The THUMBNAIL EDIT screen will appear automatically whenever moving to Stop mode from Recording mode or Recording Pause mode.

### Note

If EDIT MENU from the SYSTEM MENU screen is set to DISABLE, the THUMBNAIL EDIT screen will not be displayed. In such a case, title and chapter menus are created using preset settings.

### ■ THUMBNAIL EDIT screen

When initially displayed, the THUMBNAIL EDIT screen contains thumbnails for up to six recorded chapters in the order that they were recorded. The seventh and subsequent thumbnails are displayed on the following pages.

- This initial screen can be used to change a chapter's thumbnail or to input names and comments.
- Operations on this screen can be carried out using the front panel buttons, a keyboard, or a mouse.

Front panel : Select using the ►, ◀, ▲, and ▼ buttons, and confirm the selection using the SET button.

Keyboard : Select using the arrow keys and confirm the selection using the Enter key. The input of names and comments is also carried out using the keyboard.

Mouse : Left click the required item.

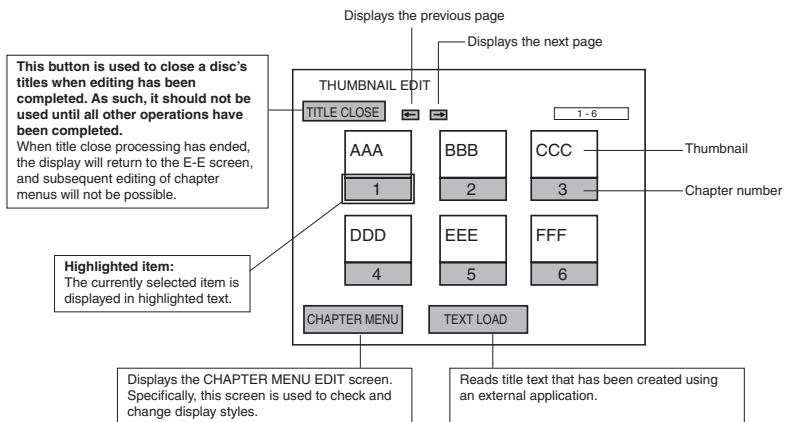

## Title & Chapter Menu Settings

### Changing & Naming Thumbnails for Chapter Menus

The modification of chapter menu thumbnails and the entry of names and comments are carried out as described below using the THUMBNAIL EDIT screen.

### Changing thumbnails

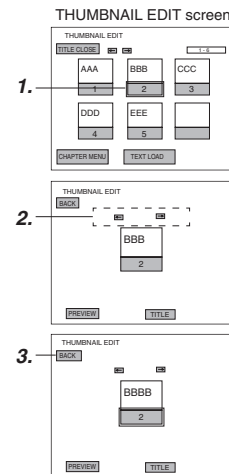

For example, let's change the thumbnail for the second chapter.

#### 1. Select the second chapter and press the SET button.

- The thumbnail screen for this chapter will be displayed.

#### 2. Select the thumbnail to be used for the second chapter.

Thumbnails can be selected using the → and ← buttons found on this screen.

- If you select → and press the SET button, the image\* recorded after the selected thumbnail will be displayed. Each time the SET button is pressed, a subsequent image will be displayed. (\*Image after 15 frames)
- If you select ← and press the SET button, the image recorded before the selected thumbnail will be displayed. Each time the SET button is pressed, a previous image will be displayed.

#### 3. Select BACK and press the SET button to change that chapter's thumbnail.

- The initial THUMBNAIL EDIT screen is displayed once again. The thumbnail for the second chapter will have changed to that just selected.

\* Thumbnail of the title menu will be the top thumbnail of the chapter menu.

### Checking thumbnails

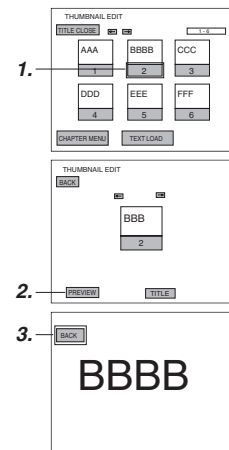

Use the following procedure to confirm that thumbnails are as desired by displaying them in full-screen mode.

For example, let's look at the thumbnail for the second chapter.

#### 1. Select the second chapter and press the SET button.

- The thumbnail screen for this chapter will be displayed.

#### 2. Select PREVIEW and then press the SET button.

- The thumbnail image for this chapter will be displayed in full-screen mode.

#### 3. Select BACK and press the SET button to return to the THUMBNAIL EDIT screen.

## Entering Names and Comments for Chapter Menus

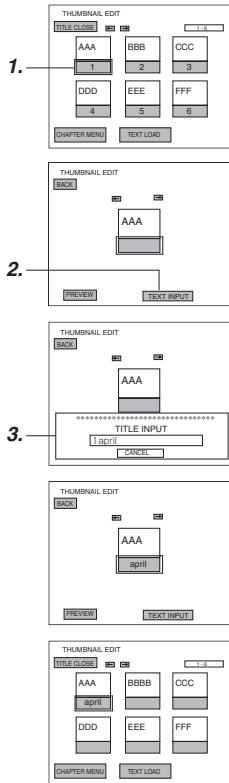

Use the following procedure to apply names to the thumbnails used in chapter menus, and also to add comments to be displayed on a chapter menu screen.

### Names and comments are entered using a keyboard.

Set KEYBOARD STYLE from the SYSTEM MENU screen in accordance with the keyboard's input language.

The following description assumes that all operations are carried out by keyboard.

For example, let's now apply a name to the first chapter.

**1. Use the arrow keys to select the first chapter from the THUMBNAIL EDIT screen, and then press the Enter key.**  
 • The thumbnail screen for this chapter will be displayed.

**2. Select TITLE using the arrow keys and then press the Enter key.**  
 • A box for inputting text will appear.

**3. Enter a name or comment into the text box.**

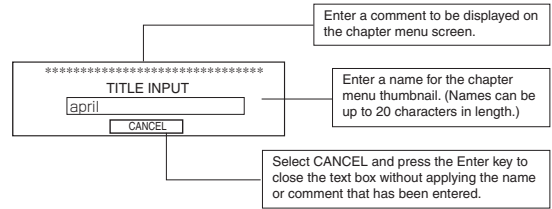

### Notes

- The ¥ mark will become a backslash.
- If text cannot be entered, press the CTRL key (right side) on the keyboard.

**4. After the required text has been entered, press the Enter key.**

- The text box will close.
- The field previously showing the chapter number will now be highlighted showing the text that was input.
- The text that has been input will be displayed on the chapter menu screen.

**5. Select BACK and then press the Enter key.**

- The initial THUMBNAIL EDIT screen will again be displayed, and the name or comment will be shown for the first chapter.

### Display Characters

The characters displayed in title and chapter menus depend on the title or chapter pattern that has been selected. A preview allows actual display characters to be confirmed. Note that at the time of purchase, display characters will be as follows.

PATTERN No.	Display characters
1	16
2	19
3	17
4	20 (15 + line return + 5)
5	16
6	—

### Note

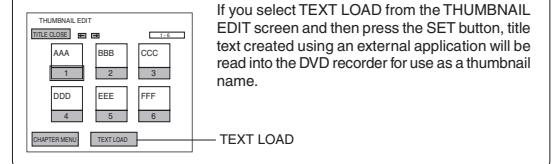

## Title & Chapter Menu Settings

### Changing & Checking Chapter Menu Styles

Although display styles for chapter menus are created using settings from the PRESET STYLE MENU screen as described above, the following procedure can be used to modify these styles at the end of title recording. In addition, it will also be possible at this time to confirm that chapter menus are as required.

These actions are carried out by selecting and confirming CHAPTER MENU from the THUMBNAIL EDIT screen.

### Changing the Display Style

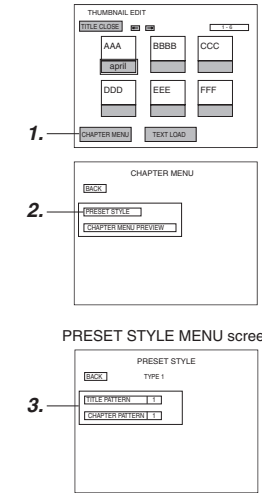

**1. Select CHAPTER MENU from the THUMBNAIL EDIT screen and press the SET button.**

- The CHAPTER MENU EDIT screen will appear.

**2. Select PRESET STYLE from the CHAPTER MENU EDIT screen and then press the SET button.**

- The PRESET STYLE MENU screen will appear.
- The style number set using the PRESET STYLE parameter will be displayed in this screen.

**3. To change the display PATTERN;**

- Select PATTERN and then press the SET button.
- Turn to page 44 for details regarding the editing procedure.

\* TITLE PATTERN and CHAPTER PATTERN changed here are also reflected in PRESET STYLE of the SETUP MENU.

## Checking the Chapter Menu Screen

Use the following procedure to see how the chapter menu looks when the selected display style is used.

### THUMBNAİL EDIT START screen

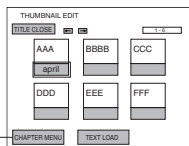

1.

### CHAPTER MENU EDIT screen

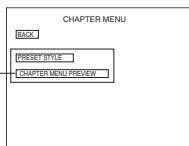

2.

### CHAPTER MENU PREVIEW screen

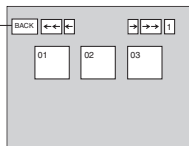

4.

1. Select **CHAPTER MENU** from the **THUMBNAİL EDIT START** screen and press the **SET** button.
  - The **CHAPTER MENU EDIT** screen will appear.

2. Select **CHAPTER MENU PREVIEW** from the **CHAPTER MENU EDIT** screen and press the **SET** button.
  - The **CHAPTER MENU PREVIEW** screen will appear. Here, it will be possible to preview the first page of the chapter menu.

3. Confirm that the other pages are as required.

Select → from the **CHAPTER MENU PREVIEW** screen and press the **SET** button to move to the next page.

Select ← and press the **SET** button to move to the previous page.

→→ and ←← can be used in combination with the **SET** button to skip forward or back in units of ten pages.

4. Complete the preview process.

To do this, select **BACK** from the **CHAPTER MENU PREVIEW** screen and press the **SET** button.

- The **CHAPTER MENU EDIT** screen will reappear.

5. Select **BACK** from the **CHAPTER MENU EDIT** screen and press the **SET** button to return to the **THUMBNAİL EDIT** screen.

#### Notes

- Up to 20 seconds per page will be required to create preview displays. More time may be required depending on the number of thumbnails per page.
- During creation of preview displays, jump by selecting the →→ button can only be made to the page being created.

## Title & Chapter Menu Settings

### Ending the Editing of Chapter Menus

Once all of the necessary changes and checks have been made using the **THUMBNAİL EDIT** screen, title closing must be carried out.

Please ensure that title closing is performed as the last stage of chapter menu editing.

Even if the chapter menu is to be left unchanged, title closing must be carried out to leave the **THUMBNAİL EDIT** screen. Note that when title closing has been completed, chapter menu details will be permanently set.

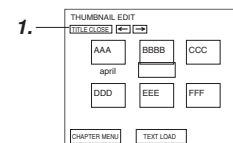

1.

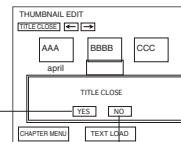

2.

Select **NO** and then press the **SET** button to close the confirmation window. The title will not be closed in this case.

1. Select **TITLE CLOSE** from the **THUMBNAİL EDIT** screen and press the **SET** button.
  - A confirmation window will appear.

2. If you wish to proceed with title closing, select **YES** and then press the **SET** button.
  - Title closing will begin. The state of progress during title closing is displayed using a progress bar.

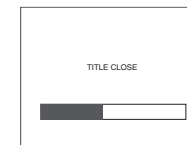

- When title closing has been completed, the progress bar will disappear.

#### Notes

- A maximum of 10 minutes will be required to complete title closing.
- If **EDIT MENU** from the **SYSTEM MENU** screen is set to **DISABLE**, title closing will be carried out automatically whenever recording is ended by, for example, pressing the **STOP** button. In such a case, title and chapter menus are created using preset settings.

## Changing & Checking Title Menu Styles & Names

If EDIT MENU from the SYSTEM MENU screen is set to ENABLE, the TITLE MENU EDIT screen will be displayed upon disc finalizing. Using this screen, it will be possible to change the title menu's display style, to enter title names, and to confirm that the title and chapter menus are as required.

- Thumbnail of the title menu will be the top thumbnail of the chapter menu.

### Opening the TITLE MENU EDIT screen

TITLE MENU EDIT screen

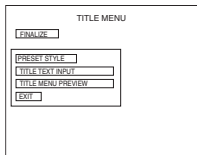

#### Settings

Set EDIT MENU from the SYSTEM MENU screen to ENABLE.

#### Procedure

The TITLE MENU EDIT screen will be displayed when finalizing of the disc is started.

### Changing the Display Style

TITLE MENU EDIT screen

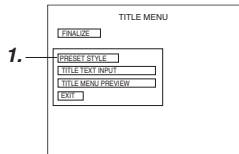

1. Select PRESET STYLE from the TITLE MENU EDIT screen and press the SET button.
  - The PRESET STYLE screen will appear.

2. To change the display PATTERN;
  - Select TITLE PATTERN and then press the SET button.

For more details regarding the editing procedure, refer to page 45.

\* The TITLE PATTERN changed here is also reflected in PRESET STYLE of the SETUP MENU.

PRESET STYLE screen

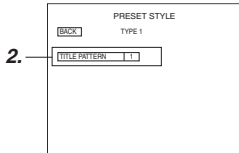

## Title & Chapter Menu Settings

### Changing & Checking Title Menu Styles & Names (continued)

#### Checking the Title Menu Screen

TITLE MENU EDIT screen

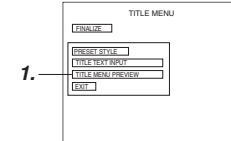

1. Select TITLE MENU PREVIEW from the TITLE MENU EDIT screen and press the SET button.
  - The TITLE MENU EDIT screen will appear.

2. Confirm that the other pages are as required.
  - Select → from the TITLE MENU PREVIEW screen and press the SET button to move to the next page. Starting with the first page of the title menu, the display will move forward through the pages each time → is selected and the SET button is pressed.
  - Select ← and press the SET button to move to the previous page.
  - → and ← can be used in combination with the SET button to skip forward or back in units of ten pages.

TITLE MENU PREVIEW screen

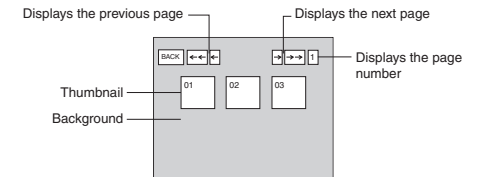
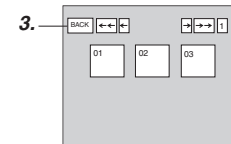

TITLE MENU EDIT screen

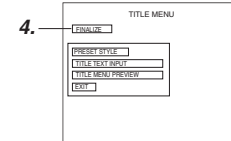

3. Complete the preview process.
  - To do this, select BACK from the TITLE MENU PREVIEW screen and press the SET button.
  - The TITLE MENU EDIT screen will reappear.

4. If you wish to finalize the disc, select FINALIZE from the TITLE MENU EDIT screen and then press the SET button.
  - (☞ page 56)

#### Notes

- Up to 20 seconds may be required per page to display the PREVIEW screen. More time may be required depending on the number of thumbnails per page.
- During creation of preview displays, jump by selecting the →→ button can only be made to the page being created.

## Entering Names for the Title Menu

TITLE MENU EDIT screen

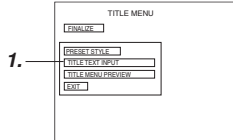

TITLE TEXT INPUT screen

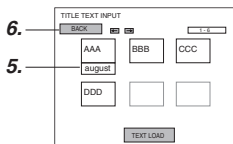
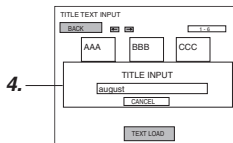
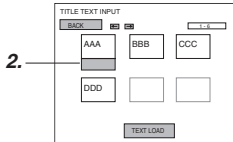

Use the following procedure to enter names for titles in the title menu.

■ **Names and comments are entered using a keyboard.**

Set KEYBOARD STYLE from the SYSTEM MENU screen in accordance with the keyboard's input language.

■ The following description assumes that all operations are carried out by keyboard.

**1. Select TITLE TEXT INPUT from the TITLE MENU EDIT screen and press the Enter key.**

- The TITLE TEXT INPUT screen is displayed.

**2. Use the arrow keys to select the title for which text is to be input.**

- The currently selected title is highlighted.

**3. Press the Enter key.**

- A box for inputting text will appear.

**4. Enter a name or comment into the text box.**

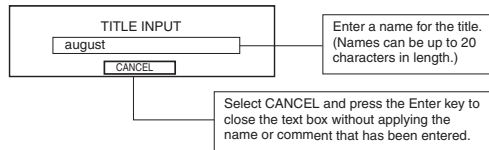

**Notes**

- The ¥ mark will become a backslash.
- If text cannot be entered, press the CTRL key (right side) on the keyboard.

**5. After the required text has been entered, press the Enter key.**

- The text box will close.
- The name just entered will be applied to the selected title.

**6. Select BACK and then press the Enter key.**

- The TITLE MENU EDIT screen will reappear.

### Display Characters

The characters displayed in title and chapter menus depend on the title or chapter pattern that has been selected. A preview allows actual display characters to be confirmed. Note that at the time of purchase, display characters will be as follows.

PATTERN No.	Display characters
1	16
2	19
3	17
4	20 (15 + line return + 5)
5	16
6	—

### Note

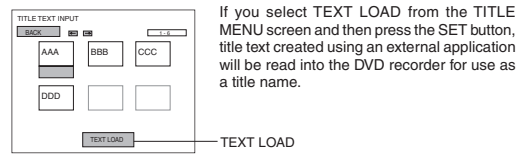

## Title & Chapter Menu Settings

### Changing & Checking Title Menu Styles & Names (continued)

#### Finalizing Discs

TITLE MENU EDIT screen

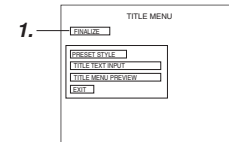

Confirmation screen

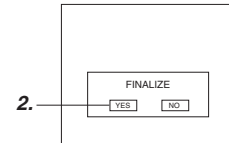

Progress screen

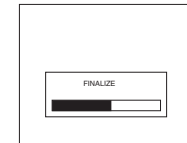

**1. Select FINALIZE from the TITLE MENU EDIT screen and press the SET button.**

- A confirmation window will appear.

**2. Select YES and then press the SET button.**

- The disc finalizing process will begin.
- The state of progress during finalizing is displayed using a progress bar.

■ When the disc has been finalized, the progress bar will disappear and the E-E screen will return.

### Notes

- A maximum of 20 minutes will be required to complete finalizing.
- When finalizing is carried out, all of the disc's recorded video and audio are stored in accordance with the DVD Video Standard; accordingly, this content can then also be replayed as DVD video.
- Although a disc finalized using this DVD recorder may in principle be played on other DVD players, there is no guarantee that all of its content will be playable.
- The action to be taken by this DVD recorder when a finalized disc is inserted or when playback of a title has ended is specified by DISC IN ACTION and TITLE END respectively from the RECORDER MENU (2/2) screen.
- Select EXIT from the TITLE MENU EDIT screen and then press the SET button to return to the E-E screen without finalizing the disc.

# Playback

## Playing Discs

This DVD recorder can also be used to playback discs that it has recorded and finalized.

When a disc is finalized, its title menu will be used to create the top menu.

The action taken by your BD-X200 when a disc it has finalized is inserted or when playback of a title has ended will depend on the settings of DISC IN ACTION and TITLE END as set on the RECORDER MENU (2/2) screen during recording.

\* Playback may not proceed smoothly with discs recorded using different devices, regardless of whether or not they have been finalized.

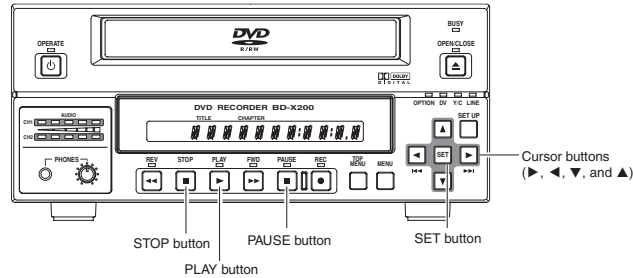

### 1. Insert a disc.

The action of the DVD recorder depends on the setting of DISC IN ACTION from the RECORDER MENU (2/2) screen. The following table describes the operations to be performed in either case.

DISC IN ACTION setting made during recording	
MENU	TITLE
The title menu will appear	Playback starts automatically from the first title.
<b>2. Select the number of the title to be played.</b> Use the ►, ◀, ▼, and ▲ buttons to select the title number for playback.	
<b>3. Press the SET button to begin playback.</b>	

### 4. Set to Still mode.

This is done by pressing the PAUSE button.

- The DVD recorder enters Still mode.
- If the PAUSE button is then pressed again in Still mode, the DVD recorder will advance playback by a single frame.

### 5. Restart playback.

Press the PLAY button.

### ■ The DVD recorder will behave as follows when title playback has ended.

These actions will depend on the setting made for TITLE END from the RECORDER MENU (2/2) screen during recording.

TITLE END SETTING made during recording	
MENU	REPEAT
The DVD recorder enters Stop mode and displays the title menu.	Repeat playback is carried out within the title.

### 6. Stop playback.

This is done by pressing the STOP button.

- The DVD recorder enters Stop mode.

# Playback

## Fast & Slow Playback

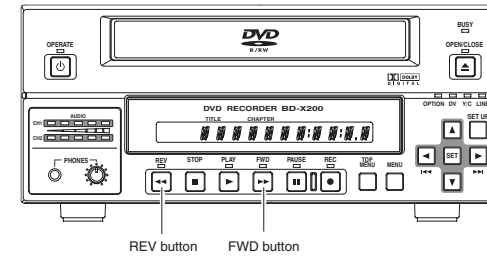

### Fast-Forward & Fast-Reverse Play

#### ■ Fast-forwarding

- Press the FWD button during playback or fast-reverse play to start fast-forward play.
- If pressed again during fast-forward play, this button toggles the speed of fast-forward play between  $\times 3$  and  $\times 15$ .

#### ■ Fast-reversing

- Press the REV button during playback or fast-forward play to start fast-reverse play.
- If pressed again during fast-reverse play, this button toggles the speed of fast-reverse play between  $\times 3$  and  $\times 15$ .

### Slow-Forward & Slow-Reverse Play

#### ■ Slow-forwarding

- Press the FWD button in Still mode or during slow-reverse play to start slow-forward play.
- If pressed again during slow-forward play, this button toggles the speed of slow-forward play between  $\times 0.5$  and  $\times 0.06$ .

#### ■ Slow-reversing

- Press the REV button in Still mode or during slow-forward play to start slow-reverse play.
- If pressed again during slow-reverse play, this button toggles the speed of slow-reverse play between  $\times 0.5$  and  $\times 0.06$ .

### Notes

- The DVD recorder can be returned to Playback mode during fast-forward, fast-reverse, slow-forward, or slow-reverse play by pressing the PLAY button. Still mode can be activated by pressing the PAUSE button. Stop mode is activated by pressing the STOP button.
- The displayed playback speed is not an exact value.

## Playing the Previous or Next Chapter

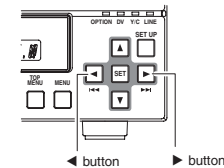

- Press the ► button while the DVD recorder is playing to move playback to the start of the next chapter.
- Press the ◀ button while the DVD recorder is playing to move playback to the start of the current chapter.
- If the ◀ button is pressed while the DVD recorder is playing the first chapter, playback will return to the beginning of that chapter.
- \* The ► button is deactivated during playback of the final chapter.



# Synchronous Recording

## Recording Playback Signals From a VCR with RS-422A

RS-422A control can be used to record playback signals from a VCR with an RS-422A terminal to a disc in your BD-X200. It will also be possible to control that VCR using this DVD recorder's REMOTE CONTROL screen.

### Signal Connections

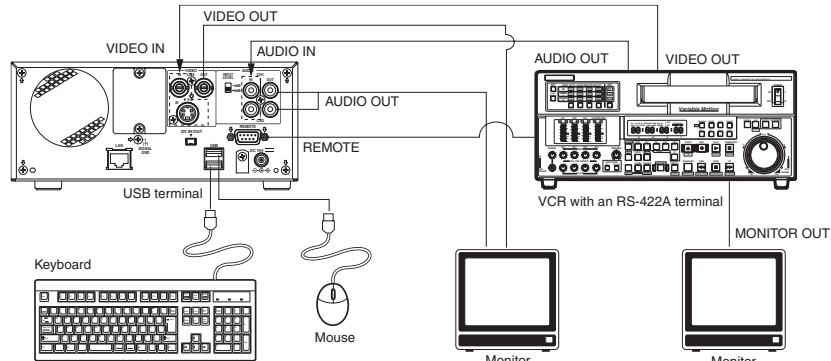

- Connect the RS-422A REMOTE terminal on the rear of the DVD recorder to the remote RS-422A terminal on the VCR using an RS-422A cable.
- Connect the DVD recorder's VIDEO LINE IN and AUDIO IN terminals to the VCR's video out and audio out terminals.
- Connect the DVD recorder's VIDEO LINE OUT and AUDIO OUT terminals to the monitor's video in and audio in terminals.
- A keyboard and mouse can be used as an alternative to the DVD recorder's buttons when using the REMOTE CONTROL screen. If used, these are to be connected to each of the USB terminals on the rear panel.

### Setup Procedures

- Insert the tape for playback into the VCR. Ensure that this tape contains an SMPTE time code.
- Insert a recordable disc into your BD-X200.

### Settings

**VCR** : Enable control via RS-422A.

**BD-X200** : Set REMOTE SELECT from the REMOTE MENU screen to 9PIN (MASTER).

#### REMOTE MENU screen

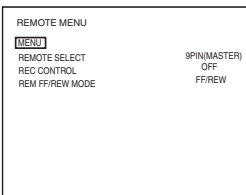

- When REMOTE SELECT is set to 9PIN (MASTER), the REMOTE CONTROL (9PIN MASTER) screen will appear. This screen is used to perform editing operations, and the corresponding operations are described on the following pages.

#### REMOTE CONTROL (9PIN MASTER) screen

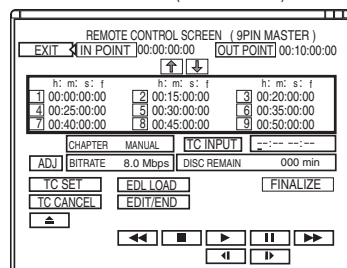

#### Note

When pressing and holding the REC button more than 2 seconds while the DVD recorder is stopped, encoded output images can be checked while the button is being held.

# Synchronous Recording

## Recording Playback Signals From a VCR with RS-422A (continued)

### Editing Via the REMOTE CONTROL (9PIN MASTER/DV MASTER) Screen

A keyboard and mouse can be used as an alternative to the DVD recorder's buttons when using the REMOTE CONTROL (9PIN MASTER/DV MASTER) screen.

**Front panel** : Select using the cursor buttons (▶, ◀, ▼, and ▲), and confirm the selection using the SET button.

**Keyboard** : Select using the arrow keys (→, ←, ↓, and ↑), and confirm the selection using the Enter key.

**Mouse** : Left click the required button.

\* When the REMOTE CONTROL screen is being displayed, the DVD recorder's, FWD, REV, PLAY, REC, PAUSE, MENU, and TOP MENU buttons will be disabled.

#### In Point (start point for editing):

Set the time code (hours : minutes : seconds : frames) of the position on the playback tape where recording is to be started.

#### Out Point (end point for editing):

Set the time code (hours : minutes : seconds : frames) of the position on the playback tape where recording is to be stopped.

#### Chapter list:

This displays the time codes of chapter marks.

- The In Point's time code is registered as the first chapter mark.
- A total of 98 chapters can be setup.

- When CHAPTER CREATION from the RECORDER MENU (2/2) screen is set to MANUAL, it will be possible to setup chapter marks at any position on the playback tape.

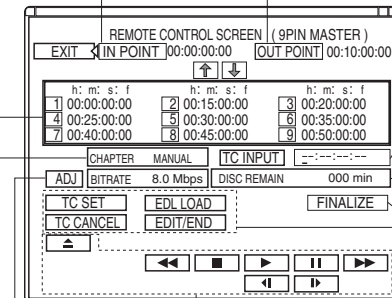

#### TC INPUT:

This field is used to input time codes for the In Point, Out Point, and chapter marks from the keyboard.

#### DISC REMAIN:

This field shows an estimate of the remaining space for recording on the disc.

#### FINALIZE:

This button is used to finalize the disc.

#### ADJUST:

This button can be pressed to determine the remaining disc time based on the editing time and to also set a suitable bit rate. This setting is then displayed in the BIT RATE field.

#### TC SET

: This button is used to set input time codes for the In Point, Out Point, and chapter marks.

**TC CANCEL** : This button is used to remove setting values for the In Point, Out Point, and chapter marks.

**EDL LOAD** : This button is used to load the most-recent edit list. It can be used whenever CREATION CHAPTER has been set to MANUAL.

**EDIT/END** : This button is used to start editing automatically. When recording has ended, the DVD recorder automatically adopts Recording STOP mode. If selected while editing, this button will end that process.

#### CHAPTER:

The right-hand field indicates the current setting for CHAPTER CREATION from the RECORDER MENU (2/2) screen.

- When set to MANUAL, chapter marks can be registered in this screen's chapter list.

- When set to AUTO, the DVD recorder's chapter auto-create function will set chapters. In such a case, it will not be possible to register chapters using this screen's chapter list.

- Chapter marks are inserted at GOP intervals (i.e., 15 frames). It will not be possible to insert chapter marks that are closer together than this interval.

#### VCR Control Panel

The buttons provided in this panel are used to control VCR operations. When a button is selected and confirmed, the VCR will carry out the corresponding operation. It is important to remember that these buttons do not control operation of this DVD recorder.

- ▲ : Eject
- ◀◀ : Fast reverse or fast-reverse play
- ◀ : Frame-Reverse play
- : Stop
- || : Pause
- ▶ : Play
- ▶▶ : Frame-advance play
- ▶▶▶ : Fast forward or fast-forward play

\* The action to be taken by the DVD recorder in response to pressing of the ▶▶▶ or ◀◀◀ button (i.e., FF/REW or SEARCH) is selected using REM FF/REW MODE from the REMOTE MENU screen.

## 1. Registering the In Point, Out Point, and Chapter Marks

The following two methods can be used to register the In Point, Out Point, and chapter marks.

- Recording of time codes corresponding to tape positions.
- Direct entry using a keyboard.

Registering chapter marks : In order to register chapter marks using the REMOTE CONTROL screen, it will first of all be necessary to set CHAPTER CREATION from the RECORDER MENU (2/2) screen to MANUAL. If this parameter is set to AUTO, chapter marks will be automatically setup at specific intervals. The current setting for CHAPTER CREATION is indicated in this screen's CHAPTER field.

### Recording from tape positions

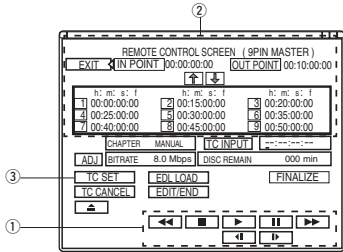

- 1 Use the VCR Control Panel to start playback on the VCR. Press the STILL (II) button and pause VCR playback at the position to be registered. If necessary, use frame advance and the like to set the exact position.
- 2 Use the cursor buttons (▶, ◀, ▼, and ▲) to select the point to be registered (i.e., the In Point or Out Point), and then press the SET button.
  - \* The selected point will be highlighted.
- 3 Use the cursor buttons (▶, ◀, ▼, and ▲) to select TC SET and press the SET button.
  - The time code will be registered for the selected point.
  - If both IN point and OUT point are not selected, the time code will be registered as a chapter point.
  - When a time code is registered for a chapter mark, the chapter list will be sorted from the smallest time-code values, and the newly registered point will be highlighted.
  - \* Editing can only be performed when there is continuous time code up to 5 seconds from IN POINT.

### Direct keyboard entry

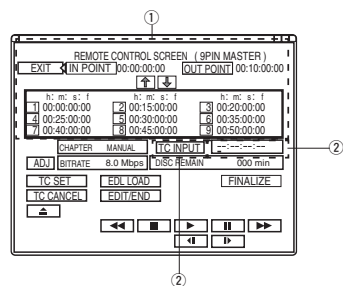

- 1 Use the arrow keys (→, ←, ↑, and ↓) to select the point to be registered (i.e., the In Point or Out Point), and then press the Enter key.
- 2 Select the TC INPUT button using the cursor keys and input a time code (hours: minutes: seconds: frames) into the TC input field using the keyboard.
- 3 Press the Enter key.
  - The time code will be registered for the selected point.
  - If both IN point and OUT point are not selected, the time code will be registered as a chapter point
  - When a time code is registered for a chapter mark, the chapter list will be sorted from the smallest time-code values, and the newly registered point will be highlighted.

#### Note

The framing mode will be matched to that used for time codes on the connected device. When in the drop frame mode, a value corrected automatically will be registered when inputting the frame to drop. (U-model only)

## Saving & Loading Time-Code Settings

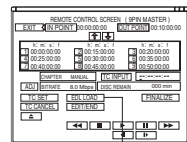

EDL LOAD

Once settings have been made, they can be saved in your BD-X200's internal memory. Even if a different screen is opened or the power is turned off, stored data can then be loaded by selecting EDL LOAD from the REMOTE CONTROL screen and pressing the Set button.

- If CHAPTER CREATION from the RECORDER MENU (2/2) screen is set to AUTO, it will not be possible to select EDL LOAD on the REMOTE CONTROL screen.
- Whenever an external edit list (EDL) is read or time-code registration is started without performing EDL LOAD, the settings will be updated accordingly. As a result, even if EDL LOAD is selected in such a case, the previous data will not be reloaded.

Refer to page 68 for more details regarding the loading of external EDL.

61

## Synchronous Recording

### Recording Playback Signals From a VCR with RS-422A (continued)

## 2. Deleting the In Point, Out Point, and Chapter Marks

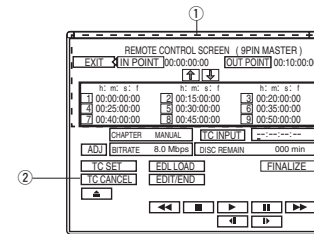

- 1 Use the cursor buttons (▶, ◀, ▼, and ▲) to select the point to be deleted (i.e., In Point, Out Point, or a chapter mark from the chapter list), and then press the SET button.
- 2 Use the cursor buttons (▶, ◀, ▼, and ▲) to select TC CANCEL and press the SET button.
  - The selected point (i.e., the In Point, Out Point, or a chapter mark from the chapter list) will be deleted.
  - Whenever a chapter mark is deleted, the chapter list will be resorted.

## 3. Starting the Record Process

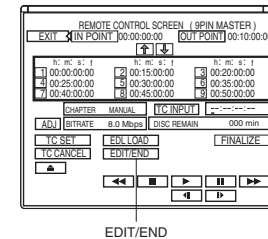

- 1 Select EDIT/END from the REMOTE CONTROL screen and press the SET button.
  - VCR will begin playback by returning to the position 5 seconds before the IN POINT.
  - The unit will start record when the VCR reaches the IN POINT. Recording of video and audio from the VCR to the DVD will be carried out from the In Point to the Out Point with chapters being created as specified.
- 2 When playback reaches the Out Point, title recording will end automatically.
  - The VCR will automatically adopt STOP mode at this time.
  - The DVD recorder will return to STOP mode and will end title recording.
  - If another title is to be recorded, repeat operations from the registration of the In Point and Out Point.

#### Notes

- Editing accuracy is ±5 frames.
- If no In Point has been registered, recording will begin at the current tape position. However, the tape must be positioned before the Out Point and all chapter marks for this to be possible.
- If no Out Point has been registered, a manual stop must be carried out to end recording. Select EDIT/END to end the editing process.
- When the chapter auto-create function is used, chapters will be created at specific intervals.

## Setting the Optimum Bit Rate

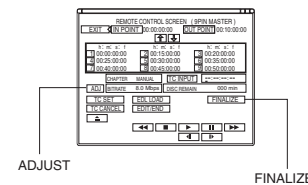

ADJUST

FINALIZE

ADJUST can be used to set the optimum bit rate (i.e., the amount of data per second) for the remaining space on a disc based on the recording time (or duration) between the In Point and the Out Point.

- DISC REMAIN displays an estimate of the available space for recording on the current disc.
- BIT RATE displays the current bit-rate setting. To set the bit rate that best suits the remaining disc capacity, select ADJUST and then press the SET button.

## 4. Ending the Record Process

- If you intend to play the recorded disc on this DVD recorder or on another player, select FINALIZE and press the SET button. Once finalizing has been carried out, no addition recordings can be made on the disc.
- To remove the recorded disc from your BD-X200, press the OPEN/CLOSE button on the front panel.

62

## Recording Playback Signals From a DV Camera or VCR

DV (IEEE1394) control can be used to record playback signals from a camera or VCR with a DV terminal to a disc in your BD-X200. It will then be possible to control that VCR using this DVD recorder's REMOTE CONTROL screen.

### Signal Connections

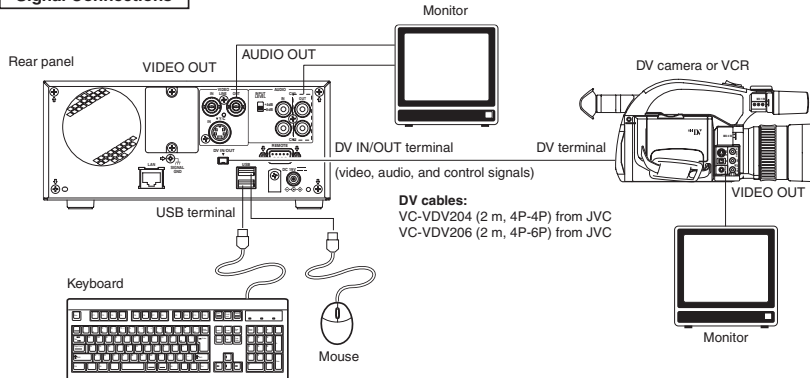

- Connect the DV IN/OUT terminal on the rear of your BD-X200 to the DV terminal on the DV camera or VCR using a DV (IEEE1394) cable. One of the commercially-available cables indicated above should be used for this purpose.
- Connect the DVD recorder's VIDEO LINE OUT and AUDIO OUT terminals to the monitor's video in and audio in terminals.
- A keyboard and mouse can be used as an alternative to the DVD recorder's buttons when using the REMOTE CONTROL screen. If used, these are to be connected to each of the USB terminals on the rear panel.

### Setup Procedures

- Insert the tape for playback into the camera or VCR. Ensure that this tape contains an SMPTE time code.
- Insert a recordable disc into your BD-X200.

### Settings

**DV camera or VCR** : Enable control via DV.  
**BD-X200** : Set REMOTE SELECT from the REMOTE MENU screen to DV (MASTER).

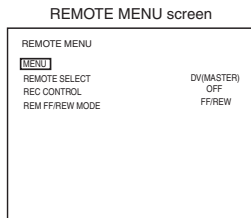

**Note**  
 When pressing and holding the REC button more than 2 seconds while the DVD recorder is stopped, encoded output images can be checked while the button is being held.

- When REMOTE SELECT is set to DV (MASTER), the REMOTE CONTROL (DV MASTER) screen will appear. This screen is used to perform editing operations, and the corresponding operations are described on pages 60 through 62.

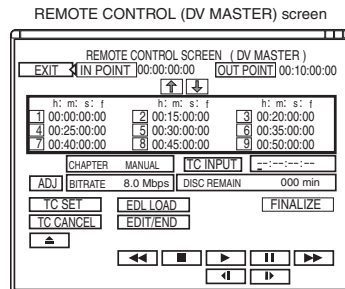

## Synchronous Recording

### Recording Video & Audio From a Non-Linear Editor

By connecting a non-linear editor featuring a DV terminal to this DVD recorder, audio and video processed using the editor can be easily recorded to a disc. In this case, the BD-X200 will be controlled by commands from the non-linear editor, and these commands will be communicated via the DV terminal.

### Signal Connections

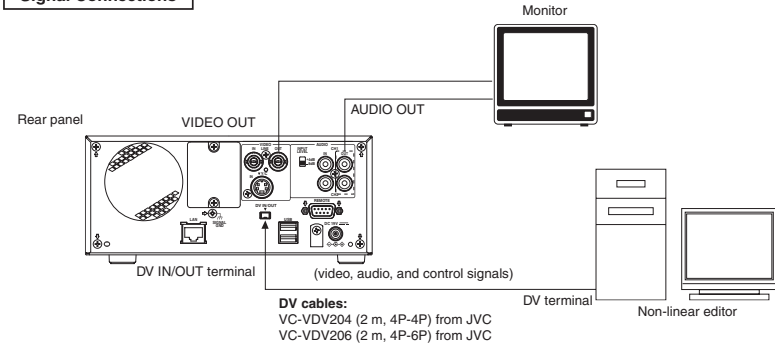

- Connect the DV IN/OUT terminal on the rear of your BD-X200 to the DV terminal on the non-linear editor using a DV (IEEE1394) cable. One of the commercially-available cables indicated above should be used for this purpose.
- Connect the DVD recorder's VIDEO LINE OUT and AUDIO OUT terminals to the monitor's video in and audio in terminals.

### Setup Procedures

- Insert a recordable disc into your BD-X200.

### Settings

**BD-X200** : Set REMOTE SELECT from the REMOTE MENU screen to DV (SLAVE).

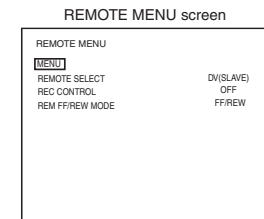

- When REMOTE SELECT is set to DV (SLAVE), the REMOTE CONTROL (DV SLAVE) screen will appear. This screen can be used to set editing points and chapter marks. Refer to page 65 for details regarding usage of the REMOTE CONTROL (DV SLAVE) screen.

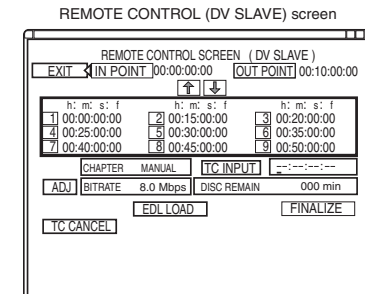

**Note**  
 When pressing and holding the REC button more than 2 seconds while the DVD recorder is stopped, encoded output images can be checked while the button is being held.

## Editing Via the REMOTE CONTROL (DV SLAVE) Screen

A keyboard and mouse can be used as an alternative to the DVD recorder's buttons when using the REMOTE CONTROL (DV SLAVE) screen.

Front panel : Select using the cursor buttons (▶, ◀, ▼, and ▲), and confirm the selection using the SET button.

Keyboard : Select using the arrow keys (←, →, ↓, and ↑), and confirm the selection using the Enter key.

Mouse : Left click the required button.

\* Setting of the In Point, Out Point, and chapter points can only be carried out by keyboard input.

**In Point (start point for editing):**  
Set the time code (hours : minutes : seconds : frames) at which recording is to be started.

**OUT POINT (end point for editing):**  
Set the time code (hours: minutes: seconds: frames) of the position to stop recording.

**Chapter list:**  
This displays the time codes of chapter marks. These time codes are displayed as relative values with respect to the In Point.

- The In Point's time code is registered as the first chapter point.
- A total of 98 chapters can be set up.
- CHAPTER CREATION from the RECORDER [2/2] MENU screen must be set to MANUAL for this to be possible.

**TC INPUT:**  
This field is used to input time codes for the In Point, Out Point, and chapter marks from the keyboard.

**DISC REMAIN:**  
This field shows an estimate of the remaining space for recording on the disc.

**FINALIZE:**  
This button is used to finalize the disc.

**ADJUST:**  
This button can be pressed to determine the remaining disc time based on the editing time and also to set a suitable bit rate. This setting is then displayed in the BIT RATE field.

**TC CANCEL :** This button is used to remove setting values for the In Point, Out Point, and chapter marks.

**EDL LOAD :** This button is used to load the most-recent edit list. It can be used whenever CREATION CHAPTER has been set to MANUAL.

**CHAPTER:**  
The right-hand field indicates the current setting for CHAPTER CREATION from the RECORDER MENU (2/2) screen.

- When set to MANUAL, chapter marks can be registered in this screen's chapter list.
- When set to AUTO, the DVD recorder's chapter auto-create function will set chapters. In such a case, it will not be possible to register chapters using this screen's chapter list.
- Chapter marks are inserted at GOP intervals (i.e., 15 frames). It will not be possible to insert chapter marks that are closer together than this interval.

## Synchronous Recording

### Recording Video & Audio From a Non-Linear Editor (continued)

#### 1. Registering the In Point, Out Point, and Chapter Marks

Use the keyboard to directly enter the In Point, Out Point, and chapter marks.

Registering chapter marks : In order to register chapter marks using the REMOTE CONTROL screen, it will first of all be necessary to set CHAPTER CREATION from the RECORDER MENU (2/2) screen to MANUAL. If this parameter is set to AUTO, chapter marks will be automatically setup at specific intervals. The current setting for CHAPTER CREATION is indicated in this screen's CHAPTER field.

#### Procedure

- Use the arrow keys (←, →, ↑, and ↓) to select the point to be registered (i.e., the In Point or Out Point), and then press the Enter key.
- Select the TC INPUT button using the cursor keys and input a time code (hours: minutes: seconds: frames) into the TC input field using the keyboard.
- Press the Enter key.
  - The time code will be registered for the selected point.
  - If both IN point and OUT point are not selected, the time code will be registered as a chapter point
  - When a time code is registered for a chapter mark, the chapter list will be sorted from the smallest time-code values, and the newly registered point will be highlighted.

#### Note

The framing mode will be matched to that used for time codes on the connected device. When in the drop frame mode, a value corrected automatically will be registered when inputting the frame to drop. (U-model only)

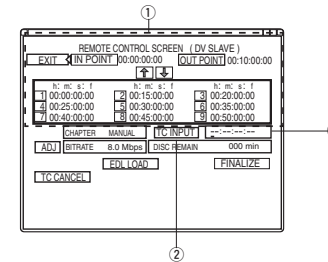

#### Saving & Loading Time-Code Settings

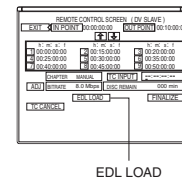

Once settings have been made, they can be saved on your BD-X200. Even if a different screen is opened or the power is turned off, stored data can then be loaded by selecting EDL LOAD from the REMOTE CONTROL screen and pressing the Set button.

- If CHAPTER CREATION from the RECORDER MENU (2/2) screen is set to AUTO, it will not be possible to select EDL LOAD on the REMOTE CONTROL screen.
- Whenever an external edit list (EDL) is read or time-code registration is started without performing EDL LOAD, the settings will be updated accordingly. As a result, even if EDL LOAD is selected in such a case, the previous data will not be reloaded. Refer to page 68 for more details regarding the loading of external EDL.

#### 2. Deleting the In Point, Out Point, and Chapter Marks

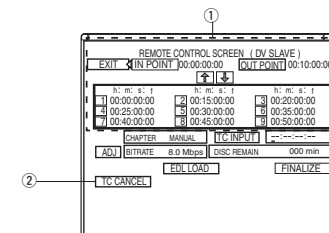

- Use the cursor buttons (▶, ◀, ▼, and ▲) to select the point to be deleted (i.e., the In Point, Out Point, or a chapter mark from the chapter list), and then press the SET button.
- Use the cursor buttons (▶, ◀, ▼, and ▲) to select TC CANCEL and press the SET button.
  - The selected point (i.e., In Point, Out Point, or a chapter mark from the chapter list) will be deleted.
  - Whenever a chapter mark is deleted, the chapter list will be sorted.

### 3. Starting the Record Process

- Use the non-linear editor to control the DVD recorder.
  - Each recording will be stored on the disc as a single title.
  - Recording of video and audio to the DVD will be carried out from the In Point to the Out Point with chapters being automatically created as specified.

#### Notes

- If no In Point has been set, recording will start in response to DV commands; however, since time codes are set for chapter marks as relative values with respect to the In Point, chapters may not be created as intended. It is recommended, therefore, that an In Point always be specified when chapters are to be created.
- When the chapter auto-create function is used, chapters will be created at specific intervals.

#### Setting the Optimum Bit Rate

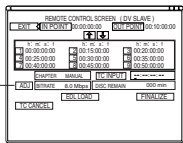

ADJUST

ADJUST can be used to set the optimum bit rate (i.e., the amount of data per second) for the remaining space on a disc based on the recording time (or duration) between the In Point and the Out Point.

- DISC REMAIN displays an estimate of the available space for recording on the current disc.
- BIT RATE displays the current bit-rate setting. To set the bit rate that best suits the remaining disc capacity, select ADJUST and then press the SET button.

### 4. Ending the Record Process

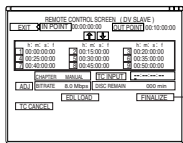

FINALIZE

- If you intend to play the recorded disc on this DVD recorder or on another player, select FINALIZE and press the SET button. Once finalizing has been carried out, no additional recordings can be made on the disc.
- To remove the recorded disc from your BD-X200, press the OPEN/CLOSE button on the front panel.

## Synchronous Recording

### In, Out & Chapter Points from External Edit Lists

When dubbing a tape edited using an external VCR or non-linear editor to a DVD, the edit list (or EDL) created during the editing process can be used to automatically set the In Point, Out Point, and chapter marks.

#### Notes

- Loading of external edit lists is possible when CHAPTER CREATION from the RECORDER [2/2] MENU screen is set to MANUAL.
- The framing mode for time codes (i.e. drop or non-drop) will be matched to that of the edit list. (**U-model only**)
- In order to be read, the EDL must be of CSV or Sony9100 format.
- The priority sequence for loading is CSV → Sony9100 → internally-made EDL.
- Chapter marks are inserted at GOP intervals (i.e., 15 frames). It will not be possible to insert chapter marks that are closer together than this interval.

#### Procedure

- Transfer the external edit list to your BD-X200.
- Select EDL LOAD from the REMOTE CONTROL screen and press the SET button.
  - The In Point, Out Point, and chapter marks are set in accordance with the EDL.

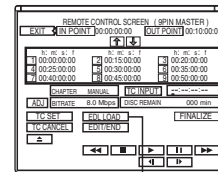

EDL LOAD

#### Example 1: Loading a CSV-format EDL

```
JVC CSV          00:00:00:00
IN POINT         01:00:00:00
OUT POINT        01:10:00:00
Chapter1         00:10:00:00
Chapter2         00:20:00:00
Chapter3         00:30:00:00
Chapter4         00:40:00:00
Chapter5         00:50:00:00
```

- Line returns at the end of each line.
- Maximum of 98 chapter marks.
- Framing mode determined by the character in front of the frame field. (**U-model only**)
  - Period (.) : Drop frames
  - Colon (:): Non-drop frames

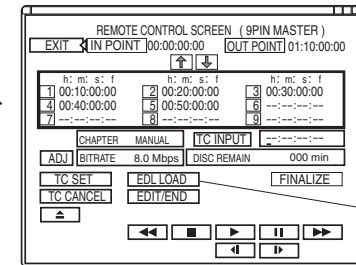

EDL LOAD

#### Example 2: Loading a Sony9100-format EDL

Recorder-In and Recorder-Out time codes are read from the X-source and Y-source rows, and these are then set as the In Point, Out Point, and chapter marks for editing.

```
EDIT  RECORDER-IN  RECORDER-OUT
0001  '00:00:00:00  '00:10:00:00
0002  '00:10:00:00  '00:20:00:00
0003  '00:20:00:00  '00:30:00:00
0004  '00:30:00:00  '00:40:00:00
0005  '00:40:00:00  '00:50:00:00
0006  '00:50:00:00  '01:00:00:00
0007  '00:50:05:00  '01:00:00:00
```

Already set

Set as the Out Point

Set as a chapter mark

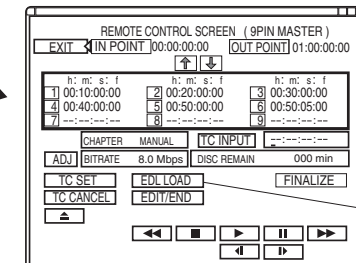

EDL LOAD

## Recording Operations Using a DV Camera Trigger

By connecting a camera featuring a DV terminal to this DVD recorder, audio and video from the camera can be easily recorded to a disc. In this type of situation, the DV camera's trigger button is used to control the BD-X200. Supported cameras: GY-DV5000 and GY-DV5001.

### Signal Connections

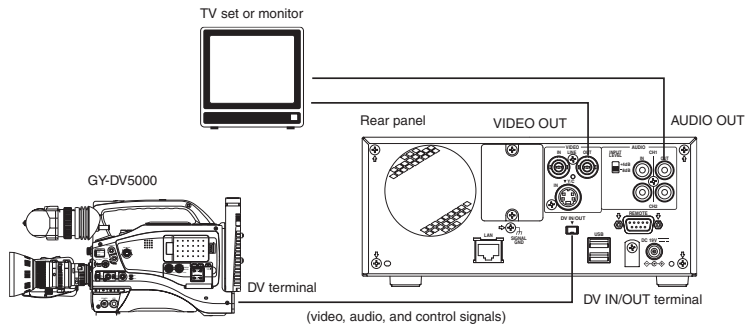

**DV cables:**  
 VC-VDV204 (2 m, 4P-4P) from JVC  
 VC-VDV206 (2 m, 4P-6P) from JVC

- Connect the DV IN/OUT terminal on the rear of your BD-X200 to the DV terminal on the GY-DV5000 using a DV (IEEE1394) cable. One of the commercially-available cables indicated above should be used for this purpose.
- Connect the DVD recorder's VIDEO LINE OUT and AUDIO OUT terminals to the monitor's video in and audio in terminals.

### Setup Procedures

- Insert a recordable disc into your BD-X200.

### Settings

**GY-DV5000** : Set DV REC TRIGGER from the OTHERS MENU (1/2) screen to ON.  
**BD-X200** : Set REMOTE SELECT from the REMOTE MENU screen to DV(TRIGGER).  
 Input will automatically be DV.

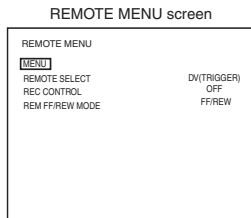

- The BD-X200 will adopt Slave mode. (It will not be possible to control recording operations from the DVD recorder.)

**Note**  
 Not compatible with the REPLICATION feature of BR-DV6000.

### Procedure

- Recording on the BD-X200 will start and stop in response to operation of the trigger button on the GY-DV5000 or GY-DV5001.  
 \* When using, make sure triggers are at least 1 second apart.

## DVD Dubbing

### Dubbing DVDs Using the LAN Terminal

When the LAN terminal is used to join two BD-X200 DVD recorders via an Ethernet connection, audio and video from a sender DVD can be dubbed onto a DVD on the receiver device.

**Connected devices** : One BD-X200 SENDER (used for playback of the master DVD)  
 One BD-X200 RECEIVER (used for DVD recording)

### Signal Connections

All connection and disconnection of cables should be carried out with the power turned off.

#### ■ Direct connection of two BD-X200s

Connect an Ethernet cable between the LAN terminals of the sender and receiver devices.  
 A Category 5, cross-wired Ethernet cable should be used in this case.

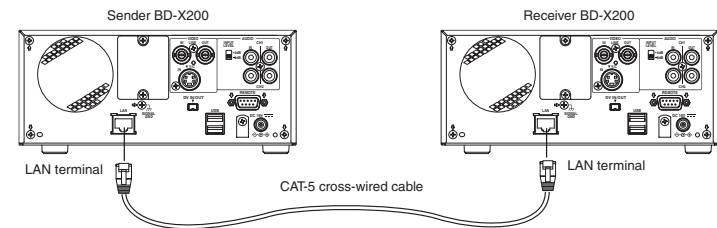



## Network Settings

Use the following procedure to carry out network settings on both the sender and receiver devices.

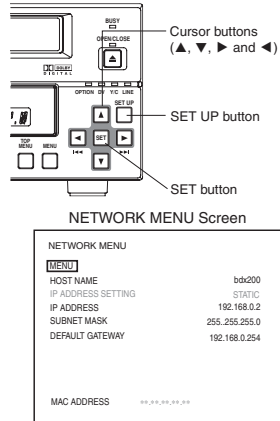

- Press the SET UP button to display the Setup Menu.
- Select NETWORK from the Setup Menu and then press the SET button.
  - The NETWORK MENU screen will appear.
- Use the following parameters from the NETWORK MENU screen to make settings required for dubbing.
  - HOST NAME**  
Use the ▲ and ▼ cursor buttons or the ↑ and ↓ arrow keys to select this parameter, and then input the BD-X200's network name using the USB keyboard. (Names may be up to 20 characters in length.)
  - IP ADDRESS, SUBNET MASK, and DEFAULT GATEWAY**  
Refer to the following table for more details regarding these parameters.
    - Select the required parameter using the ▲ and ▼ cursor buttons or the ↑ and ↓ arrow keys.
    - Select the digit to be set using the ► and ◀ cursor buttons or the → and ← arrow keys.
    - Change the selected digit using the ▲ and ▼ cursor buttons or the ↑ and ↓ arrow keys.
    - Repeat steps ② through ③ to make all of the required settings, and then press the SET button or Enter key.
- To return to the Setup Menu after all settings have been made, select MENU from the NETWORK screen, and then press the SET button or the ENTER key.
- Press the SET UP button to return to the normal screen display.

### Setting example:

This value is different for each device.

IP ADDRESS 192.168.100.xxx  
SUBNET MASK 255.255.255.000

All devices are set to the same network.

Parameter	Description	Default setting
HOST NAME	The parameter is used to enter the BD-X200's network name using a keyboard. (Names may be up to 20 characters in length.)	bdx200
IP ADDRESS SETTING	This parameter cannot be set and is fixed in STATIC mode.	———
IP ADDRESS	Use this parameter to set the IP address. Make sure, however, that no two devices on a single network share the same IP address.	192.168.0.002
SUBNET MASK	Use this parameter to set the subnet mask. Connected BD-X200s should have the same network setting.	255.255.255.000
DEAULT GATEWAY	Use this parameter to set the gateway address. Connected BD-X200s should have the same address.	192.168.0.254

## DVD Dubbing

### Dubbing DVDs Using the LAN Terminal (continued)

#### Dubbing

##### Setup Procedures

Sender device : Insert a finalized disc.  
Receiver device : Insert a blank DVD.

##### Procedure

Use the DUBBING screen to carry out the dubbing of DVDs.

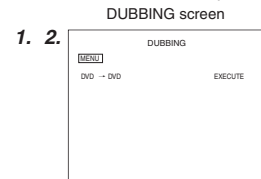

#### 1. 2. DVD → DVD dubbing screen

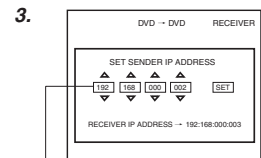
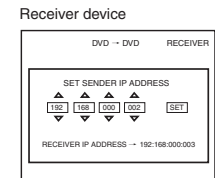
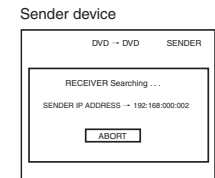

IP address for the sender device

#### 1. Sender and receiver devices

Open the DUBBING screen on both the sender and receiver devices.

- Press the SET UP button to display the Main Setup menu.
- Use the ▲ and ▼ buttons to select DUBBING and then press the SET button.
  - The DUBBING screen will appear.

#### 2. Sender and receiver devices

On both the sender and receiver devices, set DVD → DVD from the DUBBING screen to EXECUTE and press the SET button.

Sender device:

- Search for the receiver device. (☞ Page 73)

Receiver device:

- A confirmation box for the sender device's IP address is displayed.

To end dubbing:

Sender device : Select ABORT and press the SET button. The normal screen display will return.

Receiver device : Press the SET UP button to return to the normal screen display.

#### 3. Receiver device

Set the IP address for the sender device as follows.

- Use the on-screen confirmation box to set the required IP address.
  - The IP address of the currently-registered sender device will be displayed. Press the SET button to use this IP address.
- If setting a new sender-device IP address, set the IP address of the sender device.
  - Use the ► and ◀ cursor buttons to select the digit to be changed.
  - Press the cursor (▲/▼) buttons to set the value of the selected digit.
  - Repeat the above for all digits, select SET using the ◀/► buttons and press the SET button.
  - The sender-device IP address set using this dialog box will be registered as the most up-to-date address on the receiver device.

- When all of the necessary settings have been made, the status of the sender device will be displayed on the receiver device's monitor.
- This screen will not appear when setting the sender device first.



4. Sender device

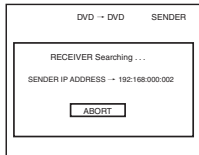

5. Confirmation box for the start of dubbing

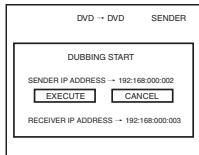

During Dubbing

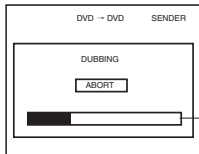

State of progress

Receiver device

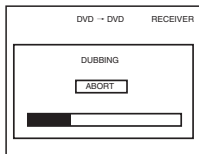

6. DUBBING MENU screen

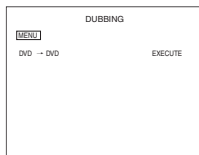

4. Sender device

The sender device will begin searching for receiver devices.

- When connection has been completed, a dialog box for confirming the start of dubbing will appear.
- The IP address of the identified receiver device will be displayed in the dialog box for confirming the start of dubbing.

5. Sender device

To proceed with dubbing, select EXECUTE in the confirmation box for the start of dubbing and press the SET button.

- DVD to DVD dubbing will begin.
- As dubbing is carried out, the state of progress will be displayed on the monitor connected to each device in the form of a progress bar.

Notes

- Dubbing will not be carried out if CANCEL is selected from the confirmation box for the start of dubbing.
- When dubbing a complete disc, approximately 90 minutes will be required to complete the process.
- Do not disconnect any cables during the dubbing process. If cable are accidentally disconnected, both devices should be turned off once and then restarted before subsequent use.

6. Dubbing proceeds to completion.

When dubbing has ended, the display for the sender device returns to the DUBBING screen.

Finalizing is performed automatically by the receiver device.

To cancel dubbing:

If ABORT from the DUBBING screen is selected and confirmed, the following confirmation box will be displayed.

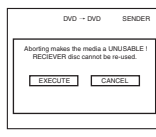

- Select EXECUTE and then press the SET button to cancel the dubbing process and return to the DUBBING menu.
- Select CANCEL and press the SET button to close the confirmation window without canceling the dubbing process.
- If dubbing is canceled, the partially-recorded DVD will no longer be usable.

# Setup Menu

## Setup Menu Configuration

The Setup Menu screen is displayed on both the monitor and LCD display. As shown below, this screen is used to access the BD-X200's setup menus.

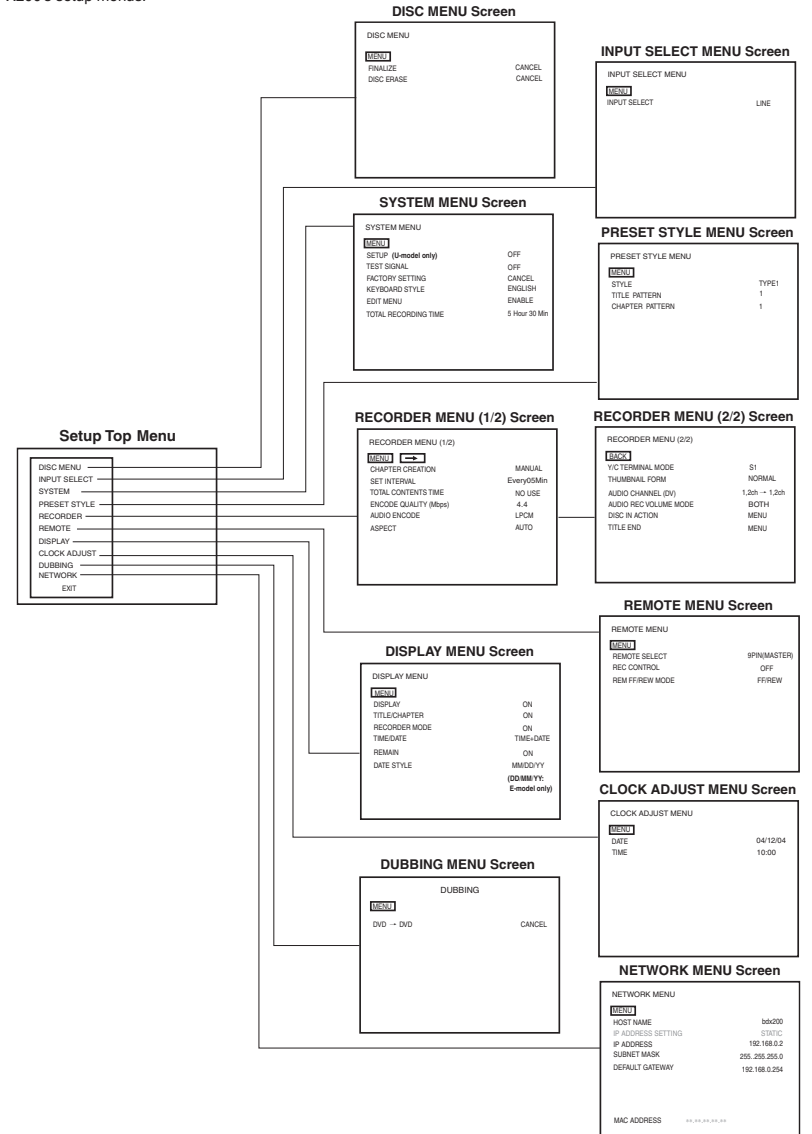

## Setting the Setup Menu

Settings made in the setup menus are stored in the BD-X200's internal memory and will be retained even when the power is turned off. It is also possible to return to default settings whenever so required.

In addition to the buttons on the front panel, a keyboard and mouse can also be used to perform operations on these menus. The following section, however, will describe operations performed using the front panel buttons.

Keyboard : Select using the arrow keys (↑ and ↓), and confirm the selection using the Enter key.

Mouse : Left click the required item.

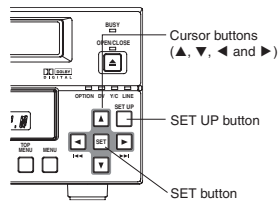

Setup Menu

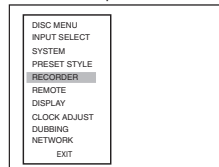

RECORDER MENU (1/2) screen

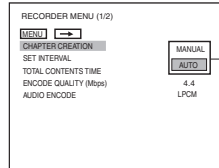
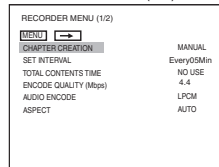

Setting list

### Settings

Setup menu operations are carried out while monitoring the display on the monitor connected to the VIDEO LINE OUT terminal. In addition, setup menu content also appears on the LCD display.

■ Stop the DVD recorder.

#### 1. Open the Setup Menu screen.

To do this, press the SET UP button

#### 2. Open the setup menu in which settings are to be modified.

① Use the ▲ and ▼ buttons to select the required screen.

② Press the SET button

\* The EXIT option can be selected to return to the normal screen display.

#### 3. Make the required settings in the setup menu.

① Use the ▲ and ▼ buttons to select the parameter to be set.

② Press the SET button

● A list of setting values will appear.

③ Use the ▲ and ▼ buttons to select the required value from the list and then press the SET button.

● The setting value will be modified accordingly.

④ Repeat steps ① through ③ until all of the required settings have been made.

■ To return to the Setup Menu, select MENU and press the SET button.

■ To move to the next menu screen, select the → button at the top of the current screen and press the SET button.

■ To return to the original menu screen, select either MENU or BACK and press the SET button.

#### 4. Use either of the following methods to return to the normal screen display.

Press the SET UP button.

or

Select EXIT from the Setup Menu and press the SET button.

## Restoring to Default Settings

SYSTEM MENU screen

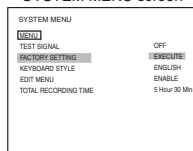

All settings from the various setup menus can be returned to the corresponding default settings by setting FACTORY SETTING from the SYSTEM MENU screen to EXECUTE and by then pressing the SET button.

## Setup Menu

### Setup Menus

The following table identifies and describes the parameters that may be set using the Setup Menus.

Top half : Appearance on monitor screen

Bottom half : Appearance on LCD display

Option	Description
DISC MENU ----- DISC MENU	This button opens a menu that allows settings to be made for finalizing and other similar disc processes.
INPUT SELECT ----- INPUT SEL	This button opens a menu that allows input audio and video signals to be selected.
SYSTEM ----- SYSTEM	This button opens a menu that allows settings to be made for the DVD recorder itself.
PRESET STYLE ----- PRESET	This button opens a menu that allows settings to be made for title-menu and chapter-menu display styles.
RECORDER ----- RECORDER	This buttons opens a RECORDER MENU screen containing two different pages of parameters. The RECORDER MENU (1/2) screen allows settings to be made for the chapter creation method and the encoding of audio and video. The RECORDER MENU (2/2) screen allows the settings required for recording to be made.
REMOTE ----- REMOTE	This button opens a menu that allows settings to be made for remote operations via the DVD recorder's RS-422A or DV terminal. In addition, this menu also allows indication of whether or not the REC CONTROL panel is to be displayed.
DISPLAY ----- DISPLAY	This button opens a menu that allows settings to be made for the display of status and alarm information on the TV or monitor screen.
CLOCK ADJUST ----- CLOCK	This button opens a menu that allows setting of the internal clock's date and time.
DUBBING ----- DUB	This button opens a menu that allows settings to be made for DVD dubbing.
NETWORK ----- NETWORK	This button opens a menu that allows network settings to be made for LAN terminal usage.
EXIT	This button is selected to return to the normal screen display.

## DISC MENU Screen

The following table identifies and describes the parameters that may be set using the DISC MENU screen.

Top half : Appearance on monitor screen  
 Bottom half : Appearance on LCD display  
 [ ] : Default setting

Parameter	Possible settings	Description
<b>FINALIZE</b>	[CANCEL] EXECUTE	This parameter indicates whether or not the recorded disc is to be finalized. If a disc recorded using this DVD recorder is to be played on a DVD player, it must first be finalized. Once finalizing has been carried out, no addition recordings can be made on the disc.
<b>FINAL</b>	[CAN] EXE	<b>CANCEL</b> : Finalizing is not to be carried out. <b>EXECUTE</b> : Finalizing is to be carried out. It will be necessary to close all titles on a disc before it can be finalized. * A maximum of 20 minutes will be required to complete finalizing.
<b>DISC ERASE</b>	[CANCEL] EXECUTE	This parameter indicates whether or not a DVD-RW (video mode) is to be erased.
<b>ERASE</b>	[CAN] EXE	<b>CANCEL</b> : This disc is not to be erased. <b>EXECUTE</b> : This disc is to be erased. In this process, all recorded data is erased from the disc, and it can then be recorded to as a new disc.
<b>MENU</b>		This button is used to return to the Setup Menu screen.

## INPUT SELECT MENU screen

The following table identifies and describes the parameters that may be set using the INPUT SELECT MENU screen.

Top half : Appearance on monitor screen  
 Bottom half : Appearance on LCD display  
 [ ] : Default setting

Parameter	Possible settings	Description
<b>INPUT SELECT</b>	[LINE] Y/C DV	This parameter is used to select the audio and video input signals. <b>LINE</b> : The composite video signal from the VIDEO LINE IN terminal and the analog audio signals from the AUDIO IN terminals are to be used. <b>Y/C</b> : The YC separate signal from the Y/C IN terminal and the analog audio signals from the AUDIO IN terminals are to be used. <b>DV</b> : The digital video and audio signals from the DV IN/OUT terminal are to be used.
<b>INPUT</b>	[LINE] YC DV	* The front-panel indicator corresponding to the type of input signal selected on this screen will light up or start to flash. Setting of this parameter will not be possible when REMOTE SELECT from the REMOTE MENU screen has been set to DV(MASTER), DV(SLAVE), or DV(TRIGGER). DV signals will be used for input at these times
<b>MENU</b>		This button is used to return to the Setup Menu screen.

## Setup Menu

### SYSTEM MENU Screen

The following table identifies and describes the parameters that may be set using the SYSTEM MENU screen.

Top half : Appearance on monitor screen  
 Bottom half : Appearance on LCD display  
 [ ] : Default setting

Parameter	Possible settings	Description
<b>SET UP</b> (U-model only)	[OFF] ON	This parameter is used to indicate whether or not a setup signal is to be added to analog video (i.e., composite or YC separate) during the recording process. The actual setting depends on whether the input analog signal contains a setup signal. <b>OFF</b> : This setting should be made when the input analog signal does not contain a setup signal. <b>ON</b> : This setting should be made when the input analog signal contains a setup signal.
<b>SETUP</b> (U-model only)	[OFF] ON	This parameter is used to indicate whether or not the color bar output by the DVD recorder's internal signal generator is to be displayed. <b>OFF</b> : The color bar is not displayed and video from the VIDEO LINE IN terminal is output to the monitor. <b>ON</b> : The color bar is displayed. Use this setting when the color bar is to be recorded.
<b>TEST SIGNAL</b>	[OFF] ON	This parameter is used to indicate whether or not all setup menu parameters are to be returned to their default settings. <b>CANCEL</b> : Default settings are not to be restored. <b>EXECUTE</b> : Default settings are to be restored.
<b>TEST S</b>	[OFF] ON	This parameter is used to indicate whether or not keyboard parameters are to be returned to their default settings. <b>CANCEL</b> : Default settings are not to be restored. <b>EXECUTE</b> : Default settings are to be restored.
<b>FACTORY SETTING</b>	[CANCEL] EXECUTE	This parameter is used to indicate whether or not keyboard parameters are to be returned to their default settings. <b>CANCEL</b> : Default settings are not to be restored. <b>EXECUTE</b> : Default settings are to be restored.
<b>FACTRY</b>	[CAN] EXE	This parameter is set when using a USB keyboard, and its purpose is to indicate the keyboard's layout (or language) as one of the following. <b>ENGLISH</b> <b>FRENCH</b> <b>ITALIAN</b> <b>GERMAN</b> <b>SPANISH</b> <b>JAPANESE</b>
<b>KEYBOARD STYLE</b>	[ENGLISH] FRENCH ITALIAN GERMAN SPANISH JAPANESE	This parameter is set when using a USB keyboard, and its purpose is to indicate the keyboard's layout (or language) as one of the following. <b>ENGLISH</b> <b>FRENCH</b> <b>ITALIAN</b> <b>GERMAN</b> <b>SPANISH</b> <b>JAPANESE</b>
<b>KBOARD</b>	[ENG] FRN ITL GER ESP JPN	— <b>Note</b> The system must be restarted after this parameter is changed.
<b>EDIT MENU</b>	[ENABLE] DISABLE	This parameter is used to indicate whether or not a screen for editing the title and chapter menus is to be displayed when title closing or finalizing is performed. <b>ENABLE</b> : The menu editing screen is to be displayed. Upon title closing, the THUMBNAIL EDIT screen will be displayed for the corresponding chapter menu. (Page 47) Upon finalizing, the TITLE MENU EDIT screen will be displayed for the title menu. (Page 53) <b>DISABLE</b> : The menu editing screen is not to be displayed.
<b>EDIT</b>	[ON] OFF	This parameter is used to indicate whether or not a screen for editing the title and chapter menus is to be displayed when title closing or finalizing is performed. <b>ENABLE</b> : The menu editing screen is to be displayed. Upon title closing, the THUMBNAIL EDIT screen will be displayed for the corresponding chapter menu. (Page 47) Upon finalizing, the TITLE MENU EDIT screen will be displayed for the title menu. (Page 53) <b>DISABLE</b> : The menu editing screen is not to be displayed.
<b>TOTAL RECORDING TIME</b>	—	This button displays the total time for recording and erasing operations. (xHour xxMin)
<b>MENU</b>		This button is used to return to the Setup Menu screen.

## PRESET STYLE MENU screen

The following table identifies and describes the parameters that may be set using the PRESET STYLE MENU screen.

Top half : Appearance on monitor screen  
 Bottom half : Appearance on LCD display  
 [ ] : Default setting

Parameter	Possible settings	Description
STYLE	[TYPE1] TYPE2 TYPE3 TYPE4 TYPE5 TYPE6 TYPE7 TYPE8	This parameter is used to select one of the eight different display styles that have been provided for title and chapter menus. (☞ Page 44)
STYLE	[T1] T2 T3 T4 T5 T6 T7 T8	
TITLE PATTERN	[1] to 6	This parameter is used to open the TITLE PATTERN screen.
TITL P	[1] to 6	That screen can then be used to select a display pattern for the title menu.
CHAPTER PATTERN	[1] to 6	This parameter is used to open the CHAPTER PATTERN screen.
CHAP P	[1] to 6	That screen can then be used to select a display pattern for the chapter menus.
MENU		This button is used to return to the Setup Menu screen.

## Setup Menu

### RECORDER MENU Screen

The following table identifies and describes the parameters that may be set using the RECORDER screen.

Top half : Appearance on monitor screen  
 Bottom half : Appearance on LCD display  
 [ ] : Default setting

#### RECORDER MENU (1/2) screen

Parameter	Possible settings	Description
CHAPTER CREATION	[MANUAL] AUTO	This parameter is used to indicate whether or not chapters are to be created automatically at set intervals while recording. <b>MANUAL</b> : Chapters are not to be created automatically. Use this setting when chapters are to be set manually.
CHAPTR	[MANU] AUTO	<b>AUTO</b> : Chapters are to be created at set intervals during recording. The SET INTERVAL parameter below is used to specify this interval.
SET INTERVAL	Every01min } [Every05min] } Every59min	This parameter becomes active whenever CHAPTER CREATION has been set to AUTO. It is used to set the time interval for automatic chapter creation and is set in units of minutes.
INTERV	1 } [5] } 59	
TOTAL CONTENTS TIME	[NO USE] 0:01 } 9:59	If you already know the duration of the video to be recorded, this parameter can be set to the corresponding time to allow your BD-X200 to select the optimum encoding bit rate. (Make a setting in hours and minutes between 00:00 and 9:59.)
CNTENS	[00] 001 } 959	• If the recording time is set using this parameter, ENCODE QUALITY will be set automatically, and this setting may not be modified manually. • If this function is not to be used, set it to NO USE. When this setting is made, ENCODE QUALITY will be returned to its previous setting.
ENCODE QUALITY(Mbps)	[8.0] Setting range described on right.	This parameter can be set when TOTAL CONTENTS TIME has been set to NO USE. Specifically, it allows direct setting of the encoding bit rate (i.e., the amount of data per second). The actual setting range depends on the setting that has been made for AUDIO ENCODE.
QUALITY	[8.0]	<b>LPCM</b> : 4.0 to 7.8 Mbps (in 0.2-Mbps steps) <b>DOLBY DIGITAL</b> : 2.0 to 9.0 Mbps (in 0.2-Mbps steps) <b>MPEG</b> : 2.0 to 9.0 Mbps (in 0.2-Mbps steps) <b>(E-model only)</b>
AUDIO ENCODE	<b>LPCM</b> [DOLBY DIGITAL] <b>MPEG</b>	This parameter is used to set the encoding format for audio data. <b>LPCM</b> : Linear PCM encoding (Non-compressed) <b>DOLBY DIGITAL</b> : Dolby AC3 encoding (Compressed) <b>MPEG</b> : MPEG encoding (Compressed) <b>(E-model only)</b>
A ENC	<b>LPCM</b> [DD] <b>MPEG</b>	
ASPECT	[AUTO] 4:3 <b>LETTER BOX</b> <b>SQUEEZE</b>	The screen aspect distinction signal of recorded video is selected. <b>AUTO</b> : Aspect distinction signal is recorded according to the screen aspect ratio of the input video. <b>4:3</b> : Constantly records aspect distinction signal of 4:3 aspect ratio. <b>LETTER BOX</b> : Constantly records aspect distinction signal of letterbox video. (Content at the top and bottom of the screen is blackened out.) <b>SQUEEZE</b> : Constantly records aspect distinction signal of squeezed video. (Content at the left and right of the screen is compressed.)
ASPECT	[AUTO] 4 3 <b>LETT</b> <b>SQUE</b>	— <b>Note</b> — Setting this item to LETTER BOX or SQUEEZE will not change the output image during recording and is reflected only in the recording to the disc.
→		This button is used to display the RECORDER MENU (2/2) screen.
MENU		This button is used to return to the Setup Menu screen.

### RECORDER MENU (2/2) screen

Parameter	Possible settings	Description
Y/C TERMINAL MODE	S1 [S2]	This parameter is used to set the specification for the DVD recorder's VIDEO Y/C INPUT terminal in order to enable the recording of wide-screen discrimination signals. <b>S1</b> : S1 terminal mode is to be adopted. A discrimination signal for normal video with a 4:3 aspect ratio and squeezed video is to be recorded. <b>S2</b> : S2 terminal mode is to be adopted. A discrimination signal for normal video with a 4:3 aspect ratio, squeezed video, and letterbox video is to be recorded.
Y C TM	S1 [S2]	Squeezed video : 16:9 wide-screen content with the left and right sides compressed for normal aspect screens. Letterbox video : Content with the top and bottom of the screen blackened out.
THUMBNAIL FORM	[NORMAL] V CUT H CUT V+H CUT	Thumbnail creation method for chapter and title menus during wide-signal recording is selected. <b>NORMAL</b> : The input signal is to be converted into thumbnails without modification. If the input video has an aspect ratio of 4:3, the corresponding thumbnails are also to have this aspect ratio. <b>V CUT</b> : In this case, the top and bottom of the video content is to be removed to form thumbnails. <b>H CUT</b> : In this case, the left and right of the video content is to be removed to form thumbnails. (SQUEEZE) <b>V+H CUT</b> : In this case, the top, bottom, left, and right of the video content is to be removed to form thumbnails. (LETTER BOX)
THUMB	[NOR] VCUT HCUT V+H	
AUDIO CHANNEL (DV)	[1,2ch → 1,2ch] 3,4ch → 1,2ch	This parameter is to be set when recording an audio signal from the DV IN/OUT terminal. Specifically, it indicates whether the signals from channels 1 and 2 or from channels 3 and 4 are to be recorded. (Only available for 32 kHz)
DV CH	[1 2] 3 4	<b>1,2ch → 1,2ch</b> : Channels 1 and 2 are to be recorded. <b>3,4ch → 3,4ch</b> : Channels 3 and 4 are to be recorded.
AUDIO REC VOL. MODE	[BOTH] INDEPENDENCE	This parameter is used to select the method for adjustment of audio recording levels. Specifically, both channels can be adjusted while maintaining the same level, or each channel can be adjusted independently.
VRMODE	[BOTH] INDE	<b>BOTH</b> : Both channels are to be adjusted while maintaining the same level. <b>INDEPENDENCE</b> : Both channels are to be adjusted independently.
DISC IN ACTION	[MENU] TITLE	This parameter is used to indicate the action to be taken when a completed (i.e., finalized) disc is inserted into this DVD recorder or another DVD player. In order to be effective, this setting must be made during the recording process.
DISCIN	[MENU] TITL	<b>MENU</b> : The title menu is to be displayed. <b>TITLE</b> : Playback of the main content is to begin.
TITLE END	[MENU] REPEAT	This parameter is used to indicate the action to be taken when playback of a title on a completed (i.e., finalized) disc has ended. In order to be effective, this setting must be made during the recording process.
TI END	[MENU] REPT	<b>MENU</b> : The title menu is to be displayed. <b>REPEAT</b> : Playback is to be repeated within the current title.
BACK		This button is used to return to the RECORDER MENU (1/2) screen.

## Setup Menu

### REMOTE MENU screen

The following table identifies and describes the parameters that may be set using the REMOTE MENU screen.

Top half : Appearance on monitor screen

Bottom half : Appearance on LCD display

[ ] : Default setting

Parameter	Possible settings	Description
REMOTE SELECT	[OFF] 9PIN(MASTER) DV(MASTER) DV(SLAVE) DV(TRIGGER)	This parameter is used to select a method for controlling external devices connected via the RS-422A REMOTE terminal or the DV IN/OUT terminal). <b>OFF</b> : Control is not to be carried out via the RS-422A REMOTE terminal or the DV IN/OUT terminal. This is the standard setting for normal operation. <b>9PIN(MASTER)</b> : This setting is made when recording audio and video from a VCR connected to the RS-422A REMOTE terminal. When selected, the REMOTE CONTROL (9PIN MASTER) screen appears, and this screen can be used to carry out recording operations. <b>DV(MASTER)</b> : This setting is made when recording audio and video from a DV camera or video connected to the DV IN/OUT terminal. When selected, the REMOTE CONTROL (DV MASTER) screen appears, and this screen can be used to carry out recording operations.
REMOTE	[OFF] 9PIN DVM DVS DVT	<b>DV(SLAVE)</b> : This setting is made when recording audio and video from a non-linear editor connected to the DV IN/OUT terminal. When selected, the REMOTE CONTROL (DV SLAVE) screen appears. In addition, the BD-X200 will become the slave device and will be controlled by the non-linear editor. <b>DV(TRIGGER)</b> : This setting is made when the BD-X200 is connected to a DV camera featuring a DV record triggering function, and it allows this DVD recorder to record video from the camera in response to operation of its trigger button.
<p>— Note</p> <p>When setting this item to 9PIN (MASTER), DV (MASTER) or DV (SLAVE), the video output image becomes the REMOTE CONTROL screen display. However, video input can be checked by press and holding the REC button while DVD Recorder is stopped and viewing the encode output.</p>		
REC CONTROL	[OFF] ON	This parameter is used to indicate whether or not the REC CONTROL panel is to be displayed on the monitor screen. <b>ON</b> : The REC CONTROL panel is to be displayed only when a recordable disc has been inserted and the DVD recorder is in Stop, Recording, or Recording Pause mode. <b>OFF</b> : The REC CONTROL panel not to be displayed.
REC	[OFF] ON	
REM FF/REW MODE	[FF/REW] SEARCH	This parameter is used to select the command output via the RS-422A REMOTE terminal or DV terminal when the FF or REW button is pressed on the REMOTE CONTROL (9PIN MASTER/DV MASTER) screen.
SEARCH	[F R] SEA	<b>FF/REW</b> : A FF or REW command is to be output accordingly. <b>SEARCH</b> : A forward-search or reverse-search command is to be output accordingly.
MENU		This button is used to return to the Setup Menu screen.

## DISPLAY MENU screen

The following table identifies and describes the parameters that may be set using the DISPLAY screen.

Top half : Appearance on monitor screen  
 Bottom half : Appearance on LCD display  
 [ ] : Default setting

Parameter	Possible settings	Description
DISPLAY	OFF [ON]	This parameter is used to indicate whether or not status and alarm information is to be displayed on the monitor screen. OFF : No such data is to be displayed on-screen.
DISPLY	OFF [ON]	ON : Data is to be displayed on-screen. When this parameter has been set to ON, the following parameters can be used to indicate which types of status information will be displayed
TITLE/CHAPTER	OFF [ON]	This parameter is used to indicate whether or not the DVD's title, chapter number, and elapsed time are to be displayed on-screen during recording and playback. OFF : No such data is to be displayed on-screen.
TITLE	OFF [ON]	ON : This data is to be displayed on-screen. Note, however, that nothing will be displayed when OFF has been set for the DISPLAY parameter.
RECORDER MODE	OFF [ON]	This parameter is used to indicate whether or not the DVD recorder's current status is to be displayed on-screen. OFF : The status is not to be displayed on-screen.
MODE	OFF [ON]	ON : The status is to be displayed on-screen. Note, however, that nothing will be displayed when OFF has been set for the DISPLAY parameter.
TIME/DATE	[OFF] DATE TIME TIME+DATE	This parameter is used to indicate whether or not the current date and/or time are to be displayed on-screen. OFF : No such information is to be displayed on-screen. DATE : Only the date is to be displayed. TIME : Only the time is to be displayed. TIME+DATE : Both date and time are to be displayed.
DATE	[OFF] DATE TIME T+D	<ul style="list-style-type: none"> <li>When the DVD recorder is stopped or recording, data from the internal clock is displayed. When playing a disc, the date and time of disc finalizing are displayed.</li> <li>Even if DATE, TIME, or DATE+TIME have been selected, nothing will be displayed when OFF has been set for the DISPLAY parameter.</li> </ul>
REMAIN	[OFF] ON	This parameter is used to indicate whether or not the disc's remaining time (in minutes) is to be displayed on-screen. OFF : No such data is to be displayed on-screen. ON : This data is to be displayed on-screen.
REMAIN	[OFF] ON	<ul style="list-style-type: none"> <li>During recording, the remaining space available for recording is displayed (in minutes).</li> <li>During playback, the time remaining in the current title is displayed.</li> <li>Nothing will be displayed when OFF has been set for the DISPLAY parameter.</li> </ul> <p><b>Note</b>                      The remaining space available for recording will depend on factors such as the number of titles recorded and the data encoding method; accordingly, this value should be treated as an estimate and not as an exact value.</p>
DATE STYLE	YY/MM/DD [MM/DD/YY] (U model) [DD/MM/YY] (E model)	This parameter is used to select the display style for dates. YY/MM/DD : Dates are to be displayed in year, month, and day sequence. MM/DD/YY : Dates are to be displayed in month, day, and year sequence. DD/MM/YY : Dates are to be displayed in day, month, and year sequence.
DSTYLE	YMD [MDY] (U model) [DMY] (E model)	
MENU		This button is used to return to the Setup Menu screen.

## Setup Menu

### CLOCK ADJUST MENU screen

The following table identifies and describes the parameters that may be set using the CLOCK ADJUST MENU screen.

Top half : Appearance on monitor screen  
 Bottom half : Appearance on LCD display  
 [ ] : Default setting

Parameter	Possible settings	Description
DATE		This parameter is used to set the date.
DATE		For more details regarding date and time settings, refer to page 27.
TIME		
TIME		
MENU		This button is used to return to the Setup Menu screen.

### DUBBING screen

The following table identifies and describes the parameters that may be set using the DUBBING screen.

Top half : Appearance on monitor screen  
 Bottom half : Appearance on LCD display  
 [ ] : Default setting

Parameter	Possible settings	Description
DVD → DVD	[CANCEL] EXECUTE	This parameter is to be selected to enable DVD-to-DVD dubbing via the LAN terminal. CANCEL : Dubbing is not to be carried out. EXECUTE : Dubbing is to be carried out.
dub	[CAN] EXE	(≠ Page 70)
MENU		This button is used to return to the Setup Menu screen.

---

## NETWORK MENU Screen

The following table identifies and describes the parameters that may be set using the NETWORK MENU screen.

Top half : Appearance on monitor screen

Bottom half : Appearance on LCD display

[ ] : Default setting

Parameter	Possible settings	Description
HOST NAME ----- HOST	bdx200	This parameter is used to enter the BD-X200's network name using a keyboard. (Names may be up to 20 characters in length. Alphanumerical characters and hyphen (-))
IP ADDRESS ----- IP ADD	[192.168.0.2]	This parameter is used to set the IP address. It is important to ensure that no two devices on a single network share the same IP address.
SUBNET MASK ----- SUBNET	[255.255.255.0]	This parameter is used to set the subnet mask. Connected BD-X200s should have the same network setting.
DEFAULT GATEWAY ----- GATE	[192.168.0.254]	This parameter is used to set the gateway address. Connected BD-X200s should have the same address.
MENU		This button is used to return to the Setup Menu screen.

---

## Others

### Troubleshooting

Before requesting for repair, please check the following URL:

<http://www.jvc-victor.co.jp/english/pro/prodv/>

If problem persists, contact either the store where the BD-X200 was purchased or your nearest JVC authorized dealer.



## Others

### Specifications

Recording format : DVD Video Version 1.1  
 Disc format : ISO9660-compatible UDF  
 Recordable media : DVD-R For General Version 2.0  
 DVD-RW Version 1.1  
 Recording signals : Must conform to DVD Video Format

#### Video Signals

Line input : 1.0 V(p-p), 75 Ω unbalanced  
 Y/C input : Y signal = 1.0 V(p-p), 75 Ω unbalanced  
 C signal = 0.286 V(p-p), 75 Ω unbalanced  
 Line output : 1.0 V(p-p), 75 Ω unbalanced  
 Encoding format : ISO/IEC13818-2 (MPEG-2 video)  
 Quantization : 8 bit  
 Sampling rate : 13.5 MHz

#### Audio Signals

Line input : -8 dBs, 10 kΩ minimum, unbalanced  
 +4 dBs, high impedance, unbalanced  
 Line output : -8 dBs, 1 kΩ minimum, unbalanced  
 Standard level : -20 dBFS  
 Dynamic range : 85 dB  
 Recording format : LPCM / DOLBY DIGITAL  
 Quantization : 16 bit  
 Sampling rate : 48 kHz  
 Number of channels: 2

#### DV Interface

I/O : IEEE1394

#### External Dimensions (Unit: mm)

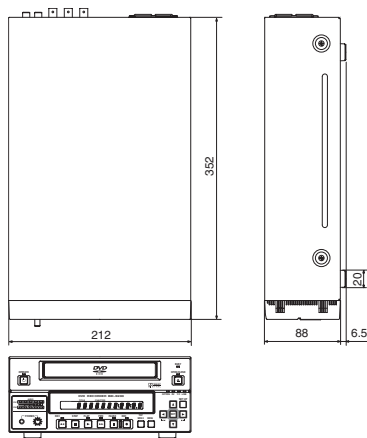

## Others

### Specifications

Recording format : DVD Video Version 1.1  
 Disc format : ISO9660-compatible UDF  
 Recordable media : DVD-R For General Version 2.0  
 DVD-RW Version 1.1  
 Recording signals : Must conform to DVD Video Format

#### Video Signals

Line input : 1.0 V(p-p), 75 Ω unbalanced  
 Y/C input : Y signal = 1.0 V(p-p), 75 Ω unbalanced  
 C signal = 0.3 V(p-p), 75 Ω unbalanced  
 Line output : 1.0 V(p-p), 75 Ω unbalanced  
 Encoding format : ISO/IEC13818-2 (MPEG-2 video)  
 Quantization : 8 bit  
 Sampling rate : 13.5 MHz

#### Audio Signals

Line input : -8 dBs, 10 kΩ minimum, unbalanced  
 +4 dBs, high impedance, unbalanced  
 Line output : -8 dBs, 1 kΩ minimum, unbalanced  
 Standard level : -20 dBFS  
 Dynamic range : 85 dB  
 Recording format : LPCM / DOLBY DIGITAL / MPEG  
 Quantization : 16 bit  
 Sampling rate : 48 kHz  
 Number of channels: 2

#### DV Interface

I/O : IEEE1394

#### External Dimensions (Unit: mm)

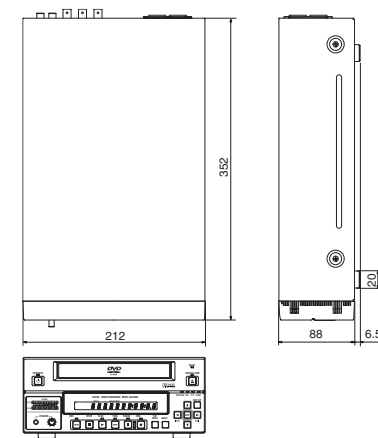



This product uses partial third-party software.  
For information concerning the software used, login via FTP by inputting the following into the unit and view the readme.txt file:  
User: anonymous  
Password: None  
(If the IP address of the unit is set to 192.168.0.2, FTP connection can be established by entering ftp://196.168.0.2 in the address bar of Internet Explorer.)

### About the audio mode during DV input

When inputting Audio UNLOCK mode signals from the DV input, high harmonic signals modulated from the audio source may be recorded as noise in rare cases. If this occurs, set the audio mode of the input source to LOCK mode, or use the LINE input or YC input.

This unit can detect audio signals of UNLOCK mode during DV input. When UNLOCK mode is detected, the unit displays:

"DV A UNLOCK" on the unit LCD

"UNLOCKED AUDIO(DV)" on the screen

until recording is started.

(May also be displayed when playing back a blank tape.)

In order to achieve higher quality recording, setting the source of DV input to the LOCK mode is recommended.

\* About audio LOCK/UNLOCK mode

For DV digital signals, synchronous relationship of video and audio signals is referred to as LOCK mode, and asynchronous relationship of video and audio signals is referred to as UNLOCK mode.

In the case of DV, 44.1kHz mode is normally the UNLOCK mode.

For the 48 kHz and 32 kHz modes, settings differ depending on the inputting video device. Please check instruction manual of the used.

## Free Manuals Download Website

<http://myh66.com>

<http://usermanuals.us>

<http://www.somanuals.com>

<http://www.4manuals.cc>

<http://www.manual-lib.com>

<http://www.404manual.com>

<http://www.luxmanual.com>

<http://aubethermostatmanual.com>

Golf course search by state

<http://golfingnear.com>

Email search by domain

<http://emailbydomain.com>

Auto manuals search

<http://auto.somanuals.com>

TV manuals search

<http://tv.somanuals.com>