

JVC

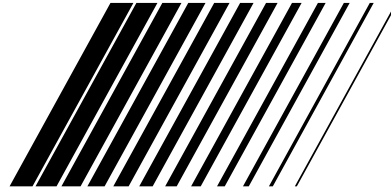

DVD VIDEO RECORDER

DR-M150SEK

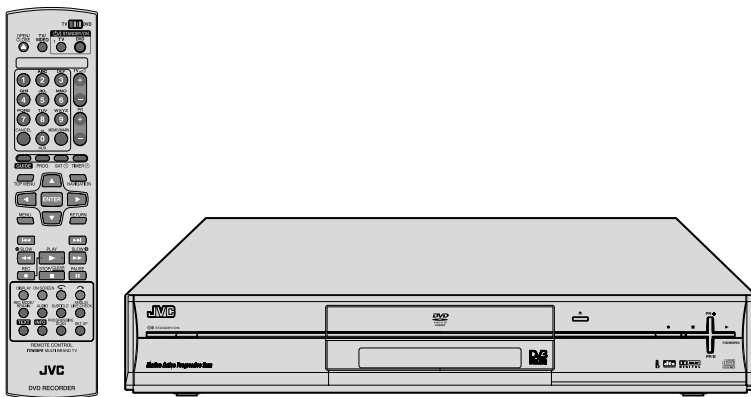

Trade Mark of the DVB Digital Video Broadcasting Project (1991 to 1996) Number : 3546

INSTRUCTIONS

LPT1045-001A

EN

2 EN SAFETY FIRST

Safety Precautions

The rating plate and the safety caution are on the rear of the unit.

WARNING: DANGEROUS VOLTAGE INSIDE
WARNING: TO PREVENT FIRE OR SHOCK HAZARD, DO NOT EXPOSE THIS UNIT TO RAIN OR MOISTURE.

CAUTION:
 A UNIT IS A CLASS 1 LASER PRODUCT. HOWEVER THIS UNIT USES A VISIBLE LASER BEAM WHICH COULD CAUSE HAZARDOUS RADIATION EXPOSURE IF DIRECTED. BE SURE TO OPERATE THE UNIT CORRECTLY AS INSTRUCTED. WHEN THIS UNIT IS PLUGGED INTO THE WALL OUTLET, DO NOT PLACE YOUR EYES CLOSE TO THE OPENING OF THE DISC TRAY AND OTHER OPENINGS TO LOOK INTO THE INSIDE OF THIS UNIT. USE OF CONTROLS OR ADJUSTMENTS OR PERFORMANCE OF PROCEDURES OTHER THAN THOSE SPECIFIED HEREIN MAY RESULT IN HAZARDOUS RADIATION EXPOSURE. DO NOT OPEN COVERS AND DO NOT REPAIR YOURSELF. REFER SERVICING TO QUALIFIED PERSONNEL.

CLASS 1 LASER PRODUCT
 REPRODUCTION OF LABELS
 WARNING LABEL INSIDE OF THE UNIT

DISCLAIMER OF LIABILITY

JVC shall not be liable for any loss relating to the unit's failure to properly record, store or playback any content (video, audio or otherwise) for any reason whatsoever. Any applicable warranties shall only cover replacement or repair of the effected unit, and shall not apply to recovery or replacement of lost content.

ATTENTION:

- Using a mobile phone in the vicinity of the unit may cause picture vibration on the TV screen or change the screen to a blue back display.
- If there is a power outage when using the unit, the recorded data may be erased.
- Recorded programmes and data cannot be restored once the disc is damaged.
- When discarding batteries, environmental problems must be considered and the local rules or laws governing the disposal of these batteries must be followed strictly.

CAUTION	VISIBLE AND INVISIBLE LASER RADIATION WHEN OPEN. AVOID EXPOSURE TO BEAM. DO NOT STARE INTO BEAM OR VIEW DIRECTLY WITH OPTICAL INSTRUMENTS.
ADVARSEL	SYNLIG OG USYNLIG LASERSTRÅLING VED ÅBNING. UNDGÅ UDSÆTTELSE FOR STRÅLING SE IKKE IND I STRÅLEN - HELLER IKKE MED OPTISKE INSTRUMENTER.
ADVARSEL	SYNLIG OG USYNLIG LASERSTRÅLING NÅR DEKSEL ÅPNES. UNDGÅ EKSPONERING FOR STRÅLEN STIRR IKKE INN I STRÅLEN ELLER SE DIREKTE MED OPTISKE INSTRUMENTER.
VARO!	AVATTAESSA OLET ALTTIINA NÄKYVÄÄ JA NÄKYMÄTÖN LASERSÄTEILYLLE. ÄLÄ TUIJOTA SÄTEESEEN ÄLÄKÄ KATSO SITÄ OPTISEN LAITTEEN LÄPI.
WARNING	SYNLIG OCH OSYNLIG LASERSTRÅLNING NÅR DENNA DEL ÄR ÖPPNAD. STRÅLEN ÄR FARLIG STIRRA EJ IN I STRÅLEN OCH BETRAKTA EJ STRÅLEN MED OPTISKA INSTRUMENT.

OR

CAUTION VISIBLE AND INVISIBLE LASER RADIATION WHEN OPEN. AVOID EXPOSURE TO BEAM. DO NOT STARE INTO BEAM OR VIEW DIRECTLY WITH OPTICAL INSTRUMENTS.	ATTENTION RAYONNEMENTS LASER VISIBLES ET INVISIBLES. LORS DE L'OUVERTURE, ÉVITER TOUTE EXPOSITION AU FAISCEAU. NE PAS FIXER DU REGARD LE FAISCEAU OU LE REGARDER DIRECTEMENT VIA DES INSTRUMENTS OPTIQUES.	ADVARSEL SYNLIG OG USYNLIG LASERSTRÅLING VED ÅBNING. UNDGÅ UDSÆTTELSE FOR STRÅLING. SE IKKE IND I STRÅLEN, HELLER IKKE MED OPTISKE INSTRUMENTER.	ADVARSEL SYNLIG OG USYNLIG LASERSTRÅLING NÅR DEKSEL ÅPNES. UNDGÅ EKSPONERING FOR STRÅLEN. STIRR IKKE INN I STRÅLEN ELLER SE DIREKTE MED OPTISKE INSTRUMENTER.	VARO! AVATTAESSA OLET ALTTIINA NÄKYVÄÄ JA NÄKYMÄTÖMÄLLE LASERSÄTEILYLLE. ÄLÄ TUIJOTA SÄTEESEEN ÄLÄKÄ KATSO SITÄ OPTISEN LAITTEEN LÄPI.	VARNING SYNLIG OCH OSYNLIG LASERSTRÅLNING NÅR DENNA DEL ÄR ÖPPNAD. STRÅLEN ÄR FARLIG STIRRA EJ IN I STRÅLEN OCH BETRAKTA EJ STRÅLEN MED OPTISKA INSTRUMENT. LP41158-001A
--	--	--	---	--	--

IMPORTANT:



- Please read the various precautions on page 2 – 4 before installing or operating the unit.
- It should be noted that it may be unlawful to re-record pre-recorded tapes, DVDs, or discs without the consent of the owner of copyright in the sound or video recording, broadcast or cable programme and in any literary, dramatic, musical, or artistic work embodied therein.

CAUTION:

- When you are not using the unit for a long period of time, it is recommended that you disconnect the power cord from the mains outlet.
- Dangerous voltage inside. Refer internal servicing to qualified service personnel. To prevent electric shock or fire hazard, remove the power cord from the mains outlet prior to connecting or disconnecting any signal lead or aerial.
- The mains plug shall remain readily operable.



- Manufactured under licence from Dolby Laboratories. "Dolby" and double-D symbol are trademarks of Dolby Laboratories.
- "DTS" and "DTS DIGITAL OUT" are trademarks of Digital Theater Systems, Inc.
- DVB (Digital Video Broadcasting) is a registered trademark of Digital Video Broadcasting Project. The Digital Video Broadcasting system is manufactured under license from Digital Video Broadcasting Project.
- This product incorporates copyright protection technology that is protected by method claims of certain U.S. patents and other intellectual property rights owned by Macrovision Corporation and other rights owners. Use of this copyright protection technology must be authorized by Macrovision Corporation, and is intended for home and other limited viewing users only unless otherwise authorized by Macrovision Corporation. Reverse engineering or disassembly is prohibited.

The STANDBY/ON /I button does not completely shut off mains power from the unit, but switches operating current on and off. “” shows electrical power standby and “I” shows ON.

Failure to heed the following precautions may result in damage to the unit, remote control or disc.

1. **DO NOT place the unit** —
 - in an environment prone to extreme temperatures or humidity.
 - in direct sunlight.
 - in a dusty environment.
 - in an environment where strong magnetic fields are generated. In addition, do not place TVs or other appliances which tend to generate strong magnetic fields on top of the unit as it may cause picture disturbance.
 - on a surface that is unstable or subject to vibration.
2. **DO NOT block the unit’s ventilation openings or holes.**
 If the ventilation openings or holes are blocked by a newspaper or cloth, etc., the heat may not be able to get out. When installing the equipment, make sure there is a space allowance of 10 cm or more on both sides, on top and at the rear of the equipment.
3. **DO NOT place heavy objects on the unit or remote control.**
4. **DO NOT place anything which might spill on top of the unit or remote control.**
 (If water or liquid is allowed to enter this equipment, fire or electric shock may be caused.)
5. **DO NOT expose the apparatus to dripping or splashing.**
6. **DO NOT use this equipment in a bathroom or places with water.** Also **DO NOT** place any containers filled with water or liquids (such as cosmetics or medicines, flower vases, potted plants, cups, etc.) on top of this unit.
7. **DO NOT place any naked flame sources, such as lighted candles, on the apparatus.**
8. **AVOID violent shocks to the unit during transport.**

MOISTURE CONDENSATION

Moisture in the air will condense on the unit when you move it from a cold place to a warm place, or under extremely humid conditions—just as water droplets form on the surface of a glass filled with cold liquid. In conditions where condensation may occur, disconnect the unit’s power plug from the wall and keep it disconnected for a few hours to let the moisture dry, then turn on the unit.

IMPORTANT

Connection to the mains supply in the United Kingdom. DO NOT cut off the mains plug from this equipment.

If the plug fitted is not suitable for the power points in your home or the cable is too short to reach a power point, then obtain a proper safety approved extension lead/adaptor or consult your dealer.

In the unlikely event of the plug fuse failing be sure to replace the fuse only with an identical approved type, as originally fitted, and to replace the fuse cover. If the fuse fails again consult your nearest JVC dealer.

If nonetheless the mains plug is cut off remove the fuse and dispose of the plug immediately, to avoid a possible shock hazard by inadvertent connection to the mains supply.

If this product is not supplied fitted with a mains plug then follow the instructions given below:

DO NOT make any connection to the Larger Terminal coded E or Green.

The wires in the mains lead are coloured in accordance with the following code:

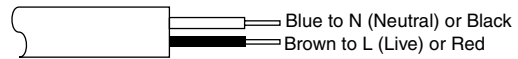

If these colours do not correspond with the terminal identifications of your plug, connect as follows:
 Blue wire to terminal coded N (Neutral) or coloured Black.
 Brown wire to terminal coded L (Live) or coloured Red.

If in doubt — consult a competent electrician.

Information for Users on Disposal of Old Equipment



[European Union]

This symbol indicates that the electrical and electronic equipment should not be disposed as general household waste at its end-of-life. Instead, the product should be handed over to the applicable collection point for the recycling of electrical and electronic equipment for proper treatment, recovery and recycling in accordance with your national legislation.

By disposing of this product correctly, you will help to conserve natural resources and will help prevent potential negative effects on the environment and human health which could otherwise be caused by inappropriate waste handling of this product. For more information about collection point and recycling of this product, please contact your local municipal office, your household waste disposal service or the shop where you purchased the product.

Penalties may be applicable for incorrect disposal of this waste, in accordance with national legislation.

ATTENTION:

This symbol is only valid in the European Union.

(Business users)

If you wish to dispose of this product, please visit our web page www.jvc-europe.com to obtain information about the take-back of the product.

[Other Countries outside the European Union]

If you wish to dispose of this product, please do so in accordance with applicable national legislation or other rules in your country for the treatment of old electrical and electronic equipment.

4 EN SAFETY FIRST

Some Do's And Don'ts On The Safe Use Of Equipment

This equipment has been designed and manufactured to meet international safety standards but, like any electrical equipment, care must be taken if you are to obtain the best results and safety is to be assured.

- DO read the operating instructions before you attempt to use the equipment.
- DO ensure that all electrical connections (including the mains plug, extension leads and interconnections between pieces of equipment) are properly made and in accordance with the manufacturer's instructions. Switch off and withdraw the mains plug when making or changing connections.
- DO consult your dealer if you are ever in doubt about the installation, operation or safety of your equipment.
- DO be careful with glass panels or doors on equipment.
- DON'T continue to operate the equipment if you are in any doubt about it working normally, or if it is damaged in any way—switch off, withdraw the mains plug and consult your dealer.
- DON'T remove any fixed cover as this may expose dangerous voltages.
- DON'T leave equipment switched on when it is unattended unless it is specifically stated that it is designed for unattended operation or has a standby mode. Switch off using the switch on the equipment and make sure that your family knows how to do this. Special arrangements may need to be made for infirm or handicapped people.
- DON'T use equipment such as personal stereos or radios so that you are distracted from the requirements of road safety. It is illegal to watch television whilst driving.
- DON'T listen to headphones at high volume, as such use can permanently damage your hearing.
- DON'T obstruct the ventilation of the equipment, for example with curtains or soft furnishings. Overheating will cause damage and shorten the life of the equipment.
- DON'T use makeshift stands and NEVER fix legs with wood screws—to ensure complete safety always fit the manufacturer's approved stand or legs with the fixings provided according to the instructions.
- DON'T allow electrical equipment to be exposed to rain or moisture.

ABOVE ALL...

- NEVER let anyone especially children push anything into holes, slots or any other opening in the case—this could result in a fatal electrical shock;
- NEVER guess or take chances with electrical equipment of any kind—it is better to be safe than sorry!

Information On Reception Of Digital Transmissions

If your DR-M150 reports that no digital signals were found after auto-tuning, or if the number of channels found is fewer than expected, this does not necessarily indicate a fault. Because of the nature of digital transmissions, there can be several external causes for this.

The following information may help you determine the exact cause.

Digital transmissions are broadcast at much lower power and on different channels or different transmitters to analogue transmissions. This may mean that you will require an aerial upgrade in order to receive them. Some smaller transmitters do not yet transmit digital signals at all. To see if you are in an area covered by digital signals, use the online postcode checker at <http://www.dtg.org.uk/consumer/coverage.html>. This will give a good indication of the conditions in your area. A more detailed version of the postcode checker, which shows more details of the channels you can expect to receive in your area, is available at <http://www.dtg.org.uk/retailer/coverage.html>. Please note that these postcode checkers give a good indication of what is available but, due to local conditions, they cannot be 100% accurate.

If you require an aerial upgrade to receive digital transmissions, you should first contact your dealer who should be able to advise on a suitable aerial. If this is not practical, you should choose an aerial installer who is a member of the Confederation of Aerial Industries (CAI). All CAI members conform to a code of practice. You can search for your local CAI registered installer at: <http://www.cai.org.uk/asp/installer.asp>

If you have a shared communal aerial system, this may be designed to receive only the analogue transmissions in your area. You should check with your landlord or local housing authority to see if your aerial system can be upgraded to receive digital transmissions.

Please note that unless you are located very close to the transmitter, it is very unlikely that you will be able to receive digital transmissions reliably with an indoor aerial.

If you have any other questions regarding the reception of digital transmissions, please call JVC Customer Services on 0870-330-5000.

CONTENTS EN **5**

SAFETY FIRST	2	EDITING	53
Safety Precautions	2	DV Dubbing	53
Some Do's And Don'ts On The Safe Use Of Equipment	4	Digital Audio Dubbing	54
Information On Reception Of Digital Transmissions	4	Edit From A Camcorder	55
DISC INFORMATION	6	Edit To Or From Another Recorder	56
About Discs	6	Output/Input Set	57
INDEX	11	SYSTEM CONNECTIONS	59
INSTALLING YOUR NEW UNIT	16	Connecting To A Satellite Receiver	59
Basic Connection	16	Connecting To A Dolby Digital Decoder Or An Amplifier With Built-in DTS	59
INITIAL SETTINGS	17	SUBSIDIARY SETTINGS	60
Auto Set Up	17	Mode Set	60
Language	19	Remote Control Functions	62
Monitor Set	19	TV Multi-Brand Remote Control	62
Setting DTV	20	Tray Lock	63
BASIC OPERATIONS ON DVD DECK	21	Child Lock	63
Basic Operation (TV)	21	Scan Mode Set	63
Basic Playback	22	Tuner Set	64
Playback Features	23	Clock Set	66
Live Memory Playback	27	Format A Disc	67
Using The On-screen Bar	30	Finalise A Disc	68
Basic Recording	34	TROUBLESHOOTING	69
Recording Features	35	APPENDIX	72
TIMER RECORDING	37	LIST OF TERMS	74
EPG Timer Programming	37		
Manual Timer Programming	38		
On-Disc Timer Programming	39		
Check, Cancel And Change Programmes	41		
Automatic Satellite Programme Recording	42		
NAVIGATION	43		
Library Database Navigation	43		
Basic Operation Of Original Information	44		
Edit Original Information	46		
Basic Operation Of Play List Information	47		
Edit Play List Information	48		
Edit Library Information	51		
Playback With MP3/JPEG Navigation	52		

HOW TO USE THIS INSTRUCTION MANUAL



- All major sections and subsections are listed in the Table Of Contents on page 5. Use this when searching for information on a specific procedure or feature.
- The Index on pages 11 – 13 illustrates the controls and connections on the front and rear panel, the front display panel and the remote control.
- The list of terms on page 74 lists frequently-used terms, and the number of the page on which they are used or explained in the manual.
- The  mark signals a reference to another page for instructions or related information.
- Operation buttons necessary for the various procedures are clearly indicated through the use of illustrations at the beginning of each major section.

6 EN **DISC INFORMATION**

About Discs

Recordable/Playable Discs

You can use discs with the following logos for recording and playback.

 <p>DVD-RAM 12 cm: 4.7 GB/9.4 GB 8 cm: 1.4 GB/2.8 GB Ver. 2.0/2x speed Ver. 2.1/1x – 3x speed Ver. 2.2/5x speed</p>	 <p>DVD-RW 12 cm: 4.7 GB 8 cm: 1.4 GB Ver. 1.1/1x – 2x speed (Video mode/VR mode) Ver. 1.2/4x speed (Video mode/VR mode)</p>
 <p>DVD-R 12 cm: 4.7 GB 8 cm: 1.4 GB Ver. 2.0/1x – 4x/8x speed (Video mode) Ver. 2.1/16x speed (Video mode)</p>	

- The above table is based on the information as of February 2005.
- Recording and playback may not be performed depending on the characteristics and condition of the disc used, leading to unsatisfactory results. Using discs manufactured by JVC is recommended since they have been tested to be compatible with this unit.

DVD-RAM Discs

It is only possible to use discs which conform with DVD-RAM standard Version 2.0, 2.1 or 2.2.

- If you use a disc formatted under a different standard version, format it on this unit before use.
- It may not be possible to record, play back, edit or dub a DVD-RAM disc even if it conforms to the standard if it was recorded or edited on the devices from other manufacturers or on a PC, or if it has far too many titles, or if there is very little available capacity remaining on the disc.
- DVD-RAM discs recorded on this unit cannot be played back on an incompatible DVD player.
- It is possible to record copy-once programmes of digital broadcasts only onto 4.7/9.4 GB DVD-RAM discs. (2.8 GB DVD-RAM discs are not compatible.)
- This unit does not support discs contained in cartridges. Use the disc after removing it from the cartridge. For details on discs in TYPE2 and TYPE4 (disc removable) cartridge, refer to its instruction manual.
- While recording, it is possible not only to start playback of a programme currently being recorded, but also to watch another programme previously recorded.

DVD-R/RW Discs

It is only possible to use DVD-R discs which conform with DVD-R standard Version 2.0 or 2.1.

It is only possible to use discs which conform with DVD-RW standard Version 1.1 or 1.2. Available in VR mode and Video mode.

When a DVD-R/RW disc (Video mode) is finalised (pg. 68), it can be played back on a standard DVD player as a DVD VIDEO disc.

When a DVD-RW disc (VR mode) is finalised (pg. 68), it can be played back on DVD player compatible with the VR mode of DVD-RW discs.

Before finalising—

It is possible to record on unrecorded areas of the disc, edit the disc title and programme titles, and delete programmes.

- It is impossible to record or edit DVD-R/RW discs recorded on other devices even if they have not been finalised.
- It is impossible to overwrite recorded areas of DVD-R discs.
- Available recording capacity does not increase even if a recorded programme is deleted from a DVD-R disc.

After finalising—

After a DVD-R/RW disc (Video mode) has been finalised, it is possible to play back the recorded programmes (video and/or audio) on a standard DVD video player as a DVD VIDEO disc.

- Edited titles are displayed as the “DVD menu” in video mode.
- It is impossible to record, edit or delete the data either in video mode or in VR mode.
- Either in video mode or in VR mode, although the disc can be played back on DVD players from other manufacturers, sometimes it may not be possible to play back depending on the disc and recording conditions.
- It is impossible to record on CD-R/RW or DVD-R discs used for authoring.
- When recording copy-once programmes of digital broadcasts, record in VR mode using CPRM compatible DVD-RW discs.









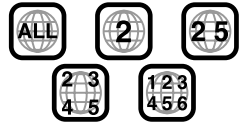

NOTE:

The following may result if you play back a DVD-R disc recorded on another unit.

- The disc does not play.
- A mosaic pattern (block noise) appears on the screen.
- Video or audio may be dropped out.
- The unit stops during playback.

Discs For Playback Only

You can use discs with the following logos for playback only.

 DVD VIDEO (example of region code indications) 	Video CD/Super Video CD  COMPACT disc DIGITAL VIDEO  COMPACT disc SUPER VIDEO  VIDEO CD  VIDEO CD
 COMPACT disc DIGITAL AUDIO Audio CD CD-DA files	 COMPACT disc Recordable CD-R CD-DA/JPEG/MP3 files
 COMPACT disc ReWritable CD-RW CD-DA/JPEG/MP3 files	 COMPACT disc CD-ROM JPEG/MP3 files

- Playback may not be performed depending on the characteristics and condition of the disc used.
- DTS Audio CDs can also be played back. (An optional DTS decoder is required)
- MP3 and JPEG discs can be played back on this unit only when they have been recorded in the ISO9660 or Joliet format and finalised.
- JPEG files that can be played back on this unit must conform to JFIF/Baseline process, and the maximum resolution of a JPEG file is 2,812 pixels in width and 2,112 pixels in height.
- CD-R/RW discs recorded in music CD format need to be finalised to play back on this unit.
- Operation and audio quality of this unit are not guaranteed for discs that do not conform to the Compact Disc specification (CD-DA).
- Before you play back a CD, check for the CD logo and read the notes on the package to confirm that it conforms to the Compact Disc specification.
- Depending on the intentions of the author of the software, recording conditions of DVD discs and Video CD/SVCD discs may be restricted. Since this unit plays back discs according to the intentions of the author of the software as indicated on the disc, some functions may not operate as commanded.
- When switching from the first layer to the second layer of double-layered DVD VIDEO discs, the image and sound may be momentarily distorted. This is not a malfunction.
- DVD-AUDIO discs compatible with DVD video players can be played.
- Super Audio CDs (SACD) compatible with conventional CD players can be played.
- It is possible to play back finalised +R/+RW (Video mode) discs. "DVD" lights up on the front display panel.

Unplayable Discs

The unit may not be able to play back or it may take some time to read a disc depending on the recording status or condition of the disc, or if the disc is scratched, dirty or warped.

In addition, do not attempt to play back discs in unusual shapes (heart-shaped, octagonal, or other forms). If such discs are accidentally played back, it may cause noise that can lead to speaker damage.

- CD-ROM discs (including PHOTO-CD and CD-G)
- Discs recorded in Packet Write (UDF) format
- 1.3 GB double density CDs (DDCD)
- High density CDs (HDCD)
- DVD-R DL (single-sided double-layer) discs
- +R DL (single-sided double-layer) discs

The following discs also cannot be played back.

- Discs of a region number other than "2"
- DVD-RAM (2.6 GB/5.2 GB)
- DVD-RAM (TYPE1)

Caution for DualDisc playback

The Non-DVD side of a "DualDisc" does not comply with the "Compact Disc Digital Audio" standard. Therefore, the use of Non-DVD side of a DualDisc on this product may not be recommended.









Region Number

The world is divided into 6 regions for DVD VIDEO discs. DVD VIDEO discs are assigned a region number to indicate which region they may be played back in. A disc cannot be played back on this unit unless the region number of the disc matches that of the unit. The region number for this unit is "2". Only discs whose region number includes "2" or "ALL" can be played back such as shown below.

Examples of DVD VIDEO labels which can be played back using this unit.



Marks of discs in this instruction manual

 DVD RAM	Allows operation with a DVD-RAM disc.	 VCD SVCD	Allows operation with a Video CD/Super Video CD (SVCD) disc.
 DVD R	Allows operation with a DVD-R disc.	 Audio CD	Allows operation with an Audio CD disc.
 DVD RW	Allows operation with a DVD-RW disc.	 MP3	Allows operation with a disc including MP3 files.
 DVD VIDEO	Allows operation with a DVD VIDEO disc.	 JPEG	Allows operation with a disc including JPEG files.

8 EN DISC INFORMATION

Recording Medium And Format

DVD-RAM

- Recording and erasing can be performed as many times as possible on a disc.
- Editing can be performed after recording, such as deleting unwanted parts.
- While recording, it is possible not only to start playback of a programme currently being recorded, but also to watch another programme previously recorded.

DVD-RW (VR mode)

- Recording and erasing can be performed as many times as possible on a disc.
- Editing can be performed after recording, such as deleting unwanted parts.

DVD-RW (Video mode)

- Can be played back on other DVD players after finalising.
- New recording can be performed by erasing all the data on a disc once played back.

DVD-R

- Can be played back on other DVD players after finalising.
- Suitable when keeping a recorded disc for a long time.

File Structure Of Discs

DVD VIDEO

Typically, DVD VIDEO discs are made up of larger units called "titles". Each title has a number (title number) that can be used to select desired titles. Titles are further divided into units called "chapters". Each chapter has a number (chapter number) that can also be used to select desired chapters. Note that some discs are not divided into titles and chapters.

When you record a programme on a DVD-RAM/RW (VR mode) disc

A single recording session results in a single title. In addition, chapter marks are automatically inserted when recording is paused. It is also possible to insert chapter marks at desired locations during playback. (pg. 25)

When you record a programme on a DVD-R/RW (Video mode) disc

A single recording session results in a single title. In addition, chapter marks are automatically inserted when recording is paused. It is possible to insert chapter marks at desired locations during playback. Once the disc has been finalised, these chapter marks are deleted and new chapter marks are assigned automatically approximately every 5 minutes.

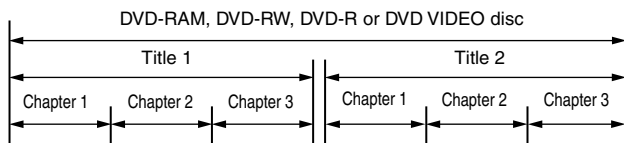

- In Video mode, even before finalising, it is impossible to perform editing operations other than changing the disc name and/or title names and deleting programmes and/or titles.
- After finalising, it is impossible to perform editing operations.

Audio CD/Video CD/SVCD

Typically, Audio CD discs are divided into separate tracks each containing one song. Each track is assigned a number. For example, the third track is Track 3. The same is true for Video CD/SVCD discs.

However, some discs are not divided into tracks.

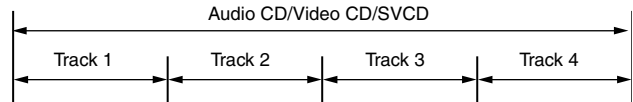

JPEG/MP3 Disc (CD-R/RW/ROM)

MP3/JPEG files put in directories nested in several levels on a disc will be organized as if they were put in single level directories (groups) by the MP3/JPEG Navigation of this unit. (pg. 52)

File structure of a disc before starting the MP3/JPEG Navigation

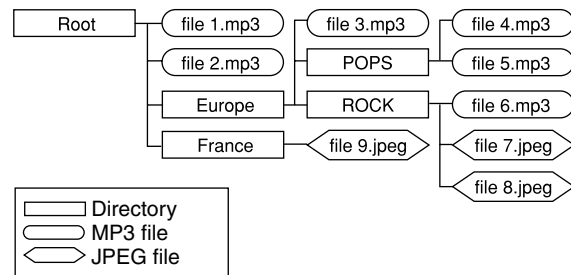

File structure of the disc after starting the MP3/JPEG Navigation

Files are automatically grouped as follows and displayed on the MP3/JPEG Navigation screen. Data is displayed in the alphabetical order of file name. Files are grouped based on roots.

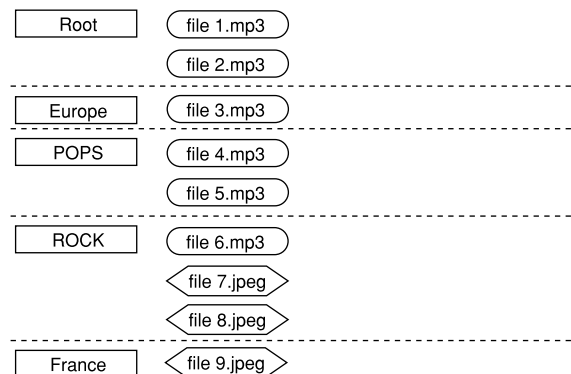

- This unit can recognise up to 9 hierarchies including directories and files. Also, it can recognise up to 250 files in each group, and up to 99 groups on a disc.





NOTES:

- Video CD/SVCD discs that support Playback Control (PBC)**
The contents of a disc are recorded into several hierarchies, and played back according to the instructions on the screen while navigating through the hierarchies. It is also possible to playback recorded tracks consecutively without activating the PBC function even when playing a PBC-compatible disc. (pg. 26)
- Regarding the contents recorded on discs**
Some files may not be played back depending on the file types and other factors.



DVD VIDEO Marks

Sometimes marks are printed on a DVD disc and/or on its packaging to indicate information regarding the contents and functions of the disc. Check the marks indicating the contents and functions of the disc. Note, however, that in some cases a disc may not include a mark even for a function it supports.

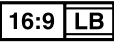
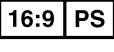
Marks related to video

	Number of subtitles		Number of angles
	Recorded under the standard 4:3 aspect ratio		Screen includes black bands at the top and the bottom of image which has a standard 4:3 aspect ratio (letter box)
	Video playback is in Wide video mode (16:9) on wide televisions, but in letter box on televisions with standard 4:3 aspect ratio.		
	Video playback is in Wide video mode (16:9) on wide televisions, but pan and scan is used on televisions with standard 4:3 aspect ratio (either the left or right side of the image is cut-out).		

Marks related to audio

	Number of audio tracks
	Dolby Digital mark It has been developed by Dolby Laboratories as a digital surround system.
	DTS (Digital Theater Systems) You can enjoy DTS audio if you connect an amplifier with a built-in DTS decoder to the DIGITAL OUT connector of the unit.

Placing A Disc

Opening the disc tray

Press  to open the disc tray.

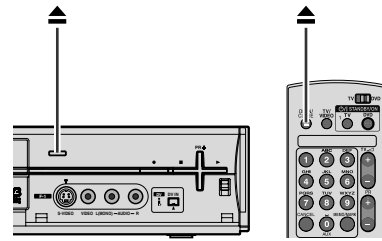

- Pressing the button again closes the disc tray.
- Use the button to open and close the disc tray.
- Do not block the disc tray with your hand while it is opening or closing as this may result in hardware failure.
- Do not place unplayable discs or any object other than a disc on the disc tray.
- Do not press down strongly on the disc tray or place any heavy objects on it.

Discs without cartridges

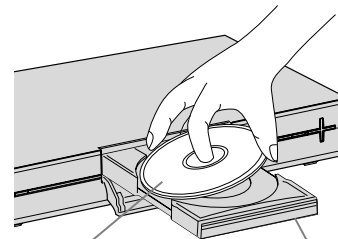

Label side facing up

Disc tray

Place the disc on the disc tray with the label side facing up. Since disc size changes depending on the disc to be played back, be sure to correctly align the disc with the grooves for its size. If the disc is not in its groove, it may be scratched or otherwise damaged. To insert an 8 cm disc, place it according to the inner groove.

DVD-RAM discs contained in cartridges

Double-sided discs:

Remove the disc from the cartridge. Align the disc with the grooves on the disc tray as shown in the illustration and insert with the side you wish to play back or record facing down. If you insert the disc with "Side A" facing down, programmes are recorded on side A.

Single-sided discs:

Remove the disc from the cartridge. Align the disc with the grooves on the disc tray as shown in the illustration and insert with the label side facing up.

10 EN *DISC INFORMATION*

Care And Handling Of Discs

How to handle discs

When handling a disc, do not touch the surface of the disc. Since discs are made of plastic, they are easily damaged. If a disc gets dirty, dusty, scratched or warped, the images and sound will not be picked up correctly, and such a disc may cause the unit to malfunction.

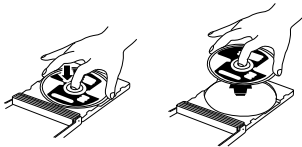

Label side:

Do not damage the label side, stick paper to or use any adhesives on its surface.

Recording side:

Make sure that discs are not scratched and dirty on the recording side before use. Scratches and dirt on the recording side of a disc may hinder proper playback and recording. Also be careful that a DVD-RAM disc may get scratched or dirty when removed from cartridge then put back in after use.

Storage:

Make sure that discs are kept in their cases. If discs are piled on top of one another without their protective cases, they can be damaged. Do not put discs in a location where they may be exposed to direct sunlight, or in a place where the humidity or temperature is high. Avoid leaving discs in your car!

Maintenance of discs:

If there are fingerprints or other dirt adhering to a disc, wipe with a soft dry cloth, moving from the centre outwards.

If a disc is difficult to clean, wipe with a cloth moistened with water. Never use record cleaners, petrol, alcohol or any anti-static agents.









CAUTION:

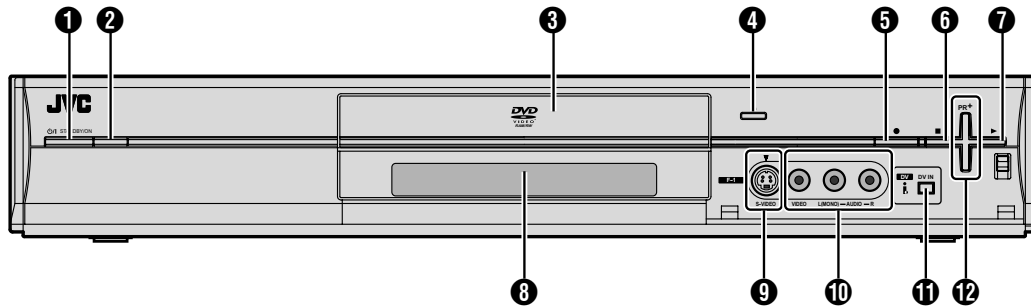

Sometimes during playback, noise may appear or images may be garbled. This is sometimes due to the disc. (It may not be up to industry standards.)

These symptoms are caused by the discs, not by the malfunction of the unit.

Front View



- 1 Standby/On Button (STANDBY/ON )
- 2 Infrared Beam Receiving Window
- 3 Disc tray
- 4 Eject Button () pg. 9
- 5 Record Button () pg. 34
- 6 Stop Button () pg. 22
- 7 Play Button () pg. 22

- 8 Front Display Panel pg. 12
- 9 S-video Input Connector [S-VIDEO] pg. 55
- 10 Video/Audio Input Connectors [VIDEO/AUDIO (L(MONO)/R)] pg. 55
- 11 DV Input connector [DV IN ()] pg. 53
- *  (i.Link) refers to the IEEE1394-1995 industry specification and extensions thereof. The  logo is used for products compliant with the i.Link standard.
- 12 Programme Buttons (PR +/-) pg. 34

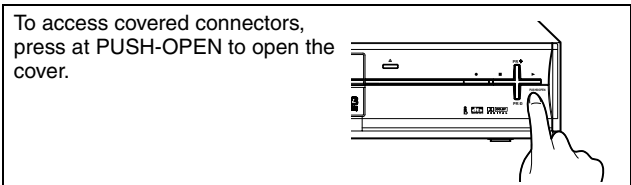

Rear View

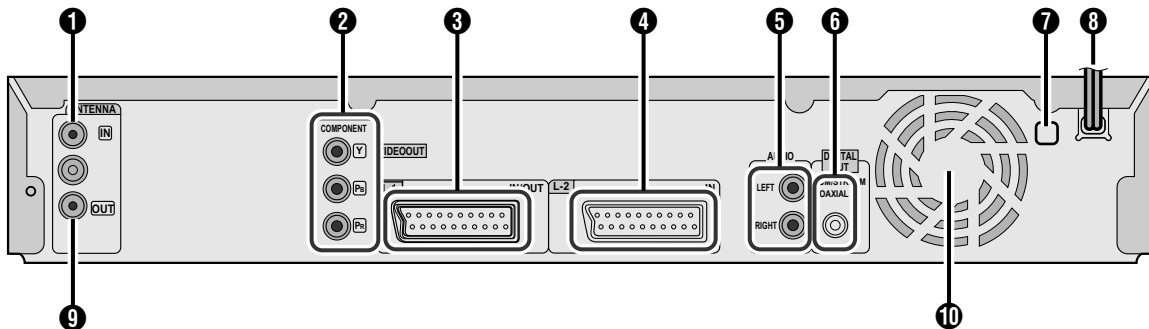

- 1 Antenna Input Connector [ANTENNA IN] pg. 16
- 2 Component Video Output Connectors [COMPONENT VIDEO OUT (Y/Pb/Pr)] pg. 16
- 3 L-1 Input/Output Connector [L-1 IN/OUT] pg. 16, 56, 57, 59, 60
- 4 L-2 Input Connector [L-2 IN] pg. 56, 57, 59, 60
- 5 Audio Output Connector [AUDIO OUT (LEFT/RIGHT)] pg. 16
- 6 Digital Audio Output Connector [DIGITAL OUT (COAXIAL)] pg. 54, 60
- 7 Region Number
- 8 AC Power Cord
- 9 Antenna Output Connector [ANTENNA OUT] pg. 16

- 10 Cooling Fan
 - This prevents the temperature from rising inside the unit. Do not remove it.
 - Install the unit so as not to block the area around the fan.
 - The unit may become hot when it is turned off, as the cooling fan on the rear of the unit is not activated. However, the cooling fan may be activated in the following cases;
 - In the Automatic Satellite Programme Recording standby mode (pg. 42)
 - If you connect the satellite receiver to [L-2 IN], and if “L-2 SELECT” is set to “SAT VIDEO/RGB” or “SAT S-VIDEO/RGB”. (pg. 58)
 - When “JUST CLOCK” is set to “ON” (pg. 66). (Set “JUST CLOCK” to “OFF” if you mind the noise of the fan.)

Front Display Panel

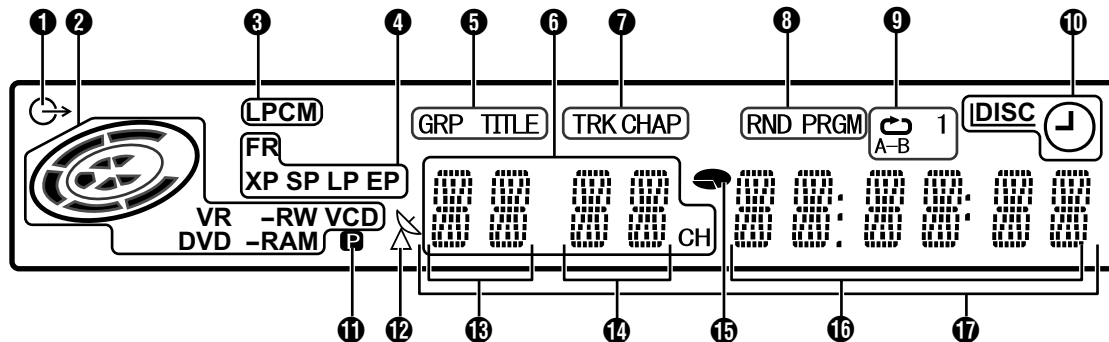

- 1 Video Indicator** (↻) [pg. 22](#)
Lights when video mode is selected by pressing TV/VIDEO ↻.
- 2 Disc Type Indicator**
When a disc is loaded, the type of the disc is indicated.
Disc Status Indicator
When a disc is running, the disc marks rotate.
During High-Speed Search:
Rotate faster than normal playback.
During Slow Motion:
Rotate slower than normal playback.
While recording:
Inner red ring lights in the same way as normal playback.
During Instant Timer Recording (ITR), inner red ring slowly blinks.
While paused:
Disc marks blink when either recording or playing back.
While stopped: Disc marks all light.
While resume stopped: Disc marks all blink.
While the disc tray opened: Disc marks all light out.
No disc on the disc tray: Disc marks all light out.
- VR Mode Indicator (VR)** [pg. 67](#)
Lights when a DVD-RW disc is formatted in VR mode.
- 3 Linear PCM Indicator (LPCM)**
Lights when "XP MODE REC AUDIO" is set to "LINEAR PCM" ([pg. 61](#)) for recording with DVD-RAM, DVD-R and DVD-RW discs, and when Linear PCM audio is played.
- 4 Recording Mode Indicator (XP/SP/LP/EP/FR)** [pg. 34](#)
Blinks when recording mode is being set.
While "FR" is blinking, the left 3 digits of the Multi Display (13 14) indicate setting values ranging from "60" to "480". After the value has been set, only "FR" lights.
- 5 Group/Title Indicator (GRP/TITLE)**
"GRP" or "TITLE" lights depending on a disc loaded while the left 2 digits of the Multi Display (13) indicate the numbers explained below.
"GRP": Total number of groups or group number being played back are displayed on the Multi Display.
"TITLE": Total number of titles or title number being played back are displayed on the Multi Display.
- 6 Channel Indicator**
Indicates the channel received.
- 7 Track/Chapter Indicator (TRK/CHAP)**
"TRK" or "CHAP" lights depending on a disc loaded while the 3rd and 4th digits from the left of the Multi Display (14) indicate the numbers explained below.
"TRK": Total number of tracks or track number being played back are displayed on the Multi Display.
"CHAP": Chapter number being played back are displayed on the Multi Display.
- 8 Random/Programme Playback Mode Indicator (RND/PRGM)** [pg. 33](#)
"RND": Lights when Random Playback mode is set.
"PROG": Lights when Programme Playback mode is set.
- 9 Repeat Mode Indicator** (↻/1/A-B) [pg. 30, 31](#)
Select Repeat Playback mode on the on-screen bar.
"↻": Whole disc is played back repeatedly.
"↻1": A single title/chapter/track is played back repeatedly.
"↻A-B": The selected part (A-B) is played back repeatedly.
No display: Repeat Playback mode is off.
- 10 DISC Timer Indicator** [pg. 39](#)
DISC: Lights when a disc set up for On-Disc Timer Programming is loaded.
⌚: Lights when timer recording other than On-Disc Timer Programming is on stand-by or being executed.
DISC ⌚: Lights when On-Disc Timer Programming is on stand-by or being executed.
⌚: Blinks quickly if you press **TIMER** ⌚ in the following cases;
• Disc is not loaded.
• Clock has not been set.
• There is no programme setting.
- 11 Video Output Indicator** (P) [pg. 63](#)
No display: Indicates that interlace mode is engaged.
P: Indicates that progressive mode is engaged.
(Example) P lights when video output mode is in progressive mode.
- 12 SAT** (⊖) [pg. 42](#)
Lights when the unit is in the Auto Satellite Programme Recording standby mode.
- 13 Group/Title Number Display**
- 14 Track/Chapter Number Display**
- 15 Remaining Time/Elapsed Time Display** [pg. 25, 35](#)
Lights when remaining time of DVD-RAM, DVD-R and DVD-RW discs is displayed, and lights out when elapsed time is displayed.
The right 6 digits of the Multi Display (16) indicate elapsed or remaining time of each track.
No display: Indicates elapsed time of the disc.
Displayed: Indicates remaining time of the disc.
- 16 Remaining Time/Elapsed Time Display** [pg. 25, 35](#)
- 17 Multi Display**
Displays clock, received channel, elapsed time, and remaining time.
Also displays status of the unit.

Remote Control

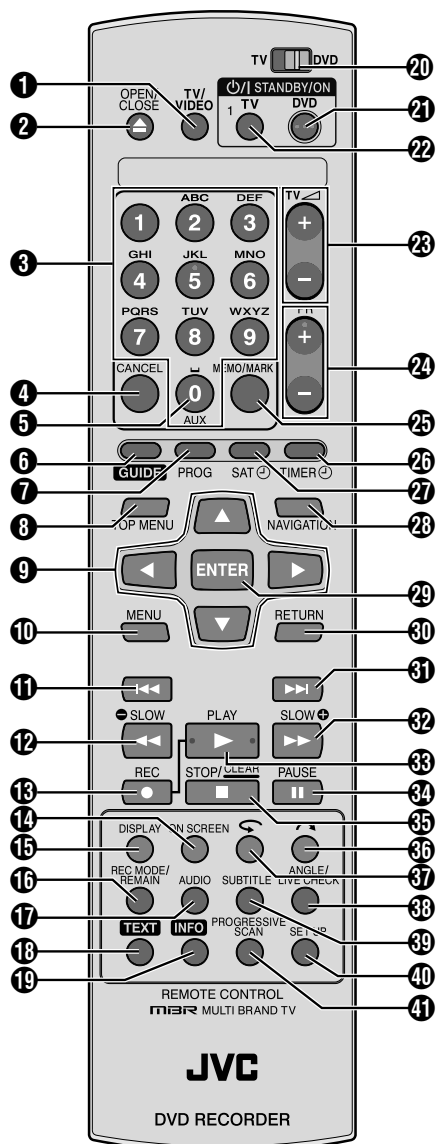

- 17 Audio Button (AUDIO) ☞ pg. 26
- 18 TEXT Button ☞ pg. 21
- 19 INFO Button ☞ pg. 21
- 20 TV/DVD Switch ☞ pg. 19
- 21 DVD STANDBY/ON Button (DVD ⏻/⏻) ☞ pg. 40
- 22 TV STANDBY/ON Button (TV ⏻/⏻)
For turning on/off the power of the TV.
- 23 TV Volume Buttons (TV ⏮ +/-)
For adjusting the volume of the TV.
- 24 Programme Buttons (PR +/-) ☞ pg. 34
- 25 Memo Button (MEMO) ☞ pg. 44
- Mark Button (MARK) ☞ pg. 25
- 26 Timer Button (TIMER ⏻) ☞ pg. 37, 38
- 27 Automatic Satellite Programme Recording Button (SAT ⏻)
☞ pg. 42
- 28 Navigation Button (NAVIGATION) ☞ pg. 43
- 29 Enter Button (ENTER)
- 30 Return Button (RETURN) ☞ pg. 26
- 31 Forward Skip Button (⏭) ☞ pg. 23, 26, 29, 33
- 32 Forward Search Button (⏮) ☞ pg. 23, 29
- Forward Slow Button (SLOW +) ☞ pg. 24
- 33 Play Button (▶) ☞ pg. 22, 23, 28
- 34 Pause Button (⏮) ☞ pg. 22, 29
- 35 Stop Button (■) ☞ pg. 22
- Clear Button (CLEAR) ☞ pg. 32
- 36 Skip Search Button (⏮) ☞ pg. 24, 29
- Colour Button (Blue Button) ☞ pg. 21
- 37 One Touch Replay Button (⏮) ☞ pg. 24, 29
- Colour Button (Yellow Button) ☞ pg. 21
- 38 Angle Button (ANGLE) ☞ pg. 25
- Live Check Button (LIVE CHECK) ☞ pg. 27, 29
- 39 Subtitle Button (SUBTITLE) ☞ pg. 21, 25
- 40 Set Up Button (SET UP) ☞ pg. 60
- 41 Progressive Scan Button (PROGRESSIVE SCAN) ☞ pg. 32, 63

How To Use

Before use, insert two AA size batteries into the remote control with the polarity (+ and -) matched correctly as indicated on the battery compartment or on the lid.

- Point the remote control toward the receiving window.
- The maximum operating distance of the remote control is about 8 m.

NOTE:

If the remote control doesn't work properly, remove its batteries, wait a short time, replace the batteries and then try again.

- 1 TV/VIDEO Button
For switching the input of a JVC TV.
- 2 Open/Close Button (▲)
- 3 Number Keys ☞ pg. 23, 32, 33
- 4 Cancel Button (CANCEL) ☞ pg. 33
- 5 Auxiliary Button (AUX) ☞ pg. 38
- 6 GUIDE Button ☞ pg. 37
- 7 Programme Button (PROG) ☞ pg. 38
- 8 Top Menu Button (TOP MENU) ☞ pg. 23
- 9 Selection Keys (▲▼◀▶)
- 10 Menu Button (MENU) ☞ pg. 23
- 11 Reverse Skip Button (◀◀) ☞ pg. 23, 26, 29, 33
- 12 Reverse Search Button (◀◀) ☞ pg. 23, 29
- Reverse Slow Button (SLOW -) ☞ pg. 24
- 13 Record Button (●) ☞ pg. 34, 35
- 14 On-Screen Button (ON SCREEN) ☞ pg. 30
- Colour Button (Green Button) ☞ pg. 21
- 15 Display Button (DISPLAY) ☞ pg. 25, 35
- Colour Button (Red Button) ☞ pg. 21
- 16 Recording Mode Button (REC MODE) ☞ pg. 34, 42
- Remain Button (REMAIN) ☞ pg. 25, 35

Check Contents

CHECK ALL THE CONTENTS SHOWN BELOW

DVD Video Recorder

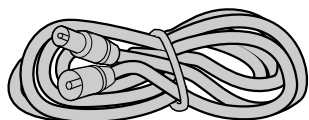
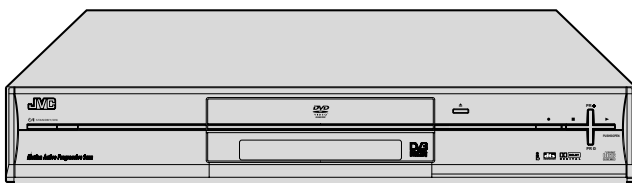

RF Cable

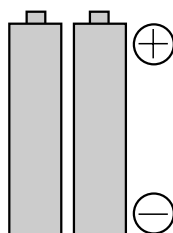

"AA" Batteries (x 2)

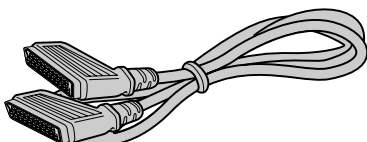

21-pin SCART Cable



Infrared Remote Control Unit

► You are now ready to install your unit. (pg. 16)

On-Screen Display

When **ON SCREEN** on the remote control is pressed, various operational indicators appear on the TV screen. To clear the operational indicators, press **ON SCREEN** twice.

When playing back a recorded title

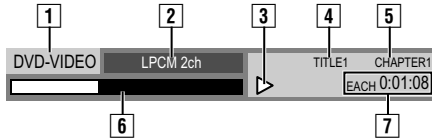

- 1 Disc type
- 2 Audio mode
- 3 Current status (playback)
- 4 Playback title number
- 5 Playback chapter number
- 6 Current playback point
- 7 Elapsed playing time

When recording

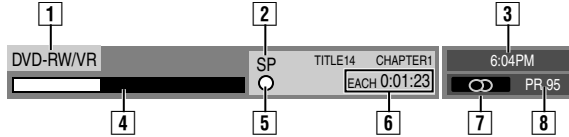

- 1 Disc type
- 2 Recording mode
- 3 Current time
- 4 Recording point
- 5 Current status (recording)
- 6 Elapsed recording time
- 7 Audio mode
- 8 Recording channel number

When pressing REC MODE:

(Appears for eight seconds.)



- 1 Recording mode
- 2 Remaining disc time for each recording speed

During Instant Timer Recording (ITR)

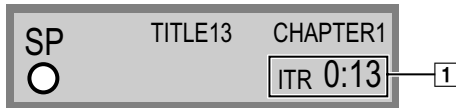

- 1 Record remaining time

When using Live Memory playback

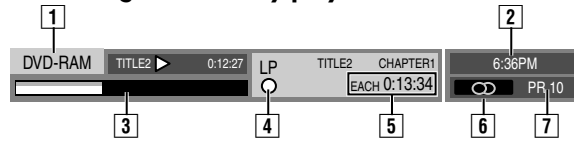

- 1 Disc type
- 2 Current time
- 3 Bar meter for recording/playback
- 4 Recording mode
- 5 Current playback time/Elapsed recording time
- 6 Audio mode
- 7 Recording channel number

DV Dubbing

When capturing images from the external DV equipment

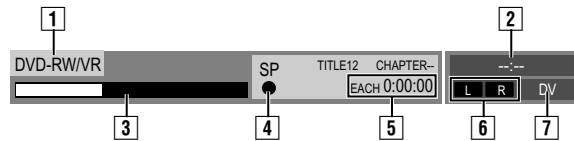

- 1 Disc type
- 2 Current time
- 3 Current recording point
- 4 Current status (recording)
- 5 Elapsed recording time
- 6 Sound mode
- 7 Recording channel (DV input)

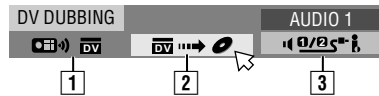

- 1 Displays when remote control is set to DV control mode.
- 2 Auto capture button
- 3 Sound monitor switch

16 EN **INSTALLING YOUR NEW UNIT**

Basic Connection

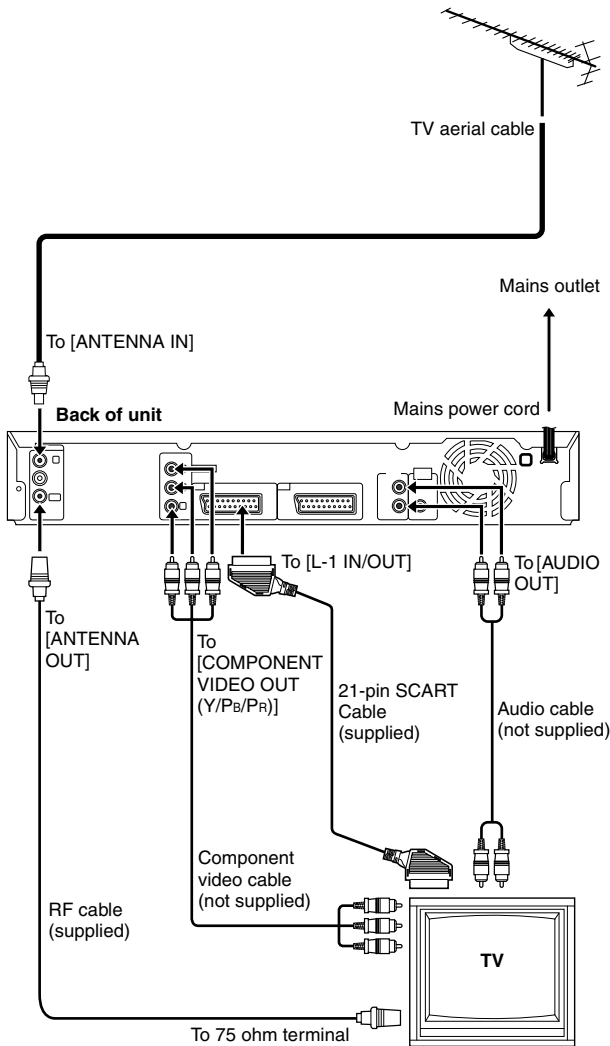

It's essential that your unit be properly connected.

ATTENTION:

- Your TV must have a 21-pin AV input connector (SCART) for the basic connection to the unit.
- Connect the AC plug only after all connections to the TV has been completed.

THESE STEPS MUST BE COMPLETED BEFORE ANY VIDEO OPERATION CAN BE PERFORMED.

- 1 Place the unit on a stable, horizontal surface.
- 2 Connect the unit to a TV depending on the TV and cables you use.

■ **Basic Connection**

To connect to a TV with 21-pin SCART input connector —

- 1 Disconnect the TV aerial cable from the TV.
- 2 Connect the TV aerial cable to the [ANTENNA IN] connector on the rear panel of the unit.
- 3 Connect the [ANTENNA OUT] connector on the rear panel of the unit and the TV's aerial connector with the supplied RF cable.
- 4 Connect the [L-1 IN/OUT] connector on the rear panel of the unit and the TV's 21-pin SCART connector with a supplied 21-pin SCART cable.
 - The [L-1 IN/OUT] connector accepts and delivers either a composite signal (regular video signal), Y/C signal or RGB signal.
 - Set your TV to the VIDEO, Y/C, or RGB mode according to the type of your TV's SCART connector.

■ **Component Video Connection**

To connect to TV's component video input connectors —

- 1 Perform steps 1 – 3 of "Basic Connection".
- 2 Connect the unit's [COMPONENT VIDEO OUT (Y/Pb/Pr)] connectors to the TV's component video input connectors.
- 3 Connect the unit's [AUDIO OUT] connectors to the TV's AUDIO input connectors.
 - You can obtain high-quality component video pictures.
 - If your TV is not stereo-capable, use the unit's [AUDIO OUT] connectors to connect to an audio amplifier for Hi-Fi stereo sound reproduction.
 - By using the component video connection, you can view the images in the progressive mode. For switching to the progressive mode, refer to "Scan Mode Set" (pg. 63).

NOTE:

Select an appropriate option of "L-1 OUTPUT" as follows (pg. 57):

When your TV's SCART connector accepts:	Set "L-1 OUTPUT" to:
Composite signals	"SCART VIDEO"
Y/C signal (separated luminance (brightness) and chrominance (colour) signals)	"SCART S-VIDEO"
RGB signal	"SCART RGB"
Component video signal	"COMPONENT"

- When the setting selected is not in accordance with the TV connected and depending on the type of appliance connected to the unit, the correct picture will not appear.
- This unit only supports 625i/625p PAL signals. Other modes are not receivable.

- 3 Plug the end of the mains power cord into a mains outlet.
 - "PLEASE" and "WAIT" blink alternately on the front display panel when the AC plug of the mains power cord is connected into a mains outlet. And it takes approximately 30 seconds for the unit to be turned on. This is not a malfunction.

If you possess a satellite receiver, refer to "Connecting To A Satellite Receiver" as well. (pg. 59)

Auto Set Up

Auto Channel Set/Auto Clock Set

After the **⏻/I** button on the unit (or **DVD ⏻/I** on the remote control) is pressed for the first time to turn on the unit, the Auto Set Up function sets the tuner channels and clock automatically.

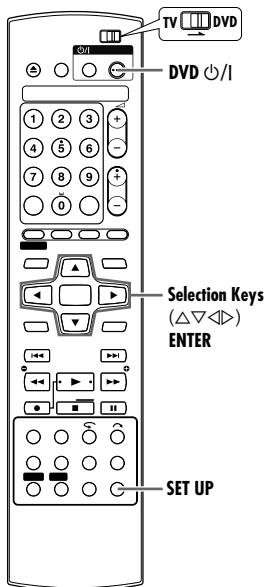
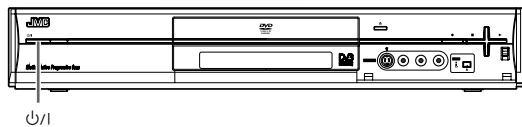

ATTENTION:
 Once you have performed "Auto Set Up", even if the unit's memory backup has expired, all the stored stations and their channel numbers remain in the unit's memory and the unit will not perform "Auto Set Up" again. Perform clock set manually if the clock has not been set correctly by "Auto Set Up". (pg. 66)
 If you have moved to a different area, perform each setting as required.
 • Tuner setting (pg. 64)
 • Clock setting (pg. 66)
 If a new station starts broadcasting in your area, perform tuner setting. (pg. 64)

NOTES:
 • If there is a power cut, or if you press **⏻/I** or **SET UP** while "Auto Set Up" is in progress, "Auto Set Up" will be interrupted. Be sure to turn off the unit power once and try again from step 1.
 • Auto Clock Set may not function properly depending on the reception condition.

After "Auto Set Up" is completed, perform "Monitor Set" on page 19.

Before starting, make sure of the following:

- The TV aerial cable should be connected to the unit.
- The unit's mains power cord should be connected to a mains outlet.
- Turn on the TV and select an input mode such as EXT1.
- Slide the **TV/DVD** switch to **DVD**.

- 1 Press **⏻/I** on the unit or **DVD ⏻/I** on the remote control to turn on the unit. The **AUTO SEARCH** display appears on the TV screen.
- 2 Press **selection keys** to select "AUTO SEARCH", then press **ENTER**.
 - Auto Channel Set for digital terrestrial broadcast (DVB-T) is performed and the received digital terrestrial broadcast (DVB-T) channels are stored automatically.
 - When Auto Channel Set is completed, a broadcast receiving screen appears.

ATTENTION:
 "AUTO" blinks on the front display panel; do NOT press any button on the unit or remote control until the front display panel shows clock time, "1" or "--:--" as illustrated on page 18.

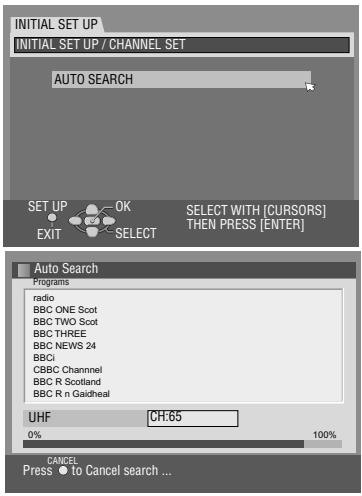

Language

- Turn on the unit.
- Turn on the TV and select an input mode such as EXT1.
- Slide the TV/DVD switch to DVD.

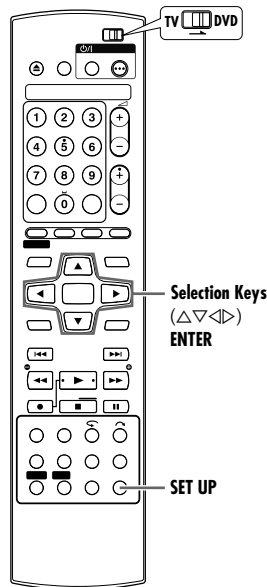

Menu/Audio/Subtitle Language Set

Some DVD discs contain the DVD menu display, audio and subtitles in multiple languages. With these discs, you can set the default language as you like.

- The procedure shows how to set "MENU LANGUAGE" as an example.
- 1 Press **SET UP** to access the Main Menu screen.
 - 2 Press **selection keys** to select "DVD SET UP", then press **ENTER**.
 - 3 Press **selection keys** to select "LANGUAGE SET", then press **ENTER**.
 - 4 Press **selection keys** to select "MENU LANGUAGE", then press **ENTER**.
 - 5 Press **selection keys** to select your desired language, then press **ENTER**.
 - See "Language Code List" (pg. 72).
 - 6 Press **SET UP** to complete the setting.

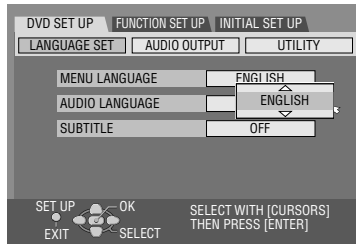

NOTE:

When the selected language is not available on the disc, the disc's default menu language is played back.

Monitor Set

You can select the monitor type depending on the TV used when you play back DVD VIDEO discs recorded for wide-screen TVs.

- 1 Press **SET UP** to access the Main Menu screen.
- 2 Press **selection keys** to select "FUNCTION SET UP", then press **ENTER**.
- 3 Press **selection keys** to select "VIDEO IN/OUT", then press **ENTER**.
- 4 Press **selection keys** to select "MONITOR TYPE", then press **ENTER**.
- 5 Press **selection keys** to select the desired setting, then press **ENTER**.
- 6 Press **SET UP** to complete the setting.

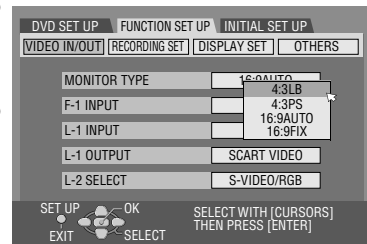
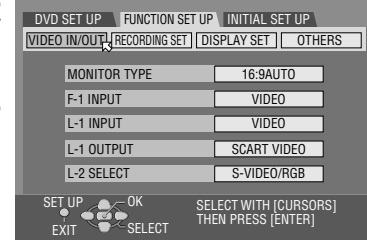

* The **boldface** settings below indicate the settings at your purchase.

MONITOR TYPE — 4:3LB / 4:3PS / **16:9AUTO** / 16:9FIX

4:3LB (Letter Box conversion):
Select this when the aspect ratio of your TV is 4:3 (conventional TV). While viewing a wide screen picture, the black bars appear on the top and the bottom of the screen.

• When recording a 16:9 (wide TV) programme, the picture displayed on the screen will be vertically stretched and black bars do not appear on the top and the bottom. However, the picture will be displayed in its normal 16:9 aspect ratio with the top and bottom black bars when the programme is played back.

4:3PS (Pan&Scan):
Select this when the aspect ratio of your TV is 4:3 (conventional TV). While viewing a wide screen picture, the black bars do not appear; however, the left and right edges of the pictures will not be shown on the screen.

16:9AUTO (Wide television conversion):
Select this when the aspect ratio of your TV is 16:9 (wide TV).

16:9FIX (Wide television conversion):
Select this when the aspect ratio of your TV is fixed to 16:9 (wide TV). The unit automatically adjusts the screen width of the output signal correctly when playing back a picture whose aspect ratio is 4:3.

Pan&Scan/Letter Box

In general, DVD VIDEO disc are produced for a wide-screen TV with 16:9 aspect ratio. Material with this ratio will not fit to a TV with 4:3 aspect ratio. There are two styles to display the image, "Pan&Scan" (PS) and "Letter Box" (LB).

Pan&Scan

The right and left side of the image are cut off. The image fills the screen.

- The picture will be shown in the "4:3LB" mode depending on the disc even if the "4:3PS" mode is selected.



Letter Box

Black bands appear at the top and bottom of the image. The image itself appears in 16:9 aspect ratio.



20 EN INITIAL SETTINGS

Setting DTV

You can set the language and channel selection method when watching TV programmes and performing recording with this unit.

- Turn on the unit.
- Turn on the TV and select an input mode such as EXT1.
- Slide the TV/DVD switch to DVD.

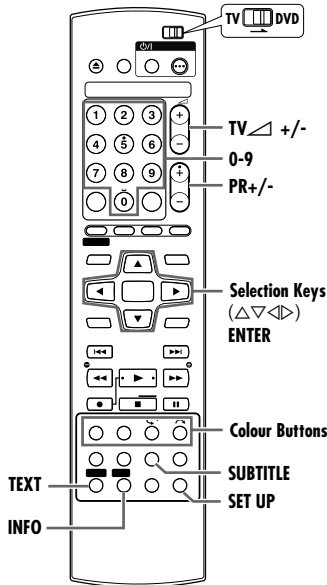

4 Press **selection keys** to select "FAVOURITE MODE", then press **ENTER**.

NOTE:

If "Favourites" under "EDIT CHANNEL LIST" (pg. 65) has not been set, "FAVOURITE MODE" cannot be set to "ON". A warning message "PLEASE SET A FAVOURITE PR IN EDIT PR LIST FIRST" will be displayed.

5 Press **selection keys** to select "ON" or "OFF", then press **ENTER**.

ON:

Only channels set in "Favourites" with "SETTING FAVOURITE" (pg. 65) are selected using **PR +/-**.

OFF:

All the channels stored on this unit are selected.

6 Press **SET UP** to complete the setting.

Setting The Subtitle Language

Some TV programmes contain subtitles. It is possible to set the subtitle language when recording these programmes.

1 Press **SET UP** to access the Main Menu screen.

2 Press **selection keys** to select "INITIAL SET UP", then press **ENTER**.

3 Press **selection keys** to select "DTV SETTING", then press **ENTER**.

4 Press **selection keys** to select "RECORDING SUBTITLE", then press **ENTER**.

5 Press **selection keys** to select your desired language, then press **ENTER**.

6 Press **SET UP** to complete the setting.

NOTE:

If the language that has been set is not available in a broadcast, the language that is available will be selected.

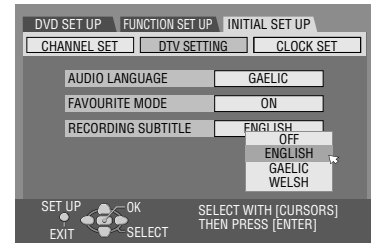

Setting The Audio Language

Set the audio language when watching TV programmes.

1 Press **SET UP** to access the Main Menu screen.

2 Press **selection keys** to select "INITIAL SET UP", then press **ENTER**.

3 Press **selection keys** to select "DTV SETTING", then press **ENTER**.

4 Press **selection keys** to select "AUDIO LANGUAGE", then press **ENTER**.

5 Press **selection keys** to select your desired language, then press **ENTER**.

6 Press **SET UP** to complete the setting.

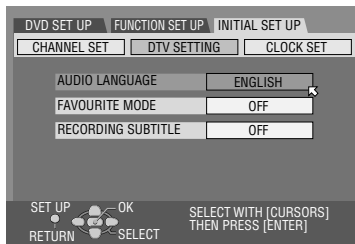

NOTE:

If the language that has been set is not available in a broadcast, the language that is available will be selected.

Setting Favourite Mode

You can select to tune to your frequently watched channels with this setting.

1 Press **SET UP** to access the Main Menu screen.

2 Press **selection keys** to select "INITIAL SET UP", then press **ENTER**.

3 Press **selection keys** to select "DTV SETTING", then press **ENTER**.

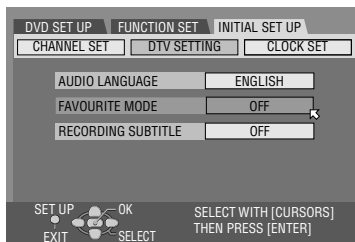

Basic Operation (TV)

ATTENTION:

- It is not possible to watch pay-TV with this unit.
- While watching Digital terrestrial broadcast (DVB-T), **ON SCREEN** and **DISPLAY** buttons function as **colour buttons**. To operate these buttons as **ON SCREEN** and **DISPLAY** buttons, press **INFO** to display the information bar.

Selecting The Desired Channel

Press **PR +/-** or the **number keys** to select the channel you wish to watch.

- When using the **number keys**, enter the PR number directly.
PR 6 → Press 6.
PR 6 1 → Press 6 and 1 in sequence.
PR 1 2 2 → Press 1, 2 then 2 in sequence.
- When using **PR +/-**, press +/- repeatedly to select the desired channel.
 If "AUTO SEARCH" (pg. 17) is performed and channels are being registered, only those registered channels are selected.
- The information bar is displayed when changing the channels using **PR +/-**.

Checking Channel Information and Clock Time

Press **INFO** when the channel is being selected.

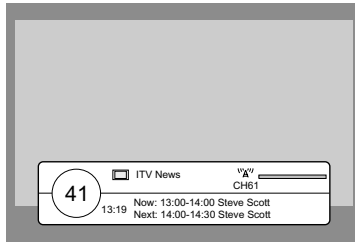

- The information bar appears.

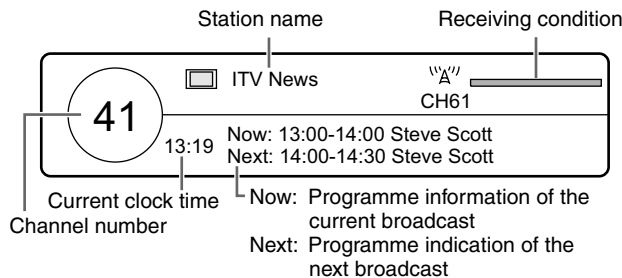

- To clear the information bar, press **INFO** again.
- While the information bar is displayed, the **colour buttons** on the remote control does not function as **colour buttons** with scrolling function and so on.

Displaying The Subtitles

Press **SUBTITLE** when watching a programme.

- If the programme contains subtitles, the subtitles will be displayed on the TV screen.
- When the unit is turned on, the subtitles set in "RECORDING SUBTITLE" (pg. 20) is displayed.
- When **SUBTITLE** on the remote control is pressed, a window (SUB-GUI) with the current selected setting is superimposed on the TV screen for 5 seconds.
- While SUB-GUI is displayed, you can change the setting using <|>. (Selectable settings: OFF/ENG.(ENGLISH)/GAEL.(GAELIC)/WELSH)
 Press **ENTER** to confirm the changes after changing. The **SUBTITLE** button is disabled when making changes.
- If the **colour buttons** or **TEXT** is pressed while the subtitles are displayed, the subtitle display is switched off and SUB-GUI displays "OFF" for 5 seconds.
- During recording, the subtitles set in "RECORDING SUBTITLE" (pg. 20) being displayed will be recorded. The subtitles of the recorded programme will be the same as that displayed during recording.
- If recording starts while the subtitles are displayed, the subtitles will also be recorded. If you do not want subtitles on the recorded image, perform recording after clearing the subtitles.
- The **SUBTITLE** button functions only after the unit has been turned on and a TV programme is displayed on the TV screen. However, when **SET UP** is pressed to access the Main Menu, the subtitles will not be displayed.

Viewing Teletext Broadcast

ATTENTION:

The **DISPLAY** button and **ON SCREEN** button function of the respective red and green button on the remote control are given priority while the On-screen bar is displayed.

- 1 Press **TEXT** when the channel is being selected.
 - The teletext menu screen appears.
- 2 Following the instructions on the screen, select the item with **△▽◀▶**, then press **ENTER**.

- The text information of the selected item (for example, news) is displayed.
- The subtitles disappear if **TEXT** is pressed while the subtitles are displayed.
- The **colour buttons** can also be used to select the items.

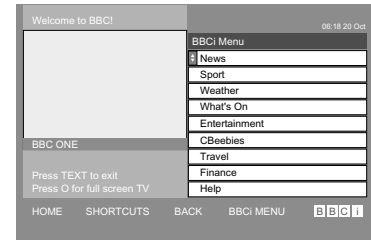

- When recording is performed while viewing the teletext, only the images of the programme are recorded. The text section will not appear. In this case, if the subtitle display is set to other than off in "RECORDING SUBTITLE" (pg. 20), some programmes will display the subtitles in place of the teletext menu. The subtitles displayed will be recorded. If you do not want subtitles on the recorded image, perform recording after clearing the subtitles.

Adjusting The Volume

Press **TV** **△ +/-** to adjust accordingly.

- + : To increase the volume.
- : To turn down the volume.

22 EN BASIC OPERATIONS ON DVD DECK

Basic Playback



- Turn on the unit.
- Turn on the TV and select an input mode such as EXT1.
- Slide the TV/DVD switch to DVD.

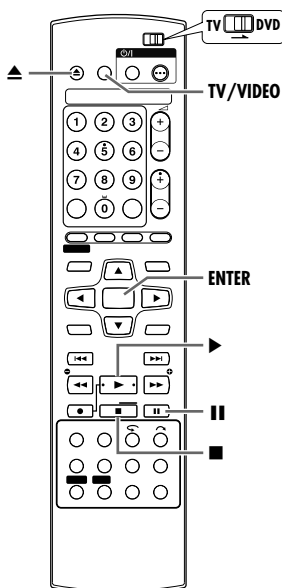

- ATTENTION:**
- It takes approximately 30 seconds to read a disc depending on the type and condition of the disc since this unit is multi-disc compatible (DVD-RAM, DVD-RW, DVD-R). It may even take several minutes when a disc is dirty, scratched or warped.
 - It may take a few seconds to start playback. This is not a malfunction.
 - Forward/reverse high-speed search and other operations cannot be performed while playback is stopped.

To play back an MP3/JPEG disc, see “Playback With MP3/JPEG Navigation” (pg. 52).

- 1** Load a disc.
 - For details, refer to “Placing A Disc” (pg. 9).
 - Pressing **▲** also closes the disc tray.
 - Playback begins automatically if an auto-playback DVD disc is loaded.
- 2** Press **▶** to start playback.
 - If you load a DVD disc whose region code does not match the unit, “REGION CODE ERROR CHECK DISC” appears on the TV screen. For details, refer to “Region Number” (pg. 7).
 - With Video CD/SVCD discs with PBC control or some DVD discs, the menu display may appear on the TV screen after starting playback. In this case, select an item which you want to play back from the menu. For details, refer to “Playback Control (PBC) Function” (pg. 26) or “Locating A Desired Scene Using The DVD Menu” (pg. 23).
 - The Library Database Navigation also enables you to search and scan the beginning of the desired titles. (pg. 44)
- 3** Press **||** to pause playback.
 - To resume normal playback, press **▶**.
- 4** Press **■** to stop playback.
 - When a recordable disc is played, playback stops and a programme received with the unit’s tuner resumes on the TV screen.
 - When a playback-only disc is played, playback stops and the TV screen becomes all blue when you press **■**. Pressing **■** again resumes a programme received with the unit’s tuner.
 - If **▲** is pressed during playback, playback stops, then the disc tray opens.

NOTE:
When the Library Database Navigation screen appears, choose a thumbnail image of the desired title on the TV screen, then press **ENTER**. (pg. 44)

Each time you press **TV/VIDEO**, the unit switches between video mode (or connected external mode) and TV mode. (pg. 13)
“**⊙**” lights on the front display panel when video mode is selected. (pg. 12)

Playback Features

- Turn on the unit.
- Turn on the TV and select an input mode such as EXT1.
- Slide the TV/DVD switch to DVD.

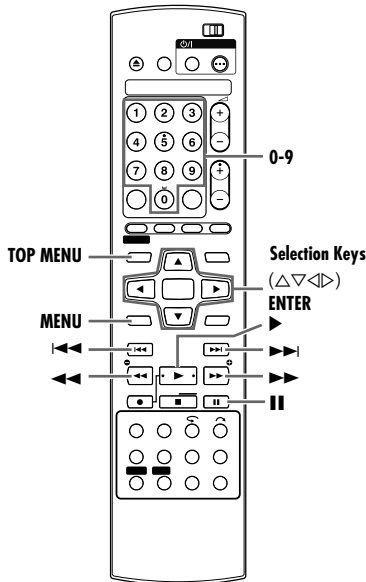

Locating A Desired Scene Using The DVD Menu



DVD VIDEO discs may have top menu and disc menu.

Top menu

DVD discs generally have their own menus which show the disc contents. These menus contain various items such as titles of a movie, names of songs, or artist information. You can locate a desired scene by using the top menu displayed on the TV screen. Press **TOP MENU** to access the top menu.

Disc menu

Disc menus include playback data (angle menu, subtitle menu, etc.) specific to each title. Press **MENU** to access the disc menu.

1 Press **TOP MENU** or **MENU** to access the DVD menu.

2 Press **selection keys** to select the desired title, then press **ENTER**. The playback starts.

- It may be possible to select the desired item using the **number keys** depending on the menu display.

Example:

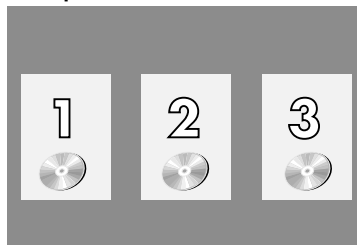

NOTE:

When "O" appears on the TV screen in step 1, the disc does not have a top menu or disc menu.

Locating The Start Point Of The Item Or Skip The Item



Press **◀◀** or **▶▶** during playback.

- Pressing **▶▶** locates the start point of the title (or track) or skips to the marked point in the forward direction, then resumes playback.
- Pressing **◀◀** locates the start point of the title (or track) or skips to the marked point in the reverse direction, then resumes playback.

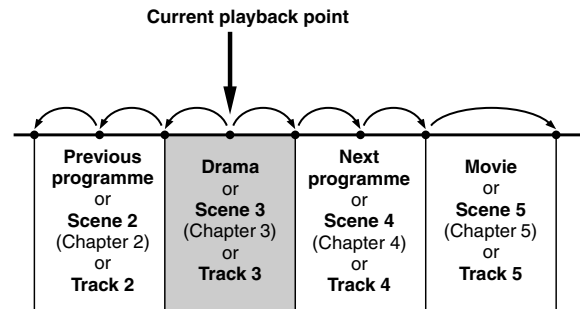

Reverse ← **◀◀** **▶▶** → Forward

- : marked points (pg. 25)

Variable Speed Search



During playback, press **▶▶** for forward variable speed search, or **◀◀** for reverse variable speed search.

- Each press of the button increases the search speed for each direction.
- To resume normal playback, press **▶**.

OR

During playback, press and hold **▶▶** for 2 or more seconds for forward variable speed search, or press and hold **◀◀** for 2 or more seconds for reverse variable speed search.

- Releasing the button resumes normal playback.

Still Picture/Frame-By-Frame Playback



1 Press **||** to pause during playback.

2 Each press of **||** advances a frame.

- Each press of **||** advances the still picture frame by frame.

OR

Press **<** or **>** to activate frame-by-frame playback.

- Each press of **<** or **>** reverses/advances the still picture frame by frame.
- Frame-by-frame playback for reverse direction cannot be performed with Video CD/SVCD discs.
- To resume normal playback, press **▶**.

24 EN BASIC OPERATIONS ON DVD DECK

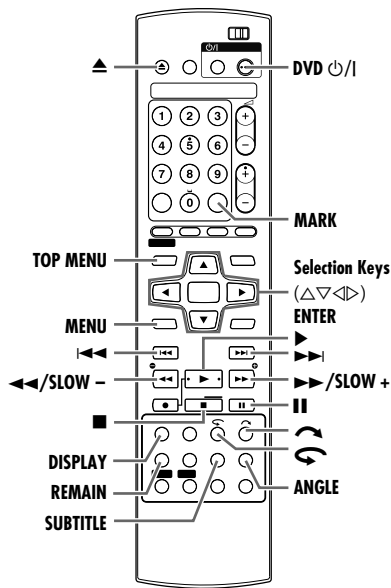

Slow Motion



- 1 Press **II** to pause during playback.
- 2 Press **SLOW -** (◀◀) or **SLOW +** (▶▶).
 - Each press of **SLOW -** (◀◀) or **SLOW +** (▶▶) increases the slow motion speed for each direction.
 - Slow motion for reverse direction cannot be performed with Video CD/SVCD discs.

OR

- Press and hold **◀◀** or **▶▶** for 2 or more seconds.
- Releasing the button resumes normal playback.

Skip Search



- Press **↶** during playback.
- Each press initiates an approximately 30 second period of fast-motion playback. Normal playback resumes automatically.
 - This function is not possible when playing back a Video CD using the PBC function.

One Touch Replay



- You can move back the playback position slightly.
- Press **↶**.
- Each press skips back for approximately 7 seconds and resumes playback.
 - Pressing while paused skips back for approximately 7 seconds and resumes pause.
 - This function is not possible when playing back a Video CD using the PBC function.

Resume Function



It is possible to memorise the position where you stop playback and resume playback from that position.

- Be sure to set “RESUME” to “ON” or “DISC RESUME”. (☞ pg. 61)

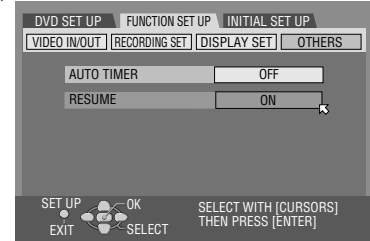

ATTENTION:

When a playback-only disc is played, pressing **■** once results in a blue screen. To perform Resume Function with these discs, follow the procedures as described below under the blue screen condition.

- 1 Press **■** during playback to memorise a resume point.
 - The unit enters Resume Stop mode and memorises the position where you have stopped playback as a resume point. (The inside of the disc status indicator on the front display panel blinks while memorising.)
 - The unit retains a memory of the resume points of the last 30 discs played back, even though they have been ejected if “RESUME” is set to “DISC RESUME”. (☞ pg. 61)
 - To clear the resume points: (The inside of the disc status indicator stops blinking and lights.)
 - When “RESUME” is set to “ON”:**
 - Press **DVD On/Off** to turn off the unit.
 - Press **▲** to take out the disc.
 - Press **■** in stop mode.
 - Press **TOP MENU** to display the top menu, then start playback by selecting an item, etc.
 - Press **MENU** to display the disc menu, then start playback by selecting an item, etc.
 - When “RESUME” is set to “DISC RESUME”:**
 - “RESUME” must be set to “OFF”. (☞ pg. 61)
 - Press **■** in stop mode.
 - Press **TOP MENU** to display the top menu, then start playback by selecting an item, etc.
 - Press **MENU** to display the disc menu, then start playback by selecting an item, etc.

- 2 Press **▶** in stop mode to resume playback. The unit starts playback from the resume point.

NOTES:

- “DISC RESUME” setting works on DVD VIDEO, VCD, SVCD and finalised DVD-R/DVD-RW (Video mode) discs. For other types of discs, the function under “ON” setting will be applied even if “RESUME” is set to “DISC RESUME”. (☞ pg. 61)
- If you stop the playback of a disc for which a resume point has already been memorised, the memory will be updated with the new resume point.
- After the unit has memorised the resume points for 30 discs, remembering a new resume point will cause the unit to delete the oldest memorised point. Stopping playback of a disc for which a resume point is already stored may change the order in which the points are stored. This may potentially change the order in which points are deleted.
- When the unit memorises a resume point for a disc, it also remembers audio language, subtitle and angle settings.
- This function may not work for some Video CD/SVCDs.
- When “RESUME” is changed to “ON” or “OFF” (☞ pg. 61), resume points of the discs memorised with “RESUME” set to “DISC RESUME” will be cleared.
- Resume points are memorised for each side of a double-sided disc.

Marking Positions To Play Back Again Later



It is possible to mark positions (up to 999 points) where you want to play back once again later, and start playback from a marked position.

To mark positions:

During playback, press **MARK** at positions you want to mark.

- “MARK” is displayed on the TV screen. You can easily locate the marked positions using **◀◀** or **▶▶** when you play back the disc.

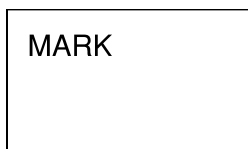

To delete the marked positions:

While paused, press **◀◀** or **▶▶** to locate a marked position you want to delete, then press **MARK**.

- Crossed “MARK” appears on the TV screen, and the marked position is deleted.



NOTES:

- When a DVD-R/RW (Video mode) disc is finalised, marked points that are marked at the desired locations during playback are deleted and new marks are assigned automatically approximately every 5 minutes.
- If **MARK** is pressed when playing back a disc that does not allow marks to be inserted, “⊙” appears on the TV screen.

Checking The Time Information



You can check time information of a disc on the front display panel and the TV screen.

Each time you press **DISPLAY**, the display changes as follows:

■ DVD-RAM/DVD-R/DVD-RW

During recording or playback

Clock time → Current title elapsed time → Disc remaining time → (back to the beginning)

- The clock time is displayed on the front display panel only.
- The clock time and disc remaining time will not be displayed when playing back finalised DVD-R/RW discs.

During recording/playback or in stop mode

- It is possible to check disc remaining time according to recording modes also by pressing **REMAIN**.
- In FR mode, it is possible to set recording time in detail. While the recording mode and the disc remaining time are displayed by pressing **REMAIN**, press **selection keys** to select “FR”, then select the desired recording time. (pg. 36)
- It is not possible to switch the recording mode during playback or while recording.

■ Video CD/SVCD/Audio CD

During playback or in stop mode

Current track elapsed time → Current track remaining time → Total elapsed time → Total remaining time → (back to the beginning)

NOTE:

When a PBC-compatible Video CD/SVCD disc is loaded, deactivate the PBC function. (pg. 26)

Angle Selection



You can enjoy a variety of scene angles if a DVD VIDEO disc contains “multi-angle” parts, where the same scene was shot from different angles.

If the disc contains “multi-angle” parts, “” appears on the TV screen at the beginning of the “multi-angle” part.

1 Press **ANGLE** during playback.

The angle selection display appears on the TV screen.



2 Press **ANGLE** or the **selection keys** to select your desired angle.

When 3 scene angles are contained.

- Each time you press **ANGLE** or the **selection keys**, the angle changes.
- When “⊙” appears on the TV screen, the current scene is not recorded from multiple angles. In addition, some discs prohibit angle selection.
- To clear the angle selection display, press **ENTER**. In addition, the angle selection display disappears automatically if no operation is done for 5 seconds.

Subtitle Selection



Some DVD VIDEO discs contain more than one subtitle language, from among which you can choose the desired subtitle language. “” appears on the TV screen at the beginning of the part where more than one subtitle language are recorded.

1 Press **SUBTITLE** during playback. The subtitle selection display appears on the TV screen.

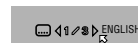

When 3 subtitle languages are contained.

- Each time you press **SUBTITLE**, the subtitle display is switched on and off.

2 Press **selection keys** to select your desired language.

- To clear the subtitle selection display, press **ENTER**.

NOTES:

- For disc that does not contain subtitle language, the number of selectable languages will not be displayed. “-/-” appears on the TV screen.
- When the subtitle language won't be changed with the procedure above, change the subtitle on a disc menu displayed by pressing **MENU**.

26 EN BASIC OPERATIONS ON DVD DECK

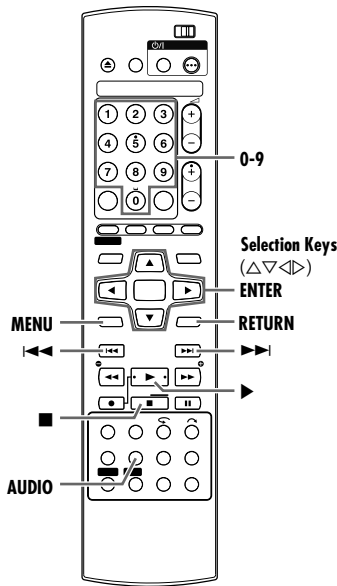

Audio Channel Selection



During disc playback, you can choose the desired audio channel.

- When "SUPERIMPOSE" is set to "AUTO", you can confirm on the TV screen the audio channel you have chosen. (pg. 61)
- Each time you press **AUDIO**, the audio channel changes.



TRACK	USE
On-Screen Display	
	For stereo discs
	For audio of left channel
	For audio of right channel

Audio Language/Sound Selection



Some DVD VIDEO discs contain the multiple audio language or sound. You can select the desired audio language or sound. For some Video CD/SVCD discs, you can switch the audio channel to choose Karaoke either with or without the vocal.

- 1 Press **AUDIO** during playback. The Audio Language/Sound selection display appears on the TV screen. **Example: DVD VIDEO**



- 2 Press **AUDIO** or the **selection keys** to select your desired audio language/sound.
 - Each time you press **AUDIO** or the **selection keys**, the audio language/sound changes.
 - To clear the Audio Language/Sound selection display, press **ENTER**.

When 3 audio languages are contained.

NOTES:

- When "⊙" appears on the TV screen, no audio language is recorded.
- When the audio language won't be changed with the procedure above, change the audio on a disc menu displayed by pressing **MENU**.
- Pressing **AUDIO** to select the audio language/sound is only possible during playback. It is not possible to select by pressing **AUDIO** in stop mode. However, you can select the desired audio language/sound from the setup menu while in stop mode.

Playback Control (PBC) Function



Some Video CD/SVCD discs support the PBC function. PBC is an abbreviation of "Play Back Control". A Video CD/SVCD disc recorded with PBC has its own menus, such as a list of the songs on the disc. You can locate a specific scene by using the menu.

- 1 Press **▶** in stop mode. The PBC menu appears.
- 2 Press the **number keys** to enter the number of the desired scene, then press **ENTER**. The unit starts playback of the selected item.
 - "PBC" is displayed on the front display panel.
 - When "NEXT" or "PREVIOUS" appears on the TV screen: Pressing **▶▶** advances to the next page. Pressing **◀◀** returns to the previous page.
 - You can return to the menu by pressing **RETURN**.
 - The method of the operation is different depending on the disc.

NOTES:

- If you want to play back a PBC-compatible Video CD/SVCD disc without activating the PBC function, start playback in stop mode by using the **number keys**, instead of the **▶** button, to choose the track, then press **ENTER**.
- To activate the PBC function when a PBC-compatible Video CD/SVCD disc is being played back without the PBC function, press **■** and clear the resume points (pg. 24), then press **▶**.

Live Memory Playback

- DVD RAM
- DVD R
- DVD RW
- DVD VIDEO
- VCD SVCD
- Audio CD
- MP3
- JPEG

You can watch a recorded portion of a programme even before recording ends (Live Memory Playback), or watch other programmes (Simultaneous Recording and Playback) while continuing to record onto the DVD-RAM disc.

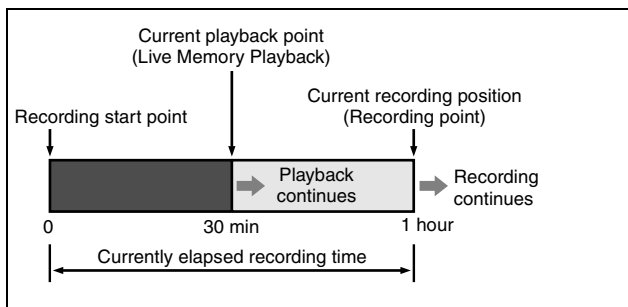
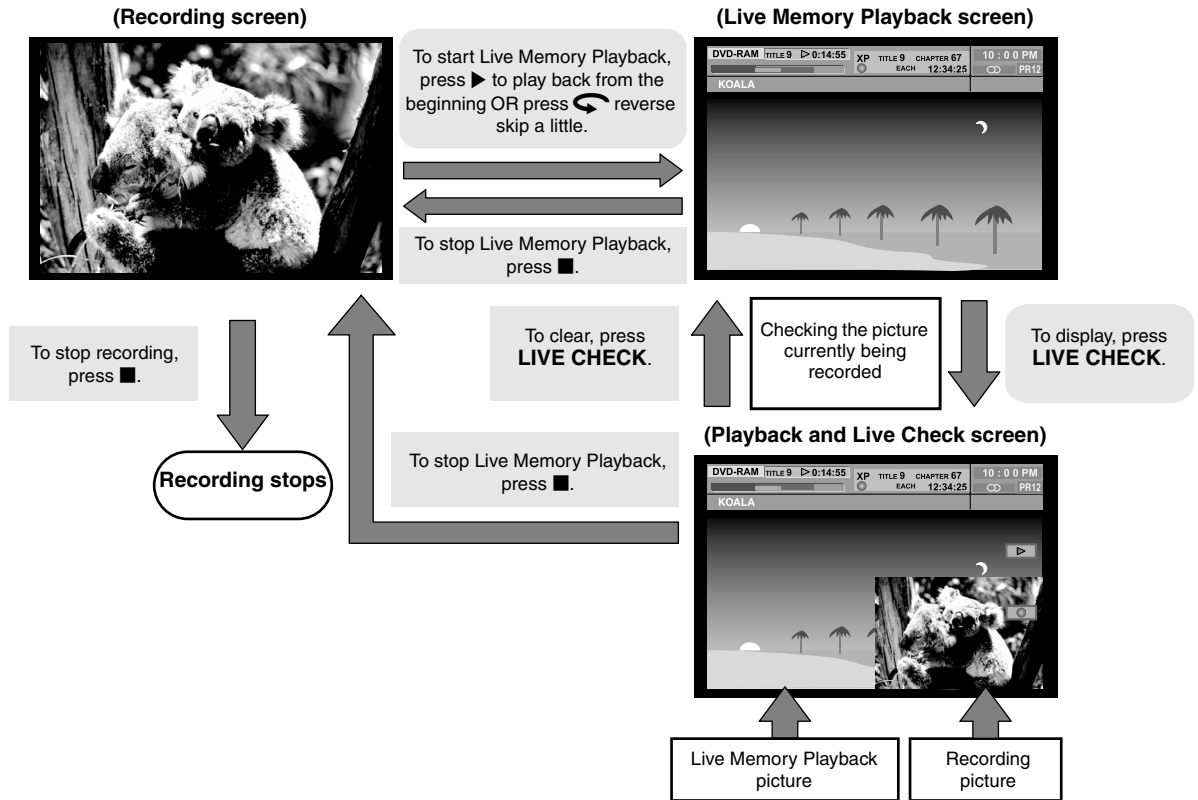

NOTES:

- Live Memory Playback could be performed approximately 30 seconds after recording has started.
- Although high-speed search up to approximately 30 seconds before the current recording point is possible during Live Memory Playback, once the current recording point is reached, the unit resumes normal playback and maintains a delay of approximately 30 seconds so that recording and playback can continue.
- When using Live Memory Playback during timer recording, the unit remains turned on and playback continues even after the end of the recording.
- When using Live Memory Playback during timer recording, playback is automatically stopped just before recording starts, and then recording starts when the time arrives for the next timer programme.
- It is impossible to perform ITR even if you press ● during Live Memory Playback. Press ■ to display the programme being recorded, then perform ITR settings.
- Playback may be paused for a moment during Live Memory Playback, which does not interfere with recording.
- When **LIVE CHECK** is pressed to display the picture currently being recorded, the picture size may not be correct.
- Live Memory Playback cannot be performed while recording the source from DV input. (pg. 53)

28 EN BASIC OPERATIONS ON DVD DECK

- Turn on the unit.
- Turn on the TV and select an input mode such as EXT1.
- Slide the **TV/DVD** switch to **DVD**.

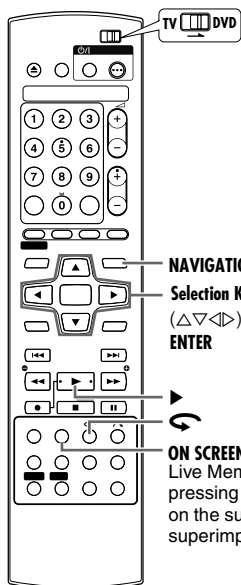

ON SCREEN
Live Memory Playback status can be checked by pressing **ON SCREEN** to display the bar meter on the superimpose display. The current status is superimposed on the TV screen.

Bar meter display

**Live Memory Playback**

You can play back the previous part of the channel you are recording.

To watch from the recording start point

- 1 Press **▶** during recording.

To watch from the point after reverse skipping a little during recording

- 1 Press **◀** during recording.
 - Live Memory Playback could be performed approximately 30 seconds after recording has started.
 - Pressing once skips back for approximately 7 seconds and resumes playback.

Simultaneous Recording and Playback

You can playback other programmes available in the Library Database Navigation on the disc.

To watch other previously recorded programmes during recording

- 1 Press **NAVIGATION** to display the Library Database Navigation screen.
- 2 Press **selection keys** to select "ORIGINAL", then press **ENTER**.
- 3 Press **selection keys** to select a desired programme, then press **ENTER**.

Buttons To Be Used During Live Memory Playback

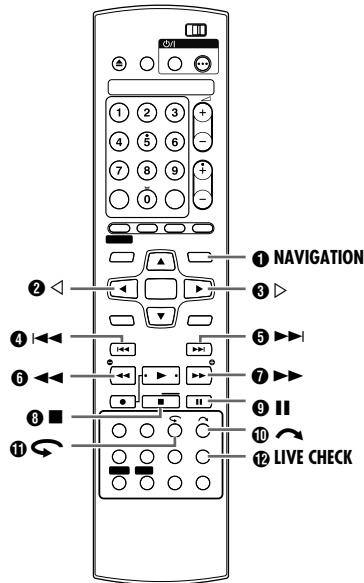

1 NAVIGATION

Displays Library Database Navigation menu. You can choose a title to play back.

2 ◀

Pressing during pause mode reverses the still picture frame by frame.

3 ▶

Pressing during pause mode advances the still picture frame by frame.

4 ◀◀

- Pressing once skips back to the beginning of the programme or chapter being played back.
- Pressing down for 2 or more seconds during playback reverses playback at a faster speed. Releasing the button resumes normal playback.

Available only when paused

- Pressing down for 2 or more seconds reverses playback at a slower speed.

5 ▶▶

- Pressing once skips forward to the next programme or chapter being played back.
- Pressing down for 2 or more seconds during playback advances playback at a faster speed. Releasing the button resumes normal playback.

Available only when paused

- Pressing down for 2 or more seconds advances playback at a slower speed.

6 ◀◀◀

- Each press of the button during playback advances the playback speed in 5 steps in the reverse direction.
- Pressing during pause mode reverses playback at a slower speed.

7 ▶▶▶

- Each press of the button during playback advances the playback speed in 4 steps in the forward direction.
- Pressing during pause mode advances playback at a slower speed.

8 ■

- Pressing once stops Live Memory Playback and returns to the screen on air.
- Pressing again stops the recording and returns to the screen on air.

9 ||

- Pressing once pauses playback (still picture playback).
- Pressing repeatedly advances the still picture frame by frame.

10 ↷

It is useful when skipping over unwanted sections.

- Pressing once skips forward for approximately 30 seconds and resumes playback.
- Pressing repeatedly skips forward continuously as many times as pressed.

11 ↶

It is useful when watching sports programmes, etc.

- Pressing once skips back for approximately 7 seconds and resumes playback.
- Pressing repeatedly skips back continuously as many times as pressed.

12 LIVE CHECK

You can check, for example, if the programme you are recording has already finished.

- Pressing once displays the picture currently being recorded and the one being played back simultaneously.
- Pressing successively clears the Live Check window and displays only the picture currently being played back.

30 EN BASIC OPERATIONS ON DVD DECK

Using The On-screen Bar



The on-screen bar allows you to control various playback functions. Some of the functions operated on Navigation Menu can be controlled on the On-screen bar.

Be sure to clear Library Database Navigation screen by pressing **NAVIGATION**.

ATTENTION:

While watching Digital terrestrial broadcast (DVB-T), **ON SCREEN** button functions as **colour button** (green). Press **INFO** to display the information bar, then proceed with the following procedures.

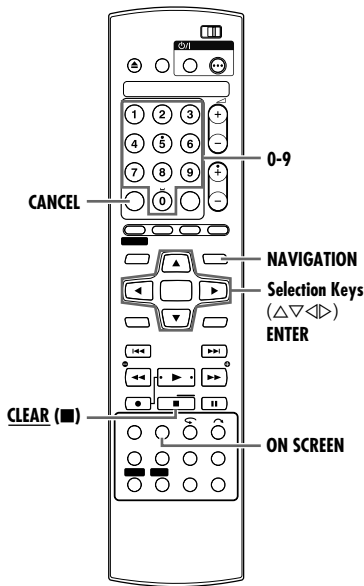

How To Access The On-screen Bar

- 1 Press **ON SCREEN** twice whenever a disc is loaded.

Contents of the on-screen bar during playback

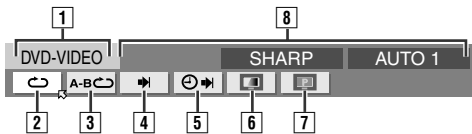

Video CD/Super Video CD

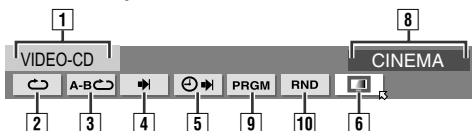

JPEG disc



- 1 Disc type.
- 2 Select this for Repeat Playback. (pg. 30)
- 3 Select this for A-B Repeat Playback. (pg. 31)
- 4 Select this for search function. (pg. 31)
- 5 Select this for time search function. (pg. 32)
- 6 Select this for Picture Control function. (pg. 32)
- 7 Select this to switch picture source type. (pg. 32)
- 8 Current status area for the selected item.
- 9 Select this for Programme Playback. (pg. 33)
- 10 Select this for Random Playback. (pg. 33)
- 11 Select this to control the switching interval of the slide show. (pg. 33)

NOTE:

Although examples of the on-screen bar are provided here only for 3 types of discs, the on-screen bar will be displayed for whichever disc indicated in the left column.

Basic Operation On The On-screen Bar

Example: When selecting Picture Control function of DVD

During playback or while stopped

- 1 Press **ON SCREEN** twice to access the on-screen bar. The item currently selected is highlighted and pointed by ↖.



- 2 Press **selection keys** to select "SHARP", then press **ENTER**. The pop-up window appears under the selected item.



- 3 Press **selection keys** to select the desired option, then press **ENTER**.

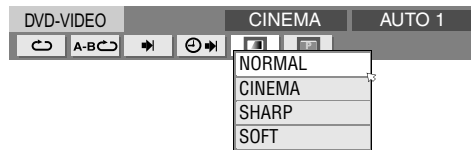

To clear the on-screen bar

Press **ON SCREEN**.

NOTE:

See the corresponding pages for details on each menu item.

Repeat Playback



You can repeat playback as you like according to the type of disc.

- 1 Press **ON SCREEN** twice to access the on-screen bar.
- 2 Press **selection keys** to select "A-B", then press **ENTER**. The pop-up window appears under the selected item.



- 3 Press **selection keys** repeatedly to select the desired Repeat mode, then press **ENTER**.

DVD-RAM/RW/R

OFF:

Repeat playback is not performed.

ALL REPEAT:

The whole disc is played back repeatedly.

TITLE REPEAT:

The current title is played back repeatedly.

DVD VIDEO

OFF:

Repeat playback is not performed.

TITLE REPEAT:

The current title is played back repeatedly.

CHAPTER REPEAT:

The current chapter is played back repeatedly.

Audio CD/Video CD/SVCD/JPEG/MP3

OFF:

Repeat playback is not performed.

ALL REPEAT:

The whole disc is played back repeatedly.

TRACK REPEAT*:

The current track is played back repeatedly.

* "TRACK REPEAT" cannot be selected for JPEG discs.

To clear the on-screen bar

Press **ON SCREEN**.

To cancel Repeat Playback

Repeat the above procedure from step 1, select "OFF" in step 3, then press **ENTER**.

NOTES:

- Repeat Playback is not possible for a Video CD/SVCD with PBC function.
- Repeat Playback may not work properly depending on the type of the disc being used.

A-B Repeat Playback



You can repeat the desired part.

During Playback

- 1 Press **ON SCREEN** twice to access the on-screen bar.
- 2 Press **selection keys** to select "A-B" icon.
- 3 Press **ENTER** at the beginning of the desired part you want to repeat (point A). The elapsed playing time of the point A appears.



- 4 Press **ENTER** at the end of the desired part you want to repeat (point B). The elapsed playing time of the point B appears.
 - The selected part of the disc (between point A and B) is played repeatedly.



To clear the on-screen bar

Press **ON SCREEN**.

To cancel A-B Repeat Playback

Press **selection keys** to select "A-B" icon, then press **ENTER**.

NOTES:

- A-B Repeat Playback may not work properly depending on the type of disc being used.
- The subtitles recorded around the A-B point may not appear.
- When the end of the item is reached before the end point is set, the on-screen bar disappears from the TV screen. In such a case, repeat the procedure from step 1.
- The point B must be set at least 3 seconds after the point A.
- When playing back a DVD, A-B Repeat Playback is possible only within the same title.
- "A-B" icon cannot be selected during Programme and Random Playback.
- "A-B" icon cannot be selected while stopped.

Locating The Beginning Of A Desired Selection



You can locate the beginning of a title, chapter, group or track.

During playback or while stopped

- 1 Press **ON SCREEN** twice to access the on-screen bar.
- 2 Press **selection keys** to select "A-B" icon, then press **ENTER**.

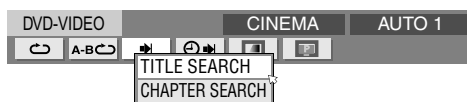

- 3 Press **selection keys** to select the desired option, then press **ENTER**.

- Skip this step for Video CD/SVCD and Audio CD.

NOTE:

Settings that are selectable during playback and stop mode differ depending on the type of disc and search used.

- 4 Press the **number keys** to enter the desired title or chapter number, then press **ENTER**.
 - Playback starts from the selected section.



Example:

- 1 To select track 5, press the **number key "5"**.
- 2 To select track 15, press the **number keys "1" and "5"**.
- 3 To select track 25, press the **number keys "2" and "5"**.

If you have specified a wrong number

Press **CLEAR** (■) or **CANCEL** on the remote control and re-enter again.

To clear the on-screen bar

Press **ON SCREEN**.

NOTES:

- When "⊖" is displayed on the TV screen in step 4, the chapter you have selected is not contained in the disc, or chapter search does not work on the disc.
- Before you press **ENTER**, playback may start automatically when you enter the section's number depending on the disc.
- This function is not possible for a Video CD/SVCD with PBC function.

32 EN BASIC OPERATIONS ON DVD DECK

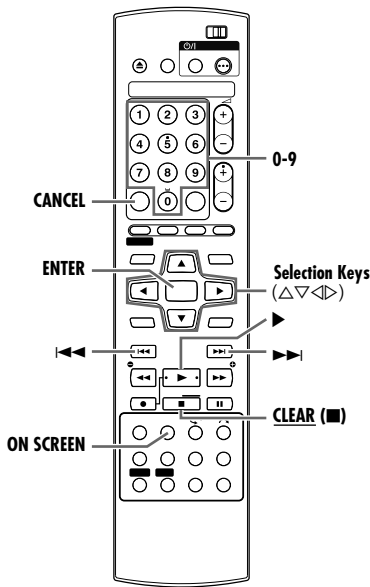

Time Search



You can play back a disc from the desired point by specifying the elapsed playing time from the beginning of a programme (DVD-RAM, DVD-R, DVD-RW and DVD VIDEO) or a disc (Video CD/SVCD and Audio CD).

- 1 Press **ON SCREEN** twice to access the on-screen bar.
- 2 Press **selection keys** to select “⏪➡”, then press **ENTER**. The pop-up window appears under the selected item.



- 3 Press the **number keys** to enter the desired time, then press **ENTER**. Playback starts from the specified time.

Example:

To play back from a point 12 (minutes): 50 (seconds) elapsed.

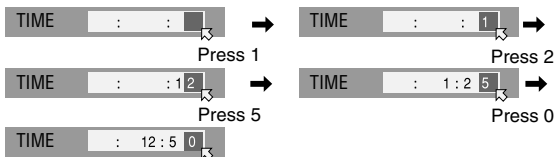

If you have specified a wrong number

Press **CLEAR** or **CANCEL** on the remote control and re-enter again.

To clear the on-screen bar

Press **ON SCREEN**.

NOTES:

- When “⊘” is displayed on the TV screen in step 3, you have selected a point that exceeds the recording time of the disc.
- Some DVD VIDEO discs do not contain time information, and it is not possible to use the Time Search function. In such cases, “⊘” is displayed on the TV screen as well.
- This function is not possible for a Video CD/SVCD with PBC function.

Adjusting The Picture Quality



You can obtain optimal picture quality by selecting an appropriate picture mode.

- 1 Press **ON SCREEN** twice to access the on-screen bar.
- 2 Press **selection keys** to select “⏪➡”, then press **ENTER**. The pop-up window appears under the selected item.

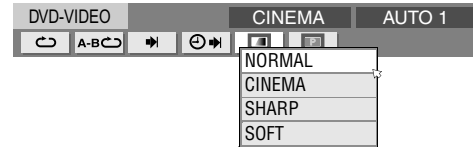

- 3 Press **selection keys** to select the desired option, then press **ENTER**.

NORMAL:

Normally select this.

CINEMA:

Suitable for a movie disc, etc.

SHARP:

Clearer, sharper-edged picture when viewing images with lots of flat, same-coloured surfaces such as cartoons.

SOFT:

Select this option when too much noise appears.

To clear the on-screen bar

Press **ON SCREEN**.

Setting The Progressive Mode



You can obtain optimal picture quality by selecting whether the content on the disc is processed by field (video source) or by frame (film source).

- 1 Set the unit to the progressive scan mode. (pg. 63)
- 2 Press **ON SCREEN** twice to access the on-screen bar.
- 3 Press **selection keys** to select “⏪➡”, then press **ENTER**. The pop-up window appears under the selected item.

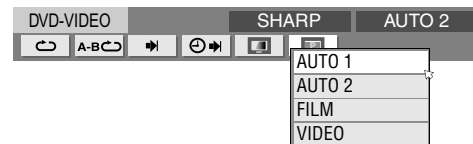

- 4 Press **selection keys** to select the desired option, then press **ENTER**.

AUTO 1:

This mode automatically detects film and video content for progressive playback. When film content is found, flag detection is used to invoke playback of film data in full screen. When video content is found, pictures from multiple fields are used to detect sections with movement, and then this movement undergoes advanced image processing for output of sharp, detailed progressive images without any reduction in image quality where movement occurs. Normally, operation in this mode is recommended.

AUTO 2:

Only the processing of sections with movement differs from “AUTO 1”.

For video contents, the sections with movement are detected and the pictures are corrected by the filtering process for motion pictures.

FILM:

Suitable for playing back a progressive scanned film source disc.

VIDEO:

Suitable for playing back a video source disc. The outlines on the played back pictures will be soft.

To clear the on-screen bar

Press **ON SCREEN**.

Programme Playback



You can programme up to 30 tracks (Video CD/SVCD or Audio CD) to play back in the desired order.

While stopped

- 1 Press **ON SCREEN** twice to access the on-screen bar.
- 2 Press **selection keys** to select "PRGM", then press **ENTER**. The programme table appears under on-screen bar.
- 3 Press the **number keys** to enter the track numbers in the desired order.

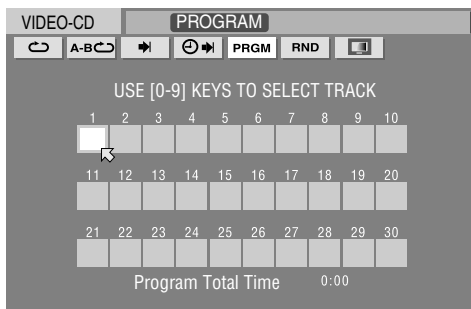

Example:

- 1 To select track 5, press the **number key "5"** and **ENTER**.
- 2 To select track 15, press the **number keys "1"** and **"5"**.
- 3 To select track 25, press the **number keys "2"** and **"5"**.

If you have specified a wrong selection

Press **CANCEL**. The last selection is erased.

Or press **CLEAR**. The whole selection is erased.

- 4 Press **▶**. Playback starts in the programmed order.
 - When all of the programmed tracks have been played back, Programme Playback stops, but the programmed information remains.
 - To add tracks to the end of the programme, perform steps 1 to 3.
 - During Programme Playback, pressing **▶▶** skips to the next track of the programme. Pressing **◀◀** returns to the beginning of the current track.

To clear the on-screen bar and the contents of the programme,

Press **ON SCREEN**.

To cancel Programme Playback

Press **selection keys** to select "PRGM", then press **ENTER**.

NOTE:

Programme Playback is not possible depending on the type of disc.

Random Playback



You can play back all the tracks on the disc in random order.

While stopped

- 1 Press **ON SCREEN** twice to access the on-screen bar.
- 2 Press **selection keys** to select "RND", then press **ENTER**. Playback starts in random order.



To clear the on-screen bar

Press **ON SCREEN**.

To cancel Random Playback

Perform steps 1 and 2.

NOTE:

The same track will not be played back more than once during Random Playback.

Select The Switching Interval Of The Slide Show



You can control the switching interval of the slide show.

- 1 Press **ON SCREEN** twice to access the on-screen bar.
- 2 Press **selection keys** to select "📄", then press **ENTER**. The pop-up window appears under the selected item.

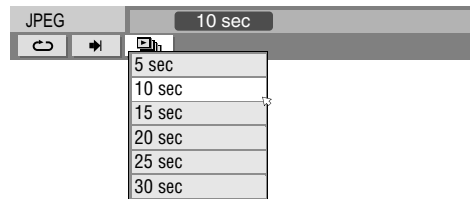

- 3 Press **selection keys** to select the desired option, then press **ENTER**.

To clear the on-screen bar

Press **ON SCREEN**.

NOTE:

JPEG files are played back as a slide show. It may take more time to display an image with larger file size.

34 EN BASIC OPERATIONS ON DVD DECK

Basic Recording



- Turn on the unit.
- Turn on the TV and select an input mode such as EXT1.
- Slide the TV/DVD switch to **DVD**.

ATTENTION:
It is not possible to record programmes on a DVD-R/RW disc which has already been finalised.

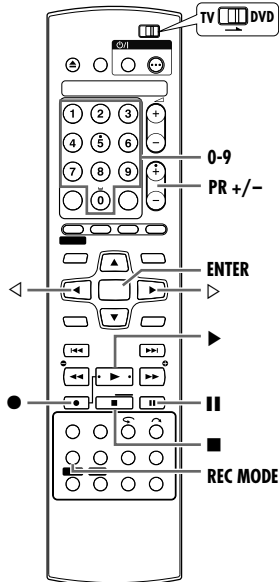
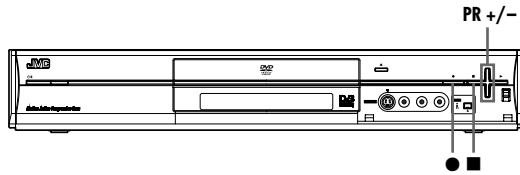

NOTES:

- It is recommended to format a DVD-RAM disc before use if you use the disc on this unit for the first time. (pg. 67)
- When using a brand-new DVD-RW disc, format the disc either in VR mode or in Video mode. (pg. 67)
- Recordings made on DVD-R/RW disc must be finalised to play back on other DVD players. Perform "Finalise A Disc" (pg. 68).
- You can record up to 99 programmes and 99 play lists on each disc.
- Some programmes can only be recorded one time.
- When recording is started, an index of the first part of recording is automatically recorded. (pg. 43) To delete the index, refer to page 46.
- Recording sometimes may stop or cannot be performed even if there is enough available capacity remaining on the disc.

Recording Mode

MPEG 2 format is used as recording format. As a guide for picture quality, the "bps" unit is used to represent how much data can be recorded per second. The larger this value is, the better the picture quality becomes but more capacity is required for the recording. Select XP or SP for programmes where quick movement occurs, such as sports programmes, and LP or EP for talk shows, etc. with relatively less movement.

The recording modes for a 4.7 GB disc are set as follows:

Recording mode	Recording amount (approx.)	Maximum recording time (approx.)
XP	10 Mbps	1 hour
SP	5 Mbps	2 hours
LP	2.5 Mbps	4 hours
EP	1.6 Mbps	6 hours
FR	60-360 (pg. 36)	1 – 6 hours
	420	7 hours
	480	8 hours

- For details on FR mode, refer to "Free Rate Function" (pg. 36).

- 1** Load a recordable disc.
 - For details, refer to "Placing A Disc" (pg. 9).
- 2** Press **PR +/-** or the **number keys** to select the channel you wish to record.
- 3** Press **REC MODE** repeatedly to select the recording mode, then press **ENTER**.
 - Each time you press **REC MODE**, the recording mode changes as follows:
XP → SP → LP → EP → FR (60-360*, 420, 480) → (Back to the beginning)
 - * The value is selectable from 1 to 6 hours in 5 minutes interval by pressing <|> repeatedly after selecting "FR60-FR360". To change the value in 30 minutes interval, press and hold <|>.
 - For details on the recording mode, see the right column.
- 4** Press ● on the unit to start recording. Or while holding ●, press ► on the remote control.
- 5** Press || to pause recording.
 - To resume recording, press ►.
- 6** Press ■ to stop recording.
 - It takes about 10 seconds to end the writing session when you stop recording.

Recording Features

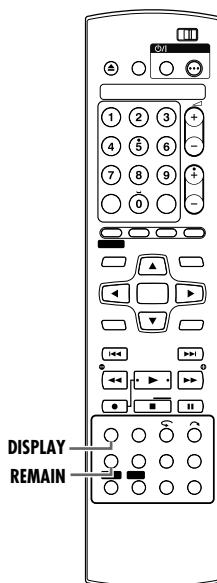
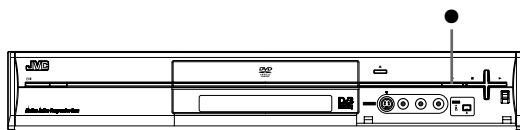

Instant Timer Recording (ITR)

It is possible to set the recording time during recording. Upon completing recording, the unit stops and shut off automatically.

- 1** Press ● on the unit to start recording.
- 2** Press ● again to engage the ITR mode.
 - "0:30" is displayed on the front display panel.
- 3** If you want to record for more than 30 minutes, press ● to extend the time. Each press extends recording time by 30 minutes.
 - Normal recording → 0:30 → 1:00 ... → Maximum disc remaining time → (back to the beginning)

NOTES:

- Perform ITR using the ● button on the unit.
- The maximum recording time changes depending on the disc remaining time.

Watch Another Programme While Recording On The Unit

While recording is going on, you can watch another programme on the TV. It does not interfere with recording.

- 1** Turn on the TV.
- 2** Select the desired channel to watch on the TV using your TV's remote control.

Elapsed Recording Time And Disc Remaining Time Indication

During recording, press **DISPLAY** repeatedly until the desired indication appears on the front display panel.

- Each time you press **DISPLAY**, the time indication changes as follows:
 - Elapsed recording time → Disc remaining time → Clock → (back to the beginning)
- You can also check the disc remaining time by pressing **REMAIN** while the unit is stopped or recording is in progress. The list of disc remaining times for all recording modes appears on the TV screen.

36 EN BASIC OPERATIONS ON DVD DECK**Free Rate Function**

To record the entire programme, the unit automatically sets the appropriate recording mode depending on the combination of the total time of the programme to be recorded and either the remaining disc space or the specified recording time (from 60 minutes to 480 minutes when using 4.7 GB blank media disc).

■ **To record the entire programme within the actual remaining disc space**

Select "FR (JUST)" in a recording mode selection procedure.

- Note that this function is available only for timer programming recording (see pg. 37, 38).

■ **To record the entire programme by specifying the desired recording time**

Select "FR60-FR360", "FR420" or "FR480" in a recording mode selection procedure. (see pg. 34)

■ **To record a 25 min. long daily programme five times just on the same DVD disc for example**

Perform "EPG Timer Programming" (see pg. 37) procedure. Be sure to set the recording mode to "FR125" and set Weekly/Daily Rec Function to "MON-FRI" in step 4 to fit the total recording time to the whole disc space.

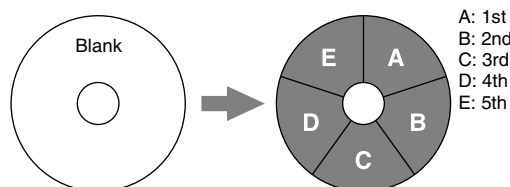

When the same programme is recorded in SP mode instead of in "FR125", the 5th programme cannot be recorded.

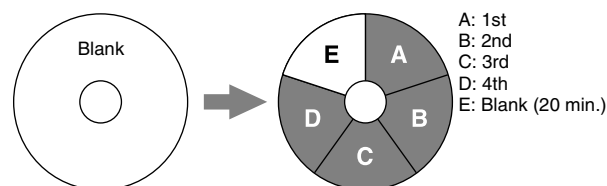
**NOTES:**

- You can programme this unit to timer record, regardless of the disc remaining time. When the disc remaining time is not enough, it is not possible to record until the end of the timer programme. **(Example)** If you programmed to timer record for 60 minutes in SP mode on a 120 minutes disc, the disc remaining time would be 30 minutes in XP mode, 60 minutes in SP mode, 120 minutes in LP mode, 180 minutes in EP mode, and 240 minutes in FR480 mode. Timer recording will not complete beyond these remaining times.
- The maximum recording time of FR (JUST) mode is the same as the recording time of FR480 mode. When timer programming a long programme in FR (JUST) mode on a disc whose remaining time is short, it is recommended to check the disc remaining time in FR480 mode to see if the remaining time is enough for the programme.
- Even if more than one programme are timer programmed in FR (JUST) mode, only the first one is recorded.
- In order to ensure that the recording fits on the disc, this feature may leave a slight non-recorded section at the end of the disc.
- There may be some noise and sound disturbance at the point on the disc where the unit switches the mode.

Selection Of The Audio Channel To Be Recorded On A Disc

When a TV programme is recorded on a disc, only the audio as set in "AUDIO LANGUAGE" (see pg. 20) is recorded on the disc.

NOTE:

Before playing back a programme recorded in stereo, refer to "Audio Channel Selection" (see pg. 26).

EPG Timer Programming



EPG (Electronic Programme Guide) is a system built into this unit to enable viewing of TV programme information.

The programme information is part of the text broadcast provided by the individual TV stations.

This unit displays the programme information of a number of channels up to 8 days from the present on the "EPG" screen of the timer programming screen.

With the "EPG" screen, you can perform timer programming with great ease using the remote control. You can programme this unit to timer record as many as 8 programmes.

ATTENTION:

If timer programming cannot be set or cancelled, wait for about 40 seconds and then try again.

- Turn on the unit.
- Turn on the TV and select an input mode such as EXT1.
- Make sure that the unit's built-in clock is set properly.
- Slide the TV/DVD switch to DVD.

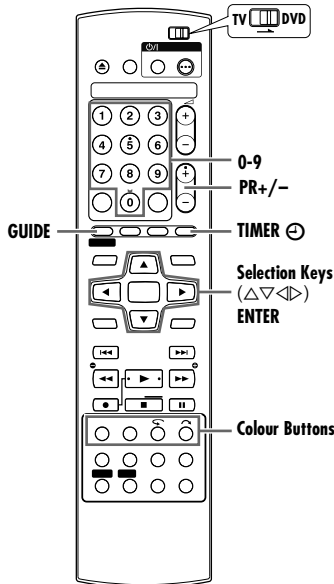

- Load a recordable disc.
 - For details, refer to "Placing A Disc" (pg. 9).
- Press **GUIDE** to display the "EPG" screen.
 - If a On-Disc Timer Programmed disc is loaded, a warning screen appears and the On-Disc Timer Programming (pg. 39) confirmation screen is displayed. Exit On-Disc Timer Programming, insert a disc that is not meant for On-Disc Timer Programming and re-perform the procedures from step 1.
- Press $\Delta \nabla$ to select the desired date (date field: left).
 - The cursor moves to the channel field when \triangleright is pressed.
 - You can press $\triangleleft \triangleright$ to move to each field to change the setting.
 - Press **PR +/-** to proceed to the next page or to return to a previous on the "EPG" screen.

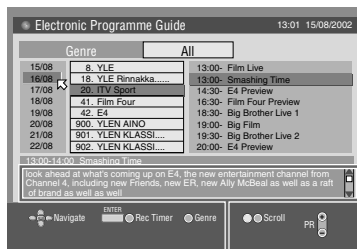

Programme description field

- You can scroll the programme description field vertically by pressing the yellow (\curvearrowright) or blue (\curvearrowleft) button on the remote control.

- Select the channel field (centre field) and the programme field (right field) in the same way, then press the red (**DISPLAY**) button.

- The confirmation screen appears.

- The items on the confirmation screen can be changed with the following methods:

- Number keys entry:** Start time, stop time and recording date.

- $\triangleleft \triangleright$ entry:

Daily/Weekly recording and recording mode.

- Daily/Weekly recording can be set as shown in the table below.
- The red (**DISPLAY**) button on the remote control is operable no matter which field the cursor is in.
- If the red (**DISPLAY**) button on the remote control is pressed when the cursor is in the date field or channel field, the programme in the programme field that turns green is timer programmed.

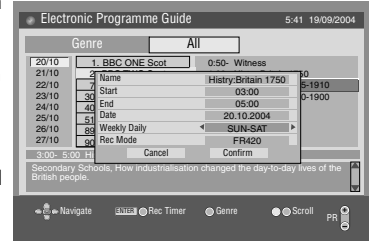

Daily/Weekly Recording Function

WEEKLY	Select to record a weekly programme.
MON-FRI	Select to record a daily programme from Monday through Friday.
MON-SAT	Select to record a daily programme from Monday through Saturday.
SUN-SAT	Select to record a daily programme from Sunday through Saturday.
ONCE	Select to perform one time recording of a programme.

- Confirm that the start/stop time, channel setting etc. are correct, press $\triangleleft \triangleright$ to select "Confirm", then press **ENTER**.

- \bullet appears on the extreme right of the programme field.
- To programme another timer, repeat steps 2 – 5.
- When the start time or stop time is manually changed in step 4 such that the time programmed is shorter than the actual programme time, \bullet appears on the extreme right of the programme field.
- If programmes overlapped or when the timer programming is full, refer to "When Programmes Overlap Each Other (2)" (pg. 41).

- Press **GUIDE** to exit the "EPG" screen.

- Press **TIMER** to engage the unit's timer mode.

- The unit turns off automatically and \bullet appears on the front display panel.
- To disengage the timer mode, press **TIMER** again.

IMPORTANT:

If you have moved to a different area or if a broadcasting station's channel number has been changed, the wrong channel number will be displayed on the "EPG" programme screen. When this happens, set the correct channel number for that station.

- When two successive programmes are recorded with the "EPG" Timer Programming function, the ending of the first programme or the beginning of the second programme may not be recorded.
- This unit does not automatically extend the stop time when a programme overruns. Press **TIMER** to exit timer recording mode. The unit returns to the normal recording mode and continues to record the extended portion. You can also engage the "Instant Timer Recording (ITR)" (pg. 35) mode to end the recording automatically.

38 EN **TIMER RECORDING**

Manual Timer Programming



You can programme this unit to timer record as many as 8 programmes up to 30 days in advance. To perform normal timer programming without using EPG, use the following procedure to set your unit to timer record the programme.

ATTENTION:

If timer programming cannot be set or cancelled, wait for about 40 seconds and then try again.

- Turn on the unit.
- Turn on the TV and select an input mode such as EXT1.
- Make sure that the unit's built-in clock is set properly.
- Slide the TV/DVD switch to DVD.

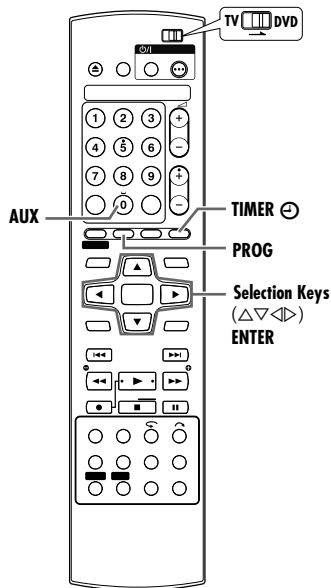

- Press **selection keys** to set the desired stop time ("STOP"), then press \triangleright .
 - Each press of $\triangle \nabla$ increases/decreases the stop time in 1 minute interval.
 - To increase/decrease the stop time in 30 minutes interval, press and hold $\triangle \nabla$.
- Press **selection keys** to set the desired channel ("TV PROG"), then press \triangleright .
- Set the other recording options as required.
- Press **ENTER** to access the Programme Confirmation screen.
- Press **ENTER** to complete the timer programming.
 - To programme another timer, repeat steps 2 – 10.
- Press **TIMER** to engage the unit's timer mode.
 - The unit turns off automatically and \odot appears on the front display panel.
 - To disengage the timer mode, press **TIMER** again.

NOTES:

- When two successive programmes are recorded with the "Manual Timer Programming" function, the ending of the first programme or the beginning of the second programme may not be recorded.
- If the copy limited programme is received during timer recording, the unit enters Record Pause mode. Recording starts again if it is switched to a recordable broadcast during the time you programmed.

Satellite Receiver Users

To record a satellite broadcast using Manual Timer Programming:

- Perform Manual Timer Programming.
 - In step 7, press **AUX** to set "TV PROG" to "SAT". Then press $\triangle \nabla$ to enter the channel position for the satellite broadcast.
- Set the satellite receiver to the appropriate channel for recording.
 - Leave the satellite receiver's power on.

- Load a recordable disc.
 - For details, refer to "Placing A Disc" (pg. 9).

- Press **PROG** to display the "PROGRAMME CHECK" screen.
 - When 8 timer programmes appear on the TV screen, you need to cancel some of the reserved programmes.

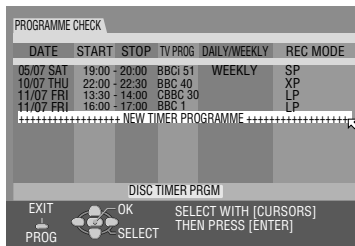

- Press **selection keys** repeatedly to select "NEW TIMER PROGRAMME", then press **ENTER**.

- Press **selection keys** to set the desired date ("DATE"), then press \triangleright .

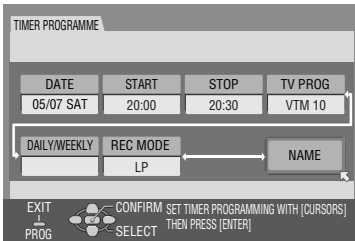

- Press **selection keys** to set the desired start time ("START"), then press \triangleright .
 - Each press of $\triangle \nabla$ increases/decreases the start time in 1 minute interval.
 - To increase/decrease the start time in 30 minutes interval, press and hold $\triangle \nabla$.

On-Disc Timer Programming



On-Disc Timer Programming is a function used with discs that are especially intended for a specific programme. The disc is then programmed for a programme you always watch every day or every week. Since older programmes are automatically overwritten, a single disc can be used without worrying about how much recording capacity remains. You can programme each disc to timer record as many as 8 programmes up to 30 days in advance.

- Make sure that the unit's built-in clock is set properly.
- Turn on the TV and select an input mode such as EXT1.
- Load a DVD-RAM or DVD-RW (VR mode) disc for programming.
- Slide the TV/DVD switch to DVD.

ATTENTION:

- On-Disc Timer Programming is possible only with the disc for On-Disc Timer Programming.
- If data is recorded on a disc for On-Disc Timer Programming using a unit from another manufacturer, On-Disc Timer Programming may not function properly.
- If timer programming cannot be set or cancelled, wait for about 40 seconds and then try again.

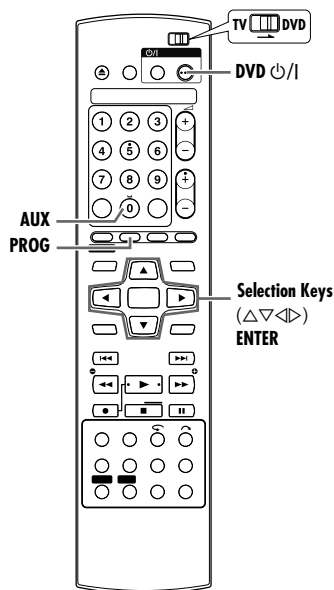

To Make The Disc For On-Disc Timer Programming

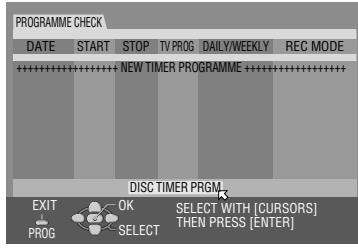
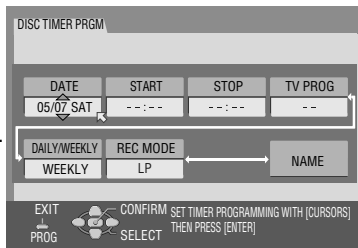
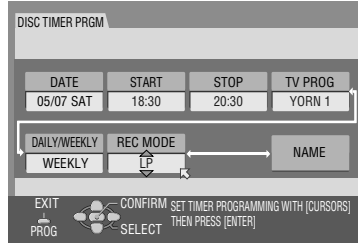
- 1 Press **PROG** to access the Programme Check screen.
 
- 2 Press **selection keys** to select "DISC TIMER PRGM", then press **ENTER**.
 - When some programmes are recorded on the disc, a caution message appears. You can either format the disc (pg. 67) or insert a new disc, then re-perform the procedure from step 1.
 - When On-Disc Timer Programming has already been made on the disc, press **selection keys** to select "NEW TIMER PROGRAMME", then press **ENTER**.
- 3 Press **selection keys** to set the desired date ("DATE"), then press **▷**.
 
- 4 Press **selection keys** to set the desired start time ("START"), then press **▷**.
 - Each press of **△▽** increases/decreases the start time in 1 minute interval.
 - To increase/decrease the start time in 30 minutes interval, press and hold **△▽**.
- 5 Press **selection keys** to set the desired stop time ("STOP"), then press **▷**.
 - **△▽** increases/decreases the stop time in 1 minute interval.
 - To increase/decrease the stop time in 30 minutes interval, press and hold **△▽**.
- 6 Press **selection keys** to set the desired channel ("TV PROG"), then press **▷**.
- 7 Press **selection keys** to set "DAILY/WEEKLY", then press **▷**.
 - For details on "DAILY/WEEKLY" setting, refer to "Daily/Weekly Recording Function" (pg. 37).
- 8 Set the other recording options as required.
 - "Recording Mode" (pg. 34)
 - "Modify Title Name" (pg. 46)
- 9 Press **ENTER** to access the Programme Confirmation screen.
 
- 10 Press **ENTER** to complete "To Make The Disc For On-Disc Timer Programming".
 - To programme another timer using "To Make The Disc For On-Disc Timer Programming", repeat steps 1 – 10.
- 11 Press **DVD** to turn off the power.
 - **DISC** is displayed on the front display panel.
 - To disengage the timer mode, press **DVD** again.

Satellite Receiver Users

To timer record a satellite broadcast using On-Disc Timer Programming:

- 1 Perform On-Disc Timer Programming.
 - In step 6, press **AUX** to set "TV PROG" to "SAT". Then press **△▽** to enter the channel position for the satellite broadcast.
- 2 Set the satellite receiver to the appropriate channel for recording.
 - Leave the satellite receiver's power on.

40 EN *TIMER RECORDING*

To Timer Record The Programme With The Programmed Disc

- 1** Load a programmed disc.
- 2** Press **DVD** \odot /I to turn off the power.
 - **DISC** \odot appears on the front display panel, and the unit enters into timer standby mode.
 - To disengage the timer mode, press **DVD** \odot /I again.

NOTES:

- On-Disc Timer Programming is not possible on a DVD-R or DVD-RW (Video mode) disc.
- The information of a programme recorded with On-Disc Timer Programming is not stored in the library.
- The play list is not created for the programmes recorded with On-Disc Timer Programming.
- Programmes recorded with On-Disc Timer Programming cannot be edited or protected.
- On-Disc Timer Programmed discs cannot be used for other recordings other than On-Disc Timer Programming.
- On-Disc Timer Programmed discs cannot be used on units from other manufacturers.
- The beginning of a programme may not be recorded. In addition, if the 1st programme's recording stop time and the 2nd programme's recording start time is the same, the ending of the 1st programme may not be recorded.
- If there is a power outage while recording, the recordings when the power outage occurs are not guaranteed.

How Discs Are Overwritten

(Example 1)

To record a 1-hour serial drama every Friday in SP mode

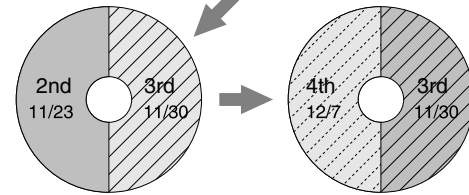
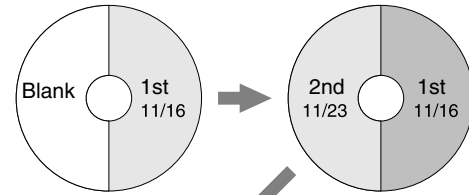

The first programme is overwritten by the third.

The second programme is overwritten by the fourth.

(Example 2)

To record a 15-minutes serial drama every morning in XP mode

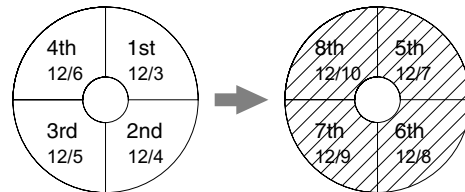

(Example 3)

To record a 90-minutes serial drama every Sunday in SP mode

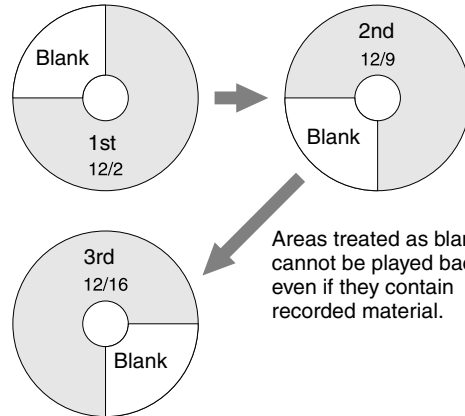

Areas treated as blank cannot be played back even if they contain recorded material.

NOTE:

On-Disc Timer Programming may not always work as these examples.

Check, Cancel And Change Programmes

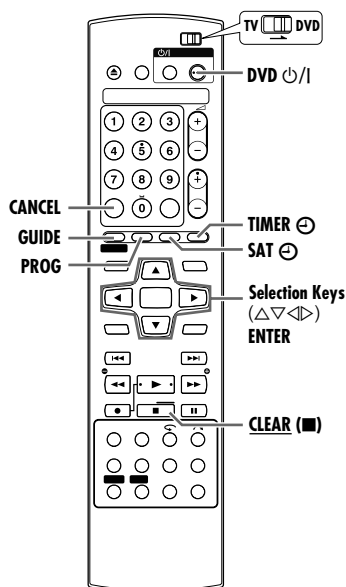

- 1 Disengage the timer mode.
 - When **DISC** lights up on the front display panel, press **DVD** \updownarrow .
 - When **TIMER** lights up on the front display panel, press **TIMER** \ominus , and press **DVD** \updownarrow after **TIMER** lights off.
 - When "SAT" lights up on the front display panel, press **SAT** \ominus .
- 2 Press **PROG** to access the Programme Check screen.
 - To return to the previous screen after you check the programme, press **PROG** again.

To cancel the programme

- Press **selection keys** to select a programme to be cancelled, then press **CANCEL**.
- 3 Press **selection keys** to select a programme to be changed, then press **ENTER**.
- 4 Change the settings of the desired recording options as required.
 - Refer to steps 4 – 10 in Manual Timer Programming.
- 5 Press **PROG** to exit the programme screen.
- 6 Set the unit to timer standby mode.

For EPG or Manual Timer Programming

- Press **TIMER** \ominus so that **TIMER** lights up on the front display panel.

For On-Disc Timer Programming

- Press **DVD** \updownarrow so that **DISC** lights up on the front display panel.

For Automatic Satellite Programme Recording

- Press **SAT** \ominus for 2 or more seconds.

When Programmes Overlap Each Other (1)

If "PROGRAMME OVERLAPPED" appears, you have another programme overlapping the programme you have just made. Press **PROG**. Programme Check screen appears and conflicting programmes will be highlighted in pink.

Example: Programme 3 (you have just made) and Programme 4 overlap each other.

- 1 Confirm the overlapping programmes.

NOTES:

- If you do not mind this overlap, press **PROG** to finish the timer programme setting.
- Recording is performed according to the order as displayed on the Programme Check screen. The timer programme that follows will not be performed correctly.

DATE	START	STOP	TV PROG	DAILY/WEEKLY	REC MODE
05/07 SAT	18:10-20:00		BBC 40		SP
06/07 THU	18:10-20:00		BBC1 51		SP
10/07 THU	19:00-20:00		BBC 1	WEEKLY	XP
10/07 THU	19:45-20:30		BBC 1		LP

NEW TIMER PROGRAMME

DISC TIMER PRGM.

EXIT OK SELECT WITH [CURSORS] THEN PRESS [ENTER]

PROG SELECT

To cancel the programme

Press **selection keys** to select a programme to be cancelled, then press **CLEAR** (■).

- "THE TIMER PROGRAMMING SETTING WAS CANCELLED" appears on the TV screen for about 5 seconds, then the normal screen resumes.

To change the programme

Press **selection keys** to select a programme to be changed, then press **ENTER**.

- Change each setting as required.
- 2 Press **ENTER** to exit the Programme screen.
- 3 Press **TIMER** \ominus to enter into timer standby mode.

NOTE:

When any overlaps remain after deletion and modification of programmes, Programme Overlap list remains showing the conflicting programmes. In such a case, repeat the procedure above until the conflict is solved.

When Programmes Overlap Each Other (2)

With "EPG" Timer Programming, if **EPG** appears on the extreme right of the programme field, you have another programme overlapping the programme you have just made.

- 1 Move the cursor to the programme with the **EPG** indication in the programme field, then press **ENTER** or the red (**DISPLAY**) button.

- The confirmation screen appears.

- 2 Confirm the content, then delete or change the current selected programme.

- To delete, select "Delete" then press **ENTER**.
- The individual items on the confirmation screen can be changed with the following methods:

Number keys entry: Start time, stop time and recording date.
<> entry: Daily/Weekly recording and recording mode.

- To confirm the next overlapping programme, select **→** then press **ENTER**.

- 3 Select "Cancel" or "OK", then press **ENTER** to clear the confirmation screen.

- Press **GUIDE** on the remote control to return to the digital terrestrial broadcast (DVB-T) screen.

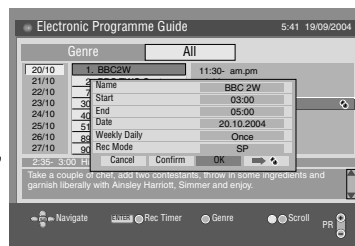

42 EN **TIMER RECORDING****Automatic Satellite Programme Recording**

This function allows you to automatically record a satellite programme which is timer programmed on your external satellite receiver. Connect a satellite receiver to the unit's [L-2 IN] connector and programme the timer on the satellite receiver. The unit starts or stops recording by the signals input from the satellite receiver. After recording, the unit's power shuts off automatically.

ATTENTION:

- When you record programmes by connecting to a digital terrestrial receiver (Freeview receiver or similar), perform the same steps as "Automatic Satellite Programme Recording" (pg. 42).
- Be sure not to turn on the satellite receiver before the programme is executed. Otherwise, the unit will start recording when the satellite receiver's power is turned on.
- If you have connected another appliance other than a satellite receiver to the [L-2 IN] connector, be sure not to engage the Automatic Satellite Programme Recording mode. Otherwise, the unit will start recording when the connected appliance's power is turned on.
- Automatic Satellite Programme Recording and timer recording cannot be done at the same time.

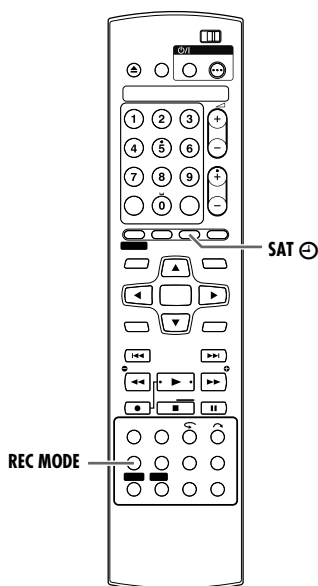

- Make sure the satellite receiver is connected to the unit's [L-2 IN] connector.
- Programme the timer on the satellite receiver.

- 1 Set "L-2 SELECT" to "SAT VIDEO/RGB" or "SAT S-VIDEO/RGB". (pg. 58)
 - Also refer to "IMPORTANT" on page 59.
- 2 Press **REC MODE** repeatedly to set the recording mode.
- 3 Press and hold **SAT** for about 2 seconds to engage the Automatic Satellite Programme Recording mode. "SAT" and "⏏" appear on the front display panel and the unit turns off automatically.

NOTES:

- To disengage the Automatic Satellite Programme Recording mode, press **SAT**.
- If the unit's power is off, it is not possible to engage the Automatic Satellite Programme Recording mode.
- In step 3, if "⏏" blinks quickly on the front display panel even though your satellite receiver's power is off, Automatic Satellite Programme Recording will not work properly with that satellite receiver*. If this is the case, perform "Manual Timer Programming" (pg. 38) to timer record a satellite programme.
 - * Some satellite receivers output signals even if the power is off. Automatic Satellite Programme Recording is not possible with those satellite receivers.
- "⏏" blinks on the front display panel while Automatic Satellite Programme Recording is in progress.
- For timer programming of the satellite receiver, refer to the instruction manual of the satellite receiver.
- Automatic Satellite Programme Recording is not possible if your satellite receiver does not have a timer.
- Pressing the unit's **⏏** button while Automatic Satellite Programme Recording is in progress turns off the unit's power and disengages the Automatic Satellite Programme Recording mode.
- If there are more than one satellite programmes you wish to record with Automatic Satellite Programme Recording, it is not possible to set different recording modes for each programme.
- Depending on the type of satellite receiver, the unit may not record a slight portion of the beginning of the programme or may record slightly longer than the actual length of the programme.
- If you engage the Automatic Satellite Programme Recording mode when the satellite receiver's power is on, the unit will not start Automatic Satellite Programme Recording even though "⏏" blinks on the front display panel. When the satellite receiver shuts off once and is turned back on again, the unit starts recording.
- When the Automatic Satellite Programme Recording mode is engaged, or the unit's power is turned off after Automatic Satellite Programme Recording is finished, the unit will not enter the timer mode even though "AUTO TIMER" is set to "ON".
- Just Clock (pg. 66) does not work when the Automatic Satellite Programme Recording mode is engaged.

Library Database Navigation



The Library Database Navigation enables you to search and select the desired titles recorded very easily.

You can record up to 99 titles on a disc.

Each time a title is recorded, the information of the title is registered for the Library Database Navigation automatically. So, you can confirm the information of the titles recorded with the Library Database Navigation screen. And, you can also select one of the titles recorded using the Library Database Navigation. The following screen appears as the Library Database Navigation screen when you press **NAVIGATION**. You can move the arrow to select the desired position on the screen by pressing the **selection keys** on the remote control.

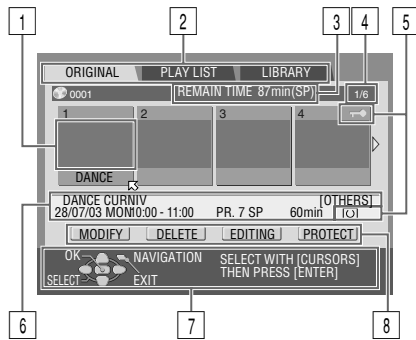

- 1 INDEX (Thumbnail of each programme)
- 2 Menu index
ORIGINAL (pg. 44)
PLAY LIST (pg. 47)
LIBRARY (pg. 51)
- 3 Remaining time (Based on the recording speed currently selected)
- 4 Current/Total number of programme(s)
- 5 Icons
- 6 Recording information for the programme indicated by the arrow
- 7 Guidance for operations
- 8 Operational commands

The Icons and their meanings

	This programme is write-protected.
	This programme has stereo sounds.
	This programme has monaural sounds.
	This programme was recorded with timer recording.

Using Library Database Navigation system, you can easily modify registered information, edit the title or play list, as well as search for the beginning of each title.

About registration of information

The following information is automatically registered for each title when ordinary recording or timer recording is performed, then stored in an area specified on the unit.

- index* (reduced pictures to show programme titles)
- programme title*
- category*
- date and time
- channel (If the station name has been registered to the channel, the station name is displayed.)
- recording mode
- length of recording time

The items marked with an asterisk (*) can be easily modified and registered again after recording by using Library Database Navigation system.

The limitations of registration

You can register information up to 99 programmes in a single DVD. When the amount of information is at the limits of registration, you cannot record new titles any more. In this case, you need to delete old titles to register new ones. (pg. 44)

NOTES:

- Once a DVD-R/RW (Video mode) disc has been finalised, the displays for original and play list do not appear. As only display for library appears, press **TOP MENU** to display the following screen to select the desired title.



- Sound of received channel may be interrupted while the Library Database Navigation screen is displayed.
- You cannot perform timer recording during editing of thumbnail images or play lists by pressing **NAVIGATION**. Press **NAVIGATION** to clear the editing screen before performing timer recording.

44 EN NAVIGATION

Basic Operation Of Original Information

You can scan the beginning of the title easily and play back with the Library Database Navigation.

- Turn on the TV and select an input mode such as EXT1.
- Load a DVD disc to play back.
- Slide the TV/DVD switch to DVD.

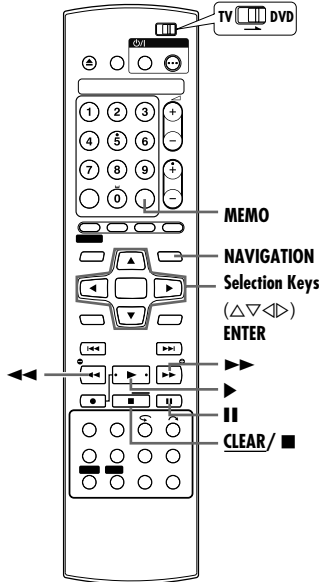

Play Back Title

- 1 Press **NAVIGATION** to display the Library Database Navigation screen.
- 2 Press **selection keys** to select "ORIGINAL", then press **ENTER**.
- 3 Press **selection keys** to select the index (small pictures) of the desired title, then press **ENTER** or **▶**.
 - With the arrow on "ORIGINAL", all titles will be played back according to the index order when **▶** is pressed.
 - All subsequent titles after the selected index will be played back in order.
 - The unit stops when playback ends, and resumes to a broadcast receiving screen.
 - Press **■** to stop playback. If "RESUME" is set to "ON" or "DISC RESUME" (pg. 61), playback starts from the point where playback was previously stopped when **▶** is pressed.
 - When you want multiple titles to be played back in a determined order, press **selection keys** to select the desired title, then press **MEMO**. The numbers of the playback order appear on the index. (Up to 30 titles)
 - When you want to correct the order, move the arrow to the desired index and press **MEMO**. The number disappears and the unit re-numbers the other titles automatically.
 - When you want to cancel the order, press **CLEAR (■)**.



Protect Title (DVD-RAM & DVD-RW (VR mode) only)

You can protect titles to prevent accidental erasure of the important titles.

- 1 Press **NAVIGATION** to display the Library Database Navigation screen.
- 2 Press **selection keys** to select "ORIGINAL", then press **ENTER**.
- 3 Press **selection keys** to select a title you want to protect, then press **▽**.
- 4 Press **selection keys** to select "PROTECT", then press **ENTER**.
 - "PROTECT" appears on the TV screen.
 - To cancel the protection, select "PROTECT" again, then press **ENTER**.
- 5 Press **NAVIGATION** to return to the normal screen.

NOTE:

All the titles on a disc will be deleted once the disc is formatted even if they are protected titles. (pg. 67)

Delete Title

You cannot record any more with Library Database Navigation once the registered titles on the disc reach 99 titles. Deleting unnecessary titles after dubbing or other operations can increase remaining time and available recording capacity. (For DVD-R discs, although it is possible to delete recorded titles, available recording capacity does not increase.) The deleted title cannot be retrieved. Play lists and title information in the unit's library are also deleted.

- 1 Press **NAVIGATION** to display the Library Database Navigation screen.
- 2 Press **selection keys** to select "ORIGINAL", then press **ENTER**.
- 3 Press **selection keys** to select a title you want to delete, then press **▽**.
- 4 Press **selection keys** to select "DELETE", then press **ENTER**.
 - The confirmation screen appears.
- 5 Press **selection keys** to select "YES", then press **ENTER**.
 - To cancel the deletion, select "NO", then press **ENTER**.
- 6 Press **NAVIGATION** to return to the normal screen.

Delete Unwanted Part Of The Title (DVD-RAM & DVD-RW (VR mode) only)

You can delete unwanted part of a title.

- 1 Press **NAVIGATION** to display the Library Database Navigation screen.
- 2 Press **selection keys** to select "ORIGINAL", then press **ENTER**.
- 3 Press **selection keys** to select a title whose unwanted part you want to delete, then press ∇ .

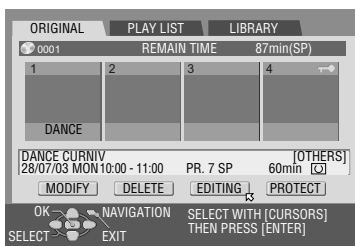

- 4 Press **selection keys** to select "EDITING", then press **ENTER**.
- 5 Press \blacktriangleright to start playback.

- Press \blacktriangleleft or \blacktriangleright to find the point where you want the deletion to begin, then press **II**.

- 6 Confirm the arrow is on "IN", then press **ENTER**.
 - The edit-in time is displayed on the left of the "IN" window.

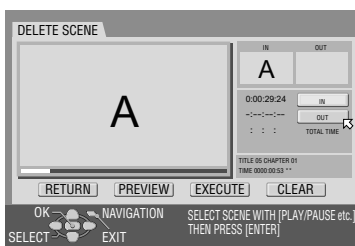

- 7 Press \blacktriangleright to resume playback.
 - Press **II** to pause at the point where you want the deletion to end.
- 8 Confirm the arrow is on "OUT", then press **ENTER**.
 - The edit-out time is displayed on the left of the "OUT" window.
- 9 Press **selection keys** to select "PREVIEW", then press **ENTER** to preview the edited title.

To modify the points

- 1 Press **selection keys** to select "CLEAR", then press **ENTER**.
 - Press **selection keys** to select "RETURN", then press **ENTER** to return to the screen in step 4.
- 2 Press **selection keys** to select "IN".
- 3 Perform steps 5 – 9.
- 10 Press **selection keys** to select "EXECUTE", then press **ENTER**.
 - The confirmation screen appears.
- 11 Press **selection keys** to select "YES", then press **ENTER**.
 - When you cancel the deletion, select "NO", then press **ENTER**.
- 12 Press **NAVIGATION** to return to the normal screen.

NOTES:

- There may be a discrepancy of several seconds between the scene you intend to edit, and the scene which is actually edited.
- Available recording capacity may not match the deleted part after deletion.

46 EN NAVIGATION

Edit Original Information



- Turn on the TV and select an input mode such as EXT1.
- Load a DVD disc to modify.
- Slide the TV/DVD switch to DVD.

ATTENTION:

- It is not possible to modify discs recorded on DVD units from other manufacturers.
- You cannot perform timer recording during editing of index by pressing **NAVIGATION**. Press **NAVIGATION** to clear the editing screen before performing timer recording.

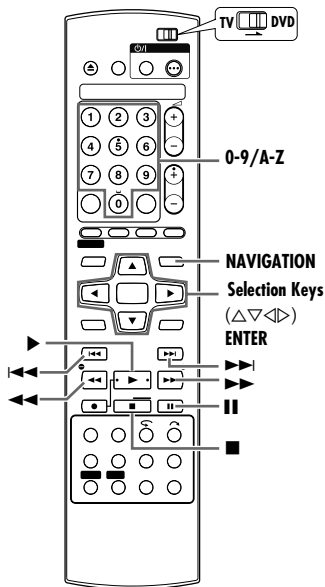

Modify Index

- 1 Press **NAVIGATION** to display the Library Database Navigation screen.
- 2 Press **selection keys** to select "ORIGINAL", then press **ENTER**.
- 3 Press **selection keys** to select a title you want to modify, then press **▽**.
- 4 Press **selection keys** to select "MODIFY", then press **ENTER**.
- 5 Press **selection keys** to select "MODIFY INDEX", then press **ENTER**.
- 6 Press **▶** to start playback. Press **◀◀** or **▶▶** to search for the picture from the title, then press **II**.
- 7 Confirm the arrow is on "REPLACE", then press **ENTER**.
 - The new index appears on the right window.
- 8 Confirm the arrow is on "RETURN", then press **ENTER**.
 - You can confirm the new index.
- 9 Press **NAVIGATION** to return to the normal screen.

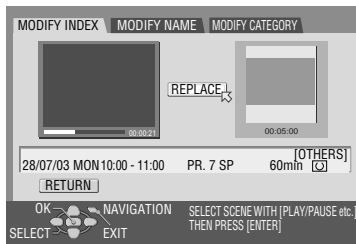

Modify Title Name

- 1 Perform steps 1 – 4 of "Modify Index" (pg. 46) before continuing.
- 2 Press **selection keys** to select "MODIFY NAME", then press **ENTER**.
- 3 Input a new title name.
 - Press **selection keys** to select the desired letter or symbol, then press **ENTER**.
 - To erase the letter, press **selection keys** to select "DELETE" or "DELETE ALL", then press **ENTER**.
 - You can enter up to 64 letters.
 - You can also use the **number keys** on the remote control to input the letters. For example, pressing the **number key "2"** repeatedly changes the letter in the order of "A", "B", "C", "a", "b", "c" and "2". The following buttons can also be used.

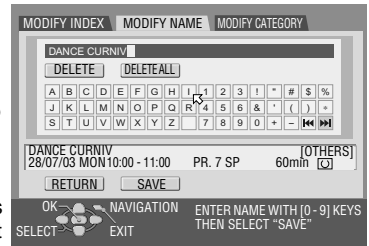

- Number keys: To input alphabet, numbers and space.
- ◀▶ buttons: To move the input position and insertion point.
- button: To correct the letters.
- ◀◀▶▶ buttons: To switch the character table.

- 4 Press **selection keys** to select "SAVE", then press **ENTER**.
 - The new title name is registered.
- 5 Press **selection keys** to select "RETURN", then press **ENTER**.
 - Return to the Library Database Navigation screen to confirm the modified name.
- 6 Press **NAVIGATION** to return to the normal screen.

Modify Category

- 1 Perform steps 1 – 4 of "Modify Index" (pg. 46) before continuing.
- 2 Press **selection keys** to select "MODIFY CATEGORY", then press **ENTER**.
- 3 Press **selection keys** to select the desired category, then press **ENTER**.
- 4 Press **selection keys** to select "RETURN", then press **ENTER**.
 - Return to the Library Database Navigation screen to confirm the modified category.
- 5 Press **NAVIGATION** to return to the normal screen.

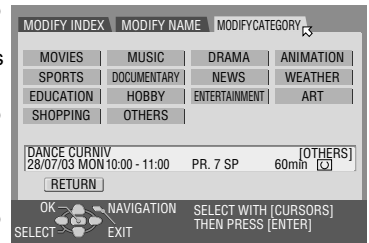

Basic Operation Of Play List Information



Play List

It is a collection of the scenes. A play list can be freely edited and played back without ever changing any original recording data. Using the random access of a disc (which allows video data to be instantly read no matter where it is on the disc), a play list includes information such as the timer counter for the playback start point and end point, indexes for checking the contents of recorded data, category information, and more. Playback according to a play list you have created allows you to enjoy various combinations of video images from a single title.

- Turn on the TV and select an input mode such as EXT1.
- Load a DVD disc to modify.
- Slide the TV/DVD switch to DVD.

ATTENTION:

It is not possible to modify discs recorded on DVD units from other manufacturers.

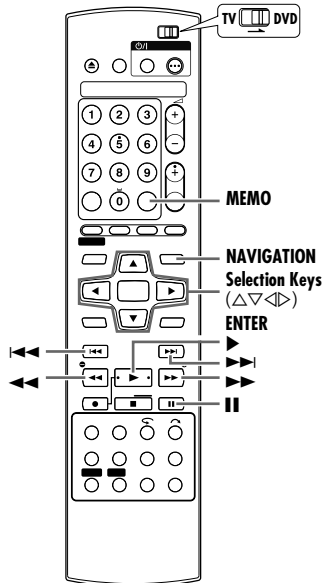

Create Play List

- 1 Press **NAVIGATION** to display the Library Database Navigation screen.
- 2 Press **selection keys** to select "PLAY LIST", then press **ENTER**.
- 3 Press **selection keys** to select "CREATE", then press **ENTER**.
- 4 Press **▶** to start playback.
 - To move to other titles, press **◀◀** or **▶▶**.
 - Press **◀** or **▶** to find the point where you want the created play list to begin, then press **II**.



- 5 Confirm the arrow is on "IN", then press **ENTER**.
 - The edit-in time is displayed on the left of the "IN" window.

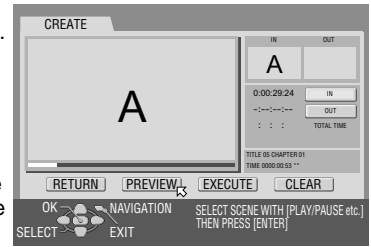

- 6 Press **▶** to resume playback.
 - Press **II** to pause at the point where you want the created play list to end.
- 7 Confirm the arrow is on "OUT", then press **ENTER**.
 - The edit-out time is displayed on the left of the "OUT" window.
 - The edit-out point must come after the edit-in point.
- 8 Press **selection keys** to select "PREVIEW", then press **ENTER** to preview the play list.
 - To cancel play list creation, press **selection keys** to select "RETURN", then press **ENTER**.

To modify the points

- 1 Press **selection keys** to select "CLEAR", then press **ENTER**.
- 2 Press **selection keys** to select "IN".
- 3 Perform steps 4 – 8.

- 9 Press **selection keys** to select "EXECUTE", then press **ENTER**. The play list is created.

- 10 Press **NAVIGATION** to return to the normal screen.

NOTES:

- There may be a discrepancy of several seconds between the scene you intend to edit, and the scene which is actually edited.
- The title, index and category of the play list can be modified in the same way as "ORIGINAL". (pg. 46)
- You can modify the play list that has just been created here by adding, moving, or deleting unwanted parts to create a digest edition, etc.

Play Back Play List

- 1 Press **NAVIGATION** to display the Library Database Navigation screen.
- 2 Press **selection keys** to select "PLAY LIST", then press **ENTER**.
- 3 Press **selection keys** to select a play list to be played back, then press **ENTER**.
 - The unit stops when playback ends, and resumes to a broadcast receiving screen.
 - When you want the multiple play lists to be played back continuously, press **MEMO** after selecting the desired play lists. The numbers of the playback order appear on the index. (Up to 30 titles)

Delete Play List

- 1 Press **NAVIGATION** to display the Library Database Navigation screen.
- 2 Press **selection keys** to select "PLAY LIST", then press **ENTER**.
- 3 Press **selection keys** to select a play list you want to delete, then press **▽**.
- 4 Press **selection keys** to select "DELETE", then press **ENTER**.
 - The confirmation screen appears.
- 5 Press **selection keys** to select "YES", then press **ENTER**.
 - To cancel the deletion, select "NO", then press **ENTER**.
- 6 Press **NAVIGATION** to return to the normal screen.



48 EN NAVIGATION

Edit Play List Information



- Turn on the TV and select an input mode such as EXT1.
- Load a DVD disc to modify.
- Slide the TV/DVD switch to DVD.

ATTENTION:
It is not possible to modify discs recorded on DVD units from other manufacturers.

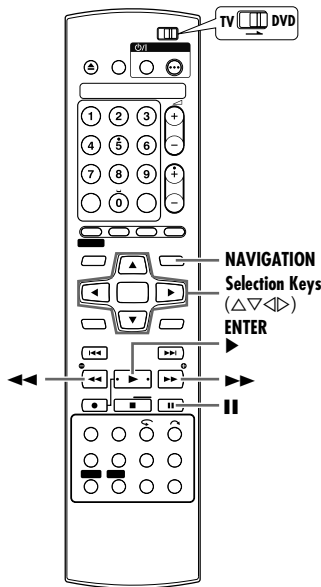

Modify Index

- 1 Press **NAVIGATION** to display the Library Database Navigation screen.
- 2 Press **selection keys** to select "PLAY LIST", then press **ENTER**.
- 3 Press **selection keys** to select a play list you want to modify, then press **▽**.
- 4 Press **selection keys** to select "MODIFY", then press **ENTER**.
- 5 Press **selection keys** to select "MODIFY INDEX", then press **ENTER**.
- 6 Press **▶** to start playback. Press **◀◀** or **▶▶** to search for the picture from the title, then press **||**.
- 7 Confirm the arrow is on "REPLACE", then press **ENTER**.
 - The new index appears on the right window.
- 8 Confirm the arrow is on "RETURN", then press **ENTER**.
 - You can confirm the new index.
- 9 Press **NAVIGATION** to return to the normal screen.

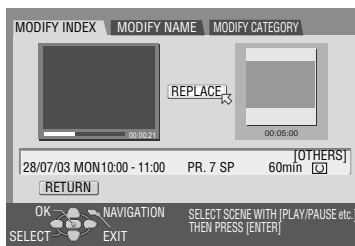
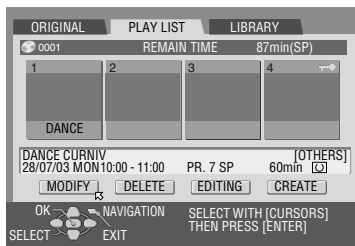

Modify Play List Name

- 1 Perform steps 1 – 4 of "Modify Index" (pg. 48) before continuing.
- 2 Press **selection keys** to select "MODIFY NAME", then press **ENTER**.
- 3 Input a new title name. See "Modify Title Name" (pg. 46).
- 4 Press **selection keys** to select "SAVE", then press **ENTER**.
- 5 Press **selection keys** to select "RETURN", then press **ENTER**.
 - Return to the Library Database Navigation screen to confirm the modified name.
- 6 Press **NAVIGATION** to return to the normal screen.

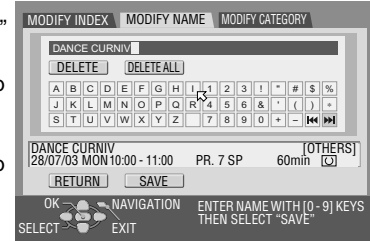

Modify Category

- 1 Perform steps 1 – 4 of "Modify Index" (pg. 48) before continuing.
- 2 Press **selection keys** to select "MODIFY CATEGORY", then press **ENTER**.
- 3 Press **selection keys** to select the desired category, then press **ENTER**.
- 4 Press **selection keys** to select "RETURN", then press **ENTER**.
 - Return to the Library Database Navigation screen to confirm the modified category.
- 5 Press **NAVIGATION** to return to the normal screen.

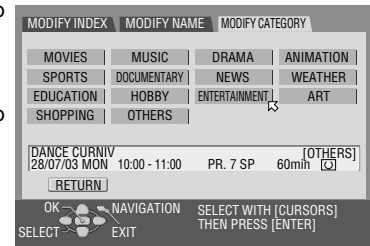

Delete Scenes

- 1 Press **NAVIGATION** to display the Library Database Navigation screen.
- 2 Press **selection keys** to select "PLAY LIST", then press **ENTER**.
- 3 Press **selection keys** to select a play list from which you wish to delete unwanted scenes, then press ∇ .
- 4 Press **selection keys** to select "EDITING", then press **ENTER**.
- 5 Press **selection keys** to select "DELETE SCENE", then press **ENTER**.
- 6 Press \blacktriangleright to start playback.
 - Press \blacktriangleleft or \blacktriangleright to find the point where you want the deletion to begin, then press **II**.
- 7 Confirm the arrow is on "IN", then press **ENTER**.
 - The edit-in time is displayed on the left of the "IN" window.
- 8 Press \blacktriangleright to resume playback.
 - Press **II** to pause at the point where you want the deletion to end.
- 9 Confirm the arrow is on "OUT", then press **ENTER**.
 - The edit-out time is displayed on the left of the "OUT" window.
- 10 Press **selection keys** to select "PREVIEW", then press **ENTER**. A preview of the scene approximately 5 seconds before and after the deleted part is played back.
 - To cancel the deletion, press **selection keys** to select "RETURN", then press **ENTER**.

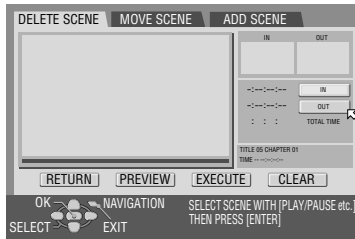
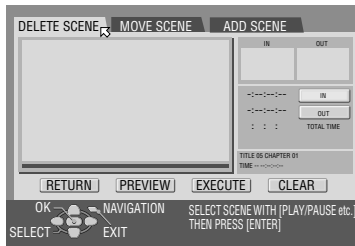
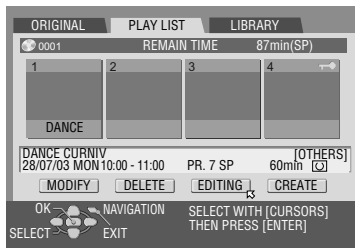

To modify the points

- 1 Press **selection keys** to select "CLEAR", then press **ENTER**.
- 2 Press **selection keys** to select "IN".
- 3 Perform steps 6 – 10.
- 11 Press **selection keys** to select "EXECUTE", then press **ENTER**.
- 12 Press **NAVIGATION** to return to the normal screen.

Move Scenes

- 1 Press **NAVIGATION** to display the Library Database Navigation screen.
- 2 Press **selection keys** to select "PLAY LIST", then press **ENTER**.
- 3 Press **selection keys** to select a play list which you wish to move a scene, then press ∇ .
- 4 Press **selection keys** to select "EDITING", then press **ENTER**.
- 5 Press **selection keys** to select "MOVE SCENE", then press **ENTER**.
- 6 Press \blacktriangleright to start playback.
 - Press \blacktriangleleft or \blacktriangleright to find the point where you want the moved scene to begin, then press **II**.
- 7 Confirm the arrow is on "IN", then press **ENTER**.
 - The edit-in time is displayed on the left of the "IN" window.
- 8 Press \blacktriangleright to start playback.
 - Press **II** to pause at the point where you want the moved scene to end.
- 9 Confirm the arrow is on "OUT", then press **ENTER**.
 - The edit-out time is displayed on the left of the "OUT" window.
- 10 Press \blacktriangleright to start playback.
 - Find the point where you want the moved scene to be moved, then press **II**.
- 11 Confirm the arrow is on "MOVE TO", then press **ENTER**.
- 12 Press **selection keys** to select "PREVIEW", then press **ENTER**. A preview of approximately 5 seconds before and after the point to which the scene has been moved is played back.
 - To cancel the moving, press **selection keys** to select "RETURN", then press **ENTER**.

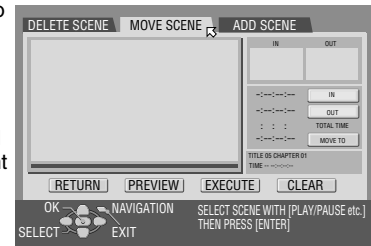
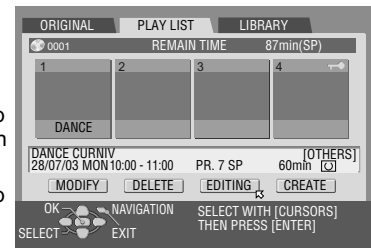

To modify the points

- 1 Press **selection keys** to select "CLEAR", then press **ENTER**.
- 2 Press **selection keys** to select "IN".
- 3 Perform steps 6 – 12.
- 13 Press **selection keys** to select "EXECUTE", then press **ENTER**.
- 14 Press **NAVIGATION** to return to the normal screen.

50 EN NAVIGATION**Add Scenes**

- 1** Press **NAVIGATION** to display the Library Database Navigation screen.
- 2** Press **selection keys** to select "PLAY LIST", then press **ENTER**.
- 3** Press **selection keys** to select a play list to which you wish to add a scene, then press **∇**.
- 4** Press **selection keys** to select "EDITING", then press **ENTER**.
- 5** Press **selection keys** to select "ADD SCENE", then press **ENTER**.
- 6** Press **▶** to start playback.
 - To move to other titles, press **◀◀** or **▶▶**.
 - Press **◀** or **▶** to find the point where you want the created play list to begin, then press **II**.
- 7** Perform steps 5 – 10 of "Create Play List" (pg. 47).

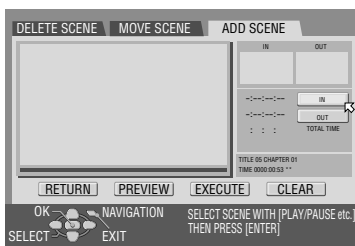

Edit Library Information



Each disc recorded on this unit is automatically numbered. If this number is retained, it is possible to find out the titles recorded in a disc quickly. Title information can be registered in the unit's memory for up to 1300 titles.

NOTE:

If you do not want the information to be registered in the library automatically, set "SAVE AS LIBRARY" to "OFF". (pg. 61)

- Turn on the TV and select an input mode such as EXT1.
- Slide the TV/DVD switch to DVD.

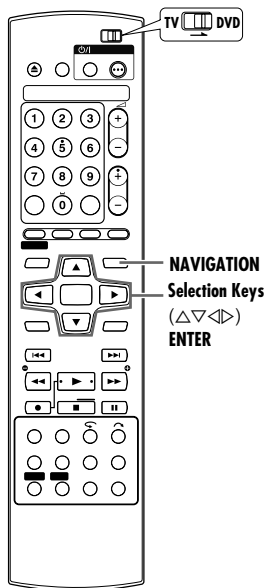

Scan For Title From Library

- 1 Press **NAVIGATION** to display the Library Database Navigation screen.
- 2 Press **selection keys** to select "LIBRARY", then press **ENTER**.
- 3 Select the appropriate sort button to sort the information, then press **ENTER**.
 - "DISC No.": Sort by disc number.
 - "CATEGORY": Sort by category.
 - "DATE": Sort by date.
 - "NAME": Sort by name.
 - Each time when the sort button is selected and **ENTER** is pressed, the sorting order switches between ascending order and descending order.
- 4 Press **selection keys** to select the desired title, then press **ENTER**.
 - If the DVD disc loaded on this unit contains the selected title, the selected title and all subsequent titles will be played back.

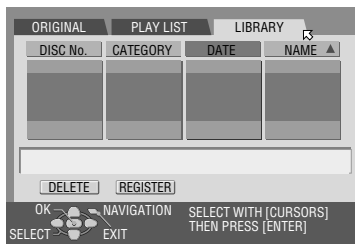

When the disc that contains the selected title is not loaded

A prompt screen appears. Load the disc after pressing **ENTER** to close the prompt screen. Then perform steps 1 – 4.

NOTE:

If a disc registered in the library is recorded or modified on DVD units from other manufacturers, it may become impossible to operate properly.

Register Disc

If a disc that is not registered in the library is loaded, a message confirming whether the disc should be registered appears when the Library Database Navigation screen is displayed. If registering, perform the following procedure.

- 1 Press **NAVIGATION** to display the Library Database Navigation screen.
- 2 Press **selection keys** to select "LIBRARY".
- 3 Press **selection keys** to select "REGISTER", then press **ENTER**.
 - To quit registration, select "CANCEL", then press **ENTER**.
- 4 Press **NAVIGATION** to return to the normal screen.

NOTES:

- It is not possible to register discs used for On-Disc Timer Programming. (pg. 39)
- It is not possible to register discs formatted on devices other than JVC's DVD recorders.
- It is not possible to register discs recorded on devices other than JVC's DVD recorders.

Delete Information

- 1 Perform steps 1 – 3 of "Scan For Title From Library" (pg. 51) before continuing.
- 2 Press **selection keys** to select a title whose information you want to delete, then press **▽**.
- 3 Press **selection keys** to select "DELETE", then press **ENTER**.
 - The confirmation screen appears.
- 4 Press **selection keys** to select "DELETE", then press **ENTER**.
 - To cancel the information deletion, select "CANCEL", then press **ENTER**.
- 5 Press **NAVIGATION** to return to the normal screen.

Playback With MP3/JPEG Navigation



This unit can play back discs that contain MP3 sound files and JPEG image files taken with digital still cameras or other devices. The MP3/JPEG Navigation enables you to search and select the desired files recorded on CD-R/RW or CD-ROM discs very easily.

- Turn on the TV and select an input mode such as EXT1.

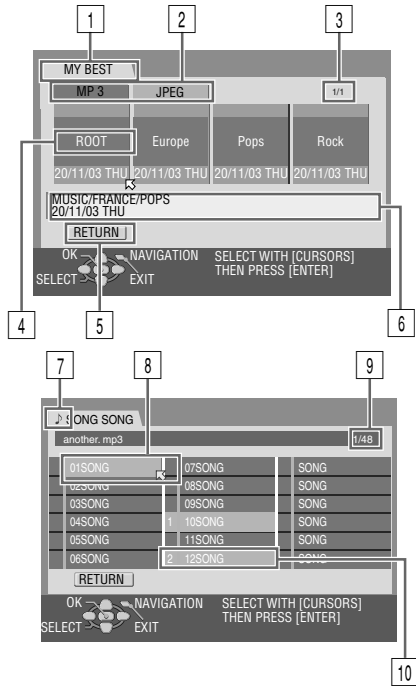

- 1 Name of the inserted disc
- 2 Sort buttons ("MP 3"/"JPEG")
- 3 Selected group number/total number of groups on the disc
- 4 Group name
- 5 Return button
- 6 Group name/Created date
- 7 File type indicator
 ♪: MP3
 📷: JPEG
- 8 Selected file
- 9 Selected file number/total number of files in the group that contains the selected file
- 10 Programme number/file name

Locating The Desired Group And Tracks

- 1 Load a disc.
- 2 Press **NAVIGATION**.
- 3 Press **selection keys** to select "MP 3" or "JPEG", then press **ENTER**.
- 4 Press **selection keys** to select the desired group, then press **ENTER**.
 - A list of files in the selected group appears.
- 5 Press **selection keys** to select a file you want to play back, then press **ENTER**. The unit starts playback from the selected file.
 - Playback stops when all the files in the selected group are played back.

NOTES:

- If you press **▶** instead of **ENTER** in step 4, the unit starts playback from the first file of the group.
- JPEG files are played back as a slide show at the set intervals. (pg. 33)
- If a file name includes any 2 byte character, the unit may not show the file name correctly.
- The order of the groups and items shown in steps 4 and 5 may differ from the order shown on your PC.
- When you want multiple files to be played back continuously, press **MEMO** instead of **ENTER** in step 5. Playbacks in the specified order when **▶** is pressed. (Up to 30 titles)
- If you have specified a wrong selection, press **CANCEL**. Or press **CLEAR** (■), all the title numbers are erased.

After all the files are played back

- 1 Perform steps 1 – 4.
- 2 Press **CLEAR** (■).
 - The title numbers are reset and erased.
- 3 Press **NAVIGATION** to return to the normal screen.

DV Dubbing

You can dub programmes from a camcorder or DV equipment connected to the unit with a DV cable. The unit's remote control allows you the limited control of the connected camcorder or DV equipment functions during dubbing.

NOTES:

- Use the DV cable VC-VDV 204U for connection.
- When you connect a PC to the [DV IN] connector, we do not assure the normal operation of this unit.

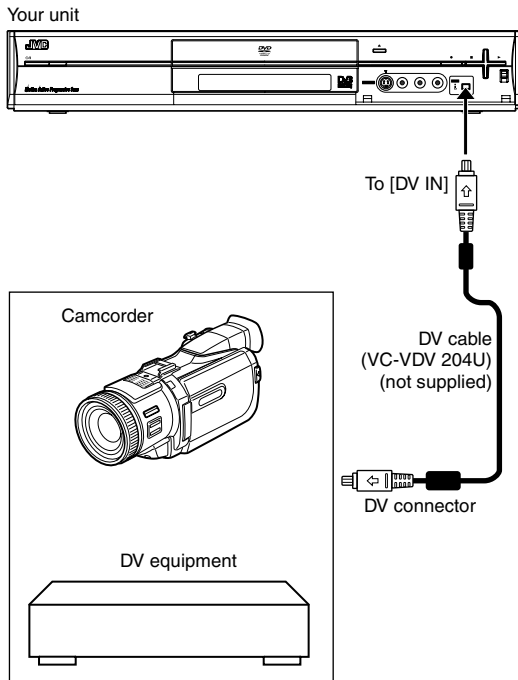

The following on-screen display for DV dubbing appears when **ON SCREEN** is pressed while the channel has been set to "DV".

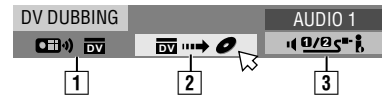

1 DV dubbing controller

If this mark is not displayed, check whether the DV equipment has been connected to the unit.

2 Auto capture button

Select to start or pause the dubbing. If **ENTER** is pressed when the DV device is in the pause condition, preroll editing* where it is possible to dub with a start time that is highly accurate will be activated. When the DV device cannot be operated from the unit (such as in camera mode), proceed with normal recording (see pg. 34).

* Preroll editing refers to the playback after the DV tape is slightly rewind. (For DV devices that do not support the -1x speed, the rewinding time may be longer.)

3 Sound monitor switch

For selecting the desired sound format for dubbing.

- 1 Connect a camcorder or DV equipment to the [DV IN] connector on the unit's front panel.
- 2 Press **PR +/-** to set the channel to "DV".
 - The on-screen display for DV dubbing appears.
- 3 Press **REC MODE** repeatedly to set the recording mode.
- 4 Locate the point from where you want to start dubbing, then stop or pause playback by pressing the following buttons on the remote control: **▶**, **▶▶**, **◀◀**, **■**, **||**.
 - To play back in slow speed (1/10 of the normal speed), press **||** to pause playback, then press **◀◀** or **▶▶**.
 - To play back frame-by-frame, press **||** to pause playback, then press **||** repeatedly. Each press of **||** advances a frame.
 - To change the playback direction, press **◀◀** or **▶▶**.
- 5 Press **selection keys** to select **AUDIO 1**, then press **ENTER**. Select the desired sound track from the pull-down menu, then press **ENTER**.

AUDIO 1:

Select this to record the original stereo sound played back on the connected DV equipment.

AUDIO 2:

Select this to record the dubbed stereo sound played back on the connected DV equipment.

MIX:

Select this to record the sound of both "AUDIO 1" and "AUDIO 2".

- Note that this selection is not available when the source programme is recorded in 16BIT (48 kHz) mode.

6 Press selection keys to select **DV**, then press **ENTER**.

The dubbing starts.

- Playback on the external DV equipment and recording on the unit should start simultaneously.
- To pause dubbing, press **selection keys** to select **DV**, then press **ENTER**. Both the unit and the external DV equipment pause dubbing.
- To resume dubbing, press **selection keys** to select **DV**, then press **ENTER** to start dubbing.

7 Press **■** to stop dubbing.

- Both the unit and the external DV equipment stop dubbing.

NOTES:

- Dubbing copyright guarded programmes is not possible.
- Original DV information such as the recording date and time are not recorded.
- The superimposed indication during the operation or dubbing is not recorded.
- If the dubbing is paused while the channel is set to "DV", you cannot switch channels.
- Only DV format video can be dubbed. It is not possible to dub MPEG2 format video.

When you dub from DV equipment other than a camcorder

- 1 Perform steps 1 – 3.
- 2 Locate the point from where you want to start dubbing, then stop on the DV equipment.
 - If you pause the DV equipment in this step, a few second's still picture will be recorded at the beginning of the recorded programme.
- 3 Set the input mode to "DV INPUT" on the DV equipment.
 - If input mode is set to other than "DV INPUT", unwanted pictures may be recorded at the beginning of the recorded programme.
- 4 Perform steps 6 and 7.

To skip unwanted part of the source picture

Press **ENTER** to stop both equipment, press ►, ►► or ◀◀ to locate the point where you want to resume dubbing, then press ■.

- Press **selection keys** to select , then press **ENTER** to start dubbing.

Digital Audio Dubbing

You can dub selected audio from a DVD or Audio CD disc to a digital audio device. However, it is not possible to dub copy-protected discs.

- Turn on the TV and select an input mode such as EXT1.

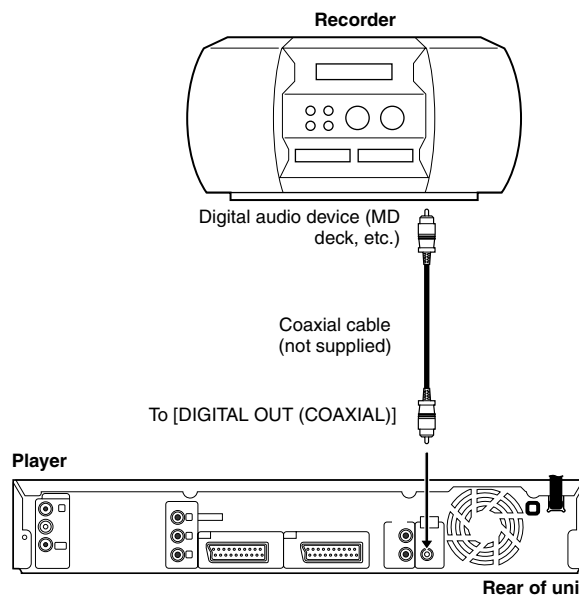
Example: Dubbing to an MD

- 1 Connect the unit and a digital audio device using an optional coaxial cable.
- 2 Place a disc on the unit and load an MD on the connected digital audio device.
- 3 Select the audio to be dubbed.
- 4 Start playback slightly before the actual point from where you wish to start dubbing.
- 5 Press **II** to pause playback.
- 6 Select the input mode on the connected digital audio device.
- 7 Press ► to start playback on the unit.
- 8 Start recording on the digital audio device.
- 9 Stop recording on the digital audio device. Then press ■ to stop playback on the unit.

NOTE:

There may be a discrepancy of several seconds between where you intend editing to start, and where it actually starts.

Edit From A Camcorder

You can use a camcorder as the source player and your unit as the recording deck.

1 If the camcorder has no S-VIDEO output connector:

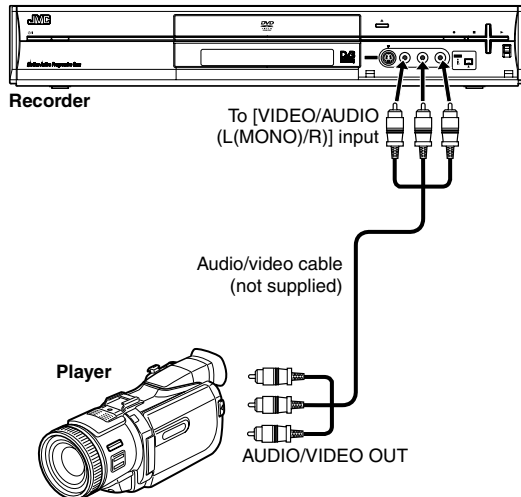

2 If the camcorder has an S-VIDEO output connector:

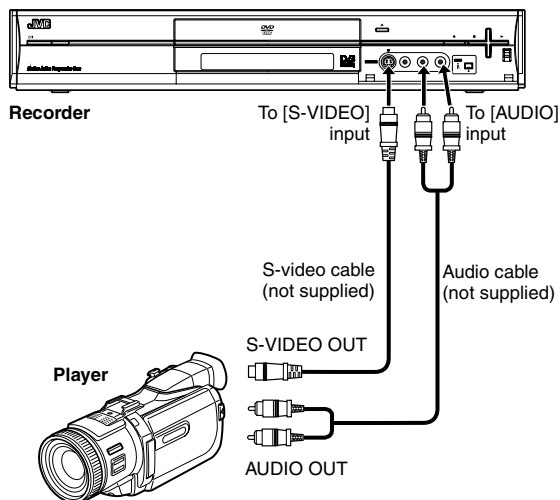

1 Make connections.

- 1 If the camcorder has no S-VIDEO output connector:
 - connect the camcorder's AUDIO/VIDEO OUT connectors to the unit's [VIDEO/AUDIO (L(MONO)/R)] input connectors on the front panel.
 - When using a monaural camcorder, connect its AUDIO OUT connector to the [AUDIO (L(MONO))] input connector on your unit.
- 2 If the camcorder has an S-VIDEO output connector:
 - connect the camcorder's AUDIO OUT and S-VIDEO OUT connectors to the unit's [AUDIO (L(MONO)/R)] and [S-VIDEO] input connectors on the front panel.

2 Press **PR +/-** to select "F-1".

- Set "F-1 INPUT" to "VIDEO" for the [VIDEO] input connector, or "S-VIDEO" for the [S-VIDEO] input connector, depending on the connector being used. (pg. 58)

3 Press **REC MODE** repeatedly to set the recording mode.

4 Start playback on the camcorder slightly before the actual point from where you wish to start dubbing.

5 Press **●** on the unit to start recording. Or while holding **●**, press **▶** on the remote control. The dubbing starts.

6 Upon completing dubbing, stop the unit and the camcorder.

- Stop recording on the recording deck (your unit), then stop playback on the source player (camcorder).

NOTES:

- All necessary cables can be obtained from your dealer.
- Refer to the camcorder's instruction manual for operating procedure.
- The quality of the dubbed picture is poorer than that of the original.

Edit To Or From Another Recorder

You can use your unit as the source player or as the recording deck.

NOTE:

When using another recorder as the recording deck, refer to its instruction manual.

1 When using your unit as the source player

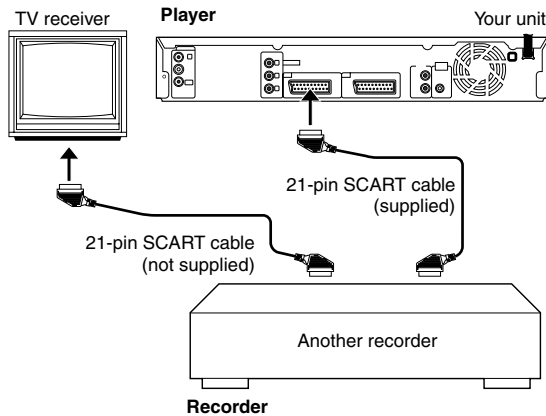

2 When using your unit as the recording deck

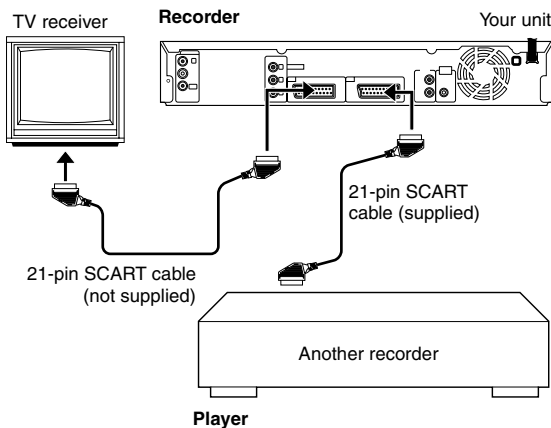

1 Connect another recorder's 21-pin SCART connector to the unit's 21-pin SCART connector as illustrated.

- 1** When using your unit as the source player:
 - connect its [L-1 IN/OUT] connector to the recording deck.
- 2** When using your unit as the recording deck:
 - connect its [L-2 IN] connector to the source player.
 - If another recorder is compatible with the Y/C signal:
 - when using your unit as the source player, set "L-1 OUTPUT" to "SCART S-VIDEO". (pg. 57)
 - when using your unit as the recording deck, set "L-2 SELECT" to "S-VIDEO/RGB". (pg. 58)

2 When using this unit as the recording deck, press **PR +/-** to select "L-2".

- Set "L-2 SELECT" to "VIDEO/RGB" or "S-VIDEO/RGB". (pg. 58)

3 When using this unit as the recording deck, press **REC MODE** repeatedly to set the recording mode.

4 Engage the Play mode of the source player.

5 Engage the Record mode of the recording deck.

6 Stop recording on the recording deck, then stop playback on the source player.

NOTES:

- All necessary cables can be obtained from your dealer.
- For Y/C signal input/output, be sure to use a 21-pin SCART cable that is compatible with the Y/C signal.
- When you use this unit as the source player for editing, be sure to set "SUPERIMPOSE" to "OFF" before starting. (pg. 61)
- If you are using another recorder with S-Video and Audio output connectors, connect its S-Video and Audio output connectors to this unit's [S-VIDEO] and [AUDIO] input connectors on the front panel. Then, set the unit's input mode to "F-1" in step 2, and set "F-1 INPUT" to "S-VIDEO". (pg. 58)

Output/Input Set

- Turn on the TV and select an input mode such as EXT1.
- Slide the TV/DVD switch to **DVD**.

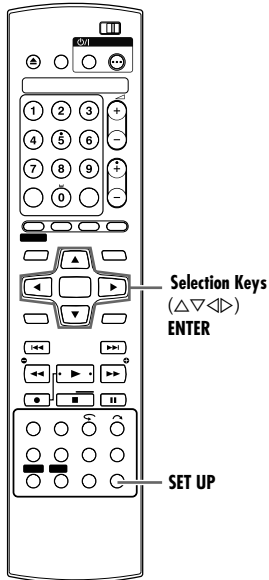

L-1 Output And L-1 Input Setting

The [L-1 IN/OUT] connector accepts and delivers either a composite signal (regular video signal) or a Y/C signal (a signal in which the luminance and chrominance signals are separated). Set "L-1 OUTPUT" and "L-1 INPUT" to the appropriate mode depending on the type of appliance connected to the unit's [L-1 IN/OUT] connector.

- 1 Press **SET UP** to access the Main Menu screen.
- 2 Press **selection keys** to select "FUNCTION SET UP", then press **ENTER**.
- 3 Press **selection keys** to select "VIDEO IN/OUT", then press **ENTER**.
- 4 Press **selection keys** to select "L-1 OUTPUT" or "L-1 INPUT", then press **ENTER**.
- 5 Press **selection keys** to select the appropriate setting, then press **ENTER**.
- 6 Press **SET UP** to complete the setting.

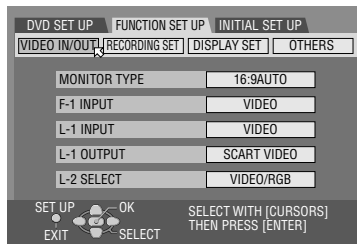

* The **boldface** settings below indicate the settings at your purchase.

■ L-1 OUTPUT — SCART VIDEO / SCART S-VIDEO / SCART RGB / COMPONENT

SCART VIDEO:

If a connected appliance's input is compatible only with regular video signals, set to "SCART VIDEO".

SCART S-VIDEO:

If a connected appliance's input is compatible with Y/C signals, set to "SCART S-VIDEO". You can obtain a high-quality picture. (For connection, be sure to use a 21-pin SCART cable that is compatible with the Y/C signal.)

SCART RGB:

If a connected appliance's input is compatible with RGB signals, set to "SCART RGB". You can obtain a high-quality RGB picture.

COMPONENT:

If a connected appliance's input is compatible with Y/P_B/P_R signals, set to "COMPONENT". You can obtain a high-quality Y/P_B/P_R picture. Switch the TV to the input that you can watch component video pictures.

■ L-1 INPUT — VIDEO / S-VIDEO

VIDEO:

If a connected appliance's output is compatible only with regular video signals, set to "VIDEO".

S-VIDEO:

If a connected appliance's output is compatible with Y/C signals, set to "S-VIDEO". You can obtain a high-quality picture. (For connection, be sure to use a 21-pin SCART cable that is compatible with the Y/C signal.)

NOTES:

- If "L-1 OUTPUT" is set to "SCART S-VIDEO" or "SCART RGB", it is not possible to set "L-1 INPUT" to "S-VIDEO".
- If "L-2 SELECT" is set to "SAT S-VIDEO/RGB", it is not possible to set "L-1 INPUT" to "S-VIDEO".
- Component video signals are not output from the [L-1 IN/OUT] connector.
- When Progressive scan mode is engaged, it is not possible to select the setting of "L-1 OUTPUT".

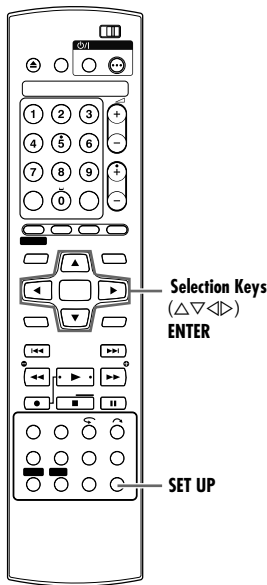

L-2 Select Setting

Set "L-2 SELECT" to the appropriate mode depending on the type of appliance connected to the unit's [L-2 IN] connector.

- 1 Perform steps 1 and 2 of "L-1 Output And L-1 Input Setting" (pg. 57).
- 2 Press **selection keys** to select "L-2 SELECT", then press **ENTER**.
- 3 Press **selection keys** to select the appropriate setting, then press **ENTER**.
- 4 Press **SET UP** to complete the setting.

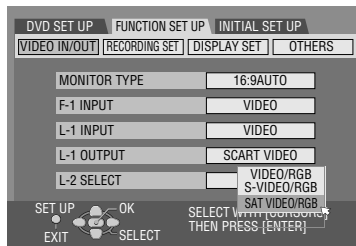

* The **boldface** settings below indicate the settings at your purchase.

■ L-2 SELECT — VIDEO/RGB / S-VIDEO/RGB / SAT VIDEO/RGB / SAT S-VIDEO/RGB

Select "VIDEO/RGB" or "S-VIDEO/RGB" to use this unit as the recording deck with the player connected to the [L-2 IN] connector, or to use the satellite receiver connected to the [L-2 IN] connector.

VIDEO/RGB:

If a connected appliance's output is compatible only with regular video signals, set to "VIDEO/RGB".

S-VIDEO/RGB:

If a connected appliance's output is compatible with Y/C signals, set to "S-VIDEO/RGB". You can obtain a high-quality picture. (For connection, be sure to use a 21-pin SCART cable that is compatible with the Y/C signal.)

Select "SAT VIDEO/RGB" or "SAT S-VIDEO/RGB" to view a satellite programme with the TV set while the unit is turned off.

SAT VIDEO/RGB:

If a connected satellite receiver's output is compatible with regular video signals, set to "SAT VIDEO/RGB".

SAT S-VIDEO/RGB:

If a connected satellite receiver's output is compatible with Y/C signals, set to "SAT S-VIDEO/RGB". You can obtain a high-quality S-VIDEO picture. (For connection, be sure to use a 21-pin SCART cable that is compatible with the Y/C signal.)

NOTES:

- When RGB signals are output from the connected appliance such as a satellite receiver, the unit will record in RGB signals.
- If you have a satellite receiver connected to the [L-2 IN] connector, be sure to set "L-2 SELECT" back to appropriate mode after editing.
- When you want to play back and record RGB picture, connect the satellite receiver's RGB compatible output connector to the unit's input connector.
- If you are not connecting a satellite receiver to the [L-2 IN] connector, leave "L-2 SELECT" set to "VIDEO/RGB".
- When "L-2 SELECT" is set to "SAT VIDEO/RGB" and "SAT S-VIDEO/RGB", "SAT" appears on the TV screen or front display panel instead of "L-2".
- If "L-1 OUTPUT" is set to "SCART S-VIDEO", it is not possible to set "L-2 SELECT" to "SAT VIDEO/RGB".
- If "L-1 OUTPUT" is set to "SCART RGB", it is not possible to set "L-2 SELECT" to "SAT S-VIDEO/RGB".
- If "L-1 OUTPUT" is set to "COMPONENT" and "L-2 SELECT" to "SAT VIDEO/RGB" or "SAT S-VIDEO/RGB", be sure to connect the [L-1 IN/OUT] connector with a TV.
- If "L-2 SELECT" is set to "SAT S-VIDEO/RGB", be sure to set "L-1 OUTPUT" to "SCART S-VIDEO".

F-1 Input Setting

Set "F-1 INPUT" to the appropriate mode depending on the connector ([VIDEO] or [S-VIDEO]) being used on the front panel.

- 1 Perform steps 1 and 2 of "L-1 Output And L-1 Input Setting" (pg. 57).
- 2 Press **selection keys** to select "F-1 INPUT", then press **ENTER**.
- 3 Press **selection keys** to select the appropriate setting, then press **ENTER**.
- 4 Press **SET UP** to complete the setting.

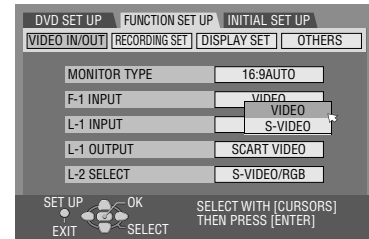

* The **boldface** settings below indicate the settings at your purchase.

■ F-1 INPUT — VIDEO / S-VIDEO

VIDEO:

When connecting an appliance to the [VIDEO] input connector, set to "VIDEO".

S-VIDEO:

When connecting an appliance to the [S-VIDEO] input connector, set to "S-VIDEO".

Connecting To A Satellite Receiver

Connect the satellite receiver to the [L-2 IN] connector, then connect the [L-1 IN/OUT] connector to the TV's connector.

NOTES:

- Set "L-2 SELECT" to "VIDEO/RGB" or "S-VIDEO/RGB". (pg. 58)
- You can use the Automatic Satellite Programme Recording function with this connection. (pg. 42)
- To record a programme via the satellite receiver, select L-2 mode by pressing **PR +/-** so that "L-2" appears on the front display panel.
- For details, refer to the instruction manual of the satellite receiver.

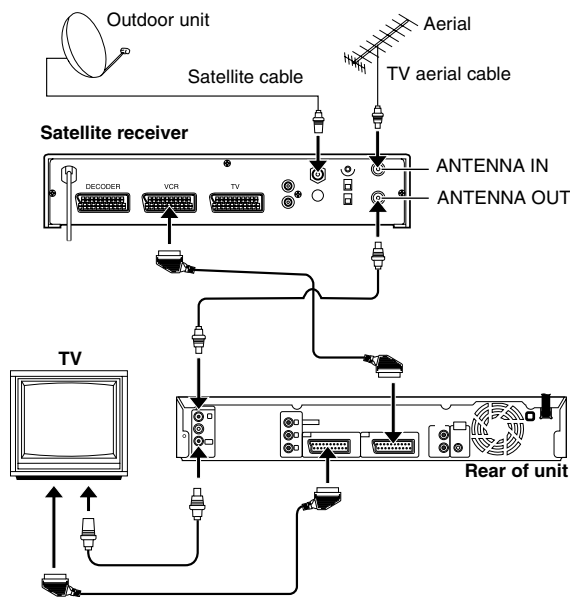

IMPORTANT

When you set "L-2 SELECT" to "SAT VIDEO/RGB" or "SAT S-VIDEO/RGB" (pg. 58), it is possible to view a satellite broadcast with the TV set to an input mode such as EXT1 even if the unit is turned off. When the unit is in Stop mode or recording, press **TV/VIDEO** on the remote control to turn off the Video indicator on the front display panel.

- If you turn on the unit when the satellite receiver's power is off, nothing appears on the TV screen. In this case, turn on the satellite receiver, or set the TV to its TV mode, or slide the **TV/DVD** switch to **TV** to set the unit to the AV mode.

Connecting To A Dolby Digital Decoder Or An Amplifier With Built-in DTS

These instructions enable you to connect your unit to a Dolby Digital Decoder or an amplifier with built-in DTS.

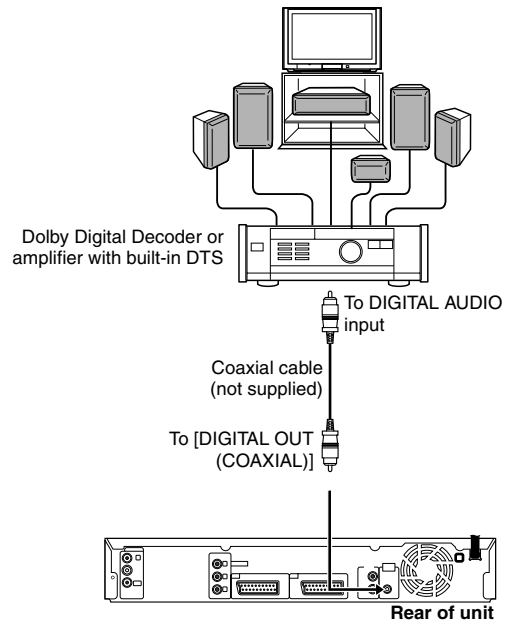

- 1 Connect the unit and a Dolby Digital Decoder or an amplifier with built-in DTS using an optional coaxial cable.

NOTE:

For details on [DIGITAL AUDIO OUT] connector setting, refer to "DIGITAL AUDIO OUT". (pg. 60)

60 EN **SUBSIDIARY SETTINGS**

Mode Set

- Turn on the unit.
- Turn on the TV and select an input mode such as EXT1.
- Slide the **TV/DVD** switch to **DVD**.

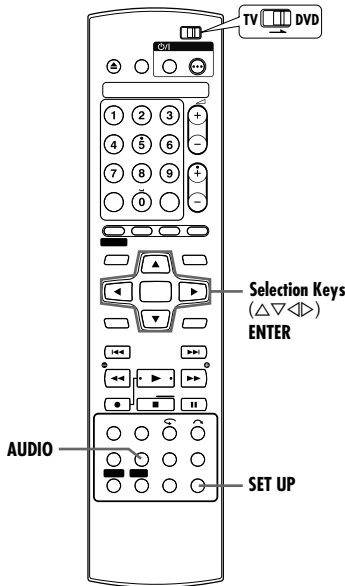

Various modes of this unit are categorised into menus nested in 2 levels shown in the following table. To change the settings of these modes, find the desired mode in the menu, then follow the procedure below. (For details on each menu, see pages 60 – 61.)

DVD SET UP	LANGUAGE SET (pg. 19) AUDIO OUTPUT (pg. 60) UTILITY (pg. 67, 68)
FUNCTION SET UP	VIDEO IN/OUT (pg. 19, 57) RECORDING SET (pg. 61) DISPLAY SET (pg. 61) OTHERS (pg. 61)
INITIAL SET UP	CHANNEL SET (pg. 64) DTV SETTING (pg. 20) CLOCK SET (pg. 66)

• The procedure below shows how to set the desired option of the "XP MODE REC AUDIO" mode as an example.

- 1 Press **SET UP** to access the Main Menu screen.
- 2 Press **selection keys** to select "FUNCTION SET UP", then press **ENTER**.
- 3 Press **selection keys** to select "RECORDING SET", then press **ENTER**.
- 4 Press **selection keys** to select "XP MODE REC AUDIO", then press **ENTER**.
- 5 Press **selection keys** to select the desired setting, then press **ENTER**.
- 6 Press **SET UP** to complete the setting.

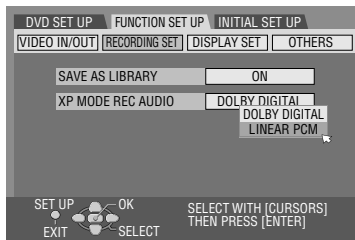

* The **boldface** settings below indicate the settings at your purchase.

AUDIO OUTPUT

■ **DIGITAL AUDIO OUT — DOLBY DIGITAL/PCM / **STREAM/PCM** / PCM ONLY**

Set to the appropriate mode according to the type of the device connected to [DIGITAL AUDIO OUT] connector.

DOLBY DIGITAL/PCM:

Select this when you connect the digital input connector of a Dolby Digital Decoder or an amplifier with a built-in Dolby Digital Decoder.

STREAM/PCM:

Select this when you connect the digital input connector of an amplifier with a built-in DTS, Dolby Digital, or MPEG multichannel decoder.

PCM ONLY:

Select this when you connect the linear PCM digital input of other audio equipment (amplifier, MD or DAT deck, etc.).

NOTE:

If you watch or play back a programme recorded on a DVD-RAM or DVD-RW (VR mode only) disc which contains multiple audio languages, select "PCM ONLY" in advance and choose main or sub audio with **AUDIO**.

■ **ANALOG AUDIO OUT — **STEREO** / DOLBY SURROUND**

Select the appropriate setting to accommodate the unit to the connected A/V equipment. This function takes effect when a DVD VIDEO disc is played back.

STEREO:

Select this when listening to conventional two-channel stereo audio with the unit's [AUDIO OUT] connectors connected to a stereo amplifier/receiver or TV set, or in case you want to record the audio from a DVD VIDEO disc to a Mini Disc, etc.

DOLBY SURROUND:

Select this when listening to audio with the unit's [AUDIO OUT] connectors connected to an amplifier/receiver with a built-in surround decoder or a surround decoder.

■ **D. RANGE CONTROL — **NORMAL** / WIDE RANGE / TV MODE**

The dynamic range (the difference between the loudest sound and the quietest one) can be compressed during playback of a programme encoded in Dolby Digital format.

This function takes effect when a DVD VIDEO disc recorded in Dolby Digital format is played back at low or middle volume.

NORMAL:

Normally select this setting to activate this function.

WIDE RANGE:

Select this to deactivate this function when you enjoy programme with wide dynamic range.

TV MODE:

Select this when connecting to a TV. Even soft sound can be well heard.

NOTES:

- This function has no effect on programmes other than those recorded in Dolby Digital format.
- The effect of "NORMAL" and "WIDE RANGE" may not be different depending on discs.

■ **OUTPUT LEVEL — **STANDARD** / LOW**

You can lower the output level of analogue audio to accommodate the unit to the connected A/V equipment.

STANDARD:

Normally select this setting.

LOW:

The output level of analogue audio is lowered.

RECORDING SET

■ SAVE AS LIBRARY — OFF / ON

When this function is set to "ON", the recording information is automatically stored in the library. For details, refer to "Edit Library Information" (pg. 51).

■ XP MODE REC AUDIO — DOLBY DIGITAL / LINEAR PCM

You can select the audio format when you record a title in XP mode. When this function is set to "LINEAR PCM", you can obtain a high-quality audio sound.

DOLBY DIGITAL:

To record in Dolby Digital format.

LINEAR PCM:

To record in Linear PCM format.

DISPLAY SET

■ SUPERIMPOSE — OFF / AUTO

When this function is set to "AUTO", various operational indicators appear on the TV screen.

OFF:

To turn off superimposed indications.

AUTO:

To superimpose operational indications for approximately five seconds just after the corresponding operation.

NOTES:

- Even when "SUPERIMPOSE" is set to "OFF", you can display the various operational indicators by pressing **ON SCREEN** on the remote control. To clear the operational indicators, press **ON SCREEN** again.
- When you use this unit as the source player for editing, be sure to set "SUPERIMPOSE" to "OFF" before starting. (pg. 56)
- When you select "AUTO", during playback, the operation mode indicators may be disturbed depending on the type of disc being used.

■ GREY BACK — OFF / ON

OFF:

Select this when you want to receive an unstable channel with poor signals.

ON:

When this function is set to "ON", the TV screen becomes all grey when receiving a channel not in use.

■ DIMMER — BRIGHT / DIMMED1 / DIMMED2 / OFF

You can change the brightness of the front display panel.

BRIGHT:

Normally select this. To turn on the display and blue lamp of the front display panel.

DIMMED1/DIMMED2:

To change the brightness level, and turn off the blue lamp of the front display panel.

OFF:

To turn off the display and blue lamp of the front display panel.

■ POWER SAVE — OFF / ON

When this function is set to "ON", you can reduce the power consumption while the unit is turned off.

NOTE:

During Power Save mode, the front display panel will be turned off.

OTHERS

■ AUTO TIMER — OFF / ON

This is the setting for engaging timer recording standby mode.

OFF:

Press **TIMER** to engage timer recording standby mode.

ON:

Timer recording standby mode is automatically engaged when the unit is turned off.

■ RESUME — OFF / ON / DISC RESUME

When this function is set to "ON" or "DISC RESUME", you can use the resume function.

OFF:

You cannot use the resume function.

ON:

The resume function works on the disc loaded on the unit.

DISC RESUME:

The unit retains a memory of the resume points of the last 30 discs played back, even though they have been ejected.

NOTE:

"DISC RESUME" setting works on DVD VIDEO, VCD, SVCD and finalised DVD-R/DVD-RW (Video mode) discs. For other types of discs, the function under "ON" setting will be applied even if "RESUME" is set to "DISC RESUME".

62 EN **SUBSIDIARY SETTINGS**

Remote Control Functions

Remote Control 1/2/3/4 Code Switching

The remote control is capable of controlling four JVC video units independently. Each of the units can respond to one of the four codes (1, 2, 3 or 4). The remote control is preset to send code 3 signals because your unit is initially set to respond to code 3 signals. You can easily modify your unit to respond to code 1, 2 or 4 signals.

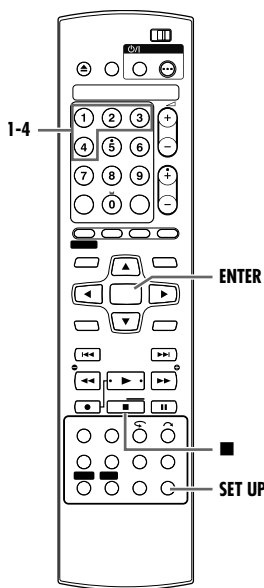
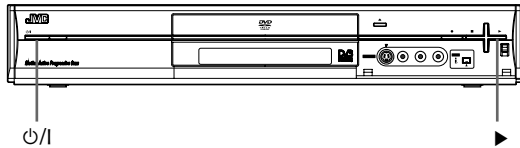

- Keep pressing **SET UP** down during step 1.
- 1** Press the **number key "1"** for 1, **"2"** for 2, **"3"** for 3 or **"4"** for 4 to change the remote control code, then press **ENTER**.
- 2** Press **power** on the unit to turn off the unit.
- 3** Press **right arrow** on the unit for over 5 seconds while the unit is turned off. The code currently set appears on the front display panel.
- 4** Press **square** on the remote control to change the unit's code. The code currently set on the remote control blinks on the front display panel for approximately 5 seconds, and is applied to the unit.

TV Multi-Brand Remote Control

Your Remote can operate the basic functions of your TV set. In addition to JVC TVs, other manufacturer's TVs can also be controlled.

- Slide the **TV/DVD** switch to **TV**.

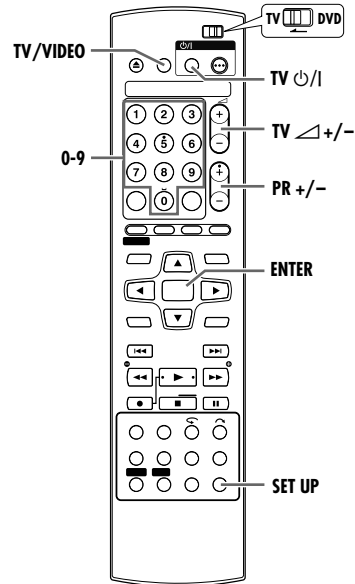

IMPORTANT:

Although the supplied Remote unit is compatible with JVC televisions, as well as many other models, it may not work with your TV, or in some instances, may have limited function capability.

■ **Set the TV brand code.**

- 1** Keep pressing **SET UP** down during step 2.
- 2** Enter your TV's brand code using the **number keys**, then press **ENTER**. (see pg. 63)
- 3** Press **TV power** on the unit's Remote to turn on the TV and try operations.
 - Once you have set the Remote to operate the TV, you do not have to repeat this step until you replace your Remote's batteries.
 - Some brands of TVs have more than one code. If the TV does not function with one code, try entering another.

■ **Operate the TV.**

- 1** Press the corresponding button: **TV power**, **TV/VIDEO**, **PR +/-**, **TV +/-**, **number keys**.
 - For some brands of TVs, you must press **ENTER** after having pressed the **number keys**.

TV Brand Code Table

BRAND NAME	CODE
JVC	01, 23, 24, 25
FERGUSON	27
FINLUX	30
FUNAI	32
LG/GOLDSTAR	18
GRUNDIG	19
HITACHI	10
ITT	28
mitsubishi	03
MIVAR	29
NEC	20
NOKIA	31
PANASONIC	04, 11
PHILIPS	02
RCA	05
SAMSUNG	12, 33, 34, 35
SANYO	13, 16
SHARP	06
SONY	07
THOMSON	26
TOSHIBA	08, 14

Scan Mode Set

If you connect the unit and TV with Component Video Connection (see pg. 11), you can select the scan mode from two modes. Interlaced scan mode which is used in the conventional TV system, and Progressive scan mode which enables reproduction of higher-quality images.

Interlaced scan

In the conventional video system, a picture is shown on the display monitor in two halves. The Interlaced scan system places lines of the second half of the picture in-between lines of the first half of the picture.

Progressive scan

Progressive scan displays all the horizontal lines of a picture at one time, as a single frame. This system can convert the interlaced video from DVD into progressive format for connection to a progressive display. It dramatically increases the vertical resolution.

ATTENTION:

- Your TV needs to be compatible with Progressive.
- Connect the unit and the TV using a component video cable.

- Turn on the unit.
- Turn on the TV and select an input mode such as EXT1.
- Slide the TV/DVD switch to DVD.

Tray Lock

You can lock the disc tray to prohibit the unwanted disc ejection by children.



To lock tray

When the unit is turned off, while holding ■, press ▲ on the unit. "LOCK" appears on the front display panel and the disc tray is locked.

To unlock tray

When the unit is turned off, while holding ■, press ▲ on the unit. "UNLOCK" lights up on the front display panel.

Child Lock

You can disable the operations of this unit using the Child Lock function.

- Turn on the unit.

- When the unit is turned on, press and hold DVD on the remote control for more than 10 seconds.
 - The unit turns off and enters into Child Lock mode.
 - When in Child Lock mode, "CL" will appear on the front display panel indicating that Child Lock mode is engaged when an attempt was made to operate buttons on the unit or remote control.
- Press and hold DVD on the remote control for 10 or more seconds.
 - Child Lock is released and the unit turns on.

When in Child Lock mode, pressing **TIMER** on the remote control during timer recording releases Child Lock and recording is continued.

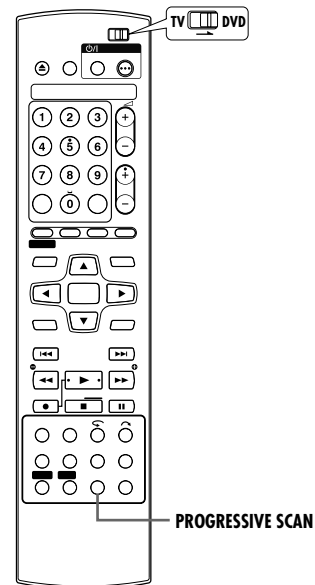

- Set "L-1 OUTPUT" to "COMPONENT". (see pg. 57)

- Press **PROGRESSIVE SCAN** for 3 or more seconds.

- Video output indicator (■) lights on the front display panel if Progressive scan mode has been established. (see pg. 12)
- Each press of **PROGRESSIVE SCAN** for 3 or more seconds switches the scan mode.

NOTES:

- Progressive scan video signal is output from the [COMPONENT VIDEO OUT] connectors.
- Interlaced scan mode is the setting at your purchase.
- Interlaced scan mode might be suitable depending on video material.
- Scan mode cannot be set while menu screen is displayed.

64 EN **SUBSIDIARY SETTINGS**

Tuner Set

Your unit needs to memorise all necessary stations in channel positions in order to record TV programmes. Auto Channel Set automatically assigns all receivable stations in your area to call them up by using the **PR +/-** buttons without going through any vacant channels.

- Turn on the unit.
- Turn on the TV and select an input mode such as EXT1.
- Slide the **TV/DVD** switch to **DVD**.

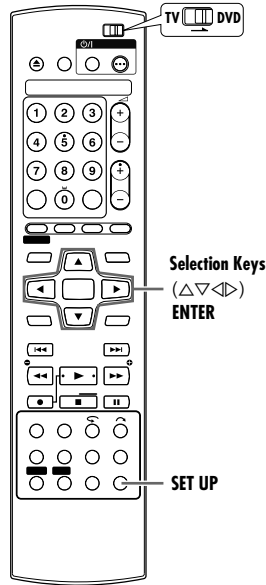

IMPORTANT:

- Perform the following steps only if —
- Auto Channel Set has not been set correctly by Auto Set Up. (pg. 17)
 - you have moved to a different area or if a new station starts broadcasting in your area.

Auto Channel Set

- 1 Press **SET UP** in DTV mode to access the Main Menu screen.
- 2 Press **selection keys** to select "INITIAL SET UP", then press **ENTER**.
- 3 Press **selection keys** to select "CHANNEL SET", then press **ENTER**.
- 4 Select "AUTO SEARCH", then press **ENTER**.
 - "AUTO SEARCH" starts.

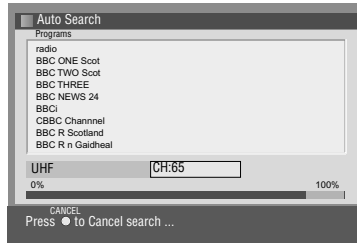

- 5 Upon completing "AUTO SEARCH", the screen display returns to the Main Menu screen and "AUTO SEARCH SCAN COMPLETED" appears on the TV screen. Press **ENTER**.
- 6 Press **SET UP** to complete "AUTO SEARCH".

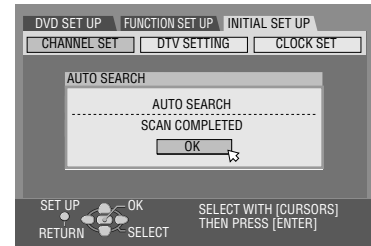

IMPORTANT:

- In certain reception conditions, the station channel numbers may not be stored correctly. When the channel numbers are not set properly, the programme that you do not intended to record will be timer recorded. When programming timer recording, be sure to check that the desired channel is selected correctly. "Check, Cancel And Change Programmes" (pg. 41)
- Your unit memorises all receivable stations even if reception of some of them is poor. You can delete those stations with an unacceptable picture from the PR list. (pg. 65, "Delete A Channel")
- If channel set is performed, all the favourite channels that have been set will be removed. The "FAVOURITE MODE" (pg. 20) setting will automatically be set to "OFF".

NOTES:

- Fine tuning is performed automatically during Auto Channel Set.
- If you perform Auto Channel Set when the aerial cable is not connected properly, "NO SIGNAL" appears on the TV screen in step 4. In such a case, make sure of the aerial connection, select "RETRY", then press **ENTER**. Auto Channel Set will start again.

Manual Channel Set

Perform manual channel set to add new channels or when checking the signal condition of the channels.

- 1 Press **SET UP** in DTV mode to access the Main Menu screen.
- 2 Press **selection keys** to select "INITIAL SET UP", then press **ENTER**.
- 3 Press **selection keys** to select "CHANNEL SET", then press **ENTER**.
- 4 Press **selection keys** to select "MANUAL SEARCH", then press **ENTER**.
- 5 Press the **number keys** to enter the channel number, then press **ENTER**.
 - "MANUAL SEARCH" starts.
 - Confirm the signal condition with the signal level bar. If the picture is displayed, it does not matter even if the level bar indicates below mid-level.
 - Once the channel is received, the screen displays the programme list for a few seconds before returning to the "MANUAL SEARCH" screen.
 - If the channel is not received, the screen display returns to the "MANUAL SEARCH" screen without displaying the programme list.
 - Repeat step 5 to add or check other channels.
- 6 Upon completing "MANUAL SEARCH", press **SET UP** on the remote control.

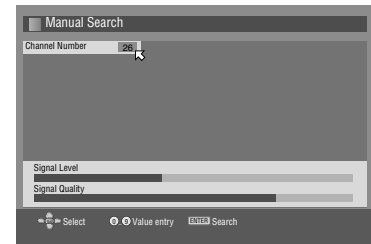

Confirming Images Of Registered Channels

- 1 Press **SET UP** in DTV mode to access the Main Menu screen.
- 2 Press **selection keys** to select "INITIAL SET UP", then press **ENTER**.
- 3 Press **selection keys** to select "CHANNEL SET", then press **ENTER**.
- 4 Press **selection keys** to select "EDIT CHANNEL LIST", then press **ENTER**.
 - The "Edit PR List" display appears on the TV screen.
- 5 Press **<>** to select "Select".
- 6 Press **△▽** to select the channel, then press **ENTER**.
 - The image of the selected channel appears on the top left video field.
 - Repeat this step as necessary to confirm the images of other channels.
- 7 Press **SET UP** to end.

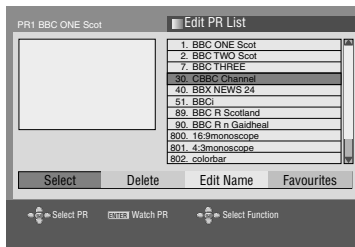
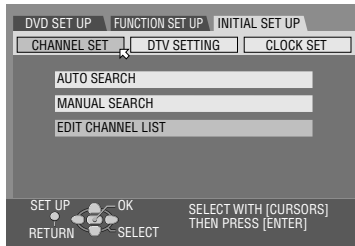

Delete A Channel

- 1 Press **SET UP** in DTV mode to access the Main Menu screen.
- 2 Press **selection keys** to select "INITIAL SET UP", then press **ENTER**.
- 3 Press **selection keys** to select "CHANNEL SET", then press **ENTER**.
- 4 Press **selection keys** to select "EDIT CHANNEL LIST", then press **ENTER**.
 - The "Edit PR List" display appears on the TV screen.
- 5 Press **<>** to select "Delete".
- 6 Press **△▽** to select the channel, then press **ENTER**.
 - The confirmation screen appears.
- 7 Press **<>** to select "Yes", then press **ENTER**.
 - The channel is deleted.
- 8 Repeat step 6 and 7 as necessary.
- 9 Press **SET UP** to end.

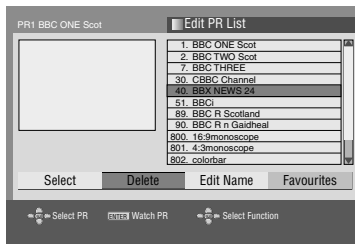

Set Stations

Set station names other than the ones registered in your unit.

- 1 Press **SET UP** in DTV mode to access the Main Menu screen.
- 2 Press **selection keys** to select "INITIAL SET UP", then press **ENTER**.
- 3 Press **selection keys** to select "CHANNEL SET", then press **ENTER**.
- 4 Press **selection keys** to select "EDIT CHANNEL LIST", then press **ENTER**.
 - The "Edit PR List" display appears on the TV screen.
- 5 Press **<>** to select "Edit Name".
- 6 Press **△▽** to select the channel, then press **ENTER**.
- 7 Press the **selection keys** to enter the characters at the character entry position, then press **ENTER**.
 - Select the characters using **△▽**.
 - To move the cursor to the next column, press **<>**.
 - After selecting all the necessary characters, press **ENTER** to confirm the station name.
- 8 Press **ENTER** to return to the "Edit PR List" screen.
 - Repeat steps 6 – 8 as necessary.
- 9 Press **SET UP** to end.

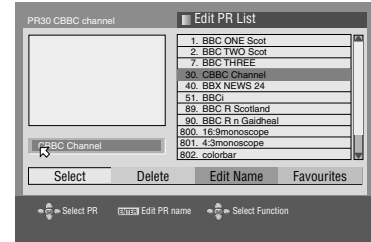

Setting Favourites

You can tune to your frequently watched channels with ease by setting the channels to "Favourites".

- 1 Press **SET UP** in DTV mode to access the Main Menu screen.
- 2 Press **selection keys** to select "INITIAL SET UP", then press **ENTER**.
- 3 Press **selection keys** to select "CHANNEL SET", then press **ENTER**.
- 4 Press **selection keys** to select "EDIT CHANNEL LIST", then press **ENTER**.
 - The "Edit PR List" display appears on the TV screen.
- 5 Press **<>** to select "Favourites".
- 6 Press **△▽** to select the channel, then press **ENTER**.
 - ☺ appears on the extreme right of the selected channel field when "Favourites" is set.
 - Thereafter, the cursor will move to the channels with the ☺ indication whenever **△▽** is pressed.
- 7 Repeat steps 6 as necessary.
- 8 Press **SET UP** to end.

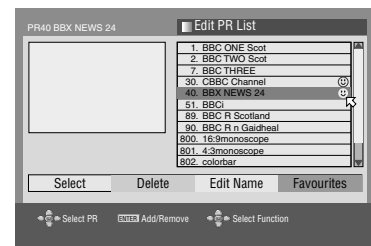

66 EN **SUBSIDIARY SETTINGS**

Clock Set

IMPORTANT:

If you performed Auto Set Up (pg. 17), without ever having set the clock previously, the unit's built-in clock is also set automatically.

Perform the following steps only if —

— Auto Clock Set has not been performed correctly by Auto Set Up.

OR

— you want to change Just Clock setting. (See "Just Clock" in the right column)

- Turn on the unit.
- Turn on the TV and select an input mode such as EXT1.
- Slide the TV/DVD switch to DVD.

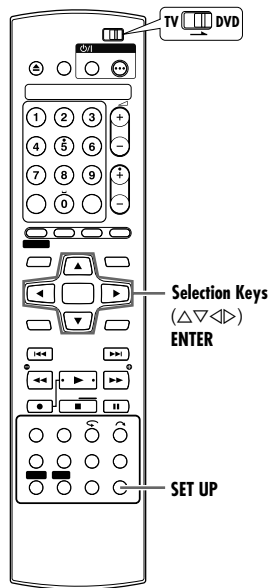

- 1 Press **SET UP** to access the Main Menu screen.
- 2 Press **selection keys** to select "INITIAL SET UP", then press **ENTER**.

- 3 Press **selection keys** to select "CLOCK SET", then press **ENTER**.

- 4 Press **selection keys** to select "YEAR", then press **ENTER**. Press **selection keys** to set the year, then press **ENTER**.

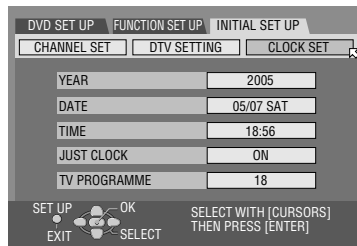

- Repeat the same procedure to set the date and time.
- When you set the date, press and hold $\Delta \nabla$ to change the date by 15 days interval.
- When you set the time, press and hold $\Delta \nabla$ to change the time by 30 minutes interval.

- 5 Press **selection keys** to select "JUST CLOCK", then press **ENTER**. Press **selection keys** to set to the desired mode, then press **ENTER**.

- The default setting is "ON".
- If you set to "OFF", you can disregard the next step as you won't be able to receive regular clock adjustments.

- 6 Press **selection keys** to select "TV PROGRAMME", then press **ENTER**. Press **selection keys** to set the channel position to the number representing the station transmitting clock setting data, then press **ENTER**.

- The unit is preset to receive clock setting and adjustment data from the channel selected in this step (step 6).

- 7 Press **SET UP** to start the clock operation.

NOTES:

- Just Clock adjusts the unit's built-in clock automatically when it is set to "ON".
- Just Clock is not effective when:
 - the unit's power is on.
 - the unit is in the Timer mode.
 - a difference of more than 3 minutes exists between the built-in clock's time and the actual time.
 - the unit is in the Automatic Satellite Programme Recording mode. (pg. 42)
 - "L-2 SELECT" is set to "SAT VIDEO/RGB" or "SAT S-VIDEO/RGB". (pg. 58)
- If Just Clock is set to "ON", the unit's clock is automatically adjusted at the start/end of Summer Time.
- Just Clock may not function properly depending on the reception condition.

Just Clock

The Just Clock function provides accurate time keeping through automatic adjustments at regular intervals, by reading data from digital tuner signal. The Just Clock option can be set to "ON" or "OFF" at the Clock Set screen. (The default setting is "ON".)

IMPORTANT:

- If you set Just Clock to "OFF", time correction will not be performed, which could adversely affect timer recording. We recommend you to keep Just Clock set to "ON".
- If you set Just Clock to "ON", automatic time acquisition is performed even when the unit is turned off. As part of the circuitry of this unit is turned on during these intervals, the fan functions and a spinning sound is generated.

Format A Disc



Some DVD-RAM/RW discs are unformatted.

Format the disc when you use an unformatted disc or you want to delete all recordings and data on the disc.

ATTENTION:

- When a disc is formatted, all recordings and data are erased. It is impossible to restore them.
- Never turn off the unit or disconnect the mains power cord while "NOW FORMATTING..." is displayed on the TV screen.

- Turn on the unit.
- Turn on the TV and select an input mode such as EXT1.
- Load a DVD-RAM/RW disc to format.
- Slide the TV/DVD switch to DVD.

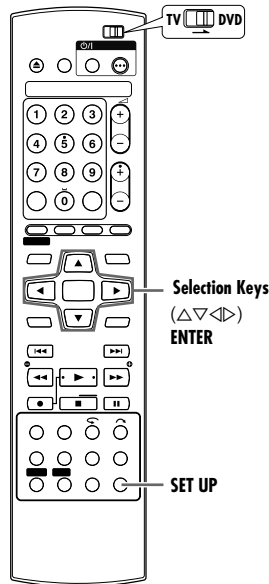

Format A DVD-RAM Disc

- 1 Press **SET UP** to access the Main Menu screen.
- 2 Press **selection keys** to select "DVD SET UP", then press **ENTER**.
- 3 Press **selection keys** to select "UTILITY", then press **ENTER**.
- 4 Press **selection keys** to select "FORMAT", then press **ENTER**.
 - The confirmation screen appears.
- 5 Press **selection keys** to select "YES", then press **ENTER**.
 - The confirmation screen appears.
- 6 Press **selection keys** to select "OK", then press **ENTER**.
- 7 Upon completing formatting, "COMPLETED" appears on the TV screen. Press **ENTER** to complete formatting.
- 8 Press **SET UP** to return to the normal screen.

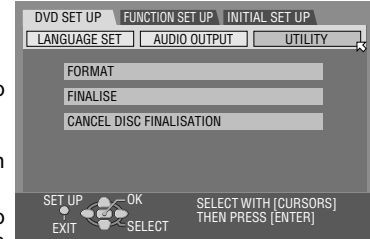

Format A DVD-RW Disc

- 1 Perform steps 1 – 3 of "Format A DVD-RAM Disc" as above before continuing.
- 2 Press **selection keys** to select "FORMAT", then press **ENTER**. Press **selection keys** to choose "VR MODE" or "VIDEO MODE", then press **ENTER** when "DISC WILL BE FORMATTED" appears on the TV screen.
 - "VR MODE":
To be chosen when you want to record, erase, or edit data on the disc repeatedly.
 - "VIDEO MODE":
To be chosen when you want to erase all the data on the disc once played back to record new data, or play back the disc on other DVD players.
- 3 Press **selection keys** to select "YES", then press **ENTER**.
- 4 Upon completing formatting, "COMPLETED" appears on the TV screen. Press **ENTER** to complete formatting.
- 5 Press **SET UP** to return to the normal screen.

NOTES:

- It is impossible to format Version 1.0 DVD-RW discs in Video mode.
- It is impossible to format DVD-R discs.
- All the titles on a disc will be deleted once the disc is formatted even if they are protected titles.

68 EN SUBSIDIARY SETTINGS**Finalise A Disc**

Finalising DVD-R/RW discs recorded on this unit makes it possible for the discs to be played back on other DVD players. DVD-RW discs are finalised in the mode that the discs were formatted, enabling playback on compatible DVD players.

Title names input in the Library Database Navigation are registered as title names in the DVD menu. (pg. 51)

ATTENTION:

Never turn off the unit or disconnect the AC power cord while finalisation or cancellation of finalisation is in progress.

- Turn on the unit.
- Turn on the TV and select an input mode such as EXT1.
- Load a DVD-R/RW disc to finalise.
- Slide the TV/DVD switch to DVD.

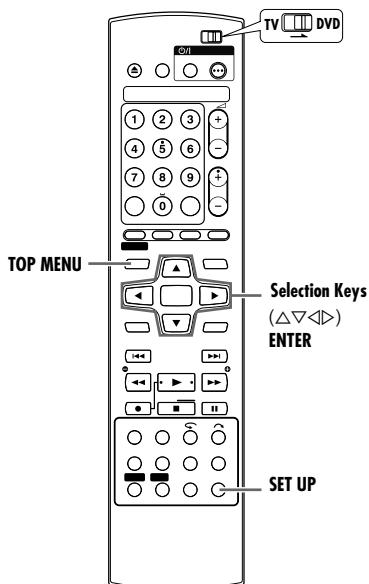
**Before finalising**

- It is possible to record on a blank space.
- It is possible to enter title names. (pg. 46)
- It is possible to delete titles. (pg. 44)
- It is impossible to overwrite recorded areas of DVD-R discs.
- Available recording capacity does not increase even if a recorded programme is deleted from a DVD-R disc.
- It is impossible to record or edit DVD-R/RW discs recorded on other devices even if they have not been finalised.

After finalising (For DVD-R/RW (Video mode) discs)

- Video and audio that are recorded in conformity to the DVD Video standard before finalising enables you to play back the discs as DVD VIDEO discs.
- Although DVD-R/RW discs finalised on this unit become playable on DVD players compatible with DVD-R/RW discs, some discs still may not play, for which JVC cannot take responsibility.
- Marked points marked before finalising will be deleted, and titles will be divided automatically into "chapters" approximately every 5 minutes. (pg. 8, 25)
- Depending on the DVD players and DVD-R/RW discs used, and on the conditions of recording, it may not be possible to play back the discs. In this case, play back the discs on this unit.
- Additional recordings become impossible.

Finalise A DVD-R/RW Disc

- 1 Perform steps 1 – 3 of "Format A DVD-RAM Disc" (pg. 67) before continuing.
- 2 Press **selection keys** to select "FINALISE", then press **ENTER**.
- 3 The confirmation screen appears. Press **selection keys** to select "YES", then press **ENTER**.
- 4 The confirmation screen appears again. Press **selection keys** to select "OK", then press **ENTER**.
 - To cancel finalisation, press "CANCEL".
- 5 Upon completing finalisation, "COMPLETED" appears on the TV screen. Press **ENTER** to return to the previous screen.
- 6 Press **SET UP** to return to the normal screen.
 - Menu screen is cleared.
 - Once a DVD-R/RW (Video mode) disc has been finalised, the displays for original and play list do not appear. As only display for library appears, press **TOP MENU** to select the desired title.
 - Once a DVD-RW (VR mode) disc has been finalised, it can be played on DVD players compatible with VR mode.

Cancel The Finalisation Of A DVD-RW Disc

- 1 Load a DVD-RW disc to cancel the disc finalisation, and perform steps 1 – 3 of "Format A DVD-RAM Disc" (pg. 67) before continuing.
- 2 Press **selection keys** to select "CANCEL DISC FINALISATION", then press **ENTER**.
- 3 Press **selection keys** to select "OK", then press **ENTER**.
- 4 Upon completing cancellation of finalisation, "COMPLETED" appears on the TV screen. Press **ENTER** to return to the previous screen.
- 5 Press **SET UP** to return to the normal screen.
 - When the disc finalisation is cancelled, the mode in which the disc was formatted is restored, making the disc recordable.
 - It is not possible to cancel the finalisation of a DVD-R disc.

Before requesting service for a problem, use this chart and see if you can solve the trouble yourself. Small problems are often easily solved, and this can save you the trouble of sending your unit off for repair.

Initialising

Malfunction occurs on the unit.

- Press \odot /I to turn off the unit, while holding \odot /I, press ■ for 3 seconds or more.
 - “RESETTING” blinks on the front display panel.
 - Initialisation may be performed automatically depending on the condition of the disc.

General

No power is supplied to the unit.

- The AC power plug is disconnected from the mains outlet.
- Connect the AC power plug to the mains outlet securely. (☞ pg. 16)

The remote control does not work properly.

- Remove the batteries, wait for 5 minutes or more, then load the batteries again.
- The setting of the remote control code is inappropriate.
- Set the same remote control code (1, 2, 3, or 4) on both the unit and the remote control. (☞ pg. 62)
- The batteries are discharged.
- Replace the dead batteries with new ones.

The TV screen appears dark with no image display.

- The DTV transmission tower is nearby.
- Install an attenuator between the antenna and this unit.
- There may be some problems with the antenna or signal transmission. Or you may be living in an area where reception is not possible. Please consult your dealer.

The digital broadcast screen freezes suddenly.

- Press and hold ■ and \odot /I on the unit simultaneously for 2 seconds or more to restart the unit.

Dubbing from the external equipment is not possible.

- The source (another video recorder, camcorder) has not been properly connected.
- Confirm that the source is properly connected.
- All necessary power switches have not been turned on.
- Confirm that all units' power switches are turned on.
- The setting of the input channel position is inappropriate.
- Select the input channel position (“F-1”, “L-1” or “L-2”) that corresponds to the input terminal connected to the external equipment. (☞ pg. 55)

The on-screen display superimposed on the programme played back/received on this unit is recorded when you dub the programme to an external recording equipment.

- Set “SUPERIMPOSE” to “OFF”. (☞ pg. 61)

The unit does not operate.

- There are cases when the operation is prohibited on the disc.
- Lightning or static electricity may cause malfunction of the unit.
- Disconnect the AC power plug from the AC outlet and connect again. Turn on the unit.

The remote control of a JVC TV will not operate the unit.

- The setting of the remote control code is inappropriate.
- To operate the unit using a JVC TV remote control, set the remote control code of the unit to “1”. (Default: “3”) (☞ pg. 62)

The channel cannot be changed.

- Recording or Live Memory Playback is in progress.
- Press II to pause recording, change the channel, then press \blacktriangleright to resume recording.

The error message does not go away.

- The DTV channel has been deleted from the PR list.
- Re-perform “Auto Channel Set” (☞ pg. 64).

The disc tray does not open.

- Remove the disc using the following method:
 - Reset the unit by disconnecting the AC power plug from the AC outlet and connect again.
 - Press and hold \blacktriangle until the disc tray opens. (Approximately 30 seconds.)
 - Remove the disc and press \blacktriangle to close the disc tray.
- The disc tray was locked.
- Unlock the tray. (☞ pg. 63)

Playback

Images do not appear on the TV screen.

- The TV receiver's channel selector is not set to an input mode such as EXT1.
- Set the TV to an input mode such as EXT1.
- When interlace scanned programme is played back, progressive scan mode is selected.
- Press and hold **PROGRESSIVE SCAN** until **P** disappears from the front display panel. (☞ pg. 63)

Playback does not start or stop immediately after playback is started by pressing \blacktriangleright . On the front display panel, “NO DISC” appears.

- The disc is loaded upside down.
- Place the disc on the disc tray with the playback surface facing down. (☞ pg. 9)
- A disc not being compatible with the unit is loaded.
- Load a playable disc on the unit. (☞ pg. 7)
- A dirty disc is loaded.
- Clean the disc. (☞ pg. 10)
- Defective disc is loaded.
- Replace the warped or scratched disc with a normal one.

Images are blurred or distorted when you start High-Speed Search.

- Images are blurred or distorted at the point where the playback speed changes and this is not a malfunction of the unit.

Playback does not start.

- Playback does not start for approximately 30 seconds after recording is stopped and this is not a malfunction of the unit.

Recording

The desired programme cannot be recorded.

- The channel position does not correspond to that in the receiving area.
- Set the correct channel number for the receiving broadcast. (☞ pg. 17, 64)

Recording and/or editing cannot be performed.

- No disc or a disc not being compatible with the unit is loaded.
- Load a recordable disc on the unit. (☞ pg. 6)
- The disc loaded is not formatted.
- Format the disc. (☞ pg. 67)
- A finalised disc is loaded.
- Recording cannot be made on finalised discs. Load a recordable disc on the unit.
- The disc is full or does not have enough space for the title to be recorded.
- Clear unnecessary titles on the disc or load a blank disc. (☞ pg. 44)

70 EN TROUBLESHOOTING**Timer Recording****Timer programming cannot be made.**

- Date and time is not correct.
→ Set date and time correctly. (☞ pg. 18, 66)
- Timer recording is in progress.
→ Timer programming can't be performed while a timer recording is in progress. Wait until it finishes.

Timer programming recording does not start.

- Date and time is not correct.
→ Set date and time correctly. (☞ pg. 18, 66)

EPG Timer Programming cannot be made.

- Date and time is not correct.
→ Set date and time correctly. (☞ pg. 18, 66)
- The channel number does not correspond to that in the receiving area.
→ Set the correct channel number for the receiving broadcast. (☞ pg. 17, 64)

The EPG system does not timer record properly.

- The unit's channels have been set incorrectly.
→ Refer to "Auto Channel Set" (☞ pg. 64) and re-perform the procedure.

Automatic Satellite Programme Recording does not start.

- The satellite receiver is not connected properly to this unit.
→ Connect the satellite receiver to the unit's [L-2 IN] connector properly. (☞ pg. 42)

On the front display panel, " --:-- " appears.

- Power failure occurred.
→ Set date and time correctly. (☞ pg. 66)

The disc space does not increase when recorded titles are cleared.

- The PC's data recorded on a DVD-RAM drive cannot be cleared on this unit.
→ Format the disc. (When the disc is soiled, wipe the disc with a soft dry cloth before formatting.) (☞ pg. 10, 67)

"PROGRAMME FULL" appears on the TV screen during timer programming.

- All 8 programmes have already been timer programmed.
→ Clear unnecessary programmes on the unit, then try timer programming again.

Other Problems**The image of the TV broadcast appears distorted on the TV screen.**

- Press **PROGRESSIVE SCAN** for 3 or more seconds so that the Video output indicator (P) lights off on the front display panel.

Whistling or howling is heard from the TV during camcorder recording.

- The camcorder's microphone is too close to the TV.
→ Position the camcorder so its microphone is away from the TV.
- The TV's volume is too high.
→ Turn the TV's volume down.

When scanning channels, some of them are skipped over.

- Those channels have been designated to be skipped.
→ If you need the skipped channels, restore them using "Manual Channel Set". (☞ pg. 64)

Channel settings that were made manually seem to have changed or disappeared.

- After the manual settings were made, Auto Channel Set was performed.
→ Do not perform Auto Channel Set after making manual settings, proceed to perform "Clock Set" (☞ pg. 66).

Malfunction occurs and the unit cannot be power off.

- Reset the unit by disconnecting the AC power plug from the AC outlet and connect again.

On-screen Message**DISC NOT REGISTERED IN THE LIBRARY
REGISTER DISC?**

- A disc that is not registered in the library has been inserted. Register the disc as necessary. (☞ pg. 51)

INSERT DISC #XXXX

- Appears when a title that has been selected in the library is not contained in the loaded disc.

**CAN NOT RECORD OR MAKE PLAY LIST
DELETE UNWANTED TITLES**

- Recording and/or editing cannot be performed.
- The number of titles exceeds 99.
- The number of play lists exceeds 99.

SET CLOCK BEFORE TIMER PROGRAMMING

- To set the timer programme, the clock must be set in advance. (☞ pg. 66)

**PROGRAMME FULL
DELETE UNWANTED TIMER PROGRAMME**

- You can programme this unit to timer record as many as 8 programmes. To programme more, you need to cancel a timer programme already set. (☞ pg. 41)

**DISC NOT RECORDABLE
INSERT RECORDABLE DISC**

- When a playback-only disc or a finalised disc is loaded, ● has been pressed. (☞ pg. 7)

REGION CODE ERROR CHECK DISC

- A disc loaded cannot be played back on this unit since the region number of the disc does not match that of the unit. (☞ pg. 7)

**UNREADABLE DISC
CHECK DISC**

- When an incompatible disc is loaded, ► has been pressed. (☞ pg. 7)

**COULD NOT FORMAT THE DISC
CHECK THE DISC**

- Formatting is not complete since the disc may be dirty or damaged. Take out the disc, clean it and retry. (☞ pg. 10, 67)

PRESS [STOP] AGAIN TO STOP RECORDING

- During Live Memory playback, ■ has been pressed. (☞ pg. 27)

TIMER RECORDING COMPLETED

- Timer recording has finished during Live Memory playback.

**PLAYBACK WILL STOP THEN TIMER RECORDING WILL
START**

- Timer recording finished during Live Memory playback, then the next timer recording is about to begin while playback continues.

**COPY PROHIBITED
CAN NOT RECORD**

- An attempt has been made to record copy-protected contents.
- An attempt has been made to record copy-once contents on a disc that is not CPRM compatible.

**COPY PROHIBITED
CAN NOT PLAY**

- The unit has detected invalid contents at the start or in the middle of playback.

**THE i.LINK DEVICE THAT YOU HAVE CONNECTED IS NOT
RECOGNIZED
MAKE SURE THAT THE DEVICE IS CONNECTED PROPERLY
AND POWERED ON**

- An attempt has been made to start DV dubbing when a digital video camera is not properly connected to the unit.
- Check the connection. (☞ pg. 53)

**MEMORY IS FULL
NOTHING MORE CAN BE REGISTERED IN THE LIBRARY
IF YOU DELETE UNNECESSARY TITLE INFORMATION, YOU
CAN THEN REGISTER ADDITIONAL INFORMATION**

- The memory for registration for the Navigation system is full. The recording cannot be started even though the capacity for the recording is enough.

**AVAILABLE MEMORY IS LOW
SOON YOU WILL NO LONGER BE ABLE TO REGISTER
INFORMATION IN THE LIBRARY
IF YOU DELETE UNNECESSARY TITLE INFORMATION, YOU
CAN THEN REGISTER ADDITIONAL INFORMATION**

- The remaining capacity of the memory is not enough for registration for the Navigation system. The recording cannot be started even though the capacity for the recording is enough.

**CAN NOT SET DISC TIMER PROGRAMMING WITH THIS DISC
PREPARE A FORMATTED DISC AS DESCRIBED BELOW
DVD-RAM
DVD-RW (VR MODE)**

- On-Disc Timer Programming has been attempted when a disc that is not compatible with the function is loaded.

NO DISC INSERTED

- On-Disc Timer Programming has been attempted when a disc is not loaded, or loaded upside down.

**GUIDE PROGRAMME IS NOT SET
SELECT CHANNEL YOU WANT TO RECORD**

- To set the timer programme using the EPG system, the channel number must be set in advance.

**COULD NOT FINALISE THE DISC
CHECK THE DISC**

- Finalising is not complete since the disc may be dirty or damaged. Take out the disc, clean it and retry.

**COULD NOT CANCEL DISC FINALISATION
CHECK THE DISC**

- Cancelling disc finalisation is not complete since the disc may be dirty or damaged. Take out the disc, clean it and retry.

72 EN APPENDIX**Language Code List**

AA	Afar	IN	Indonesian	RU	Russian
AB	Abkhazian	IS	Icelandic	RW	Kinyarwanda
AF	Afrikaans	IW	Hebrew	SA	Sanskrit
AM	Ameharic	JI	Yiddish	SD	Sindhi
AR	Arabic	JW	Javanese	SG	Sangho
AS	Assamese	KA	Georgian	SH	Serbo-Croatian
AY	Aymara	KK	Kazakh	SI	Singhalese
AZ	Azerbaijani	KL	Greenlandic	SK	Slovak
BA	Bashkir	KM	Cambodian	SL	Slovenian
BE	Byelorussian	KN	Kannada	SM	Samoan
BG	Bulgarian	KO	Korean (KOR)	SN	Shona
BH	Bihari	KS	Kashmiri	SO	Somali
BI	Bislama	KU	Kurdish	SQ	Albanian
BN	Bengali, Bangla	KY	Kirghiz	SR	Serbian
BO	Tibetan	LA	Latin	SS	Siswati
BR	Breton	LN	Lingala	ST	Sesotho
CA	Catalan	LO	Laothian	SU	Sundanese
CO	Corsican	LT	Lithuanian	SW	Swahili
CS	Czech	LV	Latvian, Lettish	TA	Tamil
CY	Welsh	MG	Malagasy	TE	Telugu
DZ	Bhutani	MI	Maori	TG	Tajik
EL	Greek	MK	Macedonian	TH	Thai
EO	Esperanto	ML	Malayalam	TI	Tigrinya
ET	Estonian	MN	Mongolian	TK	Turkmen
EU	Basque	MO	Moldavian	TL	Tagalog
FA	Persian	MR	Marathi	TN	Setswana
FJ	Fiji	MS	Malay (MAY)	TO	Tonga
FO	Faroese	MT	Maltese	TR	Turkish
FY	Frisian	MY	Burmese	TS	Tsonga
GA	Irish	NA	Nauru	TT	Tatar
GD	Scots Gaelic	NE	Nepali	TW	Twi
GL	Galician	OC	Occitan	UK	Ukrainian
GN	Guarani	OM	(Afan) Oromo	UR	Urdu
GU	Gujarati	OR	Oriya	UZ	Uzbek
HA	Hausa	PA	Panjabi	VI	Vietnamese
HI	Hindi	PL	Polish	VO	Volapuk
HR	Croatian	PS	Pashto, Pushto	WO	Wolof
HU	Hungarian	PT	Portuguese	XH	Xhosa
HY	Armenian	QU	Quechua	YO	Yoruba
IA	Interlingua	RM	Rhaeto-Romance	ZH	Chinese
IE	Interlingue	RN	Kirundi	ZU	Zulu
IK	Inupiak	RO	Rumanian		

SPECIFICATIONS

GENERAL

Power requirement

AC 220 V - 240 V~, 50 Hz/60 Hz

Power consumption

Power on: 37 W

Power off: 6.4 W

Temperature

Operating: 5 °C to 35 °C

Storage: -20 °C to 60 °C

Operating position

Horizontal only

Dimensions (WxHxD)

435 mm x 70 mm x 300 mm

Weight

3.4 kg

VIDEO/AUDIO

Recordable disc: DVD-RAM 12 cm (4.7 GB/9.4 GB)
DVD-RAM 8 cm (1.4 GB/2.8 GB)

DVD-R 12 cm (4.7 GB)

DVD-R 8 cm (1.4 GB)

DVD-RW 12 cm (4.7 GB)

DVD-RW 8 cm (1.4 GB)

Recording format

DVD-RAM : DVD Video Recording format

DVD-R : DVD-Video format

DVD-RW : DVD-Video format, DVD Video Recording format

Recording time

Maximum 8 hours (with 4.7 GB disc)

(XP) : Approx. 1 hour

(SP) : Approx. 2 hours

(LP) : Approx. 4 hours

(EP) : Approx. 6 hours

(FR) : Approx. 1 hour - 8 hours

Audio recording system

: Dolby Digital (2 ch)
Linear PCM (XP mode only)

Video recording compression system

: MPEG2 (CBR/VBR)

INPUT/OUTPUT

S-video input

Y : 1.0 Vp-p, 75 Ω

C : 0.3 Vp-p, 75 Ω

Video input : 1.0 Vp-p, 75 Ω (pin jack)

Audio input : 2 Vrms (pin jack)

Audio output : 2 Vrms (pin jack)

21-pin SCART connectors

: IN/OUT x 1, IN x 1

i.Link : 4-pin for DV input

Component video output

Y : 1.0 Vp-p, 75 Ω

PB/PR : 0.7 Vp-p, 75 Ω

Corresponding to copy protection

Digital audio output : Coaxial

Corresponding to Dolby Digital and DTS

Digital Surround

Bit stream

Selectable in digital audio output setting

menu

TUNER/TIMER

Tuning system : Frequency synthesiser tuner

DVB-T 2K (UK)

Channel coverage

UHF : 470 MHz-850 MHz

Clock reference : Quartz

Programme capacity : 7 days EPG programmable timer/
8 programmes

Memory backup time : Approx. 10 mins

ACCESSORIES

Provided accessories: RF cable,
21-pin SCART cable,
Infrared remote control unit,
"AA" battery x 2

Specifications shown are for SP mode unless otherwise specified.
E. & O.E. Design and specifications subject to change without notice.

74 EN LIST OF TERMS

A		O	
A-B Repeat Playback	31	On-Disc Timer Programming	39, 40
Adjusting The Picture Quality	32	One Touch Replay	24
Angle Selection	25	On-screen Bar	30
Audio Channel Selection	26	On-Screen Display	15
Audio Language/Sound Selection	26	P	
Auto Channel Set	64	Pan&Scan	19
Automatic Satellite Programme Recording	42	Play List	47
B		Playback Control (PBC) Function	26
Basic Playback	22	Programme Playback	33
Basic Recording	34	Progressive scan	63
C		R	
Check, Cancel And Change Programmes	41	Random Playback	33
Child Lock	63	Recordable/Playable Discs	6
D		Recording Medium And Format	8
Disc menu	23	Recording mode	34
Disc Remaining Time	35	Region Number	7
Discs For Playback Only	7	Register Disc	51
DV Dubbing	53	Repeat Playback	30
DVD menu	23	Resume Function	24
E		S	
Elapsed recording time	35	Select The Switching Interval Of The Slide Show	33
EPG Timer Programming	37	Selecting The Desired Channel	21
F		Selection Of The Audio Channel To Be Recorded	
File Structure Of Discs	8	On A Disc	36
Finalise	68	Setting Favourite Mode	20
Format A Disc	67	Setting The Progressive Mode	32
Frame-By-Frame Playback	23	Simultaneous Recording And Playback	28
Free Rate Function	36	Skip Search	24
I		Slow Motion	24
Instant Timer Recording (ITR)	35	Still Picture	23
Interlaced scan	63	Subtitle Selection	25
J		T	
Just Clock	66	Time Search	32
L		Top menu	23
Language Code List	72	Tray Lock	63
Letter Box	19	U	
Library Database Navigation	43	Unplayable Discs	7
Live Memory Playback	27	V	
M		Viewing Teletext Broadcast	21
Manual Channel Set	64	W	
Manual Timer Programming	38	When Programmes Overlap Each Other	41
Marking Positions To Play Back Again Later	25		
Menu/Audio/Subtitle Language Set	19		
Monitor Set	19		

EN

DR-M150SEK

JVC

Free Manuals Download Website

<http://myh66.com>

<http://usermanuals.us>

<http://www.somanuals.com>

<http://www.4manuals.cc>

<http://www.manual-lib.com>

<http://www.404manual.com>

<http://www.luxmanual.com>

<http://aubethermostatmanual.com>

Golf course search by state

<http://golfingnear.com>

Email search by domain

<http://emailbydomain.com>

Auto manuals search

<http://auto.somanuals.com>

TV manuals search

<http://tv.somanuals.com>