

JVC



Mini DV & HDD & DVD VIDEO RECORDER

DR-DX5SEK



INSTRUCTIONS

LPT1101-001B

EN

Safety Precautions

The rating plate and the safety caution are on the rear of the unit.

WARNING: DANGEROUS VOLTAGE INSIDE
WARNING: TO PREVENT FIRE OR SHOCK HAZARD,
DO NOT EXPOSE THIS UNIT TO RAIN OR
MOISTURE.

CAUTION:

A UNIT IS A CLASS 1 LASER PRODUCT. HOWEVER THIS UNIT USES A VISIBLE LASER BEAM WHICH COULD CAUSE HAZARDOUS RADIATION EXPOSURE IF DIRECTED. BE SURE TO OPERATE THE UNIT CORRECTLY AS INSTRUCTED.

WHEN THIS UNIT IS PLUGGED INTO THE WALL OUTLET, DO NOT PLACE YOUR EYES CLOSE TO THE OPENING OF THE DISC TRAY AND OTHER OPENINGS TO LOOK INTO THE INSIDE OF THIS UNIT.

USE OF CONTROLS OR ADJUSTMENTS OR PERFORMANCE OF PROCEDURES OTHER THAN THOSE SPECIFIED HEREIN MAY RESULT IN HAZARDOUS RADIATION EXPOSURE.

DO NOT OPEN COVERS AND DO NOT REPAIR YOURSELF. REFER SERVICING TO QUALIFIED PERSONNEL.

CLASS 1 LASER PRODUCT
 REPRODUCTION OF LABELS
 WARNING LABEL INSIDE OF THE UNIT

IMPORTANT:

- Please read the various precautions on page 2 – 4 before installing or operating the unit.
- It should be noted that it may be unlawful to re-record pre-recorded tapes, DVDs, or discs without the consent of the owner of copyright in the sound or video recording, broadcast or cable programme and in any literary, dramatic, musical, or artistic work embodied therein.

CAUTION:

- When you are not using the unit for a long period of time, it is recommended that you disconnect the power cord from the mains outlet.
- Dangerous voltage inside. Refer internal servicing to qualified service personnel. To prevent electric shock or fire hazard, remove the power cord from the mains outlet prior to connecting or disconnecting any signal lead or aerial.
- The mains plug shall remain readily operable.

CAUTION	CLASS 3B VISIBLE AND INVISIBLE LASER RADIATION WHEN OPEN. AVOID EXPOSURE TO THE BEAM.
ADVARSEL	KLASSE 3B SYNLIG OG USYNLIG LASERSTRÅLING VED ÅBNING. UNNGÅ UDSAETTELSE FOR STRÅLING.
ADVARSEL	KLASSE 3B SYNLIG OG USYNLIG LASERSTRÅLING NÅR DEKSEL ÅPENS. UNNGÅ EKSPONERING FOR STRÅLEN.
VARNING	KLASSE 3B SYNLIG OCH OSYNLIG LASERSTRÅLNING NÅR DENNA DEL ÄR ÖPPNAD. STRÅLEN ÄR FARLIG.
VARO!	KURSSI 3B NÄKYVÄ JA NÄKYMÄTÖN AVATTAESSA OLET ALTIINA LASERSÄTEILYLLE. ÄLÄ KATSO SÄTEESEN.



- Manufactured under licence from Dolby Laboratories. "Dolby" and the double-D symbol are trademarks of Dolby Laboratories.
- "DTS" and "DTS DIGITAL OUT" are trademarks of Digital Theater Systems, Inc.
- This unit plays back and records PAL signals. NTSC signals can also be played back on the DVD deck.
- VIDEO Plus+ and PlusCode are registered trademarks of Gemstar Development Corporation. The VIDEO Plus+ system is manufactured under license from Gemstar Development Corporation.
- This product incorporates copyright protection technology that is protected by U.S. patents and other intellectual property rights. Use of this copyright protection technology must be authorized by Macrovision, and is intended for home and other limited viewing uses only unless otherwise authorized by Macrovision. Reverse engineering or disassembly is prohibited.

The STANDBY/ON \odot /I button does not completely shut off mains power from the unit, but switches operating current on and off. " \odot " shows electrical power standby and "I" shows ON.

When the equipment is installed in a cabinet or a shelf, make sure that it has sufficient space on all sides to allow for ventilation (10 cm or more on both sides, on top and at the rear).

When discarding batteries, environmental problems must be considered and the local rules or laws governing the disposal of these batteries must be followed strictly.

Failure to heed the following precautions may result in damage to the unit, remote control or disc.

1. **DO NOT place the unit** —
 - in an environment prone to extreme temperatures or humidity.
 - in direct sunlight.
 - in a dusty environment.
 - in an environment where strong magnetic fields are generated.
 - on a surface that is unstable or subject to vibration.
2. **DO NOT block the unit's ventilation openings or holes.**
(If the ventilation openings or holes are blocked by a newspaper or cloth, etc., the heat may not be able to get out.)
3. **DO NOT place heavy objects on the unit or remote control.**
4. **DO NOT place anything which might spill on top of the unit or remote control.**
(If water or liquid is allowed to enter this equipment, fire or electric shock may be caused.)
5. **DO NOT expose the apparatus to dripping or splashing.**
6. **DO NOT use this equipment in a bathroom or places with water. Also DO NOT place any containers filled with water or liquids (such as cosmetics or medicines, flower vases, potted plants, cups, etc.) on top of this unit.**
7. **DO NOT place any naked flame sources, such as lighted candles, on the apparatus.**
8. **AVOID violent shocks to the unit during transport.**

MOISTURE CONDENSATION

Moisture in the air will condense on the unit when you move it from a cold place to a warm place, or under extremely humid conditions—just as water droplets form on the surface of a glass filled with cold liquid. In conditions where condensation may occur, disconnect the unit's power plug from the wall and keep it disconnected for a few hours to let the moisture dry, then turn on the unit.

DISCLAIMER OF LIABILITY

JVC shall not be liable for any loss relating to the unit's failure to properly record, store or playback any content (video, audio or otherwise) for any reason whatsoever. Any applicable warranties shall only cover replacement or repair of the effected unit, and shall not apply to recovery or replacement of lost content.

ATTENTION:

- Using a mobile phone in the vicinity of the unit may cause picture vibration on the TV screen or change the screen to a blue back display.
- Some TVs or other appliances generate strong magnetic fields. Do not place such appliances on top of the unit as it may cause picture disturbance.
- When moving the product, press \odot /I to turn off the power, and wait at least 30 seconds before unplugging the power cord. Then, wait at least 2 minutes before moving the product.
- If there is a power outage when using the unit, the recorded data may be erased.
- It is recommended to back up discs which contain important recordings periodically (every few years). As digital signals do not deteriorate, failure to play back or record might arise due to the effects of the disc aging through the years depending on the storage environment.
- Recorded programmes and data cannot be restored once the disc or tape is damaged.

IMPORTANT

Connection to the mains supply in the United Kingdom.

DO NOT cut off the mains plug from this equipment.

If the plug fitted is not suitable for the power points in your home or the cable is too short to reach a power point, then obtain a proper safety approved extension lead/adaptor or consult your dealer.

In the unlikely event of the plug fuse failing be sure to replace the fuse only with an identical approved type, as originally fitted, and to replace the fuse cover. If the fuse fails again consult your nearest JVC dealer.

If nonetheless the mains plug is cut off remove the fuse and dispose of the plug immediately, to avoid a possible shock hazard by inadvertent connection to the mains supply.

If this product is not supplied fitted with a mains plug then follow the instructions given below:

DO NOT make any connection to the Larger Terminal coded E or Green.

The wires in the mains lead are coloured in accordance with the following code:

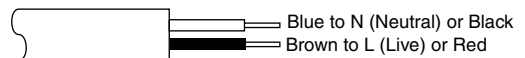

If these colours do not correspond with the terminal identifications of your plug, connect as follows:

Blue wire to terminal coded N (Neutral) or coloured Black.

Brown wire to terminal coded L (Live) or coloured Red.

If in doubt — consult a competent electrician.

Some Do's And Don'ts On The Safe Use Of Equipment

This equipment has been designed and manufactured to meet international safety standards but, like any electrical equipment, care must be taken if you are to obtain the best results and safety is to be assured.

- DO read the operating instructions before you attempt to use the equipment.
- DO ensure that all electrical connections (including the mains plug, extension leads and interconnections between pieces of equipment) are properly made and in accordance with the manufacturer's instructions. Switch off and withdraw the mains plug when making or changing connections.
- DO consult your dealer if you are ever in doubt about the installation, operation or safety of your equipment.
- DO be careful with glass panels or doors on equipment.
- DON'T continue to operate the equipment if you are in any doubt about it working normally, or if it is damaged in any way—switch off, withdraw the mains plug and consult your dealer.
- DON'T remove any fixed cover as this may expose dangerous voltages.
- DON'T leave equipment switched on when it is unattended unless it is specifically stated that it is designed for unattended operation or has a standby mode. Switch off using the switch on the equipment and make sure that your family knows how to do this. Special arrangements may need to be made for infirm or handicapped people.
- DON'T use equipment such as personal stereos or radios so that you are distracted from the requirements of road safety. It is illegal to watch television whilst driving.
- DON'T listen to headphones at high volume, as such use can permanently damage your hearing.
- DON'T obstruct the ventilation of the equipment, for example with curtains or soft furnishings. Overheating will cause damage and shorten the life of the equipment.
- DON'T use makeshift stands and NEVER fix legs with wood screws—to ensure complete safety always fit the manufacturer's approved stand or legs with the fixings provided according to the instructions.
- DON'T allow electrical equipment to be exposed to rain or moisture.

ABOVE ALL...

- NEVER let anyone especially children push anything into holes, slots or any other opening in the case—this could result in a fatal electrical shock;
- NEVER guess or take chances with electrical equipment of any kind—it is better to be safe than sorry!

Information for Users on Disposal of Old Equipment

[European Union]



This symbol indicates that the electrical and electronic equipment should not be disposed as general household waste at its end-of-life. Instead, the product should be handed over to the applicable collection point for the recycling of electrical and electronic equipment for proper treatment, recovery and recycling in accordance with your national legislation.

By disposing of this product correctly, you will help to conserve natural resources and will help prevent potential negative effects on the environment and human health which could otherwise be caused by inappropriate waste handling of this product. For more information about collection point and recycling of this product, please contact your local municipal office, your household waste disposal service or the shop where you purchased the product.

Penalties may be applicable for incorrect disposal of this waste, in accordance with national legislation.

ATTENTION:

This symbol is only valid in the European Union.

(Business users)

If you wish to dispose of this product, please visit our web page www.jvc-europe.com to obtain information about the take-back of the product.

[Other Countries outside the European Union]

If you wish to dispose of this product, please do so in accordance with applicable national legislation or other rules in your country for the treatment of old electrical and electronic equipment.

SAFETY FIRST	2	NAVIGATION ON HDD/DVD DECK	51
Safety Precautions	2	Library Database Navigation	51
Some Do's And Don'ts On The Safe Use Of Equipment	4	Edit Original Information	52
DISC INFORMATION	6	Edit Play List Information	54
About Discs	6	Navigate Library Information	56
INDEX	11	Playback With MP3/WMA/JPEG Navigation	57
INSTALLING YOUR NEW UNIT	18	EDITING	58
Basic Connections	18	Dubbing	58
INITIAL SETTINGS	19	DV Dubbing (HDD & DVD Deck Only)	61
Auto Set Up	19	Edit From A Camcorder	62
Preset Download	20	Edit To Or From Another Recorder	63
Language	22	Output/Input Set	64
Monitor Set	23	Digital Audio Dubbing	65
BASIC OPERATIONS ON DVD DECK	24	Audio Dubbing (DV Deck Only)	66
Basic Playback	24	Insert Editing (DV Deck Only)	67
Playback Features	25	REMOTE CONTROL	68
Using The On-screen Bar	29	Remote Control Functions	68
Parental Lock	33	SYSTEM CONNECTIONS	70
Basic Recording	34	Connecting To A Satellite Receiver	70
Recording Features	35	Connecting To A Dolby Digital Decoder Or An Amplifier With Built-in DTS	70
BASIC OPERATIONS ON HDD DECK	37	SUBSIDIARY SETTINGS	71
Basic Recording	37	Mode Set	71
Recording Features	38	VIDEO Plus+ System Setup	74
Basic Playback	39	Tuner Set	74
Playback Features	39	Clock Set	77
BASIC OPERATIONS ON DV DECK	41	Format A Disc (DVD Deck Only)	78
Basic Playback	41	Finalise A Disc (DVD Deck Only)	79
Playback Features	42	Scan Mode Set (HDD & DVD Deck Only)	80
LIVE MEMORY PLAYBACK ON HDD/DVD DECK	43	Tray Lock (DVD Deck Only)	80
Live Memory Playback	43	TROUBLESHOOTING	81
TIMER RECORDING ON HDD/DVD DECK	46	APPENDIX	85
VIDEO Plus+ Timer Programming	46	SPECIFICATIONS	90
Manual Timer Programming	48	LIST OF TERMS	91
Automatic Satellite Programme Recording (HDD Deck Only)	50		



HOW TO USE THIS INSTRUCTION MANUAL

- All major sections and subsections are listed in the Table Of Contents on page 5. Use this when searching for information on a specific procedure or feature.
- The Index on pages 11 – 14 illustrates the controls and connections on the front and rear panel, the front display panel and the remote control.
- The list of terms on page 91 lists frequently-used terms, and the number of the page on which they are used or explained in the manual.
- The ⓘ mark signals a reference to another page for instructions or related information.
- Operation buttons necessary for the various procedures are clearly indicated through the use of illustrations at the beginning of each major section.

About Discs

Recordable/Playable Discs

You can use discs with the following logos for recording and playback.

 <p>DVD-RAM 12 cm: 4.7 GB/9.4 GB 8 cm: 1.4 GB/2.8 GB Ver. 2.0/2x speed Ver. 2.1/1x – 3x speed Ver. 2.2/5x speed</p>	 <p>DVD-RW 12 cm: 4.7 GB/9.4 GB Ver. 1.1/1x – 2x speed (Video mode/VR mode) Ver. 1.2/4x speed (Video mode/VR mode)</p>
 <p>DVD-R 12 cm: 4.7 GB 8 cm: 1.4 GB Ver. 2.0/1x – 4x/8x speed (Video mode)</p>	

- The above table is based on the information as of August 2005.
- Recording and playback may not be performed depending on the characteristics and condition of the disc used, leading to unsatisfactory results. Using discs manufactured by JVC is recommended since they have been tested to be compatible with this unit.

DVD-RAM Discs

It is only possible to use discs which conform with DVD-RAM standard Version 2.0 or 2.1.

- It is impossible to record on DVD-RAM discs which do not conform to this standard. If you use a disc formatted under a different standard version, format it on this unit before use.
- It may not be possible to record, play back, edit or dub a DVD-RAM disc even if it conforms to the standard if it was recorded or edited on the devices from other manufacturers or on a PC, or if it has far too many titles, or if there is very little available capacity remaining on the disc.
- DVD-RAM discs recorded on this unit cannot be played back on an incompatible DVD player.
- It is possible to record copy-once programmes of digital broadcasts only onto 4.7/9.4 GB DVD-RAM discs (2.8 GB DVD-RAM discs are not compatible).

DVD-R/RW Discs

It is only possible to use DVD-R discs which conform with DVD-R standard Version 2.0.

When a DVD-R/RW disc (Video mode) is finalised (pg. 79), it can be played back on a standard DVD player as a DVD VIDEO disc.

When a DVD-RW disc (VR mode) is finalised (pg. 79), it can be played back on a standard DVD player compatible with the VR mode of DVD-RW discs.

Before finalising —

- it is possible to record on unrecorded areas of the disc, edit the disc title and programme titles, and delete programmes.
- It is impossible to record or edit DVD-R/RW discs recorded on other devices even if they have not been finalised.
- It is impossible to overwrite recorded areas of DVD-R discs.
- Available recording capacity does not increase even if a recorded programme is deleted from a DVD-R disc.

After finalising —

After a DVD-R/RW disc (Video mode) has been finalised, it is possible to play back the recorded programmes (video and/or audio) on a standard DVD video player as a DVD VIDEO disc.

- Edited titles are displayed as the “DVD menu” in video mode.
- It is impossible to record, edit or delete the data either in video mode or in VR mode.
- Either in video mode or in VR mode, although the disc can be played back on DVD players from other manufacturers, sometimes it may not be possible to play back depending on the disc and recording conditions.
- It is impossible to record on CD-R/RW or DVD-R discs used for authoring.
- It is impossible to record onto DVD-R/RW (Video mode) discs broadcasts that allow you to copy once. The copy once programmes can only be recorded onto DVD-RW discs formatted in VR mode.

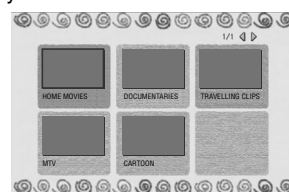





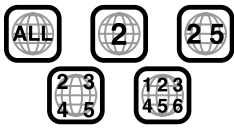

NOTES:

- The following may result if you play back a DVD-R disc recorded on another unit.
 - The disc does not play.
 - A mosaic pattern (block noise) appears on the screen.
 - Video or audio may be dropped out.
 - The unit stops during playback.
- 6x speed DVD-RW disc cannot be used on this unit.

Discs For Playback Only

You can use discs with the following logos for playback only.

 <p>DVD VIDEO</p> <p>(example of region code indications)</p> 	<p>Video CD/Super Video CD</p>  
 <p>Audio CD CD-DA files</p>	 <p>CD-R CD-DA/JPEG/ MP3/WMA files</p>
 <p>CD-RW CD-DA/JPEG/ MP3/WMA files</p>	 <p>CD-ROM JPEG/MP3/ WMA files</p>

- Playback may not be performed depending on the characteristics and condition of the disc used.
- DTS Audio CDs can also be played back (An optional DTS decoder is required).
- MP3 and JPEG discs can be played back on this unit only when they have been recorded in the ISO9660 or Joliet format and finalised.
- JPEG files that can be played back on this unit must conform to JFIF/Baseline process, and the maximum resolution of a JPEG file is 2,812 pixels in width and 2,112 pixels in height.
- CD-R/RW discs recorded in music CD format need to be finalised to play back on this unit.
- Operation and audio quality of this unit are not guaranteed for discs that do not conform to the Compact Disc specification (CD-DA).
Before you play back a CD, check for the CD logo and read the notes on the package to confirm that it conforms to the Compact Disc specification.
- Depending on the intentions of the author of the software, recording conditions of DVD discs and Video CD/SVCD discs may be restricted. Since this unit plays back discs according to the intentions of the author of the software as indicated on the disc, some functions may not operate as commanded.
- When switching from the first layer to the second layer of double-layered DVD VIDEO discs, the image and sound may be momentarily distorted. This is not a malfunction.
- DVD-AUDIO discs compatible with DVD video players can be played.
- Super Audio CDs (SACD) compatible with conventional CD players can be played.

Unplayable Discs

The following types of discs cannot be played using this unit. Do not attempt to play back any kind of disc that is damaged (cracked, warped, or repaired with adhesive tape) or discs in unusual shapes (heart-shaped, octagonal, or other forms). If such discs are accidentally played back, it may cause noise that can lead to speaker damage.

- CD-ROM discs (including PHOTO-CD and CD-G)
- Discs recorded in Packet Write (UDF) format
- 1.3-GB double density CDs (DDCD)
- High density CDs (HDCD)

The following discs also cannot be played back.

- Discs of a region number other than "2"
- DVD-RAM (2.6 GB/5.2 GB)
- DVD-RAM (TYPE1)

Caution for DualDisc playback

The Non-DVD side of a "DualDisc" does not comply with the "Compact Disc Digital Audio" standard. Therefore, the use of Non-DVD side of a DualDisc on this product may not be recommended.

Region Number

The world is divided into 6 regions for DVD VIDEO discs. DVD VIDEO discs are assigned a region number to indicate which region they may be played back in. A disc cannot be played back on this unit unless the region number of the disc matches that of the unit. The region number for this unit is "2". Only discs whose region number includes "2" or "ALL" can be played back such as shown below.

Examples of DVD VIDEO labels which can be played back using this unit.



Marks of discs in this instruction manual

	Allows operation with a DVD-RAM disc.		Allows operation with a Video CD/Super Video CD (SVCD) disc.
	Allows operation with a DVD-R disc.		Allows operation with an Audio CD disc.
	Allows operation with a DVD-RW disc.		Allows operation with a disc including MP3 files.
	Allows operation with a DVD VIDEO disc.		Allows operation with a disc including JPEG files.

Recording Medium And Format

DVD-RAM

- Recording and erasing can be performed as many times as possible on a disc.
- Editing can be performed after recording, such as deleting unwanted parts.
- While recording, it is possible not only to start playback of a programme currently being recorded, but also to watch another programme previously recorded.

DVD-RW (VR mode)

- Recording and erasing can be performed as many times as possible on a disc.
- Editing can be performed after recording, such as deleting unwanted parts.

DVD-RW (Video mode)

- Can be played back on other DVD players.
- New recording can be performed by erasing all the data on a disc once played back.

DVD-R

- Can be played back on other DVD players.
- Suitable when keeping a recorded disc for a long time.

File Structure Of Discs

DVD VIDEO

Typically, DVD VIDEO discs are made up of larger units called "titles". Each title has a number (title number) that can be used to select desired titles. Titles are further divided into units called "chapters". Each chapter has a number (chapter number) that can also be used to select desired chapters. Note that some discs are not divided into titles and chapters.

When you record a programme on a DVD-RAM/RW (VR mode) disc

A single recording session results in a single title (a single chapter). However, chapter marks are automatically inserted when recording is paused, or audio changes from monaural to stereo due to commercial breaks, etc. It is also possible to insert chapter marks at desired locations during playback. (pg. 27)

When you record a programme on a DVD-R/RW (Video mode) disc

A single recording session results in a single title (a single chapter). However, chapter marks are automatically inserted when recording is paused, or audio changes due to commercial breaks, etc. It is also possible to insert chapter marks at desired locations during either recording or playback. Once the disc has been finalised, these chapter marks are deleted and new chapter marks are assigned automatically approximately every 5 minutes.

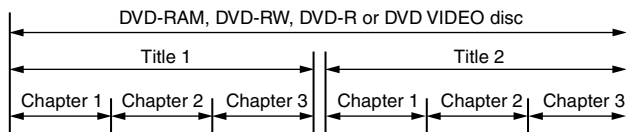

- In Video mode, even before finalising, it is impossible to perform editing operations other than changing the disc name and/or title names and deleting programmes and/or titles.
- After finalising, it is impossible to perform editing operations.

Audio CD/Video CD/SVCD

Typically, Audio CD discs are divided into separate tracks each containing one song. Each track is assigned a number. For example, the third track is Track 3. The same is true for Video CD/SVCD discs.

However, some discs are not divided into tracks.

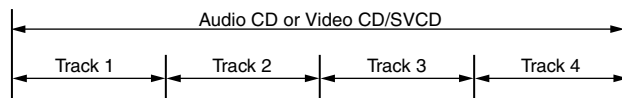

JPEG/MP3 Disc (CD-R/RW/ROM)

MP3/JPEG files put in directories nested in several levels on a disc will be organized as if they were put in single level directories (groups) by the MP3/JPEG Navigation of this unit. (pg. 57)

File structure of a disc before starting the MP3/JPEG Navigation

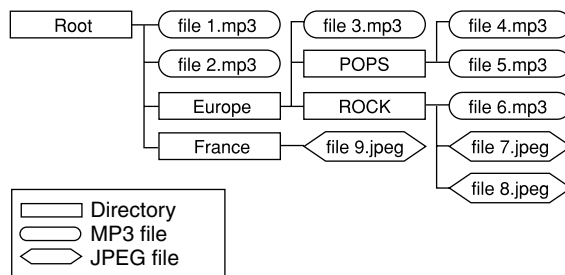

File structure of the disc after starting the MP3/JPEG Navigation

Files are automatically grouped as follows and displayed on the MP3/JPEG Navigation screen. Data is displayed in the alphabetical order of file name. Files are grouped based on roots.

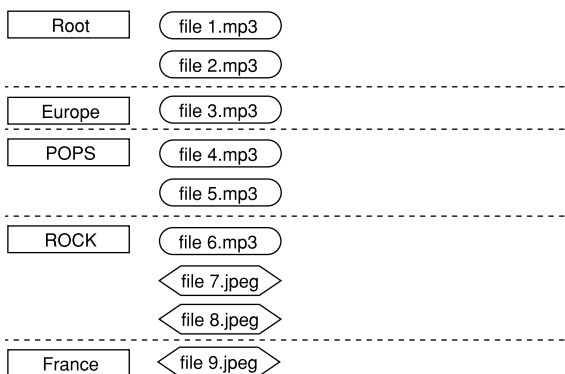

- This unit can recognise up to 9 hierarchies including directories and files. Also, it can recognise up to 250 files in each group, and up to 99 groups on a disc.









NOTES:

- Video CD/SVCD discs that support Playback Control (PBC)**
The contents of a disc are recorded into several hierarchies, and played back according to the instructions on the screen while navigating through the hierarchies. It is also possible to playback recorded tracks consecutively without activating the PBC function even when playing a PBC-compatible disc. (pg. 28)
- Regarding the contents recorded on discs**
Some files may not be played back depending on the file types and other factors.



DVD VIDEO Marks

Sometimes marks are printed on a DVD disc and/or on its packaging to indicate information regarding the contents and functions of the disc. Check the marks indicating the contents and functions of the disc. Note, however, that in some cases a disc may not include a mark even for a function it supports.

Marks related to video

	Number of subtitles		Number of angles
	Recorded under the standard 4:3 aspect ratio		Screen includes black bands at the top and the bottom of image which has a standard 4:3 aspect ratio (letter box)
 	Video playback is in Wide video mode (16:9) on wide televisions, but in letter box on televisions with standard 4:3 aspect ratio.		
 	Video playback is in Wide video mode (16:9) on wide televisions, but pan and scan is used on televisions with standard 4:3 aspect ratio (either the left or right side of the image is cut-out).		

Marks related to audio

	Number of audio tracks
	Dolby Digital mark It has been developed by Dolby Laboratories as a digital surround system.
	DTS (Digital Theater Systems) You can enjoy DTS audio if you connect an amplifier with a built-in DTS decoder to the DIGITAL OUT connector of the unit.

Placing A Disc

Opening the disc tray

Press  to open the disc tray.

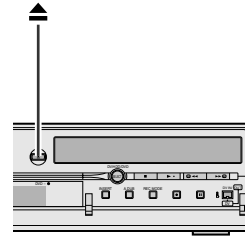

- Pressing the button again closes the disc tray.
- Use the button to open and close the disc tray.
- Do not block the disc tray with your hand while it is opening or closing as this may result in hardware failure.
- Do not place unplayable discs or any object other than a disc on the disc tray.
- Do not press down strongly on the disc tray or place any heavy objects on it.

Discs without cartridges

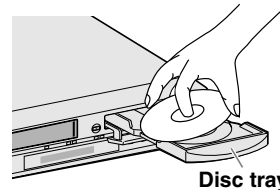

Disc tray

Place the disc on the disc tray with the label side facing up. Since disc size changes depending on the disc to be played back, be sure to correctly align the disc with the grooves for its size. If the disc is not in its groove, it may be scratched or otherwise damaged. To insert an 8 cm disc, place it according to the inner groove.

DVD-RAM discs contained in cartridges

Double-sided discs:

Remove the disc from the cartridge. Align the disc with the grooves on the disc tray as shown in the illustration and insert with the side you wish to play back or record facing down. If you insert the disc with "Side A" facing down, programmes are recorded on the side A.

Single-sided discs:

Remove the disc from the cartridge. Align the disc with the grooves on the disc tray as shown in the illustration and insert with the label side facing up.

Care And Handling Of Discs

How to handle discs

When handling a disc, do not touch the surface of the disc. Since discs are made of plastic, they are easily damaged. If a disc gets dirty, dusty, scratched or warped, the images and sound will not be picked up correctly, and such a disc may cause the unit to malfunction.

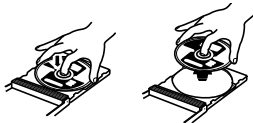

Label side

Do not damage the label side, stick paper to or use any adhesives on its surface.

Recording side

Make sure that discs are not scratched or dirty on the recording side before use. Scratches and dirt on the recording side of a disc may hinder proper playback and recording. Also be careful that a DVD-RAM disc may get scratched or dirty when removed from cartridge then put back in after use.

Storage

Make sure that discs are kept in their cases. If discs are piled on top of one another without their protective cases, they can be damaged. Do not put discs in a location where they may be exposed to direct sunlight, or in a place where the humidity or temperature is high. Avoid leaving discs in your car!

Maintenance of discs

If there are fingerprints or other dirt adhering to a disc, wipe with a soft dry cloth, moving from the centre outwards.

If a disc is difficult to clean, wipe with a cloth moistened with water. Never use record cleaners, petrol, alcohol or any anti-static agents.



CAUTION:

Sometimes during playback, noise may appear or images may be garbled. This is sometimes due to the disc. (It may not be up to industry standards.)

These symptoms are caused by the discs, not by the malfunction of the unit.

Front View

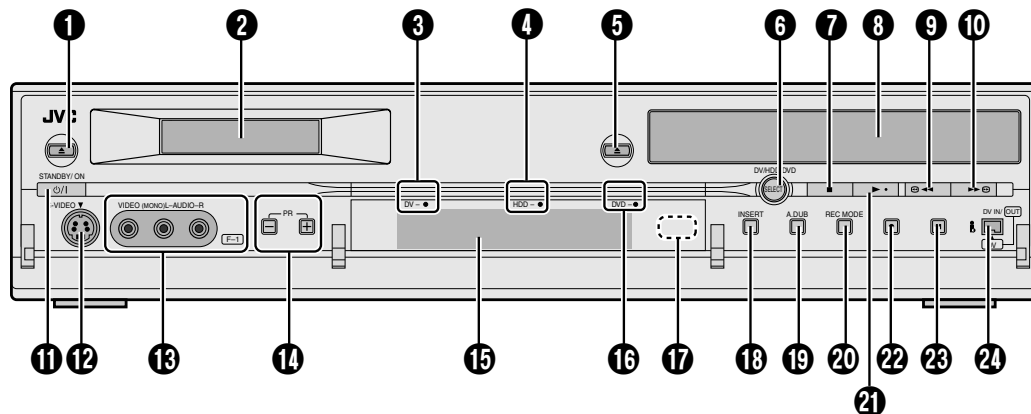

- 1 Eject Button (▲) (DV) ☞ pg. 41
- 2 Mini DV Cassette Loading Slot
- 3 DV Lamp (DV) ☞ pg. 41
- 4 DV Recording Lamp (●)
- 5 HDD Lamp (HDD) ☞ pg. 37
- 6 HDD Recording Lamp (●) ☞ pg. 37
- 7 Open/Close Button (▲) (DVD) ☞ pg. 9
- 8 DV/HDD/DVD Select Button (DV/HDD/DVD SELECT) ☞ pg. 24, 37, 41
 - This button will not function during navigation mode or set up mode.
- 9 Stop Button (■) ☞ pg. 24, 39
- 10 Disc Tray
- 11 Reverse Search Button (◀◀) (HDD & DVD deck) ☞ pg. 25, 44
- 12 Rewind Button (◀◀) (DV deck) ☞ pg. 41, 42
- 13 Forward Search Button (▶▶) (HDD & DVD deck) ☞ pg. 25, 44
- 14 Fast Forward Button (▶▶) (DV deck) ☞ pg. 41, 42

- 11 STANDBY/ON Button (⏻/⏻)
- 12 S-video Input Connector [S-VIDEO] ☞ pg. 62
- 13 Video/Audio Input Connectors [VIDEO/AUDIO ((MONO) L/R)] ☞ pg. 62
- 14 Programme Buttons (PR +/-) ☞ pg. 34, 37
- 15 Front Display Panel ☞ pg. 13
- 16 DVD Lamp (DVD) ☞ pg. 22, 24
- 17 DVD Recording Lamp (●) ☞ pg. 34
- 18 Infrared Beam Receiving Window
- 19 Insert Button (INSERT) ☞ pg. 67
- 20 Audio Dubbing Button (A.DUB) ☞ pg. 66
- 21 Recording Mode Button (REC MODE) ☞ pg. 34, 37
- 22 Play Button (▶) ☞ pg. 24, 39
- 23 Record Button (●) ☞ pg. 34, 37
- 24 Pause Button (||) ☞ pg. 24, 39
- 25 DV Input/Output Connector [DV IN/OUT(i*)] ☞ pg. 61
 - [DV OUT] is available for DV deck only.

* (i.Link) refers to the IEEE1394-1995 industry specification and extensions thereof. The  logo is used for products compliant with the i.Link standard.

To access covered connectors, pull and open the cover.

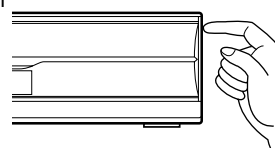

Rear View

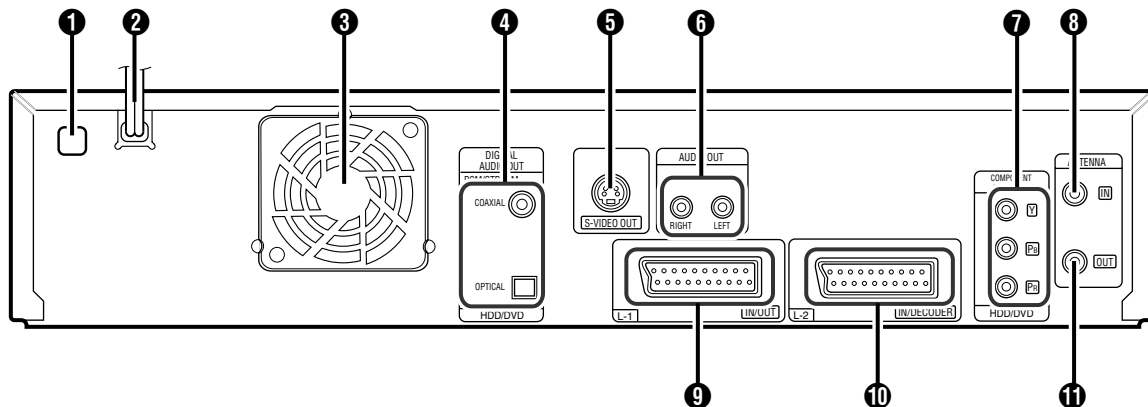
**1 Region Number** pg. 7**2 AC Power Cord** pg. 18**3 Cooling Fan**

- This prevents the temperature from rising inside the unit. Do not remove it.
- Install the unit so as not to block the area around the fan.
- The unit may become hot when it is turned off, as the cooling fan on the rear of the unit is not activated. However, the cooling fan may be activated in the following cases;
 - In the Automatic Satellite Programme Recording standby mode (pg. 50), slightly before the starting time of VPS/PDC recording (pg. 47).
 - If you connect the decoder or satellite receiver to [L-2 IN/DECODER], and if "L-2 SELECT" is set to "DECODER", "SAT VIDEO" or "SAT S-VIDEO". (pg. 64)
 - When "JUST CLOCK" is set to "ON". (pg. 77)
 (Set "JUST CLOCK" to "OFF" if you mind the noise of the fan.)

4 Digital Audio Output Connectors

[DIGITAL AUDIO OUT (OPTICAL/COAXIAL)] (HDD & DVD deck only) pg. 65, 70

5 S-video Output Connector [S-VIDEO OUT] pg. 18**6 Audio Output Connectors [AUDIO OUT (LEFT/RIGHT)]** pg. 18**7 Component Video Output Connectors [COMPONENT VIDEO OUT (Y/Pb/Pr)]** (HDD & DVD deck only) pg. 18**8 Antenna Input Connector [ANTENNA IN]** pg. 18**9 L-1 Input/Output Connector [L-1 IN/OUT]** pg. 18, 63, 70**10 L-2 Input/Decoder* Connector [L-2 IN/DECODER]** pg. 63, 70

* The decoder function of this unit is not available in the U.K.

11 Antenna Output Connector [ANTENNA OUT] pg. 18

Front Display Panel

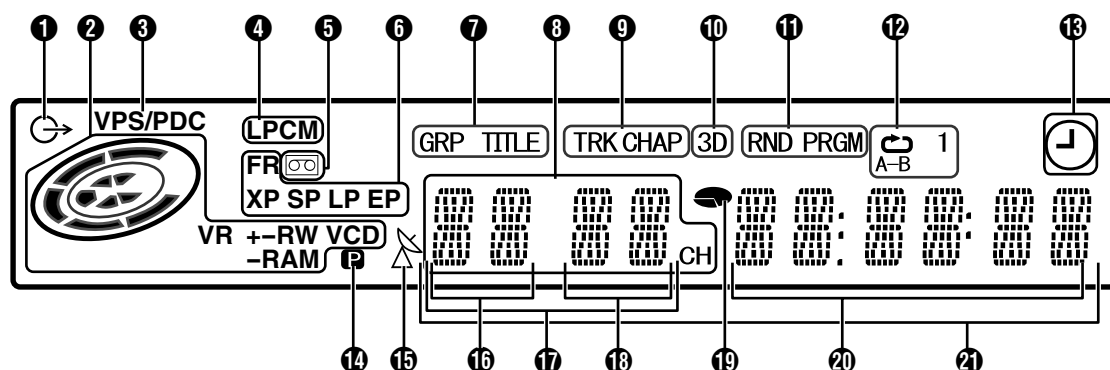

- 1 VIDEO Indicator (⊕)** [pg. 35, 38](#)
Lights when VIDEO mode is selected by pressing TV AV/VIDEO. Lights off when TV mode is selected.
- 2 Disc Type Indicator**
When a disc is loaded, the type of the disc is indicated.
Disc Status Indicator
When a disc is running, the disc marks rotate.
VR Mode Indicator (VR) [pg. 78](#)
Lights when a DVD-RW disc is formatted in VR mode.
- 3 VPS/PDC Indicator** [pg. 47](#)
Appears when checking if the station being received transmits a VPS/PDC signal.
- 4 Linear PCM Indicator (LPCM)**
Lights when "XP MODE REC AUDIO" is set to "LINEAR PCM" ([pg. 72](#)) for recording with HDD, DVD-RAM, DVD-R and DVD-RW discs, and when Linear PCM audio is played.
- 5 Cassette Loaded Mark (⊕)**
Indicates the present of a cassette in the DV deck.
Lights when a cassette is loaded into the DV deck. It will remain lit as long as the cassette is loaded, even if the HDD or DVD deck is being selected.
- 6 Recording Mode Indicator (XP/SP/LP/EP/FR)** [pg. 34](#)
Blinks when recording mode is being set.
While "FR" is blinking, the left 3 digits of the Multi Display (**16**) indicate setting values ranging from "60" to "480". After the value has been set, only "FR" lights.
- 7 Group/Title Indicator (GRP/TITLE)**
"GRP" or "TITLE" lights depending on a disc loaded while the left 2 digits of the Multi Display (**16**) indicate the numbers explained below.
"GRP": Total number of groups or group number being played back are displayed on the Multi Display.
"TITLE": Total number of titles or title number being played back are displayed on the Multi Display.
- 8 Channel Indicator**
Indicates the channel received.
- 9 Track/Chapter Indicator (TRK/CHAP)**
"TRK" or "CHAP" lights depending on a disc loaded while the 3rd and 4th digits from the left of the Multi Display (**16**) indicate the numbers explained below.
"TRK": Total number of tracks or track number being played back are displayed on the Multi Display.
"CHAP": Chapter number being played back are displayed on the Multi Display.
- 10 Simulated Surround Effect Indicator (3D)** [pg. 31](#)
Lights when a simulated surround effect is set to "3D-ON" on the on-screen bar.
- 11 Random/Programme Playback Mode Indicator (RND/PRGM)** [pg. 32](#)
"RND": Lights when Random Playback mode is set.
"PRGM": Lights when Programme Playback mode is set.
- 12 Repeat Mode Indicator (⊕/1/A-B)** [pg. 29](#)
Select Repeat Playback mode on the on-screen bar.
"⊕": Whole disc is played back repeatedly.
"⊕1": A single title/chapter/track is played back repeatedly.
"⊕A-B": The selected part (A-B) is played back repeatedly.
No display: Repeat Playback mode is off.
- 13 VPS/PDC Recording Indicator** [pg. 47](#)
Lights when VPS/PDC recording function is activated.
- 14 Video Output Indicator (P)** [pg. 80](#)
No display: Indicates that interlace mode is engaged.
P: Indicates that progressive mode is engaged.
(Example) P lights when video output mode is in progressive mode.
- 15 Automatic Satellite Programme Recording Indicator** [pg. 50](#)
Lights when the HDD deck is in the Auto Satellite Programme Recording standby mode.
- 16 Group/Title Number Display**
- 17 Audio Dubbing/Insert Editing Indicator**
"ADUB" or "INS" lights up during Audio Dubbing or Insert Editing respectively.
- 18 Track/Chapter Number Display**
- 19 Remaining Time/Elapsed Time Indicator** [pg. 27, 35](#)
Lights when remaining time of HDD, DVD-RAM, DVD-R and DVD-RW discs is displayed, and lights out when elapsed time is displayed.
The right 6 digits of the Multi Display (**20**) indicate elapsed or remaining time of each track.
No display: Indicates elapsed time of the disc.
Displayed: Indicates remaining time of the disc.
- 20 Remaining Time/Elapsed Time Display** [pg. 27, 35](#)
Time Code Display [pg. 42](#)
- 21 Multi Display**
Displays clock, received channel, elapsed time, and remaining time.
Also displays status of the unit (NO DISC/OPEN/CLOSE/READING).

Remote Control

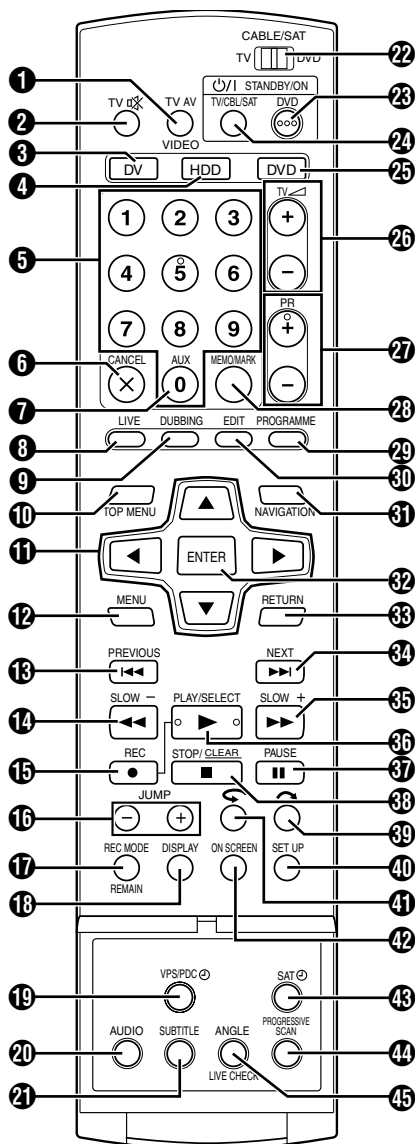

- 1 TV AV/VIDEO Button pg. 35, 38, 68
- 2 TV Muting Button (TV MUTE) pg. 68
- 3 DVD Button* pg. 41
* This button will not function during navigation mode or set up mode.
- 4 HDD Button* pg. 37
* This button will not function during navigation mode or set up mode.
- 5 Number Keys pg. 34, 37
- 6 Cancel Button (CANCEL) pg. 32
- 7 Auxiliary Button (AUX): Switches the AV source to "L-2".
- 8 Live Button (LIVE) pg. 44
- 9 Dubbing Button (DUBBING) pg. 58
- 10 Top Menu Button (TOP MENU) pg. 25
- 11 Selection Keys (Left, Enter, Right) pg. 19
- 12 Menu Button (MENU) pg. 25
- 13 Reverse Skip Button (PREVIOUS) pg. 25, 44, 40
Previous Button (PREVIOUS) pg. 28
- 14 Reverse Search Button (SLOW -) (HDD & DVD deck) pg. 25, 44
Rewind Button (SLOW -) (DV deck) pg. 41
Reverse Slow Button (SLOW -) pg. 25
- 15 Record Button (REC) pg. 34, 37
- 16 Jump Button (JUMP +/-) pg. 40
- 17 Recording Mode Button (REC MODE) pg. 34, 37
Remain Button (REMAIN) pg. 27, 35
- 18 Display Button (DISPLAY) pg. 27, 35, 42

- 19 VPS/PDC Recording Button (VPS/PDC) pg. 47
- 20 Audio Button (AUDIO) pg. 28
- 21 Subtitle Button (SUBTITLE) pg. 28
- 22 TV/CABLE/SAT/DVD switch pg. 22, 68, 69
- 23 DVD Standby/On Button (DVD)
- 24 TV/CBL/SAT Standby/On Button (TV/CBL/SAT)
- 25 DVD Button* pg. 24
* This button will not function during navigation mode or set up mode.
- 26 TV Volume Buttons (TV +/-) pg. 68
- 27 Programme Buttons (PR +/-) pg. 34, 68
- 28 Memo Button (MEMO) pg. 52, 55
Mark Button (MARK) pg. 27
- 29 Programming Button (PROGRAMME) pg. 46, 48, 49
- 30 Edit Button (EDIT) pg. 52
- 31 Navigation Button (NAVIGATION) pg. 51, 57
- 32 Enter Button (ENTER) pg. 19
- 33 Return Button (RETURN) pg. 28, 30, 46
- 34 Forward Skip Button (Next) pg. 25, 44
Next Button (NEXT) pg. 28
- 35 Forward Search Button (HDD & DVD deck) pg. 25, 44
Fast Forward Button (DV deck) pg. 41
Forward Slow Button (SLOW +) pg. 25
- 36 Play Button pg. 24, 39
- 37 Select Button (SELECT) pg. 57
- 38 Pause Button pg. 24, 39
- 39 Stop Button pg. 24, 39
Clear Button (CLEAR) pg. 32
- 40 Skip Search Button pg. 26, 39, 42, 44
- 41 Set Up Button (SET UP) pg. 22, 71
- 42 One Touch Replay Button pg. 26, 40, 42, 44, 45
- 43 On-Screen Button (ON SCREEN) pg. 16, 29
- 44 Automatic Satellite Programme Recording Button (SAT) pg. 50
- 45 Progressive Scan Button (PROGRESSIVE SCAN) pg. 80
- 46 Angle Button (ANGLE) (DVD deck only) pg. 27
Live Check Button (LIVE CHECK) pg. 44

How To Use

Before use, insert two AA size batteries into the remote control with the polarity (+) and (-) matched correctly as indicated on the battery compartment or on the lid.

The remote control can operate most of your unit's functions, as well as basic functions of TV sets and satellite receivers and other brands. (pg. 68)

- Point the remote control toward the receiving window.
- The maximum operating distance of the remote control is about 8 m.

NOTE:

If the remote control doesn't work properly, remove its batteries, wait a short time, replace the batteries and then try again.

Check Contents

CHECK ALL THE CONTENTS SHOWN BELOW

Video Recorder

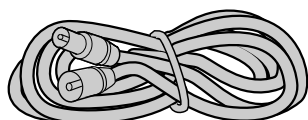

RF Cable

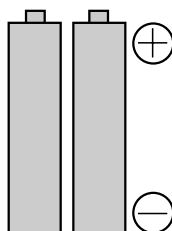

"AA" Batteries (x 2)

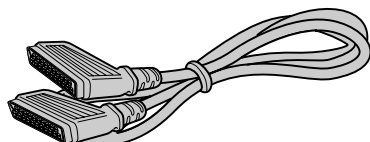

21-pin SCART Cable

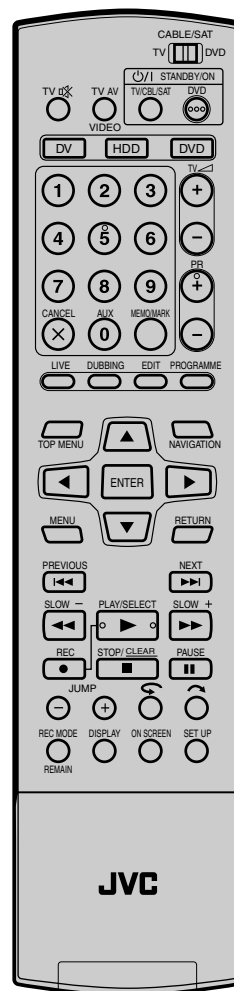

Infrared Remote Control Unit

► You are now ready to install your unit. (pg. 18)

On-Screen Display (HDD & DVD deck)

When "SUPERIMPOSE" is set to "AUTO" and **ON SCREEN** on the remote control is pressed, various operational indicators appear on the TV screen. To clear the operational indicators, press **ON SCREEN** twice.

When playing back a recorded title

HDD

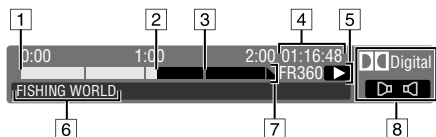

- 1 Title start
- 2 Current playback point
- 3 Title end
- 4 Elapsed playing time
- 5 Play mode
- 6 Name of title currently being played back
- 7 Time scale (This title is an hour and a half long.)
- 8 Audio mode

DVD

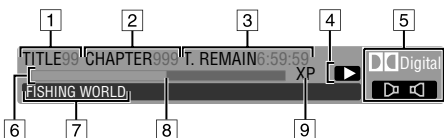

- 1 Playback title number
- 2 Playback chapter number
- 3 Disc remaining time
- 4 Current status (playback)
- 5 Audio mode
- 6 Bar meter
- 7 Name of title (or play list) currently being played back
- 8 Current playback point
- 9 Recorded mode*

* Depending on the recording condition, the recorded mode may not always be displayed.

When recording

HDD



DVD

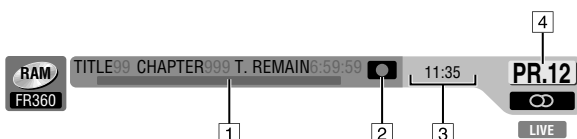

- 1 Recording point
- 2 Current status (recording)
- 3 Current time
- 4 Recording channel number

When pressing REC MODE

(Appears for eight seconds.)

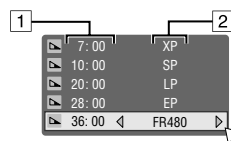

- 1 Remaining disc time for each recording speed
- 2 Recording speed

When pressing ● during recording

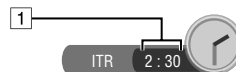

- 1 Recording time for Instant Timer Recording (ITR) mode

When using Live Memory playback

HDD

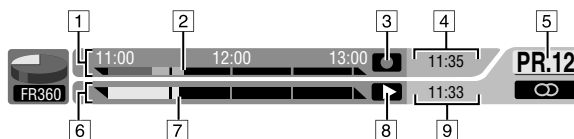

DVD

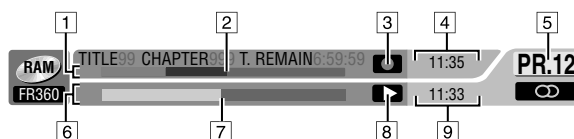

- 1 Time scale for recording (HDD deck)
Bar meter for recording (DVD deck)
- 2 Current recording point
- 3 Recording mode
- 4 Current time
- 5 Current playback channel position number
- 6 Time scale for Live Memory Playback (HDD deck)
Bar meter for Live Memory Playback (DVD deck)
- 7 Current playback point
- 8 Live Memory playback mode
- 9 Current playback time

On-Screen Display (DV Dubbing)

When capturing images from the external DV equipment

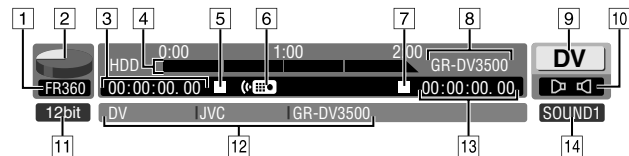

- 1 Recording speed
- 2 HDD capacity graph
- 3 HDD time counter
- 4 Recording time scale
- 5 HDD mode
- 6 Remote control mode
- 7 Connected DV equipment mode
- 8 Connected DV equipment model information
- 9 Input channel
- 10 Sound mode
- 11 Sound input bit-rate*
- * Indicates the sound bit-rate of the connected DV equipment
- 12 Connected DV equipment information*
- * Maker name and model name, etc. may not appear depending on the connected equipment.
- 13 Time counter for the connected DV equipment
- 14 Sound monitor mode

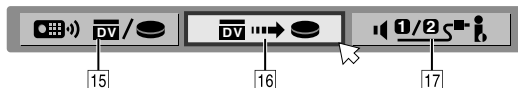

- 15 Remote control switch
- 16 Auto capture button
- 17 Sound monitor switch



- 18 Elapsed recording time

On-Screen Display (DV deck)

When "SUPERIMPOSE" is set to "AUTO" and ON SCREEN on the remote control is pressed, various operational indicators appear on the TV screen. To clear the operational indicators, press ON SCREEN again.

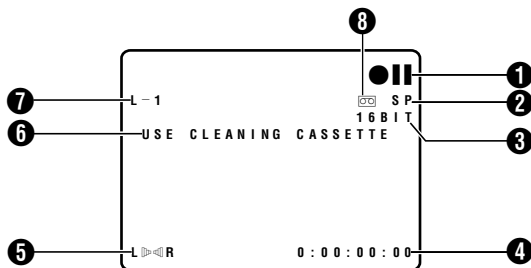

- 1 Operation Mode Indicators
- 2 Tape Speed (SP/LP)
- 3 Sound Mode Display pg. 72
- 4 Current Day/Month/Year/Clock Display/Time Code Display pg. 42
- 5 Audio Mode Display pg. 42
- 6 Warning Message
- 7 Auxiliary Input Indicator (L-1, L-2, F-1 or DV)
- 8 "Cassette Loaded" Mark

Basic Connections

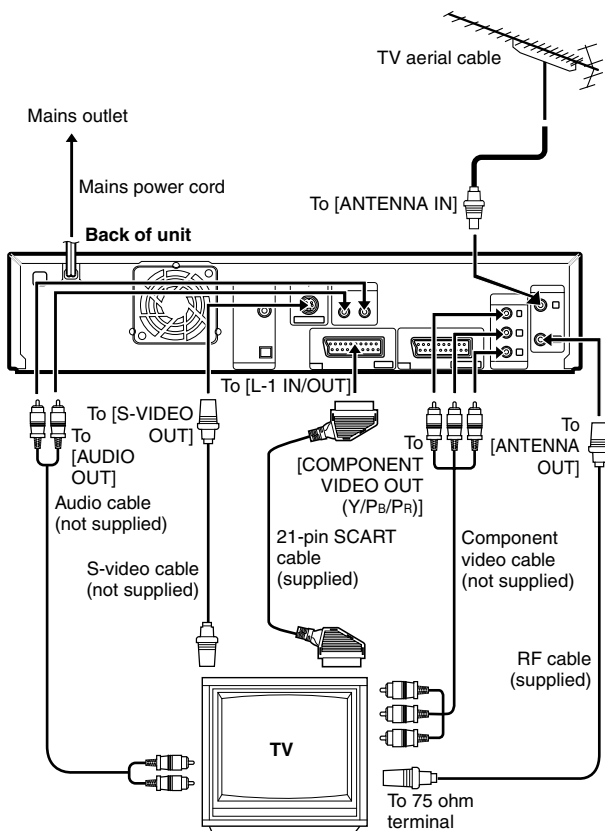

It's essential that your unit be properly connected.

ATTENTION:
Connect the AC plug only after all connections to the TV has been completed.

THESE STEPS MUST BE COMPLETED BEFORE ANY VIDEO OPERATION CAN BE PERFORMED.

- 1** Place the unit on a stable, horizontal surface.
- 2** Connect the unit to a TV depending on the TV and cables you use.

■ **Basic Connection**

To connect to a TV with 21-pin SCART connector —

- 1** Disconnect the TV aerial cable from the TV.
- 2** Connect the TV aerial cable to the [ANTENNA IN] connector on the rear panel of the unit.
- 3** Connect the [ANTENNA OUT] connector on the rear panel of the unit and the TV's aerial connector with the supplied RF cable.
- 4** Connect the [L-1 IN/OUT] connector on the rear panel of the unit and the TV's 21-pin SCART connector with a supplied 21-pin SCART cable.
 - The [L-1 IN/OUT] connector accepts and delivers either a composite signal (regular video signal), Y/C signal or RGB signal.
 - Set your TV to the VIDEO (or AV), Y/C, or RGB mode according to the type of your TV's SCART connector.

NOTE:

The [ANTENNA OUT] connector is only used to pass antenna signal to the TV. It is necessary to connect the [L-1 IN/OUT] connector to the TV to enjoy audio-visual programmes.

■ **S-Video Connection**

To connect to TV's S-VIDEO input and AUDIO input connectors —

- 1** Perform **1** – **3** of "To connect to a TV with 21-pin SCART connector —" in the left column.
- 2** Connect the unit's [S-VIDEO OUT] connector to the TV's S-VIDEO input connector.
- 3** Connect the unit's [AUDIO OUT] connectors to the TV's AUDIO input connectors.
 - If your TV is not stereo-capable, use the unit's [AUDIO OUT] connectors to connect to an audio amplifier for Hi-Fi stereo sound reproduction.
 - Set "L-1 OUTPUT" to "SCART S-VIDEO" when using the S-Video connection.

■ **Component Video Connection**

To connect to TV's component video input connectors —

- 1** Perform **1** – **3** of "To connect to a TV with 21-pin SCART connector —" in the left column.
- 2** Connect the unit's [COMPONENT VIDEO OUT (Y/Pb/Pr)] connectors to the TV's component video input connectors.
- 3** Connect the unit's [AUDIO OUT] connectors to the TV's AUDIO input connectors.
 - You can obtain high-quality component video pictures.
 - The [COMPONENT VIDEO OUT (Y/Pb/Pr)] connectors do not output DV signals.
 - If your TV is not stereo-capable, use the unit's [AUDIO OUT] connectors to connect to an audio amplifier for Hi-Fi stereo sound reproduction.
 - By using the component video connection, you can view the images in the progressive mode. For switching to the progressive mode, refer to "Scan Mode Set (HDD & DVD Deck Only)" (pg. 80).

NOTE:

Select an appropriate option of "L-1 OUTPUT" as follows (pg. 64):

When your TV's SCART connector accepts:	Set "L-1 OUTPUT" to:
Composite signals	"SCART VIDEO"
Y/C signal (separated luminance (brightness) and chrominance (colour) signals)	"SCART S-VIDEO"
RGB signal	"SCART RGB"
Component video signal	"COMPONENT"

When the setting selected is not in accordance with the TV connected and depending on the type of appliance connected to the unit, the correct picture will not appear.

- 3** Plug the end of the mains power cord into a mains outlet.
 - "LOADING" blinks on the front display panel when the AC plug of the mains power cord is connected into a mains outlet and it takes approximately 50 seconds for the unit to be turned on. This is not a malfunction.

Auto Set Up

Auto Channel Set/Auto Clock Set/Auto Guide Programme Number Set

After the P/I button on the unit (or DVD P/I on the remote control) is pressed for the first time to turn on the unit, the Auto Set Up function sets the tuner channels, clock and Guide Programme numbers automatically.

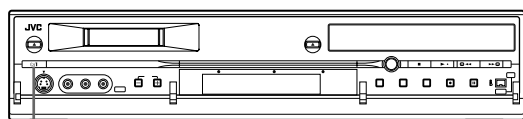

P/I

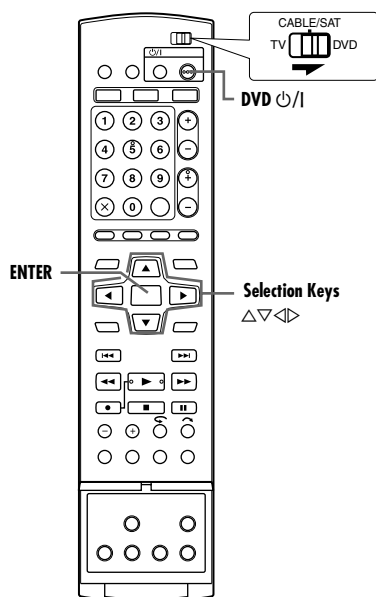

Before starting, make sure of the following:

- The TV aerial cable should be connected to the unit.
- The unit's mains power cord should be connected to a mains outlet.
- Turn on the TV and select the AV mode.
- Slide the TV/CABLE/SAT/DVD switch to DVD.

1 Press P/I on the unit or DVD P/I on the remote control to turn on the unit. The AUTO SET/T-V LINK display appears on the TV screen.

2 Press **selection keys** to select "AUTO SET", then press **ENTER**. The AUTO SET screen will appear.

- When AUTO SET is completed, "SCAN COMPLETED" appears on the TV screen. Select "OK".

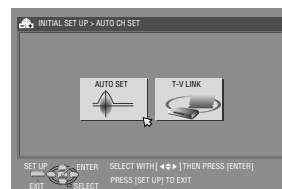

ATTENTION:

"AUTO" blinks on the front display panel; do NOT press any button on the unit or remote control until the front display panel shows "—:—:—" as illustrated on page 21.

- When you have connected the unit to a TV offering T-V Link via a fully-wired 21-pin SCART cable (see pg. 18) and the TV is turned on, the unit automatically performs the Preset Download (see pg. 20) even if you select "AUTO SET" for Auto Set Up function.

ATTENTION:

Once you have performed Auto Set Up, even if the unit's memory backup has expired, all the stored stations and their Guide Programme numbers remain in the unit's memory and the unit will not perform Auto Set Up again. The unit only performs Auto Clock Set when the unit is turned on.

If you have moved to a different area, perform each setting as required.

- Tuner setting (see pg. 74)
- Clock setting (see pg. 77)

If a new station starts broadcasting in your area, perform tuner setting. (see pg. 74)

NOTES:

- In areas where no TV station transmits a PDC (Programme Delivery Control) signal, the unit can perform neither Auto Clock Set nor Auto Guide Programme Number Set.
- Auto Clock Set may not function properly depending on the reception condition.

After "Auto Set Up" is completed, perform "Monitor Set" on page 23.

Preset Download

Auto Channel Set by Downloading from TV/Auto Clock Set/Auto Guide Programme Number Set

ATTENTION:

You can use this function only with a TV offering T-V Link, etc.* Be sure to use a fully-wired 21-pin SCART cable.

* Compatible with TVs offering T-V Link, EasyLink, Megalocic, SMARTLINK, Q-Link or DATA LOGIC via a fully-wired 21-pin SCART cable. The degree of compatibility and available functions may differ by system.

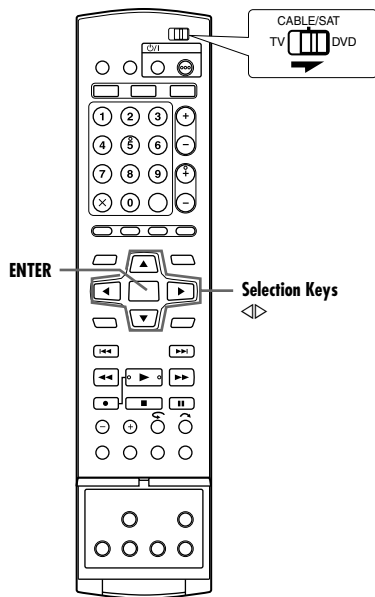

If you have connected the unit to your TV via a 21-pin SCART cable (pg. 18), the unit will automatically perform Preset Download instead of the Auto Set Up in step 2 on page 19. After downloading, the unit sets the clock and Guide Programme numbers automatically.

- Slide the TV/CABLE/SAT/DVD switch to DVD.

- 1 Press \odot /I on the unit or DVD \odot /I on the remote control to turn on the unit. The AUTO SET/T-V LINK display appears on the TV screen.
- 2 Press **selection keys** to select "T-V LINK" and press **ENTER**. The T-V LINK screen will appear.
 - When T-V LINK is completed, "SCAN COMPLETED" appears on the TV screen. Select "OK".

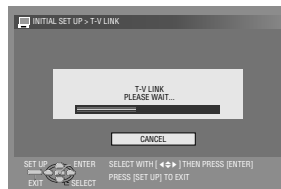
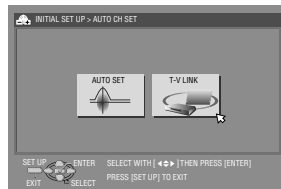

ATTENTION:

Preset positions on the front display panel increase from "PR 1"; do NOT press any button on the unit or remote control until the front display panel shows clock time, "PR 1" or "--:--" as illustrated on page 21.

- If you press any button on the unit or remote control while downloading is in progress, it will be interrupted.

NOTES:

- For details, refer to the instruction manual of your TV.
- In areas where no TV station transmits a PDC (Programme Delivery Control) signal, the unit can perform neither Auto Clock Set nor Auto Guide Programme Number Set.
- Auto Clock Set may not function properly depending on the reception condition.
- On this unit, the characters available for station names (ID) are A-Z, 0-9, -, *, + and _ (space). Some names of downloaded stations may differ from those of your TV. (pg. 76)

After "Preset Download" is completed, perform "Monitor Set" on page 23.

Results Of Auto Set Up/Preset Download Appearing On The Front Display Panel

If both Auto Channel Set and Auto Clock Set have been performed successfully, the correct current time is displayed.

PR 1 20:00

Turn on the TV and select its AV mode, then make sure that all necessary stations have been stored in the unit's memory by using the **PR +/-** button(s).

- If station names (ID – pg. 88) have also been stored in the unit's memory, the station name will be displayed at the top right corner of the TV screen for about 5 seconds when the unit is tuned to a different station.
- If you want to set the tuner manually such as to add or skip channels, to change channel positions, or to set or change station names, see pages 75 – 76.

If Auto Channel Set has succeeded but Auto Clock Set has not, "PR 1" (channel position) is displayed.

PR 1 - -: - -

OR

If both Auto Channel Set and Auto Clock Set have failed, "--:--" is displayed.

- 1 Turn on the TV and select its AV mode, then make sure that all necessary stations have been stored in the unit's memory by using the **PR +/-** button(s).
 - If station names (ID – pg. 88) have also been stored in the unit's memory, the station name will be displayed at the top right corner of the TV screen for about 5 seconds when the unit is tuned to a different station.
 - If you want to set the tuner manually such as to add or skip channels, to change channel positions, or to set or change station names, see pages 75 – 76.
- 2 Perform "Clock Set" (pg. 77).

ATTENTION:

After making sure the cables are connected properly, turn off the unit's power once, then turn the unit's power back on again. Perform "Auto Set Up" (pg. 19) or "Preset Download" (pg. 20) again.

IMPORTANT:

- To check if the Guide Programme numbers have been set correctly, perform the VIDEO Plus+ Timer Programming. (pg. 46)
- In certain reception conditions, station names may not be stored correctly, and auto Guide Programme Number Set may not work properly. If the Guide Programme numbers are not set properly when you timer record a TV programme using the VIDEO Plus+ system, the unit will record a TV programme of a different station. When programming the timer using the VIDEO Plus+ system, be sure to check the desired channel is selected correctly. (pg. 46)
- Your unit memorizes all detected stations even if reception of some of them is poor. You can delete those stations with an unacceptable picture. (pg. 76, "Delete A Channel")

INFORMATION

Just Clock

Your unit is equipped with the Just Clock function which provides accurate time keeping through automatic adjustments at regular intervals, by reading data from a PDC signal. If you want to take advantage of this function, simply set it to "ON". (pg. 77)

If you have any difficulty with the above procedures call the JVC Customer Service Hot Line on 0870 330 5000.

T-V Link Functions

When you connect the unit to your TV via a fully-wired 21-pin SCART cable (pg. 18), the following functions are available. You can use these functions only with a TV offering T-V Link, etc.*

For details, refer to the instruction manual of your TV.
* Compatible with TVs offering T-V Link, EasyLink, Megalogic, SMARTLINK, Q-Link or DATA LOGIC via a fully-wired 21-pin SCART cable. The degree of compatibility and available functions may differ by system.

TV Auto Power On

The TV will turn on and be set to its AV mode automatically whenever you start playback.
For details, refer to the instruction manual of your TV.

Unit Auto Standby

You can use your TV's remote control to turn off the unit.
For details, refer to the instruction manual of your TV.

Direct Rec

You can easily start recording the programme that you are watching on your TV. When you use this function, set "DIRECT REC" to "ON". (pg. 72)

Language

- Turn on the unit.
- Turn on the TV and select the AV mode.
- Slide the **TV/CABLE/SAT/DVD** switch to **DVD**.

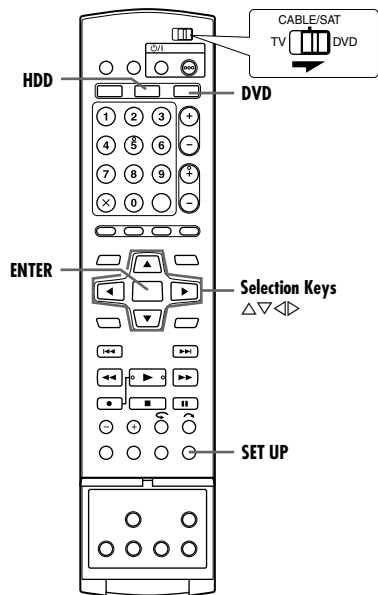

Menu/Audio/Subtitle Language Set (DVD deck only)

Some DVD discs contain the DVD menu display, audio and subtitles in multiple languages. With these discs, you can set the default language as you like.

- The procedure shows how to set “MENU LANGUAGE” as an example.

- 1 Press **DVD** so that the DVD lamp lights up on the unit.
- 2 Press **SET UP** to access the Main Menu screen.
- 3 Press **selection keys** to select “DVD VIDEO SET UP”, then press ∇ .
- 4 Press **selection keys** to select “LANGUAGE SET”, then press ∇ .
- 5 Press **selection keys** to select “MENU LANGUAGE”, then press **ENTER**.
- 6 Press **selection keys** to select your desired language, then press **ENTER**.
 - See “Language Code List” (pg. 85).
- 7 Press **SET UP** to complete the setting.

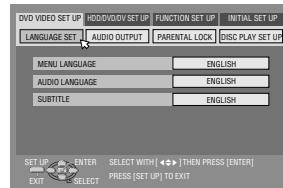

NOTE:

When the selected language is not available on the disc, the disc's default menu language is played back.

Monitor Set

You can select the monitor type depending on the TV used when you play back DVD VIDEO discs recorded for wide-screen TVs.

- Turn on the unit.
- Turn on the TV and select the AV mode.
- Slide the **TV/CABLE/SAT/DVD** switch to **DVD**.

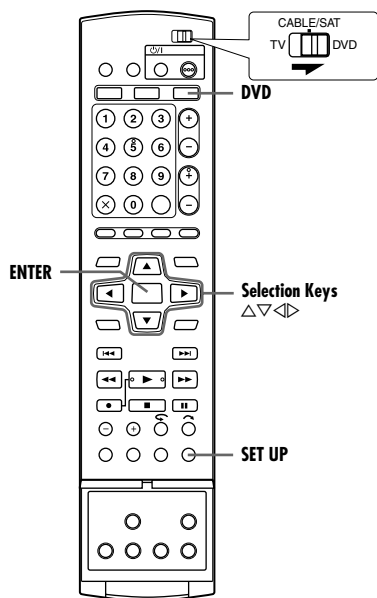

- 1 Press **DVD** so that the DVD lamp lights up on the unit.
- 2 Press **SET UP** to access the Main Menu screen.
 - You cannot set the monitor type during recording or playback.
- 3 Press **selection keys** to select "FUNCTION SET UP", then press **▽**.
- 4 Press **selection keys** to select "VIDEO IN/OUT", then press **▽**.
- 5 Press **selection keys** to select "MONITOR TYPE", then press **ENTER**.
- 6 Press **selection keys** to select the desired option, then press **ENTER**.
- 7 Press **SET UP** to complete the setting.

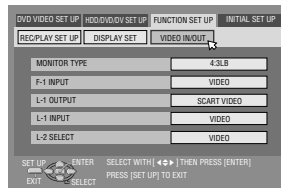

* The **boldface** settings below indicate the settings at your purchase.

■ MONITOR TYPE – **4:3LB** / 4:3PS / 16:9AUTO / 16:9FIX

4:3LB (Letter Box conversion):

Select this when the aspect ratio of your TV is 4:3 (conventional TV). While viewing a wide screen picture, the black bars appear on the top and the bottom of the screen.

4:3PS (Pan&Scan):

Select this when the aspect ratio of your TV is 4:3 (conventional TV). While viewing a wide screen picture, the black bars do not appear; however, the left and right edges of the pictures will not be shown on the screen.

16:9AUTO (Wide television conversion):

Select this when the aspect ratio of your TV is 16:9 (wide TV).

16:9FIX (Wide television conversion):

Select this when the aspect ratio of your TV is fixed to 16:9 (wide TV). The unit automatically adjusts the screen width of the output signal correctly when playing back a picture whose aspect ratio is 4:3.

Pan&Scan/Letter Box

In general, DVD VIDEO disc are produced for a wide-screen TV with 16:9 aspect ratio.

Material with this ratio will not fit to a TV with 4:3 aspect ratio.

There are two styles to display the image, "Pan&Scan" (PS) and "Letter Box" (LB).

Pan&Scan

The right and left side of the image are cut off. The image fills the screen.

- The picture will be shown in the "4:3LB" mode depending on the disc even if the "4:3PS" mode is selected.

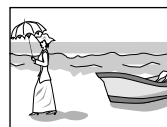

Letter Box

Black bands appear at the top and bottom of the image. The image itself appears in 16:9 aspect ratio.



Basic Playback



- Turn on the unit.
- Turn on the TV and select the AV mode.
- Slide the **TV/CABLE/SAT/DVD** switch to **DVD**.

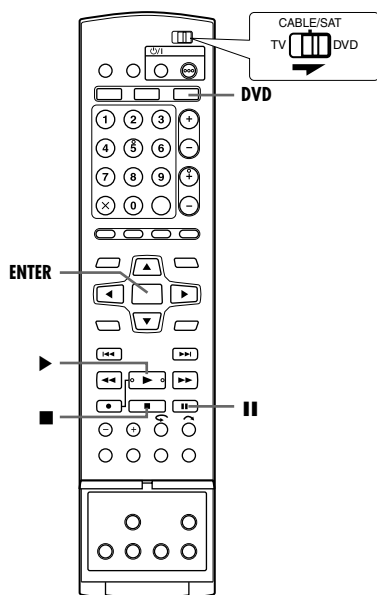
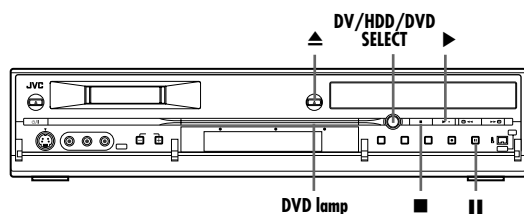

ATTENTION:

- It takes approximately 30 seconds to read a disc depending on the type and condition of the disc since this unit is multi-disc compatible (DVD-RAM, DVD-RW, DVD-R). It may even take several minutes when a disc is dirty, scratched or warped.
- It may take a few seconds to start playback. This is not a malfunction.
- Forward/reverse high-speed search and other operations cannot be performed while playback is stopped.

To play back an MP3/JPEG disc, see "Playback With MP3/WMA/JPEG Navigation" (pg. 57).

- 1 Load a disc.
 - For details, refer to "Placing A Disc" (pg. 9).
 - Pressing **▶** also closes the disc tray.
 - Playback begins automatically if an auto-playback DVD disc is loaded.
- 2 Press **DV/HDD/DVD SELECT** on the unit repeatedly or **DVD** on the remote control so that the DVD lamp lights up on the unit.
- 3 Press **▶** to start playback.
 - If you load a DVD disc whose region code does not match the unit, "REGION CODE ERROR" appears on the TV screen. For details, refer to "Region Number" (pg. 7).
 - If "CAN NOT PLAY BACK DISC UNDER CURRENT SETTING" appears on the TV screen, refer to "Parental Lock" (pg. 33).
 - With Video CD/SVCD discs with PBC control or some DVD discs, the menu display may appear on the TV screen after starting playback. In this case, select an item which you want to play back from the menu. Otherwise, the playback cannot go forward. Refer to "Playback Control (PBC) Function" (pg. 28) or "Locating A Desired Scene Using The DVD Menu" (pg. 25).
 - The Library Database Navigation also enables you to search and select the desired titles. (pg. 52)
- 4 Press **⏸** to pause playback.
 - To resume normal playback, press **▶**.
- 5 Press **■** to stop playback.
 - When a recordable disc is played, playback stops and a programme received with the unit's tuner or AV input (from external AV source) resumes on the TV screen.
 - When a playback-only disc is played, playback stops and the TV screen becomes all blue when you press **■**. Pressing **■** again resumes a programme received with the unit's tuner.
 - If **▲** is pressed during playback, playback stops, then the disc tray opens.

NOTES:

- When the Library Database Navigation screen appears, choose a thumbnail image of the desired title on the TV screen, then press **ENTER**. (pg. 52)
- It is not possible to playback the DVD disc recorded in 96 kHz on DVD during recording or Live Memory Playback on HDD.
- It is possible to play back on the DV deck and the HDD/DVD deck simultaneously. However, either DVD or HDD can be played at the same time.

Playback Features

- Turn on the unit.
- Turn on the TV and select the AV mode.
- Slide the TV/CABLE/SAT/DVD switch to DVD.
- Press DVD so that the DVD lamp lights up on the unit.

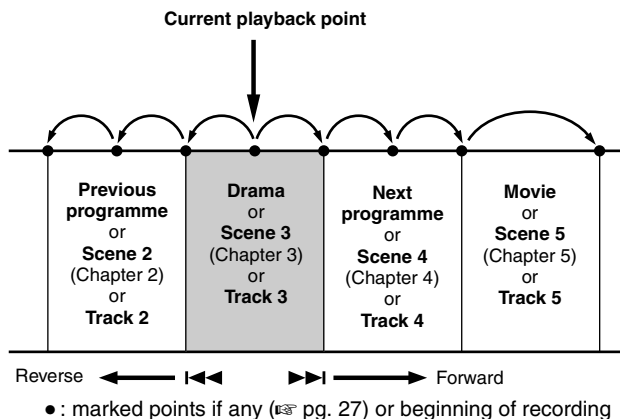
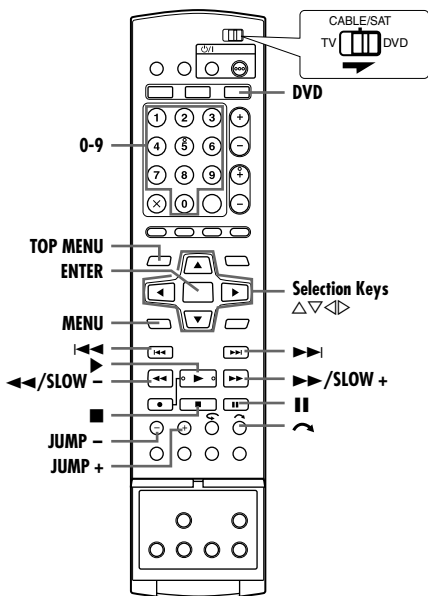

Variable Speed Search



- During playback, press **▶▶** for forward variable speed search, or **◀◀** for reverse variable speed search.
- Each press of the button increases the search speed for each direction.
 - To resume normal playback, press **▶**.

For Audio CD

You can perform 4 levels of speed search with **▶▶** and **◀◀**. (Audio is active also during variable speed search.) You cannot perform slow motion for each direction.

Reverse ◀◀				▶▶ Forward											
Reverse Search 4 steps	Reverse Play	Reverse Slow Motion 3 steps	Slow Motion 3 steps	Normal Play	Forward Search 4 steps										
-60 -15 -5 -3	-1	-1/2 -1/4 -1/8	1/8 1/4 1/2	1	3 5 15 60										

Locating A Desired Scene Using The DVD Menu



DVD VIDEO discs may have top menu and disc menu.

Top menu

DVD discs generally have their own menus which show the disc contents. These menus contain various items such as titles of a movie, names of songs, or artist information. You can locate a desired scene by using the top menu displayed on the TV screen. Press **TOP MENU** to access the top menu.

Disc menu

Disc menus include playback data (angle menu, subtitle menu, etc.) specific to each title. Press **MENU** to access the disc menu.

- 1 Press **TOP MENU** or **MENU** to access the DVD menu.
- 2 Press **selection keys** to select a desired title, then press **ENTER**. Playback starts.
 - It may be possible to select the desired item using the **number keys** depending on the menu display.

Example:

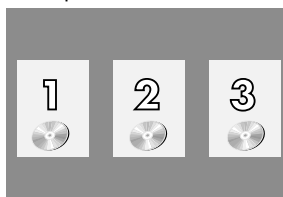

NOTE:

When "⊙" appears on the TV screen in step 1, the disc does not have a top menu or disc menu.

Locating The Start Point Of The Item Or Skip The Item



Press **◀◀** or **▶▶** during playback.

- Pressing **▶▶** locates the start point or marked points of the item or skips the item in the forward direction, then resumes playback.
- Pressing **◀◀** locates the start point or marked points of the item or skips the item in the reverse direction, then resumes playback.

Still Picture/Frame-By-Frame Playback



- 1 Press **||** to pause during playback.
- 2 Press **SLOW -** (**◀◀**) or **SLOW +** (**▶▶**) to activate frame-by-frame playback.
 - Each press of **SLOW -** (**◀◀**) or **SLOW +** (**▶▶**) advances/reverses the still picture frame by frame.
 - Frame-by-frame playback for reverse direction cannot be performed with Video CD/SVCD discs.
 - To resume normal playback, press **▶**.

Slow Motion



- 1 Press **||** to pause during playback.
- 2 Press **SLOW -** (**◀◀**) or **SLOW +** (**▶▶**) for 2 or more seconds.
 - Each press of **SLOW -** (**◀◀**) or **SLOW +** (**▶▶**) increases the slow motion speed for each direction.
 - Slow motion for reverse direction cannot be performed with Video CD/SVCD discs.

Skip Search



During playback, press .

- Each press initiates an approximately 30-second period of fast-motion playback. Normal playback resumes automatically.
- Skip search cannot be performed when a VCD/SVCD disc is being played back with the PBC function.

One Touch Replay



You can move back the playback position slightly.

Press .



- Each press skips back for approximately 7 seconds and resumes playback.
- Pressing while paused skips back for approximately 7 seconds and resumes pause.

Jump Search



You can locate a scene ahead or behind the current one by jumping scenes according to selected time intervals (see pg. 73) during playback (or Live Memory Playback).

Press **JUMP -** or **JUMP +**.

- To advance forward or back, press **JUMP -** or **JUMP +** repeatedly within 5 seconds of each press to continue jump.
- Depending on the time from where you want to start jump search, the first press of **JUMP -** or **JUMP +** will not necessarily lead to a jump to the selected time interval. The first press will lead to a jump to the nearest quarter points of an hour (15 min/ 30 min/ 45 min/ 00 min). The subsequent jumps will then be in accordance to the selected time interval.
- When you cannot advance any further (beginning or end of programme reached), the message "UNABLE TO GO BACK ANY MORE" appears on the screen and the on-air screen resumes. In such a case, press ,  or .

Example:

Playback search when jump interval is set to 15 MIN jumps. Taking for instance, you want to start jump search 40 minutes after the beginning of the programme. Pressing **JUMP -** or **JUMP +** will result in a jump to the scene at the 30 minutes point or 45 minutes point respectively as illustrated below. At the subsequent press, the scene will jump to the 15 minutes point or 1 hour point respectively, according to the selected time interval, which in this case is "15 MIN".

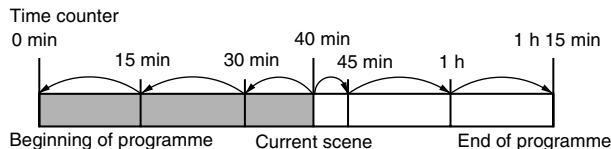

NOTE:

Jump search cannot be performed with finalised DVD-R/DVD-RW (video mode) discs.

Resume Function





It is possible to memorise the position where you stop playback and resume playback from that position.

- Be sure to set "RESUME" to "ON" or "DISC RESUME". (see pg. 72)
- Resume function always works for DVD-R/DVD-RW discs that have not been finalised and DVD-RAM regardless of the setting of "RESUME".

1 Press  during playback to memorise a resume point.

- The unit enters Resume Stop mode and memorises the position where you have stopped playback as a resume point. (The inside of the disc status indicator on the front display panel blinks while memorising.)
- The unit retains a memory of the resume points of the last 30 discs played back, even though they have been ejected if "RESUME" is set to "DISC RESUME". (see pg. 72)
- Performing the following steps would erase the resume points: (The inside of the disc status indicator stops blinking and lights.)

When "RESUME" is set to "ON":

- Press  to turn off the unit.
- Press  to take out the disc.
- Press  in stop mode.
- Press **TOP MENU** to display the top menu, then start playback by selecting an item, etc.
- Press **MENU** to display the disc menu, then start playback by selecting an item, etc.

When "RESUME" is set to "DISC RESUME":

- Set "RESUME" to "OFF". (see pg. 72)
- Press  in stop mode.
- Press **TOP MENU** to display the top menu, then start playback by selecting an item, etc.
- Press **MENU** to display the disc menu, then start playback by selecting an item, etc.

2 Press  in stop mode to resume playback. The unit starts playback from the resume point.

NOTES:

- "DISC RESUME" setting works on DVD VIDEO, VCD, SVCD and already finalised DVD-R/DVD-RW (video mode) discs. For other types of discs, the function under "ON" setting will be applied even if "RESUME" is set to "DISC RESUME". (see pg. 72)
- If you stop the playback of a disc for which a resume point has already been memorised, the memory will be updated with the new resume point.
- After the unit has memorised the resume points for 30 discs, remembering a new resume point will cause the unit to delete the oldest memorised point. Stopping playback of a disc for which a resume point is already stored may change the order in which the points are stored. This may potentially change the order in which points are deleted.
- When the unit memorises a resume point for a disc, it also remembers audio language, subtitle and angle settings.
- This function may not work for some Video CD/SVCDs.
- When "RESUME" is changed to "ON" or "OFF" (see pg. 72), resume points of the discs memorised with "RESUME" set to "DISC RESUME" will be cleared.
- Resume points are memorised for each side of a double-sided disc.
- When you switch to HDD while playing back JPEG/MP3 files, playback stops. The Resume Function doesn't work when you switch to DVD thereafter to playback the disc.

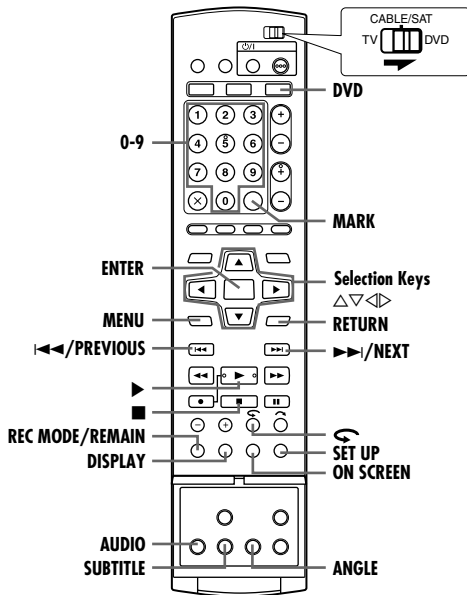

Marking Positions To Play Back Again Later



It is possible to mark positions (up to 999 points) where you want to play back once again later, and start playback from a marked position. Marking onto DVD-RAM/RW (VR mode only) discs when recording is helpful to locate a start point when you play back the discs later.

To mark positions:

During playback, press **MARK** at positions you want to mark.

- "MARK" appears on the TV screen. You can easily locate the marked positions using **PREVIOUS** or **NEXT** when you play back the disc.

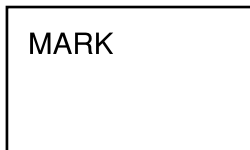

To delete the marked positions:

While paused, press **PREVIOUS** or **NEXT** to locate a marked position you want to delete, then press **MARK**.

- Crossed "MARK" appears on the TV screen, and the marked position is deleted.



NOTES:

- When a monaural programme changes to a stereo programme while recording, a mark signal is automatically recorded.
- For DVD-R/RW (Video mode) discs, marks are assigned automatically every 5 minutes.
- If **MARK** is pressed when playing back a disc that does not allow marks to be inserted, "⊗" appears on the TV screen.

Checking The Time Information



You can check time information of a disc on the front display panel and the TV screen.

■ DVD-RAM/DVD-R/DVD-RW

Each press of **DISPLAY** changes the display as follows:

During recording

Clock time (front display panel only) → Current title elapsed time → Disc remaining time → (back to the beginning)

During playback

Each title elapsed time → Total remaining time → Remaining time* → (back to the beginning)

* only discs before finalising

During recording/playback or in stop mode

Press **REC MODE**.

- The disc remaining time according to recording modes appears on the TV screen.
- It is possible to check disc remaining time according to recording modes also by pressing **REMAIN**.
- In FR mode, it is possible to set recording time in detail. While the recording mode and the disc remaining time are displayed by pressing **REMAIN**, press **selection keys** to select "FR", then press **<|>** to select the desired recording time. (see pg. 36)
- It is not possible to switch the recording mode during playback or while recording.

■ Video CD/SVCD/Audio CD

During playback or in stop mode

Current track elapsed time → Current track remaining time → Total elapsed time → Total remaining time → (back to the beginning)

NOTES:

- When a PBC-compatible Video CD/SVCD disc is loaded, deactivate the PBC function. (see pg. 28)
- For pre-recorded DVD VIDEO, only the title, chapter and elapsed time are displayed when **ON SCREEN** is pressed.

Angle Selection



You can enjoy a variety of scene angles if a DVD VIDEO disc contains "multi-angle" parts, where the same scene was shot from different angles.

If the disc contains "multi-angle" parts, "⊞" appears on the TV screen at the beginning of the "multi-angle" part.

1 Press **ANGLE** during playback.

The angle selection display appears on the TV screen.



When 3 scene angles are contained.

2 Press **ANGLE** or **selection keys** to select your desired angle.

- Each time you press **ANGLE** or the **selection keys**, the angle changes.
- When "⊞" appears on the TV screen, the current scene is not recorded from multiple angles. In addition, some discs prohibit angle selection.
- To clear the angle selection display, press **ENTER**. In addition, the angle selection display disappears automatically if no operation is done for 10 seconds.

Subtitle Selection



Some DVD VIDEO discs contain more than one subtitle language, from among which you can choose the desired subtitle language. " " appears on the TV screen at the beginning of the part where more than one subtitle language are recorded.

1 Press **SUBTITLE** during playback. The subtitle selection display appears on the TV screen.

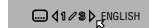

When 3 subtitle languages are contained.

- Each time you press **SUBTITLE**, the subtitle display is switched on and off.

2 Press **selection keys** to select your desired language.

- To clear the subtitle selection display, press **ENTER**.

NOTES:

- When " " appears on the TV screen, no subtitle language is recorded.
- When the subtitle language won't be changed with the procedure above, change the subtitle on a disc menu displayed by pressing **MENU**.

Audio Channel Selection



When watching bilingual programmes or playing discs on which you recorded bilingual or stereo programmes, you can choose the desired audio channel.

- When "SUPERIMPOSE" is set to "AUTO", you can confirm on the TV screen the audio channel you have chosen. (pg. 73)
- Each time you press **AUDIO**, the audio channel changes.



TRACK	USE
On-Screen Display	
	For main audio of bilingual programme
	For sub audio of bilingual programme
	For stereo discs
	For audio of left channel
	For audio of right channel

NOTE:

It is not possible for DVD-R/DVD-RW (Video mode) disc playback to switch the audio channel. The audio channel is played back as set in "VIDEO MODE RECORDING AUDIO" setting. (pg. 72)

When you can't switch the audio channel of a bilingual programme

When the unit is connected with a digital audio device using an optional optical cable and "DIGITAL AUDIO OUT" is set to "DOLBY DIGITAL/PCM", it is not possible to switch the audio channel of a bilingual programme recorded on a DVD-RAM or DVD-RW (VR mode) disc. (pg. 70) In this case, perform the following steps using the remote control to switch "DIGITAL AUDIO OUT" from "DOLBY DIGITAL/PCM" to "PCM ONLY".

- Press **SET UP** to access the Main Menu screen.
- Press **selection keys** to select "DVD VIDEO SET UP", then press **▽**.
- Press **selection keys** to select "AUDIO OUTPUT", then press **▽**.
- Press **selection keys** to select "DIGITAL AUDIO OUT", then press **ENTER**.
- Press **selection keys** to select "PCM ONLY", then press **ENTER**. (pg. 71)
- Press **SET UP** to complete the setting.
- Press **AUDIO** to select the desired audio channel.

Audio Language/Sound Selection



Some DVD VIDEO discs contain the multiple audio language or sound. You can select the desired audio language or sound. For some Video CD/SVCD discs, you can switch the audio channel to choose Karaoke either with or without the vocal.

1 Press **AUDIO** during playback. For example: DVD VIDEO The Audio Language/Sound selection display appears.



When 3 audio languages are contained.

2 Press **AUDIO** or **selection keys** to select your desired audio language/sound.

- Each time you press **AUDIO** or the **selection keys**, the audio language/sound changes.
- To clear the Audio Language/Sound selection display, press **ENTER**.

NOTES:

- When " " appears on the TV screen, no other audio language is recorded.
- When the audio language won't be changed with the procedure above, change the audio on a disc menu displayed by pressing **MENU**.
- Pressing **AUDIO** to select the audio language/sound is only possible during playback. It is not possible to select by pressing **AUDIO** in stop mode. However, you can select the desired audio language/sound from the setup menu while in stop mode.

Playback Control (PBC) Function



Some Video CD/SVCD discs support the PBC function. PBC is an abbreviation of "Play Back Control". A Video CD/SVCD disc recorded with PBC has its own menus, such as a list of the songs on the disc. You can locate a specific scene by using the menu.

1 Press **▶** in stop mode. The PBC menu appears.

2 Press the **number keys** to enter the number of the desired scene, then press **ENTER**. The unit starts playback of the selected item.

- "PBC" appears on the front display panel.
- When "NEXT" or "PREVIOUS" appears on the TV screen: Pressing **NEXT(▶▶)** advances to the next page. Pressing **PREVIOUS(◀◀)** returns to the previous page.
- You can return to the menu by pressing **RETURN**.
- The method of the operation is different depending on the disc.

NOTE:

If you want to playback a PBC-compatible Video CD/SVCD disc without activating the PBC function, start playback with the PBC function, then press **■** to stop playback. The TV screen becomes all blue. Then start playback in stop mode by using the **number keys** to choose the track, then press **ENTER**.

Using The On-screen Bar



The on-screen bar allows you to control various playback functions. Some of the functions operated on Navigation Menu can be controlled on the On-screen bar.

ATTENTION:

The on-screen bar can also be used for the HDD deck.

Be sure to clear Library Database Navigation screen by pressing **NAVIGATION**.

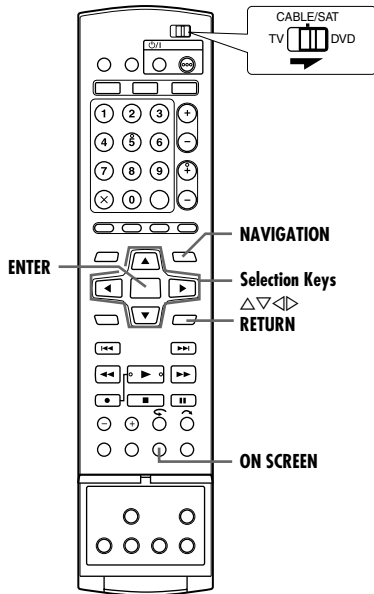

- 1 Disc type.
- 2 Select this for Repeat Playback. (See below)
- 3 Select this for A-B Repeat Playback. (pg. 30)
- 4 Select this for search function. (pg. 30)
- 5 Select this for time search function. (pg. 31)
- 6 Select this to switch Simulated Surround Effect function. (pg. 31)
- 7 Select this for Picture Control function. (pg. 31)
- 8 Select this to switch picture source type. (pg. 32)
- 9 Current status area for the selected item.
- 10 Select this for Programme Playback. (pg. 32)
- 11 Select this for Random Playback. (pg. 32)
- 12 Select this to control the switching interval of the slide show. (pg. 32)

NOTE:

Although examples of the on-screen bar are provided here only for 3 types of discs, the on-screen bar will be displayed for whichever disc indicated in the left column.

Basic Operation On The On-screen Bar

Example: When selecting Picture Control function of DVD

During playback or while stopped

- 1 Press **ON SCREEN** twice to access the on-screen bar. The item currently selected is highlighted and pointed by



- 2 Press **selection keys** to select "CINEMA", then press **ENTER**. The pop-up window appears under the selected item.



- 3 Press **selection keys** to select the desired option, then press **ENTER**.

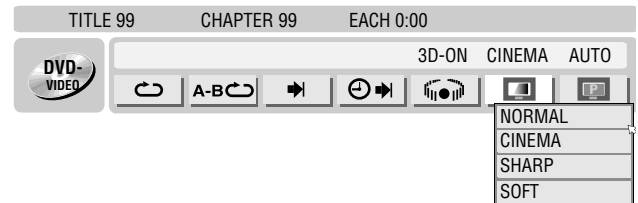

To clear the on-screen bar

Press **ON SCREEN**.

NOTE:

See the corresponding pages for details on each menu item.

Repeat Playback



You can repeat playback as you like according to the type of disc.

- 1 Press **ON SCREEN** twice to access the on-screen bar.
- 2 Press **selection keys** to select "Repeat Playback" icon, then press **ENTER**. The pop-up window appears under the selected item.



- 3 Press **selection keys** repeatedly to select the desired Repeat mode, then press **ENTER**.

How To Access The On-screen Bar

- 1 Press **ON SCREEN** twice whenever a disc is loaded.

Contents of the on-screen bar during playback

DVD VIDEO

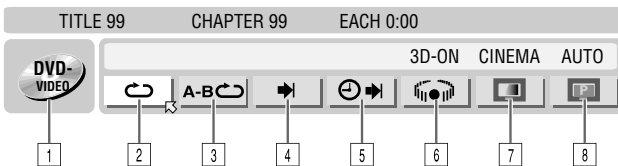

Video CD/SVCD

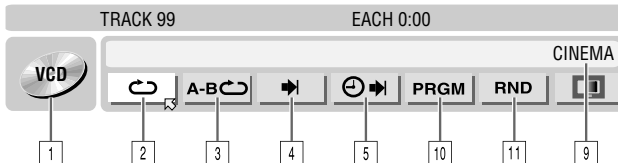

JPEG disc

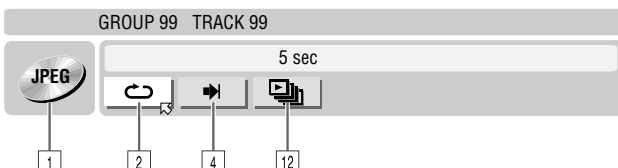

DVD-RAM/RW/R

OFF:
Repeat playback is not performed.

ALL REPEAT:
The whole disc is played back repeatedly.

TITLE REPEAT:
The current title is played back repeatedly.

DVD VIDEO

OFF:
Repeat playback is not performed.

TITLE REPEAT:
The current title is played back repeatedly.

CHAPTER REPEAT:
The current chapter is played back repeatedly.

Audio CD/Video CD/SVCD/JPEG/MP3

OFF:
Repeat playback is not performed.

ALL REPEAT:
The whole disc is played back repeatedly.

TRACK REPEAT*:
The current track is played back repeatedly.

* "TRACK REPEAT" cannot be selected for JPEG discs.

To clear the on-screen bar

Press **ON SCREEN**.

To cancel Repeat Playback

Repeat the above procedure from step 1, select "OFF" in step 3, then press **ENTER**.

NOTES:

- Repeat Playback is not possible for a Video CD/SVCD with PBC function.
- Repeat Playback may not work properly depending on the type of the disc being used.

A-B Repeat Playback



You can repeat the desired part.

During playback

- 1 Press **ON SCREEN** twice to access the on-screen bar.
- 2 Press **selection keys** to select "A-B"
- 3 Press **ENTER** at the beginning of the desired part you want to repeat (point A). The elapsed playing time of the point A appears.

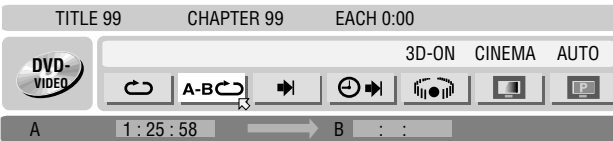

- 4 Press **ENTER** at the end of the desired part you want to repeat (point B). The elapsed playing time of the point B appears.

• The selected part of the disc (between point A and B) is played repeatedly.

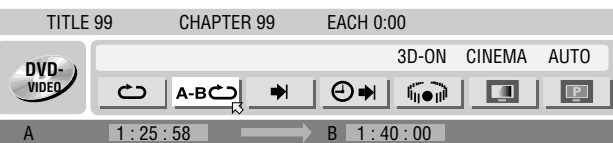

To clear the on-screen bar

Press **ON SCREEN**.

To cancel A-B Repeat Playback

Press **selection keys** to select "A-B" , then press **ENTER**.

NOTES:

- A-B Repeat Playback may not work properly depending on the type of disc being used.
- The subtitles recorded around the A-B point may not appear.
- When the end of the item is reached before the end point is set, the on-screen bar disappears from the TV screen. In such a case, repeat the procedure from step 1.
- The point B must be set at least 3 seconds after the point A.
- When playing back a DVD, A-B Repeat Playback is possible only within the same title.
- "A-B" cannot be selected during Programme and Random Playback.
- "A-B" cannot be selected while stopped.

Locating The Beginning Of A Desired Selection



You can locate the beginning of a title, chapter, group or track.

During playback or while stopped

- 1 Press **ON SCREEN** twice to access the on-screen bar.
- 2 Press **selection keys** to select "➡", then press **ENTER**.
- 3 Press **selection keys** to select the desired item, then press **ENTER**.
 - Skip this step for Video CD/SVCD and Audio CD.

For DVD-RAM/RW/R, DVD VIDEO

"TITLE SEARCH" or "CHAPTER SEARCH" is selectable. (However, "CHAPTER SEARCH" is not selectable while stopped.)

For JPEG, MP3

"GROUP SEARCH" or "TRACK SEARCH" is selectable. (However, "TRACK SEARCH" is not selectable while stopped.)

For Video CD/SVCD, Audio CD

"TRACK" is selectable.

NOTE:

Settings that are selectable during playback and stop mode differ depending on the type of disc and search used.

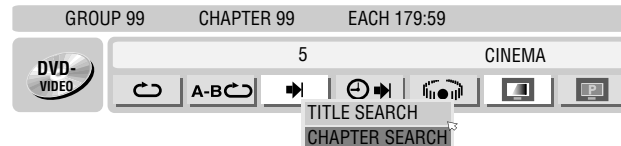

- 4 Press the **number keys** to enter the desired item number, then press **ENTER**.
 - Playback starts from the selected section.

Examples:

- 1 To select track 5, press the **number key "5"**.
- 2 To select track 15, press the **number key "1"** and **"5"**.
- 3 To select track 25, press the **number key "2"**, then **"5"**.

If you have specified a wrong selection

Press **RETURN** on the remote control and repeat the above procedures from step 2.

To clear the on-screen bar

Press **ON SCREEN**.

NOTES:

- When "⊙" is displayed on the TV screen in step 4, the chapter you have selected is not contained in the disc, or chapter search does not work on the disc.
- Before you press **ENTER**, playback may start automatically when you enter the section's number depending on the disc.
- This function is not possible for a Video CD/SVCD with PBC function.

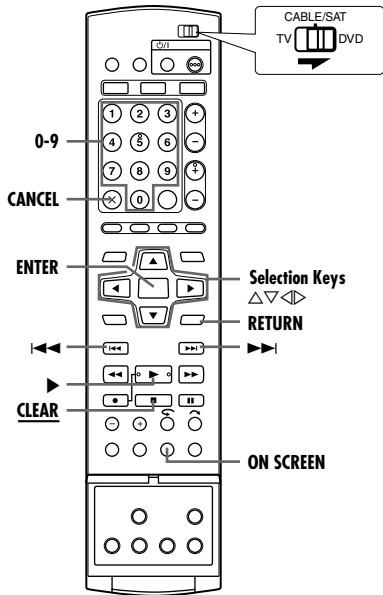

Time Search



You can play back a disc from the desired point by specifying the elapsed playing time from the beginning of a programme (DVD-RAM, DVD-R, DVD-RW, DVD VIDEO and HDD) or a disc (Video CD/SVCD and Audio CD).

- 1 Press **ON SCREEN** twice to access the on-screen bar.
- 2 Press **selection keys** to select “⏮➡”, then press **ENTER**. The pop-up window appears under the selected item.

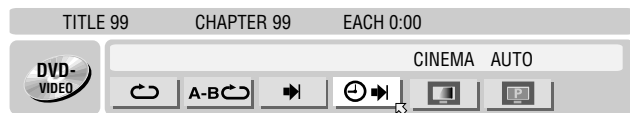

- 3 Press the **number keys** to enter the time, then press **ENTER**. Playback starts from the specified time.

Example:
To play back from a point 12 (minutes): 50 (seconds) elapsed.

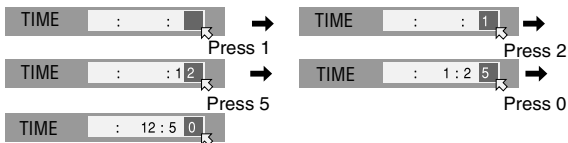

If you have specified a wrong selection,
Press **RETURN** on the remote control and repeat the above procedures from step 2.

To clear the on-screen bar
Press **ON SCREEN**.

- NOTES:**
- When “⏮” is displayed on the TV screen in step 3, you have selected a point that exceeds the recording time of the disc.
 - Some DVD VIDEO discs do not contain time information, and it is not possible to use the Time Search function. In such cases, “⏮” is displayed on the TV screen as well.
 - This function is not possible for a Video CD/SVCD with PBC function.

Simulated Surround Effect



It is possible to get a simulated surround effect from your stereo system. You can enjoy the virtual surround sound with your 2-channel stereo system.

- 1 Press **ON SCREEN** twice to access the on-screen bar.
- 2 Press **selection keys** to select “⦿”, then press **ENTER**.
 - “3D-ON” appears above the selected item and Simulated Surround Effect is activated.
 - Each time you press **ENTER**, “3D-ON” appears and disappears alternately.



To clear the on-screen bar
Press **ON SCREEN**.

To cancel the simulated surround effect
Press **ENTER** to clear “3D-ON” from the screen.

- NOTES:**
- Simulated Surround Effect works correctly only when playing back a title recorded in multichannels.
 - Simulated Surround Effect does not affect the DVD VIDEO bitstream signal from the [DIGITAL AUDIO OUT] connectors.
 - When Simulated Surround Effect is activated, the settings of “ANALOG AUDIO OUT” and “D. RANGE CONTROL” are disabled. (pg. 71)
 - Simulated Surround Effect cannot be activated under the following conditions:
 - When the HDD deck is in the recording mode.
 - When the HDD or DVD deck is in the timer standby mode.
 - When a disc containing both the Dolby Digital 5.1CH and 2CH sound formats is playing back a scene that is not in the 5.1CH sound format.

Adjusting The Picture Quality



You can obtain optimal picture quality by selecting an appropriate picture mode.

- 1 Press **ON SCREEN** twice to access the on-screen bar.
- 2 Press **selection keys** to select “P”, then press **ENTER**. The pop-up window appears under the selected item.



- 3 Press **selection keys** to select the desired option, then press **ENTER**.
 - NORMAL:**
Normally select this option.
 - CINEMA:**
Suitable for a movie disc, etc.
 - SHARP:**
Clearer, sharper-edged picture when viewing images with lots of flat, same-coloured surfaces such as cartoons.
 - SOFT:**
Select this option when too much noise appears.

To clear the on-screen bar
Press **ON SCREEN**.

Setting The Progressive Mode



You can obtain optimal picture quality by selecting whether the content on the disc is processed by field (video source) or by frame (film source).

- 1 Set the unit to the progressive scan mode. (pg. 80)
- 2 Press **ON SCREEN** twice to access the on-screen bar.
- 3 Press **selection keys** to select "A-B", then press **ENTER**. The pop-up window appears under the selected item.



- 4 Press **selection keys** to select the desired option, then press **ENTER**.

AUTO:

This mode automatically detects film and video content for progressive playback. When film content is found, flag detection is used to invoke playback of film data in full screen. When video content is found, pictures from multiple fields are used to detect sections with movement, and then this movement undergoes advanced image processing for output of sharp, detailed progressive images without any reduction in image quality where movement occurs. Normally, operation in this mode is recommended.

FILM:

Suitable for playing back a progressive scanned film source disc.

VIDEO:

Suitable for playing back a video source disc. The outlines on the played back pictures will be soft.

To clear the on-screen bar

Press **ON SCREEN**.

NOTE:

When the progressive mode is set, be sure to set "L-1 OUTPUT" to "COMPONENT" (pg. 64). Progressive scan is output only from [COMPONENT VIDEO OUT] connectors.

Programme Playback



You can programme up to 30 tracks (Video CD/SVCD or Audio CD) to play back in the desired order.

While stopped

- 1 Press **ON SCREEN** twice to access the on-screen bar.
- 2 Press **selection keys** to select "PRGM", then press **ENTER**. The programme table appears under on-screen bar.



- 3 Press the **number keys** to enter the track numbers in the desired order.

Examples:

- 1 To select track 5, press the **number key "5"** and **ENTER**.
- 2 To select track 15, press the **number key "1"** and **"5"**.
- 3 To select track 25, press the **number key "2"** and **"5"**.

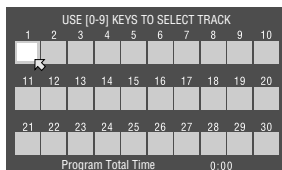

If you have specified a wrong selection

Press **CANCEL(X)**. The last selection is erased.

Or press **CLEAR(■)**. The whole selection is erased.

- 4 Press **▶**. Playback starts in the programmed order.

- When all of the programmed tracks have been played back, Programme Playback stops, but the programmed information remains.
- To add tracks to the end of the programme, perform steps 3.
- During Programme Playback, pressing **▶▶** skips to the next selection of the programme. Pressing **◀◀** returns to the beginning of the current selection.

To clear the on-screen bar and the contents of the programme
Press **ON SCREEN**.

To cancel Programme Playback

Press **selection keys** to select "PRGM", then press **ENTER**.

NOTE:

Programme Playback is not possible depending on the type of disc.

Random Playback



You can play back all the tracks on the disc in random order.

While stopped

- 1 Press **ON SCREEN** twice to access the on-screen bar.
- 2 Press **selection keys** to select "RND", then press **ENTER**. Playback starts in random order.



To clear the on-screen bar

Press **ON SCREEN**.

To cancel Random Playback

Perform steps 1 and 2.

NOTE:

The same track will not be played back more than once during Random Playback.

Select The Switching Interval Of The Slide Show



You can control the switching interval of the slide show.

- 1 Press **ON SCREEN** twice to access the on-screen bar.
- 2 Press **selection keys** to select "5 sec", then press **ENTER**. The pop-up window appears under the selected item.

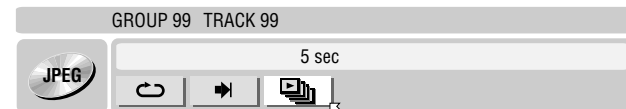

- 3 Press **selection keys** to select the desired option, then press **ENTER**.

- Each time you press the **selection keys**, the interval changes as follows:
5 sec -- 10 sec -- 15 sec -- 20 sec -- 25 sec -- 30 sec --
(Back to the beginning)

To clear the on-screen bar

Press **ON SCREEN**.

NOTE:

JPEG files are played back as a slide show. It may take more time to display an image with larger file size.

Parental Lock



This function restricts playback of DVD VIDEO discs which contain violent (and other) scenes according to the level set by the user. For example, if a movie which includes violent scenes supports the parental lock feature, such scenes which you do not want to let children view can be cut or replaced by other scenes.

- Turn on the unit.
- Turn on the TV and select the AV mode.
- Slide the TV/CABLE/SAT/DVD switch to DVD.
- Press DVD so that the DVD lamp lights up on the unit.

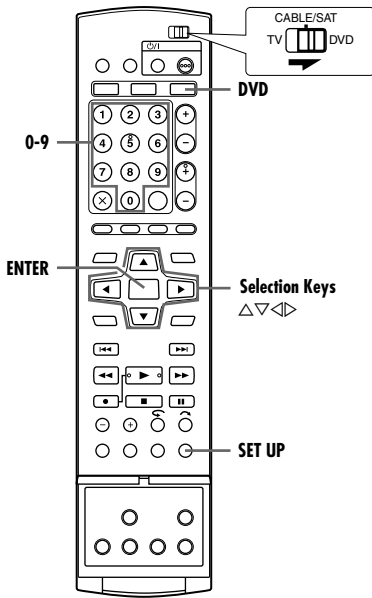

To Set Parental Lock For The First Time

While stopped

- 1** Press **SET UP** to access the Main Menu screen.
- 2** Press **selection keys** to select "DVD VIDEO SET UP", then press **▽**.
- 3** Press **selection keys** to select "PARENTAL LOCK", then press **▽**.
- 4** Press **selection keys** to select "PARENTAL LEVEL", then press **ENTER**.
- 5** Press **selection keys** to select the desired level, then press **ENTER**.
 - The smaller the value of level is, the more restrictive the Parental Lock level becomes.
 - Select "NONE" to cancel the restriction.
- 6** Press the **number keys** to enter your desired four-digit number, then press **ENTER**.
 - If you made a mistake, enter a correct number again.
- 7** Press **selection keys** to select "COUNTRY CODE", then press **ENTER**.

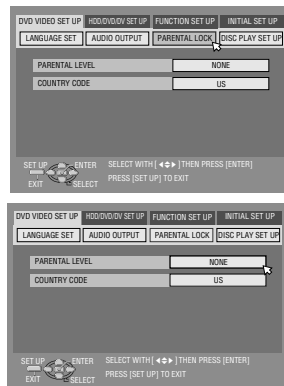

- 8** Press **selection keys** to select your country code, then press **ENTER**.
 - If you do not need to change your country code, jump to **10**.
 - See "Country/Area Code List for Parental Lock" (pg. 86).
- 9** Press the **number keys** to enter the same password as in step **6** above, then press **ENTER**.
- 10** Press **SET UP** to complete the setting.

NOTE:

Remember your password, or make a note of it.

To Change The Settings

You can change the Parental Lock settings later.

- 1** Perform steps **1** to **3** of "To Set Parental Lock For The First Time" to access the "PARENTAL LOCK" screen before continuing.

To change the level

- 2** Press **selection keys** to select "PARENTAL LEVEL", then press **ENTER**.
- 3** Press **selection keys** to select the desired level, then press **ENTER**.

To change the country code

- 4** Press **selection keys** to select "COUNTRY CODE", then press **ENTER**.
- 5** Press **selection keys** to select your country code, then press **ENTER**.
 - See "Country/Area Code List for Parental Lock" (pg. 86).
- 6** Press the **number keys** to enter the same password as in step **6** of "To Set Parental Lock For The First Time", then press **ENTER**.
- 7** Press **SET UP** to complete the setting.

NOTE:

If you forget your password, enter "8888" in step **6**.

To Temporarily Release Parental Lock

When you set the Parental Lock level strictly, some discs may not be played back at all. When you insert such a disc and try to play it back, the confirmation screen appears on the TV screen, asking you whether you want Parental Lock to be temporarily released or not.

- 1** Load a disc.
 - If the disc is rated higher than the selected level, the confirmation screen appears.
- 2** Press **selection keys** to select "YES", then press **ENTER**.
 - If you select "NO", you cannot play back that disc.
- 3** Press the **number keys** to enter the same password as in step **6** of "To Set Parental Lock For The First Time", then press **ENTER**.
 - When you enter the correct password, the Parental Lock is released and the unit starts playback.
 - If you enter a wrong password, "ENTRY ERROR" appears on the TV screen. Enter the correct password.
 - If you have successively entered wrong password three times, "ENTRY ERROR CAN NOT CHANGE PASSWORD" appears on the TV screen. In such a case, press **ENTER**. The disc will stop. Then play back the disc again, and try the procedure again from step **1**.

NOTE:

If you forget your password, enter "8888" in step **3**.

Basic Recording



- Turn on the unit.
- Turn on the TV and select the AV mode.
- Slide the TV/CABLE/SAT/DVD switch to DVD.

ATTENTION:
It is not possible to record programmes on a DVD-R disc which has already been finalised.

- Press **■** twice to stop recording.
 - It takes about 10 seconds to end the writing session when you stop recording.

NOTES:

- When switching from the HDD to the DVD deck, or when the unit is turned on while a playback only disc is loaded, the DVD deck enters into resume stop mode automatically and the TV screen becomes all blue. To display the EE* signal on the screen, press **■**.
 - * EE means Electronics to Electronics, no mechanical movement is involved. EE signal means a programme received with the unit's tuner or the AV input signals.
- It is recommended to format a DVD-RAM disc before use if you use the disc on this unit for the first time.
- When using a brand-new DVD-RW disc, format the disc either in VR mode or in Video mode. (pg. 78)
- Recordings made on DVD-R/RW disc must be finalised to play back on other DVD players. Perform "Finalise A Disc (DVD Deck Only)" (pg. 79).
- You can record up to 99 programmes and 99 play lists on each disc.
- Some programmes can only be recorded one time.
- When recording is started, an index of the first part of recording is automatically recorded. (pg. 51) To record satellite programmes, refer to page 50. To delete the index, refer to page 53.
- Recording sometimes may stop or cannot be performed even when there is enough available capacity remaining on the disc if the signal source is copy-protected or intermittent.
- It is not possible to record on both DVD and HDD simultaneously.
- It is not possible to record from this unit's built-in tuner to the DV deck.

Recording Mode

MPEG2 format is used as recording format. As a guide for picture quality, the "bps" unit is used to represent how much data can be recorded per second. The larger this value is, the better the picture quality becomes but more capacity is required for the recording. Select XP or SP for programmes where quick movement occurs, such as sports programmes, and LP or EP for talk shows, etc. with relatively less movement.

The recording modes for a 4.7 GB disc are set as follows:

Recording mode	Recording amount (approx.)	Maximum recording time (approx.)	
XP	10 Mbps	1 hour	
SP	5 Mbps	2 hours	
LP	2.5 Mbps	4 hours	
EP	1.6 Mbps	6 hours	
FR	60-360 (pg. 36)	The amount varies depending on the selected time.	
	420		1 – 6 hours
	480		7 hours
		8 hours	

- For details on FR mode, refer to "Free Rate Function" (pg. 36).

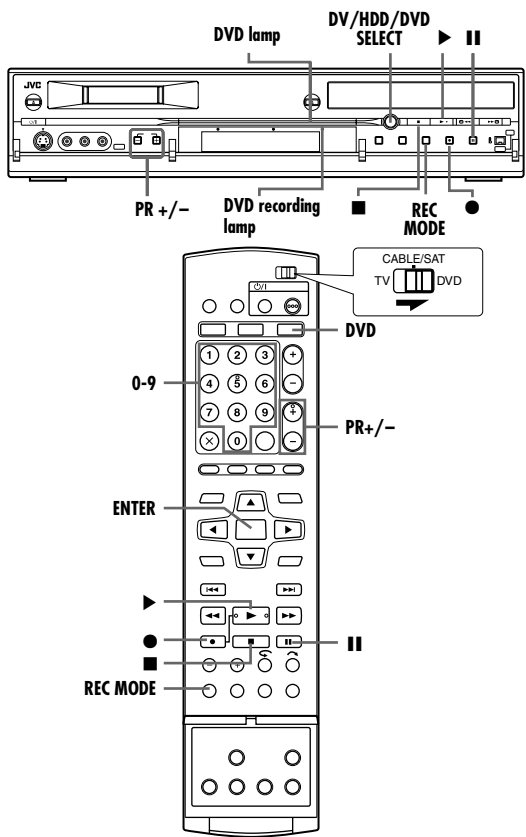

- Load a recordable disc.
 - For details, refer to "Placing A Disc" (pg. 9).
- Press **DV/HDD/DVD SELECT** on the unit repeatedly or **DVD** on the remote control so that the DVD lamp lights up on the unit.
- Press **PR +/-** or the **number keys** to select the channel you wish to record.
- Press **REC MODE** repeatedly to select the recording mode, then press **ENTER**.
 - Each time you press **REC MODE**, the recording mode changes as follows:
XP → SP → LP → EP → FR (60-360*, 420, 480) → (Back to the beginning)
 - * The value is selectable from 1 to 6 hours in 5-minute intervals by pressing **<D>** repeatedly after selecting "FR60-FR360". To change the value in 30-minute intervals, press and hold **<D>**.
 - For details on the recording mode, see the right column.
- Press **●** on the unit to start recording. Or while holding **●**, press **▶** on the remote control.
 - The DVD recording lamp lights up on the unit.
- Press **●** and **||** on the remote control simultaneously to pause recording.
 - To resume recording, press **●** and **▶** simultaneously.

Recording Features

- DVD RAM
- DVD R
- DVD RW
- DVD VIDEO
- VCD SVCD
- Audio CD
- MP3
- JPEG

- Turn on the unit.
- Turn on the TV and select the AV mode.
- Slide the **TV/CABLE/SAT/DVD** switch to **DVD**.
- Press **DV/HDD/DVD SELECT** on the unit repeatedly or **DVD** on the remote so that the DVD lamp lights up on the unit.

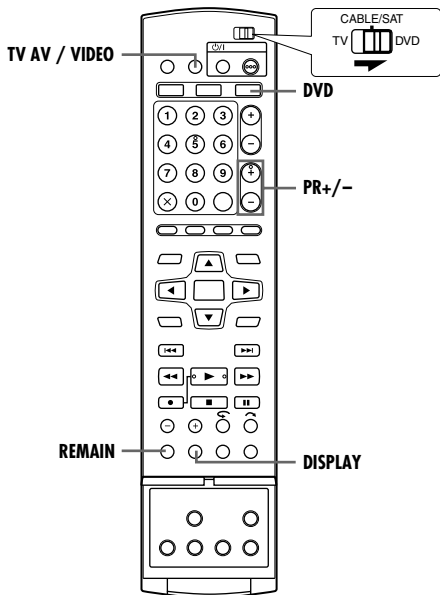
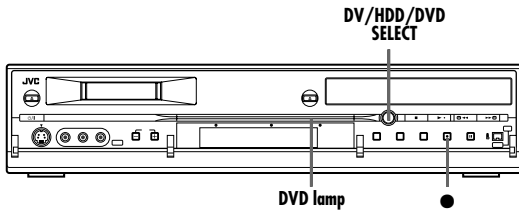

Instant Timer Recording (ITR)

This easy method lets you record for 30 minutes to 6 hours (selectable in 30-minute intervals), and shuts the unit off after recording is finished.

- 1** Press ● on the unit to start recording.
- 2** Press ● again to engage the ITR mode.
 - On the front display panel, “0:30” appears.
- 3** If you want to record for more than 30 minutes, press ● to extend the time. Each press extends recording time by 30 minutes.

NOTES:

- You can only perform ITR using the ● button on the unit.
- ITR is not possible during timer recording.
- When the recording capacity becomes full during timer recording or Instant Timer Recording, the unit automatically performs “Relief Recording” (see pg. 48).

Watch Another Programme While Recording On The Unit

While recording is going on, you can watch another programme on the TV by using the TV’s tuner.

NOTE:

It is required that the remote control is set to be able to operate the TV in advance. (see pg. 68)

- 1** During recording, press **TV AV/VIDEO** to select TV mode.
 - Video mode is disengaged, and the VIDEO indicator on the front display panel lights off.
 - VIDEO indicator lights off.

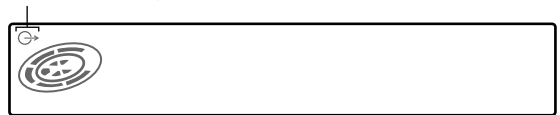

- The programme received on the TV’s tuner is displayed on the TV screen.
- 2** Slide the **TV/CABLE/SAT/DVD** switch to **TV**.
 - 3** Press **PR +/-** repeatedly to select the desired channel.

Elapsed Recording Time And Disc Remaining Time Indication

During recording, press **DISPLAY** repeatedly until the desired indication appears on the front display panel.

- Each time you press **DISPLAY**, the time indication changes as follows:
Elapsed recording time → Disc remaining time → Clock → (Back to the beginning)
- You can also check the disc remaining time by pressing **REMAIN** while the unit is stopped or recording is in progress. The list of disc remaining times for all recording modes appears on the TV screen.

Free Rate Function

To record the entire programme, the unit automatically sets the appropriate recording mode depending on the combination of the total time of the programme to be recorded and either the remaining disc space or the specified recording time (from 60 minutes to 480 minutes).

■ To record the entire programme within the actual remaining disc space (DVD deck only)

Select "FR (JUST)" in a recording mode selection procedure.

- Note that this function is available only for timer programming recording (☞ pg. 46, 48) and dubbing from HDD to DVD (☞ pg. 58).

■ To record the entire programme by specifying the desired recording time

Select "FR60–FR360", "FR420" or "FR480" in a recording mode selection procedure. (☞ pg. 34, 37, 46, 48)

■ To record a 25-min. long daily programme five times just on the same DVD disc for example

Perform "VIDEO Plus+ Timer Programming" (☞ pg. 46)

procedure. Be sure to set the recording mode to "FR125" and set Weekly/Daily Rec Function to "MON-FRI" in step 8 to fit the total recording time to the whole disc space.

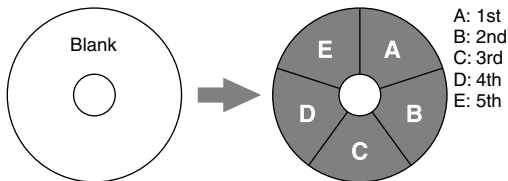

When the same programme is recorded in SP mode instead of in "FR125", the 5th programme cannot be recorded.

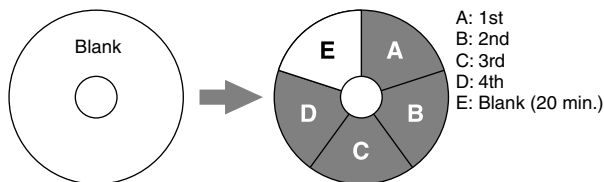

NOTES:

- You can programme this unit to timer record, regardless of the disc remaining time. When the disc remaining time is not enough, the unit performs "Relief Recording" (☞ pg. 48). To avoid this, make sure of the disc remaining time before setting timer programming.

(Example) If you programmed to timer record for 60 minutes in SP mode on a 120-minute disc, the disc remaining time would be 30 minutes in XP mode, 60 minutes in SP mode, 120 minutes in LP mode, 180 minutes in EP mode, and 240 minutes in FR480 mode. Timer recording will not complete beyond these remaining times.

- The maximum recording time of FR (JUST) mode is the same as the recording time of FR480 mode. When timer programming a long programme in FR (JUST) mode on a disc whose remaining time is short, it is recommended to check the disc remaining time in FR480 mode to see if the remaining time is enough for the programme.
- Even if more than one programme are timer programmed in FR (JUST) mode, only the first one is recorded.
- In order to ensure that the recording fits on the disc, this feature may leave a slight non-recorded section at the end of the disc.
- There may be some noise and sound disturbance at the point on the disc where the unit switches the mode.

Receiving Stereo And Bilingual Programmes

Your unit is equipped with a Digital stereo sound decoder (NICAM) making reception of stereo and bilingual broadcasts possible. When the channel is changed, the type of broadcast being received will be displayed on the TV screen for a few seconds.

Type of Broadcast Being Received	On-Screen Display
Regular Monaural	
NICAM Stereo	
NICAM Bilingual	
NICAM Monaural	

NOTES:

- "SUPERIMPOSE" must be set to "AUTO". Otherwise the on-screen displays will not appear. (☞ pg. 73)
- If the quality of stereo sound being received is poor, the broadcast might be received in monaural with better quality.

Selection Of The Audio Channel To Be Recorded On A Disc

When a programme is recorded on a DVD-RAM or DVD-RW disc in VR mode, all audio channels of the receiving programme are recorded on the disc. When you record a programme on a DVD-R or DVD-RW disc in video mode, select the desired audio channel ("NICAM" or "MONO") to be recorded on the disc. (☞ pg. 72)

NOTE:

Before playing back a programme recorded in stereo, or a bilingual programme, refer to "Audio Channel Selection" (☞ pg. 28).

Basic Recording

- Turn on the unit.
- Turn on the TV and select the AV mode.
- Slide the TV/CABLE/SAT/DVD switch to DVD.

ATTENTION:

The HDD on the unit requires approximately 20 seconds to start up after the unit has been turned on, during which no operation can be made.

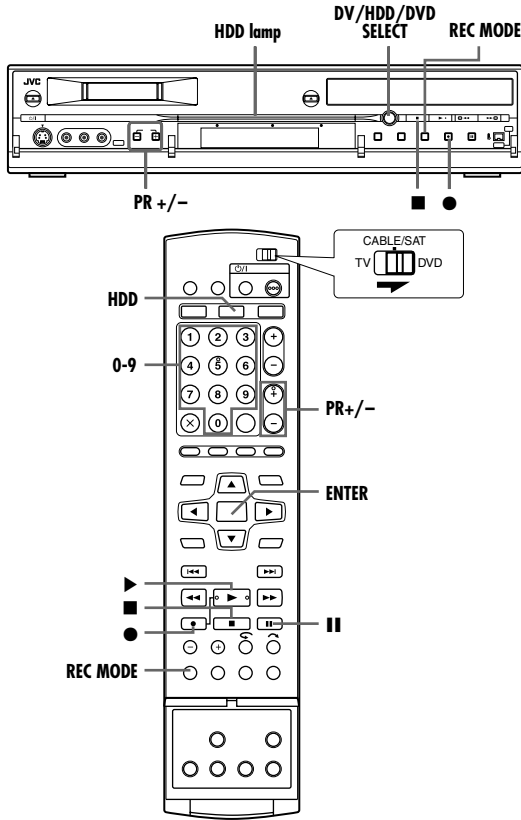

NOTES:

- Continuous recording for over 48 hours is not possible.
- It is not possible to record on both DVD and HDD simultaneously.
- It is not possible to record from this unit's built-in tuner to the DV deck.

Pause recording on HDD deck

It is not possible to pause recording. Pressing **||** initiates Live Memory Playback.

However, it is still possible to pause recording only when recording the channels of external sources ("L-1", "L-2", "F-1", and "DV"). While holding **●**, press **||** on the remote control. To resume recording, while holding **●**, press **▶** on the remote control. No operation can be made with the buttons on the unit.

Recording Mode

MPEG2 format is used as recording format. As a guide for picture quality, the "bps" unit is used to represent how much data can be recorded per second. The larger this value is, the better the picture quality becomes but more capacity is required for the recording. Select XP or SP for programmes where quick movement occurs, such as sports programmes, and LP or EP for talk shows, etc. with relatively less movement.

Recording mode	Maximum recording time (approx.)
XP	53 hours
SP	109 hours
LP	218 hours
EP	328 hours
FR480	473 hours

- For details on FR mode, refer to "Free Rate Function" (pg. 36).

NOTE:

The maximum recording time stated in the above table are the approximate time under unused condition.

- 1 Press **DV/HDD/DVD SELECT** on the unit repeatedly or **HDD** on the remote control so that the HDD lamp lights up on the unit.
- 2 Press **PR +/-** or the **number keys** to select the channel you wish to record.
- 3 Press **REC MODE** repeatedly to select the recording mode, then press **ENTER**.
 - Each time you press **REC MODE**, the recording mode changes as follows:
 XP → SP → LP → EP → FR (60-360*, 420, 480) → (Back to the beginning)
 * The value is selectable from 1 to 6 hours in 5-minute intervals by pressing **<|>** repeatedly after selecting "FR60-FR360". To change the value in 30-minute intervals, press and hold **<|>**.
 - For details on the recording mode, see the right column.
- 4 Press **●** on the unit to start recording. Or while holding **●**, press **▶** on the remote control.
 - The HDD recording lamp lights up on the unit.
- 5 Press **■** twice to stop recording.
 - Pressing **■** once displays the confirmation message to stop recording. Press **■** again to terminate recording.

Recording Features

- Turn on the unit.
- Turn on the TV and select the AV mode.
- Slide the **TV/CABLE/SAT/DVD** switch to **DVD**.
- Press **DV/HDD/DVD SELECT** on the unit repeatedly or **HDD** on the remote so that the HDD lamp lights up on the unit.

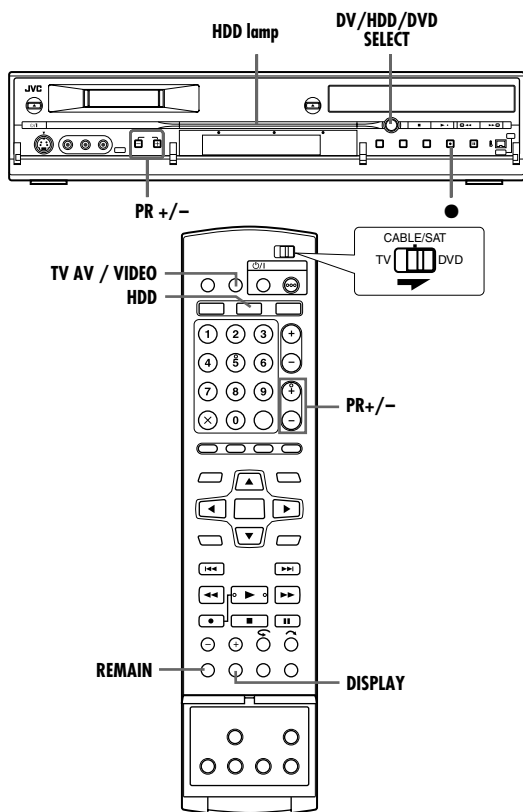

Watch Another Programme While Recording On The Unit

While recording is going on, you can watch another programme on the TV by using the TV's tuner.

NOTE:

It is required that the remote control is set to be able to operate the TV in advance. (pg. 68)

- 1 During recording, press **TV AV/VIDEO** to select TV mode.
 - Video mode is disengaged, and the VIDEO indicator on the front display panel lights off.

VIDEO indicator lights off.

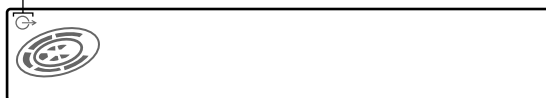

- The programme received on the TV's tuner is displayed on the TV screen.

- 2 Slide the **TV/CABLE/SAT/DVD** switch to **TV**.

- 3 Press **PR +/-** repeatedly to select the desired channel.

Elapsed Recording Time And Disc Remaining Time Indication

During recording, press **DISPLAY** repeatedly until the desired indication appears on the front display panel.

- Each time you press **DISPLAY**, the time indication changes as follows:
Elapsed recording time → Disc remaining time → Clock → (Back to the beginning)
- You can also check the disc remaining time by pressing **REMAIN** while the unit is stopped or recording is in progress. The list of disc remaining times for all recording modes appears on the TV screen.

Receiving Stereo And Bilingual Programmes

Your unit is equipped with a Digital stereo sound decoder (NICAM) making reception of stereo and bilingual broadcasts possible. When the channel is changed, the type of broadcast being received will be displayed on the TV screen for a few seconds.

Type of Broadcast Being Received	On-Screen Display
Regular Monaural	
NICAM Stereo	
NICAM Bilingual	
NICAM Monaural	

NOTES:

- "SUPERIMPOSE" must be set to "AUTO". Otherwise the on-screen displays will not appear. (pg. 73)
- If the quality of stereo sound being received is poor, the broadcast might be received in monaural with better quality.

Instant Timer Recording (ITR)

This easy method lets you record for 30 minutes to 6 hours (selectable in 30-minute intervals), and shuts the unit off after recording is finished.

- 1 Press ● on the unit to start recording.
- 2 Press ● again to engage the ITR mode.
 - On the front display panel, "0:30" appears.
- 3 If you want to record for more than 30 minutes, press ● to extend the time. Each press extends recording time by 30 minutes.

NOTES:

- You can only perform ITR using the ● button on the unit.
- ITR is not possible during timer recording.
- When the recording capacity becomes full during timer recording or Instant Timer Recording, the unit is automatically shut off.

Basic Playback

- Turn on the unit.
- Turn on the TV and select the AV mode.
- Slide the **TV/CABLE/SAT/DVD** switch to **DVD**.

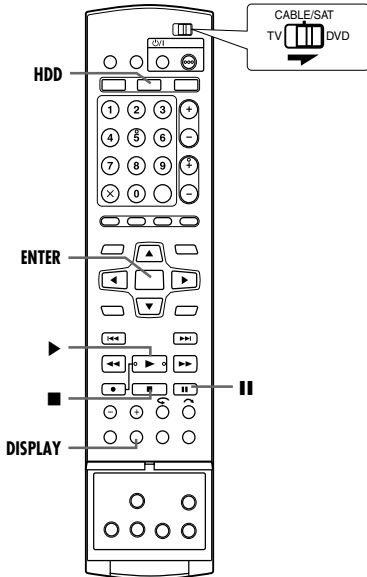
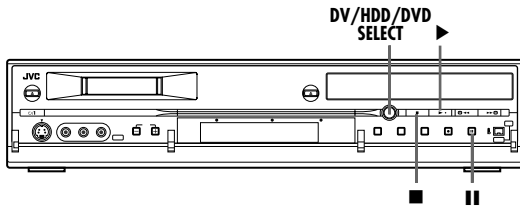

ATTENTION:

- It may take a few seconds to start playback. This is not a malfunction.
- Forward/reverse high-speed search and other operations cannot be performed while playback is stopped.

- 1 Press **DV/HDD/DVD SELECT** on the unit repeatedly or **HDD** on the remote so that the HDD lamp lights up on the unit.
- 2 Press **▶** to start playback.
 - The Library Database Navigation also enables you to search and select the desired programmes. (see pg. 52)
- 3 Press **||** to pause playback.
 - To resume normal playback, press **▶**.
- 4 Press **■** to stop playback.

NOTES:

- When the Library Database Navigation screen appears, choose a thumbnail image of the desired title on the TV screen, then press **ENTER**. (see pg. 52)
- During HDD playback, the current title elapsed time is displayed on the TV screen when **ON SCREEN** is pressed. However, each press of **DISPLAY** changes the time display on the front display panel as follows:
Current title elapsed time → Disc remaining time → Current title remaining time → (back to the beginning)
- It is possible to play back on the DV deck and the HDD/DVD deck simultaneously. However, either DVD or HDD can be played at the same time.

Playback Features

- Turn on the unit.
- Turn on the TV and select the AV mode.
- Slide the **TV/CABLE/SAT/DVD** switch to **DVD**.
- Press **HDD** so that the HDD lamp lights up on the unit.

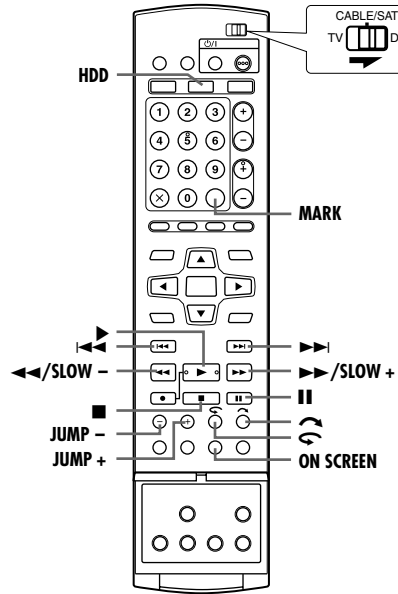

Variable Speed Search

- During playback, press **▶▶** for forward variable speed search, or **◀◀** for reverse variable speed search.
- Each press of the button increases the search speed for each direction.
 - To resume normal playback, press **▶**.

Reverse ◀◀				▶▶ Forward												
Reverse Search 4 steps	Reverse Play	Reverse Slow Motion 3 steps	Slow Motion 3 steps	Normal Play	Forward Search 5 steps											
-60	-15	-5	-3	-1	-1/2	-1/4	-1/6	1/6	1/4	1/2	1	1.5	3	5	15	60

NOTE:

You can hear the (normal) audio track only during 1.5x speed search.

Still Picture/Frame-By-Frame Playback

- 1 Press **||** to pause during playback.
- 2 Press **SLOW -** (**◀◀**) or **SLOW +** (**▶▶**) to activate frame-by-frame playback.
 - Each press of **SLOW -** (**◀◀**) or **SLOW +** (**▶▶**) advances/reverses the still picture frame by frame.
 - To resume normal playback, press **▶**.

Slow Motion

- 1 Press **||** to pause during playback.
- 2 Press **SLOW -** (**◀◀**) or **SLOW +** (**▶▶**) for 2 or more seconds.
 - Each press of **SLOW -** (**◀◀**) or **SLOW +** (**▶▶**) increases the slow motion speed for each direction.

Skip Search

During playback, press **↶**.

- Each press initiates an approximately 30-second period of fast-motion playback. Normal playback resumes automatically.

One Touch Replay

You can move back the playback position slightly.



Press .

- Each press skips back for approximately 7 seconds and resumes playback.
- Pressing while paused skips back for approximately 7 seconds and resumes pause.

1.5x Speed Playback

You can play back a title quickly. The sound will also be played back faster than normal speed during 1.5x speed playback.

1.5x speed playback cannot be performed during recording on HDD or DVD.

- 1 Press  to locate the point to start 1.5x speed playback from.
- 2 Press  to resume playback.
- 3 Press  once.
 - Pressing **ON SCREEN** displays "X1.5" on the top right corner of the screen.



NOTE:

When the unit is connected with a digital audio device using an optional optical cable, set "DIGITAL AUDIO OUT" to "PCM ONLY". (pg. 28)

Jump Search

You can locate a scene ahead or behind the current one by jumping scenes according to selected time intervals (pg. 73) during playback (or Live Memory Playback).

Press **JUMP -** or **JUMP +**.

- To advance forward or back, press **JUMP -** or **JUMP +** repeatedly within 5 seconds of each press to continue jump.
- Depending on the time from where you want to start jump search, the first press of **JUMP -** or **JUMP +** will not necessarily lead to a jump of the selected time interval. The first press will lead to a jump to the nearest quarter points of an hour (15 min/ 30 min/ 45 min/ 00 min). The subsequent jumps will then be in accordance to the selected time interval.
- When you cannot advance any further (beginning or end of programme reached), the message "UNABLE TO GO BACK ANY MORE" appears on the screen and the on-air screen resumes. In such a case, press ,  or .

Example:

Playback search when jump interval is set to 15 MIN jumps.

Taking for instance, you want to start jump search 40 minutes after the beginning of the programme. Pressing **JUMP -** or **JUMP +** will result in a jump to the scene at the 30 minutes point or 45 minutes point respectively as illustrated below. At the subsequent press, the scene will jump to the 15 minutes point or 1 hour point respectively, according to the selected time interval, which in this case is "15 MIN".

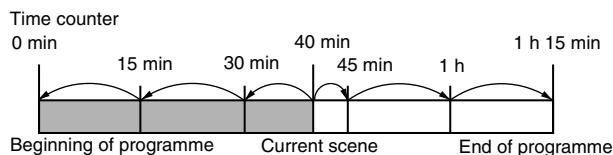



Marking Positions To Play Back Again Later

It is possible to mark positions (up to 999 points) where you want to play back once again later, and start playback from a marked position. Marking onto the disc when recording is helpful to locate a start point when you play back the disc later.



To mark positions:

During playback, press **MARK** at positions you want to mark.

- "MARK" appears on the TV screen.
You can easily locate the marked positions using  or  when you play back the disc.



To delete the marked positions:

While paused, press  or  to locate a marked position you want to delete, then press **MARK**.

- Crossed "MARK" appears on the TV screen, and the marked position is deleted.



NOTE:

When a monaural programme changes to a stereo programme while recording, a mark signal is automatically recorded.

Basic Playback

- Turn on the unit.
- Turn on the TV and select the AV mode.
- Slide the **TV/CABLE/SAT/DVD** switch to **DVD**.

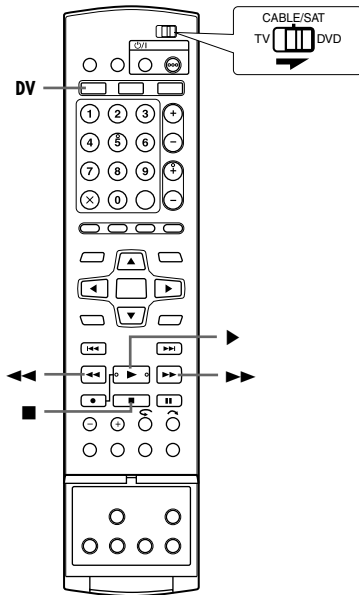
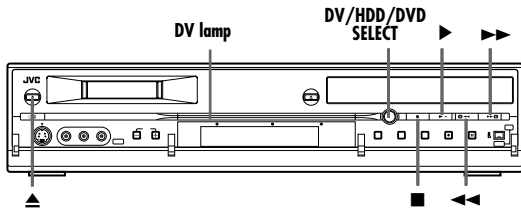

- 1 Load a cassette. Make sure the window side is up, the rear label side is facing you and the arrow on the front of the cassette is pointed toward the unit.
 - Do not apply too much pressure when inserting.
 - If the erase protection switch is set to "SAVE", playback begins automatically. It takes about 15 seconds until the playback picture appears. However, when "POWER SAVE" is set to "ON" (pg. 73), playback will not begin automatically even though a cassette with its erase protection switch set to "SAVE" is inserted.
 - The unit's power comes on automatically.
- 2 Press **DV/HDD/DVD SELECT** on the unit repeatedly or **DV** on the remote control so that the DV lamp lights up on the unit.
- 3 Find the programme start point. If the tape is advanced past the start point, press **◀**. To go forward, press **▶**.
- 4 Press **▶** to start playback.
- 5 Press **■** to stop playback.
 - To eject the cassette, press **▲** (DV).

Clean the video heads using a dry cleaning cassette - M-DV12CL - when:

- No picture during playback.
- Block noise appears during playback.
- "USE CLEANING CASSETTE" appears on the screen.

NOTE:

The heads get dirty in the following cases:

- in an environment prone to extreme temperature or humidity
- in a dusty environment
- flaw, dirt or mould on video tapes
- continuous usage for a long time

Usable cassettes

- Cassettes marked **Mini DV** can be used with the DV deck.

NOTES:

- This unit does not support playback of DV tapes with HD format recordings.
- When you record a tape on the DV deck with the recording speed set to "LP", it is recommended to play back that tape back on this DV deck. Digital video recorder from other manufacturers may not be able to play back the tape properly.
- It is possible to play back on the DV deck and the HDD/DVD deck simultaneously. However, either DVD or HDD can be played at the same time.

Accidental erasure prevention

To prevent accidental recording on a recorded cassette, set its erase protection switch to "SAVE". To record on it later, set the switch to "REC".

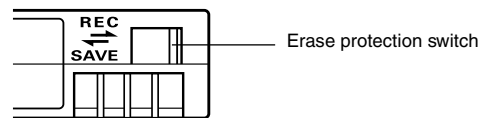

Playback Features

- Turn on the unit.
- Turn on the TV and select the AV mode.
- Slide the **TV/CABLE/SAT/DVD** switch to **DVD**.
- Press **DV/HDD/DVD SELECT** on the unit repeatedly or **DV** on the remote so that the DV lamp lights up on the unit.

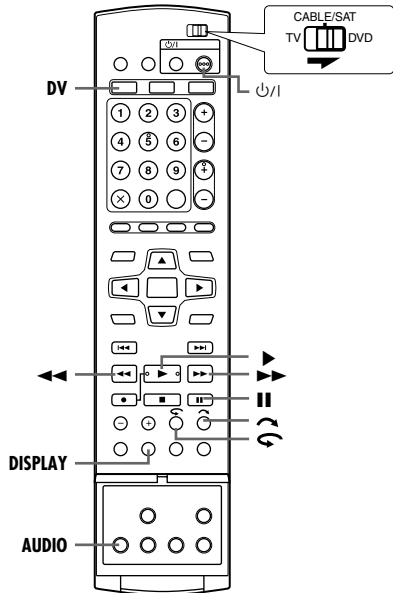

ATTENTION:

In the search, still, slow-motion or frame-by-frame playback mode, a slight mosaic effect appears on screen.

Variable Speed Search

During playback, press **▶▶** for forward variable speed search, or **◀◀** for reverse variable speed search.

- Each press of the button increases the search speed for each direction.
- To resume normal playback, press **▶**.

Reverse ◀◀			▶▶ Forward					
Reverse Search 3 steps			Reverse Slow Motion 1 step	Slow Motion 1 step	Forward Search 3 steps			
-12	-4	-2	-1/5	1/5	1	2	4	12

Still Picture/Frame-By-Frame Playback

- 1 Press **||** to pause during playback.
- 2 Press **||** to activate frame-by-frame playback.
 - To resume normal playback, press **▶**.

Slow Motion

- 1 Press **||** to pause during playback.
- 2 Press and hold **||** for 2 seconds, then release. Press **||** and release again to return to still picture.
 - Press **▶▶** for forward slow motion or **◀◀** for reverse slow motion.
 - To resume normal playback, press **▶**.

Skip Search

During playback, press **↶**.

- Each press initiates an approximately 30-second period of fast-motion playback. Normal playback resumes automatically.

One Touch Replay

During playback, press **↷**. The unit rewinds the picture a little (about 7 seconds) and resumes playback.

Next Function Memory

The Next Function Memory "tells" the unit what to do after rewinding. Before continuing, make sure the unit is in the Stop mode.

For Automatic Start Of Playback

Press **◀◀**, then press **▶** within 2 seconds.

Soundtrack Selection

Your unit is capable of recording two soundtracks (L and R) and will play back the one you select.

During Playback

Pressing **AUDIO** changes the soundtrack as follows:

TRACK	USE
On-Screen Display	
L ▶▶ R	For stereo or Bilingual tapes
L ▶▶	For main audio of Bilingual tapes
◀▶ R	For sub audio of Bilingual tapes

To select the audio mode (**SOUND1/SOUND2/MIX**), refer to "AUDIO MODE" under "DV SET UP" (pg. 72).

NOTE:

For instructions on recording stereo and bilingual programmes, refer to page 36.

Time Code

During recording, a time code is recorded on the tape. This time code is used to confirm the position on the tape when playing back or editing a tape.

1 Press **DISPLAY** until the time code on the tape appears on the front display panel and the TV screen.

- Each time you press **DISPLAY**, the indication changes as follows:

Clock time → Time code → Tape remaining time → (Back to the beginning)

Live Memory Playback



- Turn on the unit.
- Turn on the TV and select the AV mode.
- Slide the **TV/CABLE/SAT/DVD** switch to **DVD**.
- Press **DV/HDD/DVD SELECT** on the unit repeatedly to select the HDD or DVD deck.

This unit records pictures onto the hard disk and DVD-RAM disc, instead of video tapes, then plays back the pictures recorded on the disc. This makes it possible to achieve high-speed writing and read-out that has not been possible with conventional VCRs, enabling recording and playback simultaneously.

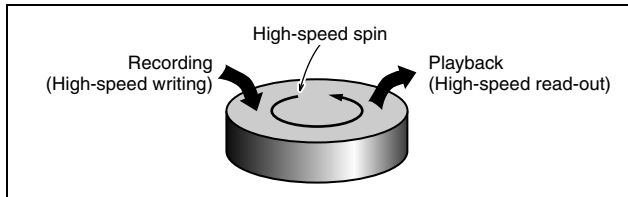

It is called "Live Memory Playback" to start playback of the programme being recorded, with a time-lag between a recording point and a playback point, as shown in the figure below.

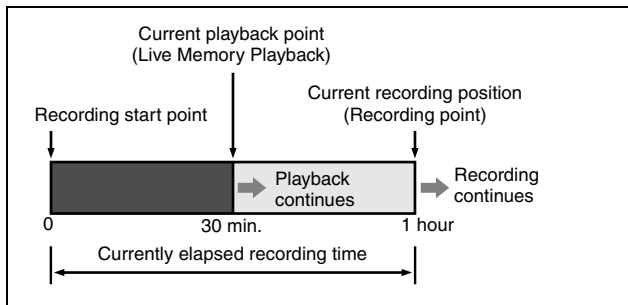

Not only can this unit play back a programme previously recorded while recording or timer recording another programme, but the unit also allows you to play back from the beginning of a programme while continuing to record the same programme.

Recording/playback Status Display

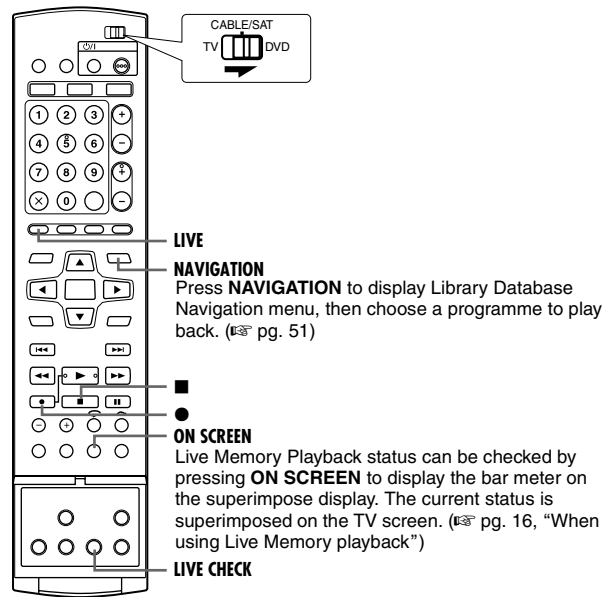

NOTES:

- Live Memory Playback could be performed approximately 30 seconds after recording has started on the DVD-RAM disc. However, for HDD, Live Memory Playback is possible right after recording has started.
- Although high-speed search up to approximately 30 seconds before the current recording point is possible during Live Memory Playback, once the current recording point is reached, the unit resumes normal playback and maintains a delay of approximately 30 seconds so that recording and playback can continue.
- When using Live Memory Playback during timer recording, playback continues even after the end of the recording.
- When using Live Memory Playback during timer recording on the DVD-RAM disc, the next timer recording will be recorded to the HDD deck even though recording on the DVD deck has stopped. (pg. 48, "Relief Recording")
- It is impossible to perform ITR even if you press ● on the unit during Live Memory Playback while in normal recording or RetroActive Recording. (pg. 38)
Press ■ to display the programme being recorded, then perform ITR settings.
- It is possible to perform ITR during Live Memory Playback while in temporary recording for Live Memory (HDD deck only). Press ● to stop Live Memory Playback and activate normal recording, then perform ITR settings.
- It is impossible to perform ITR during Live Memory Playback while in timer recording.
- Playback may be paused for a moment during Live Memory Playback, which does not interfere with recording.
- Live Memory Playback cannot be performed while recording the source from DV input. (pg. 61, "DV Dubbing (HDD & DVD Deck Only)")
- When **LIVE CHECK** is pressed to display the picture currently being recorded, the picture size may not be correct.
- Press ■ or **LIVE** to stop Live Memory Playback.
- Live Memory Playback cannot be performed while the DVD deck is recording as temporary recording on HDD stops during recording on DVD.

Buttons To Be Used During Live Memory Playback

- Turn on the unit.
- Turn on the TV and select the AV mode.
- Slide the **TV/CABLE/SAT/DVD** switch to **DVD**.
- Press **HDD** or **DVD** to select the desired deck for Live Memory Playback.

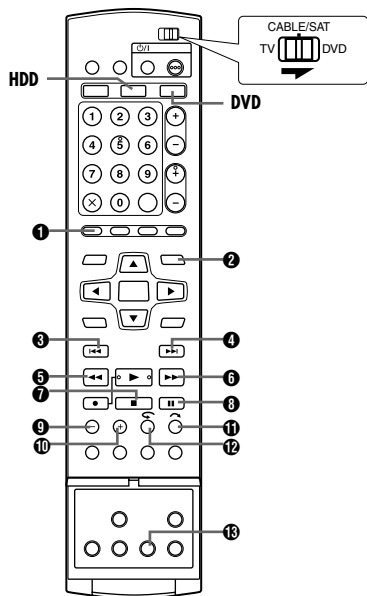

1 LIVE

Returns to on air programme screen. When a confirmation message appears by pressing this button during timer programming or title editing, etc., follow the instruction to return to the previous screen.

2 NAVIGATION

Displays Library Database Navigation menu. You can choose a title to play back.

3 ◀◀

- Pressing once skips back to the beginning of the chapter being played back.
- Pressing down for 2 or more seconds during playback reverses playback at 5 times the normal speed while pressed. Releasing the button resumes normal playback.

Available only when paused

- Pressing down for 2 or more seconds reverses playback at 1/16 times the normal speed.

4 ▶▶

- Pressing once skips forward to the beginning of the next chapter being played back.
- Pressing down for 2 or more seconds during playback advances playback at 5 times the normal speed while pressed. Releasing the button resumes normal playback.

Available only when paused

- Pressing down for 2 or more seconds advances playback at 1/16 times the normal speed.

5 ◀◀

- Each press of the button during playback advances the playback speed in 5 steps in the reverse direction.

Available only when paused

- Each press of the button reverses the still picture frame by frame.
- Pressing down for 2 or more seconds reverses playback at 1/16 times the normal speed. Then, each press of the button reverses slow-motion at 1/16 times, 1/4 times and 1/2 times the normal playback.

6 ▶▶▶

- Each press of the button during playback advances the playback speed in 4 steps in the forward direction.

Available only when paused

- Each press of the button advances the still picture frame by frame.
- Pressing down for 2 or more seconds advances playback at 1/16 times the normal speed. Then, each press of the button advances slow-motion at 1/16 times, 1/4 times and 1/2 times the normal playback.

7 ■

- Pressing once during Live Memory Playback or RetroActive Recording returns to the screen on air.
- Pressing twice during recording stops recording and returns to the screen on air.

8 ||

- Pressing once pauses playback (still picture playback).
- Pressing repeatedly advances the still picture frame by frame.

9 JUMP -

Each press of the button during Live Memory Playback jumps back for the selected time interval and resumes playback. (pg. 40, "Jump Search")

10 JUMP +

Each press of the button during Live Memory Playback jumps forward for the selected time interval and resumes playback. (pg. 40, "Jump Search")

11 ↶

It is useful when skipping over unwanted sections.

- Pressing once skips forward for approximately 30 seconds and resumes playback.
- Pressing repeatedly skips forward continuously as many times as pressed.

12 ↷

It is useful when watching sports programmes, etc.

- Each press skips back for approximately 7 seconds and resumes playback.
- Pressing repeatedly skips back for approximately 7 seconds continuously as many times as pressed.

13 LIVE CHECK

You can check, for example, if the programme you are recording has already finished.

- Pressing once displays the picture currently being recorded and the one being played back simultaneously.
- Pressing successively clears the Live Check window and displays only the picture currently being played back.

Temporary recording for Live Memory (HDD deck only)

This unit automatically records the channel being received, within the specified range of time, to the reserved space on the hard disk. The time range can be set for 30 minutes, 1 hour, and 3 hours. (pg. 72)

NOTE:

Previous temporary recordings will be overwritten since the unit is always recording the channel being received. Thus, it is not possible to play back TV programmes recorded beyond the specified range of time since they are already overwritten. To avoid this in order to save titles, perform normal recording (pg. 37), timer recording (pg. 46, 48), or RetroActive Recording (See below).

About limitation on temporary recording

The temporary recording for Live Memory is cancelled in the following cases, and will start all over again when it is to resume.

- When the power is turned off
- When the system is powered again after a power failure was occurred
- When normal recording, timer recording, RetroActive Recording, or Automatic Satellite Programme Recording (pg. 50) is performed
- When the "LIVE MEMORY" setting is changed (pg. 72)
- When tuner channel setting is performed (pg. 74)
- When dubbing is performed by pressing **DUBBING** (pg. 58)
- When "DV" is selected by pressing **PR +/-** (pg. 61)

RetroActive Recording (HDD deck only)

You can start recording from the previous part of the channel you are currently watching (temporarily recorded on the background). (See "Temporary recording for Live Memory (HDD deck only)" above.)

- 1** Press **◀◀** or **◀◀** to locate the point to start recording from.
 - Each press of **◀◀** increases the reverse search speed.
- 2** Press **●** on the unit to start RetroActive Recording. Or while holding **●**, press **▶** on the remote control.
- 3** Press **■** twice to stop RetroActive Recording.
 - The on-air screen resumes.

NOTES:

- You cannot use RetroActive Recording for channels other than the channel you are currently watching.
- Recording speed is automatically set to FR65 mode when RetroActive Recording is started.
- Temporarily recorded data prior to the beginning of RetroActive Recording is erased when RetroActive Recording started.

Simultaneous Recording and Playback

You can play back the previous part of the channel you are recording or other programmes available in the Library Database.

- 1** Press **NAVIGATION**. The Library Database Navigation screen appears.
- 2** Press **selection keys** to select "ORIGINAL", then press **ENTER**.
- 3** Press **selection keys** to select the desired title, then press **ENTER**.
 - For DVD-RAM, playback starts from the beginning of the title if "CONTINUOUS PLAY" in "DVD SET UP" is set to "ON" (pg. 72).
- 4** Press **selection keys** to select the desired playback method ("BEGINNING", "RESUME" or "REPEAT"), then press **ENTER**.
 - Playback of the selected title begins automatically.
- 5** Press **■** to stop playback.
 - The on-air screen resumes.

NOTES:

- You can use various playback features during Live Memory Playback.
- To stop simultaneous playback, press **■**. The on-air screen resumes. To stop actual recording, press **■** twice again.

One Touch Replay

You can move back the playback position slightly during recording or Live Memory Playback.

Press **↶**.

■ DVD-RAM

- Pressing once during recording skips back for approximately 30 seconds and starts Live Memory Playback. While pressing once during Live Memory Playback skips back for approximately 7 seconds and resumes playback.
- Each subsequent press skips back for approximately 7 seconds and resumes playback.
- Pressing while paused skips back for approximately 7 seconds and resumes pause.

■ HDD

- Pressing during recording skips back for approximately 7 seconds and starts Live Memory Playback. While pressing during Live Memory Playback skips back for approximately 7 seconds and resumes playback.
- Each press skips back for approximately 7 seconds and resumes playback.
- Pressing while paused skips back for approximately 7 seconds and resumes pause.

Resuming Playback (HDD deck only)

You can resume playback of a TV broadcast you were recording or watching from the point you have paused.

- 1** Press **||** to pause a TV broadcast.
 - Recording continues when recording.
- 2** Press **▶** to start Live Memory Playback.
 - Playback resumes from the paused position.
- 3** Press **■** to resume the on-air screen.

VIDEO Plus+ Timer Programming

You can programme this unit to timer record as many as 16 programmes.

With the VIDEO Plus+ system, timer programming is greatly simplified because each TV programme has a corresponding code number which your unit is able to recognise.

You can use the remote control to enter the PlusCode number.

- Make sure that the unit's built-in clock is set properly.
- Turn on the unit.
- Turn on the TV and select the AV mode.
- Slide the **TV/CABLE/SAT/DVD** switch to **DVD**.

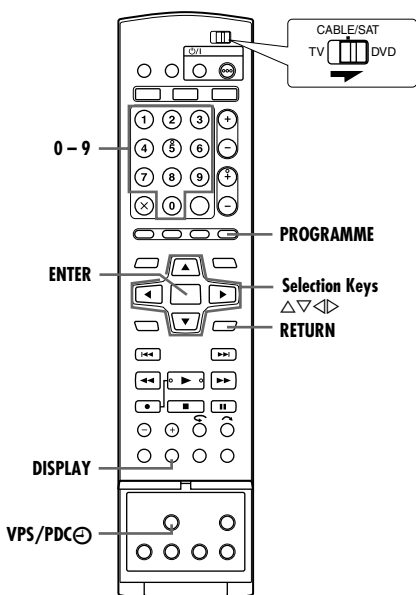

- 1 Load a recordable disc if recording to DVD.
- 2 Press **PROGRAMME** to access the programme top screen.
- 3 Press **selection keys** to select "VIDEO PLUS+", then press **ENTER**.
 - When "PROGRAMME FULL DELETE UNWANTED TIMER PROGRAMMES" appears on the TV screen, you need to cancel some of the reserved programmes. (pg. 49)

- 4 Press the **number keys** to enter the PlusCode number of a programme you wish to record.

OR

Press **selection keys** to select the desired number key on the screen, then press **ENTER**. Repeat to enter all required numbers.

- If you have made a mistake, press **selection keys** to select "DELETE" or "DELETE ALL", then press **ENTER** and input the correct number before you press **ENTER** again.

- 5 Press **selection keys** to select "RECORD TO", then press **ENTER**. Press **selection keys** to select the desired recording deck, then press **ENTER**.

- 6 Press **selection keys** to select "CONFIRM", then press **ENTER**.

- If the number you entered is invalid, "PLUSCODE NO. ERROR CONFIRM PLUSCODE NO. THEN RETRY" appears on the TV screen. Input a valid PlusCode number.
- If "GUIDE PROGRAMME IS NOT SET SET GUIDE PROGRAMME THEN RETRY" appears on the TV screen, set Guide Programme Numbers manually. (pg. 74)

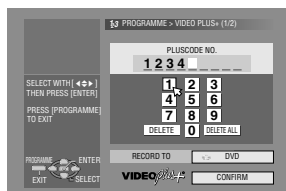

- 7 The PlusCode number you entered and the matching timer recording information are displayed on the TV screen. Check the programme data.

- To cancel this setting, press **RETURN**.

IMPORTANT:

Make sure the channel position number you wish to record is displayed; if not, see "VIDEO Plus+ System Setup" (pg. 74) and set the Guide Programme number correctly.

- 8 Press **selection keys** to select the desired recording option as required. Press **selection keys** to select the desired setting, then press **ENTER**.

- "INPUT TITLE" (pg. 52, "Modify Title Name")
- "CATEGORY" (pg. 53, "Modify Category")
- "VPS/PDC" (pg. 47, "VPS/PDC Recording")
- "WEEKLY/DAILY" (pg. 47, "Weekly/Daily Recording")
- "REC MODE" (pg. 34, "Recording Mode")

- 9 Press **selection keys** to select "OK", then press **ENTER** to access the Programme Confirmation screen.

- 10 Press **selection keys** to select "EXIT", then press **ENTER** to complete timer programming.

- To programme another timer, press **selection keys** to select "CONTINUE", then press **ENTER**.
- If "PROGRAMME OVERLAPPED" appears on the TV screen, delete or modify the programmes.

NOTES:

- There may be cases that the VIDEO Plus+ Timer Programming function prolongs the stop time of the programming.
- When two successive programmes are recorded on a DVD-RW disc with the VIDEO Plus+ Timer Programming function, the beginning of the second one may be left off the recording.
- If the copy limited programme is received during timer recording, the unit enters Record Pause mode. Recording starts again if it is switched to a recordable broadcast during the time you programmed.

IMPORTANT:

If you have moved to a different area or if a broadcasting station's channel number has been changed, the wrong channel number will be displayed on the VIDEO Plus+ programme screen in step 7. When this happens, set the correct Guide Programme number for that station. (pg. 74, "VIDEO Plus+ System Setup")

Weekly/Daily Recording

You can record programmes with one of the following weekly/daily timer settings.

For the HDD deck

When you select a mode other than ONCE, the space on the hard disk drive is saved for new recordings by overwriting previous recordings. To prevent loss of a needed recording, backup programmes you wish to save by dubbing them to DVD discs before overwriting previous recordings. Or save the title of weekly/daily programmes to avoid overwriting of a previous week/day. (pg. 49)

ONCE (One Time Recording)

In this mode a programme will not be automatically overwritten.

WEEKLY (OVERWRITE) (Weekly Recording/Weekly Overwrite)

When the set weekly programme is broadcast, the programme recorded last week is automatically deleted and overwritten by the new programme. Save the title of each programme you wish to save, then the recorded programme is saved and will not be overwritten by the new programme.

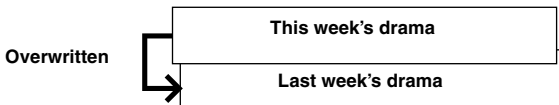

MON-SUN (FOR A WEEK)/ MON-SAT (FOR A WEEK)/ MON-FRI (FOR A WEEK) (Daily Recording/Weekly Overwrite)

When the set weekly programme is broadcast, the programme recorded on the same day last week is automatically deleted and overwritten by the new programme. Save the title of each programme you wish to save, then the recorded programme is saved and will not be overwritten by the new programme.

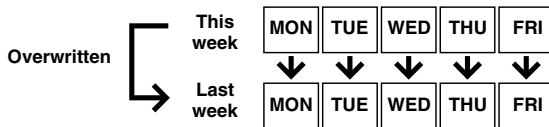

MON-SUN (OVERWRITE)/ MON-SAT (OVERWRITE)/ MON-FRI (OVERWRITE) (Daily Recording/Daily Overwrite)

When the set daily programme is broadcast, yesterday's programme is automatically deleted and overwritten by the new programme. Save the title of each programme you wish to save, then the recorded programme is saved and will not be overwritten by the new programme.

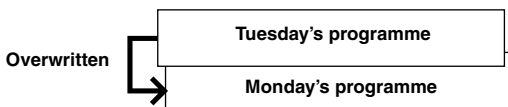

For the DVD deck

ONCE (One Time Recording)

WEEKLY (Weekly Recording)

MON-SUN/ MON-SAT/ MON-FRI (Daily Recording)

VPS/PDC Recording

Now available from some TV stations, PDC (Programme Delivery Control) and VPS (Video Programme System) are services designed to assure safe, accurate timer recording. With this system, special code signals are transmitted together with the audio/video signals. These code signals control your video unit and have precedence over the advertised times you may have preset into the timer. This means that your unit will start and stop recording when the preset TV programmes actually start and end—even if the broadcast time of a preset TV programme is changed from what has been advertised. PDC is currently available nationally on BBC1, BBC2, Ch.4 and Ch.5, except from a few small relay transmitters. Ch.3 operates a PDC service in some areas. All channels intend to offer this service in due course. Check your TV programme listing guide for latest information. If the channel you intend to record does not offer a PDC service your unit will not start recording if PDC has been selected. Be sure to set PDC to "OFF" if PDC is not available on your selected channel. (See step 8 on page 46.)

NOTES:

- Make sure to press **VPS/PDC** after completing timer programming procedure to activate the VPS/PDC recording function. The VPS/PDC recording indicator lights up on the front display panel when VPS/PDC recording function is activated. However, it will blink rapidly when **VPS/PDC** is pressed under the following conditions:
 - Clock is not set.
 - Timer programming has not been set.
 - Disc is not loaded.
 - HDD is full.
- When you use Manual Timer Programming, set the start time (VPS or PDC time) exactly as advertised in the TV listing. A different time than advertised will result in no recording.
- VPS/PDC recording is also possible when a satellite receiver or a cable system is connected to [L-2 IN/DECODER] connector on your unit.
- VPS/PDC recording is also possible via the [L-1 IN/OUT] connector.
- When timer recording via VPS/PDC recording is in progress, it is not possible to switch between the HDD and DVD deck, and the following menus cannot be displayed:
 - Main Menu
 - Library Database Navigation Menu
 - Editing Menu
- If the unit is powered on when set to record a timer programme onto HDD/DVD using VPS/PDC, the PDC information will not be used. The programme will be recorded using the start and stop times originally programmed.

How to check if the station being received transmits a VPS/PDC signal

- 1 Hold down **DISPLAY** for about 5 seconds. "VPS/PDC" appears and blinks on the front display panel. If a VPS/PDC signal is detected from the station, "VPS/PDC" will stop blinking. If no VPS/PDC signal is detected from the station, "VPS/PDC" will blink at a slower rate.
- 2 Press **DISPLAY** again to return to normal display.

Manual Timer Programming

You can programme this unit to timer record as many as 16 programmes.

If you do not know the PlusCode number for the programme you wish to record, use the following procedure to set your unit to timer record the programme.

- Make sure that the unit's built-in clock is set properly.
- Turn on the unit.
- Turn on the TV and select the AV mode.
- Slide the **TV/CABLE/SAT/DVD** switch to **DVD**.

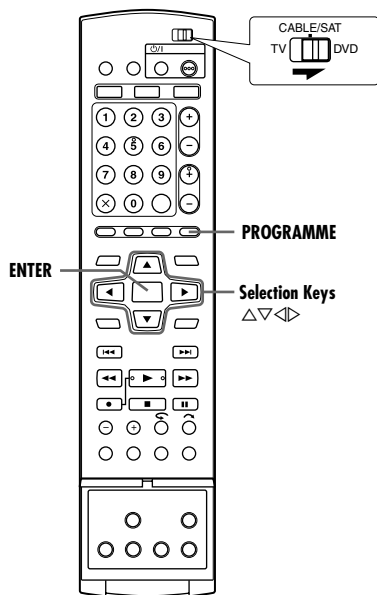

- 1 Load a recordable disc if recording to DVD.
- 2 Press **PROGRAMME** to access the programme top screen.
- 3 Press **selection keys** to select "CALENDAR PR.", then press **ENTER**.
 - When "PROGRAMME FULL DELETE UNWANTED TIMER PROGRAMMES" appears on the TV screen, you need to cancel some of the reserved programmes. (pg. 49)
- 4 Press **selection keys** to select the desired date, then press **ENTER**.
- 5 Press **selection keys** to select "RECORD TO", then press **ENTER**. Press **selection keys** to select the desired recording deck, then press **ENTER**.
- 6 Press **selection keys** to select "START", then press **ENTER**. Press **selection keys** to set the desired start time, then press **ENTER**.
 - Each press of $\Delta \nabla$ increases/decreases the start time in 1-minute intervals.
 - To increase/decrease the start time in 30-minute intervals, press and hold $\Delta \nabla$.
- 7 Press **selection keys** to select "STOP", then press **ENTER**. Press **selection keys** to set the desired stop time, then press **ENTER**.
 - Each press of $\Delta \nabla$ increases/decreases the stop time in 1-minute intervals.
 - To increase/decrease the stop time in 30-minute intervals, press and hold $\Delta \nabla$.



- 8 Press **selection keys** to select "TV PROG", then press **ENTER**. Press **selection keys** to select the desired channel.
- 9 Press **selection keys** to select "CONFIRM", then press **ENTER**.
- 10 Set the other recording options as required.
 - Refer to step 8 in "VIDEO Plus+ Timer Programming" (pg. 46).
- 11 Press **selection keys** to select "OK", then press **ENTER** to access the Programme Confirmation screen.
- 12 Press **selection keys** to select "EXIT", then press **ENTER** to complete timer programming.
 - To programme another timer, press **selection keys** to select "CONTINUE", then press **ENTER**.
 - If "PROGRAMME OVERLAPPED" appears on the TV screen, delete or modify the programmes.



NOTES:

- When two successive programmes are recorded on a DVD-RW disc with Manual Timer Programming function, the beginning of the second one may be left off the recording.
- If the copy limited programme is received during timer recording, the unit enters Record Pause mode. Recording starts again if it is switched to a recordable broadcast during the time you programmed.

Satellite Receiver Users

To timer record a satellite broadcast using Manual Timer Programming:

- 1 Perform "Manual Timer Programming" on this page. In step 8, set "TV PROG" to "L-2".
- 2 Set the satellite receiver to the appropriate channel before the selected programme begins.
- 3 Leave the satellite receiver's power on.

Relief Recording

When a programme that is set for the DVD deck cannot be recorded properly, the programme is recorded to the HDD deck instead in the recording mode as set.

- If the remaining capacity of the hard disk is not sufficient, the programme is recorded to the DVD deck until the remaining capacity of the DVD disc lasts.
- If "JUST" is selected for the recording mode, the current recording mode for the DVD deck is applied.

Automatic Satellite Programme Recording (HDD Deck Only)

This function allows you to automatically record a satellite programme which is timer programmed on your external satellite receiver. Connect a satellite receiver to the unit's [L-2 IN/DECODER] connector and programme the timer on the satellite receiver. The unit starts or stops recording by the signals input from the satellite receiver. After recording, the unit's power shuts off automatically.

ATTENTION:

- When you record programmes by connecting to a digital terrestrial receiver (Freeview receiver or similar), perform the same steps as "Automatic Satellite Programme Recording (HDD Deck Only)" on this page. It is not possible to operate the digital terrestrial receiver (Freeview receiver or similar) by using the provided satellite controller.
- Be sure not to turn on the satellite receiver before the programme is executed; otherwise, the unit will start recording when the satellite receiver's power is turned on.
- If you have connected another appliance other than a satellite receiver to the [L-2 IN/DECODER] connector, be sure not to engage the Automatic Satellite Programme Recording mode; otherwise, the unit will start recording when the connected appliance's power is turned on.
- Automatic Satellite Programme Recording and timer recording cannot be done at the same time.

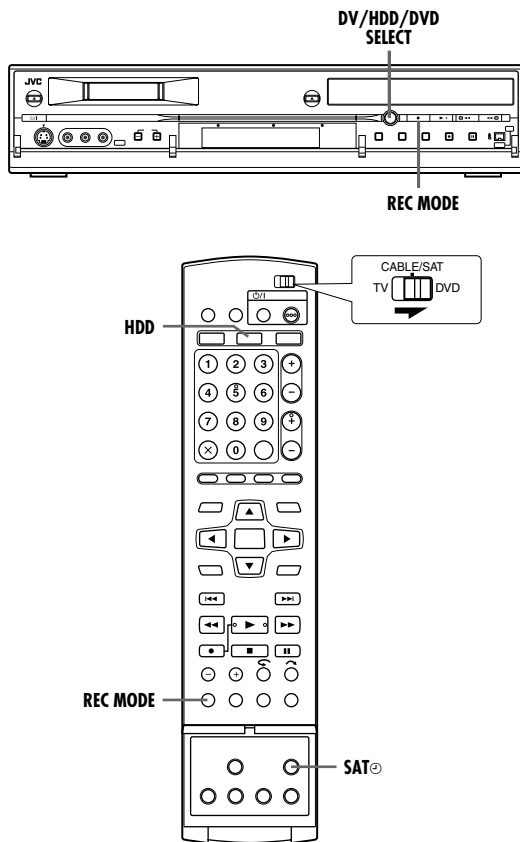

- Make sure the satellite receiver is connected to the unit's [L-2 IN/DECODER] connector.
- Programme the timer on the satellite receiver.
- Slide the TV/CABLE/SAT/DVD switch to DVD.

- 1 Press **HDD** on the remote control to choose the recording deck. You can also press **DV/HDD/DVD SELECT** on the unit repeatedly to select the recording deck.
- 2 Set "L-2 SELECT" to "SAT VIDEO" or "SAT S-VIDEO". (pg. 64)
 - Also refer to "IMPORTANT" on page 70.
- 3 Press **REC MODE** repeatedly to set the recording mode.
- 4 Press and hold **SAT** for about 2 seconds to engage the Automatic Satellite Programme Recording mode. "SAT" and "SAT" appear on the front display panel.

NOTES:

- To disengage the Automatic Satellite Programme Recording mode, press **SAT**.
- If the unit's power is off, it is not possible to engage the Automatic Satellite Programme Recording mode.
- In step 4, if "SAT" blinks quickly on the front display panel even though your satellite receiver's power is off, Automatic Satellite Programme Recording will not work properly with that satellite receiver*. If this is the case, perform "Manual Timer Programming" (pg. 48) to timer record a satellite programme.

* Some satellite receivers output signals even if the power is off. Automatic Satellite Programme Recording is not possible with those satellite receivers.
- "SAT" blinks on the front display panel while Automatic Satellite Programme Recording is in progress.
- For timer programming of the satellite receiver, refer to the instruction manual of the satellite receiver.
- Automatic Satellite Programme Recording is not possible if your satellite receiver does not have a timer.
- If there are more than one satellite programmes you wish to record with Automatic Satellite Programme Recording, it is not possible to set different recording modes for each programme.
- Depending on the type of satellite receiver, the unit may not record a slight portion of the beginning of the programme or may record slightly longer than the actual length of the programme.
- If you engage the Automatic Satellite Programme Recording mode when the satellite receiver's power is on, the unit will not start Automatic Satellite Programme Recording even though "SAT" blinks on the front display panel. When the satellite receiver shuts off once and is turned back on again, the unit starts recording.
- You can also record a programme from your cable system in the same way if the system has a timer.
- Just Clock (pg. 77) does not work when the Automatic Satellite Programme Recording mode is engaged.

Library Database Navigation



The Library Database Navigation enables you to search and select the desired titles recorded on the HDD deck and the DVD deck very easily.

You can record up to 99 titles on a disc.

Each time a title is recorded, the information of the title is registered for the Library Database Navigation automatically.

So, you can confirm the information of the titles recorded with the Library Database Navigation screen. And, you can also select one of the titles recorded using the Library Database Navigation.

The following screen appears as the Library Database Navigation screen when you press **NAVIGATION**. You can move the arrow to select the desired position on the screen by pressing **selection keys** on the remote control.

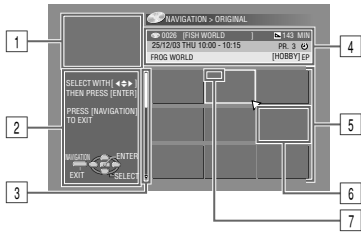

- 1 Playback screen
(Indicates currently received TV programme.)
- 2 Guidance for operations
- 3 Scroll bar
(Appears when there are over nine registered titles (or play lists). The scroll bar only indicates that there are more titles (or play lists) hidden off the current screen display. To show hidden titles (or play lists), press **selection keys** repeatedly.)
- 4 Recording information for the title indicated by the arrow
- 5 Index list
(Thumbnail still of each title)
Thumbnail still is not to be played back.
- 6 Index
 - ⚔: Indicates no index is registered.
 - 🕒: Indicates title in standby for timer recording.
 - 📁: Indicates no title is registered.
- 7 Icons
(Indicate the record condition of each title.)

Using Library Database Navigation system, you can easily modify registered information, edit the title or play list, as well as search for the beginning of each title.

About registration of information

The following information is automatically registered for each title when ordinary recording or timer recording is performed, then stored in an area specified on the unit.

- index* (reduced pictures to show programme titles)
- programme title*
- category*
- date and time
- channel
- recording mode
- length of recording time

The items marked with an asterisk (*) can be easily modified and registered again after recording by using Library Database Navigation system.

The limitations of registration

You can register information up to 99 titles for the DVD deck and 200 titles for the HDD deck.

When the amount of information is at the limits of registration, you cannot record new titles any more. In this case, you need to delete old titles to register new ones. (pg. 53)

NOTES:

- Once a DVD-R/RW (Video mode) disc has been finalised, the display for original does not appear. Only display for library appears.
- When a copy-once title recorded on the HDD is dubbed to a DVD disc (DVD-RAM/-RW (VR mode)), the original data will be moved from the HDD to the DVD disc. In additional, the title that was moved to the DVD disc will become a copy-protected title, and the icon changes from 🔄 to 🔒.
- Sound of received channel may be interrupted while the Library Database Navigation screen is displayed.
- The order of index which are displayed by pressing **DUBBING** differs from the images displayed by pressing **NAVIGATION** or **EDIT**.
- You cannot perform timer recording during editing of thumbnail images or play lists by pressing **EDIT**. Press **EDIT** to clear the Editing screen before performing timer recording.

The Icons and their meanings

	This title is write-protected.
	This title was recorded with timer recording.
	This title is Weekly Recording/Weekly Overwrite.
	This title is Daily Recording/Daily Overwrite.
	This title is Daily Recording/Weekly Overwrite.
	This title has not been played back.
	This title is copy-protected.
	This title can only be recorded once (copy-once title).

Scan For Beginning Of Title

- Turn on the TV and select the AV mode.
- Slide the **TV/CABLE/SAT/DVD** switch to **DVD**.
- Press **HDD** or **DVD** to choose the corresponding deck.
- Load a DVD disc to scan.

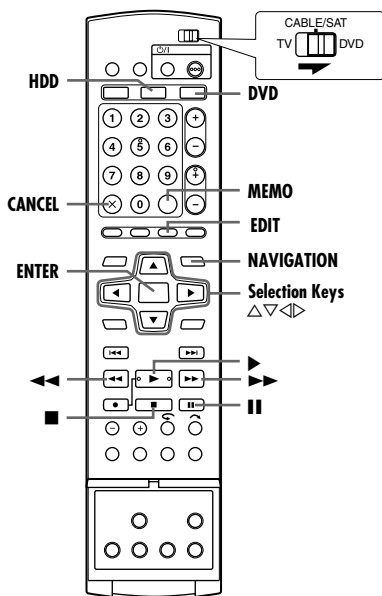

You can scan the beginning of the title easily with the Library Database Navigation.

- 1 Press **NAVIGATION**. The Library Database Navigation screen appears.
- 2 Press **selection keys** to select "ORIGINAL", then press **ENTER**.
- 3 Press **selection keys** to select the index (small pictures) of the desired title, then press **ENTER**.
 - When you want the plural titles to be played back continuously, press **MEMO** after selecting the desired title. The numbers of the playback order appear on the index. You can select up to 8 titles.
 - When you want to correct the order, move the arrow to the desired index and press **MEMO**. The number disappears and the unit re-numbers the other programmes automatically.
 - When you want to cancel the order, press **CANCEL(X)**.
- 4 Press **selection keys** to select "BEGINNING", then press **ENTER**.
 - To resume playback from the point where playback was previously stopped, press **selection keys** to select "RESUME", then press **ENTER**.
 - To repeat playback of a selected title, press **selection keys** to select "REPEAT", then press **ENTER**.
- 5 Press **II** to pause playback.
- To resume normal playback, press **▶**.
- 6 Press **■** to stop playback.

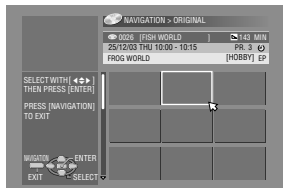

Edit Original Information



- Turn on the TV and select the AV mode.
- Slide the **TV/CABLE/SAT/DVD** switch to **DVD**.
- Press **HDD** or **DVD** to choose the corresponding deck.
- Load a DVD disc to modify.

ATTENTION:

- It is not possible to modify discs recorded on DVD units from other manufacturers.
- You cannot perform timer recording during editing the index by pressing **EDIT**. Press **EDIT** to clear the editing screen before performing timer recording.

Modify Index

- 1 Press **EDIT**. The Editing screen appears.
- 2 (DVD deck only) Press **selection keys** to select "MODIFY" under "ORIGINAL/PLAY LIST", then press **ENTER**.
- 3 Press **selection keys** to select "MODIFY" under "ORIGINAL", then press **ENTER**.
- 4 Press **selection keys** to select a title you want to modify, then press **ENTER**.
- 5 Press **selection keys** to select "INDEX", then press **ENTER**.
- 6 Press **▶** to start playback. Press **◀◀** or **▶▶** to search for the picture from the title, then press **II**.
 - The pictures of the title appear on the left window.
- 7 Confirm the arrow is on "REPLACE", then press **ENTER** to register new index. New index appears on the right window.
 - When you press **ENTER** with the arrow on "RETURN" you can return to the previous screen.
- 8 Press **EDIT** to return to the normal screen.

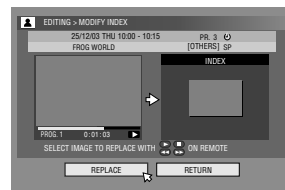

Modify Title Name

- 1 Perform steps 1 – 4 of "Modify Index" above before continuing.
- 2 Press **selection keys** to select "NAME", then press **ENTER**.
- 3 Press **selection keys** to select "ALPHABET", "SYMBOL1" or "SYMBOL2".
- 4 Press **selection keys** to select the desired letter or symbol, then press **ENTER**. Repeat this process to complete the name.
 - To correct a letter, press **selection keys** to select "DELETE", then press **ENTER**.
 - You can enter the letters up to 64.
- 5 Press **selection keys** to select "SAVE", then press **ENTER**.
- 6 Press **EDIT** to return to the normal screen.

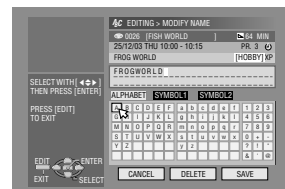

Modify Category

- 1 Perform steps 1 – 4 of “Modify Index” (pg. 52) before continuing.
- 2 Press **selection keys** to select “CATEGORY”, then press **ENTER**.
- 3 Press **selection keys** to select the desired category, then press **ENTER**.
- 4 Press **EDIT** to return to the normal screen.



Protect Title (DVD-RAM & DVD-RW (VR mode) only)

You can protect titles to prevent accidental erasure of the important titles.

- 1 Perform steps 1 – 2 of “Modify Index” (pg. 52) before continuing.
- 2 Press **selection keys** to select “PROTECT”, then press **ENTER**.
- 3 Press **selection keys** to select a title you want to protect, then press **ENTER**.
- 4 Press **<D>** to select “PROTECT”, then press **ENTER**. “” appears.
 - To cancel the protection, repeat 3 – 4 again. In step 4, select “CANCEL PROTECT”, then press **ENTER**.
- 5 Press **EDIT** to return to the normal screen.

NOTE:

All the titles on a disc will be deleted once the disc is formatted even if they are protected titles.

Delete Title

You cannot record any more with Library Database Navigation once the registered titles on the disc reach 99 titles for the DVD deck and 200 titles for the HDD deck. Deleting unnecessary titles after dubbing or other operations can increase remaining time and available recording capacity. (For DVD-R discs, although it is possible to delete recorded titles, available recording capacity does not increase.) The deleted title is never resumed. Play lists and title information in the unit’s library are also deleted.

- 1 Press **EDIT**. The Editing screen appears.
- 2 (DVD deck only) Press **selection keys** to select “MODIFY” under “ORIGINAL/PLAY LIST”, then press **ENTER**.
- 3 Press **selection keys** to select “DELETE” under “ORIGINAL”, then press **ENTER**.
- 4 Press **selection keys** to select a title you want to delete, then press **ENTER**.
- 5 Press **selection keys** to select “DELETE”, then press **ENTER**.
 - When you cancel the deletion, select “CANCEL”, then press **ENTER**.
- 6 Press **EDIT** to return to the normal screen.

Delete Unwanted Part Of The Title (DVD-RAM & DVD-RW (VR mode) only)

You can delete unwanted part of the title.

- 1 Perform steps 1 – 2 of “Modify Index” (pg. 52) before continuing.
- 2 Press **selection keys** to select “DEL SCEN”, then press **ENTER**.
- 3 Press **selection keys** to select a title whose unwanted part you want to delete, then press **ENTER**.
- 4 Press **>** to start playback. Press **<<** or **>>** to find the point where you want the deletion to begin, then press **II**.
- 5 Confirm the arrow is on “IN”, then press **ENTER**.
- 6 Press **>** to start playback. Press **<<** or **>>** to find the point where you want the deletion to end, then press **II**.
- 7 Press **selection keys** to select “OUT”, then press **ENTER**.
 - Select “PREVIEW”, then press **ENTER** to preview the edited title.
- 8 Press **selection keys** to select “OK”, then press **ENTER**.
 - If you do not want to delete the scene, press **RETURN**.

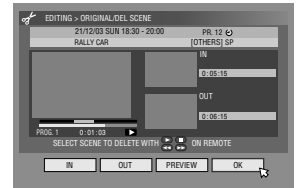

To modify the points

- 1 Press **RETURN**.
- 2 Repeat steps 4 – 8 as necessary.
- 9 Press **selection keys** to select “DELETE”, then press **ENTER**. The selected scene is deleted.
 - To cancel the deletion, press **selection keys** to select “CANCEL”, then press **ENTER**.
- 10 Press **EDIT** to return to the normal screen.

NOTES:

- There may be a discrepancy of several seconds between the scene you intend to edit, and the scene which is actually edited.
- Available recording capacity may not match the deleted part after deletion.

Divide Title (HDD deck only)

- 1 Press **EDIT**. The Editing screen appears.
- 2 Press **selection keys** to select "DIVIDE", then press **ENTER**.
- 3 Press **selection keys** to select a title to divide, then press **ENTER**.
- 4 Press **▶** to start playback. Press **◀◀** or **▶▶** to locate a point to divide, then press **II**.
- 5 Confirm the arrow is on "DIVIDE", then press **ENTER**.
 - The first picture (start) of the newly created title appears in the bottom right window.
 - Select "PREVIEW", then press **ENTER**. The first several seconds of the newly created title is played back, then the playback pauses at the dividing point.
 - To undo the division, press **selection keys** to select "RETRY", then press **ENTER**. Repeat the above procedure to locate another point to divide.
- 6 Press **selection keys** to select "OK", then press **ENTER**.
- 7 Press **selection keys** to select "DIVIDE", then press **ENTER**.
 - Select "CANCEL", then press **ENTER** to return to the previous screen.
- 8 Press **EDIT** to return to the normal screen.

NOTE:

There may be a discrepancy of several seconds between the scene you intend to edit, and the scene which is actually edited.

Modify Chapter (HDD, DVD-RAM & DVD-RW (VR mode) only)

You can create and delete chapter marks in titles.

- 1 Perform steps 1 – 4 of "Modify Index" (pg. 52) before continuing.
- 2 Press **selection keys** to select "CHAPTER", then press **ENTER**.
- 3 Press **▶** to start playback. Press **◀◀** or **▶▶**, then press **II** at the positions you want to mark.
- 4 Press **selection keys** to select "MARK", then press **ENTER**.
 - To undo the marking, press **selection keys** to select "ERASE", then press **ENTER**.
 - Repeat the above steps 3 and 4 to locate another point to mark.
- 5 Press **◀◀** or **▶▶** to select one chapter you want to delete, press **selection keys** to select "ERASE", then press **ENTER**.
 - To undo the deletion, press **selection keys** to select "RETRY", then press **ENTER**.
- 6 Press **EDIT** to return to the normal screen.

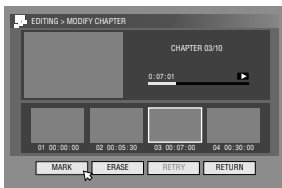

NOTE:

There may be a discrepancy of several seconds between the scene you intend to edit, and the scene which is actually edited.

Edit Play List Information



- Turn on the TV and select the AV mode.
- Slide the **TV/CABLE/SAT/DVD** switch to **DVD**.
- Press **HDD** or **DVD** to choose the corresponding deck.
- Load a DVD disc to modify.

ATTENTION:

- It is not possible to modify discs recorded on DVD units from other manufacturers.
- You cannot perform timer recording during editing the index by pressing **EDIT**. Press **EDIT** to clear the editing screen before performing timer recording.

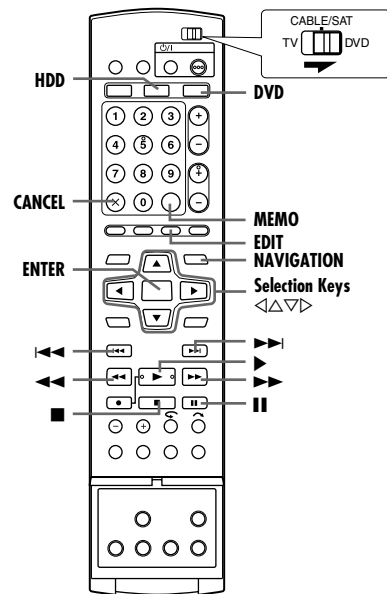

Play List

It is a collection of the scenes. A play list can be freely edited and played back without ever changing any original recording data. Using the random access of a disc (which allows video data to be instantly read no matter where it is on the disc), a play list includes information such as the timer counter for the playback start point and end point, indexes for checking the contents of recorded data, category information, and more. Playback according to a play list you have created allows you to enjoy various combinations of video images from a single title.

Create Play List

- 1 Press **EDIT**. The Editing screen appears.
- 2 (DVD deck only) Press **selection keys** to select "MODIFY" under "ORIGINAL/PLAY LIST", then press **ENTER**.
- 3 Press **selection keys** to select "CREATE", then press **ENTER**.
- 4 Press **selection keys** to select a title that includes scenes to be included in a play list, then press **ENTER**.
- 5 Press **▶** to start playback. Press **◀◀** or **▶▶** to find the point where you want the created play list to begin, then press **II**.
- 6 Confirm the arrow is on "IN/OUT", then press **ENTER**.
 - The edit-in time is displayed on the screen.
 - To undo, press **selection keys** to select "RETRY", then press **ENTER**.
- 7 Press **▶** to start playback. Press **◀◀** or **▶▶** to find the point where you want the created play list to end, then press **II**.
- 8 Confirm the arrow is on "IN/OUT", then press **ENTER**.
 - The edit-out time is displayed on the screen.
 - The edit-out point must come after the edit-in point.
 - Select "PREVIEW", then press **ENTER** to preview the play list.
- 9 Press **selection keys** to select "OK", then press **ENTER**.
- 10 Press **selection keys** to select "EXIT", then press **ENTER**.
- 11 Press **EDIT** to return to the normal screen.



NOTES:

- There may be a discrepancy of several seconds between the scene you intend to edit, and the scene which is actually edited.
- The title, index and category of the play list can be modified in the same way as "ORIGINAL". (pg. 52)
- You can modify the play list that has just been created here by adding, moving, or deleting unwanted parts to create a digest edition, etc.

Edit Scenes

- 1 Press **EDIT**. The Editing screen appears.
- 2 (DVD deck only) Press **selection keys** to select "MODIFY" under "ORIGINAL/PLAY LIST", then press **ENTER**.
- 3 Press **selection keys** to select "MODIFY" under "PLAY LIST", then press **ENTER**.
- 4 Press **selection keys** to select a play list to modify, then press **ENTER**.
- 5 Press **selection keys** to select "SCENE", then press **ENTER**.
- 6 Press **selection keys** to select "MODIFY", then press **ENTER**.
- 7 Press **selection keys** to select the start or end point of a scene to modify, then press **ENTER**.
- 8 Perform steps 5 – 11 of "Create Play List" above.

Add scenes

- 1 Perform steps 1 – 5 of "Edit Scenes" on the left column before continuing.
- 2 Press **selection keys** to select "SEL. TITLE", then press **ENTER**.
- 3 Perform steps 4 – 11 of "Create Play List" on the left column.

Move Scenes

- 1 Perform steps 1 – 5 of "Edit Scenes" on the left column before continuing.
- 2 Press **selection keys** to select "MOVE", then press **ENTER**.
- 3 Press **selection keys** to select a scene to move, then press **ENTER**.
- 4 Press **selection keys** to select another scene to which the scene is to be moved, then press **ENTER**.
 - To cancel the move, press **selection keys** to select "RETRY", then press **ENTER**.
- 5 Perform steps 9 – 11 of "Create Play List" on the left column.

Delete Scenes

- 1 Perform steps 1 – 5 of "Edit Scenes" on the left column before continuing.
- 2 Press **selection keys** to select "DELETE", then press **ENTER**.
- 3 Press **selection keys** to select a scene to delete, then press **ENTER**.
- 4 Perform steps 9 – 11 of "Create Play List" on the left column.

Play Back Play List

- 1 Press **NAVIGATION**. The Library Database Navigation screen appears.
- 2 Press **selection keys** to select "PLAY LIST", then press **ENTER**.
- 3 Press **selection keys** to select the index (small pictures) of the desired play list, then press **ENTER**.
 - When you want the plural play lists to be played back continuously, press **MEMO** after selecting the desired play lists. The numbers of the playback order appear on the index. You can select up to 8 play lists.
 - When you want to correct the order, move the arrow to the desired index and press **MEMO**. The number disappears and the unit re-numbers the other play lists automatically.
 - When you want to cancel the order, press **CANCEL(X)**.
- 4 Press **selection keys** to select "BEGINNING", then press **ENTER**. The playback starts.
 - Upon completing play list playback, the normal screen will resume.
 - The normal screen will also resume when **■** is pressed to stop play list playback.



Delete Play List

- 1 Press **EDIT**. The Editing screen appears.
- 2 (DVD deck only) Press **selection keys** to select "MODIFY" under "ORIGINAL/PLAY LIST", then press **ENTER**.
- 3 Press **selection keys** to select "DELETE" under "PLAY LIST", then press **ENTER**.
- 4 Press **selection keys** to select one play list you want to delete, then press **ENTER**.
- 5 Press **selection keys** to select "DELETE", then press **ENTER**.
 - When you cancel the deletion, select "CANCEL", then press **ENTER**.
- 6 Press **EDIT** to return to the normal screen.

NOTE:

Even if a play list is deleted, the titles recorded and the library information are not affected at all.

Modify Index

- 1 Perform steps 1 – 4 of "Edit Scenes" (pg. 55) before continuing.
- 2 Perform steps 5 – 8 of "Modify Index" (pg. 52).

Modify Play List Name

- 1 Perform steps 1 – 4 of "Edit Scenes" (pg. 55) before continuing.
- 2 Perform steps 2 – 6 of "Modify Title Name" (pg. 52).

Modify Category

- 1 Perform steps 1 – 4 of "Edit Scenes" (pg. 55) before continuing.
- 2 Perform steps 2 – 4 of "Modify Category" (pg. 53).

Navigate Library Information



Title information can be registered in the unit's memory for up to 600 DVD discs, 2,000 titles. It is helpful when finding a desired title (or play list) by sorting according to the sort options registered during (or after) recording.

- Turn on the TV and select the AV mode.
- Slide the **TV/CABLE/SAT/DVD** switch to **DVD**.
- Press **HDD** or **DVD** to choose the corresponding deck.

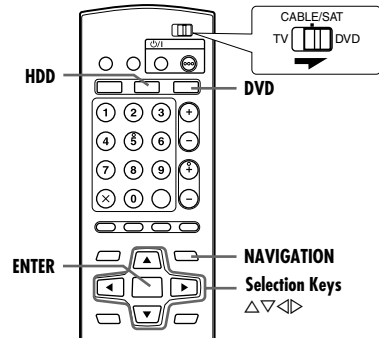

Scan For Title From Library

- 1 Press **NAVIGATION**. The Library Database Navigation screen appears.
- 2 Press **selection keys** to select the appropriate sort button to sort the information, then press **ENTER**.
 - "DATE":
 - Sort by date
 - "DISC No.":
 - Sort by disc number
 - "CATEGORY":
 - Sort by category
 - "NAME":
 - Sort by name
- "DATE" and "DISC No." are available for the DVD deck only.
- 3 Press **selection keys** to select the desired title, then press **ENTER**.
 - For HDD deck, playback begins automatically after the selected title is located.
 - For DVD deck, the title information will be displayed after the selected title is located. However, playback will not begin automatically.

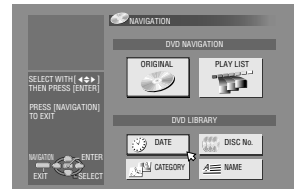

NOTE:

If a disc registered in the library is recorded or modified on DVD units from other manufacturers, it may become impossible to operate properly.

Register Disc

When a disc that is not registered in the library is loaded, a message appears confirming if the disc should be registered. If registering, perform the following procedure.

- 1 Press **selection keys** to select "REGISTER", then press **ENTER** to confirm the registration.
- 2 Press **NAVIGATION** to return to the normal screen.

NOTES:

- It is not possible to register discs formatted on devices other than JVC's DVD recorders.
- It is not possible to register discs recorded on devices other than JVC's DVD recorders.
- It is not possible to register discs when "SAVE AS LIBRARY" is set to "OFF". (pg. 72)

Playback With MP3/WMA/JPEG Navigation



This unit can play back discs that MP3/WMA sound files and JPEG image files taken with digital still cameras or other devices are recorded.

The MP3/WMA/JPEG Navigation enables you to search and select the desired files recorded on CD-R/RW or CD-ROM discs very easily.

- Turn on the TV and select the AV mode.
- Slide the TV/CABLE/SAT/DVD switch to DVD.
- Press DVD to select the DVD deck.

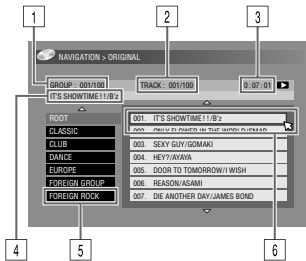

- 1 Selected group number/total number of groups on the disc
- 2 Selected file number/total number of files in the group that contains the selected file
- 3 Elapsed time (MP3/WMA)
- 4 Name of the selected file
- 5 Group name
- 6 Selected file

NOTES:

- If there are more than 100 files, the rest of the files are not displayed. In this case, press **ON SCREEN** to display them on the TV screen.
- If both MP3 files and WMA files are recorded on the same disc, WMA files cannot be played back as they are not displayed on the navigation screen.

Locating The Desired Group And Tracks

- 1 Load a disc.
- 2 Press **NAVIGATION**.
- 3 Press **selection keys** to select "ORIGINAL", then press **ENTER**.
- 4 Press **selection keys** to select the desired group, then press **ENTER**.
 - A list of files in the selected group appears.



- 5 Press **selection keys** to select the desired item, then press **ENTER**. The unit starts playback from the selected item.
 - The unit stops when all items in the selected group are played back.

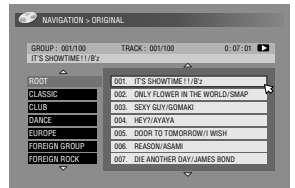

NOTES:

- If you press **SELECT** (▶) instead of **ENTER** in step 4, the unit starts playback from the first file of the group.
- JPEG files are played back as a slide show at the set intervals. (pg. 32)
- If a file name includes any 2-byte character, the unit may not show the file name correctly.
- The order of the groups and items shown in steps 4 and 5 may differ from the order shown on your PC.

Dubbing

- Turn on the unit.
- Turn on the TV and select the AV mode.
- Slide the **TV/CABLE/SAT/DVD** switch to **DVD**.

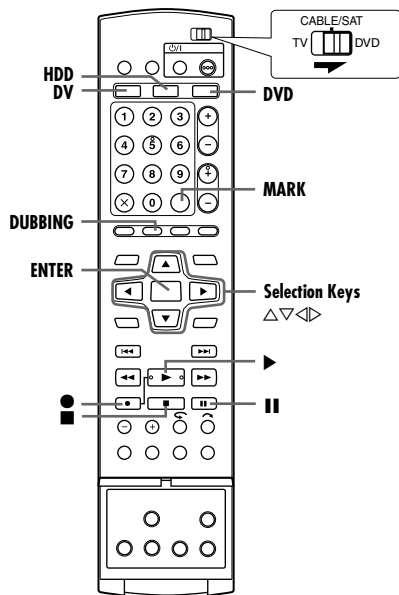

NOTES:

- It is not possible to dub copy-protected contents. An error message will appear on the TV screen.
- It is not possible to dub simultaneously when timer programming is set. Select either dubbing or timer programming.
- The order of the index which is displayed by pressing **DUBBING** differs from the images displayed by pressing **NAVIGATION** or **EDIT**.

High Speed Dubbing (From HDD To DVD)

It is possible to dub the original recordings and/or play lists on the HDD deck to DVD discs. The dubbing is performed in high speed, keeping the original transfer rate.

NOTES:

- After accessing the Dubbing Menu screen, it is not possible to take out a disc.
- It is not possible to dub copy-once titles in Video mode.
- When dubbing a copy-once title, the data will be moved from HDD to DVD upon completing dubbing.
- When you cancel dubbing a copy-once title during dubbing, the original recording on the HDD deck remains and the title copied to a DVD disc is deleted.
- It is not possible to dub play lists which contain copy-once titles.
- It is not possible to dub the following programmes to DVD-R/RW disc (Video mode):
 - which contains more than one audio language.
 - which is on the play list.
 - which is edited (also RetroActive Recording).
 - which is recorded in LP mode or FP155-FP240 mode.
- Recording may not be performed in the highest speed depending on the characteristics of the disc used.

- 1 Load a recordable disc.
- 2 Press **DUBBING** to access the Dubbing Menu screen.
- 3 Press **selection keys** to select "HDD→DVD", then press **ENTER**.
- 4 Press **selection keys** to select "HIGH SPEED", then press **ENTER**.

- 5 Press **selection keys** to select indexes (small pictures) of desired original recordings and/or play lists, then press **MARK**. After selecting all indexes you want to dub, press **ENTER**.
 - You can select up to 8 original recordings and/or play lists.
 - The recordable time of the disc is displayed on the bar meter. For details, refer to "About Disc Remaining Display" (pg. 60).
- 6 Press **selection keys** to select "EXECUTE", then press **ENTER** to start dubbing.

NOTES:

- Play lists are dubbed as programmes.
- In Video mode, if the selected play list includes the scenes recorded in the different transfer rate, the dubbing is performed in the highest transfer rate of the scenes in the selected play list.
- During dubbing, it is not possible to play back on HDD or DVD, or to set timer programming.
- It is not possible to discontinue dubbing once it has been started.

Just Dubbing (From HDD To DVD)

By using Just Dubbing function, when dubbing all selected original recordings and/or play lists, the unit automatically sets the appropriate recording mode depending on the combination of the total time of the selected recordings and/or play lists to be dubbed and the available disc space.

- 1 Load a recordable disc.
- 2 Press **DUBBING** to access the Dubbing Menu screen.
- 3 Press **selection keys** to select "HDD→DVD", then press **ENTER**.
- 4 Press **selection keys** to select "JUST", then press **ENTER**.
- 5 Perform steps 5 – 6 of "High Speed Dubbing (From HDD To DVD)".

NOTES:

- Play lists are dubbed as programmes.
- In Video mode, if the selected play list includes the scenes recorded in the different transfer rate, the dubbing is performed in the highest transfer rate of the scenes in the selected play list. However, the lower transfer rate cannot be dubbed in the higher transfer rate.
- The recordable time of the disc is displayed on the bar meter. For details, refer to "About Disc Remaining Display" (pg. 60).
- During dubbing, it is not possible to play back on HDD or DVD, or to set timer programming.
- It is not possible to discontinue dubbing once it has been started.

Manual Dubbing (From HDD To DVD)

It is possible to perform dubbing in the desired transfer rate.

- 1 Load a recordable disc.
- 2 Press **DUBBING** to access the Dubbing Menu screen.
- 3 Press **selection keys** to select "HDD→DVD", then press **ENTER**.
- 4 Press **selection keys** to select "MANUAL", then press **ENTER**.
- 5 Perform step 5 of "High Speed Dubbing (From HDD To DVD)". The Manual Dubbing screen appears.
- 6 Press **selection keys** to select "REC MODE", then press **ENTER**. Press **selection keys** to select the desired option, then press **ENTER**.
- 7 Press **▽** to select "CONFIRM", then press **ENTER**.
- 8 Press **selection keys** to select "EXECUTE", then press **ENTER** to start dubbing.

NOTES:

- In Video mode, if the selected play list includes the scenes recorded in the different transfer rate, the dubbing is performed in the highest transfer rate of the scenes in the selected play list. However, the lower transfer rate cannot be dubbed in the higher transfer rate.
- The recordable time of the disc is displayed on the bar meter. For details, refer to "About Disc Remaining Display" (pg. 60).
- During dubbing, it is not possible to play back on HDD or DVD, or to set timer programming.
- It is not possible to discontinue dubbing once it has been started.

Dubbing From HDD To DV

It is possible to perform dubbing from the HDD deck to the DV deck.

- 1** Load a Mini DV cassette with the erase protection switch set to "REC".
- 2** Press **DUBBING** to access the Dubbing Menu screen.
- 3** Press **selection keys** to select "HDD→DV", then press **ENTER**.
- 4** Press **selection keys** to select indexes (small pictures) of desired original recordings and/or play lists, then press **MARK**. After selecting all indexes you want to dub, press **ENTER**.
 - You can select up to 8 original recordings and/or play lists.
- 5** Press **selection keys** to select "SELECT REC. MODE", then press **ENTER**. Press **selection keys** to select the desired option, then press **ENTER**.
- 6** Press **selection keys** to select "SELECT SND. MODE", then press **ENTER**. Press **selection keys** to select the desired option, then press **ENTER**.
- 7** Press ∇ to select "CONFIRM", then press **ENTER**. The confirmation screen appears.
- 8** Press **DV** so that the DV lamp lights up on the unit.
- 9** Press \blacktriangleright to locate the point from where you want to start dubbing, press \blacksquare or \parallel then press \bullet and \parallel simultaneously so that the DV deck enters the record pause mode.
- 10** Press **HDD** so that the HDD lamp lights up on the unit.
 - The dubbing screen will appear.
- 11** Press **selection keys** to select "EXECUTE", then press **ENTER** for confirmation.
 - To cancel the dubbing, press \blacksquare then **selection keys** to select "CANCEL" and press **ENTER** to confirm.
- 12** Upon completing dubbing, the tape stops and "DUBBING COMPLETED" appears on the TV screen. Press **ENTER** to end.

Original Dubbing (From DVD To HDD)

It is possible to dub the original recordings on DVD discs to the HDD deck.

- 1** Load a disc you want to dub.
- 2** Press **DUBBING** to access the Dubbing Menu screen.
- 3** Press **selection keys** to select "DVD→HDD", then press **ENTER**.
- 4** Press **selection keys** to select indexes (small pictures) of desired original recordings and/or play lists, then press **MARK**. After selecting all indexes you want to dub, press **ENTER**.
 - You can select up to 8 original recordings and/or play lists.
- 5** Press **selection keys** to select "EXECUTE", then press **ENTER** to start dubbing.

NOTES:

- It is not possible to dub play lists on DVD discs.
- It is not possible to dub pre-recorded DVD VIDEO discs.
- It is not possible to dub Video CDs/SVCDs or Audio CDs.
- It is not possible to discontinue dubbing once it has been started.

Dubbing From DVD To DV

It is possible to perform dubbing from the DVD deck to the DV deck.

- 1** Load the disc you want to dub onto the DVD deck, and a Mini DV cassette with the erase protection switch set to "REC" to the DV deck.
- 2** Press **DUBBING** to access the Dubbing Menu screen.
- 3** Press **selection keys** to select "DVD→DV", then press **ENTER**.
- 4** Press **selection keys** to select indexes (small pictures) of desired original recordings and/or play lists, then press **MARK**. After selecting all indexes you want to dub, press **ENTER**.
 - You can select up to 8 original recordings and/or play lists.
- 5** Press **selection keys** to select "SELECT REC. MODE", then press **ENTER**. Press **selection keys** to select the desired option, then press **ENTER**. The confirmation screen appears.
- 6** Press **selection keys** to select "SELECT SND. MODE", then press **ENTER**. Press **selection keys** to select the desired option, then press **ENTER**.
 - Sound mode selection is not available when dubbing a DVD-RW (Video mode) or DVD-R disc.
- 7** Press ∇ to select "CONFIRM", then press **ENTER**. The confirmation screen appears.
- 8** Press **DV** so that the DV lamp lights up on the unit.
- 9** Press \blacktriangleright to locate the point from where you want to start dubbing, press \blacksquare or \parallel then press \bullet and \parallel simultaneously so that the DV deck enters the record pause mode.
- 10** Press **DVD** so that the DVD lamp lights up on the unit.
 - The dubbing screen will appear.
- 11** Press **selection keys** to select "EXECUTE", then press **ENTER** to confirm.
 - To cancel the dubbing, press \blacksquare then **selection keys** to select "CANCEL" and press **ENTER** to confirm.
- 12** Upon completing dubbing, the tape stops and "DUBBING COMPLETED" appears on the TV screen. Press **ENTER** to end.

NOTES:

- It is not possible to dub play lists on DVD discs.
- It is not possible to dub Video CDs/SVCDs or Audio CDs.
- When dubbing is in progress, only \blacksquare is functional.

Dubbing From DV To HDD (Dubbing An Entire Cassette)

It is possible to perform automatic dubbing of all the recorded programmes of a cassette from the DV deck to the HDD deck using the "ENTIRE" dubbing. You cannot select the images to be dubbed; all recorded images on the DV cassette will be dubbed.

- 1 Load the Mini DV cassette you want to dub. Make sure its erase protection switch is set to "SAVE".
 - Set "DV AUDIO REC" to the appropriate mode. (pg. 72)
- 2 Press **DUBBING** to access the Dubbing Menu screen.
- 3 Press **selection keys** to select "DV→HDD", then press **ENTER**.
- 4 Select "ENTIRE", then press **ENTER**.
- 5 Press **selection keys** to select "SELECT REC. MODE", then press **ENTER**. Press **selection keys** to select the desired option, then press **ENTER**.
- 6 Press **selection keys** to select "SELECT SND. MODE", then press **ENTER**. Press **selection keys** to select the desired option, then press **ENTER**.
- 7 Press ∇ to select "CONFIRM", then press **ENTER**. The confirmation screen appears.
- 8 Press **selection keys** to select "EXECUTE", then press **ENTER** for confirmation.
 - Once dubbing starts, it will continue dubbing until the end of the tape is reached.
 - To cancel the dubbing, press \blacksquare then **selection keys** to select "CANCEL" and press **ENTER** to confirm.
 - If the tape is not rewind, the unit will start dubbing after automatically rewinding the tape to the beginning.
- 9 Upon completing dubbing, the tape stops and "DUBBING COMPLETED" appears on the TV screen. Press **ENTER** to end.
 - The tape will automatically be rewind.

NOTES:

- "SUPERIMPOSE" is automatically set to "OFF". It will return to "AUTO" after dubbing is completed.
- When there are blanks on the tape of more than 2 seconds, the HDD deck will enter into pause mode while playback on DV deck continues. This also applies to portions of the DV tape that are damaged or unreadable. The last image is displayed on the TV screen. Dubbing will resume once recorded portion is detected. If the blank portion continues until the end of the tape, "DUBBING COMPLETED" appears on the TV screen when the tape end is reached and the tape rewinds automatically.
- Dubbing copyright guarded tape is not possible.
- When dubbing is in progress, only \blacksquare is functional.

Dubbing From DV To DVD (Dubbing An Entire Cassette)

It is possible to perform automatic dubbing of all the recorded programmes of a cassette from the DV deck to the DVD deck using the "ENTIRE" dubbing. You cannot select the images to be dubbed; all recorded images on the DV cassette will be dubbed.

- 1 Load the Mini DV cassette you want to dub. Make sure its erase protection switch is set to "SAVE".
 - Set "DV AUDIO REC" to the appropriate mode. (pg. 72)
- 2 Press **DUBBING** to access the Dubbing Menu screen.
- 3 Press **selection keys** to select "DV→DVD", then press **ENTER**.
- 4 Select "ENTIRE", then press **ENTER**.
- 5 Press **selection keys** to select "SELECT REC. MODE", then press **ENTER**. Press **selection keys** to select the desired option, then press **ENTER**.
- 6 Press **selection keys** to select "SELECT SND. MODE", then press **ENTER**. Press **selection keys** to select the desired option, then press **ENTER**.
- 7 Press ∇ to select "CONFIRM", then press **ENTER**. The confirmation screen appears.

- 8 Press **selection keys** to select "EXECUTE", then press **ENTER** for confirmation.
 - Once dubbing starts, it will continue dubbing until the end of the tape is reached.
 - To cancel the dubbing, press \blacksquare then **selection keys** to select "CANCEL" and press **ENTER** to confirm.
 - If the tape is not rewind, the unit will start dubbing after automatically rewinding the tape to the beginning.
- 9 Upon completing dubbing, the tape stops and "DUBBING COMPLETED" appears on the TV screen. Press **ENTER** to end.
 - The tape will automatically be rewind.

NOTES:

- "SUPERIMPOSE" is automatically set to "OFF". It will return to "AUTO" after dubbing is completed.
- The programme information at the DV deck will not be dubbed.
- When there are blanks on the tape of more than 2 seconds, the DVD deck will enter into pause mode while playback on DV deck continues. This also applies to portions of the DV tape that are damaged or unreadable. The last image is displayed on the TV screen. Dubbing will resume once recorded portion is detected. If the blank portion continues until the end of the tape, "DUBBING COMPLETED" appears on the TV screen when the tape end is reached and the tape rewinds automatically.
- Dubbing copyright guarded tape is not possible.
- When dubbing is in progress, only \blacksquare is functional.

About Disc Remaining Display

When dubbing from HDD to DVD, the unit displays the time information for dubbing by bar meter. By comparing the disc remaining time and the necessary time for dubbing of the selected items, it is possible to check if the dubbing can be performed completely or not.

When performing the High Speed Dubbing

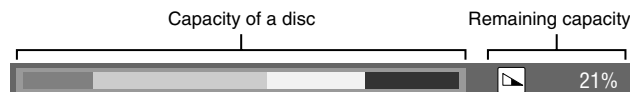

Dark green: Length of already recorded item
 Light green: Length of selected item
 Yellow: Length of the item now being selected by arrow
 Red: Excess over the capacity

When performing the Just Dubbing



- The unit displays the status on the assumption that the selected items are dubbed in the lowest transfer rate.
- The total time of a loaded disc is displayed on the right of the bar meter.

When performing the Manual Dubbing



- The unit displays the status on the assumption that the selected items are dubbed in the lowest transfer rate.
- The available highest transfer rate is displayed on the right of the bar meter.

DV Dubbing (HDD & DVD Deck Only)

You can dub programmes from a camcorder or DV equipment connected to the unit with a DV cable. The unit's remote control allows you the limited control of the connected camcorder or DV equipment functions during dubbing.

NOTES:

- When connecting the unit to a device equipped with a DV input connector, be sure to use the optional DV cable (VC-VDV 204U).
- When you connect a PC to the [DV IN] connector, we do not assure the normal operation of this unit.

Your unit

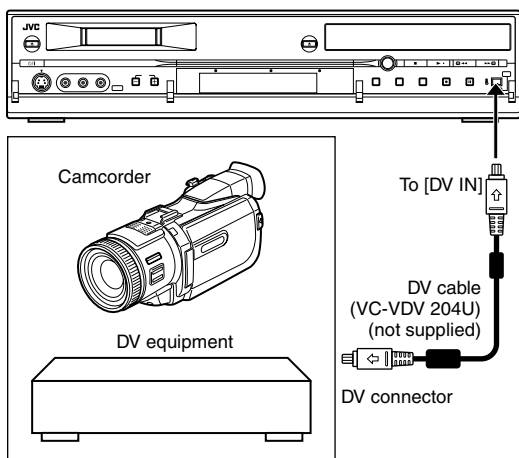

The following on-screen display for DV dubbing appears when **ON SCREEN** is pressed while the channel has been set to "DV".

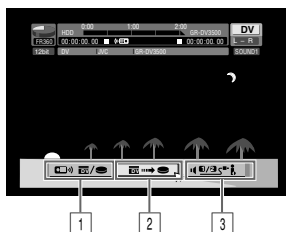

1 Remote control switch

To switch between the devices operable by the remote control unit. The unit is operable when the remote icon (📺) displayed faces to the left, while the DV device is operable when the remote icon is facing to the right.

2 Auto capture button

Select to start or pause the dubbing. If **ENTER** is pressed when the DV device is in the pause condition, preroll editing* where it is possible to dub with a start time that is highly accurate will be activated. When the DV device cannot be operated from the unit (such as in camera mode), proceed with normal recording (see pg. 34, 37).

- Do not start dubbing at the portion with no time code ("--:--:--").
- * Preroll editing refers to the playback after the DV tape is slightly rewind. (For DV devices that do not support the -1x speed, the rewinding time may be longer.)

3 Sound monitor switch

For selecting the desired sound format for dubbing.

1 Connect a camcorder or DV equipment to the [DV IN] connector on the unit's front panel.

2 Press DV/HDD/DVD SELECT on the unit repeatedly; or press HDD or DVD on the remote control to select the recording deck.

- When dubbing to a DVD disc, load a recordable disc on this unit.

3 Press PR +/- to set the channel to "DV".

4 Press ON SCREEN.

- The on-screen display for DV dubbing appears.

5 Press selection keys to select (📺 DV 📺), then press ENTER to display the remote icon (facing to the right) for the DV equipment.

6 Press REC MODE repeatedly to set the recording mode. For DV deck, press REC MODE on the remote control to set the recording mode.

7 Locate the point from where you want to start dubbing, then stop or pause playback by pressing the following buttons on the remote control: ▶, ⏩, ⏪, ■, ⏸.

- To play back in slow speed (1/10 of the normal speed), press ⏸ to pause playback, then press ⏪ or ⏩.
- To play back frame-by-frame, press ⏸ to pause playback, then press ⏸ repeatedly. Each press of ⏸ advances a frame.
- To change the playback direction, press ⏪ or ⏩.

8 Press selection keys to select (📺 0/05* 📺), then press ENTER repeatedly until the desired sound track appears on the TV screen.

SOUND1:

Select this to record the original stereo sound played back on the connected DV equipment.

SOUND2:

Select this to record the dubbed stereo sound played back on the connected DV equipment.

MIX:

Select this to record the sound of both "SOUND1" and "SOUND2".

- Note that this selection is not available when the source programme is recorded in 16BIT (48 kHz) mode.

9 Press selection keys to select (📺 DV 📺), then press ENTER. The dubbing starts.

- Playback on the external DV equipment and recording on the unit should start simultaneously.
- To pause dubbing, press selection keys to select (📺 DV 📺), then press ENTER. Both the unit and the external DV equipment pause dubbing. Pressing ⏸ on the unit also works the same way.

10 Press selection keys to select (📺 DV 📺), then press ENTER. Then press ■. The DV equipment stops.

11 Press selection keys to select (📺 DV 📺), then press ENTER.

12 Press ■ twice on the remote control to stop dubbing.

- Both the unit and the external DV equipment stop dubbing.

NOTES:

- Dubbing copyright guarded programmes is not possible.
- Original DV information such as the recording date and time are not recorded.
- The superimposed indication during the operation or dubbing is not recorded.
- If the dubbing is paused while the channel is set to "DV", you cannot switch channels.

When you dub from DV equipment other than a camcorder

- 1 Perform step 1 to 4.
- 2 Locate the point from where you want to start dubbing, then stop on the DV equipment.
 - If you pause the DV equipment in this step, a few second's still picture will be recorded at the beginning of the recorded programme.
- 3 Set the input mode to "DV INPUT" on the DV equipment.
 - If you select an input mode other than "DV INPUT", unwanted pictures may be recorded at the beginning of the recorded programme.
- 4 Perform step 9 to 12.

To skip unwanted part of the source picture

Press **ENTER** to stop both equipment, then press selection keys to select (📺 DV 📺).

Locate the point where you want to restart dubbing by pressing ▶, ⏩, or ⏪, then press ■.

Press selection keys to select (📺 DV 📺), then press **ENTER** to restart dubbing.

Edit From A Camcorder

You can use a camcorder as the source player and your unit as the recording deck. If your camcorder has a DV IN/OUT connector, you can use the camcorder as the recording deck and your unit (DV deck only) as the source player.

1 If the camcorder has no S-VIDEO output connector:

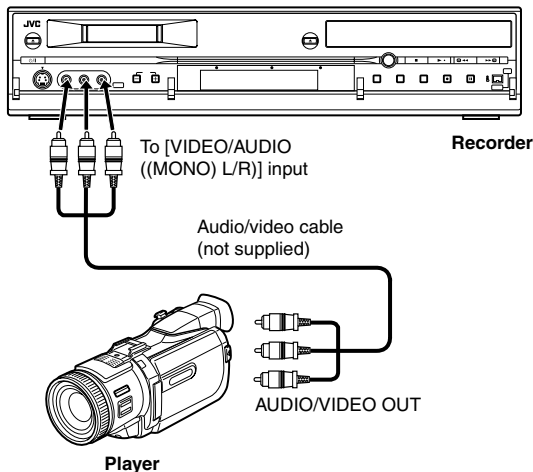

2 If the camcorder has an S-VIDEO output connector:

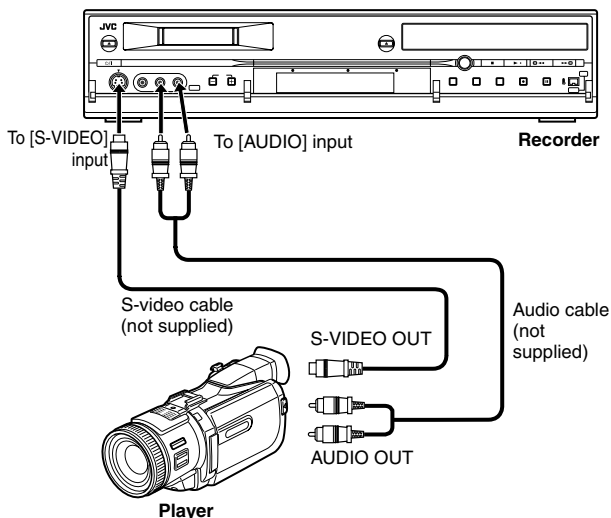

3 If the camcorder has a DV IN/OUT connector:

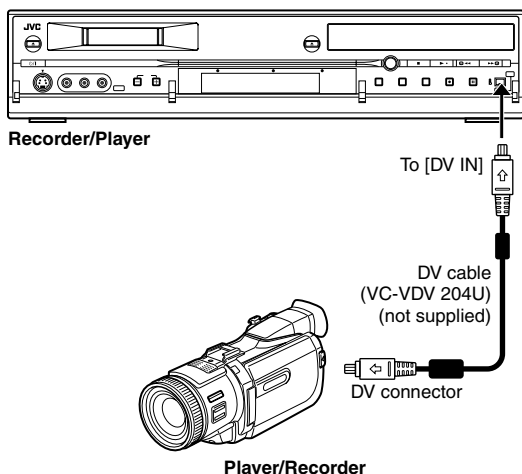

- Slide the **TV/CABLE/SAT/DVD** switch to **DVD**.

1 Make connections.

- If the camcorder has no S-VIDEO output connector:
 - connect the camcorder's AUDIO/VIDEO OUT connectors to the unit's [VIDEO/AUDIO ((MONO) L/R)] input connectors on the front panel.
- If the camcorder has an S-VIDEO output connector:
 - connect the camcorder's AUDIO OUT and S-VIDEO OUT connectors to the unit's [AUDIO] and [S-VIDEO] input connectors on the front panel.
- If the camcorder has a DV IN/OUT connector:
 - connect the camcorder's DV IN/OUT connector to the unit's [DV IN/OUT] connector.

- When using a monaural camcorder, connect its AUDIO OUT connector to the [AUDIO-L] input connector on your unit.

2 Press **DV/HDD/DVD SELECT** on the unit repeatedly to select the recording deck.

3 Press **PR +/-** to select "F-1" or "DV".

- Set "F-1 INPUT" to "VIDEO" for the [VIDEO] input connector, or "S-VIDEO" for the [S-VIDEO] input connector, depending on the connector being used. (pg. 65)

4 Press **REC MODE** repeatedly to set the recording mode. For DV deck, press **REC MODE** on the remote control to set the recording mode.

5 Start playback on the camcorder slightly before the actual point from where you wish to start dubbing.

6 Press **●** on the unit to start recording. Or while holding **●**, press **▶** on the remote control. The dubbing starts.

7 Press **■** on the unit, then stop playback on the camcorder.

NOTES:

- All necessary cables can be obtained from your dealer.
- Refer to the camcorder's instruction manual for operating procedure.
- The quality of dubbed picture becomes poorer than that of the original.
- When you are editing through the [DV IN/OUT] connector, the unit will stop if the player begins playing a blank portion of tape or the signal is interrupted.
- When connecting the unit to a device equipped with a DV input connector, be sure to use the optional DV cable (VC-VDV 204U).
- To edit through the [DV IN/OUT] connector using the HDD or DVD deck, refer to "DV Dubbing (HDD & DVD Deck Only)" (pg. 61).

Edit To Or From Another Recorder

You can use your unit as the source player or as the recording deck.

NOTES:

- When using another recorder as the recording deck, refer to its instruction manual.
- It is not possible to dub copy-protected contents. An error message will appear on the TV screen.

1 When using your unit as the source player

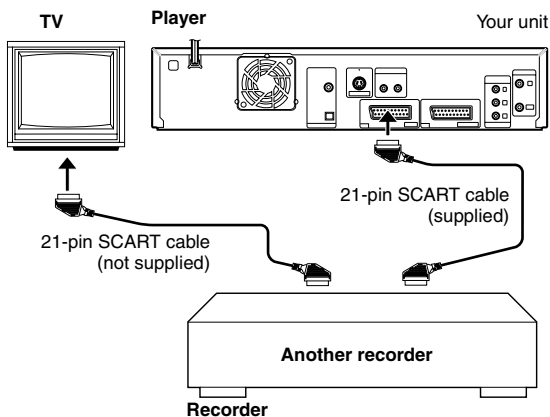

2 When using your unit as the recording deck

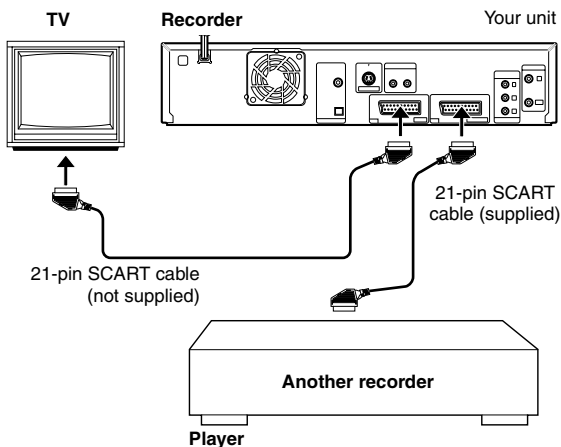

- Slide the **TV/CABLE/SAT/DVD** switch to **DVD**.

- 1 Connect another recorder's 21-pin SCART connector to the unit's 21-pin SCART connector as illustrated.
 - 1 When using your unit as the source player:
 - connect its [L-1 IN/OUT] connector to the recording deck.
 - 2 When using your unit as the recording deck:
 - connect its [L-2 IN/DECODER] connector to the source player.
- If another recorder is compatible with the Y/C signal:
 - when using your unit as the source player, set "L-1 OUTPUT" to "SCART S-VIDEO". (pg. 64)
 - when using your unit as the recording deck, set "L-2 SELECT" to "S-VIDEO". (pg. 64)
- 2 When using this unit as the recording deck, press **DV/HDD/DVD SELECT** on the unit repeatedly to select the recording deck.
- 3 When using this unit as the recording deck, press **PR +/-** to select "L-2".
 - Set "L-2 SELECT" to "VIDEO" or "S-VIDEO". (pg. 64)
- 4 When using this unit as the recording deck, press **REC MODE** repeatedly to set the recording mode. For DV deck, press **REC MODE** on the remote control to set the recording mode.
- 5 Engage the Play mode of the source player.
- 6 Engage the Record mode of the recording deck.
- 7 Stop recording on the recording deck, then stop playback on the source player.

NOTES:

- All necessary cables can be obtained from your dealer.
- For Y/C signal input/output, be sure to use a 21-pin SCART cable that is compatible with the Y/C signal.
- When you use this unit as the source player for editing, be sure to set "SUPERIMPOSE" to "OFF" before starting. (pg. 73) If you are using another recorder with S-Video and Audio output connectors, connect its S-Video and Audio output connectors to this unit's [S-VIDEO] and [AUDIO] input connectors on the front panel. Then, set the unit's input mode to "F-1" in step 3, and set "F-1 INPUT" to "S-VIDEO". (pg. 65)

Output/Input Set

- Turn on the TV and select the AV mode.
- Slide the TV/CABLE/SAT/DVD switch to **DVD**.

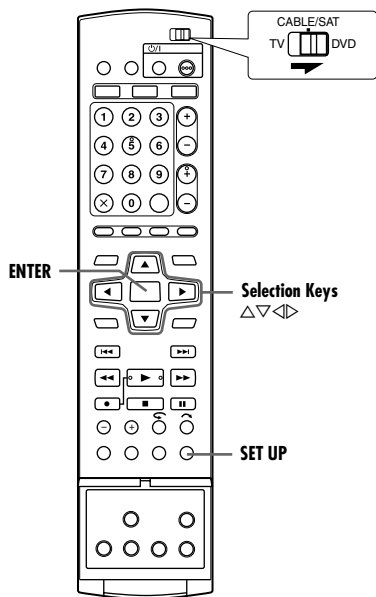

L-1 Output And L-1 Input Setting

The [L-1 IN/OUT] connector accepts and delivers either a composite signal (regular video signal) or a Y/C signal (a signal in which the luminance and chrominance signals are separated). Set "L-1 OUTPUT" and "L-1 INPUT" to the appropriate mode depending on the type of appliance connected to the unit's [L-1 IN/OUT] connector.

- 1 Press **SET UP** to access the Main Menu screen.
- 2 Press **selection keys** to select "FUNCTION SET UP", then press **▽**.
- 3 Press **selection keys** to select "VIDEO IN/OUT", then press **▽**.
- 4 Press **selection keys** to select "L-1 OUTPUT" or "L-1 INPUT", then press **ENTER**.
- 5 Press **selection keys** to select the appropriate setting, then press **ENTER**.
- 6 Press **SET UP** to complete the setting.

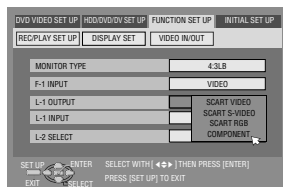
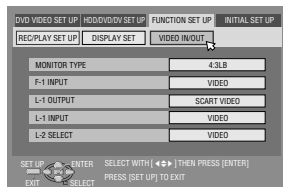

* The **boldface** settings below indicate the settings at your purchase.

L-1 OUTPUT — SCART VIDEO / SCART S-VIDEO / SCART RGB / COMPONENT

SCART VIDEO:

If a connected appliance's input is compatible only with regular video signals, set to "SCART VIDEO".

SCART S-VIDEO:

If a connected appliance's input is compatible with Y/C signals, set to "SCART S-VIDEO". You can obtain high-quality picture. (For connection, be sure to use a 21-pin SCART cable that is compatible with the Y/C signal.)

SCART RGB:

If a connected appliance's input is compatible with RGB signals, set to "SCART RGB". You can obtain a high-quality RGB picture.

COMPONENT:

If a connected appliance's input is compatible with Y/P_B/P_R signals, set to "COMPONENT". You can obtain a high-quality Y/P_B/P_R picture. Switch the TV to the input that you can watch component video pictures.

L-1 INPUT — VIDEO / S-VIDEO

VIDEO:

If a connected appliance's output is compatible only with regular video signals, set to "VIDEO".

S-VIDEO:

If a connected appliance's output is compatible with Y/C signals, set to "S-VIDEO". You can obtain a high-quality picture. (For connection, be sure to use a 21-pin SCART cable that is compatible with the Y/C signal.)

NOTES:

- If "L-1 OUTPUT" is set to "SCART S-VIDEO" or "SCART RGB", it is not possible to set "L-1 INPUT" to "S-VIDEO".
- If "L-2 SELECT" is set to "SAT S-VIDEO" or "DECODER", it is not possible to set "L-1 INPUT" to "S-VIDEO".
- If "L-2 SELECT" is set to "DECODER", it is only possible to set "L-1 OUTPUT" to "SCART VIDEO".
- Component video signals are not output from the [L-1 IN/OUT] connector.
- When Progressive scan mode is engaged, it is not possible to select the setting of "L-1 OUTPUT". (pg. 64)

L-2 Select Setting

Set "L-2 SELECT" to the appropriate mode depending on the type of appliance connected to the unit's [L-2 IN/DECODER] connector.

- 1 Perform steps 1 and 2 of "L-1 Output And L-1 Input Setting" on the left column.
- 2 Press **selection keys** to select "L-2 SELECT", then press **ENTER**.
- 3 Press **selection keys** to select the appropriate setting, then press **ENTER**.
- 4 Press **SET UP** to complete the setting.

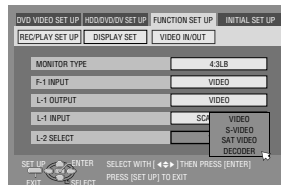

* The **boldface** settings below indicate the settings at your purchase.

L-2 SELECT — VIDEO / S-VIDEO / SAT VIDEO / SAT S-VIDEO / DECODER

Select "VIDEO" or "S-VIDEO" to use this unit as the recording deck with the player connected to the [L-2 IN/DECODER] connector, or to use the satellite receiver connected to the [L-2 IN/DECODER] connector.

VIDEO:

If a connected appliance's output is compatible only with regular video signals, set to "VIDEO".

S-VIDEO:

If a connected appliance's output is compatible with Y/C signals, set to "S-VIDEO". You can obtain high-quality picture. (For connection, be sure to use a 21-pin SCART cable that is compatible with the Y/C signal.)

Select "SAT VIDEO" or "SAT S-VIDEO" to view a satellite programme with the TV set while the unit is turned off. (pg. 70)

SAT VIDEO:

If a connected satellite receiver's output is compatible only with regular video signals, set to "SAT VIDEO".

SAT S-VIDEO:

If a connected satellite receiver's output is compatible with Y/C signals, set to "SAT S-VIDEO". (For connection, be sure to use a 21-pin SCART cable that is compatible with the Y/C signal.)

DECODER*:

To use a decoder connected to the [L-2 IN/DECODER] connector.

* This setting is not available in the U.K., although it is selectable.

NOTES:

- If you have a satellite receiver connected to the [L-2 IN/DECODER] connector, be sure to set "L-2 SELECT" back to appropriate mode after editing.
- If you are not connecting a satellite receiver to the [L-2 IN/DECODER] connector, leave "L-2 SELECT" set to "VIDEO".
- When "L-2 SELECT" is set to "SAT VIDEO" and "SAT S-VIDEO", "SAT" appears on the TV screen or front display panel instead of "L-2".
- If "L-1 OUTPUT" is set to "SCART S-VIDEO", it is not possible to set "L-2 SELECT" to "DECODER" or "SAT VIDEO".
- If "L-1 OUTPUT" is set to "SCART RGB", it is not possible to set "L-2 SELECT" to "DECODER" or "SAT S-VIDEO".
- If "L-1 OUTPUT" is set to "COMPONENT" and "L-2 SELECT" to "SAT VIDEO", "SAT S-VIDEO" or "DECODER", be sure to connect the [L-1 IN/OUT] connector with a TV.
- If "L-2 SELECT" is set to "SAT S-VIDEO", be sure to set "L-1 OUTPUT" to "SCART S-VIDEO".
- The S-Video output does not support the satellite receiver function. Make use of the L-1 output when viewing images from the satellite receiver.

F-1 Input Setting

Set "F-1 INPUT" to the appropriate mode depending on the connector (VIDEO or S-VIDEO) being used on the front panel.

- 1 Perform steps 1 and 2 of "L-1 Output And L-1 Input Setting" (pg. 64).
- 2 Press **selection keys** to select "F-1 INPUT", then press **ENTER**.
- 3 Press **selection keys** to select the appropriate setting, then press **ENTER**.
- 4 Press **SET UP** to complete the setting.

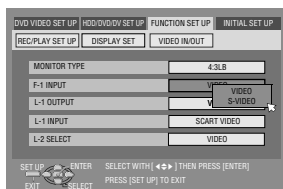

* The **boldface** settings below indicate the settings at your purchase.

F-1 INPUT — VIDEO / S-VIDEO

VIDEO:

When connecting an appliance to the [VIDEO] input connector, set to "VIDEO".

S-VIDEO:

When connecting an appliance to the [S-VIDEO] input connector, set to "S-VIDEO".

Digital Audio Dubbing

You can dub selected audio from a DVD or Audio CD disc to a digital audio device.

However, it is not possible to dub copy-protected discs.

- Turn on the TV and select the AV mode.
- Slide the **TV/CABLE/SAT/DVD** switch to **DVD**.

Example: Dubbing to an MD

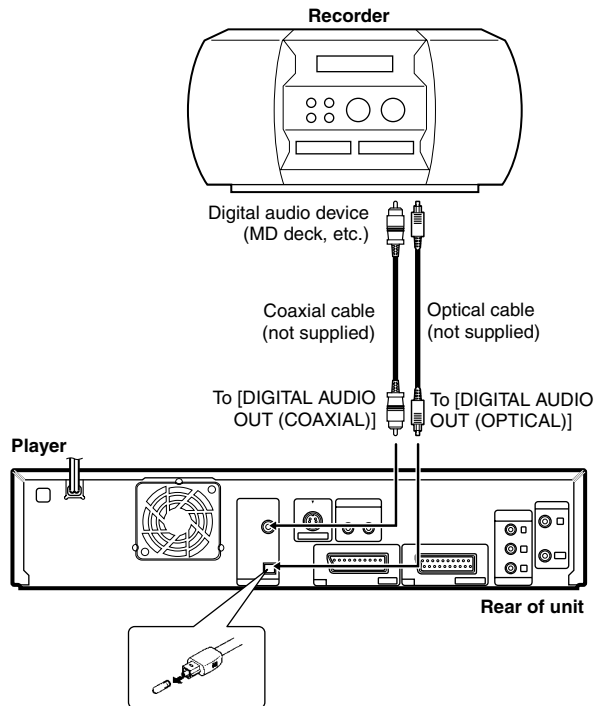

Note for connection:
Remove the protection cap from the optical cable.

- 1 Connect the unit and a digital audio device using either an optional optical cable or an optional coaxial cable.
- 2 Place a disc on the unit and load an MD on the connected digital audio device.
- 3 Select the audio to be dubbed.
- 4 Start playback slightly before the actual point from where you wish to start dubbing.
- 5 Press **II** to pause playback.
- 6 Select the input mode on the connected digital audio device.
- 7 Press **▶** to start playback on the unit.
- 8 Start recording on the digital audio device.
- 9 Stop recording on the digital audio device. Then press **■** to stop playback on the unit.

NOTE:

There may be a discrepancy of several seconds between where you intend editing to start, and where it actually starts.

Audio Dubbing (DV Deck Only)

This function allows you to record new audio, without erasing the original audio, on a DV tape that was recorded with "DV AUDIO REC" set to "12BIT" (pg. 72).

ATTENTION:

You cannot perform Audio Dubbing on a tape that was recorded with "DV AUDIO REC" set to "16BIT" (pg. 72), on a tape that was recorded at the "LP" speed, or on a blank tape.

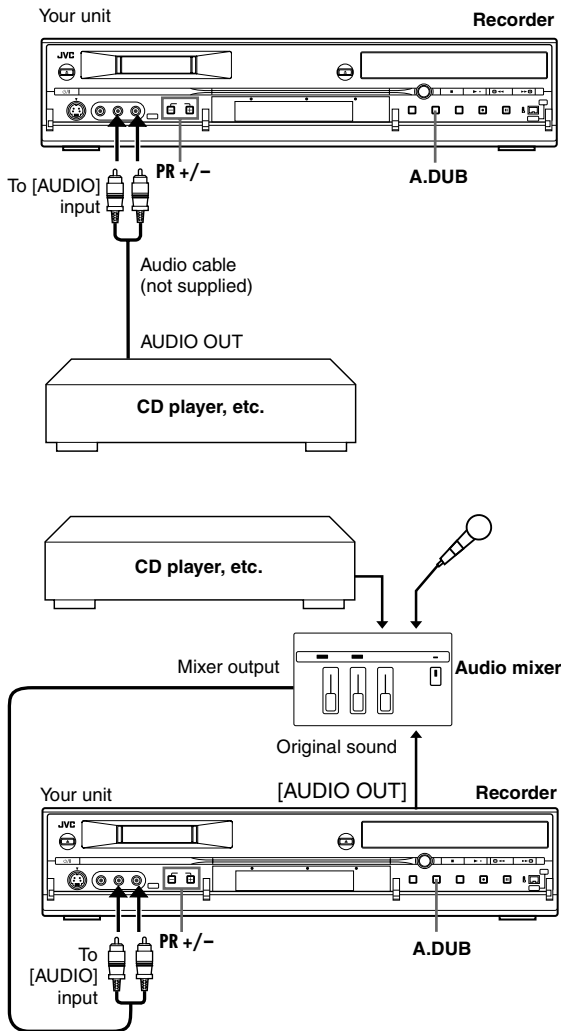

- Slide the TV/CABLE/SAT/DVD switch to DVD.

- 1 Connect an audio device to the unit's [AUDIO] input connectors on the front panel.
 - When using a monaural audio device, connect its AUDIO OUT connector to the [AUDIO-L] input connector on your unit.
- 2 Load a Mini DV cassette with the erase protection switch set to "REC".
- 3 Press DV/HDD/DVD SELECT on the unit repeatedly or DV on the remote so that the DV lamp lights up on the unit.
- 4 Press PR +/- to select "F-1".
- 5 Start playback slightly before the actual point from where you wish to start dubbing.
- 6 Press II to pause playback.
- 7 Press A.DUB to engage the audio dubbing mode.
 - Your unit enters the Audio Dubbing Pause mode.
 - To perform Audio Dubbing with audio mixing, press AUDIO to select "L R" at this point. When using the DV deck as the recording deck, also make sure that "AUDIO MODE" is set to "SOUND1" (pg. 72).
 - * Audio Dubbing with audio mixing is not possible if you are using a monaural audio component, or if you don't have an audio mixer.
- 8 Engage the audio device's playback, then press ► to start the tape in the unit. Audio dubbing starts at this point.
 - To stop dubbing temporarily, press II. Press ► to resume dubbing.
- 9 Press ■ on the unit, then stop playback on the audio device to end the audio dubbing.

NOTES:

- Once the Audio Dubbing starts, you cannot use the other deck.
- When monitoring the audio dubbed sound on the DV deck, set "AUDIO MODE" to "SOUND2" (pg. 72).
- Audio Dubbing is also possible with the [L-1 IN/OUT] or [L-2 IN/DECODER] connector on the rear panel. When using these 21-pin SCART connectors, be sure to select the correct input mode ("L-1" or "L-2") in step 4.
- When playing back an audio dubbed Mini DV tape on the DV deck, set "AUDIO MODE" to "SOUND2" (pg. 72).
- Audio dubbing is not possible using the [DV IN/OUT] connector.
- Audio dubbing is not possible on a blank portion of the tape.

Insert Editing (DV Deck Only)

Insert Editing replaces the pictures with new ones, while the audio soundtrack remains unchanged. For Insert Editing, use your unit as the recording deck.

ATTENTION:

Insert Editing is not possible with a Mini DV cassette recorded in LP mode.

1 If the player has no S-VIDEO output connector:

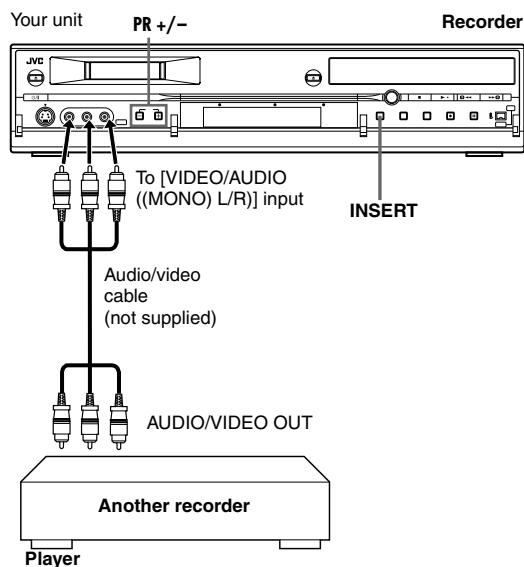

2 If the player has an S-VIDEO output connector:

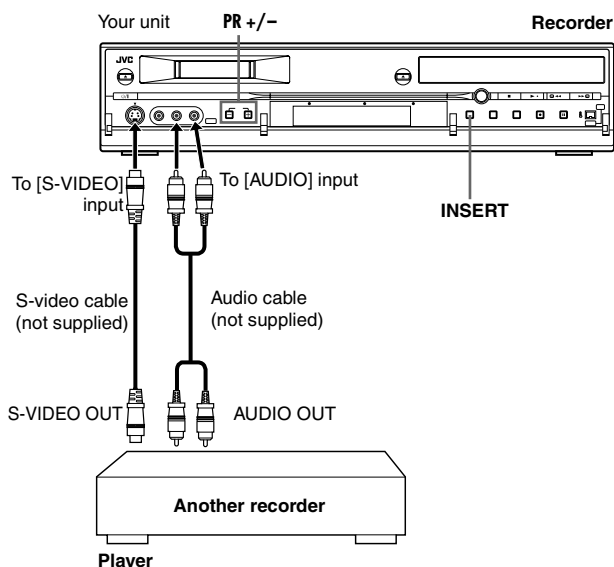

- Slide the TV/CABLE/SAT/DVD switch to DVD.

1 Make connections.

- 1 If the player has no S-VIDEO output connector:
 - connect the player's AUDIO/VIDEO OUT connectors to your unit's [VIDEO/AUDIO ((MONO) L/R)] input connectors on the front panel.
- 2 If the player has an S-VIDEO output connector:
 - connect the player's AUDIO OUT and S-VIDEO OUT connectors to your unit's [AUDIO] and [S-VIDEO] input connectors on the front panel.

2 Load a Mini DV cassette with the erase protection switch set to "REC".

3 Press DV/HDD/DVD SELECT on the unit repeatedly or DV on the remote so that the DV lamp lights up on the unit.

4 Press PR +/- to select "F-1".

5 Press <Left>, <Right> and <Stop> to determine the edit-in point (the beginning of the segment to be replaced).

- Be sure to engage the Still mode at the edit-in point.

6 Press INSERT to engage the insert editing mode.

- Your unit enters the Insert Pause mode.
- The TV screen changes from the still picture to the input source you are going to record.

7 Load the source cassette and play back the segment that is to be inserted. When you reach the start of the section of the source tape that you wish to insert, press <Right> to start the tape in your unit. Insert editing begins at this point.

8 Press <Stop> to stop recording on the DV deck to end insert editing.

NOTES:

- Once the Insert Editing starts, you cannot use the other deck.
- All necessary cables can be obtained from your dealer.
- Insert Editing cannot be performed on a Mini DV cassette that has had its erase protection switch set to "SAVE".
- When Insert Editing is performed on a tape that has been recorded on another video recorder, the inserted portion may appear distorted.
- A small portion of the recording which precedes an insert edit may become erased.
- Insert Editing is also possible with the [L-1 IN/OUT] or [L-2 IN/DECODER] connector on the rear panel. When using these 21-pin SCART connectors, be sure to select the correct input mode ("L-1" or "L-2") in step 4.
- Insert Editing is not possible using the [DV IN/OUT] connector.
- Insert Editing is not possible on a blank portion of the tape.

Remote Control Functions

Remote Control 1/2/3/4 Code Switching

The remote control is capable of controlling four JVC video units independently. Each of the units can respond to one of the four codes (1, 2, 3 or 4). The remote control is preset to send code 3 signals because your unit is initially set to respond to code 3 signals. You can easily modify your unit to respond to code 1, 2 or 4 signals.

- Slide the **TV/CABLE/SAT/DVD** switch to **DVD**.

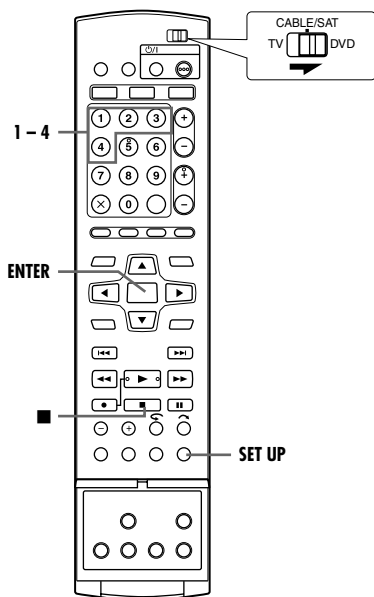
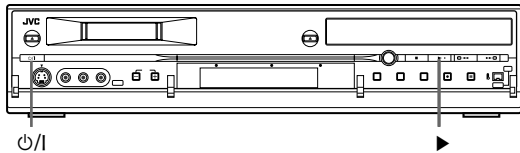

- Keep pressing **SET UP** down during step 1.
- 1 Press the **number key** "1" for 1, "2" for 2, "3" for 3 or "4" for 4 to change the remote control code, then press **ENTER**.
 - 2 Press **power** on the unit to turn off the unit.
 - 3 Press **right arrow** on the unit for over 5 seconds while the unit is turned off. The current code appears on the front display panel.
 - 4 Press **stop** on the remote control to change the unit's code. The new code blinks on the front display panel for approximately 5 seconds, and is applied to the unit.

NOTE:

When "POWER SAVE" is set to "ON" (pg. 73), it is not possible to change the remote code.

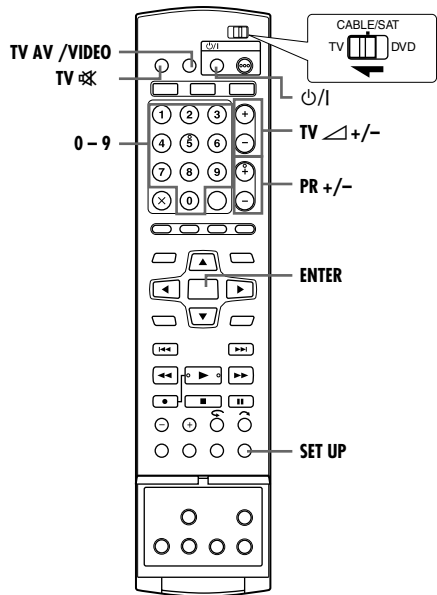

TV Multi-Brand Remote Control

Your remote control can operate the basic functions of your TV set. In addition to JVC TVs, other manufacturer's TVs can also be controlled.

- Turn off the TV using its remote control.
- Slide the **TV/CABLE/SAT/DVD** switch to **TV**.

IMPORTANT:

Although the provided remote control unit is compatible with JVC televisions, as well as many other models, it may not work with your TV or in some instances, may have limited function capability.

- Keep pressing **SET UP** down during step 1.
- 1 Enter your TV's brand code using the **number keys**, then press **ENTER**.
 - 2 Press **power** on the unit's remote control to turn on the TV and try operations (see step 3).
 - Once you have set the remote control to operate the TV, you do not have to repeat this step until you replace your remote control's batteries.
 - Some brands of TVs have more than one code. If the TV does not function with one code, try entering another.
 - 3 Press the corresponding buttons to operate the TV: **power**, **TV AV /VIDEO**, **PR +/-**, **TV +/-**, **TV**, **number keys**.
 - For some brands of TVs, you must press **ENTER** after having pressed the **number keys**.

BRAND NAME	CODE
JVC	01, 23, 24, 25
FERGUSON	27
FINLUX	30
FUNAI	32
LG/GOLDSTAR	18
GRUNDIG	19
HITACHI	10
ITT	28
MITSUBISHI	03
MIVAR	29
NEC	20
NOKIA	31
PANASONIC	04, 11
PHILIPS	02
RCA	05
SAMSUNG	12, 33, 34, 35
SANYO	13, 16
SHARP	06
SONY	07
THOMSON	26
TOSHIBA	08, 14

BRAND NAME	CODE
JVC	72, 73
AMSTRAD	60, 61, 62, 63, 92
CANAL +	81
D-BOX	85
ECHOSTAR (VIA DIGITAL)	82
FINLUX	68
FORCE	89
GALAXIS	88
GRUNDIG	64, 65
HIRSCHMANN	64
ITT NOKIA	68
KATHREIN	70, 71
LUXOR	68
MASCOM	93
MASPRO	70
NOKIA	87
PACE	67, 86, 92
PANASONIC	13, 14, 74
PHILIPS	66, 84
RFT	69
SAGEM	83
SALORA	68
SAMSUNG	05, 24
SKY DIGI BOX	92
SKYMASTER	69
TPS	83
TRIAx	91
WISI	64

Satellite Receiver Multi-Brand Remote Control

Your remote control can operate the basic functions of your satellite receiver set. In addition to JVC satellite receivers, other manufacturer's satellite receivers can also be controlled.

- Slide the **TV/CABLE/SAT/DVD** switch to **CABLE/SAT**.

IMPORTANT:

Although the provided remote control unit is compatible with JVC satellite receivers, as well as many other models, it may not work with your satellite receiver, or in some instances, may have limited function capability.

- Keep pressing **SET UP** down during step 1.
- 1** Enter your satellite receiver's brand code using the **number keys**, then press **ENTER**.
 - 2** Press **⏻/|** on the unit's remote control to turn on the satellite receiver and try operations (see step 3).
 - Once you have set the remote control to operate the satellite receiver, you do not have to repeat this step until you replace your remote control's batteries.
 - Some brands of satellite receivers have more than one code. If the satellite receiver does not function with one code, try entering another.
 - 3** Press the corresponding buttons to operate the satellite receiver: **⏻/|**, **PR +/-**, **number keys**.
 - For some brands of satellite receivers, you must press **ENTER** after having pressed the **number keys**.
 - The **number keys** may not function with some satellite receivers.

Connecting To A Satellite Receiver

Connect the satellite receiver to the [L-2 IN/DECODER] connector, then connect the [L-1 IN/OUT] connector to the TV's connector.

NOTES:

- Set "L-2 SELECT" to "VIDEO" or "S-VIDEO". (pg. 64)
- You can use the Automatic Satellite Programme Recording function (pg. 50) with this connection. (HDD deck only)
- To record a programme via the satellite receiver, select L-2 mode by pressing **PR +/-** so that "L-2" appears on the front display panel.
- For details, refer to the instruction manual of the satellite receiver.

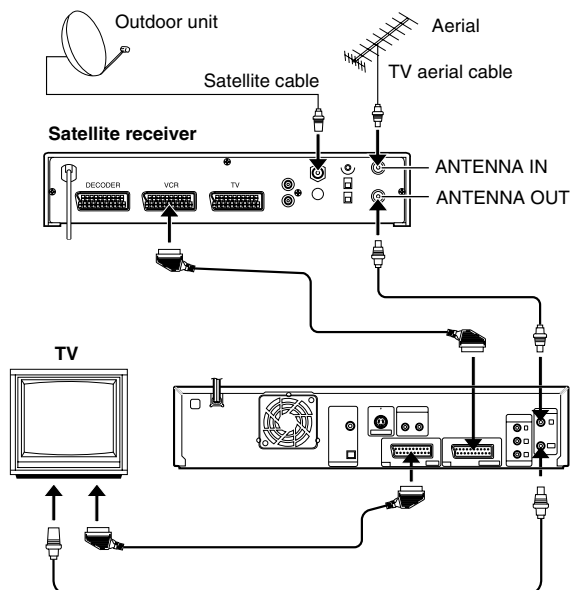

IMPORTANT

When you set "L-2 SELECT" to "SAT VIDEO" or "SAT S-VIDEO" (pg. 64), it is possible to view a satellite broadcast with the TV set to its AV mode even if the unit is turned off. When the unit is in Stop mode or recording, press **TV AV/VIDEO** on the remote control to turn off the VIDEO indicator on the front display panel.

- If you turn on the unit when the satellite receiver's power is off, nothing appears on the TV screen. In this case, turn on the satellite receiver, or set the TV to its TV mode, or press **TV AV/VIDEO** on the remote control to set the unit to the AV mode.

Connecting To A Dolby Digital Decoder Or An Amplifier With Built-in DTS

These instructions enable you to connect your unit to a Dolby Digital Decoder or an amplifier with built-in DTS.

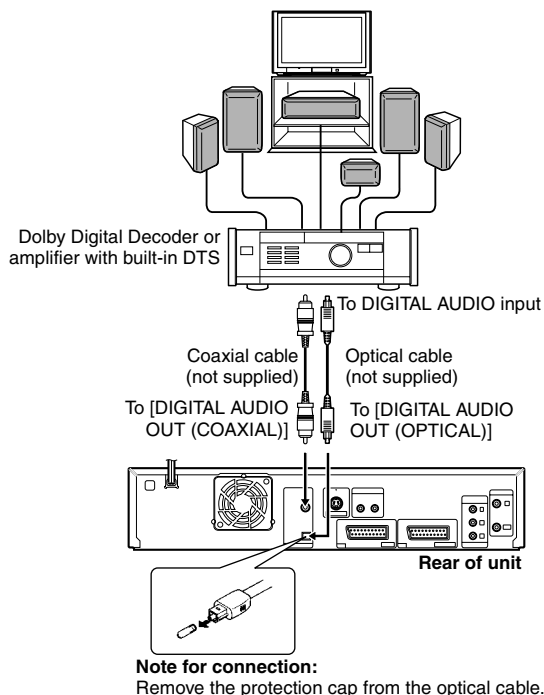

- 1 Connect the unit and a Dolby Digital Decoder or an amplifier with built-in DTS using either an optional optical cable or an optional coaxial cable.

NOTES:

- For Dolby Digital sound, set "DIGITAL AUDIO OUT" to "DOLBY DIGITAL/PCM". (pg. 71)
- For DTS sound, set "DIGITAL AUDIO OUT" to "STREAM/PCM". (pg. 71)

CAUTIONS:

- This unit has a dynamic range of more than 110 dB with regards to its Hi-Fi audio capability. It is recommended that you check the maximum level if you are going to listen to the Hi-Fi audio signals through a stereo amplifier. A sudden surge in the input level to the speakers may damage them.
- Some speakers and televisions are specially shielded to prevent television interference. If both are of the non-shielded type, do not place the speakers adjacent to the TV set as this can adversely affect the playback picture.

When you can't switch the audio channel of a bilingual programme

When the unit is connected with a digital audio device using an optional optical cable and "DIGITAL AUDIO OUT" is set to "DOLBY DIGITAL/PCM", it is not possible to switch the audio channel of a bilingual programme recorded on a DVD-RAM or DVD-RW (VR mode) disc. In this case, perform the following steps using the remote control to switch "DIGITAL AUDIO OUT" from "DOLBY DIGITAL/PCM" to "PCM ONLY".

- 1 Press **SET UP** to access the Main Menu screen.
- 2 Press **selection keys** to select "DVD VIDEO SET UP", then press **∇**.
- 3 Press **selection keys** to select "AUDIO OUTPUT", then press **∇**.
- 4 Press **selection keys** to select "DIGITAL AUDIO OUT", then press **ENTER**.
- 5 Press **selection keys** to select "PCM ONLY", then press **ENTER**. (pg. 71)
- 6 Press **SET UP** to complete the setting.
- 7 Press **AUDIO** to select the desired audio channel.

Mode Set

- Turn on the unit.
- Turn on the TV and select the AV mode.
- Slide the **TV/CABLE/SAT/DVD** switch to **DVD**.

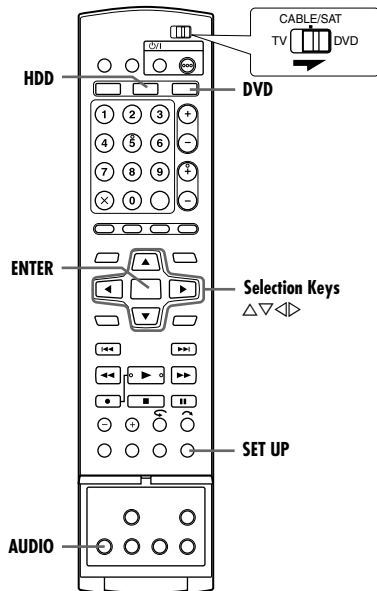

Various modes of this unit are categorized into menus nested in 2 levels shown in the following table. To change the settings of these modes, find the desired mode in the menu (for details on each menu, see pages 71 through 73), then follow the procedure below.

DVD VIDEO SET UP	LANGUAGE SET (pg. 22) AUDIO OUTPUT (See right column) PARENTAL LOCK (pg. 33) DISC PLAY SET UP (pg. 72)
HDD/DVD/DV SET UP	HDD SET UP (pg. 72) DVD SET UP (pg. 72) DISC SET UP (pg. 78, 79) DV SET UP (pg. 72)
FUNCTION SET UP	REC/PLAY SET UP (pg. 72) DISPLAY SET (pg. 73) VIDEO IN/OUT (pg. 23, 64)
INITIAL SET UP	TUNER SET (pg. 74) CLOCK SET (pg. 77)

- The procedure below shows how to set the desired option of the "AUDIO REC" mode as an example.

- 1 Press **HDD** or **DVD** so that the HDD or DVD lamp lights up on the unit.
- 2 Press **SET UP** to access the Main Menu screen.
- 3 Press **selection keys** to select "FUNCTION SET UP", then press ∇ .
- 4 Press **selection keys** to select "REC/PLAY SET UP", then press ∇ .
- 5 Press **selection keys** to select "AUDIO REC", then press **ENTER**.
- 6 Press **selection keys** to select the desired option, then press **ENTER**.
- 7 Press **SET UP** to complete the setting.

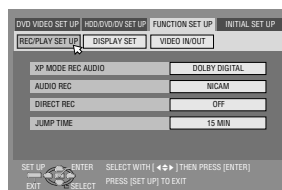

* The **boldface** settings below indicate the settings at your purchase.

AUDIO OUTPUT

■ DIGITAL AUDIO OUT — DOLBY DIGITAL/PCM / STREAM/PCM / PCM ONLY

Set to the appropriate mode according to the type of the device connected to [DIGITAL AUDIO OUT] connector.

DOLBY DIGITAL/PCM:

Select this when you connect the digital input connector of a Dolby Digital Decoder or an amplifier with a built-in Dolby Digital Decoder.

STREAM/PCM:

Select this when you connect the digital input connector of an amplifier with a built-in DTS, Dolby Digital, or MPEG multichannel decoder.

PCM ONLY:

Select this when you connect the linear PCM digital input of other audio equipment (amplifier, MD or DAT deck, etc.).

NOTES:

- This setting also functions when HDD is active.
- If you watch or play back a title which contains multiple audio languages, select "PCM ONLY" in advance and choose main or sub audio with **AUDIO**.

■ ANALOG AUDIO OUT — STEREO / DOLBY SURROUND

Select the appropriate setting to accommodate the unit to the connected A/V equipment. This function takes effect when a DVD VIDEO disc is played back.

STEREO:

Select this when listening to conventional two-channel stereo audio with the unit's [AUDIO OUT] connectors connected to a stereo amplifier/receiver or TV set, or in case you want to record the audio from a DVD VIDEO disc to a Mini Disc, etc.

DOLBY SURROUND:

Select this when listening to multichannel surround audio with the unit's [AUDIO OUT] connectors connected to an amplifier/receiver with a built-in surround decoder or a surround decoder.

■ D. RANGE CONTROL — NORMAL / WIDE RANGE / TV MODE

The dynamic range (the difference between the loudest sound and the quietest one) can be compressed during playback of a programme encoded in Dolby Digital format. This function takes effect when a DVD VIDEO disc recorded in Dolby Digital format is played back at low or middle volume.

NORMAL:

Normally select this setting to activate this function.

WIDE RANGE:

Select this to deactivate this function when you enjoy wide dynamic range programme.

TV MODE:

Select this when you hear the sound through the TV's speaker(s).

NOTES:

- This function has no effect on programmes other than those recorded in Dolby Digital format.
- This function does not work when Simulated Surround Effect is activated. (pg. 31)
- The effect of "NORMAL" and "WIDE RANGE" may not be different depending on discs.

■ OUTPUT LEVEL — STANDARD / LOW

You can lower the output level of analogue audio to accommodate the unit to the connected A/V equipment.

STANDARD:

Normally select this setting.

LOW:

The output level of analogue audio is lowered.

DISC PLAY SET UP**RESUME** — OFF / ON / DISC RESUME

When this function is set to "ON" or "DISC RESUME", you can use the resume function. (☞ pg. 26)

OFF:

You cannot use the resume function.

ON:

You can start playback from the resume point of the placed disc.

DISC RESUME:

The unit retains a memory of the resume points of the last 30 discs played back, even though they have been ejected.

NOTE:

"DISC RESUME" setting works on DVD VIDEO, VCD, SVCD and already finalised DVD-R/DVD-RW (video mode) discs. For other types of discs, the function under "ON" setting will be applied even if "RESUME" is set to "DISC RESUME".

HDD SET UP**LIVE MEMORY** — OFF / 30 MIN / 1 HR / 3 HR

When this function is set to "30 MIN", "1 HR" or "3 HR", you can apply the selected time length to "Temporary recording for Live Memory (HDD deck only)" (☞ pg. 45).

DVD SET UP**SAVE AS LIBRARY** — OFF / ON

When this function is set to "ON", the recording information is automatically stored in the library. For details, refer to "Navigate Library Information" (☞ pg. 56).

CONTINUOUS PLAY — OFF / ON

When this function is set to "ON", multiple titles on a disc are played back continuously one after another.

VIDEO MODE RECORDING ASPECT — PRIORITYZE 4:3 / PRIORITYZE 16:9

This is the setting for the aspect ratio used when you dub titles to DVD discs in video mode. If the titles you want to dub are recorded in both 16:9 and 4:3, you must select one aspect ratio.

PRIORITYZE 4:3:

If you select "PRIORITYZE 4:3", even a title recorded in 16:9 is dubbed in 4:3.

PRIORITYZE 16:9:

If you select "PRIORITYZE 16:9", even a title recorded in 4:3 is dubbed in 16:9.

VIDEO MODE RECORDING AUDIO — MAIN / SUB

This is the setting for the audio channel to be selected when dubbing titles to DVD discs in video mode. Select either one of the two settings if the titles to be dubbed have two audio channels.

MAIN:

Select this to dub the main channel.

SUB:

Select this to dub the sub channel.

MP3 & WMA / JPEG — MP3 & WMA / JPEG

You can select files to play back, when both MP3&WMA files and JPEG files are recorded on a disc.

MP3 & WMA:

Select this to play back MP3/WMA files.

JPEG:

Select this to play back JPEG files.

ATTENTION:

When **SET UP** is pressed while in the DV deck mode, the unit will switch to the previous deck mode (HDD or DVD). To proceed to DV deck after changing the settings in the "DV SET UP" menu, press **DV/HDD/DVD SELECT** on the unit repeatedly or **DV** on the remote control to select the DV deck.

DV SET UP**DV AUDIO REC** — 12BIT / 16BIT

This is the setting for sound mode before recording on a Mini DV tape.

12BIT:

Enables Audio Dubbing later.

16BIT:

Audio Dubbing is not possible but the recorded sound quality is higher than "12BIT".

AUDIO MODE — SOUND1 / SOUND2 / MIX

You can select the desired sound mode when playing back an audio dubbed Mini DV tape.

SOUND1:

Original recorded sound.

SOUND2:

Audio dubbed sound.

MIX:

Original recorded sound and audio-dubbed sound.

NOTES:

- When "AUDIO MODE" is set to "MIX", both the main and sub audio will be audible for bilingual tapes.
- To select only the main audio or only the sub audio of bilingual tapes, set "AUDIO MODE" to "SOUND1".

REC/PLAY SET UP**XP MODE REC AUDIO** — DOLBY DIGITAL / LINEAR PCM

You can select the audio format when you record a title in XP mode. When this function is set to "LINEAR PCM", you can obtain a high-quality audio sound.

DOLBY DIGITAL:

To record in Dolby Digital format.

LINEAR PCM:

To record in Linear PCM format.

AUDIO REC — NICAM / MONO

You can select the desired NICAM audio channel to be recorded on a DVD-R/RW (Video mode) disc.

NICAM:

To record the main and sub language of NICAM audio.

MONO:

To record the standard (monaural) sound of NICAM audio.

NOTE:

This function works only for the NICAM bilingual programme.

DIRECT REC — OFF / ON

When this function is set to "ON", you can easily start recording the programme that you are watching on your TV. While holding ●, press ► on the remote control, or press ● on the unit.

NOTES:

- When you use the Direct Rec function, be sure to use a TV offering T-V LINK, etc. and connect a fully-wired 21-pin SCART cable between the unit and the TV. (☞ pg. 18)
- If "DIRECT REC" is set to "OFF", the ● button functions as described in "Basic Recording" (☞ pg. 34, 37).
- During Direct Rec, "—" appears on the front display panel.
- If a programme is recorded with the Direct Rec, the station name will not be registered in the library. "----" will be displayed for the station name.
- Even if there is no power supply for more than 60 minutes, the unit keeps the setting.

■ JUMP TIME — 15 MIN / 30 MIN / 1 HR

You can locate a scene ahead of or behind the currently viewed one by jumping a selected time interval during playback (or Live Memory Playback). For details, refer to “Jump Search” (pg. 26, 40).

DISPLAY SET**■ SUPERIMPOSE — AUTO / OFF**

When this function is set to “AUTO”, various operational indicators appear on the TV screen.

AUTO:

To superimpose operational indications for approximately five seconds just after the corresponding operation.

OFF:

To turn off superimposed indications.

NOTES:

- When you use this unit as the source player for editing, be sure to set “SUPERIMPOSE” to “OFF” before starting. (pg. 63)
- When you select “AUTO”, during playback, the operation mode indicators may be disturbed depending on the type of disc being used.

■ BLUE BACK — OFF / ON

When this function is set to “ON”, the TV screen becomes all blue when receiving a channel not in use.

NOTE:

When you want to receive an unstable channel with poor signals, set this function to “OFF”.

■ DIMMER — BRIGHT / DIMMED

You can change the brightness of the front display panel.

BRIGHT:

Normally select this.

DIMMED:

To dim the front display panel. (Blue lamp on the front display panel is turned off.)

■ POWER SAVE — OFF / ON

When this function is set to “ON”, you can reduce the power consumption while the unit is turned off.

NOTES:

- During Power Save mode —
 - the front display panel will be turned off.
 - the Just Clock function (pg. 77) does not work.
- Power Save does not work when —
 - the unit is in the Timer mode.
 - the Automatic Satellite Programme Recording mode is engaged. (pg. 50)
 - “L-2 SELECT” is set to “DECODER”, “SAT VIDEO” or “SAT S-VIDEO”. (pg. 64)
- It takes some time for the unit to complete initialisation after you turn on the unit power, with “WAKE UP” blinking on the front display panel.

■ ON SCREEN LANGUAGE

This unit offers you the choice to view on-screen messages in 10 different languages. You can change the language setting manually as required.

VIDEO Plus+ System Setup

IMPORTANT:

Normally, Auto Set Up (pg. 19), Preset Download (pg. 20) or Auto Channel Set (pg. 74) sets the Guide Programme numbers automatically. You need to set the Guide Programme numbers manually only in the following cases.

- When timer programming with the VIDEO Plus+ system, the channel position, where the station you wish to record is received on your unit, is not selected, **OR** when you add a channel after Auto Set Up, Preset Download or Auto Channel Set has taken place, — Set the Guide Programme number for that station manually.
- When you wish to timer record a satellite programme with the VIDEO Plus+ system, — Set the Guide Programme numbers for all satellite broadcasts received on your satellite receiver.

- Turn on the unit.
- Turn on the TV and select the AV mode.
- Slide the **TV/CABLE/SAT/DVD** switch to **DVD**.

Guide Programme Number Set

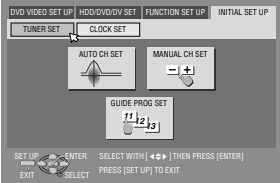
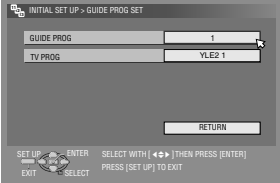
- 1 Press **SET UP** to access the Main Menu screen.
 - 2 Press **selection keys** to select "INITIAL SET UP", then press **▽**.
 - 3 Press **selection keys** to select "TUNER SET", then press **▽**.
 - 4 Press **selection keys** to select "GUIDE PROG SET", then press **ENTER**.
- 
- 5 Press **selection keys** to select "GUIDE PROG", then press **ENTER**.
 - 6 Press **selection keys** to select the Guide Programme number for the desired station as shown in the TV listings. Then press **ENTER**.
 - 7 Press **selection keys** to select "TV PROG", then press **ENTER**. Press **selection keys** to select the number of the unit's channel position on which the Guide Programme number's broadcast is received by the unit or the satellite receiver. Then press **ENTER**.
 - Repeat steps 5 – 7 as necessary.
 - 8 Press **SET UP** to complete the setting.
- 

Guide Programme Number

"Guide Programme (GUIDE PROG) number" refers to the assigned TV station numbers, according to broadcast area, for the VIDEO Plus+ timer recording. The Guide Programme Numbers can be found in most TV listings.

Tuner Set

Your unit needs to memorise all necessary stations in channel positions in order to record TV programmes. Auto Channel Set automatically assigns all receivable stations in your area to call them up by using the **PR +/-** buttons without going through any vacant channels.

- Turn on the unit.
- Turn on the TV and select the AV mode.
- Slide the **TV/CABLE/SAT/DVD** switch to **DVD**.

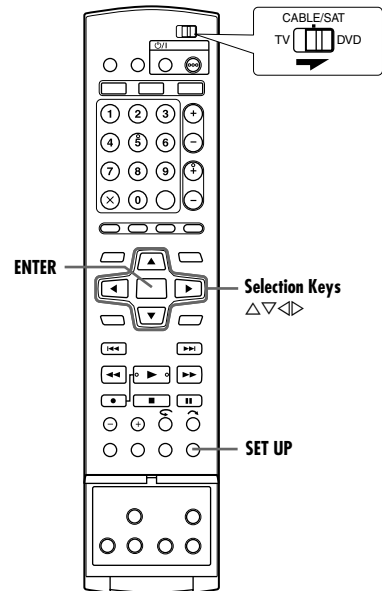

IMPORTANT:

Perform the following steps only if —
 — Auto Channel Set has not been set correctly by Auto Set Up or by Preset Download. (pg. 19, 20)
 — you have moved to a different area or if a new station starts broadcasting in your area.

Auto Channel Set

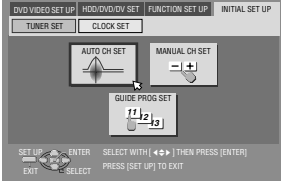
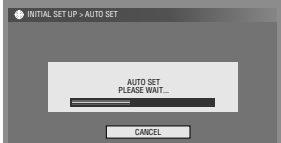
- 1 Press **SET UP** to access the Main Menu screen.
 - 2 Press **selection keys** to select "INITIAL SET UP", then press **▽**.
 - 3 Press **selection keys** to select "TUNER SET", then press **▽**.
 - 4 Press **selection keys** to select "AUTO CH SET", then press **ENTER**.
 - When you have connected the unit to a TV offering T-V Link via a fully-wired 21-pin SCART cable (pg. 18), the unit automatically performs the Preset Download and the T-V LINK screen will appear. (pg. 20)
 - The Auto Set screen appears, and remains on screen while the unit searches for receivable stations.
- 
- 

- 5 View the Confirmation screen. "AUTO SET COMPLETED" or "SCAN COMPLETED" is displayed on the TV screen. Select "OK".
- 6 Press **SET UP** to complete the setting.
 - Using the Confirmation screen, you can skip or add channel positions, enter station names and perform other operations. Refer to pages 75 – 76 for the procedures.
 - Depending on reception conditions, the stations may not be stored in order, and the station names may not be stored correctly.

IMPORTANT:

- In certain reception conditions, station names may not be stored correctly, and Auto Guide Programme Number Set may not work properly. When the Guide Programme numbers are not set properly, the programme that you do not intend to record will be timer recorded by the VIDEO Plus+ system of the unit. When programming the timer using the VIDEO Plus+ system, be sure to check the desired channel is selected correctly. (pg. 46)
- Your unit memorises all receivable stations even if reception of some of them is poor. You can delete those stations with an unacceptable picture from the list. (pg. 76, "Delete A Channel")

NOTES:

- Fine tuning is performed automatically during Auto Channel Set. If you want to perform tuning manually, refer to "Fine-Tuning Channels Already Stored" (pg. 76).
- If you perform Auto Channel Set when the aerial cable is not connected properly, "SCAN COMPLETED –NO SIGNAL–" appears on the TV screen in step 5. In such a case, make sure of the aerial connection and press **ENTER**; Auto Channel Set will start again.

Manual Channel Set

Store channels that were not stored during Auto Set Up (pg. 19), Preset Download (pg. 20) or Auto Channel Set (pg. 74).

- 1 Press **SET UP** to access the Main Menu screen.
- 2 Press **selection keys** to select "INITIAL SET UP", then press ∇ .
- 3 Press **selection keys** to select "TUNER SET", then press ∇ .
- 4 Press **selection keys** to select "MANUAL CH SET", then press **ENTER**. The Manual Channel Set screen appears.
- 5 Press **selection keys** to select "EDIT", then press **ENTER**.
- 6 Press **selection keys** to select a blank position in which you want to store a channel, then press **ENTER**. The Confirmation screen appears.
- 7 Press **selection keys** to select "BAND", then press **ENTER**.

(Example) To store in position 6.

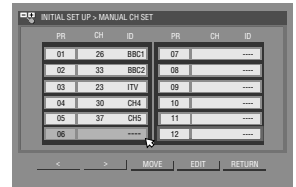

The programme currently received on the selected channel position appears behind the confirmation screen.

- 8 Press **selection keys** to change the band between CH (regular) and CC (cable), then press **ENTER**.
- 9 Press **selection keys** to select "CH", then press **ENTER**.
- 10 Press **selection keys** to input the channel number you want to store.
 - To enter the registered station name (pg. 88), press **selection keys** to select "ID", then press **ENTER**. Press $\Delta \nabla$.
 - For fine tuning adjustment, press **selection keys** to select "FINE", then press **ENTER**. Press $\Delta \nabla$ to perform fine-tuning.
 - When "L-2 SELECT" is set to "VIDEO", "S-VIDEO", "SAT VIDEO" or "SAT S-VIDEO", the "DECODER" setting cannot be changed. (pg. 64)
- 11 Press **ENTER** to enter new channel information. The Confirmation screen appears.
- 12 Press **SET UP** or **RETURN** to close the Confirmation screen.
 - To change positions, see "Change Station Channel Position" (pg. 76).
 - If you wish to set station names other than the ones registered in your unit, see "Set Stations (B)" (pg. 76).

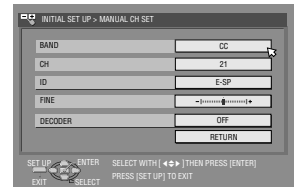
**ATTENTION:**

Guide Programme numbers are not set when channels are stored manually. (pg. 74, "VIDEO Plus+ System Setup")

Delete A Channel

- 1 Perform steps 1 – 5 of “Manual Channel Set” (pg. 75).
- 2 Press **selection keys** to select the channel you want to delete.
- 3 Press **CANCEL**(X) to delete a channel. The channel next to the cancelled one moves up one line.
 - Repeat steps 2 – 3 as necessary.
- 4 Press **SET UP** or **RETURN** to close the Confirmation screen.

Change Station Channel Position

- 1 Perform steps 1 – 4 of “Manual Channel Set” (pg. 75).
- 2 Press **selection keys** to select “MOVE”, then press **ENTER**.
- 3 Press **selection keys** to select the channel you want to move, then press **ENTER**.
- 4 Press **selection keys** to select the new channel position, then press **ENTER**.

Example: If you moved the station in position 4 to position 2, the stations originally in positions 2 and 3 each move down one space.

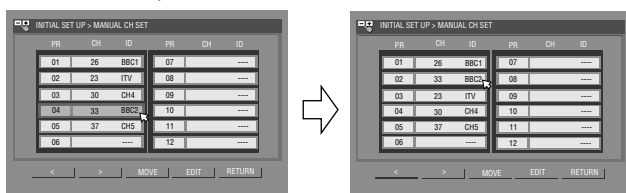

- Repeat steps 3 – 4 as necessary.
- 5 Press **SET UP** or **RETURN** to close the Confirmation screen.

Set Stations (A)

Set station names that are registered in your unit.

- 1 Perform steps 1 – 5 of “Manual Channel Set” (pg. 75).
- 2 Press **selection keys** to select the channel you want to modify, then press **ENTER**. The Confirmation screen appears.
- 3 Press **selection keys** to select “ID”, then press **ENTER**.
- 4 Move the arrow to the left ID selection column. Registered station names (ID) (pg. 88) appear as you press $\Delta \nabla$.
- 5 Press **ENTER** to select the desired ID, then press **ENTER** again to select “OK”.
- 6 Press **RETURN** to return to the Manual Channel Set screen.
 - Repeat steps 2 – 5 as necessary.
- 7 Press **SET UP** or **RETURN** to close the Confirmation screen.

Set Stations (B)

Set station names other than the ones registered in your unit.

- 1 Perform steps 1 – 5 of “Manual Channel Set” (pg. 75).
- 2 Press **selection keys** to select the channel you want to modify, then press **ENTER**. The Confirmation screen appears.
- 3 Press **selection keys** to select “ID”, then press **ENTER**.
- 4 Press **selection keys** to select the desired characters (A–Z, 0–9, -, *, +, _ (space)), then press **ENTER**.
 - Enter the remaining characters the same way (maximum of 4).
- 5 After entering all characters, press **selection keys** to select “OK”, then press **ENTER**.
- 6 Press **RETURN** to return to the Manual Channel Set screen.
 - Repeat steps 2 – 5 as necessary.
- 7 Press **SET UP** or **RETURN** to close the Confirmation screen.

NOTE:

The characters available for the station name (ID) are A–Z, 0–9, -, *, +, _ (space) (maximum of 4).

Fine-Tuning Channels Already Stored

- 1 Perform steps 1 – 5 of “Manual Channel Set” (pg. 75).
- 2 Press **selection keys** to select the channel you want to fine-tune, then press **ENTER**. The Confirmation screen appears.
- 3 Press **selection keys** to select “FINE”, then press **ENTER**.
- 4 Press $\Delta \nabla$ until the picture appears in its best quality, then press **ENTER**.
 - Repeat steps 2 – 4 as necessary.
- 5 Press **RETURN** to return to the Manual Channel Set screen.
- 6 Press **SET UP** or **RETURN** to close the Confirmation screen.

Clock Set

IMPORTANT:

If you performed Auto Set Up (pg. 19) or Preset Download (pg. 20), without ever having set the clock previously, the unit's built-in clock is also set automatically.

Perform the following steps only if —

— Auto Clock Set has not been performed correctly by Auto Set Up or Preset Download.

OR

— you want to change Just Clock setting. (See "Just Clock" in the right column)

- Turn on the unit.
- Turn on the TV and select the AV mode.
- Slide the TV/CABLE/SAT/DVD switch to DVD.

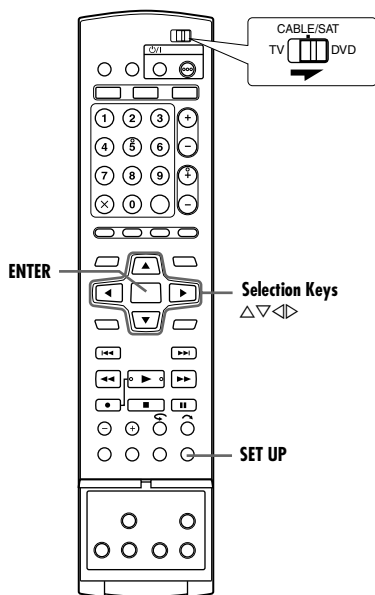

- 1 Press **SET UP** to access the Main Menu screen.
- 2 Press **selection keys** to select "INITIAL SET UP", then press ∇ .
- 3 Press **selection keys** to select "CLOCK SET", then press ∇ .
- 4 Press **selection keys** to select "YEAR", then press **ENTER**. Press **selection keys** to set the year, then press **ENTER**.
 - Repeat the same procedure to set the date and time.
 - When you set the date, press and hold $\Delta \nabla$ to change the date by 15-day intervals.
 - When you set the time, press and hold $\Delta \nabla$ to change the time by 30-minute intervals.
- 5 Press **selection keys** to select "JUST CLOCK", then press **ENTER**. Press **selection keys** to set to the desired mode, then press **ENTER**.
 - The default setting is "OFF".
 - For the Just clock function, refer to "Just Clock" on the right column.
 - If you set to "OFF", you can disregard the next step as you won't be able to receive regular clock adjustments.

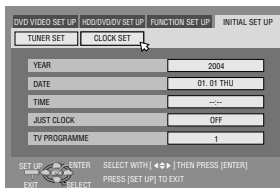

- 6 Press **selection keys** to select "TV PROGRAMME", then press **ENTER**. Press **selection keys** to set the channel position to the number representing the station transmitting clock setting data, then press **ENTER**.
 - The unit is preset to receive clock setting and adjustment data from channel position 1.

- 7 Press **SET UP** to start the clock operation.

NOTES:

- Just Clock (when set to "ON") adjusts the unit's built-in clock every hour, except for 23:00, 0:00, 1:00 and 2:00.
- Just Clock is not effective when:
 - the unit's power is on.
 - the unit is in the Timer mode.
 - a difference of more than 3 minutes exists between the built-in clock's time and the actual time.
 - the unit is in the Automatic Satellite Programme Recording mode. (pg. 50) (HDD deck only)
 - the unit is in the Power Save mode. (pg. 73)
 - "L-2 SELECT" is set to "SAT VIDEO" or "SAT S-VIDEO". (pg. 64)
- If Just Clock is set to "ON", the unit's clock is automatically adjusted at the start/end of Summer Time.
- Just Clock may not function properly depending on the reception condition.

Just Clock

The Just Clock function provides accurate time keeping through automatic adjustments at regular intervals, by reading data from a PDC signal.

The Just Clock option can be set to "ON" or "OFF" at the Clock Set screen (the default setting is "OFF").

IMPORTANT:

If you turn off Just Clock, the accuracy of your unit's built-in clock may be reduced, which could adversely affect timer recording. We recommend you to keep Just Clock on. In cases where the clock setting data from a PDC signal is incorrect, however, you are advised to keep Just Clock set to "OFF".

Format A Disc (DVD Deck Only)



Some DVD-RAM/RW discs are unformatted. Format the disc when you use an unformatted disc or you want to delete all recordings and data on the disc.

ATTENTION:

- When a disc is formatted, all recordings and data are erased. It is impossible to restore them.
- Never turn off the unit or disconnect the mains power cord while “NOW FORMATTING...” is displayed on the TV screen.

- Turn on the unit.
- Turn on the TV and select the AV mode.
- Slide the **TV/CABLE/SAT/DVD** switch to **DVD**.
- Load a DVD-RAM/RW disc to format.

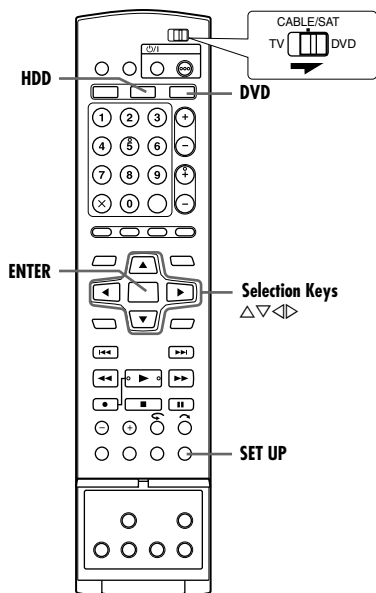

Format A DVD-RAM Disc

- 1 Press **HDD** or **DVD** so that the HDD or DVD lamp lights up on the unit.
- 2 Press **SET UP** to access the Main Menu screen.
- 3 Press **selection keys** to select “HDD/DVD/DV SET UP”, then press ∇ .
- 4 Press **selection keys** to select “DISC SET UP”, then press ∇ .
- 5 Press **selection keys** to select “FORMAT”, then press **ENTER**. Press **selection keys** to select “OK”, then press **ENTER**.
- 6 Press **selection keys** to select “EXECUTE”, then press **ENTER**.

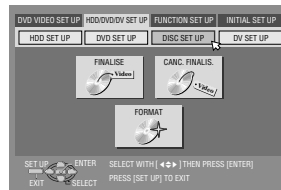

Format A DVD-RW Disc

- 1 Perform steps 1 to 4 of “Format A DVD-RAM Disc” as above before continuing.
- 2 Press **selection keys** to select “FORMAT”, then press **ENTER**. Press **selection keys** to choose “VR MODE” or “VIDEO MODE”, then press **ENTER** when “DISC WILL BE FORMATTED” appears on the TV screen.

“VR MODE”:
To be chosen when you want to record, erase, or edit data on the disc repeatedly.

“VIDEO MODE”:
To be chosen when you want to erase all the data on the disc once played back to record new data, or play back the disc on other DVD players.
- 3 Press **selection keys** to select “EXECUTE”, then press **ENTER**.

NOTES:

- It is impossible to format Version 1.0 DVD-RW discs in Video mode.
- It is impossible to format DVD-R discs.
- All the titles on a disc will be deleted once the disc is formatted even if they are protected titles. (pg. 53)

Finalise A Disc (DVD Deck Only)



Finalising DVD-R/RW discs recorded on this unit makes it possible for the discs to be played back on other DVD players. DVD-RW discs are finalised in the mode that the discs were formatted, enabling playback on compatible DVD players. Title names input in the Library Database Navigation are registered as title names in the DVD menu. (pg. 52)

- Turn on the unit.
- Turn on the TV and select the AV mode.
- Slide the **TV/CABLE/SAT/DVD** switch to **DVD**.
- Load a DVD-R/RW disc to finalise.

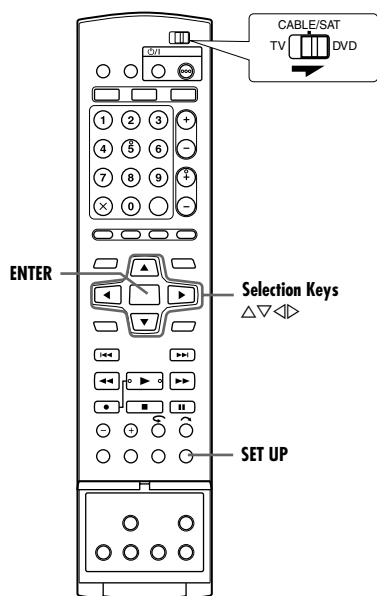

Before finalising

- It is possible to record on a blank space.
- It is possible to enter title names. (pg. 52)
- It is possible to delete titles. (pg. 53)
- It is impossible to overwrite recorded areas of DVD-R discs.
- Available recording capacity does not increase even if a recorded title is deleted from a DVD-R disc.
- It is impossible to record or edit DVD-R/RW discs recorded on other devices even if they have not been finalised.

After finalising (For DVD-R/RW (Video mode) discs)

- Video and audio that have been recorded by then are recorded in conformity to the DVD Video standard, enabling you to play back the discs as DVD VIDEO discs.
- Although DVD-R/RW discs finalised on this unit become playable on DVD players compatible with DVD-R/RW discs, some discs still may not play, for which JVC cannot take responsibility.
- Marked points marked before finalising will be deleted, and titles will be divided automatically into "chapters" approximately every 5 minutes. (pg. 27)
- Depending on the DVD players and DVD-R/RW discs used, and on the conditions of recording, it may not be possible to play back the discs. In this case, play back the discs on this unit.
- Additional recordings become impossible.

Finalise A DVD-R/RW Disc

- 1** Perform steps 1 to 4 of "Format A DVD-RAM Disc" (pg. 78) before continuing.
- 2** Press **selection keys** to select "FINALISE", then press **ENTER**.
 - For DVD-R/RW (Video mode) discs, the background selection screen will appear. Press **selection keys** to select the desired background from a selection of 18 backgrounds, then press **ENTER**.
- 3** Press **selection keys** to select "OK", then press **ENTER**.
- 4** Upon completing finalisation, "COMPLETED" appears on the TV screen. Press **ENTER** to end.
- 5** Press **SET UP** to return to the normal screen.
 - Menu screen is cleared.
 - Once a DVD-R/RW (Video mode) disc has been finalised, the displays for original and play list do not appear. Only display for library appears.
 - Once a DVD-RW (VR mode) disc has been finalised, it can be played on DVD players compatible with VR mode.

Cancel The Finalisation Of A DVD-RW Disc

- 1** Load a DVD-RW disc to cancel the disc finalisation, and perform steps 1 to 4 of "Format A DVD-RAM Disc" (pg. 78) before continuing.
- 2** Press **selection keys** to select "CANC. FINALIS.", then press **ENTER**.
- 3** Press **selection keys** to select "EXECUTE", then press **ENTER**.
- 4** Upon completing cancellation of finalisation, "CANCELLATION COMPLETED" appears on the TV screen. Press **ENTER** to end.
- 5** Press **SET UP** to return to the normal screen.
 - When the disc finalisation is cancelled, the mode in which the disc was formatted is restored, making the disc recordable. (pg. 8, 78)

Scan Mode Set (HDD & DVD Deck Only)

If you connect the unit and TV with Component Video Connection (pg. 18), you can select the scan mode from two modes: Interlaced scan mode which is used in the conventional TV system, and Progressive scan mode which enables reproduction of higher-quality images.

Interlaced scan

In the conventional video system, a picture is shown on the display monitor in two halves. The Interlaced scan system places lines of the second half of the picture in-between lines of the first half of the picture.

Progressive scan

Progressive scan displays all the horizontal lines of a picture at one time, as a single frame. This system can convert the interlaced video from DVD into progressive format for connection to a progressive display. It dramatically increases the vertical resolution.

ATTENTION:

Your TV needs to be compatible with PAL Progressive.

- Turn on the unit.
- Turn on the TV and select the AV mode.
- Slide the **TV/CABLE/SAT/DVD** switch to **DVD**.

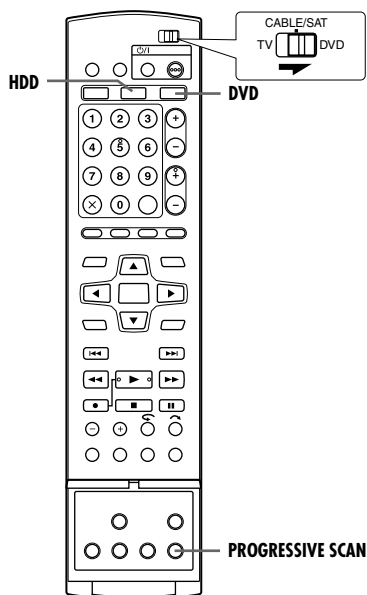

1 Press **HDD** or **DVD** so that the HDD or DVD lamp lights up on the unit.

2 Press **PROGRESSIVE SCAN** for 3 or more seconds.

- Video output indicator (P) lights on the front display panel if Progressive scan mode has been established. (pg. 13)
- Each press of **PROGRESSIVE SCAN** for 3 or more seconds switches the scan mode.

NOTES:

- When the progressive mode is set, be sure to set "L-1 OUTPUT" to "COMPONENT" (pg. 64). Progressive scan is output only from [COMPONENT VIDEO OUT] connector.
- Interlaced scan mode is the setting at your purchase.
- Interlaced scan mode might be suitable depending on video material.
- Scan mode cannot be set while menu screen is displayed.
- When the Progressive scan mode is engaged, no video signal is output from [L-1 IN/OUT] connector.

Tray Lock (DVD Deck Only)

You can lock the disc tray to prohibit the unwanted disc ejection by children.

- Turn off the unit.

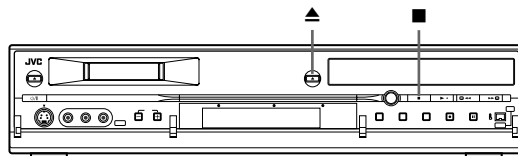

To lock tray

While the unit is turned off, press and hold ■, then press ▲ on the unit. "LOCK" appears on the front display panel and the disc tray is locked.

To unlock tray

While the unit is turned off, press and hold ■, then press ▲ on the unit. "UNLOCK" appears on the front display panel.

Before requesting service for a problem, use this chart and see if you can solve the trouble yourself. Small problems are often easily solved, and this can save you the trouble of sending your unit off for repair.

Initialising (DVD Deck Only)

Malfunction occurs on the unit.

- Press \odot /I to turn off the unit, press and hold \odot /I, then press ■ for two seconds or more.

General

No power is supplied to the unit.

- The AC power plug is disconnected from the mains outlet.
- Connect the AC power plug to the mains outlet securely. (☞ pg. 18)

The remote control does not work properly.

- Remove the batteries, wait for 5 minutes or more, then load the batteries again.
- The setting of the remote control code is inappropriate.
- Set the same remote control code (1, 2, 3, or 4) on both the unit and the remote control. (☞ pg. 68)
- The batteries are discharged.
- Replace the dead batteries with new ones.

Dubbing from the external equipment is not possible.

- The source (another video recorder, camcorder) has not been properly connected.
- Confirm that the source is properly connected.
- All necessary power switches have not been turned on.
- Confirm that all units' power switches are turned on.
- The setting of the input channel position is inappropriate.
- Select the input channel position ("F-1", "L-1" or "L-2") that corresponds to the input terminal connected to the external equipment. (☞ pg. 63)

The on-screen display superimposed on the programme played back/received on this unit is recorded when you dub the programme to an external recording equipment.

- Set "SUPERIMPOSE" to "OFF". (☞ pg. 73)

The unit does not operate.

- There are cases when the operation is prohibited on the disc.
- Lightning or static electricity may cause malfunction of the unit.
- Press \odot /I to turn the power off, then press the button again to turn the power on.

The remote control of a JVC TV will not operate the unit.

- The setting of the remote control code is inappropriate.
- To operate the unit using a JVC TV remote control, set the remote control code of the unit to "1" (Default: "3"). (☞ pg. 68)

Playback (DVD Deck)

The DVD deck cannot be operated.

- The DVD deck is not selected.
- Press **DV/HDD/DVD SELECT** on the unit repeatedly or **DVD** on the remote control so that the DVD lamp lights up on the unit.

Images do not appear on the TV screen.

- The TV receiver's channel selector is not set to the AV mode.
- Set the TV to its AV mode.
- When interlace scanned programme is played back, progressive scan mode is selected.
- Press and hold **PROGRESSIVE SCAN** until **P** disappears from the front display panel. (☞ pg. 80)

Playback does not start or stop immediately after playback is started by pressing ►. On the front display panel, "NO DISC" appears.

- The disc is loaded upside down.
- Place the disc on the disc tray with the playback surface facing down. (☞ pg. 9)
- A disc not being compatible with the unit is loaded.
- Load a playable disc on the unit. (☞ pg. 6)
- A dirty disc is loaded.
- Clean the disc. (☞ pg. 10)
- Defective disc is loaded.
- Replace the warped or scratched disc with a normal one.

Images are blurred or distorted when you start High-Speed Search.

- Images are blurred or distorted at the point where the playback speed changes and this is not a malfunction of the unit.

Playback does not start.

- Playback does not start for approximately 30 seconds after recording is stopped and this is not a malfunction of the unit.

Playback does not start when you select a title or a chapter.

- The Parental Lock is engaged and the disc is rated higher than the set level.
- Release the Parental Lock temporarily or change the set level. (☞ pg. 33)

Playback (HDD Deck)

The HDD deck cannot be operated.

- The HDD deck is not selected.
- Press **DV/HDD/DVD SELECT** on the unit repeatedly or **HDD** on the remote so that the HDD lamp lights up on the unit.

Playback (DV Deck)

The DV deck cannot be operated.

- The DV deck is not selected.
- Press **DV/HDD/DVD SELECT** on the unit repeatedly or **DV** on the remote control so that the DV lamp lights up on the unit.

The tape will not rewind or fast-forward.

- The tape is already fully rewound or fast-forwarded.
- Check the cassette.

The playback picture does not appear while the tape is running.

- The TV is not set to the AV mode.
- Set the TV to the AV mode.

Noise appears during visual search.

- This is normal.

The playback picture is blurred or interrupted while TV broadcasts are clear or "USE CLEANING CASSETTE" message appears on the screen.

- The video heads may be dirty.
- Use a dry cleaning cassette M-DV12CL, or consult your JVC dealer.

Recording (DVD Deck)

The desired programme cannot be recorded.

- The channel position does not correspond to that in the receiving area.
- Set the correct channel position for the receiving broadcast. (pg. 74)

Recording cannot be made.

- No disc or a disc not being compatible with the unit is loaded.
- Load a recordable disc on the unit. (pg. 6)
- The disc loaded is not formatted.
- Format the disc. (pg. 78)
- A finalised DVD-R disc is loaded.
- Recording cannot be made on finalised discs. Load a recordable disc on the unit.
- The disc is full or does not have enough space for the title to be recorded.
- Clear unnecessary titles on the disc or load a blank disc. (pg. 53)
- The DVD-RAM disc loaded has had its protect tab slid to the protect position.
- Release the protect tab. (pg. 9)

Recording (HDD Deck)

TV broadcasts cannot be recorded.

- "L-1", "L-2" or "F-1" has been selected as the input mode.
- Set to the desired channel.

Camcorder recording is not possible.

- The camcorder has not been properly connected.
- Confirm that the camcorder is properly connected.
- The input mode is not correct.
- Set the input mode to "F-1". (pg. 62)

Recording (DV Deck)

During recording, the tape does not run. The DV recording lamp lights up on the unit.

- The unit is in the Record Pause mode.
- Press **▶** to resume recording.

Recording cannot be done.

- There is no cassette loaded, or the cassette loaded has had its erase protection switch set to "SAVE".
 - Insert a Mini DV cassette, or set the erase protection switch set to "REC".
 - An attempt has been made to record from this unit's built-in tuner.
 - It is not possible to record from this unit's built-in tuner to the DV deck. Record to the HDD or a DVD disc.
- If you want to record on a DV tape, record by connecting the output of the external equipment such as a satellite receiver to this unit's external input ([L-2 IN/DECODER], etc.).

Camcorder recording is not possible.

- The camcorder has not been properly connected.
- Confirm that the camcorder is properly connected.
- The input mode is not correct.
- Set the input mode to "F-1" or "DV".

The tape is automatically rewound, then the unit is shut off.

- The end of the tape was reached during recording.
- The programme may not have been recorded in its entirety. Next time make sure you have enough time on the tape to record the entire programme.

Audio dubbing is not possible.

- "DV AUDIO REC" had been set to "16BIT" at the original recording.
- Set "DV AUDIO REC" to "12BIT" at the original recording.
- The tape speed had been set to LP at the original recording.
- Set the tape speed to SP at the original recording.

Monitoring the audio dubbed sound is not possible during audio dubbing.

- This is normal. Monitor the sound using the connected devices.

Timer Recording (HDD & DVD Deck)

Timer programming cannot be made.

- Date and time is not correct.
- Set date and time correctly. (☞ pg. 77)
- Timer recording is in progress.
- Timer programming can't be performed while a timer recording is in progress. Wait until it finishes.

Timer programming recording does not start.

- Date and time is not correct.
- Set date and time correctly. (☞ pg. 77)

VIDEO Plus+ Timer Programming cannot be made.

- Date and time set on the unit is not correct.
- Set date and time correctly. (☞ pg. 77)
- The channel position does not correspond to that in the receiving area.
- Set the correct channel position for the receiving broadcast. (☞ pg. 74)

The VIDEO Plus+ system does not timer record properly.

- The unit's channel positions have been set incorrectly.
- Refer to "VIDEO Plus+ System Setup" (☞ pg. 74) and reperform the procedure.

Automatic Satellite Programme Recording does not start.

- The satellite receiver is not connected properly to this unit.
- Connect the satellite receiver to the [L-2 IN/DECODER] connector properly. (☞ pg. 50)

On the front display panel, " - :- - " appears.

- Power failure occurred.
- Set date and time correctly. (☞ pg. 77)

"PROGRAMME FULL" appears on the TV screen during timer programming.

- 16 programmes have already been timer programmed.
- Clear unnecessary programmes on the unit, then try timer programming again. (☞ pg. 49)

The disc space does not increase when recorded titles are cleared.

- The PC's data recorded on a DVD-RAM drive cannot be cleared on this unit.
- Format the disc. (When the disc is soiled, wipe the disc with a soft dry cloth before formatting.) (☞ pg. 10, 78)

Other Problems

The image of the TV broadcast appears distorted on the TV screen.

For basic connection

- Press **PROGRESSIVE SCAN** for 3 or more seconds so that the Video output indicator (**P**) lights off on the front display panel.

For component video connection

- Press **PROGRESSIVE SCAN** for 3 or more seconds so that the Video output indicator (**P**) lights up on the front display panel.

Whistling or howling is heard from the TV during camcorder recording.

- The camcorder's microphone is too close to the TV.
- Position the camcorder so its microphone is away from the TV.
- The TV's volume is too high.
- Turn the TV's volume down.

When scanning channels, some of them are skipped over.

- Those channels have been designated to be skipped.
- If you need the skipped channels, restore them. (☞ pg. 75)

The channel cannot be changed.

- Recording or RetroActive Recording* is in progress.
- Press **II** to pause recording, change the channel, then press **▶** to resume recording.
- * HDD deck only

Channel settings that were made manually seem to have changed or disappeared.

- After the manual settings were made, Auto Channel Set was performed.
- Perform "Clock Set" (☞ pg. 77).

Malfunction occurs and the unit cannot be power off.

- Reset the unit by disconnecting the AC power plug from the AC outlet and connect again.

On-screen Message (HDD & DVD Deck Only)**DISC NOT REGISTERED IN THE LIBRARY
REGISTER DISC?**

- A disc that is not registered in the library has been inserted. Register the disc as necessary. (pg. 56)

INSERT DISC XXXX

- Appears when a title that has been selected in the library is not contained in the loaded disc.

**CAN NOT RECORD OR MAKE PLAY LIST
DELETE UNWANTED TITLES**

- Recording and/or editing cannot be performed.
- The number of titles exceeds 99.
- The number of play lists exceeds 99.

SET CLOCK BEFORE TIMER PROGRAMMING

- To set the timer programme, the clock must be set in advance. (pg. 77)

**PROGRAMME FULL
DELETE UNWANTED TIMER PROGRAMMES**

- You can programme this unit to timer record as many as 16 programmes. To programme more, you need to cancel a timer programme already set. (pg. 49)

DISC NOT LOADED

- Operation has been attempted when a disc is not loaded, or loaded upside down. (pg. 9)

**DISC NOT RECORDABLE
INSERT RECORDABLE DISC**

- When a playback-only disc or a finalised disc is loaded, has been pressed. (pg. 6)

**PLUSCODE NO. ERROR
CONFIRM PLUSCODE NO. THEN RETRY**

- An invalid PlusCode number has been input. (pg. 46)

**GUIDE PROGRAM IS NOT SET
SET GUIDE PROGRAM THEN RETRY**

- To set the timer programme using the VIDEO Plus+ system, the Guide Programme Number must be set in advance. (pg. 74)

**CAN NOT SET VIDEO PLUS+ TIMER PROGRAMMING
DURING TIMER RECORDING OR INSTANT TIMER
RECORDING**

- Appears when you tried to input a PlusCode number during timer recording or instant timer recording.

**REGION CODE ERROR
CHECK DISC**

- A disc loaded cannot be played back on this unit since the region number of the disc does not match that of the unit. (pg. 7)

**UNREADABLE DISC
CHECK DISC**

- When an incompatible disc is loaded, has been pressed. (pg. 7)

**COULD NOT FORMAT THE DISC
CHECK THE DISC**

- Formatting is not complete since the disc may be dirty or damaged. Take out the disc, clean it and retry. (pg. 10, 78)

CAN NOT FINALISE THIS DISC

- Finalising is not complete since the disc may be dirty or damaged. Take out the disc, clean it and retry. (pg. 10, 79)

CAN NOT CANCEL FINALISATION OF THIS DISC

- Cancelling disc finalisation is not complete since the disc may be dirty or damaged. Take out the disc, clean it and retry. (pg. 10, 79)

PRESS [STOP] AGAIN TO STOP RECORDING

- During Live Memory playback, has been pressed. (pg. 44)

TIMER RECORDING COMPLETED

- Timer recording has finished during Live Memory playback.

**PLAYBACK WILL STOP
THEN TIMER RECORDING WILL START**

- Timer recording finished during Live Memory playback, then the next timer recording is about to begin while playback continues.

**COPY PROHIBITED
CAN NOT RECORD**

- An attempt has been made to record copy-protected contents.
- An attempt has been made to record copy-once contents on a disc that is not CPRM compatible, such as DVD-R.

**COPY PROHIBITED
CAN NOT PLAY**

- The unit has detected invalid contents at the start or in the middle of playback.

**THE i.LINK DEVICE THAT YOU HAVE CONNECTED IS NOT
RECOGNIZED
MAKE SURE THAT THE DEVICE IS CONNECTED PROPERLY
AND POWERED ON**

- An attempt has been made to start DV dubbing when a digital video camera is not properly connected to the unit.
- Check the connection. (pg. 61)

Language Code List

AA	Afar	IK	Inupiak	RN	Kirundi
AB	Abkhazian	IN	Indonesian	RO	Rumanian
AF	Afrikaans	IS	Icelandic	RU	Russian
AM	Ameharic	IW	Hebrew	RW	Kinyarwanda
AR	Arabic	JI	Yiddish	SA	Sanskrit
AS	Assamese	JW	Javanese	SD	Sindhi
AY	Aymara	KA	Georgian	SG	Sangho
AZ	Azerbaijani	KK	Kazakh	SH	Serbo-Croatian
BA	Bashkir	KL	Greenlandic	SI	Singhalese
BE	Byelorussian	KM	Cambodian	SK	Slovak
BG	Bulgarian	KN	Kannada	SL	Slovenian
BH	Bihari	KO	Korean (KOR)	SM	Samoan
BI	Bislama	KS	Kashmiri	SN	Shona
BN	Bengali, Bangla	KU	Kurdish	SO	Somali
BO	Tibetan	KY	Kirghiz	SQ	Albanian
BR	Breton	LA	Latin	SR	Serbian
CA	Catalan	LN	Lingala	SS	Siswati
CO	Corsican	LO	Laothian	ST	Sesotho
CS	Czech	LT	Lithuanian	SU	Sundanese
CY	Welsh	LV	Latvian, Lettish	SW	Swahili
DZ	Bhutani	MG	Malagasy	TA	Tamil
EL	Greek	MI	Maori	TE	Telugu
EO	Esperanto	MK	Macedonian	TG	Tajik
ET	Estonian	ML	Malayalam	TH	Thai
EU	Basque	MN	Mongolian	TI	Tigrinya
FA	Persian	MO	Moldavian	TK	Turkmen
FJ	Fiji	MR	Marathi	TL	Tagalog
FO	Faroese	MS	Malay (MAY)	TN	Setswana
FY	Frisian	MT	Maltese	TO	Tonga
GA	Irish	MY	Burmese	TR	Turkish
GD	Scots Gaelic	NA	Nauru	TS	Tsonga
GL	Galician	NE	Nepali	TT	Tatar
GN	Guarani	OC	Occitan	TW	Twi
GU	Gujarati	OM	(Afan) Oromo	UK	Ukrainian
HA	Hausa	OR	Oriya	UR	Urdu
HI	Hindi	PA	Panjabi	UZ	Uzbek
HR	Croatian	PL	Polish	VI	Vietnamese
HU	Hungarian	PS	Pashto, Pushto	VO	Volapuk
HY	Armenian	PT	Portuguese	WO	Wolof
IA	Interlingua	QU	Quechua	XH	Xhosa
IE	Interlingue	RM	Rhaeto-Romance	YO	Yoruba
				ZU	Zulu

Country/Area Code List for Parental Lock

AD	Andorra	CK	Cook Islands	GN	Guinea
AE	United Arab Emirates	CL	Chile	GP	Guadeloupe
AF	Afghanistan	CM	Cameroon	GQ	Equatorial Guinea
AG	Antigua and Barbuda	CN	China	GR	Greece
AI	Anguilla	CO	Colombia	GS	South Georgia and the South Sandwich Islands
AL	Albania	CR	Costa Rica	GT	Guatemala
AM	Armenia	CU	Cuba	GU	Guam
AN	Netherlands Antilles	CV	Cape Verde	GW	Guinea-Bissau
AO	Angola	CX	Christmas Island	GY	Guyana
AQ	Antarctica	CY	Cyprus	HK	Hong Kong
AR	Argentina	CZ	Czech Republic	HM	Heard Island and McDonald Islands
AS	American Samoa	DE	Germany	HN	Honduras
AT	Austria	DJ	Djibouti	HR	Croatia
AU	Australia	DK	Denmark	HT	Haiti
AW	Aruba	DM	Dominica	HU	Hungary
AZ	Azerbaijan	DO	Dominican Republic	ID	Indonesia
BA	Bosnia and Herzegovina	DZ	Algeria	IE	Ireland
BB	Barbados	EC	Ecuador	IL	Israel
BD	Bangladesh	EE	Estonia	IN	India
BE	Belgium	EG	Egypt	IO	British Indian Ocean Territory
BF	Burkina Faso	EH	Western Sahara	IQ	Iraq
BG	Bulgaria	ER	Eritrea	IR	Iran (Islamic Republic of)
BH	Bahrain	ES	Spain	IS	Iceland
BI	Burundi	ET	Ethiopia	IT	Italy
BJ	Benin	FI	Finland	JM	Jamaica
BM	Bermuda	FJ	Fiji	JO	Jordan
BN	Brunei Darussalam	FK	Falkland Islands (Malvinas)	JP	Japan
BO	Bolivia	FM	Micronesia (Federated States of)	KE	Kenya
BR	Brazil	FO	Faroe Islands	KG	Kyrgyzstan
BS	Bahamas	FR	France	KH	Cambodia
BT	Bhutan	FX	France, Metropolitan	KI	Kiribati
BV	Bouvet Island	GA	Gabon	KM	Comoros
BW	Botswana	GB	United Kingdom	KN	Saint Kitts and Nevis
BY	Belarus	GD	Grenada	KP	Korea, Democratic People's Republic of
BZ	Belize	GE	Georgia	KR	Korea, Republic of
CA	Canada	GF	French Guiana	KW	Kuwait
CC	Cocos (Keeling) Islands	GH	Ghana	KY	Cayman Islands
CF	Central African Republic	GI	Gibraltar	KZ	Kazakhstan
CG	Congo	GL	Greenland	LA	Lao People's Democratic Republic
CH	Switzerland	GM	Gambia	LB	Lebanon
CI	Côte d'Ivoire				

LC	Saint Lucia	NU	Niue	SZ	Swaziland
LI	Liechtenstein	NZ	New Zealand	TC	Turks and Caicos Islands
LK	Sri Lanka	OM	Oman	TD	Chad
LR	Liberia	PA	Panama	TF	French Southern Territories
LS	Lesotho	PE	Peru	TG	Togo
LT	Lithuania	PF	French Polynesia	TH	Thailand
LU	Luxembourg	PG	Papua New Guinea	TJ	Tajikistan
LV	Latvia	PH	Philippines	TK	Tokelau
LY	Libyan Arab Jamahiriya	PK	Pakistan	TM	Turkmenistan
MA	Morocco	PL	Poland	TN	Tunisia
MC	Monaco	PM	Saint Pierre and Miquelon	TO	Tonga
MD	Moldova, Republic of	PN	Pitcairn	TP	East Timor
MG	Madagascar	PR	Puerto Rico	TR	Turkey
MH	Marshall Islands	PT	Portugal	TT	Trinidad and Tobago
ML	Mali	PW	Palau	TV	Tuvalu
MM	Myanmar	PY	Paraguay	TW	Taiwan
MN	Mongolia	QA	Qatar	TZ	Tanzania, United Republic of
MO	Macau	RE	Réunion	UA	Ukraine
MP	Northern Mariana Islands	RO	Romania	UG	Uganda
MQ	Martinique	RU	Russian Federation	UM	United States Minor Outlying Islands
MR	Mauritania	RW	Rwanda	US	United States
MS	Montserrat	SA	Saudi Arabia	UY	Uruguay
MT	Malta	SB	Solomon Islands	UZ	Uzbekistan
MU	Mauritius	SC	Seychelles	VA	Vatican City State (Holy See)
MV	Maldives	SD	Sudan	VC	Saint Vincent and the Grenadines
MW	Malawi	SE	Sweden	VE	Venezuela
MX	Mexico	SG	Singapore	VG	Virgin Islands (British)
MY	Malaysia	SH	Saint Helena	VI	Virgin Islands (U.S.)
MZ	Mozambique	SI	Slovenia	VN	Viet Nam
NA	Namibia	SJ	Svalbard and Jan Mayen	VU	Vanuatu
NC	New Caledonia	SK	Slovakia	WF	Wallis and Futuna Islands
NE	Niger	SL	Sierra Leone	WS	Samoa
NF	Norfolk Island	SM	San Marino	YE	Yemen
NG	Nigeria	SN	Senegal	YT	Mayotte
NI	Nicaragua	SO	Somalia	YU	Yugoslavia
NL	Netherlands	SR	Suriname	ZA	South Africa
NO	Norway	ST	Sao Tome and Principe	ZM	Zambia
NP	Nepal	SV	El Salvador	ZR	Zaire
NR	Nauru	SY	Syrian Arab Republic	ZW	Zimbabwe

TV Station And ID List

The "ID" abbreviation is what is shown on-screen in lieu of the station name. The "ID" abbreviation is listed in the Confirmation screen and is displayed on the TV screen when the unit is tuned to a different station.

STATION NAME	ID
Anglia TV	ANGL
ARD	ARD
ARTE	ARTE
BBC Group	BBC
BBC1	BBC1
BBC2	BBC2
BBCW	BBCW
Berlin 1	BLN1
Berlin 2	BLN2
Border TV	BORD
Bayern1	BR1
Bayern3	BR3
BRT1	BRT1
BRT2	BRT2
Children Ch	CHLD
Canal +	CH+
CNN	CNN
Channel TV	CHNL
Central TV	CNTR
Channel 4	CH 4
Channel 5	CH 5
DISC	DISC
DRS	DRS
DR TV	DRTV
DSF	DSF
Euronews	EURN
Euronews	EURO
Eurosports	EURS
France1	FR1
France2	FR2
France3	FR3
Granada TV	GRNA
Grampian TV	GRMP
Hessen1	HR1
Hessen3	HR3
HRT	HRT
HTV	HTV
ITV Network	ITV1
Kabelkanal	KABL
London	LNDN
MDR	MDR
MTV	MTV
Nord3	N3
NDR1	NDR1
NDR3	NDR3
NED1	NED1
NED2	NED2
NED3	NED3
Network 2	NET2
NRK	NRK
N-TV	N-TV
Offener Kanal	OKAN
ORF1	ORF1
ORF2	ORF2
ORF3	ORF3
OWL 3	OWL3
Premiere	PRMI
PR07	PR07
RAI1	RAI1
RAI2	RAI2
RAI3	RAI3

STATION NAME	ID
RB1	RB1
RB3	RB3
Rikisutvarpid-S	RKPS
RTBF 1	RTB1
RTBF 2	RTB2
RTE 1	RTE1
RTL	RTL
RTL 2	RTL2
RTP	RTP
SAT	SAT
SAT 1	SAT1
Scottish TV	SCOT
SC4	SC4
SDR	SDR
SDR1	SDR1
SFB1	SFB1
SFB3	SFB3
SKY	SKY
Sky One	SKY1
Sky Net	SKYN
Sport	SPRT
SR 1	SR1
Super RTL	SRTL
STV Test	STVT
STV 1	STV1
STV 2	STV2
Suedwest3	SWR
SWF 1	SWF1
Schweiz4	SWZ4
TYNE TEES	TEES
Text	TEXT
TF1	TF1
TNT int	TNT
TRT int	TRT
TSI	TSI
TSR	TSR
TSW	TSW
TVE	TVE
TV Polonia	TVPA
TVP 1	TVP1
TVP 2	TVP2
TVS	TVS
TV2	TV2
TV5	TV5
Tele Zurich	TZUR
Ulster TV	ULST
Veronica	VERN
VIVA	VIVA
VIVA2	VIV2
VOX	VOX
VTM	VTM
VT4	VT4
West1	WDR1
West3	WDR3
YLE 1	YLE1
YLE 2	YLE2
Yorkshire TV	YORK
ZDF	ZDF
Zurich 1	ZUR1
3SAT	3SAT

TV Station Channel Number Guide

Only the main stations are listed. There are in addition many relay stations, and full lists are available from the BBC and ITV.

	BBC1	BBC2	ITV	CH4	CH5		BBC1	BBC2	ITV	CH4	CH5
London & South-East						North-West					
Bluebell Hill.....	40	46	43	65	—	Caldbeck.....	30	34	28	32	56
Crystal Palace.....	26	33	23	30	37	Winter Hill.....	55	62	59	65	48
Dover.....	50	56	66	53	—	North-East					
Heathfield.....	49	52	64	67	—	Bilsdale West Moor.....	33	26	29	23	35
Oxford.....	57	63	60	53	49	Chatton.....	39	45	49	42	—
South-West						Pontop Pike.....	58	64	61	54	68
Beacon Hill.....	57	63	60	53	—	Scotland					
Caradon Hill.....	22	28	25	32	—	Angus.....	57	63	60	53	—
Huntshaw Cross.....	55	62	59	65	67	Black Hill.....	40	46	43	50	37
Redruth.....	51	44	41	47	37	Sandale.....	22	—	—	—	—
Stockland Hill.....	33	26	23	29	—	Caldbeck.....	—	34	28	32	56
Channel Islands						Creigkelly.....	31	27	24	21	48
Fremont Point.....	51	44	41	47	—	Darvel.....	33	26	23	29	35
South						Durris.....	22	28	25	32	67
Hannington.....	39	45	42	66	35	Eitshal.....	33	26	23	29	—
Midhurst.....	61	55	58	68	—	Keelylang Hill.....	40	46	43	50	—
Rowridge.....	31	24	27	21	—	Knock More.....	33	26	23	29	—
West						Rosemarkie.....	39	45	49	42	67
Mendip.....	58	64	61	54	37	Rumster Forest.....	31	27	24	21	—
East						Selkirk.....	55	62	59	65	52
Sandy Heath.....	31	27	24	21	39	Wales					
Sudbury.....	51	44	41	47	35	Blaenplwyf.....	31	27	24	21	56
Tacolneston.....	62	55	59	65	52	Carmel.....	57	63	60	53	—
Midlands						Llanddona.....	57	63	60	53	—
Ridge Hill.....	22	28	25	32	35	Moel-y-Parc.....	52	45	49	42	—
Sutton Coldfield.....	46	40	43	50	37	Presely.....	46	40	43	50	37
The Wrekin.....	26	33	23	29	35	Wenvoe.....	44	51	41	47	—
Waltham.....	58	64	61	54	35	Northern Ireland					
North						Brougher Mountain.....	22	28	25	32	—
Belmont.....	22	28	25	32	56	Divis.....	31	27	24	21	37
Emley Moor.....	44	51	47	41	37	Limavady.....	55	62	59	65	—

GENERAL**Power requirement**AC 220 V - 240 V \sim , 50 Hz/60 Hz**Power consumption**

Power on: 45 W

Power off: 15 W

Temperature

Operating: 5°C to 35°C

Storage: -20°C to 60°C

Operating position

Horizontal only

Dimensions (WxHxD)

435 mm x 96 mm x 383 mm

Weight

6.5 kg

Input/OutputVideo input: 0.5 - 2.0 Vp-p, 75 Ω (pin jack)

Audio input:

-8 dB, 50 k Ω (pin jack)

Corresponding to mono (left)

Audio output: -8 dB, 1 k Ω (pin jack)

21-pin SCART connectors:

IN/OUT x 1, IN/DECODER x 1

S-video input:

Y: 0.8 - 1.2 Vp-p, 75 Ω C: 0.2 - 0.4 Vp-p, 75 Ω

S-video output:

Y: 1.0 Vp-p, 75 Ω C: 0.3 Vp-p, 75 Ω

DV: 4-pin for DV IN/OUT

Component video output:

Y: 1.0 Vp-p, 75 Ω C_B/C_R, P_B/P_R: 0.7 Vp-p, 75 Ω

Corresponding to copy protection

Digital audio output:

Optical, Coaxial

Corresponding to Dolby Digital and DTS Digital Surround

Bit stream

Selectable in digital audio output setting menu

VIDEO/AUDIO (DVD Deck)**Recording time**

Maximum 8 hours (with 4.7 GB disc)

(XP): Approx. 1 hour

(SP): Approx. 2 hours

(LP): Approx. 4 hours

(EP): Approx. 6 hours

(FR): Approx. 1 hour - 8 hours

Audio recording system

Dolby Digital (2 ch)

Linear PCM (XP mode only)

Video recording compression system

MPEG2 (CBR/VBR)

VIDEO/AUDIO (HDD Deck)**Video recording compression system**

MPEG2 (VBR)

Audio recording system

Dolby Digital (2 ch)

Linear PCM (XP mode only)

Recording time

Maximum 473 hours (with 250 GB HDD)

(XP): Approx. 53 hours

(SP): Approx. 109 hours

(LP): Approx. 218 hours

(EP): Approx. 328 hours

(FR): Approx. 473 hours

VIDEO/AUDIO (DV Deck)**Signal system**

PAL colour signal, 625 lines/50 fields

Recording system

Digital Component Recording

Format

DV format (SD mode)

Cassette

Mini DV Cassette

Maximum recording time

(SP): 80 min. with M-DV80ME cassette

(LP): 120 min. with M-DV80ME cassette

Audio recording system

PCM 48 kHz, 16 bit (2 ch)/

32 kHz, 12 bit (4 ch)

Specifications shown are for SP mode unless otherwise specified.

TUNER/TIMER**Tuning system**

Frequency synthesised tuner

Channel coverage

VHF: 44.5 MHz - 143 MHz/

143 MHz - 470 MHz

UHF: 470 MHz - 862 MHz

Memory backup time

Approx. 60 minutes

ACCESSORIES**Provided accessories**

RF cable,

21-pin SCART cable,

Infrared remote control unit,

"AA" battery x 2

E. & O.E. Design and specifications subject to change without notice.

ATTENTION:

This unit contains microcomputers. External electronic noise or interference could cause malfunctioning. In such cases, switch the unit off and unplug the mains power cord. Then plug it in again and turn the unit on. Take out the disc. After checking the disc, operate the unit as usual.

A		P	
A-B Repeat Playback	30	Pan&Scan	23
Accidental erasure prevention	41	Parental Lock	33
Adjusting The Picture Quality	31	Play List	54
Angle Selection	27	Playback Control (PBC)	28
Audio Channel Selection	28	Programme Playback	32
Audio Language/Sound Selection	28	Progressive scan	80
Auto Channel Set	74		
B		R	
Basic Playback	24, 39, 41	Random Playback	32
Basic Recording	34, 37	Receiving Stereo And Bilingual Programmes	36, 38
C		Recordable/Playable Discs	6
Cancel And Change Programmes	49	Recording Medium And Format	8
Check Programmes	49	Recording Mode	34, 37
Country/Area Code List for Parental Lock	86	Region Number	7
D		Register Disc	56
Disc menu	25	Relief Recording	48
Disc Remaining Time	35, 38	Repeat Playback	29
Disc Resume	72	Resume Function	26
Discs For Playback Only	7	Resuming Playback	45
DVD menu	25	RetroActive Recording	45
E		S	
Elapsed Recording Time Indication	35, 38	Select The Switching Interval Of The Slide Show	32
F		Selection Of The Audio Channel To Be Recorded On A Disc	36
File Structure Of Discs	8	Setting The Progressive Mode	32
Free Rate Function	36	Simulated Surround Effect	31
G		Simultaneous Recording and Playback	45
Guide Programme Number	74	Skip Search	26, 39, 42
I		Slow Motion	25, 39, 42
Instant Timer Recording (ITR)	35, 38	Soundtrack Selection	42
Interlaced scan	80	Still Picture/Frame-By-Frame Playback	25, 39, 42
J		Subtitle Selection	28
Jump Search	26, 40	T	
Just Clock	77	Temporary Recording	45
L		Time Code	42
Language Code List	85	Time Search	31
Letter Box	23	Top menu	25
Live Memory	45	Tray Lock	80
M		TV Station And ID List	88
Manual Channel Set	75	U	
Marking Positions To Play Back Again Later	27, 40	Unplayable Discs	7
Menu/Audio/Subtitle Language Set	22	Usable cassettes	41
N		V	
Next Function Memory	42	Variable Speed Search	25, 39, 42
O		VPS/PDC Recording	47
One Touch Replay	26, 40, 42, 45	W	
On-screen Bar	29	Weekly/Daily Recording	47

EN

DR-DX5SEK

JVC

Free Manuals Download Website

<http://myh66.com>

<http://usermanuals.us>

<http://www.somanuals.com>

<http://www.4manuals.cc>

<http://www.manual-lib.com>

<http://www.404manual.com>

<http://www.luxmanual.com>

<http://aubethermostatmanual.com>

Golf course search by state

<http://golfingnear.com>

Email search by domain

<http://emailbydomain.com>

Auto manuals search

<http://auto.somanuals.com>

TV manuals search

<http://tv.somanuals.com>