

JVC

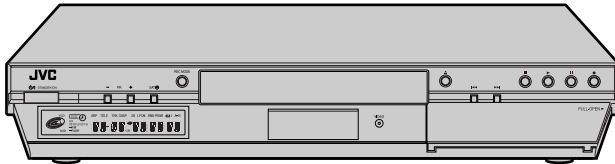

DVD VIDEO RECORDER

DR-M1SLB



VIDEO *Plus+*
DELUXE

DVD
VIDEO
RAM

DVD
VIDEO/R/RW

dts
DIGITAL OUT

DOLBY
DIGITAL

COMPACT
disc
DIGITAL VIDEO

COMPACT
disc
DIGITAL AUDIO

VIDEO CD



INSTRUCTIONS

LPT0827-001B

Safety Precautions

The rating plate and the safety caution are on the rear of the unit.

WARNING: DANGEROUS VOLTAGE INSIDE

WARNING: TO PREVENT FIRE OR SHOCK HAZARD, DO NOT EXPOSE THIS UNIT TO RAIN OR MOISTURE.

CAUTION

A UNIT IS A CLASS 1 LASER PRODUCT. HOWEVER THIS UNIT USES A VISIBLE LASER BEAM WHICH COULD CAUSE HAZARDOUS RADIATION EXPOSURE IF DIRECTED. BE SURE TO OPERATE THE UNIT CORRECTLY AS INSTRUCTED.

WHEN THIS UNIT IS PLUGGED INTO THE WALL OUTLET, DO NOT PLACE YOUR EYES CLOSE TO THE OPENING OF THE DISC TRAY AND OTHER OPENINGS TO LOOK INTO THE INSIDE OF THIS UNIT.

USE OF CONTROLS OR ADJUSTMENTS OR PERFORMANCE OF PROCEDURES OTHER THAN THOSE SPECIFIED HEREIN MAY RESULT IN HAZARDOUS RADIATION EXPOSURE.

DO NOT OPEN COVERS AND DO NOT REPAIR YOURSELF. REFER SERVICING TO QUALIFIED PERSONNEL.

CAUTION

- When you are not using the unit for a long period of time, it is recommended that you disconnect the power cord from the mains outlet.
- Dangerous voltage inside. Refer internal servicing to qualified service personnel. To prevent electric shock or fire hazard, remove the power cord from the mains outlet prior to connecting or disconnecting any signal lead or aerial.

IMPORTANT:

- Please read the various precautions on pages 2 and 3 before installing or operating the unit.
- It should be noted that it may be unlawful to re-record pre-recorded tapes, DVDs, or discs without the consent of the owner of copyright in the sound or video recording, broadcast or cable programme and in any literary, dramatic, musical, or artistic work embodied therein.

CLASS 1 LASER PRODUCT

REPRODUCTION OF LABELS

WARNING LABEL INSIDE OF THE UNIT

CAUTION	VISIBLE AND INVISIBLE LASER RADIATION WHEN OPEN. AVOID EXPOSURE TO BEAM. DO NOT STARE INTO BEAM OR VIEW DIRECTLY WITH OPTICAL INSTRUMENTS.
ADVARSEL	SYNLIG OG USYNLIG LASERSTRÅLING VED ÅBNING. UNDGÅ UDSAETTELSE FOR STRÅLING SE IKKE IND I STRÅLEN - HELLER IKKE MED OPTISKE INSTRUMENTER.
ADVARSEL	SYNLIG OG USYNLIG LASERSTRÅLING NÅR DEKSEL ÅPNES. UNDGÅ EKSPONERING FOR STRÅLEN STIRR IKKE INN I STRÅLEN ELLER SE DIREKTE MED OPTISKE INSTRUMENTER.
VARO!	AVATTAESSA OLET ALTTIINA NÄKYVÄÄ JA NÄKYMÄTÖN LASERSÄTEILYLLE. ÄLÄ TUIJOTA SÄTEESEEN ÄLÄKÄ KATSO SITÄ OPTISEN LAITTEEN LÄPI.
VARNING	SYNLIG OCH OSYNLIG LASERSTRÅLNING NÅR DENNA DEL ÄR ÖPPNAD. STRÅLEN ÄR FARLIG STIRRA EJ IN I STRÅLEN OCH BETRAKTA EJ STRÅLEN MED OPTISKA INSTRUMENT.



- Manufactured under licence from Dolby Laboratories. "Dolby" and double-D symbol are trademarks of Dolby Laboratories.
- "DTS" and "DTS Digital Out" are trademarks of Digital Theater Systems, Inc.
- VIDEO Plus+ and PlusCode are registered trademarks of Gemstar Development Corporation. The VIDEO Plus+ system is manufactured under license from Gemstar Development Corporation.
- This product incorporates copyright protection technology that is protected by method claims of certain U.S. patents and other intellectual property rights owned by Macrovision Corporation and other rights owners. Use of this copyright protection technology must be authorized by Macrovision Corporation, and is intended for home and other limited viewing users only unless otherwise authorized by Macrovision Corporation. Reverse engineering or disassembly is prohibited.

The STANDBY/ON \cup /I button does not completely shut off mains power from the unit, but switches operating current on and off. " \cup " shows electrical power standby and "I" shows ON.

When the equipment is installed in a cabinet or a shelf, make sure that it has sufficient space on all sides to allow for ventilation (10 cm or more on both sides, on top and at the rear).

When discarding batteries, environmental problems must be considered and the local rules or laws governing the disposal of these batteries must be followed strictly.

Failure to heed the following precautions may result in damage to the unit, remote control or disc.

1. **DO NOT place the unit** —
 - in an environment prone to extreme temperatures or humidity.
 - in direct sunlight.
 - in a dusty environment.
 - in an environment where strong magnetic fields are generated.
 - on a surface that is unstable or subject to vibration.
2. **DO NOT block the unit's ventilation openings or holes.**
(If the ventilation openings or holes are blocked by a newspaper or cloth, etc., the heat may not be able to get out.)
3. **DO NOT place heavy objects on the unit or remote control.**
4. **DO NOT place anything which might spill on top of the unit or remote control.**
(If water or liquid is allowed to enter this equipment, fire or electric shock may be caused.)
5. **DO NOT expose the apparatus to dripping or splashing.**
6. **DO NOT use this equipment in a bathroom or places with water. Also DO NOT** place any containers filled with water or liquids (such as cosmetics or medicines, flower vases, potted plants, cups, etc.) on top of this unit.
7. **DO NOT place any naked flame sources, such as lighted candles, on the apparatus.**
8. **AVOID violent shocks to the unit during transport.**

MOISTURE CONDENSATION

Moisture in the air will condense on the unit when you move it from a cold place to a warm place, or under extremely humid conditions—just as water droplets form on the surface of a glass filled with cold liquid. In conditions where condensation may occur, disconnect the unit's power plug from the wall and keep it disconnected for a few hours to let the moisture dry, then turn on the unit.

ATTENTION:

To mobile phone users:

Using a mobile phone in the vicinity of the unit may cause picture vibration on the TV screen or change the screen to a blue back display.

On placing the unit:

Some TVs or other appliances generate strong magnetic fields. Do not place such appliances on top of the unit as it may cause picture disturbance.

IMPORTANT

Connection to the mains supply in the United Kingdom.

DO NOT cut off the mains plug from this equipment.

If the plug fitted is not suitable for the power points in your home or the cable is too short to reach a power point, then obtain a proper safety approved extension lead/adaptor or consult your dealer.

In the unlikely event of the plug fuse failing be sure to replace the fuse only with an identical approved type, as originally fitted, and to replace the fuse cover. If the fuse fails again consult your nearest JVC dealer.

If nonetheless the mains plug is cut off remove the fuse and dispose of the plug immediately, to avoid a possible shock hazard by inadvertent connection to the mains supply.

If this product is not supplied fitted with a mains plug then follow the instructions given below:

DO NOT make any connection to the Larger Terminal coded E or Green.

The wires in the mains lead are coloured in accordance with the following code:

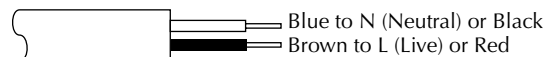

If these colours do not correspond with the terminal identifications of your plug, connect as follows:
Blue wire to terminal coded N (Neutral) or coloured Black.

Brown wire to terminal coded L (Live) or coloured Red.

If in doubt — consult a competent electrician.

Some Do's And Don'ts On The Safe Use Of Equipment

This equipment has been designed and manufactured to meet international safety standards but, like any electrical equipment, care must be taken if you are to obtain the best results and safety is to be assured.

- DO** read the operating instructions before you attempt to use the equipment.
- DO** ensure that all electrical connections (including the mains plug, extension leads and interconnections between pieces of equipment) are properly made and in accordance with the manufacturer's instructions. Switch off and withdraw the mains plug when making or changing connections.
- DO** consult your dealer if you are ever in doubt about the installation, operation or safety of your equipment.
- DO** be careful with glass panels or doors on equipment.
- DON'T** continue to operate the equipment if you are in any doubt about it working normally, or if it is damaged in any way — switch off, withdraw the mains plug and consult your dealer.
- DON'T** remove any fixed cover as this may expose dangerous voltages.
- DON'T** leave equipment switched on when it is unattended unless it is specifically stated that it is designed for unattended operation or has a standby mode. Switch off using the switch on the equipment and make sure that your family knows how to do this. Special arrangements may need to be made for infirm or handicapped people.
- DON'T** use equipment such as personal stereos or radios so that you are distracted from the requirements of road safety. It is illegal to watch television whilst driving.
- DON'T** listen to headphones at high volume, as such use can permanently damage your hearing.
- DON'T** obstruct the ventilation of the equipment, for example with curtains or soft furnishings. Overheating will cause damage and shorten the life of the equipment.
- DON'T** use makeshift stands and NEVER fix legs with wood screws — to ensure complete safety always fit the manufacturer's approved stand or legs with the fixings provided according to the instructions.
- DON'T** allow electrical equipment to be exposed to rain or moisture.

ABOVE ALL...



- **NEVER** let anyone especially children push anything into holes, slots or any other opening in the case — this could result in a fatal electrical shock;
- **NEVER** guess or take chances with electrical equipment of any kind — it is better to be safe than sorry!

SAFETY FIRST	2	EDITING	80
Safety Precautions	2	DV Dubbing	80
Some Do's And Don'ts On The Safe Use Of Equipment	4	Edit From A Camcorder	82
DISC INFORMATION	6	Edit To Or From Another Recorder	83
About Discs	6	Output/Input Set	84
INDEX	11	Digital Audio Dubbing	86
INSTALLING YOUR NEW UNIT	17	REMOTE CONTROL	87
Check Contents	17	Remote Control Functions	87
Basic Connections	18	SYSTEM CONNECTIONS	90
S-VIDEO Connection	19	Connecting To A Satellite Receiver	90
Component Video Connection	20	Connecting To A Dolby Digital Decoder or An Amplifier With Built-in DTS	91
INITIAL SETTINGS	21	SUBSIDIARY SETTINGS	92
Auto Set Up	21	Mode Set	92
Preset Download	23	VIDEO Plus+ [®] System Setup	97
Monitor Set	25	Tuner Set	98
Language	26	Clock Set	104
SAT CONTROL SET	28	Format a disc	106
Satellite Receiver Control Setting	28	Finalise a disc	107
T-V LINK	30	Scan Mode Set	108
T-V Link Functions	30	TROUBLESHOOTING	109
PLAYBACK OPERATIONS	31	GLOSSARY	113
Basic Playback	31	SPECIFICATIONS	114
Playback Features	32	LIST OF TERMS	115
Live Memory Playback	37		
Using Play Set Up Menu	42		
Parental Lock	49		
RECORDING	53		
Basic Recording	53		
Recording Features	54		
TIMER RECORDING	56		
VIDEO Plus+ [®] Timer Programming	56		
Manual Timer Programming	58		
On-Disc Timer Programming	60		
Automatic Satellite Programme Recording	65		
NAVIGATION	66		
Library Database DVD Navi	66		
Modify Original Information	69		
Modify Play List Information	72		
Modify Library Information	76		
Playback with MP3/JPEG Navigation	78		

About Discs

Recordable/playable discs

You can use discs with the following logos for recording and playback.

 <p>DVD-RAM RAM 4.7</p>	<p>12 cm: 4.7 GB/9.4 GB 8 cm: 1.4 GB/2.8 GB (VR mode)</p>
 <p>DVD-R R 4.7</p>	<p>12 cm: 4.7 GB 8 cm: 1.4 GB General Ver. 2.0 (Video mode)</p>
 <p>DVD-RW RW</p>	<p>12 cm: 4.7 GB Ver. 1.0 (VR mode only) Ver. 1.1 or higher (Video mode/VR mode)</p>

- Recording and playback may not be performed depending on the characteristics and condition of the disc used, leading to unsatisfactory results. Using discs manufactured by JVC is recommended since they have been tested to be compatible with this unit.

DVD-RAM Discs

It is only possible to use discs which conform with DVD-RAM standard Version 2.0.

- It is impossible to record on DVD-RAM discs which do not conform to this standard. If you use a disc formatted under a different standard version, format it on this unit before use.
- It may not be possible to record, play back, edit or dub a DVD-RAM disc even if it conforms to the standard if it was recorded or edited on the devices from other manufacturers or on a PC, or if it has far too many titles, or if there is very little available capacity remaining on the disc.
- Some DVD-RAM discs are contained in a cartridge. This unit cannot handle this type of disc. Remove the disc from the cartridge (only discs with a removable cartridge); or the use of DVD-RAM discs not contained in a cartridge is recommended.
- DVD-RAM discs recorded on this unit cannot be played back on an incompatible DVD player.
- It is possible to record copy-once programmes of digital broadcasts only onto 4.7/9.4 GB DVD-RAM discs (2.8 GB DVD-RAM discs are not compatible).

DVD-R/RW Discs

It is only possible to use DVD-R discs which conform with DVD-R standard Version 2.0, and DVD-RW discs of Version 1.0 or higher.

When a DVD-R/RW disc (Video mode) is finalised (☞ pg. 107), it can be played back on a standard DVD player as a DVD VIDEO disc.

When a DVD-RW disc (VR mode) is finalised (☞ pg. 107), it can be played back on a standard DVD player compatible with the VR mode of DVD-RW discs.

Before finalising (☞ pg. 107) —

- It is possible to record on unrecorded areas of the disc, edit the disc title and programme titles, and delete programmes.
- It is impossible to record or edit DVD-R/RW discs recorded on other devices even if they have not been finalised.
- It is impossible to overwrite recorded areas of DVD-R discs.
- Available recording capacity does not increase even if a recorded programme is deleted from a DVD-R disc.

After finalising (☞ pg. 107) —

- After a DVD-R/RW disc (Video mode) has been finalised, it is possible to play back the recorded programmes (video and/or audio) on a standard DVD video player as a DVD VIDEO disc.
- Edited titles are displayed as the “DVD menu” in video mode.

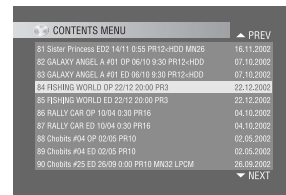

- It is impossible to record, edit or delete the data either in video mode or in VR mode.
- Either in video mode or in VR mode, although the disc can be played back on DVD players from other manufacturers, sometimes it may not be possible to play depending on the disc and recording conditions.
- It is impossible to record on CD-R/RW or DVD-R discs used for authoring.
- It is impossible to record onto DVD-R/RW (Video mode) discs broadcasts that allow you to copy once. The copy once programmes can only be recorded onto DVD-RW discs formatted in VR mode.







NOTES:

The following may result if you play back a DVD-R disc recorded on another unit.

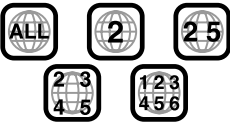
- The disc does not play.
- A mosaic pattern (block noise) appears on the screen.
- Video or audio may be dropped out.
- The unit stops during playback.

Discs for Playback Only

You can use discs with the following logos for playback only.

<p>DVD VIDEO</p>  <p>(example of region code indications)</p> 	<p>Video CD</p>  
<p>Audio CD</p>  <p>CD-DA files</p>	<p>CD-R</p>  <p>CD-DA/JPEG/MP3 files</p>
<p>CD-RW</p>  <p>CD-DA/JPEG/MP3 files</p>	<p>CD-ROM</p>  <p>JPEG/MP3 files</p>

- Playback may not be performed depending on the characteristics and condition of the disc used.
- DTS Audio CDs can also be played back (An optional DTS decoder is required).
- MP3 and JPEG discs can be played back on this unit only when they have been recorded in the ISO9660 or Joliet format and finalised.
- JPEG files that can be played back on this unit must conform to JFIF/Baseline process, and the maximum resolution of a JPEG file is 3,840 x 2,160 pixels.
- CD-R/RW discs recorded in music CD format need to be finalised to play on this unit.
- Operation and audio quality of this unit are not guaranteed for discs that do not conform to the Compact Disc specification (CD-DA).
Before you play back a CD, check for the CD logo and read the notes on the package to confirm that it conforms to the Compact Disc specification.
- Depending on the intentions of the author of the software, recording conditions of DVD discs and Video CD discs may be restricted. Since this unit plays back discs according to the intentions of the author of the software as indicated on the disc, some functions may not operate as commanded.
- When switching from the first layer to the second layer of double-layered DVD VIDEO discs, the image and sound may be momentarily distorted. This is not a malfunction.
- DVD-AUDIO discs compatible with DVD video players can be played.
- Super Audio CDs (SACD) compatible with conventional CD players can be played.

Unplayable Discs

The following types of discs cannot be played using this unit. Do not attempt to play back any kind of disc that is damaged (cracked, warped, or repaired with adhesive tape) or discs in unusual shapes (heart-shaped, octagonal, or other forms). If such discs are accidentally played back, it may cause noise that can lead to speaker damage.

- CD-ROM discs (including PHOTO-CD and CD-G)
- Discs recorded in Packet Write (UDF) format.
- Super Video CDs (SVCD)
- 1.3-GB double density CDs (DDCD)
- High density CDs (HDCD)

The following discs also cannot be played back.

- Discs of a region number other than "2"
- DVD-RAM (2.6 GB/5.2 GB)









Region Number

The world is divided into 6 regions for DVD VIDEO discs. DVD VIDEO discs are assigned a region number to indicate which region they may be played back in. A disc cannot be played back on this unit unless the region number of the disc matches that of the unit. The region number for this unit is "2". Only discs whose region number includes "2" or "ALL" can be played back such as shown below.

Examples of DVD VIDEO labels which can be played back using this unit.



Marks of discs in this instruction manual

	Allows operation with a DVD-RAM disc.		Allows operation with a Video CD disc.
	Allows operation with a DVD-R disc.		Allows operation with an Audio CD disc.
	Allows operation with a DVD-RW disc.		Allows operation with a disc including MP3 files.
	Allows operation with a DVD VIDEO disc.		Allows operation with a disc including JPEG files.

Recording Medium and Format

DVD-RAM

- Recording and erasing can be performed as many times as possible on a disc.
- Editing can be performed after recording, such as deleting unwanted parts.
- While recording, it is possible not only to start playback of a programme currently being recorded, but also to watch another programme previously recorded.

DVD-RW (VR mode)

- Recording and erasing can be performed as many times as possible on a disc.
- Editing can be performed after recording, such as deleting unwanted parts.

DVD-RW (Video mode)

- Can be played back on other DVD players.
- New recording can be performed by erasing all the data on a disc once played back.

DVD-R

- Can be played back on other DVD players.
- Suitable when keeping a recorded disc for a long time.

File Structure of Discs

DVD VIDEO

Typically, DVD VIDEO discs are made up of larger units called "titles". Each title has a number (title number) that can be used to select desired titles. Titles are further divided into units called "chapters". Each chapter has a number (chapter number) that can also be used to select desired chapters. Note that some discs are not divided into titles and chapters.

When you record a programme on a DVD-RAM/RW (VR mode) disc

A single recording session results in a single title (a single chapter). However, chapter marks are automatically inserted when recording is paused, or audio changes from monaural or bilingual to stereo due to commercial breaks, etc. It is also possible to insert chapter marks at desired locations during playback. (☞ pg. 34)

When you record a programme on a DVD-R/RW (Video mode) disc

A single recording session results in a single title (a single chapter). However, chapter marks are automatically inserted when recording is paused, or audio changes due to commercial breaks, etc. It is also possible to insert chapter marks at desired locations during either recording or playback. Once the disc has been finalised, these chapter marks are deleted and new chapter marks are assigned automatically approximately every 5 minutes.

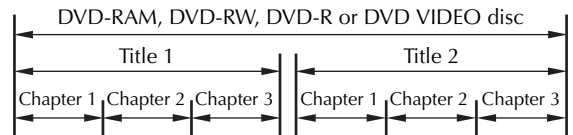

- In Video mode, even before finalising, it is impossible to perform editing operations other than changing the disc name and/or title names and deleting programmes and/or titles.
- After finalising, it is impossible to perform editing operations.

Audio CD/Video CD

Typically, Audio CD discs are divided into separate tracks each containing one song. Each track is assigned a number. For example, the third track is Track 3. The same is true for Video CD discs.

However, some discs are not divided into tracks.

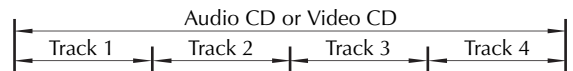

JPEG/MP3 Disc (CD-R/RW/ROM)

MP3/JPEG files put in directories nested in several levels on a disc will be organized as if they were put in single level directories (groups) by the MP3/JPEG Navigation of this unit. (☞ pg. 78)

File structure of a disc before starting the MP3/JPEG Navigation

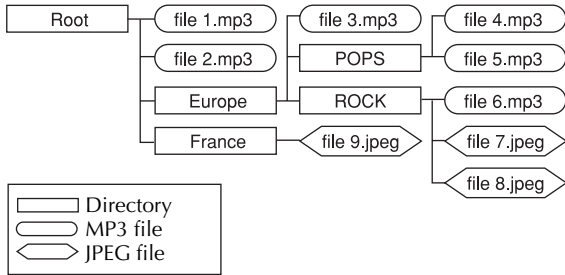

File structure of the disc after starting the MP3/JPEG Navigation

Files are automatically grouped as follows and displayed on the MP3/JPEG Navigation screen. Data is displayed in the alphabetical order of file name. Files are grouped based on roots.

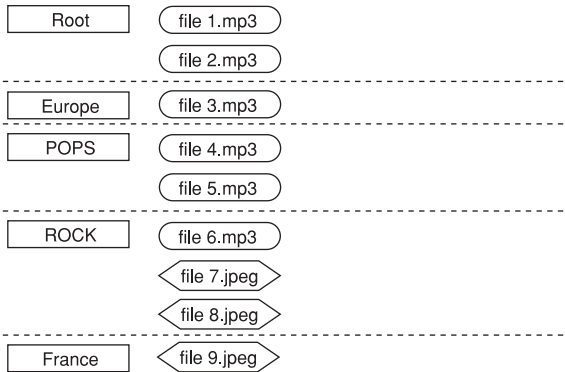

- This unit can recognise up to 9 hierarchies including directories and files. Also, it can recognise up to 250 files in each group, and up to 99 groups on a disc.

NOTES:

- **Video CD discs that support Playback Control (PBC)**
The contents of a disc are recorded into several hierarchies, and played back according to the instructions on the screen while navigating through the hierarchies. It is also possible to playback recorded tracks consecutively without activating the PBC function even when playing a PBC-compatible disc. (☞ pg. 36)
- **Regarding the contents recorded on discs**
Some files may not be played back depending on the file types and other factors.

DVD VIDEO Marks

Sometimes marks are printed on a DVD disc and/or on its packaging to indicate information regarding the contents and functions of the disc. Check the marks indicating the contents and functions of the disc. Note, however, that in some cases a disc may not include a mark even for a function it supports.

Marks related to video

Mark	Description
	Number of subtitles
	Number of angles
	Recorded under the standard 4:3 aspect ratio
	Screen includes black bands at the top and the bottom of image which has a standard 4:3 aspect ratio (letter box)
	Video playback is in Wide video mode (16:9) on wide televisions, but in letter box on televisions with standard 4:3 aspect ratio.
	Video playback is in Wide video mode (16:9) on wide televisions, but pan and scan is used on televisions with standard 4:3 aspect ratio (either the left or right side of the image is cut-out).

Marks related to audio

Mark	Description
	Number of audio tracks
	Dolby Digital mark It has been developed by Dolby Laboratories as a digital surround system.
	DTS (Digital Theater Systems) You can enjoy DTS audio if you connect an amplifier with a built-in DTS decoder to the DIGITAL AUDIO OUT connector of the unit.

Placing a Disc

Opening the disc tray

Press ▲ on the unit or remote control to open the disc tray.

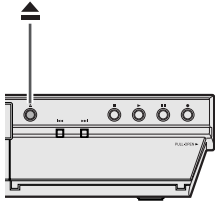

Unit

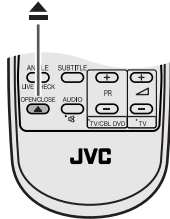

Remote control

- Pressing the button on the unit or on the remote control again closes the disc tray.
- Use the buttons on the unit or on the remote control to open and close the disc tray.
- Do not block the disc tray with your hand while it is opening or closing as this may result in hardware failure.
- Do not place unplayable discs or any object other than a disc on the disc tray.
- Do not press down strongly on the disc tray or place any heavy objects on it.

Discs without cartridges

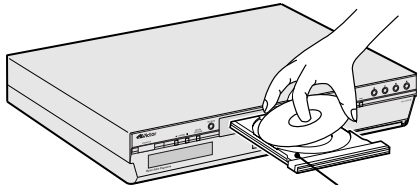

Disc tray

- Place the disc on the disc tray with the label side facing up. Since disc size changes depending on the disc to be played back, be sure to correctly align the disc with the grooves for its size. If the disc is not in its groove, it may be scratched or otherwise damaged. To insert an 8 cm disc, place it according to the inner groove.

DVD-RAM discs contained in cartridges

Double-sided discs:

Remove the disc from the cartridge. Align the disc with the grooves on the disc tray as shown in the illustration and insert with the side you wish to play back or record facing down. If you insert the disc with "Side A" facing down, programmes are recorded on the side A.

Single-sided discs:

Remove the disc from the cartridge. Align the disc with the grooves on the disc tray as shown in the illustration and insert with the label side facing up.

Care and Handling of Discs

How to handle discs

When handling a disc, do not touch the surface of the disc. Since discs are made of plastic, they are easily damaged. If a disc gets dirty, dusty, scratched or warped, the images and sound will not be picked up correctly, and such a disc may cause the unit to malfunction.

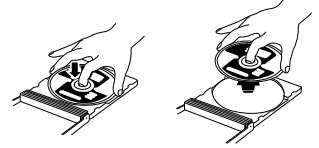

Label side

Do not damage the label side, stick paper to or use any adhesives on its surface.

Recording side

Make sure that discs are not scratched and dirty on the recording side before use. Scratches and dirt on the recording side of a disc may hinder proper playback and recording. Also be careful that a DVD-RAM disc may get scratched or dirt when removed from cartridge then put back in after use.

Storage

Make sure that discs are kept in their cases. If discs are piled on top of one another without their protective cases, they can be damaged. Do not put discs in a location where they may be exposed to direct sunlight, or in a place where the humidity or temperature is high. Avoid leaving discs in your car!

Maintenance of discs

If there are fingerprints or other dirt adhering to a disc, wipe with a soft dry cloth, moving from the centre outwards. If a disc is difficult to clean, wipe with a cloth moistened with water. Never use record cleaners, petrol, alcohol or any anti-static agents.



CAUTION

Sometimes during playback, noise may appear or images may be garbled. This is sometimes due to the disc. (It may not be up to industry standards.)

These symptoms are caused by the discs, not by the malfunction of the unit.

FRONT VIEW

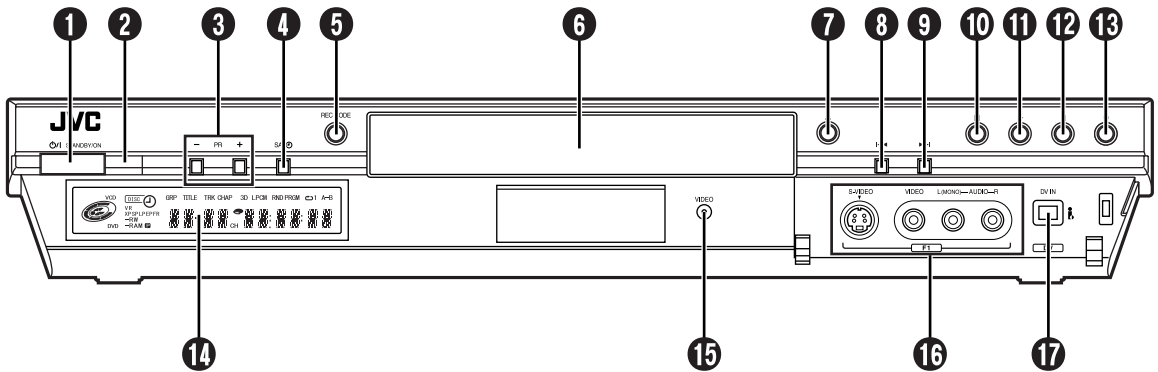

- ❶ Standby/On Button (⏻/⏻ (STANDBY/ON))
☞ pg. 21
- ❷ Infrared Beam Receiving Window
- ❸ Programme Button (PR +/-) ☞ pg. 53
- ❹ Automatic Satellite Programme Recording Button (SAT) ☞ pg. 65
- ❺ Recording Mode Button (REC MODE) ☞ pg. 53
- ❻ Disc Tray
- ❼ Open/Close Button (⏏ (OPEN/CLOSE)) ☞ pg. 10
- ❽ Back Skip Button (⏮) ☞ pg. 33
- ❾ Forward Skip Button (⏭) ☞ pg. 33

- ❿ Stop Button (■) ☞ pg. 31, 53
 - ⓫ Play Button (▶ (PLAY)) ☞ pg. 31
 - ⓬ Pause Button (⏸ (PAUSE)) ☞ pg. 31
 - ⓭ Record Button (● (REC)) ☞ pg. 53
 - ⓮ Front Display Panel ☞ pg. 13
 - ⓯ Video Indicator (VIDEO) ☞ pg. 54
 - ⓰ S-video/Video/Audio Input Connectors (S-VIDEO/VIDEO/AUDIO (L/R)) ☞ pg. 82
 - ⓱ DV Input connector (DV IN (i.Link*)) ☞ pg. 80
- * i.Link refers to the IEEE1394-1995 industry specification and extensions thereof. The  logo is used for products compliant with the i.Link standard.

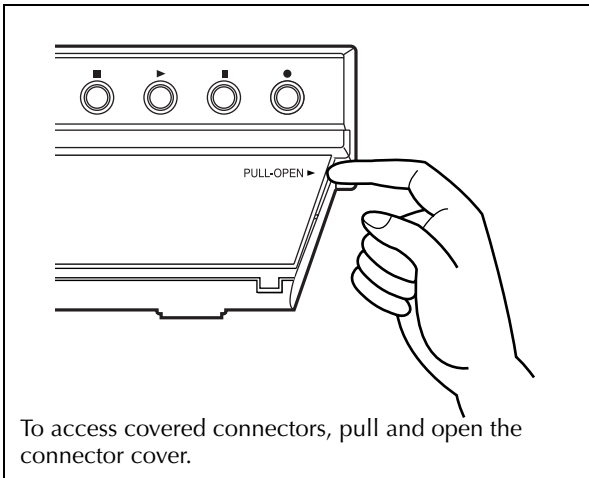

REAR VIEW

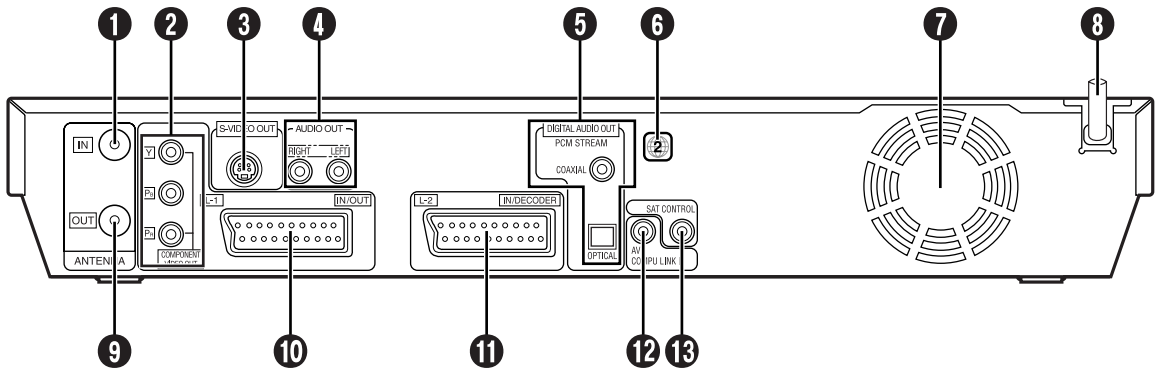
**1** Antenna Input Connector (ANTENNA IN)

☞ pg. 18

2 Component Video Output Connectors (COMPONENT VIDEO OUT (L-1)) ☞ pg. 20**3** S-video Output Connector (S-VIDEO OUT) ☞ pg. 19**4** Audio Output Connectors (AUDIO OUT (RIGHT/LEFT)) ☞ pg. 19**5** Digital Audio Output Connectors (DIGITAL AUDIO OUT (COAXIAL/OPTICAL)) ☞ pg. 86, 91**6** Region Number Label ☞ pg. 7**7** Cooling Fan

- This prevents the temperature from rising inside the unit. Do not remove it.
- Install the unit so as not to block the area around the fan.
- The fan may be activated even if the unit is turned off.

8 Mains Power Cord ☞ pg. 18**9** Antenna Output Connector (ANTENNA OUT) ☞ pg. 18**10** L-1 Input/Output Connector (L-1 IN/OUT) ☞ pg. 18, 83, 84, 90**11** L-2 Input/Decoder Connector (L-2 IN/DECODER) ☞ pg. 28, 83, 90**12** AV COMPU LINK III Connector*

* Not function with this unit.

13 Satellite Control Connector (SAT CONTROL) ☞ pg. 28

FRONT DISPLAY PANEL

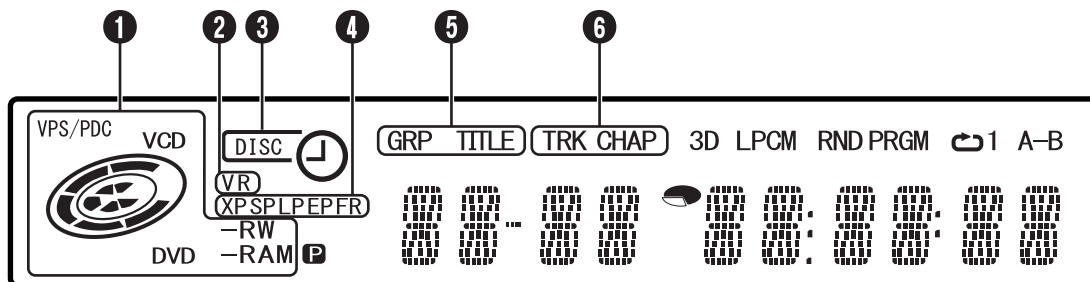

1 VPS/PDC Indicator pg. 59

Appears when a station being received transmits a PDC signal.

Disc Type/Status Indicator

When a disc is loaded, the type of the disc is indicated.

When a disc is running, the disc marks rotate.

During High-Speed Search: Rotate faster than normal playback.

During Slow Motion: Rotate slower than normal playback.

While recording: Inner red ring lights in the same way as normal playback. During Instant Timer Recording (ITR), inner red ring slowly blinks.

While paused: Disc marks blink when either recording or playing back.

While stopped: Disc marks all light.

While resume stopped: Disc marks all blink.

While the disc tray opened: Disc marks all light out.

No disc on the disc tray: Disc marks all light out.

2 VR Mode Indicator pg. 106

Lights when a DVD-RW disc is formatted in VR mode.

3 Timer Recording Indicator pg. 56, 58, 60, 63

: Lights when a disc set up for On-Disc Timer Programming is loaded.

: Lights when timer recording other than On-Disc Timer Programming is on stand-by or being executed.

: Lights when On-Disc Timer Programming is on stand-by or being executed.

: Blinks quickly if you press (TIMER) in the following cases;

- Disc is not loaded.
- Clock has not been set.
- There is no programme setting.

4 Recording Mode Indicator (XP/SP/LP/EP/FR) pg. 54

Blinks when recording mode is being set.

While "FR" is blinking, the left 3 digits of the Multi Display indicate setting values ranging from "60" to "360".

After the value has been set, only "FR" lights.

5 Group/Title Indicator (GRP/TITLE) pg. 8, 46

"GRP" or "TITLE" lights depending on a disc loaded while the left 2 digits of the Multi Display indicate the numbers explained below.

"GRP": Total number of groups or group number being played back are displayed on the Multi Display.

"TITLE": Total number of titles or title number being played back are displayed on the Multi Display.

6 Track/Chapter Indicator (TRK/CHAP) pg. 8, 46

"TRK" or "CHAP" lights depending on a disc loaded while the 3rd and 4th digits from the left of the Multi Display indicate the numbers explained below.

"TRK": Total number of tracks or track number being played back are displayed on the Multi Display.

"CHAP": Chapter number being played back are displayed on the Multi Display.

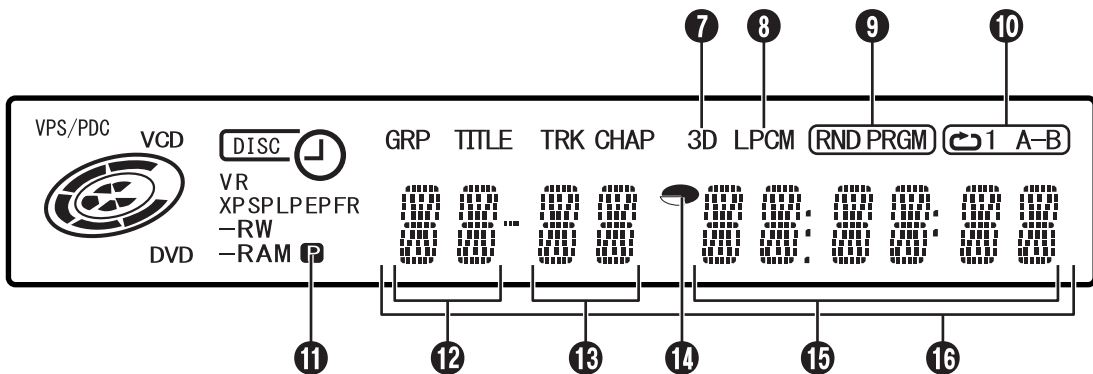

7 Simulated Surround Effect Indicator (3D)

☞ pg. 47

Lights when a simulated surround effect is set to "3D-ON" in Play Set Up menu.

8 Linear PCM Indicator (LPCM)

Lights when "XP MODE REC AUDIO" is set to "LINEAR PCM" (☞ pg. 94) for recording with DVD-RAM, DVD-R and DVD-RW discs, and when Linear PCM audio is played.

9 Random/Programme Playback Mode Indicator (RND/PRGM) ☞ pg. 45

"RND": Lights when Random Playback mode is set. (☞ pg. 45)

"PRGM": Lights when Programme Playback mode is set. (☞ pg. 45)

10 Repeat Mode Indicator (1/A-B) ☞ pg. 44

Select Repeat Playback mode in Play Set Up menu.

"1": Whole disc is played back repeatedly.

"1": A single title/chapter/track is played back repeatedly.

"A-B": The selected part (A-B) is played back repeatedly.

No display: Repeat Playback mode is off.

11 Video Output Indicator (P) ☞ pg. 108

No display: Indicates that interlace mode is engaged.

P: Indicates that progressive mode is engaged.

(Example) P lights when video output mode is in progressive mode.

12 Group/Title Number Display ☞ pg. 8, 46

13 Track/Chapter Number Display ☞ pg. 8, 46

14 Remaining Time/Elapsed Time Indicator

☞ pg. 34, 54

Lights when remaining time of DVD-RAM, DVD-R and DVD-RW discs is displayed, and lights out when elapsed time is displayed.

The right 6 digits of the Multi Display (16) indicate elapsed or remaining time of each track.

No display: Indicates elapsed time of the disc.

Displayed: Indicates remaining time of the disc.

15 Remaining Time/Elapsed Time Display

☞ pg. 34, 54

16 Multi Display

Displays clock, received channel, elapsed time, and remaining time.

Also displays status of the unit (NO DISC/OPEN/CLOSE/READING).

ON-SCREEN DISPLAY

When **DISPLAY** on the remote control is pressed, various operational indicators appear on the TV screen.

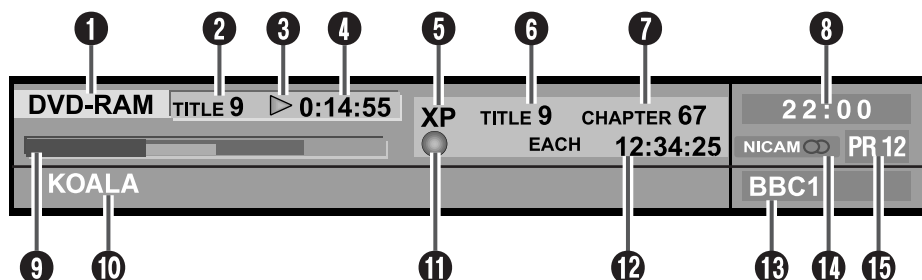

- 1** Disc Display
Displays the type of the disc loaded on the disc tray.
- 2** Title Number*
Displays number of the title currently being played back.
- 3** Playback Operation Status Indicator*
Indicates playback operation status by pictographs.
- 4** Playback Time*
Displays playback time of the title currently being played back.
- 5** Recording Mode
Displays recording mode as XP, SP, LP, EP, FR, and FR60–FR360. Current recording mode is displayed during recording, and recording mode in which the programme was recorded is displayed during playback. The recording mode is not displayed during play list playback.
- 6** Title Number
Displays playback title number during playback, and recording title number during recording.
- 7** Chapter Number
Displays playback chapter number during playback, and recording chapter number during recording.
- 8** Clock Display
- 9** Bar Meter Display pg. 39
Displays playback point and other information in bar meter.
- 10** Title Name Display
Displays title name newly registered to the title recorded on DVD-RAM/RW/R discs, or file name of JPEG and MP3 files.
- 11** Operation Status Indicator
Indicates operation status by pictographs. (Also indicates its speed for forward high-speed search, reverse high-speed search and slow motion.)
- 12** Time Display
Displays single title playback elapsed time, single track playback elapsed time, single track remaining time, total elapsed time, total remaining time, and other information in turn.
- 13** Station Name Display
Displays currently selected station name.
- 14** Audio Display
Displays audio that is being input.
- 15** Input Display
Displays currently selected input.

* During Live Memory playback, playback operation status is displayed. During normal playback, the multichannel encoding method is displayed.

REMOTE CONTROL

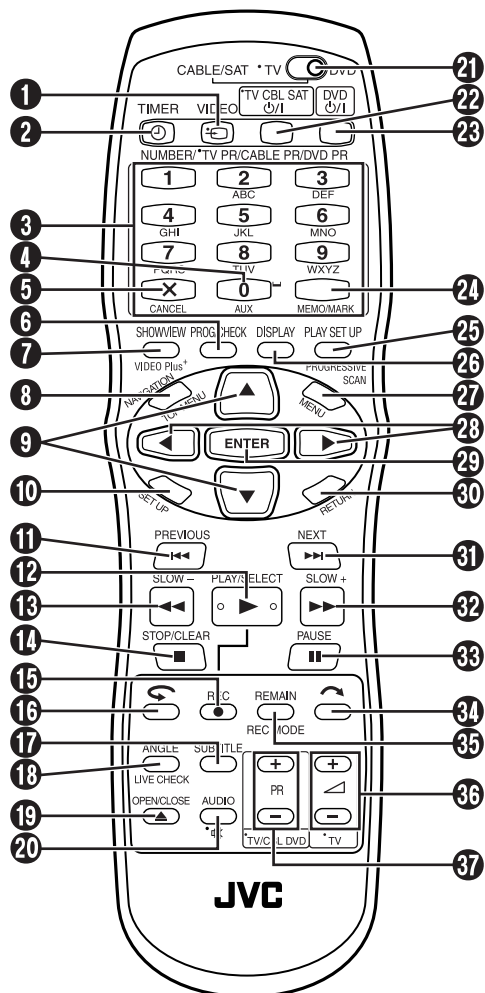

Buttons with a small dot on the left side of the name can also be used to operate your TV. (☞ pg. 88)

- 1 Video Button (VIDEO) ☞ pg. 54
- 2 Timer Button (TIMER) ☞ pg. 57, 59
- 3 Number Keys ☞ pg. 32, 49, 53, 56, 70, 87, 99
- 4 Auxiliary Button (AUX) ☞ pg. 97
- 5 Cancel Button (X (CANCEL)) ☞ pg. 42, 49, 56, 63, 79, 100
- 6 Programme Check Button (PROG/CHECK) ☞ pg. 63
- 7 VIDEO Plus+ Button ☞ pg. 56
- 8 Top Menu Button (TOP MENU) ☞ pg. 32
Navigation Button (NAVIGATION) ☞ pg. 66
- 9 \triangle / ∇ Button ☞ pg. 21
- 10 Set Up Button (SET UP) ☞ pg. 25
- 11 Reverse Skip Button (◀◀) ☞ pg. 33, 40
Previous Button (PREVIOUS) ☞ pg. 36
- 12 Play Button (▶) (PLAY) ☞ pg. 31
Select Button (SELECT)
- 13 Reverse Search Button (◀◀) ☞ pg. 33, 40
Reverse Slow Button (SLOW -) ☞ pg. 33

- 14 Stop Button (■) ☞ pg. 31, 40, 53, 80
Clear Button (CLEAR) ☞ pg. 34, 42, 49, 56
- 15 Record Button (● (REC)) ☞ pg. 53
- 16 One Touch Replay Button (↺) ☞ pg. 40, 41
- 17 Subtitle Button (SUBTITLE) ☞ pg. 35
- 18 Angle Button (ANGLE) ☞ pg. 35
Live Check Button (LIVE CHECK) ☞ pg. 40
- 19 Open/Close Button (▲ (OPEN/CLOSE)) ☞ pg. 10
- 20 Audio Button (AUDIO) ☞ pg. 35
TV Muting Button (🔇) ☞ pg. 88
- 21 TV/CABLE/SAT/DVD switch ☞ pg. 21
- 22 TV/CABLE/SAT STANDBY/ON Button (TV CBL SAT ψ /I) ☞ pg. 88
- 23 DVD STANDBY/ON Button (DVD ψ /I) ☞ pg. 21
- 24 Memo Button (MEMO) ☞ pg. 68, 75, 79
Mark Button (MARK) ☞ pg. 34
- 25 Play Set Up Button (PLAY SET UP) ☞ pg. 42
Progressive Scan Button (PROGRESSIVE SCAN) ☞ pg. 108
- 26 Display Button (DISPLAY) ☞ pg. 15, 34, 39, 54
- 27 Menu Button (MENU) ☞ pg. 32
- 28 \triangleleft / \triangleright Button ☞ pg. 25, 40
- 29 Enter Button (ENTER) ☞ pg. 21
- 30 Return Button (RETURN) ☞ pg. 36, 56
- 31 Forward Skip Button (▶▶) ☞ pg. 33, 40
Next Button (NEXT) ☞ pg. 36
- 32 Forward Search Button (▶▶) ☞ pg. 33, 40
Forward Slow Button (SLOW +) ☞ pg. 33
- 33 Pause Button (⏸ (PAUSE)) ☞ pg. 31, 40
- 34 Skip Search Button (◀) ☞ pg. 33, 40
- 35 Remain Button (REMAIN) ☞ pg. 34, 54
Recording Mode Button (REC MODE) ☞ pg. 53
- 36 TV Volume Button (◀+/-) ☞ pg. 88
- 37 TV/CBL DVD Programme Button (PR +/-) ☞ pg. 88

How To Use

The remote control can operate most of your unit's functions, as well as basic functions of TV sets and satellite receivers of JVC and other brands. (☞ pg. 87, "Remote Control Functions")

- Point the remote control toward the receiving window.
- The maximum operating distance of the remote control is about 8 m.

NOTES:

- When inserting the batteries, be sure to insert in the correct directions as indicated under the battery cover.
- If the remote control doesn't work properly, remove its batteries, wait for approximately 5 minutes, replace the batteries and then try operating the unit again.

Check Contents

CHECK ALL THE CONTENTS SHOWN BELOW

DVD Video Recorder

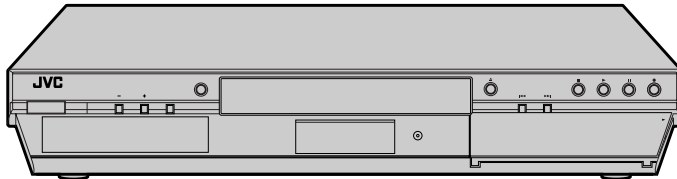

RF Cable

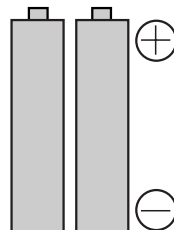

"AA" Batteries (x 2)

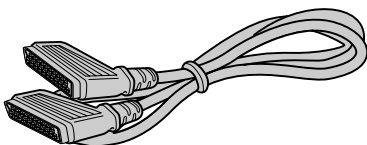

21-pin SCART Cable



Satellite Controller

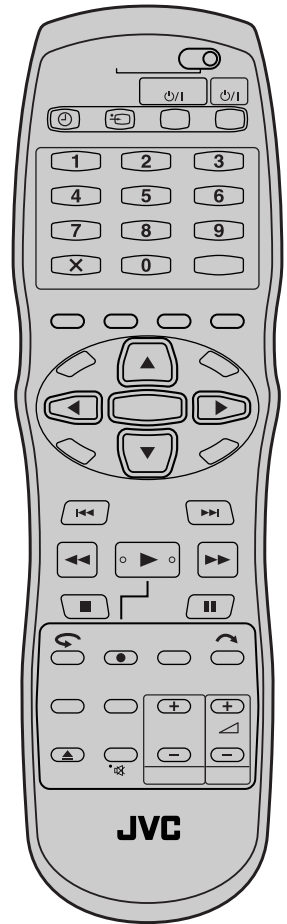

Infrared Remote Control Unit

► **You are now ready to install your unit.** (→ pg. 18)

Basic Connections

It's essential that your unit be properly connected.

THESE STEPS MUST BE COMPLETED BEFORE ANY VIDEO OPERATION CAN BE PERFORMED.

1 Install the unit.

Place the unit on a stable, horizontal surface.

2 Connect the unit to a TV.

- 1 Disconnect the TV aerial cable from the TV.
 - 2 Connect the TV aerial cable to the ANTENNA IN connector on the rear panel of the unit.
 - 3 Connect the ANTENNA OUT connector on the rear panel of the unit and the TV's aerial connector with the provided RF cable.
 - 4 Connect the L-1 IN/OUT connector on the rear panel of the unit and the TV's 21-pin SCART connector with a provided 21-pin SCART cable.
- The L-1 IN/OUT connector accepts and delivers either a composite signal (regular video signal), Y/C signal or RGB signal.
 - Select an appropriate option of "L-1 OUTPUT" as follows (☞ pg. 84):

When your TV's SCART connector accepts:	Set "L-1 OUTPUT" to:
Y/C signal (separated luminance (brightness) and chrominance (colour) signals)	"SCART S-VIDEO"
RGB signal	"SCART RGB"

- Set your TV to the VIDEO (or AV), Y/C, or RGB mode according to the type of your TV's SCART connector.
- For switching the TV's mode, refer to the instruction manual of your TV.

3 Connect the unit to mains.

Connect the AC plug of the mains power cord into a mains outlet.

- "LOADING" blinks on the front display panel when the AC plug of the mains power cord is connected into a mains outlet, and it takes the unit approximately 50 seconds to be turned on. This is not a malfunction.

After connection is completed, perform "Auto Set Up" on page 21.

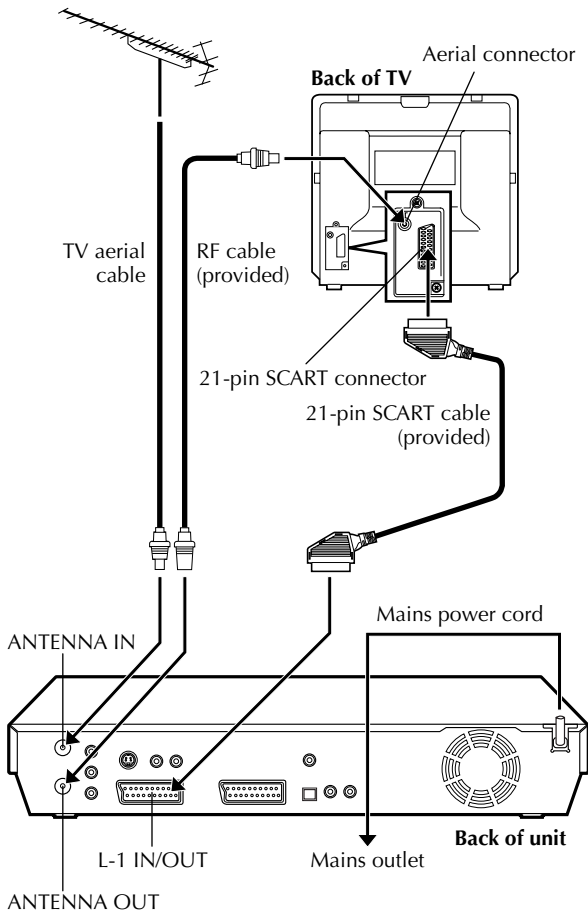

ATTENTION:

Your TV must have a 21-pin AV input connector (SCART) for the connection to the unit.

S-VIDEO Connection

- To connect to TV's S-VIDEO input and AUDIO input connectors

1 Connect the unit to a TV.

- 1 Connect the aerial, unit and TV as per "Basic Connections". (☞ pg. 18)
- 2 Connect the unit's S-VIDEO OUT connector to the TV's S-VIDEO input connector.
- 3 Connect the unit's AUDIO OUT connectors to the TV's AUDIO input connectors.

2 Connect the unit to mains.

Connect the AC plug of the mains power cord into a mains outlet.

NOTES:

- You can obtain high-quality S-VHS pictures.
- With S-VIDEO connection, you cannot use the Preset Download function. (☞ pg. 23)
- If your TV is not stereo-capable, use the unit's AUDIO OUT connectors to connect to an audio amplifier for Hi-Fi stereo sound reproduction.
- For switching the TV's video input mode, refer to the instruction manual of your television.

After the connection is completed, perform "Auto Set Up" on page 21.

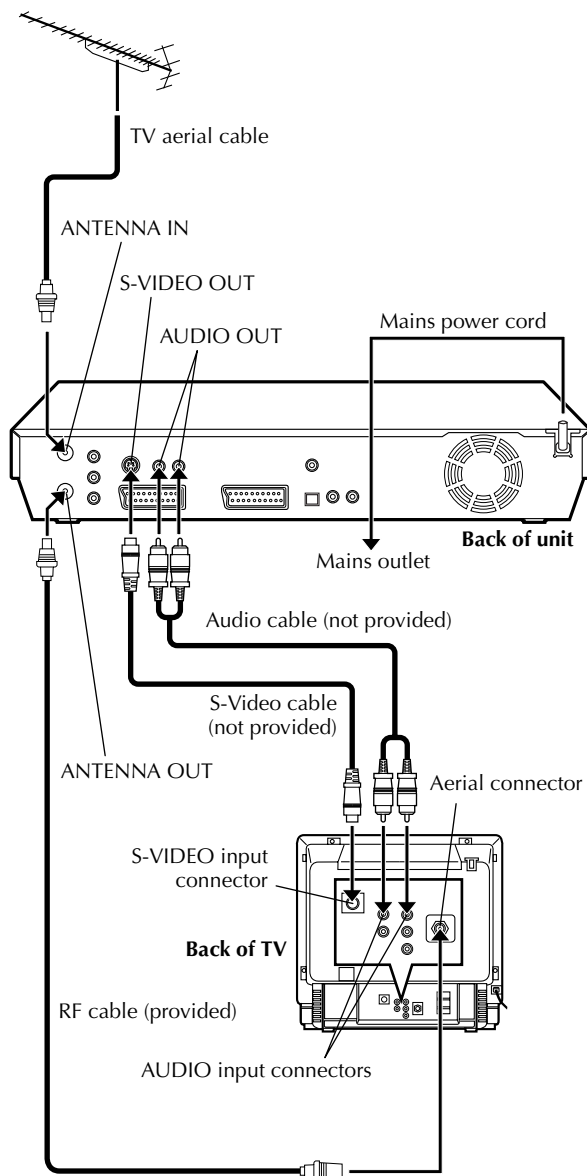

Component Video Connection

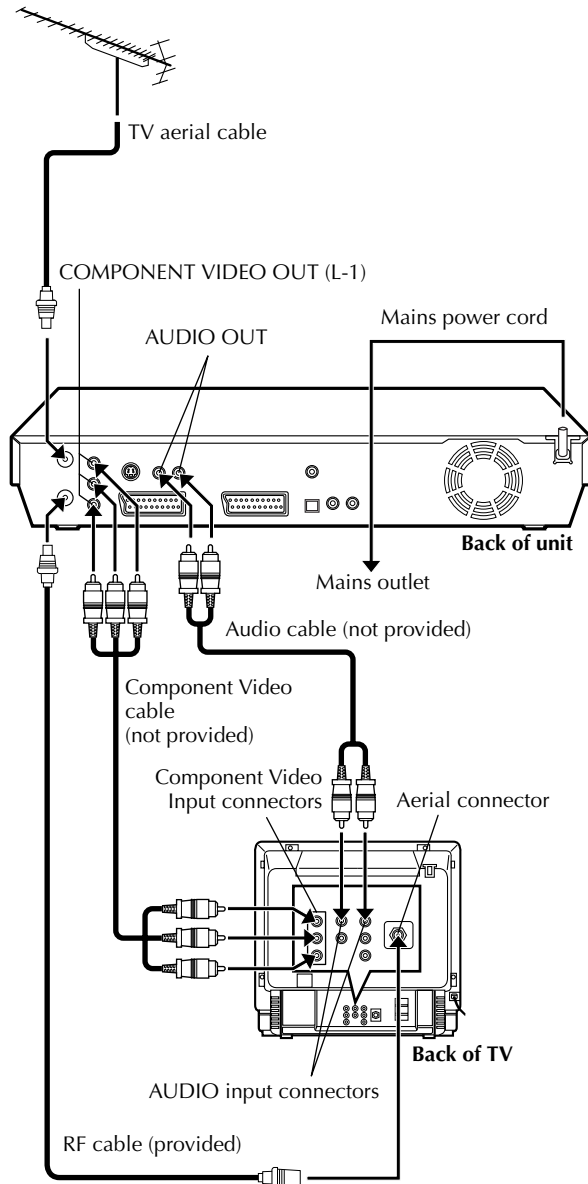

Component video connection enables you to obtain high-quality component video pictures.

■ To connect to TV's component video input connectors

1 Connect the unit to TV.

- 1 Perform 1 – 3 in step 2 in “Basic Connections” (pg. 18).
- 2 Connect the unit's COMPONENT VIDEO OUT connectors to the TV's component video input connectors.
- 3 Connect the unit's AUDIO OUT connectors to the TV's AUDIO input connectors.

2 Connect the unit to mains.

Connect the AC plug of the mains power cord into a mains outlet.

NOTES:

- If your TV is not stereo-capable, use the unit's AUDIO OUT connectors to connect to an audio amplifier for Hi-Fi stereo sound reproduction.
- For switching the TV's video input mode, refer to the instruction manual of your television.

After the connection is completed, perform “Auto Set Up” on page 21.

Auto Set Up

Auto Channel Set/Auto Clock Set/ Auto Guide Program Number Set

After the $\psi/1$ button on the unit (or DVD $\psi/1$ on the remote control) is pressed for the first time to turn on the unit, the Auto Set Up function sets the tuner channels, clock and Guide Program numbers automatically.

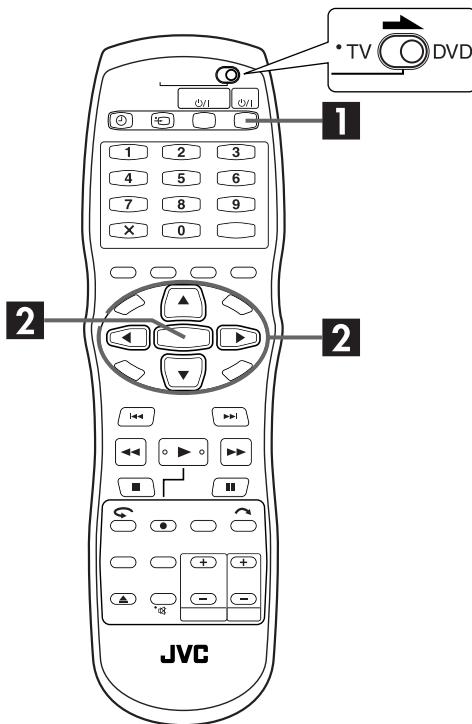
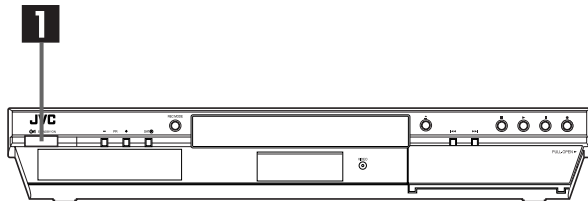

Before starting, make sure of the following:

- The TV aerial cable should be connected to the unit.
- The unit's mains power cord should be connected to a mains outlet.
- Turn on the TV and select the AV mode.
- Slide the TV/CABLE/SAT/DVD switch to DVD.

1 Turn on the unit.

On the unit

Press $\psi/1$ on the unit.

On the remote control

Press DVD $\psi/1$ on the remote control.

- The AUTO SET/T-V LINK display appears on the TV screen.

2 Perform Auto Set Up.

Press Δ/∇ to move the arrow to "AUTO SET", then press ENTER.

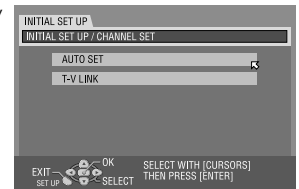

"AUTO" blinks on the front display panel; do NOT press any button on the unit or remote control until the front display panel shows "--:--" as illustrated on page 24.

- The AUTO SET screen will appear.

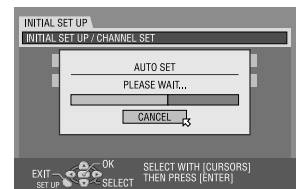

- When you have connected the unit to a TV offering T-V Link via a fully-wired 21-pin SCART cable (pg. 18) and the TV is turned on, the unit automatically performs the Preset Download (pg. 23) even if you select "AUTO SET" for Auto Set Up function.

ATTENTION:

Once you have performed Auto Set Up, even if the unit's memory backup has expired, all the stored stations and their Guide Program numbers remain in the unit's memory and the unit will not perform Auto Set Up again. The unit only performs Auto Clock Set when the unit is turned on.

If you have moved to a different area, perform each setting as required.

- Tuner setting (☞ pg. 98)
- Clock setting (☞ pg. 104)

If a new station starts broadcasting in your area, perform tuner setting. (☞ pg. 98, "Tuner Set")

NOTES:

- In areas where no TV station transmits a PDC (Programme Delivery Control) signal, the unit can perform neither Auto Clock Set nor Auto Guide Program Number Set.
- If there is a power cut, or if you press $\psi/1$ or **SET UP** while Auto Set Up is in progress, Auto Set Up will be interrupted; be sure to turn off the unit power once and try again from step **1**.
- Auto Clock Set may not function properly depending on the reception condition.

After "Auto Set Up" is completed, perform "Monitor Set" on page 25.

Preset Download

Auto Channel Set by Downloading from TV/Auto Clock Set/Auto Guide Program Number Set

ATTENTION:

You can use this function only with a TV offering T-V Link, etc.* Be sure to use a fully-wired 21-pin SCART cable.

* Compatible with TVs offering T-V Link, EasyLink, Megalogic, SMARTLINK, Q-Link or DATA LOGIC via a fully-wired 21-pin SCART cable. The degree of compatibility and available functions may differ by system.

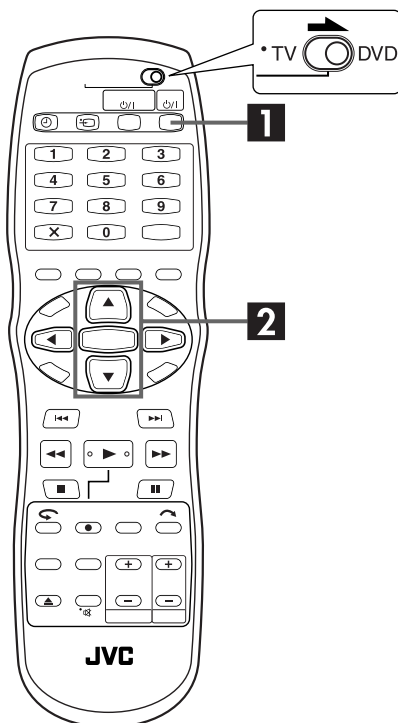

If you have connected the unit to your TV via a 21-pin SCART cable (☞ pg. 18), the unit will automatically perform Preset Download instead of the Auto Set Up in step 2 on page 21. After downloading, the unit sets the clock and Guide Program numbers automatically.

- Slide the TV/CABLE/SAT/DVD switch to DVD.

1 Turn on the unit.

On the unit

Press $\phi/1$ on the unit.

On the remote control

Press **DVD** $\phi/1$ on the remote control.

- The AUTO SET/T-V LINK display appears on the TV screen.

2 Perform Preset Download.

1 Press ENTER.

- The AUTO SET/T-V LINK display appears on the TV screen.

- #### 2 Press Δ/∇ to move the arrow to "T-V LINK" and press ENTER.

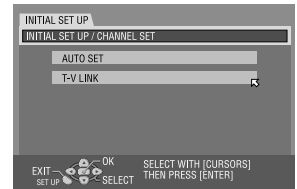

Preset positions on the front display panel increase from "PR 1"; do NOT press any button on the unit or remote control until the front display panel shows clock time, "PR 1" or "--:--" as illustrated on page 24.

- The T-V LINK screen will appear. When Preset Download is completed, "COMPLETED" appears for about 5 seconds, then the normal screen appears.
- If you press any button on the unit or remote control while downloading is in progress, it will be interrupted.

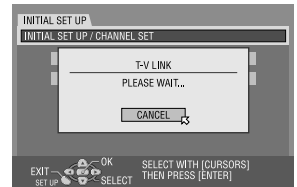

After "Preset Download" is completed, perform "Monitor Set" on page 25.

NOTES:

- For details, refer to the instruction manual of your TV.
- In the area where no TV station transmits a PDC (Programme Delivery Control) signal, the unit can perform neither Auto Clock Set nor Auto Guide Program Number Set.
- If there is a power cut, or if you press $\phi/1$ or **SET UP** while downloading or set up is in progress, it will be interrupted; be sure to turn off the unit power once and try again from the beginning.
- Auto Clock Set may not function properly depending on the reception condition.
- On this unit, the characters available for station names (ID) are A-Z, 0-9, -, *, + and _ (space). Some names of downloaded stations may differ from those of your TV. (☞ pg. 101, "Set Stations (B)")

Results of Auto Set Up/Presets Download appearing on the front display panel

A PR 1 20:00

If both Auto Channel Set and Auto Clock Set have been performed successfully, the correct current time is displayed.

Turn on the TV and select its AV mode, then make sure that all necessary stations have been stored in the unit's memory by using the **PR +/-** button(s).

- If station names (ID – pg. 102) have also been stored in the unit's memory, the station name will be displayed at the top right corner of the TV screen for about 5 seconds when the unit is tuned to a different station.
- If you want to set the tuner manually such as to add or skip channels, to change channel positions, or to set or change station names, see pages 99 – 102.

B PR 1 -:-:-

If Auto Channel Set has succeeded but Auto Clock Set has not, "PR 1" (channel position) is displayed.

OR

If both Auto Channel Set and Auto Clock Set have failed, "-:-:-" is displayed.

- 1 Turn on the TV and select its AV mode, then make sure that all necessary stations have been stored in the unit's memory by using the **PR +/-** button(s).
 - If station names (ID – pg. 102) have also been stored in the unit's memory, the station name will be displayed at the top right corner of the TV screen for about 5 seconds when the unit is tuned to a different station.
 - If you want to set the tuner manually such as to add or skip channels, to change channel positions, or to set or change station names, see pages 99 – 103.
- 2 Perform "Clock Set" on page 104.

NOTE:

After making sure the cables are connected properly, turn off the unit's power once, then turn the unit's power back on again.

Perform "Auto Set Up" on page 21 or "Presets Download" on page 23 again.

IMPORTANT:

- To check if the Guide Program numbers have been set correctly, perform the VIDEO Plus+ Timer Programming. (pg. 56)
- In certain reception conditions, station names may not be stored correctly, and auto Guide Program Number Set may not work properly. If the Guide Program numbers are not set properly when you timer-record a TV programme using the VIDEO Plus+ system, the unit will record a TV programme of a different station. When programming the timer using the VIDEO Plus+ system, be sure to check the desired channel is selected correctly. (pg. 56, "VIDEO Plus+ Timer Programming")
- Your unit memorizes all detected stations even if reception of some of them is poor. You can delete those stations with an unacceptable picture. (pg. 100, "Delete A Channel")

INFORMATION

Just Clock

Your unit is equipped with the Just Clock function which provides accurate time keeping through automatic adjustments at regular intervals, by reading data from a PDC signal. If you want to take advantage of this function, simply set it to "ON". (pg. 104, "Just Clock")

If you have any difficulty with the above procedures call the JVC Customer Service Hot Line on 0870 330 5000

Monitor Set

You can select the monitor type depending on the TV used when you play back DVD VIDEO discs recorded for wide-screen TVs.

- Turn on the unit.
- Turn on the TV and select the AV mode.
- Slide the **TV/CABLE/SAT/DVD** switch to **DVD**.

1 Access the Main Menu screen.

Press **SET UP**.

2 Access the "VIDEO IN/OUT" screen.

- 1 Press \triangleleft \triangleright to move the arrow to "FUNCTION SET UP", then press **ENTER**.
- 2 Press \triangleleft \triangleright to move the arrow to "VIDEO IN/OUT", then press **ENTER**.

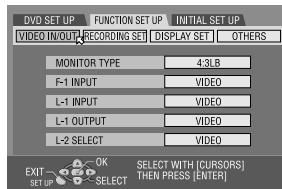

3 Select the desired option.

- 1 Press \triangle ∇ to select "MONITOR TYPE", then press **ENTER**.
- 2 Press \triangle ∇ to select the desired option, then press **ENTER**.

4 Complete the setting.

Press **SET UP**.

(The **boldface** settings in the table below indicate the settings at your purchase.)

MONITOR TYPE

4:3LB (Letter Box conversion):

Select this when the aspect ratio of your TV is 4:3 (conventional TV). While viewing a wide screen picture, the black bars appear on the top and the bottom of the screen.

4:3PS (Pan&Scan):

Select this when the aspect ratio of your TV is 4:3 (conventional TV). While viewing a wide screen picture, the black bars do not appear; however, the left and right edges of the pictures will not be shown on the screen.

16:9 AUTO (Wide television conversion):

Select this when the aspect ratio of your TV is 16:9 (wide TV).

16:9 FIX (Wide television conversion):

Select this when the aspect ratio of your TV is fixed to 16:9 (wide TV). The unit automatically adjusts the screen width of the output signal correctly when playing back a picture whose aspect ratio is 4:3.

Pan&Scan/Letter Box

In general, DVD VIDEO disc are produced for a wide-screen TV with 16:9 aspect ratio.

Material with this ratio will not fit to a TV with 4:3 aspect ratio. There are two styles to display the image, "Pan&Scan" (PS) and "Letter Box" (LB).

Pan&Scan

The right and left side of the image are cut off. The image fills the screen.

- The picture will be shown in the "4:3LB" mode depending on the disc even if the "4:3PS" mode is selected.

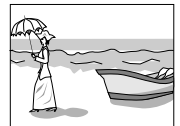

Letter Box

Black bands appear at the top and bottom of the image. The image itself appears in 16:9 aspect ratio.



Language

- Turn on the unit.
- Turn on the TV and select the AV mode.
- Slide the **TV/CABLE/SAT/DVD** switch to **DVD**.

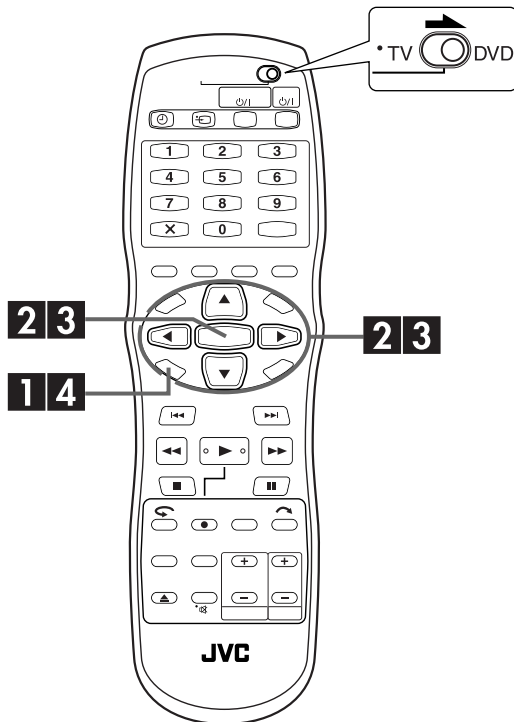

Menu/Audio/Subtitle Language Set

Some DVD discs contain the DVD menu display, audio and subtitles in multiple languages. With these discs, you can set the default language as you like.

- The procedure shows how to set "MENU LANGUAGE" as an example.

1 Access the Main Menu screen.

Press **SET UP**.

2 Access the "LANGUAGE SET" screen.

- 1 Press $\triangleleft \triangleright$ to move the arrow to "DVD SET UP", then press **OK**.
- 2 Press $\triangleleft \triangleright$ to move the arrow to "LANGUAGE SET", then press **ENTER**.

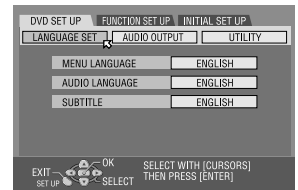

3 Select the desired language.

- 1 Press $\triangle \nabla$ to move the arrow to "MENU LANGUAGE", then press **ENTER**.
 - See "Language Code List" (pg. 27).
- 2 Press $\triangle \nabla$ to select your desired language, then press **ENTER**.

4 Complete the setting.

Press **SET UP**.

NOTE:

When the selected language is not available on the disc, the disc's default menu language is played back.

Language Code List

AA	Afar
AB	Abkhazian
AF	Afrikaans
AM	Ameharic
AR	Arabic
AS	Assamese
AY	Aymara
AZ	Azerbaijani
BA	Bashkir
BE	Byelorussian
BG	Bulgarian
BH	Bihari
BI	Bislama
BN	Bengali, Bangla
BO	Tibetan
BR	Breton
CA	Catalan
CO	Corsican
CS	Czech
CY	Welsh
DZ	Bhutani
EL	Greek
EO	Esperanto
ET	Estonian
EU	Basque
FA	Persian
FJ	Fiji
FO	Faroese
FY	Frisian
GA	Irish
GD	Scots Gaelic
GL	Galician
GN	Guarani
GU	Gujarati
HA	Hausa
HI	Hindi
HR	Croatian
HU	Hungarian
HY	Armenian
IA	Interlingua
IE	Interlingue

IK	Inupiak
IN	Indonesian
IS	Icelandic
IW	Hebrew
JA	Japanese
JL	Yiddish
JW	Javanese
KA	Georgian
KK	Kazakh
KL	Greenlandic
KM	Cambodian
KN	Kannada
KO	Korean (KOR)
KS	Kashmiri
KU	Kurdish
KY	Kirghiz
LA	Latin
LN	Lingala
LO	Laothian
LT	Lithuanian
LV	Latvian, Lettish
MG	Malagasy
MI	Maori
MK	Macedonian
ML	Malayalam
MN	Mongolian
MO	Moldavian
MR	Marathi
MS	Malay (MAY)
MT	Maltese
MY	Burmese
NA	Nauru
NE	Nepali
OC	Occitan
OM	(Afan) Oromo
OR	Oriya
PA	Panjabi
PL	Polish
PS	Pashto, Pushto
PT	Portuguese
QU	Quechua
RM	Rhaeto-Romance

RN	Kirundi
RO	Rumanian
RU	Russian
RW	Kinyarwanda
SA	Sanskrit
SD	Sindhi
SG	Sangho
SH	Serbo-Croatian
SI	Singhalese
SK	Slovak
SL	Slovenian
SM	Samoa
SN	Shona
SO	Somali
SQ	Albanian
SR	Serbian
SS	Siswati
ST	Sesotho
SU	Sundanese
SW	Swahili
TA	Tamil
TE	Telugu
TG	Tajik
TH	Thai
TI	Tigrinya
TK	Turkmen
TL	Tagalog
TN	Setswana
TO	Tonga
TR	Turkish
TS	Tsonga
TT	Tatar
TW	Twi
UK	Ukrainian
UR	Urdu
UZ	Uzbek
VI	Vietnamese
VO	Volapuk
WO	Wolof
XH	Xhosa
YO	Yoruba
ZU	Zulu

Satellite Receiver Control Setting

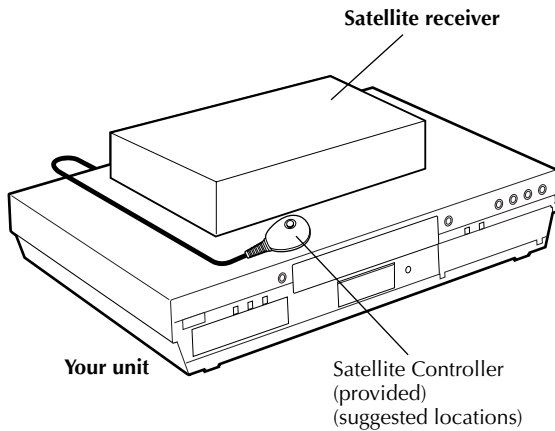

Installing Satellite Controller

1 Install a Satellite Controller.

Place a Satellite Controller so that the path between its transmitter and the satellite receiver's remote sensor is unobstructed.

2 Attach the Satellite Controller.

Fix securely using the adhesive strip attached on the back of the Satellite Controller.

3 Make connections.

Be sure to connect the unit's L-2 IN/DECODER connector to the satellite receiver's 21-pin SCART connector.

NOTE:

When connecting your satellite receiver, refer to its instruction manual.

4 Connect the Satellite Controller to unit.

Connect the Satellite Controller to the SAT CONTROL connector on the rear panel.

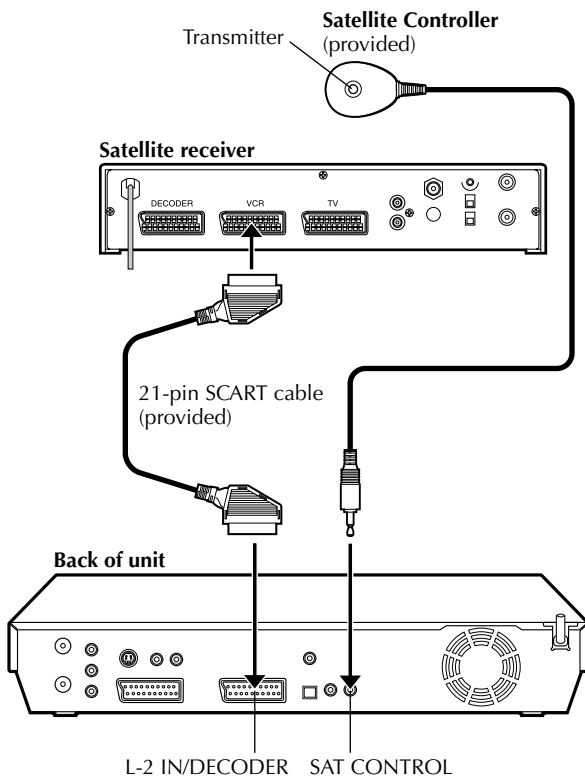

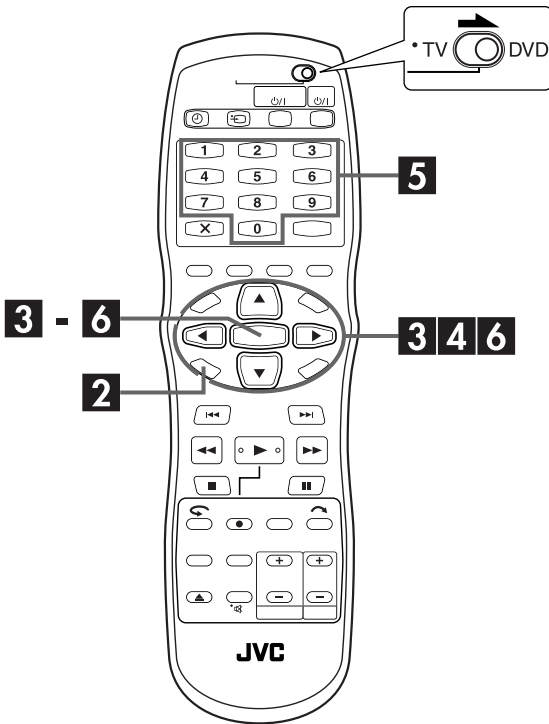

Setting satellite receiver's brand and channel

After installation, set the satellite receiver's brand and channel correctly; otherwise, the Satellite Controller cannot work correctly.

- Turn on the unit.
- Turn on the TV and select the AV mode.
- Slide the **TV/CABLE/SAT/DVD** switch to **DVD**.

1 Turn on the satellite receiver.

Turn on the satellite receiver's power.

2 Access the Main Menu screen.

Press **SET UP**.

3 Access the "SAT/GUIDE PR" screen.

- 1 Press $\triangleleft \triangleright$ to move the arrow to "INITIAL SET UP", then press **ENTER**.
- 2 Press $\triangleleft \triangleright$ to move the arrow to "SAT/GUIDE PR", then press **ENTER**.

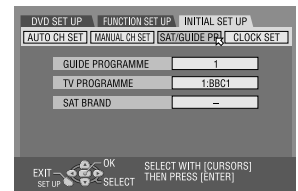

4 Select the satellite receiver's brand.

- 1 Press $\triangle \nabla$ to move the arrow to "SAT BRAND", then press **ENTER**.
 - 2 Press $\triangle \nabla$ to select the brand code from the list on page 30, then press **ENTER**.
- If the brand code you entered is invalid, the code field will be reset. Enter the correct brand code again.
 - If the unit is in playback or recording mode, you cannot set the brand code.

5 Select the satellite receiver's channel for testing.

Press the appropriate **number keys** to enter one of the channel positions on the satellite receiver, then press **ENTER** twice.

- You can select the channel position between 1 to 999.
- After pressing **ENTER**, the unit enters the Test mode.



6 Check the result of the test.

If the satellite receiver's channel number has been changed to the same one as you set in step 5.

Press \triangleleft \triangleright to move the arrow to "YES", then press **ENTER** to finish the Sat Control Set mode.

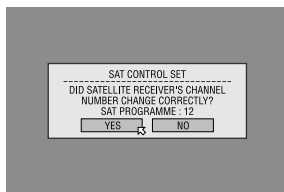

If the satellite receiver's channel number has not been changed correctly

Press \triangleleft \triangleright to move the arrow to "NO", then press **ENTER**. Then perform the procedure again from step 4.

BRAND NAME	CODE
JVC	73
AMSTRAD	60, 61, 62, 63, 92
ASTON	97
CANAL SATELLITE	81
CANAL +	81
D-BOX	85
ECHOSTAR (VIA DIGITAL)	82
FINLUX	68
FORCE	89
GALAXIS	88
GRUNDIG	64, 65, 102
HIRSCHMANN	64, 78, 99
HUMAX	88
ITT NOKIA	68
JERROLD	75
KATHREIN	70, 71, 96
LUXOR	68
MASCOM	93
MASPRO	70
NOKIA	87, 94
PACE	65, 67, 74, 86, 92, 97
PANASONIC	74, 92
PHILIPS	66, 84, 101
RADIX	78
RFT	69
SABA	97
SAGEM	83, 90
SALORA	68
SAMSUNG	83
SIEMENS	64
SKYMASTER	69, 98
TECHNISAT	66, 100
THOMSON	97
TPS	83
TRIAx	91
WISI	64

NOTES:

- The Satellite Controller may not work with all types of satellite receiver.
- For some satellite receivers, you need to set its channel input mode to 2-digit.
- If your satellite receiver has more than two channel modes, be sure to set to "All Channel Mode". For details, refer to the instruction manual of the satellite receiver.
- When selecting the satellite receiver's channel (step 5), signals from the remote control may interfere with signals transmitted from the Satellite Controller. In this case, move the remote control as close to the unit's infrared beam receiving window as possible.

T-V Link Functions

When you connect the unit to your TV via a fully-wired 21-pin SCART cable (pg. 18), the following functions are available. You can use these functions only with a TV offering T-V Link, etc.*

For details, refer to the instruction manual of your TV.

* Compatible with TVs offering T-V Link, EasyLink, Megalogic, SMARTLINK, Q-Link or DATA LOGIC via a fully-wired 21-pin SCART cable. The degree of compatibility and available functions may differ by system.

TV Auto Power On

The TV will turn on and be set to its AV mode automatically whenever you start playback.

For details, refer to the instruction manual of your TV.

Unit Auto Standby

You can use your TV's remote control to turn off the unit.

For details, refer to the instruction manual of your TV.

Direct Rec

You can easily start recording the programme that you are watching on your TV. When you use this function, set "DIRECT REC" to "ON". (pg. 94)

Basic Playback



- Turn on the unit.
- Turn on the TV and select the AV mode.
- Slide the **TV/CABLE/SAT/DVD** switch to **DVD**.

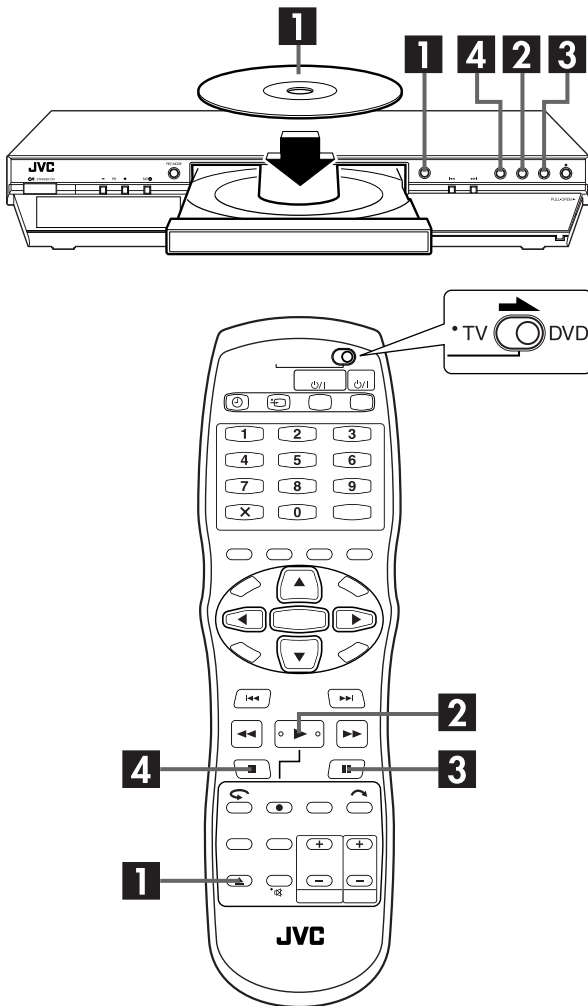

ATTENTION:

- It takes approximately 30 seconds to read a disc depending on the type and condition of the disc since this unit is multi-disc compatible (DVD-RAM, DVD-RW, DVD-R). It may even take several minutes when a disc is dirty, scratched or warped.
- It may take a few seconds to start playback. This is not a malfunction.
- Forward/reverse high-speed search and other operations cannot be performed while playback is stopped.

To play back an MP3/JPEG disc, see "Playback with MP3/JPEG Navigation" (☞ pg. 78).

1 Load a disc.

- 1 Press **▲** to open the disc tray.
 - 2 Place the disc on the disc tray.
 - 3 Press **▲** to close the disc tray.
- For details, refer to "Placing a Disc" (☞ pg. 10).
 - Pressing **▶** also closes the disc tray.
 - Playback begins automatically if an auto-playback DVD disc is loaded.

2 Start playback.

Press **▶**.

- If you load a DVD disc whose region code does not match the unit, "REGION CODE ERROR" appears on the TV screen. For details, refer to "Region Number" (☞ pg. 7).
- If "The DISC can't play now!" appears on the TV screen, refer to "Parental Lock" (☞ pg. 49).
- With Video CD discs with PBC control or some DVD discs, the menu display may appear on the TV screen after starting playback. In this case, select an item which you want to play back from the menu. Otherwise, the playback cannot go forward. Refer to "Locating a desired scene using the menu of a Video CD with PBC" (☞ pg. 36) or "Locating a desired scene using the DVD menu" (☞ pg. 32).
- The Library Database DVD Navi also enables you to search and select the desired programmes. (☞ pg. 66)

3 Pause playback.

Press **⏸**.

- To resume normal playback, press **▶**.

4 Stop playback.

Press **■**.

- When a recordable disc is played, playback stops and a programme received with the unit's tuner resumes on the TV screen.
- When a playback-only disc is played, playback stops and the still image at the time you press **■** remains on the TV screen. Pressing **■** again resumes a programme received with the unit's tuner.
- If **▲** is pressed during playback, playback stops, then the disc tray opens.

NOTES:

- When the Library Database DVD Navi screen appears, choose a thumbnail image of the desired programme on the TV screen, then press **▶** or **ENTER**. (☞ pg. 68)
- When **▶** is pressed for the first time after purchase or a power cut, menu screen appears. (☞ pg. 104)

Playback Features

- Turn on the unit.
- Turn on the TV and select the AV mode.
- Slide the **TV/CABLE/SAT/DVD** switch to **DVD**.

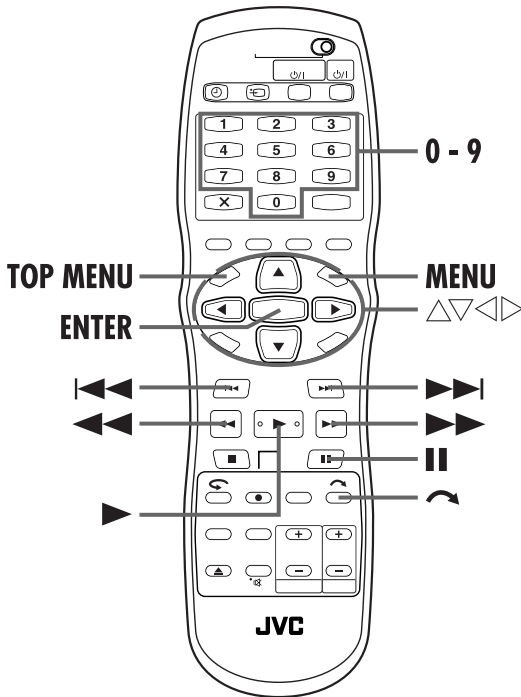

Locating a desired scene using the DVD menu



DVD VIDEO discs may have top menu and disc menu.

Top menu

DVD discs generally have their own menus which show the disc contents. These menus contain various items such as titles of a movie, names of songs, or artist information. You can locate a desired scene by using the top menu displayed on the TV screen. Press **TOP MENU** to access the top menu.

Disc menu

Disc menus include playback data (angle menu, subtitle menu, etc.) specific to each title. Press **MENU** to access the disc menu.

1 Access the DVD menu.

Press **TOP MENU** or **MENU**. Example:



2 Start playback.

Press **△▽◀▶** to select a desired title, then press **ENTER**.

- It may be possible to select the desired item using the **number keys** depending on the menu display.

NOTE:

When "⊙" appears on the TV screen in step 1, the disc does not have a top menu or disc menu.

Locating the start point of the item or skip the item



Press **⏮** or **⏭** during playback.

- Pressing **⏭** locates the start point of the item or skips the item for forward direction, then resumes playback.
- Pressing **⏮** locates the start point of the item or skips the item for reverse direction, then resumes playback.

When a DVD-RAM/RW/R disc is played

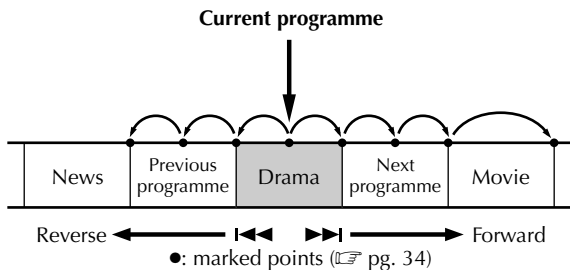

Example:

- To locate the beginning of the next item, press **⏭** once.
- To locate the beginning of the current item, press **⏮** once.
- To locate the beginning of the previous item, press **⏮** three times.

When a DVD VIDEO, Audio CD or Video CD disc is played

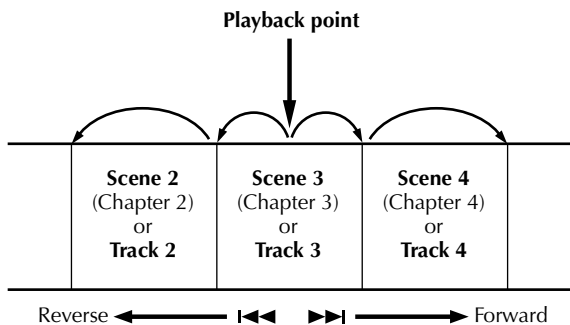

Example:

- To locate the beginning of the next item, press **⏭** once.
- To locate the beginning of the current item, press **⏮** once.

High-Speed Search



During playback, press **⏭** for forward high-speed search, or **⏮** for reverse high-speed search.

- Each press of the button increases the search speed for each direction.
- To resume normal playback, press **▶**.

OR

During playback, press and hold **⏭** for 2 or more seconds for forward high-speed search, or press and hold **⏮** for 2 or more seconds for reverse high-speed search.

- Releasing the button resumes normal playback.

Still Picture/Frame-By-Frame Playback



1 Pause during playback.

Press **⏸**.

2 Activate frame-by-frame playback.

Press **⏸**.

- Each press of **⏸** advances the still picture frame by frame.

OR

Press **◀▷**.

- Each press of **◀▷** advances/reverses the still picture frame by frame.
- Frame-by-frame playback for reverse direction cannot be performed with Video CD discs.
- To resume normal playback, press **▶**.

Slow Motion



While paused, press **⏮** or **⏭**.

- Each press of **⏮** or **⏭** increases the slow motion speed for each direction (from 1/16 to 1/2 times the normal speed).
- Slow motion for reverse direction cannot be performed with Video CD discs.

OR

Press **⏮** or **⏭** for 2 or more seconds.

Skip Search



During playback, press **⏭**.

- Each press initiates an approximately 30-second period of fast-motion playback. Normal playback resumes automatically.

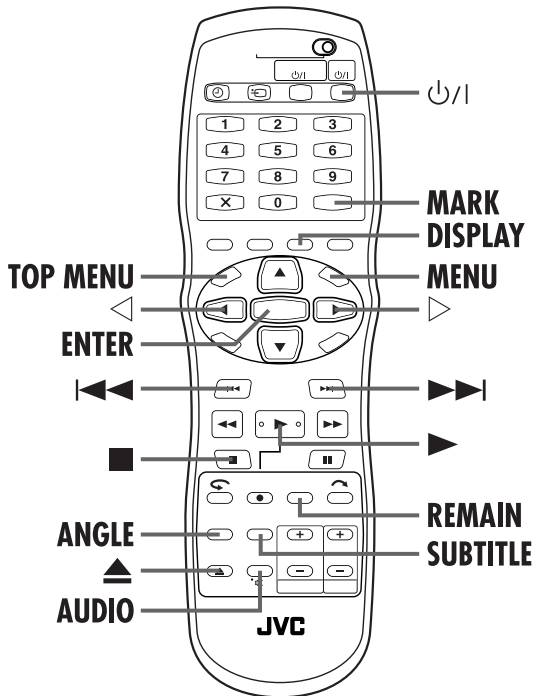

Resume Function



It is possible to memorise the position where you stop playback and resume playback from that position.

1 Memorise a resume point.

Press ■ during playback.

- The unit enters Resume Stop mode and memorises the position where you have stopped playback as a resume point. (The inside of the disc status indicator on the front display panel blinks while memorising.)
- To clear the resume points: (The inside of the disc status indicator stops blinking and lights.)
 - Press $\phi/1$ to turn off the unit.
 - Press ▲ to take out the disc.
 - Press ■ in stop mode.
 - Press **TOP MENU** to display the top menu, then start playback by selecting an item, etc.
 - Press **MENU** to display the disc menu, then start playback by selecting an item, etc.

2 Resume playback.

Press ► in stop mode. The unit starts playback from the resume point.

Marking positions to play again later



It is possible to mark positions (up to 999 points) where you want to play back once again later, and start playback from a marked position. Marking onto DVD-RAM/RW/R discs when recording is helpful to locate a start point when you play back the discs later.

1 Mark positions.

During playback, press **MARK** at positions you want to mark.

- “MARK” appears on the TV screen. You can easily locate the marked positions using ◀◀ or ▶▶ when you play back the disc.



2 Delete the marked positions.

While paused, press ◀◀ or ▶▶ to locate a marked position you want to delete, then press **MARK**.

- Crossed “MARK” appears on the TV screen, and the marked position is deleted.



NOTES:

- When a monaural programme or bilingual programme changes to a stereo programme while recording, a mark signal is automatically recorded.
- When a DVD-R/RW (Video mode) disc is finalised, marked points marked before finalising will be deleted, and programmes will be divided automatically into “chapters” approximately every 5 minutes. (☞ pg. 107, “Finalise a disc”)

Checking the disc remaining time



You can change the counter display on the front display panel and TV screen to check disc remaining time (only discs before finalising).

During playback

Each press of **DISPLAY** changes the display as follows:

- Clock time (front display panel only) → Current title elapsed time → Disc remaining time → (back to the beginning)
- Clock time is displayed only when a recordable disc is played.

In stop mode or during playback

- It is possible to check disc remaining time according to recording modes also by pressing **REMAIN**.
- In FR mode, it is possible to set recording time in detail using ◀▶. (☞ pg. 55, “Free Rate Function”)
- It is not possible to switch the recording mode during playback or while recording.

Switching Time Indication



You can check time information of an audio CD and a Video CD on the front display panel and the TV screen.

Each press of **DISPLAY** changes the time indication as follows:

During playback

Current track elapsed time → Current track remaining time →

Total elapsed time → Total remaining time → (back to the beginning)

In stop mode

0:00 → Playback time of track 1 → 0:00 → Total length of a disc → (back to the beginning)

NOTE:

When a PBC-compatible Video CD disc is loaded, deactivate the PBC function. (pg. 36)

Angle Selection



You can enjoy a variety of scene angles if a DVD VIDEO disc contains “multi-angle” parts, where the same scene was shot from different angles.

If the disc contains “multi-angle” parts, “” appears on the TV screen at the beginning of the “multi-angle” part.

1 Access Angle display.

Press **ANGLE** during playback.

- The angle selection display appears on the TV screen.



(When 3 scene angles are contained.)

2 Select the angle.

Press **ANGLE** or $\triangleleft \triangleright$ to select your desired angle.

- Each time you press **ANGLE** or $\triangleleft \triangleright$, the angle changes.
- When “” appears on the TV screen, the current scene is not recorded from multiple angles. In addition, some discs prohibit angle selection.
- To clear the angle selection display, press **ENTER**. In addition, the angle selection display disappears automatically if no operation is done for 10 seconds.

Subtitle Selection



Some DVD VIDEO discs contain more than one subtitle language, from among which you can choose the desired subtitle language. “” appears on the TV screen at the beginning of the part where more than one subtitle language are recorded.

1 Access Subtitle display.

Press **SUBTITLE** during playback.

- The subtitle selection display appears on the TV screen.
- Each time you press **SUBTITLE**, the subtitle display is switched on and off.

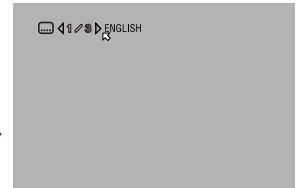

(When 3 subtitle languages are contained.)

2 Select the subtitle language.

Press $\triangleleft \triangleright$ to select your desired language.

- To clear the subtitle selection display, press **ENTER**.

NOTES:

- When “” appears on the TV screen, no subtitle language is recorded.
- When the subtitle language won't be changed with the procedure above, change the subtitle on a disc menu displayed by pressing **MENU**.

Audio Language/Sound Selection



Some DVD VIDEO discs contain the multiple audio language or sound. You can select the desired audio language or sound. For some Video CD discs, you can switch the audio channel to choose Karaoke either with or without the vocal.

1 Access Audio Language/Sound selection display.

Press **AUDIO** during playback.

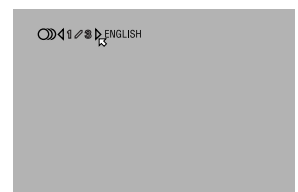

(When 3 audio languages are contained.)

2 Select the audio language/sound.

Each time you press **AUDIO** or $\triangleleft \triangleright$, the audio language/sound changes.

- To clear the Audio Language/Sound selection display, press **ENTER**.

NOTES:

- When “” appears on the TV screen, no audio language is recorded.
- When the audio language won't be changed with the procedure above, change the audio on a disc menu displayed by pressing **MENU**.
- It is only possible to select the audio language in stop mode. The audio language cannot be selected during playback.

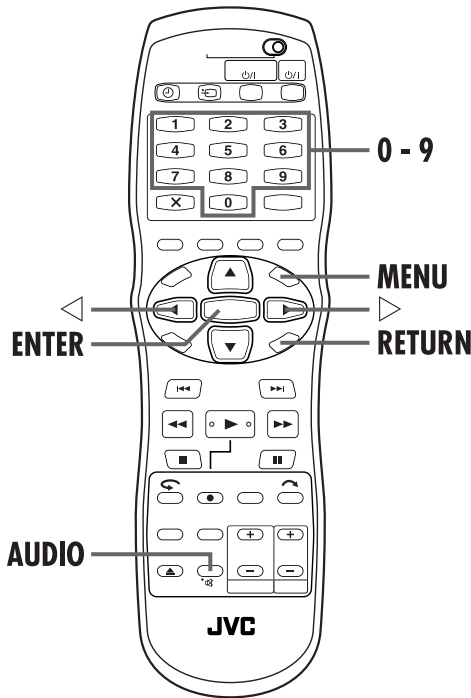

NOTE:

It is not possible for DVD-R/DVD-RW (Video mode) disc playback to switch the audio channel. The audio channel is played back as set in "AUDIO REC" (pg. 94).

When you can't switch the audio channel of a bilingual programme

When the unit is connected with a digital audio device using an optional optical cable and "DIGITAL AUDIO OUT" is set to "DOLBY DIGITAL/PCM", it is not possible to switch the audio channel of a bilingual programme recorded on a DVD-RAM or DVD-RW (VR mode) disc. (pg. 91) In this case, perform the following steps using the remote control to switch "DIGITAL AUDIO OUT" from "DOLBY DIGITAL/PCM" to "PCM ONLY".

- 1 Press **SET UP** to access the Main Menu screen.
- 2 Press < > to select "DVD SET UP", then press **ENTER**.
- 3 Press < > to select "AUDIO OUTPUT", then press **ENTER**.
- 4 Press < > to select "DIGITAL AUDIO OUT", then press **ENTER**.
- 5 Press < > to select "PCM ONLY", then press **ENTER**. (pg. 93)
- 6 Press **SET UP** to complete the setting.
- 7 Press **AUDIO** to select the desired audio channel.

Audio Channel Selection



When watching bilingual programmes or playing discs on which you recorded bilingual or stereo programmes, you can choose the desired audio channel.

- When "SUPERIMPOSE" is set to "AUTO" or "ON", you can confirm on the TV screen the audio channel you have chosen. (pg. 95)
- Each time you press **AUDIO**, the audio channel changes.

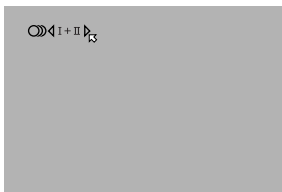

TRACK	USE
On-Screen Display	
I+II	For main and sub audio of bilingual programme
I	For main audio of bilingual programme
II	For sub audio of bilingual programme
L+R	For stereo discs
L	For audio of left channel
R	For audio of right channel

Playback Control (PBC) Function

— Locating a desired scene using the menu of a Video CD with PBC



Some Video CD discs support the PBC function. PBC is an abbreviation of "Play Back Control". A Video CD disc recorded with PBC has its own menus, such as a list of the songs on the disc. You can locate a specific scene by using the menu.

1 Access the PBC menu.

In stop mode

Press **>**.

2 Start playback.

Press the **number keys** to enter the number of the desired scene.

- The unit starts playback of the selected item. "PBC" appears on the front display panel.
- When "NEXT" or "PREVIOUS" appears on the TV screen: Pressing **>>>** advances to the next page. Pressing **<<<** returns to the previous page.
- You can return to the menu by pressing **RETURN**.
- The method of the operation is different depending on the disc.

NOTES:

- If you want to playback a PBC-compatible Video CD disc without activating the PBC function, start playback in stop mode by using the **number keys**, instead of the **>** button, to choose the track, then press **ENTER**.
- To activate the PBC function when a PBC-compatible Video CD disc is being played back without the PBC function, press **TOP MENU**, or press **■** then press **>**.

Live Memory Playback



This unit records pictures onto DVD-RAM discs, instead of video tapes, then plays back the pictures recorded on the discs. This makes it possible to achieve high-speed writing and read-out that has not been possible with conventional VCRs, enabling recording and playback simultaneously.

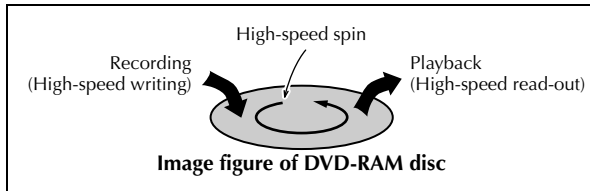

It is called "Live Memory Playback" to start playback of the programme being recorded, with a time-lag between a recording point and a playback point, as shown in the figure below.

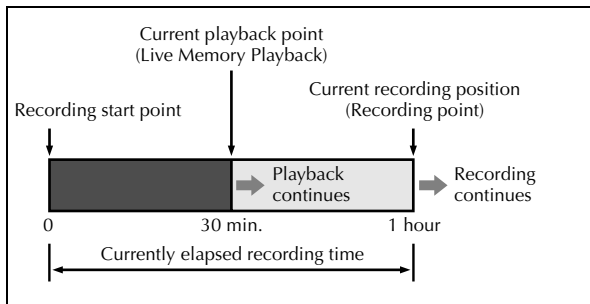

Not only can this unit play back a programme previously recorded while recording or timer recording another programme, but the unit also allows you to play back from the beginning of a programme while continuing to record the same programme.

Recording/playback status display

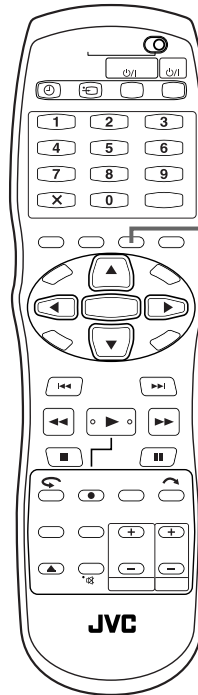

DISPLAY

Live Memory Playback status can be checked by pressing **DISPLAY** to display the bar meter on the superimpose display.

Press **DISPLAY**. The current status is superimposed on the TV screen.

Bar meter display



Superimpose display

Overview of Live Memory Playback

You can play back a programme you are recording from the beginning while continuing to record or timer record onto a DVD-RAM disc. This is called "Live Memory Playback".

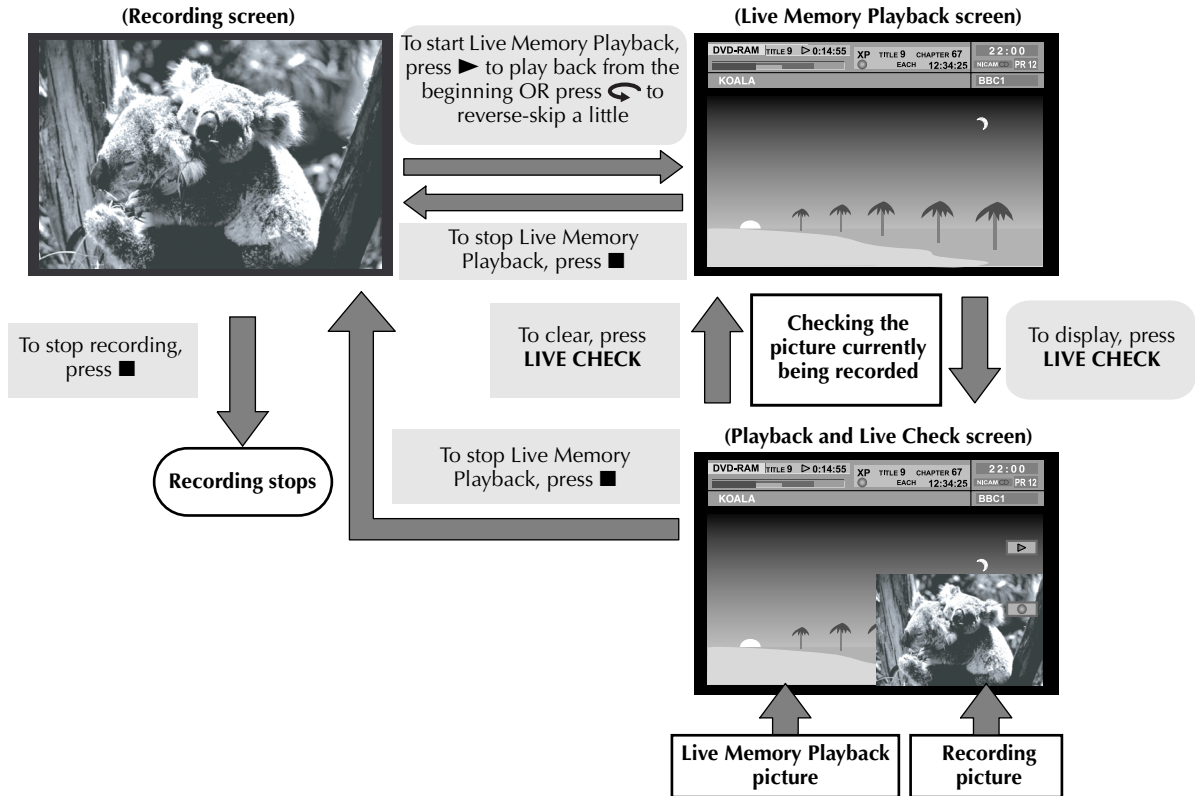

NOTES:

- Live Memory Playback cannot be performed for approximately 30 seconds after recording has started.
- Although high-speed search up to approximately 30 seconds before the current recording point is possible during Live Memory Playback, once the current recording point is reached, the unit resumes normal playback and maintains a delay of approximately 30 seconds so that recording and playback can continue.
- When using Live Memory Playback during timer recording, playback continues even after the end of the recording.
- When using Live Memory Playback during timer recording, playback is automatically stopped just before recording starts, and then recording starts when the time arrives for the next timer-programme.
- It is impossible to perform ITR even if you press ● during Live Memory Playback. (☞ pg. 54, "Instant Timer Recording (ITR)")
Press ■ to display the programme being recorded, then perform ITR settings.
- Playback may be paused for a moment during Live Memory Playback, which does not interfere with recording.
- Live Memory Playback cannot be performed while recording the source from DV input.
- When **LIVE CHECK** is pressed to display the picture currently being recorded, the picture size may not be correct.

Display during Live Memory Playback

During recording, you can watch at your will what was previously recorded or is currently being recorded. It is possible to perform freely normal playback operations (forward/reverse high-speed search and variable-speed search) within the range of the red or blue bar on the TV screen.

When Live Memory Playback reaches the point of 30 seconds before the current recording point by forward high-speed search or other operations, the unit returns to normal playback.

The superimpose display appears by pressing **DISPLAY**. (pg. 15)

The Live Check picture is displayed on the bottom right corner by pressing **LIVE CHECK**.

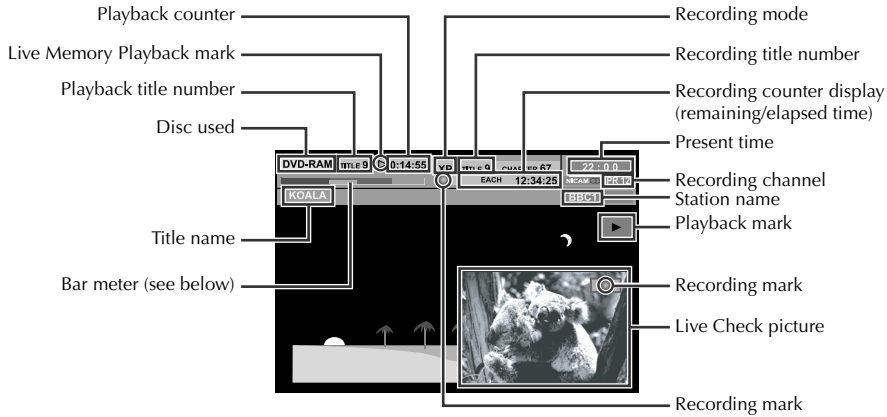

This unit displays the current recording/playback status by the bar meter.
(Example of bar meter display)

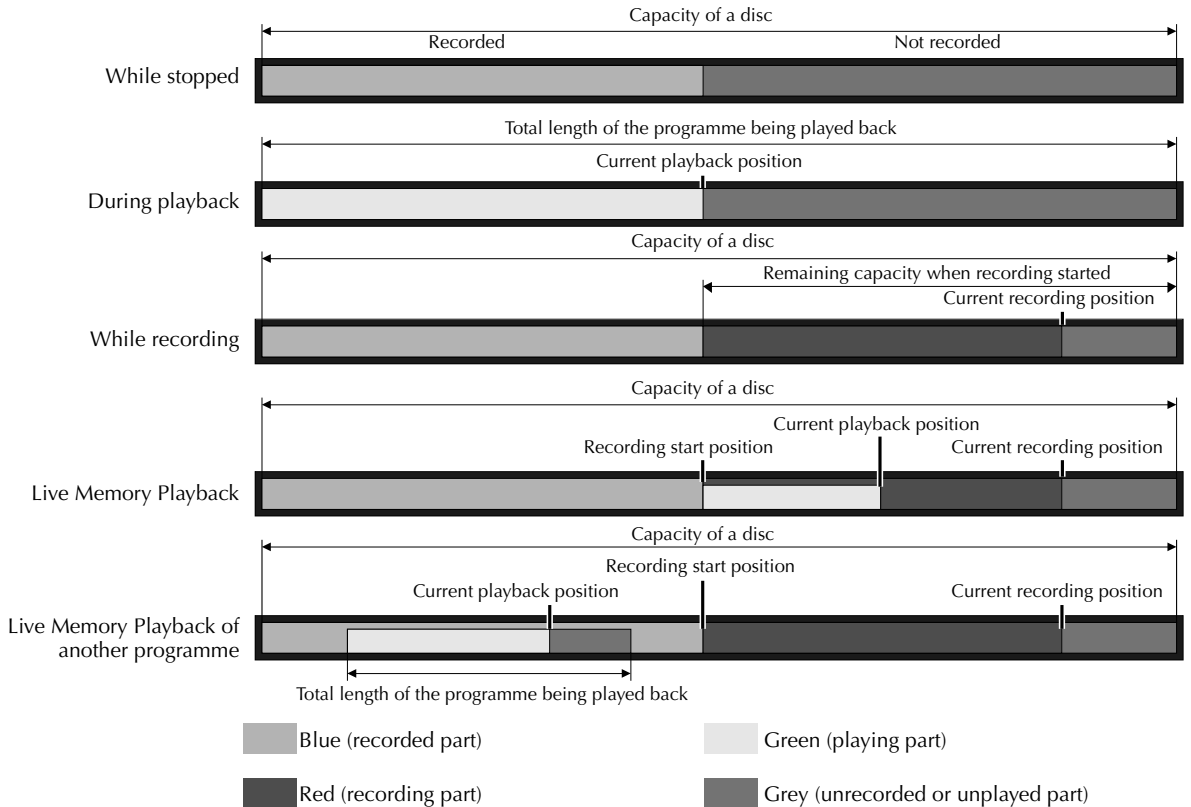

Buttons to be used during Live Memory Playback

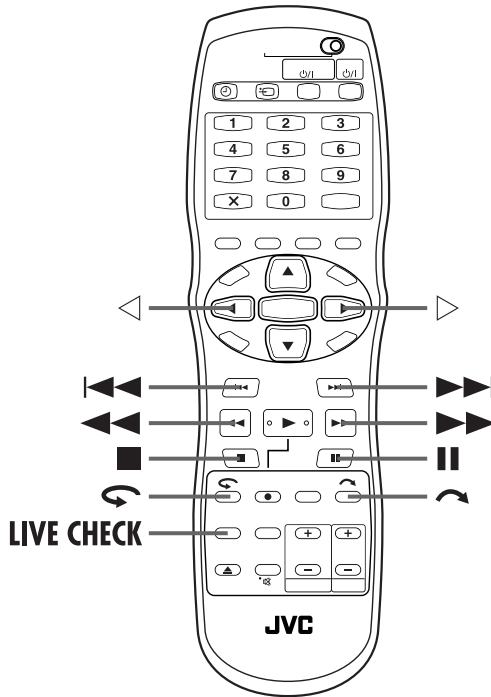

Available buttons	Functions
	<ul style="list-style-type: none"> Pressing once skips forward to the beginning of the next chapter being played back. Pressing down for 2 or more seconds during playback advances playback at 5 times the normal speed while pressed. Releasing the button resumes normal playback. <p>Available only when paused</p> <ul style="list-style-type: none"> Pressing down for 2 or more seconds advances playback at 1/16 times the normal speed.
	<ul style="list-style-type: none"> Pressing once skips back to the beginning of the chapter being played back. Pressing down for 2 or more seconds during playback reverses playback at 5 times the normal speed while pressed. Releasing the button resumes normal playback. <p>Available only when paused</p> <ul style="list-style-type: none"> Pressing down for 2 or more seconds reverses playback at 1/16 times the normal speed.
	<ul style="list-style-type: none"> Each press of the button during playback advances the playback speed in 4 steps for forward direction. <p>Available only when paused</p> <ul style="list-style-type: none"> Pressing once advances playback by 1/16 times the normal speed. Each press of the button during forward 1/16 times slow-motion advances slow-motion by 1/16 times, 1/4 times and 1/2 times the normal speed.
	<ul style="list-style-type: none"> Each press of the button during playback advances the playback speed in 5 steps for reverse direction. <p>Available only when paused</p> <ul style="list-style-type: none"> Pressing once reverses playback by 1/16 times the normal speed. Each press of the button during reverse 1/16 times slow-motion reverses slow-motion by 1/16 times, 1/4 times and 1/2 times the normal speed.
	Pressing once pauses playback (still picture playback). Pressing repeatedly advances the still picture frame by frame.
	<p>Available only when paused</p> <ul style="list-style-type: none"> Advances/reverses the still picture frame by frame.
	Stops Live Memory Playback to return to the screen being recorded. Then a resume point is stored. Pressing again stops recording.
	Pressing once skips forward for approximately 30 seconds and resumes playback. Pressing repeatedly skips forward continuously as many times as pressed. It is useful when skipping over unwanted sections.
	Pressing once skips back for approximately 7 seconds and resumes playback. Pressing repeatedly skips back continuously as many times as pressed. It is useful when watching sports programmes, etc.
LIVE CHECK	Pressing once displays the picture currently being recorded and the one being played back simultaneously. Pressing successively clears the Live Check window and displays only the picture currently being played back. You can check, for example, if the programme you are recording has already finished.

- Turn on the unit.
- Turn on the TV and select the AV mode.
- Slide the TV/CABLE/SAT/DVD switch to DVD.

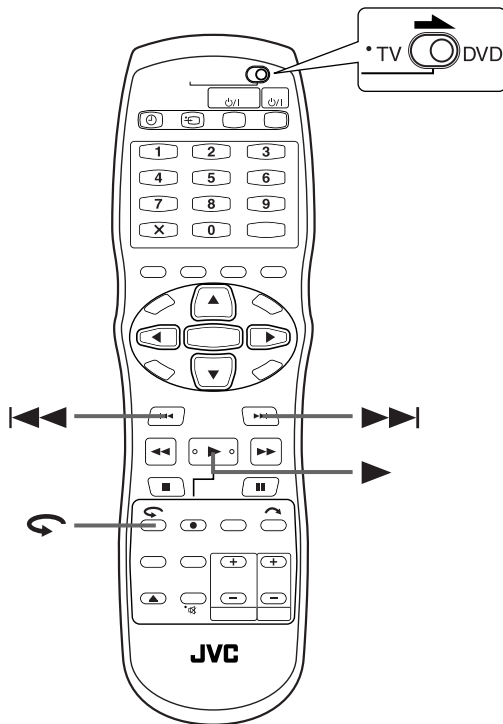

To play back from the beginning of the programme while recording

You can play back a programme you are recording from the beginning while continuing to record or timer record onto a DVD-RAM disc.

1 Start Live Memory Playback.

Press ►.

- Playback starts from the beginning of the programme being recorded.
- Pressing ◀◀/▶▶ allows you to locate the desired scenes.

To move back the playback position slightly while recording (One Touch Replay function)

You can move back the playback position while continuing to record or timer record onto a DVD-RAM disc.

1 Start One Touch Replay function.

Press ↺.

- Each press skips back for approximately 7 seconds and resumes playback.
- Pressing while paused skips back for approximately 7 seconds and resumes pause.

To watch a programme previously recorded while recording

You can play back a programme you recorded previously while recording.

1 Start Live Memory Playback.

Press ► while recording to establish Live Memory Playback mode.

2 Locate the beginning of the desired programme.

Press ◀◀ or ▶▶.

NOTE:

To stop playback, press ■. The programme being recorded is displayed.

Using Play Set Up Menu



Play Set Up Menu allows you to control various playback functions. Some of the functions operated on Navigation Menu can be controlled on Set Up Menu.

Before using Play Set Up Menu

Be sure to clear Library Database DVD Navi screen by pressing **NAVIGATION**.

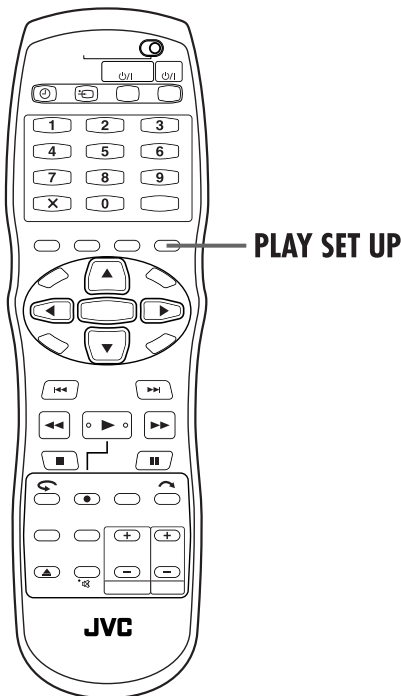

How to Access Play Set Up Menu

Press **PLAY SET UP** whenever a disc is loaded.

Contents of Play Set Up Menu during playback

DVD VIDEO

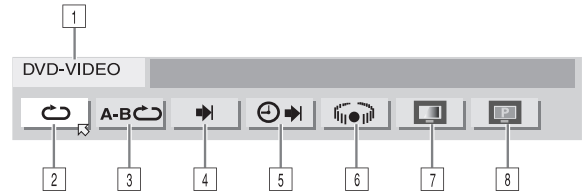

Video CD

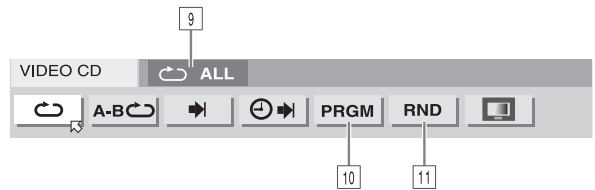

JPEG disc



- 1 Disc type.
- 2 Select this for Repeat Playback. (☞ pg. 44)
- 3 Select this for A-B repeat Playback. (☞ pg. 44)
- 4 Select this for search function. (☞ pg. 46)
- 5 Select this for time search function. (☞ pg. 47)
- 6 Select this to switch Simulated Surround Effect function. (☞ pg. 47)
- 7 Select this for Picture Control function. (☞ pg. 48)
- 8 Select this to switch picture source type. (☞ pg. 48)
- 9 Current status area for the selected item.
- 10 Select this for Programme Playback. (☞ pg. 45)
- 11 Select this for Random Playback. (☞ pg. 45)
- 12 Select this to control the switching interval of the slide show. (☞ pg. 48)

NOTE:

Although examples of Play Set Up Menu are provided here only for 3 types of discs, Play Set Up Menu will be displayed for whichever disc indicated in the left column.

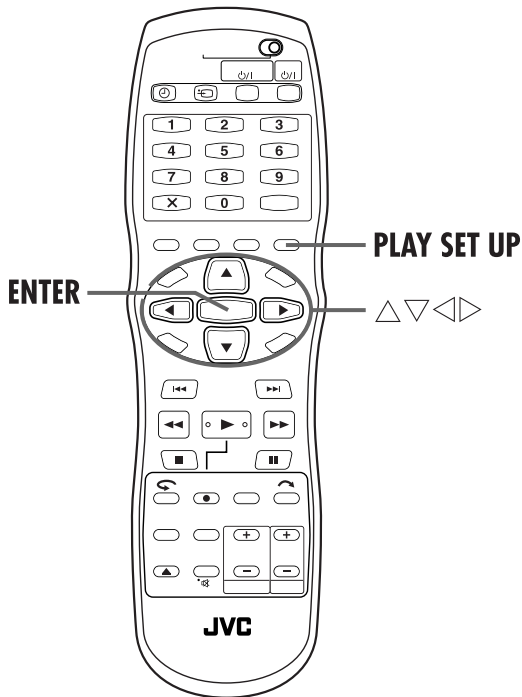

Basic operation on Play Set Up Menu

Example: When selecting Picture Control function of DVD

During playback or while stopped

1 Access Play Set Up Menu.

Press **PLAY SET UP**.

- The item currently selected is highlighted and pointed by .



2 Select the menu item.

Press  to select "", then press **ENTER**.

- The pop-up window appears under the selected item.



3 Select the option.

Press  to select the desired option, then press **ENTER**.

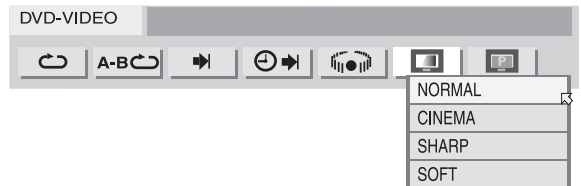

To clear Play Set Up Menu

Press **PLAY SET UP**.

NOTE:

See the corresponding pages for details on each menu item.

Repeat Playback



You can repeat playback as you like according to the type of disc.

1 Access Play Set Up Menu.

Press **PLAY SET UP**.

2 Select the menu item.

Press $\triangleleft \triangleright$ to select “”, then press **ENTER**.

- The pop-up window appears under the selected item.



3 Select the repeat mode.

Press $\triangle \nabla$ repeatedly to select the desired Repeat mode, then press **ENTER**.

DVD-RAM/RW/R

OFF:	Repeat playback is not performed.
ALL REPEAT:	The whole disc is played back repeatedly.
TITLE REPEAT:	The current title is played back repeatedly.

DVD VIDEO

OFF:	Repeat playback is not performed.
TITLE REPEAT:	The current title is played back repeatedly.
CHAPTER REPEAT:	The current chapter is played back repeatedly.

Audio CD/Video CD/JPEG/MP3

OFF:	Repeat playback is not performed.
ALL REPEAT:	The whole disc is played back repeatedly.
TRACK REPEAT*:	The current track is played back repeatedly.

* “TRACK REPEAT” cannot be selected for JPEG discs.

To clear Play Set Up Menu

Press **PLAY SET UP**.

To cancel Repeat Playback

Repeat the above procedure from step 1, select “OFF” in step 3, then press **ENTER**.

NOTES:

- Repeat Playback is not possible for a Video CD with PBC function.
- Repeat Playback may not work properly depending on the type of the disc being used.

A-B Repeat Playback



You can repeat the desired part.

During playback

1 Access Play Set Up Menu.

Press **PLAY SET UP**.

2 Select the menu item.

Press $\triangleleft \triangleright$ to select “A-B ”.

3 Locate the start point.

Press **ENTER** at the beginning of the desired part you want to repeat (point A).

- The elapsed playing time of the point A appears



4 Locate the end point and start A-B Repeat Playback.

Press **ENTER** at the end of the desired part you want to repeat (point B).

- The elapsed playing time of the point B appears.
- The selected part of the disc (between point A and B) is played repeatedly.



To clear Play Set Up Menu

Press **PLAY SET UP**.

To cancel A-B Repeat Playback

Press $\triangleleft \triangleright$ to select “A-B ”, then press **ENTER**.

NOTES:

- A-B Repeat Playback may not work properly depending on the type of disc being used.
- The subtitles recorded around the A-B point may not appear.
- When the end of the item is reached before the end point is set, Play Set Up Menu disappears from the TV screen. In such a case, repeat the procedure from step 1.
- The point B must be set at least 3 seconds after the point A.
- When playing back a DVD, A-B Repeat Playback is possible only within the same title.
- “A-B ” cannot be selected during Programme and Random Playback.
- “A-B ” cannot be selected while stopped.

Random Playback



You can play back all the tracks on the disc in random order.

While stopped

1 Access Play Set Up Menu.

Press **PLAY SET UP**.

2 Select the menu item.

Press $\triangleleft \triangleright$ to select "RND", then press **ENTER**.

- Playback starts in random order.



To clear Play Set Up Menu

Press **PLAY SET UP**.

To cancel Random Playback

Perform steps 1 and 2.

NOTE:

The same track will not be played back more than once during Random Playback.

Programme Playback



You can play back up to 30 tracks in the desired order.

While stopped

1 Access Play Set Up Menu.

Press **PLAY SET UP**.

2 Select the menu item.

Press $\triangleleft \triangleright$ to select "PRGM", then press **ENTER**.

- The programme table appears under Play Set Up Menu.



3 Select the tracks in the desired order.

Use **number keys** (1–9, 0) to enter the track numbers.

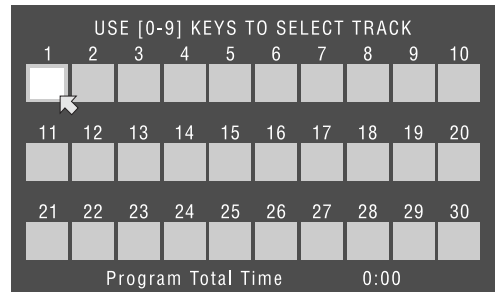

Examples:

- To select track 5, press the **number key "5"** and **ENTER**.
- To select track 15, press the **number key "1"** and **"5"**.
- To select track 25, press the **number key "2"** and **"5"**.

If you have specified a wrong selection

Press **X**. The last selection is erased.

Or press **■**. The whole selection is erased.

4 Start playback.

Press **▶**. Playback starts in the programmed order.

- When all of the programmed tracks have been played back, Programme Playback stops, but the programmed information remains.
- To add tracks to the end of the programme, perform steps 1 through 3.
- During Programme Playback, pressing **▶▶** skips to the next selection of the programme. Pressing **◀◀** returns to the beginning of the current selection.

To clear Play Set Up Menu

Press **PLAY SET UP**.

To cancel Programme Playback

Press $\triangleleft \triangleright$ to select "PRGM", then press **ENTER**.

NOTE:

Programme Playback is not possible depending on the type of disc.

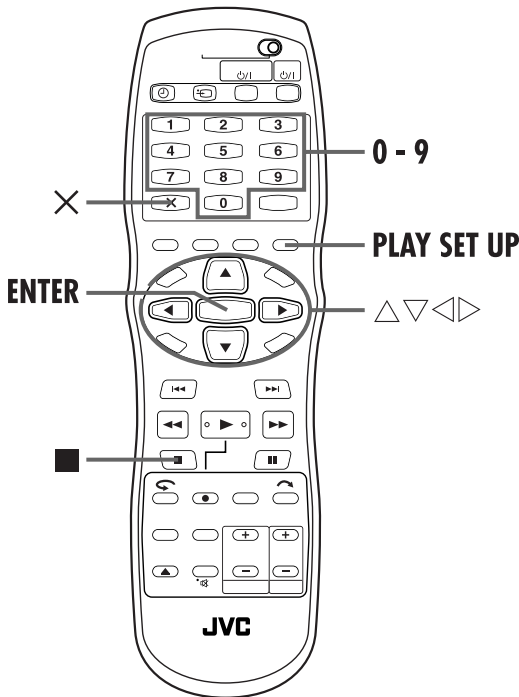

Locating the beginning of a desired selection



You can locate the beginning of a title, chapter, group or track.

During playback or while stopped

1 Access Play Set Up Menu.

Press **PLAY SET UP**.

2 Select the menu item.

Press $\triangleleft \triangleright$ to select " \blacktriangleright ", then press **ENTER**.

3 Select the desired item.

For DVD-RAM/RW/R, DVD VIDEO

"TITLE SEARCH" or "CHAPTER SEARCH" is selectable.
("TITLE SEARCH" only is selectable while stopped.)

For JPEG, MP3

"GROUP SEARCH" or "TRACK SEARCH" is selectable.

For Video CD, Audio CD

"TRACK" is selectable.

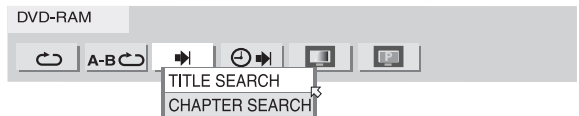

Press $\triangle \nabla$ to select the desired item, then press **ENTER**.

- Skip this step for Video CD and Audio CD.

4 Specify the number of the selected item.

Press **number keys** (1–9, 0) to enter the desired item number, then press **ENTER**.

- Playback starts from the selected section.

Examples:

To select track 5, press the **number key "5"**.

To select track 15, press the **number key "1"** and **"5"**.

To select track 25, press **number key "2"**, then **"5"**.

If you have specified a wrong selection

Press **X** or **■** to clear the wrong number, then enter the correct one before you press **ENTER** in this step.

To clear Play Set Up Menu

Press **PLAY SET UP**.

NOTES:

- When " \odot " is displayed on the TV screen in step 4, the chapter you have selected is not contained in the disc, or chapter search does not work on the disc.
- Before you press **ENTER**, playback may start automatically when you enter the section's number depending on the disc.
- This function is not possible for a Video CD with PBC function.

Time Search



You can play back a disc from the desired point by specifying the elapsed playing time from the beginning of a title (DVD-RAM, DVD-R, DVD-RW and DVD VIDEO) or a disc (Video CD and Audio CD).

1 Access Play Set Up Menu.

Press **PLAY SET UP**.

2 Select the menu item.

Press $\triangleleft \triangleright$ to select “ $\ominus \rightarrow$ ”, then press **ENTER**.

- The pop-up window appears under the selected item.



3 Enter the time.

Use **number keys** (1–9, 0) to enter the time, then press **ENTER**.

- Playback starts from the specified time.

Example:

To play back from a point 12 (minutes): 50 (seconds) elapsed.

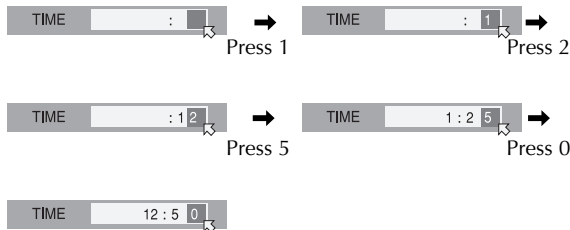

If you have specified a wrong selection,

Press **X** (for the last entered number) or **■** (for whole numbers) to clear the wrong number, then enter the correct one(s) before you press **ENTER** in this step.

To clear Play Set Up Menu

Press **PLAY SET UP**.

NOTES:

- When “ \ominus ” is displayed on the TV screen in step 3, you have selected a point that exceeds the recording time of the disc.
- Some DVD VIDEO discs do not contain time information, and it is not possible to use the Time Search function. In such cases, “ \ominus ” is displayed on the TV screen as well.
- This function is not possible for a Video CD with PBC function.

Simulated Surround Effect



It is possible to get a simulated surround effect from your stereo system. You can enjoy the virtual surround sound with your 2-channel stereo system.

1 Access Play Set Up Menu.

Press **PLAY SET UP**.

2 Select the menu item.

Press $\triangleleft \triangleright$ to select “ Speaker Icon ”, then press **ENTER**.

- Above the selected item, “3D-ON” appears and Simulated Surround Effect is activated.
- Each time you press **ENTER**, “3D-ON” appears and disappears alternately.

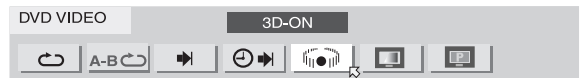

To cancel the simulated surround effect

Press **ENTER** to clear “3D-ON” from the screen.

NOTES:

- The simulated surround effect works correctly only when playing back a title recorded in multichannels.
- Simulated Surround Effect does not affect the DVD VIDEO bitstream signal from the “DIGITAL AUDIO OUT” connector.
- When Simulated Surround Effect is activated, the settings of “ANALOG AUDIO OUT” and “D. RANGE CONTROL” are disabled. (pg. 93)

Adjusting the picture quality



You can obtain optimal picture quality by selecting an appropriate picture mode.

1 Access Play Set Up Menu.

Press **PLAY SET UP**.

2 Select the menu item.

Press $\triangleleft \triangleright$ to select “”, then press **ENTER**.

- The pop-up window appears under the selected item.



3 Select the desired option.

Press $\triangle \nabla$ to select the desired option, then press **ENTER**.

NORMAL:	Normally select this option.
CINEMA:	Suitable for a movie disc, etc.
SHARP:	Clearer, sharper-edged picture when viewing images with lots of flat, same-coloured surfaces such as cartoons.
SOFT:	Select this option when too much noise appears.

Select the switching interval of the slide show



You can control the switching interval of the slide show.

1 Access Play Set Up Menu.

Press **PLAY SET UP**.

2 Select the menu item.

Press $\triangleleft \triangleright$ to select “”, then press **ENTER**.

- The pop-up window appears under the selected item.



3 Select the desired option.

Press $\triangle \nabla$ to select the desired option, then press **ENTER**.

- Each time you press $\triangle \nabla$, the interval changes as follows:
5 SEC. \leftrightarrow 10 SEC. \leftrightarrow 15 SEC. \leftrightarrow 20 SEC. \leftrightarrow 25 SEC. \leftrightarrow 30 SEC. \leftrightarrow (Back to the beginning)

Setting the progressive mode



You can obtain optimal picture quality by selecting whether the content on the disc is processed by field (video source) or by frame (film source).

1 Access Play Set Up Menu.

Press **PLAY SET UP**.

2 Select the menu item.

Press $\triangleleft \triangleright$ to select “”, then press **ENTER**.

- The pop-up window appears under the selected item.



3 Select the desired option.

Press $\triangle \nabla$ to select the desired option, then press **ENTER**.

AUTO 1:	Used to play a disc containing both video and film source materials. This system recognizes the source type (video or film) of the current disc according to the disc information. Normally select this option.
AUTO 2:	Almost the same as the “AUTO 1”, but the processing of the scenes with movement is different. Select “AUTO 1” or “AUTO 2” to your preference.
FILM:	Suitable for playing back a progressive scanned film source disc.
VIDEO:	Suitable for playing back a video source disc. The outlines on the played back pictures will be soft.

NOTE:

When the progressive mode is set, be sure to set “L-1 OUTPUT” to “COMPONENT”. (See pg. 84, “L-1 Output and L-1 Input Setting (L-1 OUTPUT and L-1 INPUT)”) Progressive scan is output only from COMPONENT VIDEO OUT connector.

Parental Lock



This function restricts playback of DVD VIDEO discs which contain violent (and other) scenes according to the level set by the user. For example, if a movie which includes violent scenes supports the parental lock feature, such scenes which you do not want to let children view can be cut or replaced by other scenes.

- Turn on the unit.
- Turn on the TV and select the AV mode.
- Slide the **TV/CABLE/SAT/DVD** switch to **DVD**.

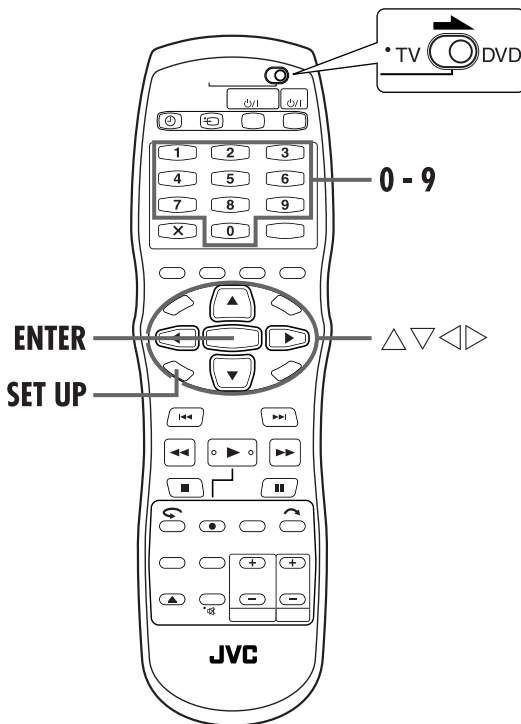

2 Access the "PARENTAL LOCK" screen.

- 1 Press $\triangleleft \triangleright$ to select "UTILITY", then press **ENTER**.
- 2 Press $\triangle \nabla$ to select "PARENTAL LOCK", then press **ENTER**.

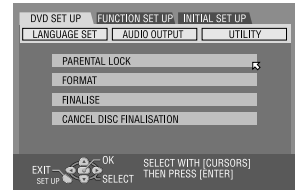

3 Select the desired level.

- 1 Press $\triangle \nabla$ repeatedly to select "PARENTAL LEVEL", then press **ENTER**.
 - 2 Press $\triangle \nabla$ repeatedly to select the desired level, then press **ENTER**.
- The smaller the value of level is, the more restrictive the Parental Lock level becomes.
 - Select "NONE" to cancel the restriction.

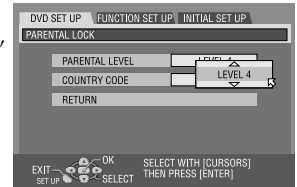

4 Enter your password.

Press the **number keys** to enter your desired four-digit number, then press **ENTER**.

- If you made a mistake, enter a correct number again.



5 Select your country code.

- 1 Press $\triangle \nabla$ repeatedly to select "COUNTRY CODE", then press **ENTER**.
 - 2 Press $\triangle \nabla$ repeatedly to select your country code, then press **ENTER**.
- If you do not need to change your country code, jump to **7**.
 - See "Country/Area Code List for Parental Lock" (pg. 51).

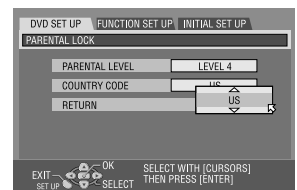

6 Enter your password.

Press the **number keys** to enter the same password as in step **4** above, then press **ENTER**.

7 Complete the setting.

- Press **SET UP** twice.
- The normal screen resumes.

NOTE:

Remember your password, or make a note of it.

To set Parental Lock for the first time

While stopped

1 Access the "DVD SET UP" screen.

- 1 Press **SET UP**.
- 2 Press $\triangleleft \triangleright$ to select "DVD SET UP", then press **ENTER**.

To change the settings

You can change the Parental lock settings later.

Perform steps **1** to **2** of "To set Parental Lock for the first time" on page 49 to access the "PARENTAL LOCK" screen before continuing.

1 Change the level.

- 1 Press Δ / ∇ repeatedly to select "PARENTAL LEVEL", then press **ENTER**.
- 2 Press Δ / ∇ repeatedly to select the desired level, then press **ENTER**.

2 Change the country code.

- 1 Press Δ / ∇ repeatedly to select "COUNTRY CODE", then press **ENTER**.
 - 2 Press Δ / ∇ repeatedly to select your country code, then press **ENTER**.
- See "Country/Area Code List for Parental Lock" (☞ pg. 51).

3 Enter your password.

Press the **number keys** to enter the same password as in step **4** of "To set Parental Lock for the first time", then press **ENTER**.

4 Complete the setting.

Press **SET UP** twice.

- The normal screen resumes.

NOTE:

If you forget your password, enter "8888" in step **3**.

To temporarily release Parental Lock

When you set the parental lock level strictly, some discs may not be played back at all. When you insert such a disc and try to play it back, the confirmation screen appears on the TV screen, asking you whether you want Parental Lock to be temporarily released or not.

1 Access the password screen.

- 1 Place the disc on the disc tray.
 - If the disc is rated higher than the selected level, the confirmation screen appears.
- 2 Press \triangleleft / \triangleright to select "YES", then press **ENTER**.
 - If you select "NO", you cannot play back that disc.

2 Enter your password.

Press the **number keys** to enter the same password as in step **4** of "To set Parental Lock for the first time", then press **ENTER**.

- When you enter the correct password, the Parental Lock is released and the unit starts playback.
- If you enter a wrong password, "ENTRY ERROR RETRY" appears on the TV screen. Enter the correct password.
- If you have successively entered wrong password three times, "ENTRY ERROR CAN NOT CHANGE PASSWORD" appears on the TV screen. In such a case, press **ENTER**. The disc will stop. Then play the disc again, and try the procedure again from step **1**.

NOTE:

If you forget your password, enter "8888" in step **2**.

Country/Area Code List for Parental Lock

AD	Andorra	ES	Spain
AE	United Arab Emirates	ET	Ethiopia
AF	Afghanistan	FI	Finland
AG	Antigua and Barbuda	FJ	Fiji
AI	Anguilla	FK	Falkland Islands (Malvinas)
AL	Albania	FM	Micronesia (Federated States of)
AM	Armenia	FO	Faroe Islands
AN	Netherlands Antilles	FR	France
AO	Angola	FX	France, Metropolitan
AQ	Antarctica	GA	Gabon
AR	Argentina	GB	United Kingdom
AS	American Samoa	GD	Grenada
AT	Austria	GE	Georgia
AU	Australia	GF	French Guiana
AW	Aruba	GH	Ghana
AZ	Azerbaijan	GI	Gibraltar
BA	Bosnia and Herzegovina	GL	Greenland
BB	Barbados	GM	Gambia
BD	Bangladesh	GN	Guinea
BE	Belgium	GP	Guadeloupe
BF	Burkina Faso	GQ	Equatorial Guinea
BG	Bulgaria	GR	Greece
BH	Bahrain	GS	South Georgia and the South Sandwich Islands
BI	Burundi	GT	Guatemala
BJ	Benin	GU	Guam
BM	Bermuda	GW	Guinea-Bissau
BN	Brunei Darussalam	GY	Guyana
BO	Bolivia	HK	Hong Kong
BR	Brazil	HM	Heard Island and McDonald Islands
BS	Bahamas	HN	Honduras
BT	Bhutan	HR	Croatia
BV	Bouvet Island	HT	Haiti
BW	Botswana	HU	Hungary
BY	Belarus	ID	Indonesia
BZ	Belize	IE	Ireland
CA	Canada	IL	Israel
CC	Cocos (Keeling) Islands	IN	India
CF	Central African Republic	IO	British Indian Ocean Territory
CG	Congo	IQ	Iraq
CH	Switzerland	IR	Iran (Islamic Republic of)
CI	Côte d'Ivoire	IS	Iceland
CK	Cook Islands	IT	Italy
CL	Chile	JM	Jamaica
CM	Cameroon	JO	Jordan
CN	China	JP	Japan
CO	Colombia	KE	Kenya
CR	Costa Rica	KG	Kyrgyzstan
CU	Cuba	KH	Cambodia
CV	Cape Verde	KI	Kiribati
CX	Christmas Island	KM	Comoros
CY	Cyprus	KN	Saint Kitts and Nevis
CZ	Czech Republic	KP	Korea, Democratic People's Republic of
DE	Germany	KR	Korea, Republic of
DJ	Djibouti	KW	Kuwait
DK	Denmark	KY	Cayman Islands
DM	Dominica	KZ	Kazakhstan
DO	Dominican Republic	LA	Lao People's Democratic Republic
DZ	Algeria	LB	Lebanon
EC	Ecuador		
EE	Estonia		
EG	Egypt		
EH	Western Sahara		
ER	Eritrea		

LC	Saint Lucia
LI	Liechtenstein
LK	Sri Lanka
LR	Liberia
LS	Lesotho
LT	Lithuania
LU	Luxembourg
LV	Latvia
LY	Libyan Arab Jamahiriya
MA	Morocco
MC	Monaco
MD	Moldova, Republic of
MG	Madagascar
MH	Marshall Islands
ML	Mali
MM	Myanmar
MN	Mongolia
MO	Macau
MP	Northern Mariana Islands
MQ	Martinique
MR	Mauritania
MS	Montserrat
MT	Malta
MU	Mauritius
MV	Maldives
MW	Malawi
MX	Mexico
MY	Malaysia
MZ	Mozambique
NA	Namibia
NC	New Caledonia
NE	Niger
NF	Norfolk Island
NG	Nigeria
NI	Nicaragua
NL	Netherlands
NO	Norway
NP	Nepal
NR	Nauru
NU	Niue
NZ	New Zealand
OM	Oman
PA	Panama
PE	Peru
PF	French Polynesia
PG	Papua New Guinea
PH	Philippines
PK	Pakistan
PL	Poland
PM	Saint Pierre and Miquelon
PN	Pitcairn
PR	Puerto Rico
PT	Portugal
PW	Palau
PY	Paraguay
QA	Qatar
RE	Réunion
RO	Romania
RU	Russian Federation
RW	Rwanda

SA	Saudi Arabia
SB	Solomon Islands
SC	Seychelles
SD	Sudan
SE	Sweden
SG	Singapore
SH	Saint Helena
SI	Slovenia
SJ	Svalbard and Jan Mayen
SK	Slovakia
SL	Sierra Leone
SM	San Marino
SN	Senegal
SO	Somalia
SR	Suriname
ST	Sao Tome and Principe
SV	El Salvador
SY	Syrian Arab Republic
SZ	Swaziland
TC	Turks and Caicos Islands
TD	Chad
TF	French Southern Territories
TG	Togo
TH	Thailand
TJ	Tajikistan
TK	Tokelau
TM	Turkmenistan
TN	Tunisia
TO	Tonga
TP	East Timor
TR	Turkey
TT	Trinidad and Tobago
TV	Tuvalu
TW	Taiwan, Province of China
TZ	Tanzania, United Republic of
UA	Ukraine
UG	Uganda
UM	United States Minor Outlying Islands
US	United States
UY	Uruguay
UZ	Uzbekistan
VA	Vatican City State (Holy See)
VC	Saint Vincent and the Grenadines
VE	Venezuela
VG	Virgin Islands (British)
VI	Virgin Islands (U.S.)
VN	Viet Nam
VU	Vanuatu
WF	Wallis and Futuna Islands
WS	Samoa
YE	Yemen
YT	Mayotte
YU	Yugoslavia
ZA	South Africa
ZM	Zambia
ZR	Zaire
ZW	Zimbabwe

Basic Recording



- Turn on the unit.
- Turn on the TV and select the AV mode.
- Slide the TV/CABLE/SAT/DVD switch to DVD.

ATTENTION:

It is not possible to record programmes on a DVD-R disc which has already been finalised.

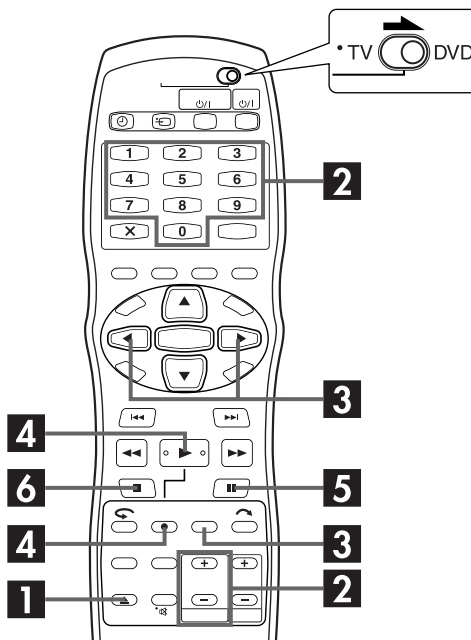
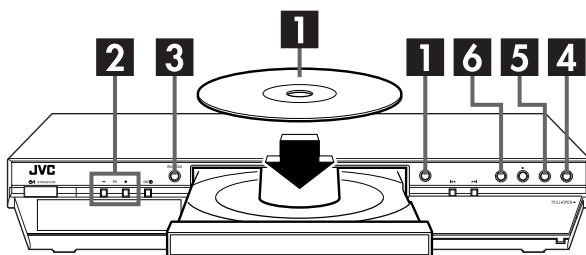

1 Load a disc.

- 1 Press **▲** to open the disc tray.
- 2 Place a recordable disc on the disc tray.
- For details, refer to "Placing a Disc" (pg. 10).
- 3 Press **▲** to close the disc tray.

2 Choose a programme.

Press **PR +/-** or the **number keys** to select the channel you wish to record.

3 Set the recording speed.

Press **REC MODE** repeatedly until the desired recording speed appears.

- Each time you press **REC MODE**, the recording speed changes as follows:
XP → SP → LP → EP → FR60–FR360* → (Back to the beginning)

* The value is selectable from 1 to 6 hours in 5-min. increment by pressing **◀▷** repeatedly after selecting "FR60–FR360". To change the value in 30-min. increments, press and hold **◀▷**.

- For details on the recording speed, see page 54.

4 Start recording.

Press and hold **●**, then press **▶** on the remote control, or press **●** on the unit.

5 Pause recording.

Press **⏸**.

- To resume recording, press **▶**.

6 Stop recording.

Press **■**.

It takes about 10 seconds to end the writing session when you stop recording.

NOTES:

- It is recommended to format a DVD-RAM disc before use if you use the disc on this unit for the first time.
- When using a brand-new DVD-RW disc, format the disc either in VR mode or in Video mode. (pg. 106, "Format a DVD-RW disc")
- You can record up to 99 programmes and 999 play lists on each disc.
- Some programmes can only be recorded one time.
- When recording is started, an index of the first part of recording is automatically recorded (pg. 66, "Library Database DVD Navi"). To record a satellite programmes, refer to page 65. To delete the index, refer to page 71.
- Recording sometimes may stop or cannot be performed even if there is enough available capacity remaining on the disc.

Recording Resume Function

If there is a power outage during recording, Instant Timer Recording (ITR) (pg. 54) or timer recording (pg. 56, 58), the recording will resume automatically when power is restored to the unit unless the unit's memory backup has expired.

Recording Features

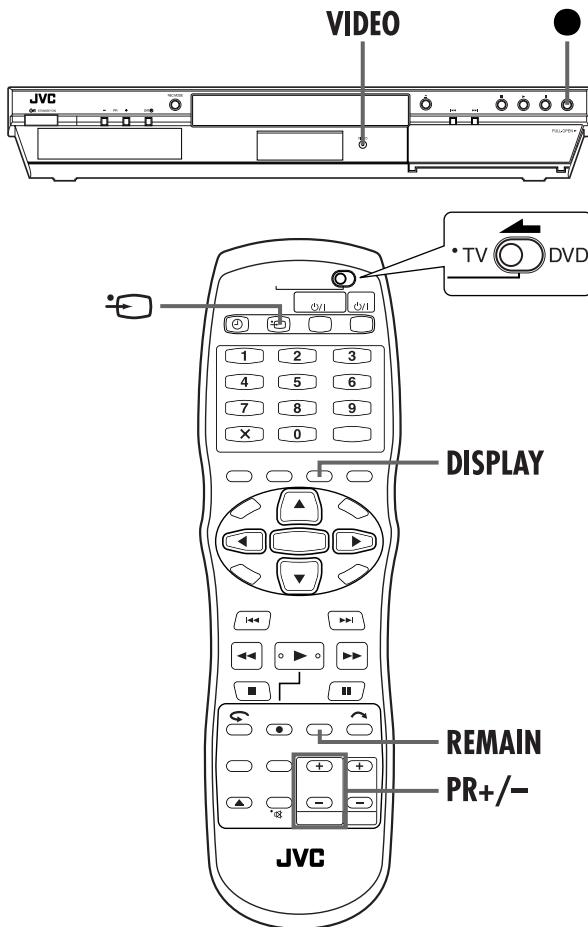

Recording Speed

MPEG2 format is used as recording format. As a guide for picture quality, the "bps" unit is used to represent how much data can be recorded per second. The larger this value is, the better the picture quality becomes but more capacity is required for the recording. Select XP or SP for programmes where quick movement occurs, such as sports programmes, and LP or EP for talk shows, etc. with relatively less movement.

The recording speeds for a 4.7 GB disc are set as follows:

Recording speed	Recording amount (approx.)	Maximum recording time (approx.)
XP	10 Mbps	1 hour
SP	5 Mbps	2 hours
LP	2 Mbps	4 hours
EP	1.6 Mbps	6 hours
FR60-FR360 (pg. 55)	The amount varies depending on the selected time.	6 hours

Instant Timer Recording (ITR)

This easy method lets you record for from 30 minutes to 6 hours (selectable in 30-min. increments), and shuts the unit off after recording is finished.

1 Start recording.

Press ● on the unit.

2 Engage the ITR mode.

Press ● again. On the front display panel, "0:30" appears.

3 Set the recording duration.

If you want to record for more than 30 minutes, press ● to extend the time. Each press extends recording time by 30 minutes.

NOTES:

- You can only perform ITR using the ● button on the unit's front panel.
- If "DIRECT REC" is set to "ON" in the menu, Instant Timer Recording (ITR) function does not work. (pg. 94)

Watch Another Programme While Recording on the Unit

While recording is going on, you can watch another programme on the TV by using the TV's tuner. It is required that the remote control is set to be able to operate the TV in advance.

(pg. 88, "TV Multi-Brand Remote Control")

1 Switch the TV to TV mode.

During recording, press VIDEO (VIDEO) to select TV mode.

- Video mode is disengaged and the video indicator on the unit is turned off.
- The programme received on the TV's tuner is displayed on the TV screen.

2 Switch the remote control to TV control mode.

Slide the TV/CABLE/SAT/DVD switch to TV.

3 Select the desired channel.

Press PR +/- repeatedly.

Elapsed Recording Time and Disc Remaining Time Indication

During recording, press DISPLAY repeatedly until the desired indication appears on the front display panel.

- Each time you press DISPLAY, the time indication changes as follows:

Elapsed recording time → Disc remaining time → Clock → (Back to the beginning)

- There is another way to check the disc remaining time. While the unit is stopped or recording is in progress, press REMAIN. The list of disc remaining times for all recording speeds appears on the TV screen.

Free Rate Function

To record the entire programme, the unit automatically set the appropriate recording speed depending on the combination of the total time of the programme to be recorded and either the remaining disc space or the specified recording time (from 60 minutes to 360 minutes).

To record the entire programme within the actual remaining disc space

Select "FR (JUST)" in a recording speed selection procedure. (☞ pg. 57, 59)

- Note that this function is available only for timer programming recording.

To record the entire programme by specifying the desired recording time

Select "FR60–FR360" in a recording speed selection procedure. (☞ pg. 53, 57, 59)

To record a 25-min. long daily programme five times just on a same disc for example

Perform "VIDEO Plus+™ Timer Programming" (☞ pg. 56) procedure. Be sure to set the recording speed to "FR125" and set Weekly/Daily Rec Function to "MON–FRI" in step 5 to fit the total recording time to the whole disc space.

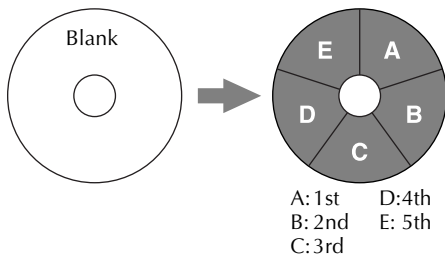

When the same programme is recorded in SP mode instead of in "FR125", the 5th programme cannot be recorded.

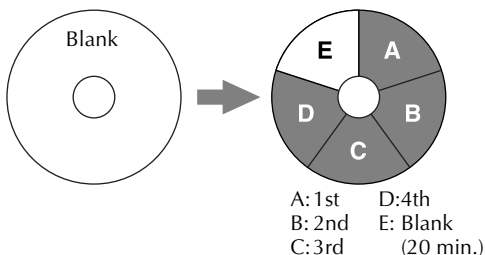

NOTES:

- You can programme this unit to timer-record, regardless of the disc remaining time. When the disc remaining time is not enough, recording may stop in the middle of a programme. To avoid this, make sure of the disc remaining time before setting timer-programming.
(Example) If you programmed to timer-record for 60 minutes in SP mode on a 120-minute disc, the disc remaining time would be 30 minutes in XP mode, 60 minutes in SP mode, 120 minutes in LP mode, and 180 minutes in EP mode. Timer-recording will not complete beyond these remaining times.
- The maximum recording time of FR (JUST) mode is the same as the recording time of EP mode. When timer-programming a long programme in FR (JUST) mode on a disc whose remaining time is short, it is recommended checking the disc remaining time in EP mode to see if the remaining time is enough for the programme.
- Even if more than one programme are timer-programmed in FR (JUST) mode, only the first one is recorded.
- In order to ensure that the recording fits on the disc, this feature may leave a slight non-recorded section at the end of the disc.
- There may be some noise and sound disturbance at the point on the disc where the unit switches the mode.

Receiving Stereo and Bilingual Programmes

Your unit is equipped with a Digital stereo sound decoder (NICAM) making reception of stereo and bilingual broadcasts possible.

When the channel is changed, the type of broadcast being received will be displayed on the TV screen for a few seconds.

Type of Broadcast Being Received	On-screen Display
Regular Monaural	
NICAM Stereo	
NICAM Bilingual	
NICAM Monaural	

NOTES:

- "SUPERIMPOSE" must be set to "ON" or "AUTO". Otherwise the on-screen displays will not appear. (☞ pg. 95)
- If the quality of stereo sound being received is poor, the broadcast might be received in monaural with better quality.

Selection of the audio channel to be recorded on a disc

When a programme is recorded on a DVD-RAM or DVD-RW disc in VR mode, all audio channels of the receiving programme are recorded on the disc. When you record a programme on a DVD-R or DVD-RW disc in video mode, select the desired audio channel (from among "NICAM 1/MAIN", "NICAM 2/SUB", "MONO") to be recorded on the disc. (☞ pg. 94)

NOTE:

Before playing back a programme recorded in stereo, or a bilingual programme, refer to "Audio Channel Selection" on page 36.

VIDEO Plus+®

Timer Programming



You can programme this unit to timer-record as many as 8 programmes.

With the VIDEO Plus+ system, timer programming is greatly simplified because each TV programme has a corresponding code number which your unit is able to recognize.

You can use the remote control to enter the PlusCode number.

Before performing the VIDEO Plus+ Timer Programming:

- Turn on the unit.
- Turn on the TV and select the AV mode.
- Slide the TV/CABLE/SAT/DVD switch to DVD.
- Make sure that the unit's built-in clock is set properly.

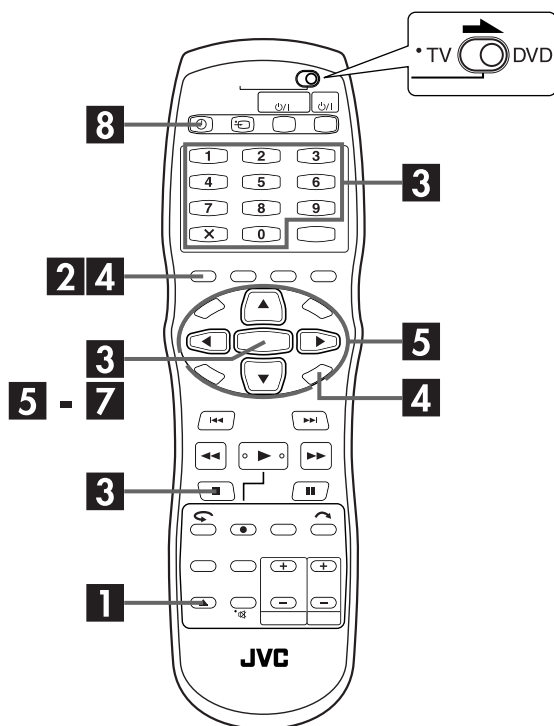

1 Load a disc.

- 1 Press **▲** to open the disc tray.
- 2 Place a recordable disc on the disc tray.
 - For details, refer to "Placing a Disc" (ⓘ pg. 10).
- 3 Press **▲** to close the disc tray.

2 Access the VIDEO Plus+ screen.

Press **VIDEO Plus+**.

3 Enter the PlusCode number.

Press the **number keys** to enter the PlusCode number of a programme you wish to record, then press **ENTER**.

- If you have made a mistake, press **X** and input the correct number before you press **ENTER**.
- To clear all entered numbers at a time, press **■**.
- If the number you entered is invalid, "PLUSCODE NO. ERROR CONFIRM PLUSCODE NO. THEN RETRY" appears on the TV screen. Input a valid PlusCode number.
- If "GUIDE PROGRAMME IS NOT SET SELECT CHANNEL YOU WANT TO RECORD" appears on the TV screen, set Guide Program Numbers (ⓘ pg. 97) manually.
- When "PROGRAMME FULL DELETE UNWANTED TIMER PROGRAMME" appears on the TV screen, you need to cancel some of the reserved programmes. (ⓘ pg. 63)

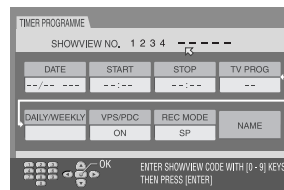

4 Check the programme data.

The PlusCode number you entered and the matching timer-recording information are displayed on the TV screen. Check if they are correct.

- To cancel this setting, press **VIDEO Plus+** or **RETURN**.

IMPORTANT:

Make sure the channel position number you wish to record is displayed; if not, see "VIDEO Plus+ System Setup" on page 97 and set the Guide Program number correctly.

5 Set the following recording options as required.

- 1 Press \triangleleft \triangleright to select the desired option.
- 2 Press \triangle ∇ to select the desired setting, then press **ENTER**.

"REC MODE" (☞ pg. 54, "Recording Speed") (☞ pg. 55, "Free Rate Function"), "VPS/PDC" (☞ pg. 59, "PDC Recording"), "DAILY/WEEKLY" (☞ pg. 57, "Daily/Weekly Rec Function"), "NAME" (☞ pg. 70, "Modify Programme Name"), and "STOP" (To advance/go back the stop time by 30 minutes, press and hold \triangle ∇).

- VPS (Video Programme System) recording is not currently available in the U.K. and not possible with this unit.

6 Access the confirmation screen.

Press **ENTER**.

7 Complete timer programming.

Press **ENTER**.

- To programme another timer, repeat steps 2 – 7.
- If "PROGRAM OVERLAPPED" appears on the TV screen, see "When programmes overlap each other" (☞ pg. 64).

8 Engage the unit's timer mode.

Press \odot (**TIMER**). The unit turns off automatically and " \odot " appears on the front display panel.

- To disengage the timer mode, press \odot (**TIMER**) again.

NOTES:

- There may be cases that VIDEO Plus+ programming timer recording function prolongs the stop time of the programming.
- When two successive programmes are recorded on a DVD-RW disc with VIDEO Plus+ programming timer recording function, the beginning of the second one may be left off the recording.
- VIDEO Plus+ Timer Programming is not possible on the discs used exclusively for On-Disc Timer Programming.
- If the copy limited programme is received during timer-recording, the unit enters Record Pause mode. Recording starts again if it is switched to a recordable broadcast during the time you programmed.

Satellite Receiver Users

To timer-record a satellite broadcast using the VIDEO Plus+ system:

- 1 Perform "Satellite Receiver Control Setting" on page 28.
- 2 Perform "VIDEO Plus+™ Timer Programming". In step 5, you cannot set "VPS/PDC" to "ON".
- 3 Leave the satellite receiver's power on.

Daily/Weekly Rec Function

You can record programmes with one of the following weekly/daily timer settings.

WEEKLY	Select to record a weekly programme.
MON-FRI	Select to record a daily programme from Monday through Friday.
MON-SAT	Select to record a daily programme from Monday through Saturday.
SUN-SAT	Select to record a daily programme from Sunday through Saturday.

Manual Timer Programming



You can programme this unit to timer-record as many as 8 programmes.

If you do not know the PlusCode number for the programme you wish to record, use the following procedure to set your unit to timer-record the programme.

Before performing Manual Timer Programming:

- Turn on the unit.
- Turn on the TV and select the AV mode.
- Slide the TV/CABLE/SAT/DVD switch to DVD.
- Make sure that the unit's built-in clock is set properly.

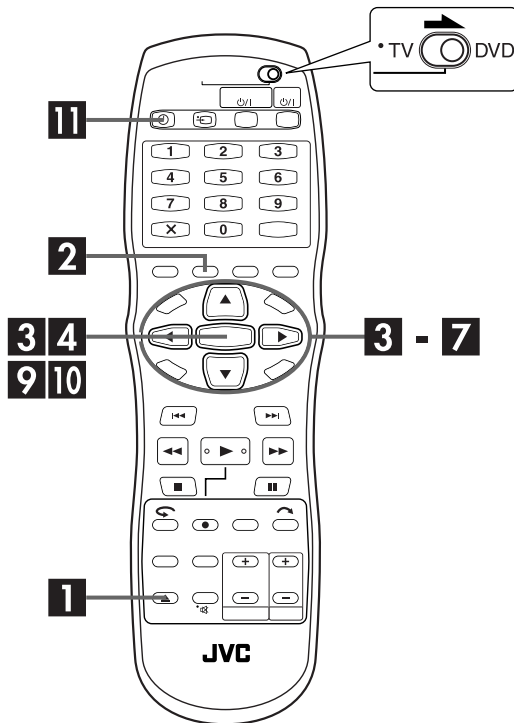

1 Load a disc.

- 1 Press \blacktriangle to open the disc tray.
- 2 Place a recordable disc on the disc tray.
 - For details, refer to "Placing a Disc" (pg. 10).
- 3 Press \blacktriangle to close the disc tray.

2 Access Programme Check screen.

Press **PROG/CHECK**.

- When "PROGRAMME FULL DELETE UNWANTED TIMER PROGRAMME" appears on the TV screen, you need to cancel some of the reserved programmes. (pg. 63)

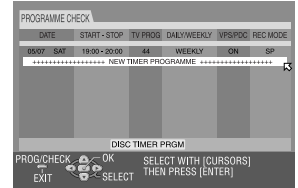

3 Access the programme screen.

Press \triangle / ∇ repeatedly to select "NEW TIMER PROGRAMME", then press **ENTER**.

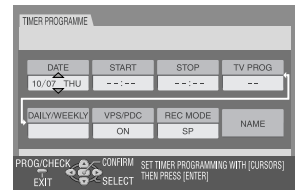

4 Enter the recording date.

Press \triangle / ∇ repeatedly to set the desired date.

- The current date appears on the TV screen. The date you enter appears in its place.

5 Enter the recording start time.

Press \triangle / ∇ to select "START", then press \triangle / ∇ repeatedly to set the desired start time.

- Each press of \triangle / ∇ advances/goes back the start time in 1-min. increments.
- To advance/go back the start time in 30-min. increments, press and hold \triangle / ∇ .

6 Enter the recording stop time.

Press ◀▶ to select "STOP", then press △▽ repeatedly to set the desired stop time.

- Each press of △▽ advances/goes back the stop time in 1-min. increments.
- To advance/go back the stop time in 30-min. increments, press and hold △▽.

7 Enter the channel position.

Press ◀▶ to select "TV PROG", then press △▽ repeatedly to select the desired channel.

8 Set the other recording options as required.

Refer to step 5 in "VIDEO Plus+™ Timer Programming" (pg. 56).

9 Access the confirmation screen.

Press ENTER.

10 Complete timer programming.

Press ENTER.

- To programme another timer, repeat steps 2 – 10.

11 Engage the unit's timer mode.

Press ⊖ (TIMER). The unit turns off automatically and "⊖" appears on the front display panel.

- To disengage the timer mode, press ⊖ (TIMER) again.

NOTES:

- When two successive programmes are recorded on a DVD-RW disc with Manual timer programming recording function, the beginning of the second one may be left off the recording.
- If the copy limited programme is received during timer-recording, the unit enters Record Pause mode. Recording starts again if it is switched to a recordable broadcast during the time you programmed.

Satellite Receiver Users

To timer-record a satellite broadcast using Manual Timer Programming:

- 1 Perform "Satellite Receiver Control Setting" on page 28.
- 2 Perform "Manual Timer Programming". In step 7, press **AUX** to change "TV PROG" to "SAT". Then press △▽ to enter the channel position for the satellite broadcast. In step 8, you cannot set "VPS/PDC" to "ON".
- 3 Leave the satellite receiver's power on.

PDC Recording

Now available from some TV stations, PDC (Programme Delivery Control) is a service designed to assure safe, accurate timer recording. With this system, special code signals are transmitted together with the audio/video signals. These code signals control your unit and have precedence over the advertised times which you may have preset into the timer. This means that your unit will start and stop recording when the preset TV programmes actually start and end — even if the broadcast time of a preset TV programme is changed from what has been advertised. PDC is currently available nationally on BBC1, BBC2, Ch.4 and Ch.5, except from a few small relay transmitters. Ch.3 operates a PDC service in some areas. All channels intend to offer this service in due course. Check your TV programme listing guide for latest information. If the channel you intend to record does not offer a PDC service your unit will not start recording if PDC has been selected. Be sure to set PDC to "OFF" if PDC is not available on your selected channel. (See step 8 on page 59.)

NOTES:

- When you use Manual Timer Programming, set the start time (PDC time) exactly as advertised in the TV listing. A different time than advertised will result in no recording.
- PDC recording is also possible when a satellite receiver or a cable system is connected to L-2 IN/DECODER connector on your unit.
- PDC recording is also possible via the L-1 IN/OUT connector.

On-Disc Timer Programming



On-Disc Timer Programming is a function used with discs that are especially intended for a specific programme. The disc is then programmed for a programme you always watch every day or every week. Since older programs are automatically overwritten, a single DVD-RAM/RW (VR mode) disc can be used without worrying about how much recording capacity remains. (☞ pg. 62, "How discs are overwritten")

You can programme each disc to timer-record as many as 8 programmes.

Before performing On-Disc Timer Programming:

- Turn on the unit.
- Turn on the TV and select the AV mode.
- Slide the TV/CABLE/SAT/DVD switch to DVD.
- Make sure that the unit's built-in clock is set properly.

ATTENTION:

- On-Disc Timer Programming is possible only with the disc for On-Disc Timer Programming.
- If data is recorded on a disc for On-Disc Timer Programming using a unit from another manufacturer, On-Disc Timer Programming may no longer function properly.

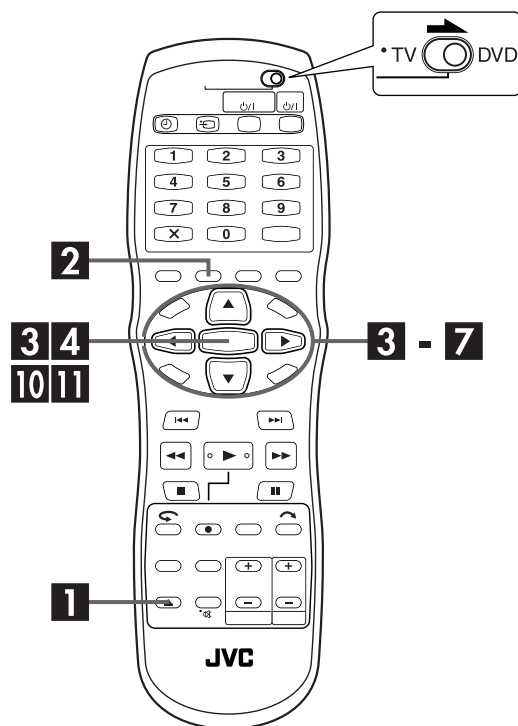

To make the disc for On-Disc Timer Programming

1 Load a disc.

- 1 Press \blacktriangle to open the disc tray.
- 2 Place a recordable disc on the disc tray.
 - For details, refer to "Placing a Disc" (☞ pg. 10).
- 3 Press \blacktriangle to close the disc tray.

2 Access Programme Check screen.

Press **PROG/CHECK**.

3 Access the programme screen.

When On-Disc Timer Programming is made for the first time on the disc

Press \triangle / ∇ repeatedly to select "DISC TIMER PRGM", then press **ENTER**.

- When some programmes are recorded on the disc, a caution message appears. In such a case, backup the programmes as required, then format the disc before making On-Disc Timer Programming. (☞ pg. 106, "Format a disc")

When On-Disc Timer Programming has already been made on the disc

Press \triangle / ∇ repeatedly to select "NEW TIMER PROGRAMME", then press **ENTER**.

4 Enter the recording date.

Press \triangle / ∇ repeatedly to set the desired date.

- The current date appears on the TV screen. The date you enter appears in its place.

5 Enter the recording start time.

Press \triangle / ∇ to select "START", then press \triangle / ∇ repeatedly to set the desired start time.

- Each press of \triangle / ∇ advances/goes back the start time in 1-min. increments.
- To advance/go back the start time in 30-min. increments, press and hold \triangle / ∇ .

6 Enter the recording stop time.

Press ◀▶ to select "STOP", then press △▽ repeatedly to set the desired stop time.

- Each press of △▽ advances/goes back the stop time in 1-min. increments.
- To advance/go back the stop time in 30-min. increments, press and hold △▽.

7 Enter the channel position.

Press ◀▶ to select "TV PROG", then press △▽ repeatedly to select the desired channel.

8 Set "DAILY/WEEKLY" option.

Refer to step 5 in "VIDEO Plus+™ Timer Programming" (pg. 56).

- It is necessary to set "DAILY/WEEKLY" option for On-Disc Timer Programming. (pg. 57, "Daily/Weekly Rec Function")

9 Set the other recording options as required.

Refer to step 5 in "VIDEO Plus+™ Timer Programming" (pg. 56).

10 Access the confirmation screen.

Press ENTER.

11 Complete timer programming.

Press ENTER.

- To programme another timer, repeat steps 2 – 11.

Satellite Receiver Users

To timer-record a satellite broadcast using the On-Disc Timer Programming function:

- 1 Perform "Satellite Receiver Control Setting" on page 28.
- 2 Perform "On-Disc Timer Programming". In step 9, you cannot set "VPS/PDC" to "ON".
- 3 Leave the satellite receiver's power on.

To timer-record the programme with the programmed disc

1 Load the disc.

- 1 Press ▲ to open the disc tray.
- 2 Place the programmed disc on the disc tray.
 - For details, refer to "Placing a Disc" (pg. 10).
- 3 Press ▲ to close the disc tray.

2 Engage the unit's timer mode.

Press DVD ⏻/I. The unit turns off and "DISC ⏻" appears on the front display panel.

- To disengage the timer mode, press DVD ⏻/I again.

NOTES:

- Even if On-Disc Timer Programming is overlapping with other timer programming, any caution message does not appear. In such a case, recording will be executed in the descending order of the recording start time of the programme.
- On-Disc Timer Programming is not possible on a DVD-RW disc formatted in video mode. (pg. 106, "Format a DVD-RW disc")
- The information of a programme recorded with On-Disc Timer Programming is not stored in the library. (pg. 76)
- The play list is not created for the programmes recorded with On-Disc Timer Programming. (pg. 72)
- VIDEO Plus+™ Timer Programming is not possible on the discs used exclusively for On-Disc Timer Programming.
- Manual Timer Programming is not possible on the On-Disc Timer Programmed disc. (pg. 58)
- Basic Recording is not possible on the On-Disc Timer Programmed disc. (pg. 53)
- The On-Disc Timer Programming function does not work on the unit from other manufactures even if the On-Disc Timer Programmed disc is loaded.
- The beginning of a programme may not be recorded. Also, if the 1st programme's recording stop time and the 2nd programme's recording start time is the same, the ending of the 1st programme may not be recorded.
- If there is a power cut while recording, the recordings before the power cut are not guaranteed.

How discs are overwritten

(Example 1)

To record a 1-hour serial drama every Friday in SP mode

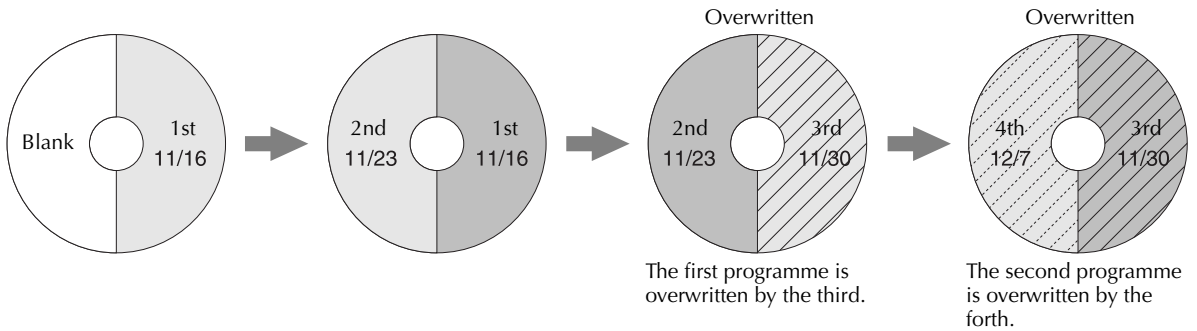

(Example 2)

To record a 15-minute serial drama every morning in XP mode

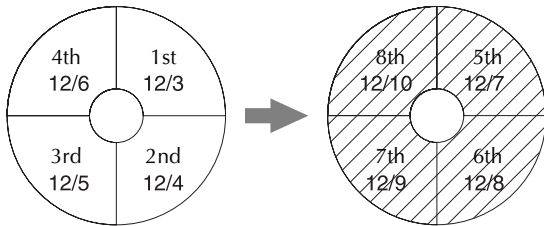

(Example 3)

To record a 90-minute serial drama every Sunday in SP mode

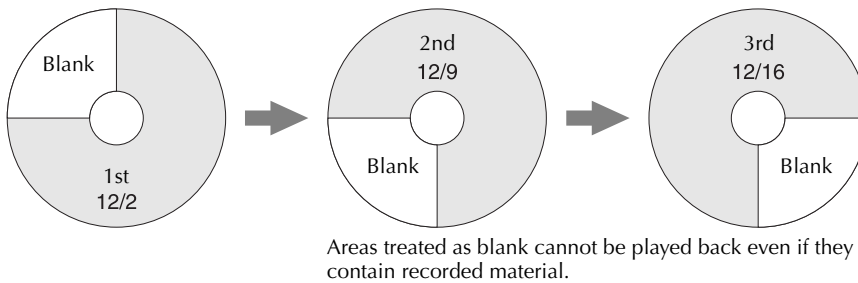

NOTES:

- On-Disc Timer Programming may not always work as these examples.
- On-Disc Timer Programming may not complete successfully if the recording stop time is extended due to PDC.

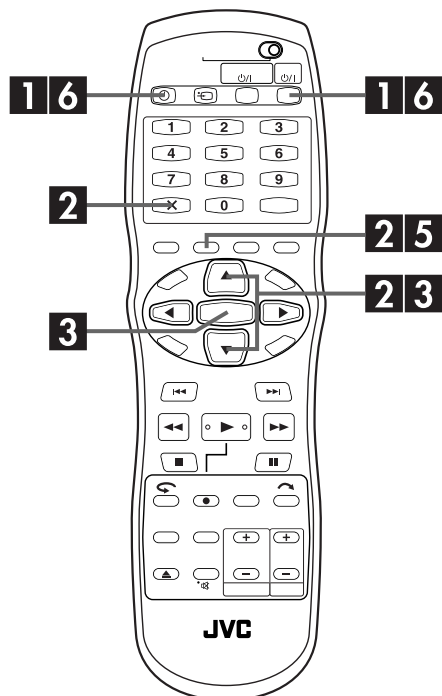

Check, cancel and change programmes

1 Disengage the timer mode.

When “**TIMER**” lights on the front display panel

Press **TIMER** (TIMER), then press **DVD** \downarrow /I.

When “**DISC**” (DISC) lights on the front display panel

Press **DVD** \downarrow /I.

When “**SAT**” (SAT) lights on the front display panel

Press **SAT** (SAT) on the unit, then press **DVD** \downarrow /I.

2 Access Programme Check screen.

Press **PROG/CHECK**.

- To return to the previous screen after you check the programme, press **PROG/CHECK** again.

To cancel the programme

Press Δ / ∇ repeatedly to select a programme to be cancelled, then press **X**.

PROGRAMME CHECK							
DATE	START - STOP	TV PROG	DAILY/WEEKLY	WSP/POD	REC MODE		
05/07 SAT	19:00 - 20:00	44	WEEKLY	ON	SP		
10/07 THU	22:00 - 22:30	56		ON	XP		
11/07 FRI	8:00 - 8:30	55		ON	LP		
***** NEW TIMER PROGRAMME *****							
DISC TIMER PROM							
PROG/CHECK Δ / ∇ OK				SELECT WITH (CURSORS)			
EXIT \times SELECT				THEN PRESS [ENTER]			

3 Access the programme screen.

Press Δ / ∇ to select the programme, then press **ENTER**.

4 Change a programme.

Change the settings of the desired recording options as required.

- Refer to steps **4** - **9** in “Manual Timer Programming” (pg. 58).

5 Complete timer correction.

Press **PROG/CHECK**.

- The previous screen resumes.

6 Engage the unit's timer mode.

For **VIDEO Plus+ or Manual Timer Programming**

Press **TIMER** (TIMER).

For **On-Disc Timer Programming**

Press **DVD** \downarrow /I.

For **Automatic Satellite Programme recording**

Press **SAT** (SAT) on the unit for 2 seconds or more.

Programme's information on the front display panel

You can check the details of the programmes even when the power is turned off. (It is necessary that the Power Save mode (pg. 95, “POWER SAVE”) is disengaged or the unit is not in timer standby mode.) However, it is not possible to cancel or change the programme's setting.

1 Press **PROG/CHECK**.

- “NEW PROG” or “P-1” (if 8 programmes have already been set) appears.

2 Press Δ / ∇ repeatedly until the desired programme number (“P-1” to “P-8”) appears, then press **ENTER**.

3 Press \triangleright .

- Each time you press \triangleright , the indication changes as follows (the settings in parentheses are examples):

Date (“DATE 08.03SU”) \rightarrow Start time (“ON 11:00”) \rightarrow Stop time (“OFF 11:30”) \rightarrow Channel (“PR 1”) \rightarrow Weekly/Daily (“MO-FR DAILY”) \rightarrow Programme number (“P-1”) and Recording speed (SP) \rightarrow (Back to the beginning)

4 Press **PROG/CHECK** to complete checking.

- The normal display resumes.

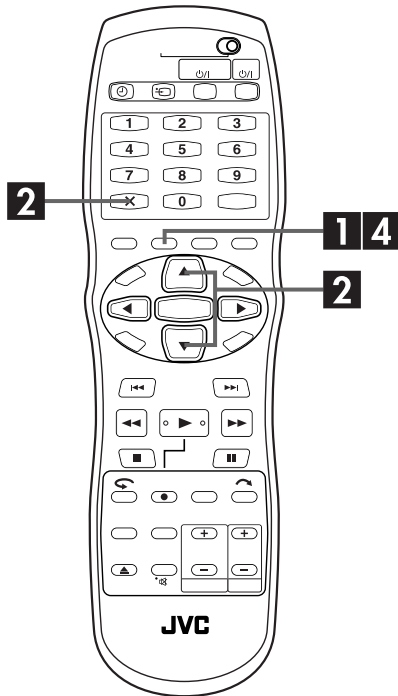

When programmes overlap each other

If "PROGRAM OVERLAPPED" appears, you have another programme overlapping the programme you have just made. Confirm with the arrow on "OK", then press **PROG/CHECK**. Programme Check screen appears and conflicting programmes will be highlighted in pink.

DATE	START-STOP	TV PROG	DAILY/WEEKLY	WSPROG	REC MODE
09:07 SAT	19:00-20:00	44	WEEKLY	ON	SP
10:00 THU	22:00-22:30	16		ON	XP
11:07 FRI	8:30-9:30	36		ON	LP
11:07 FRI	8:30-9:30	33		ON	LP
***** NEW TIMER PROGRAMME *****					

DISC TIMER PRGM

PROG/CHECK OK SELECT WITH (CURSORS)
EXIT SELECT THEN PRESS [ENTER]

Example: Programme 3 (you have just made) and Programme 4 overlap each other.

1 Confirm the overlapping programmes.

Overlapping programmes appear on the TV screen.

NOTE:

If you do not mind this overlap, press **PROG/CHECK** to finish the timer programme setting. The programme with the lower programme number will be recorded and the other one will not be recorded correctly. If no changes are made for approximately 1 minute, the unit will return to the normal screen.

2 Select the desired programme to be cancelled or changed.

Press Δ / ∇ .

To cancel the programme

Press **X**.

- "THE TIMER PROGRAMMING SETTING WAS CANCELLED" appears on the TV screen for about 5 seconds, then the normal screen resumes.

To change the programme setting

Press **ENTER**.

3 Change the programme setting.

- Refer to steps **4** – **10** in "Manual Timer Programming" (pg. 58).

4 Check if the conflict has been settled.

Press **PROG/CHECK**.

- Programme check screen appears.

5 Engage the unit's timer mode.

- Refer to step **6** in "Check, cancel and change programmes" (pg. 63).

NOTE:

When any overlaps remain after deletion and modification of programmes, Programme Check screen remains showing the conflicting programmes. In such a case, repeat the procedure above until the conflict is solved.

Automatic Satellite Programme Recording



This function allows you to automatically record a satellite programme which is timer-programmed on your external satellite receiver. Connect a satellite receiver to the unit's L-2 IN/DECODER connector and programme the timer on the satellite receiver. When the signals come into the unit from the satellite receiver, the unit automatically turns on and starts recording.

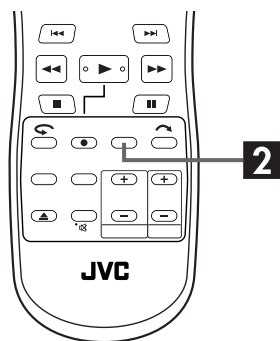
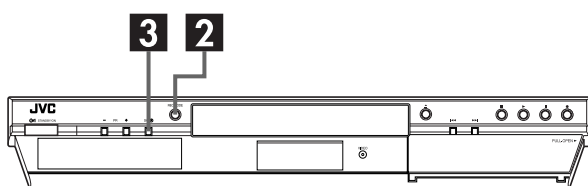

ATTENTION:

- Be sure not to turn on the satellite receiver before the programme is executed; otherwise, the unit will start recording when the satellite receiver's power is turned on.
- If you have connected another appliance other than a satellite receiver to the L-2 IN/DECODER connector, be sure not to engage the Automatic Satellite Programme Recording mode; otherwise, the unit will start recording when the connected appliance's power is turned on.
- Automatic Satellite Programme Recording and timer-recording cannot be done at the same time.

Before performing the following steps:

- Make sure the satellite receiver is connected to the unit's L-2 IN/DECODER connector. (☞ pg. 90)
- Programme the timer on the satellite receiver.
- Slide the TV/CABLE/SAT/DVD switch to TV.

1 Select the L-2 SELECT mode.

Set "L-2 SELECT" to "SAT VIDEO" or "SAT S-VIDEO" (☞ pg. 85, "L-2 Select Setting (L-2 SELECT)").

- Also refer to "IMPORTANT" on page 90.

2 Set the recording speed.

Press REC MODE.

3 Engage the Automatic Satellite Programme Recording mode.

Press and hold SATⓈ for about 2 seconds. "SATⓈ" appears on the front display panel and the unit turns off automatically.

NOTES:

- To disengage the Automatic Satellite Programme Recording mode, press SATⓈ.
- If the unit's power is off, it is not possible to engage the Automatic Satellite Programme Recording mode.
- In step 1, if "SATⓈ" blinks quickly on the front display panel even though your satellite receiver's power is off, Automatic Satellite Programme Recording will not work properly with that satellite receiver*. If this is the case, perform "Manual Timer Programming" (☞ pg. 58) to timer-record a satellite programme.
- * Some satellite receivers output signals even if the power is off. Automatic Satellite Programme Recording is not possible with those satellite receivers.
- "SATⓈ" blinks on the front display panel while Automatic Satellite Programme Recording is in progress.
- For timer programming of the satellite receiver, refer to the instruction manual of the satellite receiver.
- Automatic Satellite Programme Recording is not possible if your satellite receiver does not have a timer.
- Pressing the unit's Ⓢ/1 button while Automatic Satellite Programme Recording is in progress turns off the unit's power and disengages the Automatic Satellite Programme Recording mode.
- If there are more than one satellite programmes you wish to record with Automatic Satellite Programme Recording, it is not possible to set different recording speeds for each programme.
- Depending on the type of satellite receiver, the unit may not record a slight portion of the beginning of the programme or may record slightly longer than the actual length of the programme.
- If you engage the Automatic Satellite Programme Recording mode when the satellite receiver's power is on, the unit will not start Automatic Satellite Programme Recording even though "SATⓈ" blinks on the front display panel. When the satellite receiver shuts off once and is turned back on again, the unit starts recording.
- You can also record a programme from your cable system in the same way if the system has a timer.
- Just Clock (☞ pg. 104) does not work when the Automatic Satellite Programme Recording mode is engaged.
- When the Automatic Satellite Programme Recording mode is engaged, or the unit's power is turned off after Automatic Satellite Programme Recording is finished, the unit will not enter the Timer mode even though "AUTO TIMER" is set to "ON" (☞ pg. 96).

Library Database DVD Navi



The Library Database DVD Navi enables you to search and select the desired programmes recorded on a DVD-RAM/R/RW (VR) disc very easily.

You can record up to 99 programmes on a disc.

Each time a programme is recorded on the disc, the information of the programme is registered for the Library Database DVD Navi automatically.

So, you can confirm the information of the programmes recorded on the disc with the Library Database DVD Navi screen. And, you can also select one of the programmes recorded on the disc using the Library Database DVD Navi.

The following screen appears as the Library Database DVD Navi screen when you press **NAVIGATION**. You can move the arrow to select the desired position on the screen by pressing $\triangle \nabla \triangleleft \triangleright$ on the remote control.

The screenshot shows a menu interface with the following elements:

- 1**: A small thumbnail image of a programme.
- 2**: The name of the function (e.g., ORIGINAL, PLAY LIST, LIBRARY).
- 3**: Remaining time for the selected programme.
- 4**: Current/Total number of programme(s).
- 5**: Small icons representing recording status (e.g., write-protected, stereo, bilingual, timer).
- 6**: Detailed recording information for the selected programme (e.g., DANCE GURUVI, PHOTO SHOW, 10:00-11:00, PS, TCH, SP, 60min).
- 7**: Guidance for operations (e.g., SELECT WITH [CURSORS] THEN PRESS [ENTER]).
- 8**: Operational commands (e.g., MODIFY, DELETE, EDITING, PROTECT).

- 1 Index
(Small still picture of each programme)
- 2 Names of functions
ORIGINAL (☞ pg. 69)
PLAY LIST (☞ pg. 72)
LIBRARY (☞ pg. 76)
- 3 Remaining time
(Based on the recording speed currently selected)
- 4 Current/Total number of programme(s)
(For example, there are 6 recorded programmes and the programme indicated by the arrow is the 3rd one.)
- 5 Icons
(Indicate the recording situation for each programme.)
- 6 Recording information for the programme indicated by the arrow
- 7 Guidance for operations
- 8 Operational commands

The Icons and their meanings

	This programme is write-protected.
	This programme has stereo sounds.
	This programme has bilingual sounds.
	This programme was recorded with timer recording.

Using Library Database DVD Navi system, you can easily modify registered information, edit the programme or play list, as well as search for the beginning of each programme.

About registration of information

The following information is automatically registered for each programme when ordinary recording or timer recording is performed, then stored in an area specified on the unit.

- index* (reduced still pictures to show programme titles)
- programme title*
- category*
- date and time
- channel
- recording speed
- length of recording time

The items marked with an asterisk (*) can be easily modified and registered again after recording by using Library Database DVD Navi system.

About editing of programmes

Library Database DVD Navi system has the following functions for editing of programmes.

- "Modify Original Information" (⏏ pg. 69)
- "Delete programme" (⏏ pg. 71)

The limitations of registration

You can register information up to 99 programmes.

When the amount of information is at the limits of registration, you cannot record new programme any more. In this case, you need to delete old programmes to register new one. (⏏ pg. 71, "Delete programme")

NOTES:

- The Library Database DVD Navi screen is not displayed once a DVD-R/RW (Video mode) disc has been finalised. The DVD menu appears instead.
- On the other hand, the Library Database DVD Navi screen is displayed even if a DVD-RW (VR mode) disc has been finalised.

The display for original recording



The display for play list



The display for library



DVD menu



Scan for Beginning(s) of Programme(s)

- Turn on the TV and select the AV mode.
- Slide the TV/CABLE/SAT/DVD switch to DVD.

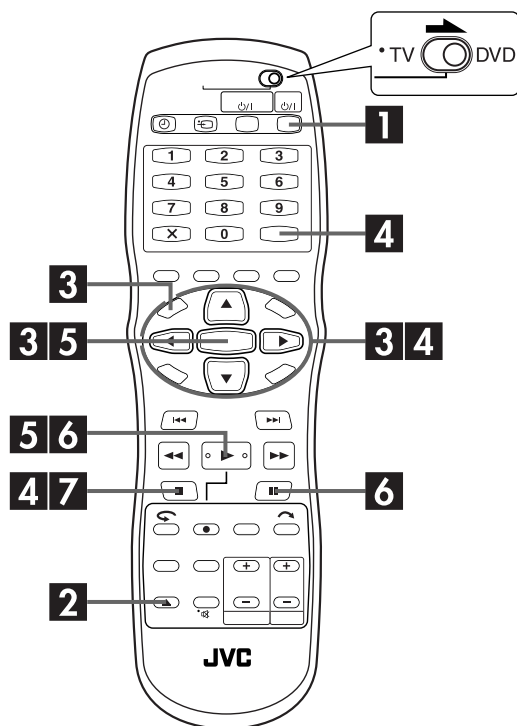



You can scan the beginning of the programme easily with the Library Database DVD Navi.



1 Turn on the unit.

Press **DVD** .

2 Load a disc.



- 1 Press  to open the disc tray.
- 2 Place a recorded disc on the disc tray.
 - For details, refer to "Placing a Disc" ( pg. 10).
- 3 Press  to close the disc tray.

3 Access the Index screen.

- 1 Press **NAVIGATION**. The Library Database DVD Navi screen appears.
- 2 Press    to move the arrow to "ORIGINAL", then press **ENTER**.



4 Select the programme(s).

Press   to move the arrow on the index (small still pictures) of the desired programme.

- When you want the plural programmes to be played back continuously, press **MEMO** after selecting the desired programme. The numbers of the playback order appear on the index. You can select up to 30 programmes.
- When you want to correct the order, move the arrow on the desired index and press **MEMO**. The number disappears and the unit re-numbers the other programmes automatically.
- When you want to cancel the order, press .



5 Start playback.

Press **ENTER**. Or simply press . The playback starts.

6 Pause playback.

Press .

- To resume normal playback, press .

7 Stop playback.

Press .

Modify Original Information



- Turn on the TV and select the AV mode.
- Slide the TV/CABLE/SAT/DVD switch to DVD.

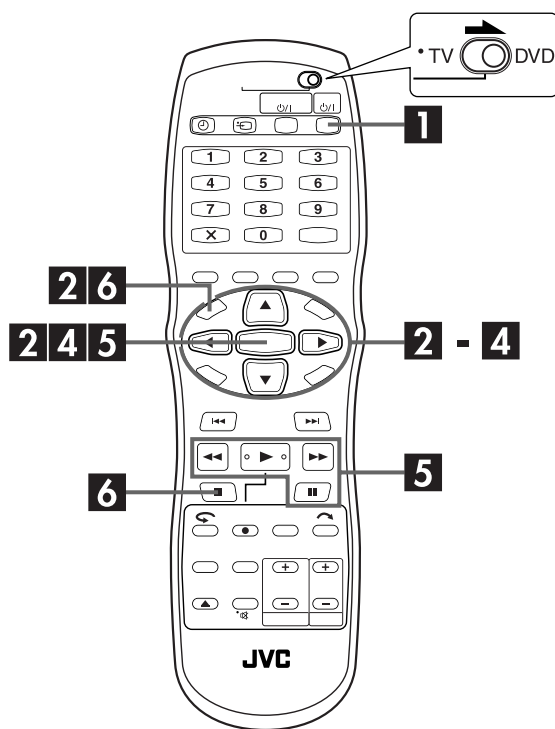

Modify Index

1 Turn on the unit.

Press **DVD** .

2 Access the Index screen.

- 1 Press **NAVIGATION**. The Library Database DVD Navi screen appears.
- 2 Press $\Delta \nabla \triangleleft \triangleright$ to move the arrow to "ORIGINAL", then press **ENTER**.

3 Select a programme.

Press $\Delta \nabla \triangleleft \triangleright$ to move the arrow to select one programme you want to modify, then press ∇ .

4 Access the modify screen.

- 1 Press $\Delta \nabla \triangleleft \triangleright$ to move the arrow to "MODIFY", then press **ENTER**.
- 2 Press $\triangleleft \triangleright$ to move the arrow to "MODIFY INDEX". The "MODIFY INDEX" screen appears.

5 Register new index.

- 1 Search for the picture from the programme by pressing the appropriate buttons ($\triangleleft \triangleleft$, \triangleright , $\triangleright \triangleright$, or **II**). The pictures of the programme appear on the left window.

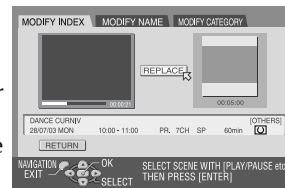

- 2 Confirm the arrow is on "REPLACE", then press **ENTER** to register new index. New index appears on the right window.
 - When you press **ENTER** with the arrow on "RETURN" you can return to the previous screen.

6 Return to the normal screen.

Press **NAVIGATION**.

- Press **■** to cancel pause mode after pressing **NAVIGATION**.

Modify Programme Name

Perform steps **1** to **3** of "Modify Index" (☞ pg. 69) before continuing.

1 Access the modify screen.

- Press $\Delta \nabla \triangleleft \triangleright$ to move the arrow to "MODIFY", then press **ENTER**.
- Press $\triangleleft \triangleright$ to move the arrow to "MODIFY NAME". The "MODIFY NAME" screen appears.

2 Enter new name.

Press $\Delta \nabla \triangleleft \triangleright$ to move the arrow to the desired letter or command, then press **ENTER**. Repeat this process to complete the name.

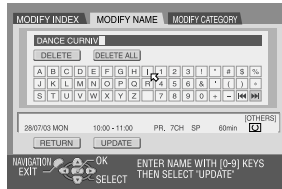

- To correct a letter, press $\Delta \nabla \triangleleft \triangleright$ to move the arrow to "DELETE" or "DELETE ALL", then press **ENTER**.
- You can enter the letters up to 64.
- You can also enter the new name with **number keys**. For example, when you press **2** repeatedly, "A", "B", "C", "a", "b", "c", "2", and then "A" appear by turns. You can use the following buttons.

Number keys: for entering letters, numbers and blank space
 $\triangleleft \triangleright$ **buttons:** for moving the entering or inserting point
■ **button:** for correcting a letter
 $\blacktriangleleft \blacktriangleright$ **buttons:** for changing character tables

3 Register new name.

Press $\Delta \nabla \triangleleft \triangleright$ to move the arrow to "UPDATE", then press **ENTER**.

4 Return to the Library Database DVD Navi screen.

Press $\Delta \nabla \triangleleft \triangleright$ to move the arrow to "RETURN", then press **ENTER**. The Library Database DVD Navi screen appears again.

5 Return to the normal screen.

Press **NAVIGATION**.

Modify Category

Perform steps **1** to **3** of "Modify Index" (☞ pg. 69) before continuing.

1 Access the modify screen.

- Press $\Delta \nabla \triangleleft \triangleright$ to move the arrow to "MODIFY", then press **ENTER**.
- Press $\triangleleft \triangleright$ to move the arrow to "MODIFY CATEGORY". The "MODIFY CATEGORY" screen appears.

2 Select new category.

Press $\Delta \nabla \triangleleft \triangleright$ to move the arrow to the desired category, then press **ENTER**.



3 Register new category.

Press **ENTER**. The Library Database DVD Navi screen appears again.

4 Return to the normal screen.

Press **NAVIGATION**.

Protect title

You can protect the programme to prevent accidental erasure of the important programme.

Perform steps **1** to **2** of "Modify Index" (☞ pg. 69) before continuing.

1 Select a programme.

Press $\Delta \nabla \triangleleft \triangleright$ to move the arrow to a programme you want to protect, then press ∇ .

2 Protect the programme.

Press $\triangleleft \triangleright$ to move the arrow to "PROTECT", then press **ENTER**.

- "" appears.
- To cancel the protection, repeat **1** – **2** again.

3 Return to the normal screen.

Press **NAVIGATION**.

NOTE:

All the programmes on a disc will be deleted once the disc is formatted even if they are protected titles. (☞ pg. 106)

Delete programme

You cannot record any more with Library Database DVD Navi once the registered programmes on the disc reach 99 programmes. Deleting unnecessary programmes after dubbing (☞ pg. 83, "Edit To Or From Another Recorder") or other operations can increase remaining time and available recording capacity. (For DVD-R discs, although it is possible to delete recorded programmes, available recording capacity does not increase.) The deleted programme is never resumed. Play lists and programme information in the unit's library are also deleted.

Perform steps **1** to **2** of "Modify Index" (☞ pg. 69) before continuing.

1 Select a programme.

Press ◀▶ to move the arrow to select one programme you want to delete, then press ▽.

2 Access the delete screen.

Press △▽◀▶ to move the arrow to "DELETE", then press ENTER. The message appears for your confirmation.

3 Confirm the deletion.

Press ◀▶ to select "YES", then press ENTER.

- When you cancel the deletion, select "NO", then press ENTER.

4 Return to the normal screen.

Press NAVIGATION.

Delete unwanted part of the programme

You can delete unwanted part of the programme.

Perform steps **1** to **2** of "Modify Index" (☞ pg. 69) before continuing.

1 Select a programme.

Press ◀▶ to move the arrow to select one programme whose unwanted part you want to delete, then press ▽.

2 Access the delete screen.

Press ◀▶ to move the arrow to "EDITING", then press ENTER.

3 Start playback.

Press ▶ to start playback. The playback pictures appear in the window on the screen. The elapsed playing time starts counting with the arrow on "IN".

4 Set edit-in and edit-out points.

- 1 Find the point where you want the deletion to begin, then press ENTER with the arrow on "IN". The edit-in time is fixed and the elapsed playing time starts counting again.

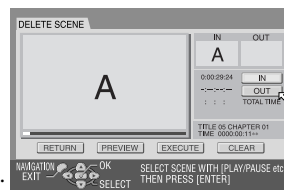

- 2 Find the point where you want the deletion to end, then press ENTER with the arrow on "OUT". The edit-out time is fixed.

- Press ◀◀, ▶, ▶▶, ◀◀, ▶▶ or || to find the edit-in and edit-out points.

5 Confirm the deletion.

- 1 Press △▽◀▶ to move the arrow to "PREVIEW", then press ENTER to preview the edited programme.
- 2 Press △▽◀▶ to select "EXECUTE", then press ENTER.
 - If you do not want to delete the scene, select "CLEAR" and press ENTER.
- 3 Press ◀▶ to select "YES", then press ENTER.
 - The selected scene is deleted.
 - To cancel the deletion, press ◀▶ to select "NO", then press ENTER.

To modify the points

- 1 Press ◀▶ to move the arrow to "CLEAR", then press ENTER.
- 2 Repeat step **3** – **5**.

6 Return to the normal screen.

Press NAVIGATION.

NOTES:

- There may be a discrepancy of several seconds between the scene you intend to edit, and the scene which is actually edited.
- Available recording capacity may not match the deleted part after deletion.

Modify Play List Information



- Turn on the TV and select the AV mode.
- Slide the TV/CABLE/SAT/DVD switch to DVD.

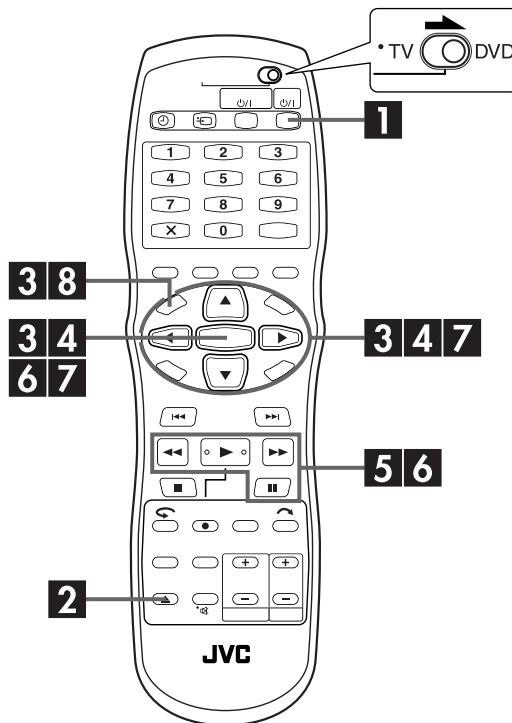

■ Play List

It is a collection of the scenes. A play list can be freely edited and played back without ever changing any original recording data.

Using the random access of a DVD disc (which allows video data to be instantly read no matter where it is on the disc), a play list includes information such as the timer counter for the playback start point and end point, indexes for checking the contents of recorded data, category information, and more. Playback according to a play list you have created allows you to enjoy various combinations of video images from a single programme.

Create Play List

1 Turn on the unit.

Press **DVD** \odot /I.

2 Load a disc.

- 1 Press \blacktriangle to open the disc tray.
- 2 Place a DVD-RAM or DVD-RW (VR mode) disc that was recorded with this unit on the disc tray.
- For details, refer to "Placing a Disc" (pg. 10).
- 3 Press \blacktriangle to close the disc tray.

3 Access the Play List screen.

- 1 Press **NAVIGATION**. The Library Database DVD Nav screen appears.
- 2 Press \triangle ∇ \triangleleft \triangleright to move the arrow to "PLAY LIST", then press ∇ or **ENTER**.

4 Create a play list.

Press \triangle ∇ \triangleleft \triangleright to move the arrow to "CREATE", then press **ENTER**.

5 Start playback.

Press \blacktriangleright to start playback. The playback pictures appear in the window on the screen. The elapsed playing time starts counting with the arrow on "IN".

- To locate the beginning of other titles, press \blacktriangleleft \blacktriangleright .

6 Set edit-in and edit-out points.

- 1 Find the point where you want the created play list to begin, then press **ENTER** with the arrow on "IN". The edit-in time is fixed and the elapsed playing time starts counting again.
- 2 Find the point where you want the created play list to end, then press **ENTER** with the arrow on "OUT". The edit-out time is fixed.
 - Press \blacktriangleleft , \blacktriangleright , \blacktriangleright , \blacktriangleright , \blacktriangleleft , \blacktriangleright or \parallel to find the edit-in and edit-out points.
 - The edit-out point must come after the edit-in point.

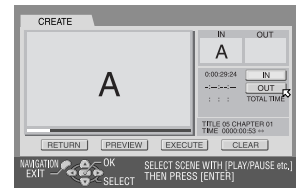

7 Confirm the play list.

- 1 Press \triangleleft \triangleright to move the arrow to "PREVIEW", then press **ENTER** to preview the play list.
- 2 Press \triangleleft \triangleright to select "EXECUTE", then press **ENTER**.
 - The play list is created.

To modify the points

- 1 Press \triangleleft \triangleright to move the arrow to "CLEAR", then press **ENTER**.
- 2 Repeat step **5** – **7**.

8 Return to the normal screen.

Press **NAVIGATION**.

NOTES:

- There may be a discrepancy of several seconds between the scene you intend to edit, and the scene which is actually edited.
- The title, index and category of the play list can be modified in the same way as "ORIGINAL". (☞ pg. 69, "Modify Original Information")
- You can modify the play list that has just been created here by adding, moving, or deleting unwanted parts to create a digest edition, etc.

Add scenes to a play list

Perform steps **1** to **3** of "Create Play List" (☞ pg. 72) before continuing.

1 Select a play list.

Press $\triangleleft \triangleright$ to move the arrow to the play list to which you wish to add a scene, then press ∇ .

2 Access the Editing screen.

- 1 Press $\triangleleft \triangleright$ to move the arrow to "EDITING", then press **ENTER**.
- 2 Press $\triangleleft \triangleright$ to move the arrow to "ADD SCENE".



3 Start playback.

Press \blacktriangleright to start playback. The playback pictures appear in the window on the screen. The elapsed playing time starts counting with the arrow on "IN".

- To locate the beginning of other titles, press $\mathbb{L} \ll \lll \ggg \gg \mathbb{R}$.

4 Set edit-in and edit-out points.

- 1 Find the point where you want the added scene to begin, then press **ENTER** with the arrow on "IN". The edit-in time is fixed and the elapsed playing time starts counting again.
 - 2 Find the point where you want the added scene to end, then press **ENTER** with the arrow on "OUT". The edit-out time is fixed.
- Press $\mathbb{L} \ll \lll \ggg \gg \mathbb{R}$ or \mathbb{H} to find the edit-in and edit-out points.

5 Confirm the addition.

- 1 Press $\triangleleft \triangleright$ to move the arrow to "PREVIEW", then press **ENTER** to preview approximately 5 seconds before and after the edited scene.
- 2 Press $\triangleleft \triangleright$ to select "EXECUTE", then press **ENTER**.
 - The selected scene is added.

To modify the points

- 1 Press $\triangleleft \triangleright$ to move the arrow to "CLEAR", then press **ENTER**.
- 2 Repeat step **3** – **5**.

6 Return to the normal screen.

Press **NAVIGATION**.

NOTE:

There may be a discrepancy of several seconds between the scene you intend to edit, and the scene which is actually edited.

Move scenes

Perform steps **1** to **3** of "Create Play List" (☞ pg. 72) before continuing.

1 Select a play list.

Press $\triangleleft \triangleright$ to move the arrow to a play list into which you wish to move a scene, then press ∇ .

2 Access the Editing screen.

- 1 Press $\triangleleft \triangleright$ to move the arrow to "EDITING", then press **ENTER**.
- 2 Press $\triangleleft \triangleright$ to move the arrow to "MOVE SCENE".

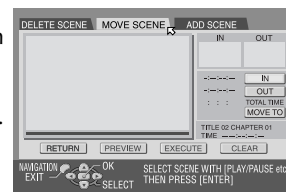

3 Start playback.

Press \blacktriangleright to start playback. The playback pictures appear in the window on the screen. The elapsed playing time starts counting with the arrow on "IN".

- To locate the beginning of other titles, press $\mathbb{L} \ll \lll \ggg \gg \mathbb{R}$.

4 Set edit-in and edit-out points.

- 1 Find the point where you want the moved scene to begin, then press **ENTER** with the arrow on "IN". The edit-in time is fixed and the elapsed playing time starts counting again.
 - 2 Find the point where you want the moved scene to end, then press **ENTER** with the arrow on "OUT". The edit-out time is fixed.
 - 3 Press **▶** to start playback.
 - 4 Find the point where you want the moved scene to be moved, then press **ENTER** with the arrow on "MOVE TO".
- Press **◀◀, ▶, ▶▶, ◀◀, ▶▶, ▶▶** or **||** to find the edit-in, edit-out and move-to points.

5 Confirm the move.

- 1 Press **◀▶** to move the arrow to "PREVIEW", then press **ENTER** to preview the part approximately 5 seconds before and after the point to which the scene has been moved.
 - 2 Press **◀▶** to select "EXECUTE", then press **ENTER**.
- The selected scene is moved.

To modify the points

- 1 Press **◀▶** to move the arrow to "CLEAR", then press **ENTER**.
- 2 Repeat step **3** – **5**.

6 Return to the normal screen.

Press **NAVIGATION**.

NOTE:

There may be a discrepancy of several seconds between the scene you intend to edit, and the scene which is actually edited.

Delete unwanted part from play list

Perform steps **1** to **3** of "Create Play List" (pg. 72) before continuing.

1 Select a play list.

Press **◀▶** to move the arrow to a play list from which you wish to delete unwanted parts, then press **▽**.

2 Access the Editing screen.

- 1 Press **◀▶** to move the arrow to "EDITING", then press **ENTER**.
- 2 Press **◀▶** to move the arrow to "DELETE SCENE", then press **ENTER**.



3 Start playback.

Press **▶** to start playback. The playback pictures appear in the window on the screen. The elapsed playing time starts counting with the arrow on "IN".

- To locate the beginning of other titles, press **◀◀▶▶**.

4 Set edit-in and edit-out points.

- 1 Find the point where you want the deletion to begin, then press **ENTER** with the arrow on "IN". The edit-in time is fixed and the elapsed playing time starts counting again.
 - 2 Find the point where you want the deletion to end, then press **ENTER** with the arrow on "OUT". The edit-out time is fixed.
- Press **◀◀, ▶, ▶▶, ◀◀, ▶▶, ▶▶** or **||** to find the edit-in and edit-out points.

5 Confirm the deletion.

- 1 Press **◀▶** to move the arrow to "PREVIEW", then press **ENTER** to preview the scene approximately 5 seconds before and after the deleted part.
 - 2 Press **◀▶** to select "EXECUTE", then press **ENTER**.
- The selected scene is deleted.

To modify the points

- 1 Press **◀▶** to move the arrow to "CLEAR", then press **ENTER**.
- 2 Repeat steps **3** – **5**.

6 Return to the normal screen.

Press **NAVIGATION**.

NOTE:

There may be a discrepancy of several seconds between the scene you intend to edit, and the scene which is actually edited.

Play back play list

Perform steps **1** to **3** of "Create Play List" (☞ pg. 72) before continuing.

1 Select the play list(s).

Press ◀▶ to move the arrow on the index (small still pictures) of the desired play list.

- When you want the plural play lists to be played back continuously, press **MEMO** after selecting the desired play lists. The numbers of the playback order appear on the index. You can select up to 30 play lists.



- When you want to correct the order, move the arrow on the desired index and press **MEMO**. The number disappears and the unit re-numbers the other play lists automatically.
- When you want to cancel the order, press **■**.

2 Start playback.

Press **ENTER**. Or simply press ▶. The playback starts.

3 Pause playback.

Press **II**.

- To resume normal playback, press ▶.

4 Stop playback.

Press **■**.

Delete play list

Perform steps **1** to **3** of "Create Play List" (☞ pg. 72) before continuing.

1 Select a play list.

- 1 Press ◀▶ to move the arrow to select one play list you want to delete, then press ▽.
- 2 Press ◀▶ to move the arrow to "DELETE", then press **ENTER**.

2 Confirm the deletion.

Press ◀▶ to select "YES", then press **ENTER**.

- When you cancel the deletion, select "NO", then press **ENTER**.

3 Return to the normal screen.

Press **NAVIGATION**.

NOTE:

Even if a play list is deleted, the programmes recorded on a DVD disc and the library information are not affected at all.

Modify Index

- 1 Perform steps **1** to **3** of "Create Play List" (☞ pg. 72).
- 2 Perform steps **3** to **6** of "Modify Index" (☞ pg. 69).

Modify Programme Title

- 1 Perform steps **1** to **3** of "Create Play List" (☞ pg. 72).
- 2 Perform steps **1** to **5** of "Modify Programme Name" (☞ pg. 70).

Modify Category

- 1 Perform steps **1** to **3** of "Create Play List" (☞ pg. 72).
- 2 Perform steps **1** to **4** of "Modify Category" (☞ pg. 70).

Modify Library Information



Programme information can be registered in the unit's memory for up to 1,300 programmes. It is helpful when finding out on which disc the desired programme is recorded.

- Turn on the TV and select the AV mode.
- Slide the TV/CABLE/SAT/DVD switch to DVD.

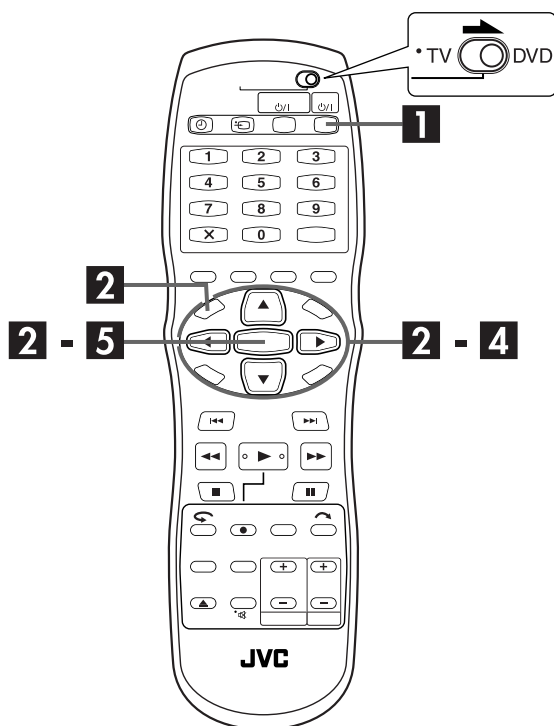

Scan for Programme from library

1 Turn on the unit.

Press DVD $\odot/1$.

2 Access the library screen.

- 1 Press NAVIGATION. The Library Database DVD Navi screen appears.
- 2 Press $\triangle \nabla \triangleleft \triangleright$ to move the arrow to "LIBRARY", then press ENTER.

3 Sort the information.

Press $\triangleleft \triangleright$ to move the arrow to the appropriate sort button to sort the information, then press ENTER.



"DISC No.": Sort by disc number

"CATEGORY": Sort by category

"DATE": Sort by date

"NAME": Sort by name

- The sorting order can be switched between ascending order and descending order by pressing the sort buttons.

4 Select the programme(s).

Press $\triangleleft \triangleright$ to move the arrow to select the desired programme, then press ENTER.

- Playback begins automatically after the selected programme is located.

When the disc that contains the selected programme is not loaded

A screen prompting you to load the designated disc appears. Place the disc whose number is displayed on the screen after pressing ENTER to close the prompt screen. Then perform steps 2 to 4.

5 Return to the normal screen.

Press NAVIGATION.

NOTE:

If a disc registered in the library is recorded or modified on DVD units from other manufacturers, it may become impossible to operate properly.

Register disc

1 Turn on the unit.

Press **DVD** \cup /I.

2 Load a disc.

- 1 Press \blacktriangle to open the disc tray.
- 2 Place a disc you want to register on the disc tray.
 - For details, refer to "Placing a Disc" (pg. 10).
- 3 Press \blacktriangle to close the disc tray.

3 Access the library screen.

- 1 Press **NAVIGATION**. The Library Database DVD Navi screen appears.
- 2 Press $\triangle \nabla \triangleleft \triangleright$ to move the arrow to "LIBRARY", then press **ENTER**.

4 Register the disc.

Press $\triangleleft \triangleright$ to move the arrow to "REGISTER", then press **ENTER**.

5 Confirm the registration.

Press $\triangleleft \triangleright$ to select "REGISTER", then press **ENTER**.

6 Return to the normal screen.

Press **NAVIGATION**.

NOTES:

- It is not possible to register discs used for On-Disc Timer Programming. (pg. 60)
- It is not possible to register discs formatted on devices other than JVC's DVD recorders.
- It is not possible to register discs recorded on devices other than JVC's DVD recorders.
- It is not possible to register discs when "SAVE AS LIBRARY" is set to "OFF" in FUNCTION SET UP menu. (pg. 94)

Delete information

1 Turn on the unit.

Press **DVD** \cup /I.

2 Access the library screen.

- 1 Press **NAVIGATION**. The Library Database DVD Navi screen appears.
- 2 Press $\triangle \nabla \triangleleft \triangleright$ to move the arrow to "LIBRARY", then press **ENTER**.

3 Select a programme.

- 1 Press $\triangle \nabla \triangleleft \triangleright$ to move the arrow to the appropriate sort button to sort the information, then press **ENTER**.
- 2 Press $\triangleleft \triangleright$ to move the arrow to a programme you want to delete, then press ∇ .

4 Delete the programme.

Press $\triangle \nabla \triangleleft \triangleright$ to move the arrow to "DELETE", then press **ENTER**.

5 Confirm the deletion.

Press $\triangleleft \triangleright$ to select "DELETE", then press **ENTER**.

6 Return to the normal screen.

Press **NAVIGATION**.

Playback with MP3/JPEG Navigation



This unit can play back discs that MP3 sound files and JPEG image files taken with digital still cameras or other devices are recorded. The MP3/JPEG Navigation enables you to search and select the desired files recorded on CD-R/RW or CD-ROM discs very easily.

The following screen appears as the MP3/JPEG Navigation screen when you press **NAVIGATION**. You can move the arrow to select the desired position on the screen by pressing $\triangle \nabla \triangleleft \triangleright$ on the remote control.

The top screenshot shows a navigation menu with the following elements:

- 1: Name of the inserted disc (MY BEST)
- 2: Sort buttons (MP3/JPEG)
- 3: Selected group number/total number of groups on the disc (1/1)
- 4: Group name (ROOT)
- 5: Return button (RETURN)
- 6: Group name/Created date (MUSIC/FRANCE/POPS 2011/03 TUE)
- 7: File type indicator (MUSIC/FRANCE/POPS 2011/03 TUE)

The bottom screenshot shows a detailed file list for a selected group:

- 7: File type indicator (01SONG)
- 8: Selected file (01SONG)
- 9: Selected file number/total number of files in the group that contains the selected file (1/1)
- 10: Programme number/file name (01SONG)

- 1 Name of the inserted disc.
- 2 Sort buttons ("MP3"/"JPEG")
- 3 Selected group number/total number of groups on the disc
- 4 Group name
- 5 Return button ("RETURN")
- 6 Group name/Created date
- 7 File type indicator
 - ♪: MP3
 - 📷: JPEG
- 8 Selected file
- 9 Selected file number/total number of files in the group that contains the selected file
- 10 Programme number/file name

Locating the desired group and tracks

1 Load a disc.

- 1 Press **▲** to open the disc tray.
- 2 Place a disc on the disc tray.
 - For details, refer to "Placing a Disc" (☞ pg. 10).
- 3 Press **▲** to close the disc tray.

2 Access the MP3/JPEG Navigation screen.

Press **NAVIGATION**. The MP3/JPEG Navigation screen appears.

3 Display the item.

For MP3 Playback

Press **◀▶** to move the arrow to "MP3".

- Only groups which contain MP3 files appear.

For JPEG Playback

Press **◀▶** to move the arrow to "JPEG".

- Only groups which contain JPEG files appear.

4 Select the group.

Press **◀▶** to move the arrow to the desired group, then press **ENTER**.

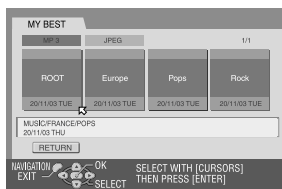

For MP3 Playback

- The tracks in the selected group appear.

For JPEG Playback

- The images in the selected group appear.

5 Select the item.

Press **△▽◀▶** to move the arrow to the desired item, then press **ENTER**. The unit starts playback from the selected item.

- The unit stops when all items in the selected group are played back.

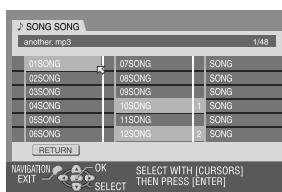

NOTES:

- If you press **▶** instead of **ENTER** in step 4, the unit starts playback from the first file of the group.
- JPEG files are played back as a slide show at the set intervals. (☞ pg. 48, "Select the switching interval of the slide show")
- If a file name includes any 2-byte character, the unit may not show the file name correctly.
- Press **△▽** to move the arrow to "RETURN", then press **ENTER** to return to the screen that shows the group(s).
- The order of the groups and items shown in step 4 and 5 may differ from the order shown on your PC.

Programme Playback

Perform steps 1 to 4 of "Locating the desired group and tracks" in the left column before continuing.

1 Select the items in the desired order.

Press **△▽◀▶** to move the arrow to the desired item, then press **MEMO**.

- The order number appears on the left of the track name.
- Repeat this step as necessary.
- To cancel the track, press **△▽◀▶** to move the arrow to the track, then press **X**.
- Pressing **■** clears all the order numbers.

2 Start playback.

Press **▶**.

- To quit the Programme Playback, press **■**.
- Repeat playback can be performed if it is set as such in Play Set Up menu. (☞ pg. 44, "Repeat Playback")

NOTES:

- It is not possible to select tracks and images simultaneously.
- It is not possible to select tracks or images in other groups.

On completion of the playback of all the items

- 1 Perform steps 1 to 4 of "Locating the desired group and tracks" in the left column.
- 2 Press **■**.
 - The order numbers are reset and cleared.
- 3 Press **NAVIGATION** to complete the procedure.

DV Dubbing

You can dub programmes from a camcorder or DV equipment connected to the unit with a DV cable. The unit's remote control allows you the limited control of the connected camcorder or DV equipment functions during dubbing.

NOTE:

When you connect a PC to the DV IN connector, we do not assure the normal operation of this unit.

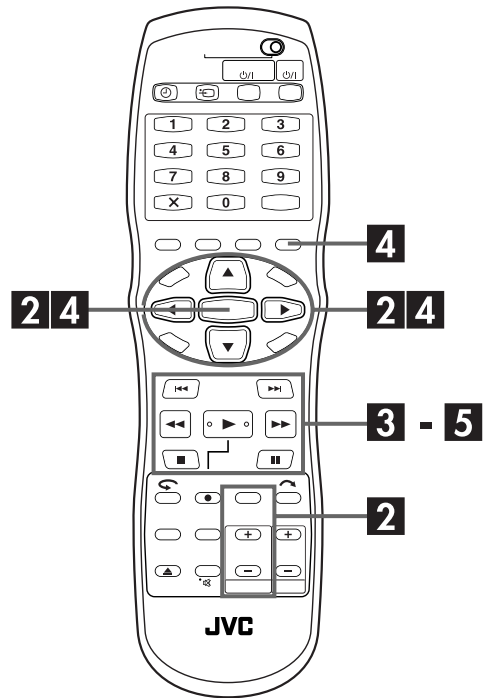
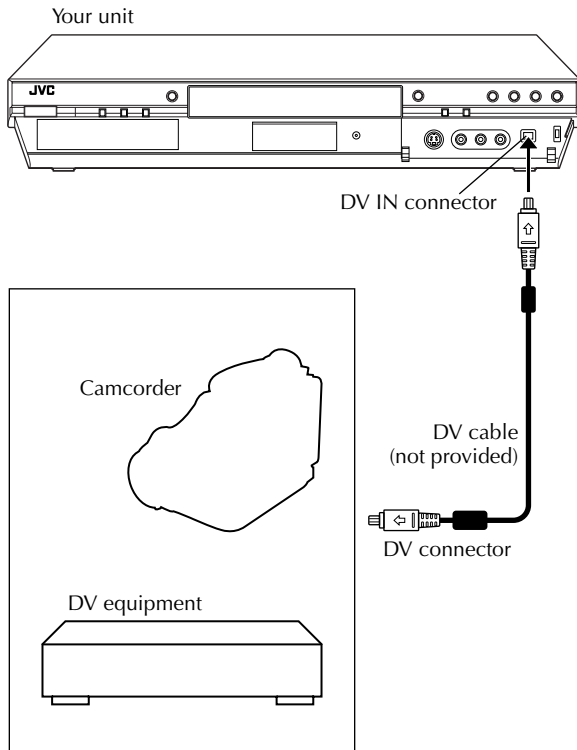

1 Make connections.

Connect a camcorder or DV equipment to the DV IN connector on the unit's front panel.

2 Prepare the unit for dubbing.

1 Load a DVD-RAM/RW/R disc on the unit.

2 Press **PR +/-** to set the channel to "DV DUBBING".

• The "DV DUBBING" controller appears on the TV screen.

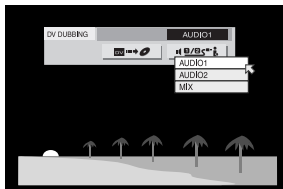

3 Press **< >** to move **↔** to **|| 0/05 ||**, then press **ENTER**.

4 Press **△ ▽** repeatedly to select the desired sound track, then press **ENTER**.

AUDIO 1:	Select this to record the original stereo sound played back on the connected DV equipment.
AUDIO 2:	Select this to record the dubbed stereo sound played back on the connected DV equipment.
MIX:	Select this to record the sound of both "AUDIO 1" and "AUDIO 2".

• Note that this selection is not available when the source programme is recorded in 16BIT (48 kHz) mode.

5 Press **REC MODE** repeatedly until the desired recording speed appears. (☞ pg. 54, "Recording Speed")

3 Prepare the DV equipment for dubbing.

Locate the point from where you want to start dubbing, then stop or pause playback by pressing the following buttons on the remote control:

▶, ▶▶, ◀◀, ■, ||

• To play back in slow speed (1/10 of the normal speed), press **||** to pause playback, then press **◀◀** or **▶▶**.

• To play back frame-by-frame, press **||** to pause playback, then press **||** repeatedly. Each press of **||** advances a frame.

• To change the playback direction, press **◀◀** or **▶▶**.

4 Start dubbing.

Press **< >** to move the arrow to **DV |||▶▶**, then press **ENTER**.

• Playback on the external DV equipment and recording on the unit should start simultaneously.

• When the playback from the beginning is not possible, the "DV DUBBING" controller cannot be used. Perform dubbing without using the "DV DUBBING" controller. (☞ right column)

• To pause dubbing, press **< >** to move **↔** to **|||▶▶**, then press **ENTER**. Both the unit and the external DV equipment pause dubbing. Pressing **||** on the unit also works the same way.

• To clear the "DV DUBBING" controller from the TV screen, press **PLAY SET UP**.

5 Stop dubbing.

Press **■** on the remote control.

• Both the unit and the external DV equipment stop dubbing.

NOTES:

- Dubbing copyright guarded programmes is not possible.
- Original DV informations such as the recording date and time are not recorded.
- The superimposed indication during the operation or dubbing is not recorded.
- The "DV DUBBING" controller disappears if **SET UP** or other buttons are pressed. To display the "DV DUBBING" controller again, press **PLAY SET UP** on the remote control.

Performing dubbing without using the "DV DUBBING" controller

- 1 Press **PR +/-** to set the channel to "DV DUBBING".
- 2 Press **REC MODE** repeatedly until the desired recording speed appears.
- 3 Start playback on the external DV equipment slightly before the actual point from where you wish to start dubbing.
- 4 Press and hold **●**, then press **▶** on the remote control, or press **●** on the unit.
- 5 When the dubbing ends, press **■** on the unit, then stop playback on the external DV equipment.

Edit From A Camcorder

You can use a camcorder as the source player and your unit as the recording deck.

Slide the **TV/CABLE/SAT/DVD** switch to **DVD**.

1 Make connections.

- 1 If the camcorder has no S-VIDEO output connector:
 - connect the camcorder's AUDIO OUT and VIDEO OUT connectors to the unit's AUDIO and VIDEO input connectors on the front panel.
 - 2 If the camcorder has an S-VIDEO output connector:
 - connect the camcorder's AUDIO OUT and S-VIDEO OUT connectors to the unit's AUDIO and S-VIDEO input connectors on the front panel.
- When using a monaural camcorder, connect its AUDIO OUT connector to the AUDIO L input connector on your unit.

2 Set the unit's input mode.

Press **PR +/-** to set the channel to "F-1".

- Set "F-1 INPUT" to "VIDEO" for the VIDEO input connector, or "S-VIDEO" for the S-VIDEO input connector, depending on the connector being used. (ⓘ pg. 85, "F-1 Input Setting (F-1 INPUT)")

3 Set the recording speed.

Press **REC MODE** repeatedly until the desired recording speed appears.

4 Prepare the camcorder for dubbing.

Start playback on the camcorder slightly before the actual point from where you wish to start dubbing.

5 Start dubbing.

Press and hold **●**, then press **▶** on the remote control, or press **●** on the unit.

6 Stop dubbing.

Press **■** on the unit, then stop playback on the camcorder.

NOTES:

- All necessary cables can be obtained from your dealer.
- Refer to the camcorder's instruction manual for operating procedure.
- The quality of dubbed picture becomes poorer than that of the original.

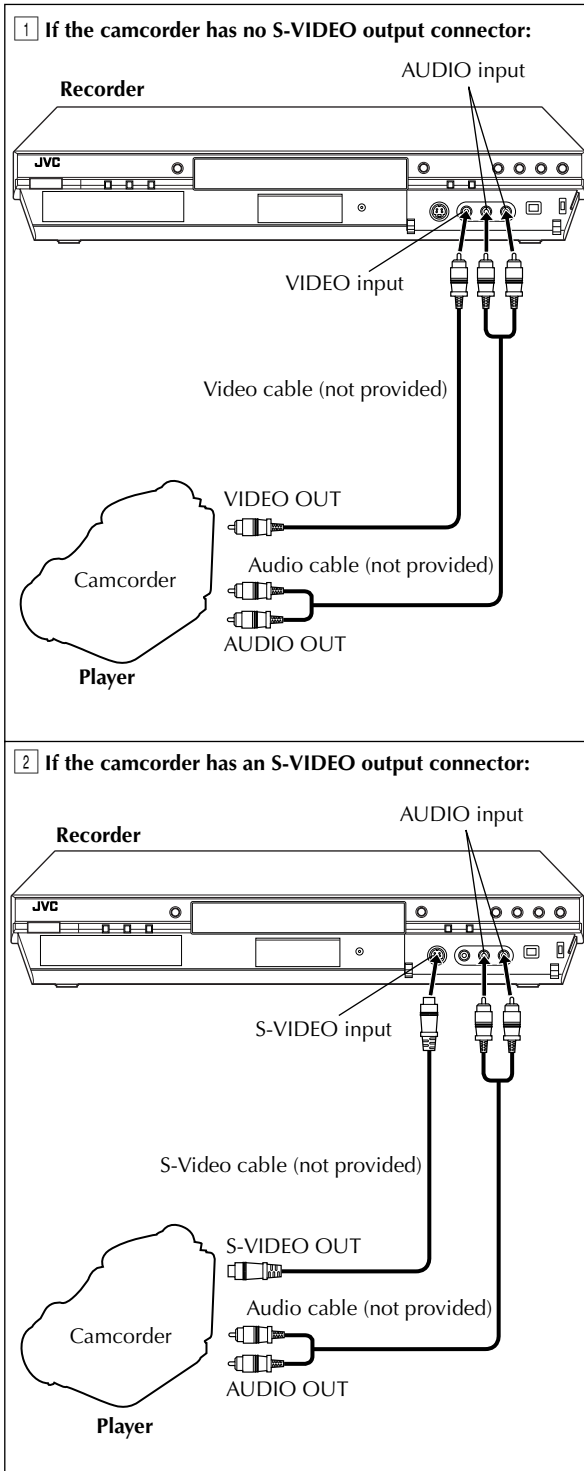

Edit To Or From Another Recorder

You can use your unit as the source player or as the recording deck.

Slide the **TV/CABLE/SAT/DVD** switch to **DVD**.

1 Make connections.

Connect the player's 21-pin SCART connector to the unit's 21-pin SCART connector as illustrated.

- 1 When using your unit as the source player:
 - connect its L-1 IN/OUT connector to the recording deck.
- 2 When using your unit as the recording deck:
 - connect its L-1 IN/OUT or L-2 IN/DECODER connector to the source player.
 - If another recorder is compatible with the Y/C signal:
 - when using your unit as the source player, set "L-1 OUTPUT" to "SCART S-VIDEO". (☞ pg. 84, "L-1 Output and L-1 Input Setting (L-1 OUTPUT and L-1 INPUT)")
 - when using your unit as the recording deck, set "L-2 SELECT" to "S-VIDEO". (☞ pg. 85, "L-2 Select Setting (L-2 SELECT)")

2 Set the input mode of recording deck.

With this unit, press **PR +/-** to select "L-1" for the L-1 IN/OUT connector, or "L-2" for the L-2 IN/DECODER connector, depending on the connector being used.

- When using another recorder as the recording deck, refer to its instruction manual.
- When using the L-2 IN/DECODER connector, set "L-2 SELECT" to "VIDEO" or "S-VIDEO". (☞ pg. 85, "L-2 Select Setting (L-2 SELECT)")

3 Set the recording speed.

Press **REC MODE** repeatedly until the desired recording speed appears.

4 Start the source player.

Engage the Play mode of the source player.

5 Start the recording deck.

Engage the Record mode of the recording deck.

6 Stop dubbing.

Stop recording on the recording deck, then stop playback on the source player.

NOTES:

- All necessary cables can be obtained from your dealer.
- For Y/C signal input/output, be sure to use a 21-pin SCART cable that is compatible with the Y/C signal.
- When you use this unit as the source player for editing, be sure to set "SUPERIMPOSE" to "OFF" before starting. (☞ pg. 95)
- If you are using another recorder with S-Video and Audio output connectors, connect its S-Video and Audio output connectors to this unit's S-VIDEO and AUDIO input connectors on the front panel. Then, set the unit's input mode to "F-1" in step 2, and set "F-1 INPUT" to "S-VIDEO". (☞ pg. 85, "F-1 Input Setting (F-1 INPUT)")

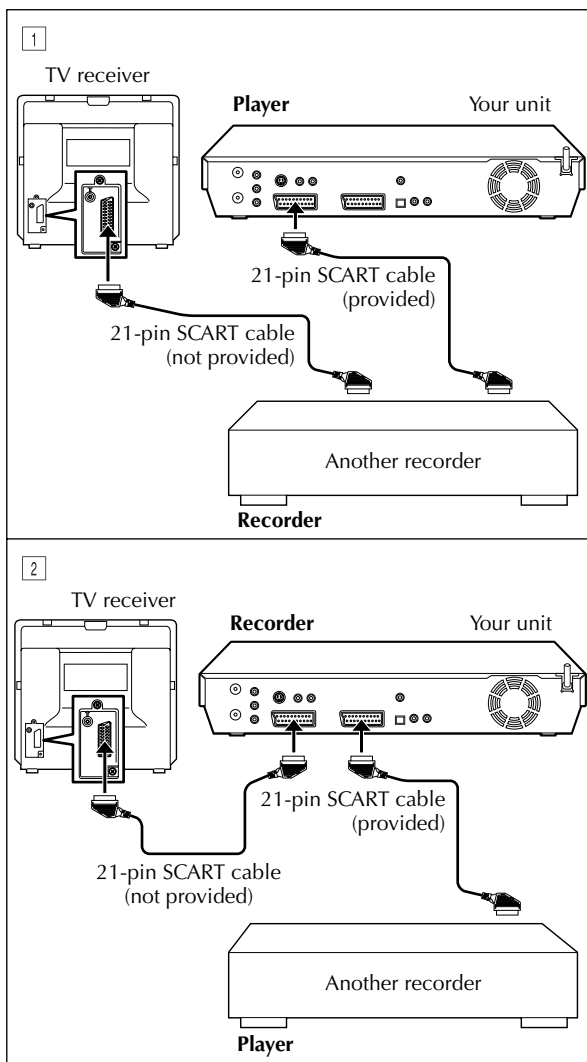

Output/Input Set

- Turn on the TV and select the AV mode.
- Slide the TV/CABLE/SAT/DVD switch to DVD.

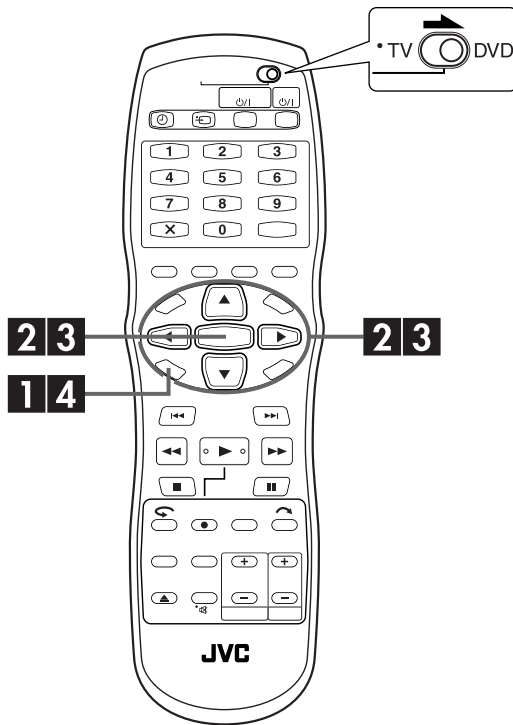

L-1 Output and L-1 Input Setting (L-1 OUTPUT and L-1 INPUT)

The L-1 IN/OUT connector accepts and delivers either a composite signal (regular video signal) or a Y/C signal (a signal in which the luminance and chrominance signals are separated). Set "L-1 OUTPUT" and "L-1 INPUT" to the appropriate mode depending on the type of appliance connected to the unit's L-1 IN/OUT connector.

1 Access the Main Menu screen.

Press **SET UP**.

2 Access the Output/Input Set screen.

- 1 Press \triangleleft \triangleright to move the arrow to "FUNCTION SET UP", then press **ENTER**.
- 2 Press \triangleleft \triangleright to move the arrow to "VIDEO IN/OUT", then press **ENTER**.

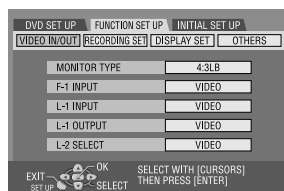

3 Select the output or input mode for the L-1 IN/OUT connector.

- 1 Press \triangle ∇ to move the arrow to "L-1 OUTPUT" or "L-1 INPUT", then press **ENTER**.
- 2 Press \triangle ∇ to select the appropriate setting, then press **ENTER**.

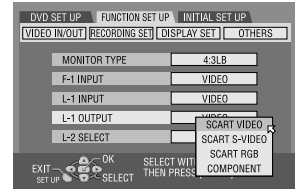

(The **boldface** settings in the table below indicate the settings at your purchase.)

■ L-1 OUTPUT

SCART VIDEO: If a connected appliance's input is compatible only with regular video signals, set to "SCART VIDEO".

SCART S-VIDEO: If a connected appliance's input is compatible with Y/C signals, set to "SCART S-VIDEO". You can obtain high-quality picture. (For connection, be sure to use a 21-pin SCART cable that is compatible with the Y/C signal.)

SCART RGB: If a connected appliance's input is compatible with RGB signals, set to "SCART RGB". You can obtain a high-quality RGB picture.

COMPONENT: If a connected appliance's input is compatible with Y/P_B/P_R signals, set to "COMPONENT". You can obtain a high-quality Y/P_B/P_R picture.

■ L-1 INPUT

VIDEO: If a connected appliance's output is compatible only with regular video signals, set to "VIDEO".

S-VIDEO: If a connected appliance's output is compatible with Y/C signals, set to "S-VIDEO". You can obtain a high-quality picture. (For connection, be sure to use a 21-pin SCART cable that is compatible with the Y/C signal.)

4 Return to the normal screen.

Press **SET UP**.

NOTES:

- If "L-1 OUTPUT" is set to "SCART S-VIDEO", "SCART RGB" or "COMPONENT", it is not possible to set "L-1 INPUT" to "S-VIDEO".
- If "L-2 SELECT" is set to "DECODER", it is not possible to set "L-1 INPUT" to "S-VIDEO".
- If "L-2 SELECT" is set to "DECODER", it is only possible to set "L-1 OUTPUT" to "SCART VIDEO".
- Component video signals are not output from the L-1 IN/OUT connector.
- When Progressive scan mode is engaged, it is not possible to select the setting of "L-1 OUTPUT". (ⓘ pg. 108)

L-2 Select Setting (L-2 SELECT)

Set "L-2 SELECT" to the appropriate mode depending on the type of appliance connected to the unit's L-2 IN/DECODER connector.

Perform steps **1** and **2** of "L-1 Output and L-1 Input Setting (L-1 OUTPUT and L-1 INPUT)" on page 84.

1 Select the input mode for the L-2 IN/DECODER connector.

- Press Δ/∇ to move the arrow to "L-2 SELECT", then press **ENTER**.
- Press Δ/∇ to select the appropriate setting, then press **ENTER**.

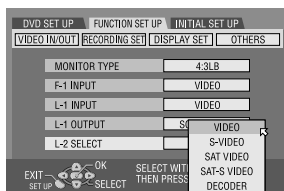

(The **boldface** settings in the table below indicate the settings at your purchase.)

■ L-2 SELECT

Select "VIDEO" or "S-VIDEO" to use this unit as the recording deck with the player connected to the L-2 IN/DECODER connector, or to use the satellite receiver connected to the L-2 IN/DECODER connector.

VIDEO: If a connected appliance's output is compatible only with regular video signals, set to "VIDEO".

S-VIDEO: If a connected appliance's output is compatible with Y/C signals, set to "S-VIDEO". You can obtain high-quality picture. (For connection, be sure to use a 21-pin SCART cable that is compatible with the Y/C signal.)

Select "SAT VIDEO" or "SAT S-VIDEO" to view a satellite programme with the TV set while the unit is turned off. (pg. 90)

SAT VIDEO: If a connected satellite receiver's output is compatible only with regular video signals, set to "SAT VIDEO".

SAT S-VIDEO: If a connected satellite receiver's output is compatible with Y/C signals, set to "SAT S-VIDEO". You can obtain a high-quality S-VHS picture. (For connection, be sure to use a 21-pin SCART cable that is compatible with the Y/C signal.)

DECODER: To use a decoder connected to the L-2 IN/DECODER connector.

2 Return to the normal screen.

Press **SET UP**.

NOTES:

- If you have a satellite receiver or a decoder connected to the L-2 IN/DECODER connector, be sure to set "L-2 SELECT" back to appropriate mode after editing.
- If you are not connecting a satellite receiver or a decoder to the L-2 IN/DECODER connector, leave "L-2 SELECT" set to "VIDEO".
- When "L-2 SELECT" is set to "SAT VIDEO" and "SAT S-VIDEO", "SAT" appears on the TV screen or front display panel instead of "L-2".
- If "L-1 OUTPUT" is set to "SCART S-VIDEO", it is not possible to set "L-2 SELECT" to "DECODER" or "SAT VIDEO".
- If "L-1 INPUT" is set to "SCART RGB", it is not possible to set "L-2 SELECT" to "DECODER" or "SAT S-VIDEO".
- If "L-1 OUTPUT" is set to "COMPONENT" and "L-2 SELECT" to "SAT VIDEO", "SAT S-VIDEO" or "DECODER", be sure to connect the L-1 IN/OUT connector with a TV.

F-1 Input Setting (F-1 INPUT)

Set "F-1 INPUT" to the appropriate mode depending on the connector (VIDEO or S-VIDEO) being used on the front panel.

Perform steps **1** and **2** of "L-1 Output and L-1 Input Setting (L-1 OUTPUT and L-1 INPUT)" on page 84.

1 Select the input mode for the VIDEO/S-VIDEO connector.

- Press Δ/∇ to move the arrow to "F-1 INPUT", then press **ENTER**.
- Press Δ/∇ to select the appropriate setting, then press **ENTER**.

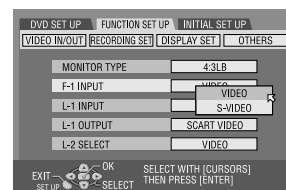

(The **boldface** settings in the table below indicate the settings at your purchase.)

■ F-1 INPUT

VIDEO: When connecting an appliance to the VIDEO input connector, set to "VIDEO".

S-VIDEO: When connecting an appliance to the S-VIDEO input connector, set to "S-VIDEO".

2 Return to the normal screen.

Press **SET UP**.

Digital Audio Dubbing

- Turn on the TV and select the AV mode.
- Slide the TV/CABLE/SAT/DVD switch to DVD.

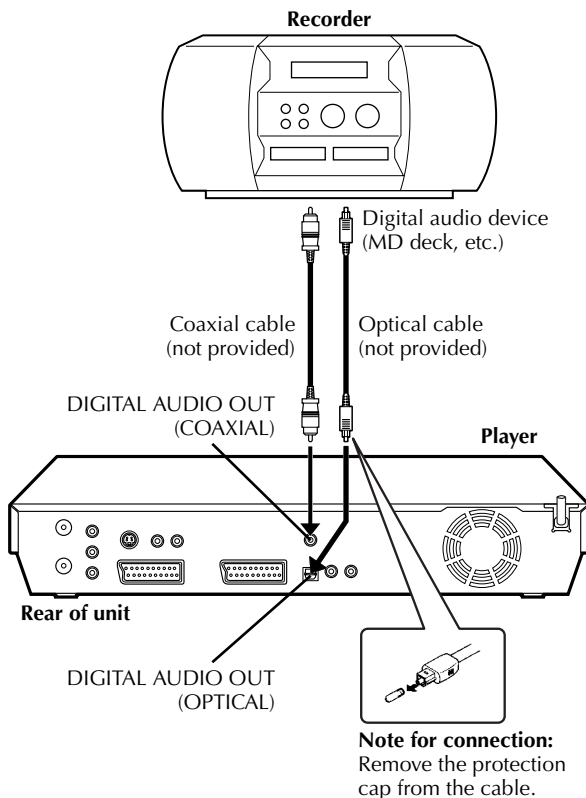

You can dub selected audio from a DVD or Audio CD disc to a digital audio device.

However, it is not possible to dub copy-protected discs.

Example: Dubbing to an MD

1 Make connections.

Connect the unit and a digital audio device using either an optional optical cable or an optional coaxial cable.

2 Place a disc and load an MD.

For the unit

- 1 Press **▲** to open the disc tray.
- 2 Place a disc on the disc tray.
- 3 Press **▲** to close the disc tray.

For the digital audio device

Load an MD.

3 Prepare the unit for dubbing.

- 1 Select the audio to be dubbed.
- 2 Start playback slightly before the actual point from where you wish to start dubbing.
- 3 Press **II** to pause playback.

4 Prepare the digital audio device for dubbing.

Select the input mode.

5 Start dubbing.

- 1 Press **▶** to start playback on the unit.
- 2 Start recording on the digital audio device.

6 Stop dubbing.

Stop recording on the digital audio device. Then press **■** to stop playback on the unit.

NOTE:

There may be a discrepancy of several seconds between where you intend editing to start, and where it actually starts.

Remote Control Functions

Remote 1/2/3/4 Code Switching

The remote control is capable of controlling four JVC video units independently. Each of the units can respond to one of four codes (1, 2, 3 or 4). The remote control is preset to send 1 code signals because your unit is initially set to respond to 1 code signals. You can easily modify your unit to respond to 2, 3 or 4 code signals.

Slide the TV/CABLE/SAT/DVD switch to DVD.

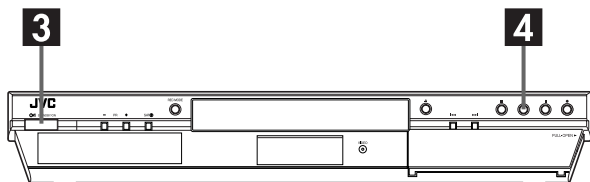
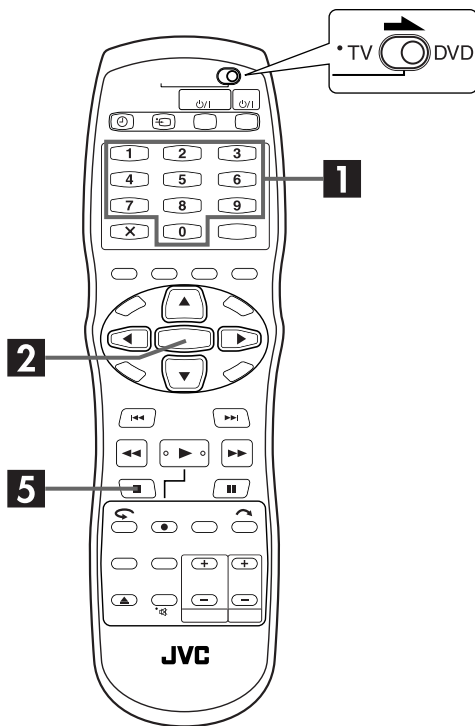

On the remote control

Keep pressing SET UP down during steps 1 - 2.

1 Change the remote control code.

Press the number key "1" for 1, "2" for 2, "3" for 3 or "4" for 4.

2 Set the remote control code.

Press ENTER to set the code.

On the unit

3 Turn off the unit.

Press \odot /I on the unit.

4 Display the code.

Press \blacktriangleright on the unit for over 5 seconds while the unit is turned off.

- The code currently set appears on the front display panel.

5 Change the unit's code.

Press \blacksquare on the remote control.

- The code currently set on the remote control blinks on the front display panel for approximately 5 seconds, and is applied to the unit.

NOTE:

When "POWER SAVE" is set to "ON" (pg. 95), it is not possible to change the remote code.

TV Multi-Brand Remote Control

Your remote control can operate the basic functions of your TV set. In addition to JVC TVs, other manufacturer's TVs can also be controlled.

Before performing the following steps:

- Turn off the TV using its remote control.
- Slide the **TV/CABLE/SAT/DVD** switch to **TV**.

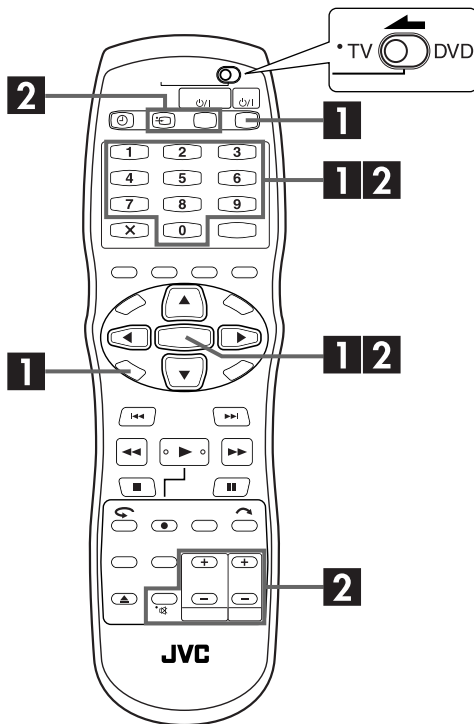

1 Set the TV brand code.

Keep pressing **SET UP** down during step **1**.

Enter your TV's brand code using the **number keys**, then press **ENTER**.

Press **TV/CBL/SAT** $\psi/1$ on the unit's remote control to turn on the TV and try operations (see step **2**).

- Once you have set the remote control to operate the TV, you do not have to repeat this step until you replace your remote control's batteries.
- Some brands of TVs have more than one code. If the TV does not function with one code, try entering another.

2 Operate the TV.

Press the corresponding button: **TV/CBL/SAT** $\psi/1$, $\psi/2$ (VIDEO), **TV/CBL DVD PR +/-**, **TV** $\triangle/+/ -$ (Volume), \boxtimes (TV Muting), **number keys**.

- For some brands of TVs, you must press **ENTER** after having pressed the **number keys**.

BRAND NAME	CODE
JVC	01, 03
HITACHI	10
MAGNAVOX	02
MITSUBISHI	03
PANASONIC	04, 11
RCA	05
SHARP	06
SONY	07
SAMSUNG	12
SANYO	13
SEARS	13
TOSHIBA	08
ZENITH	09

IMPORTANT:

Although the provided remote control unit is compatible with JVC televisions, as well as many other models, it may not work with your TV, or in some instances, may have limited function capability.

Satellite Receiver Multi-Brand Remote Control

Your remote control can operate the basic functions of your satellite receiver set. In addition to JVC satellite receivers, other manufacturer's satellite receivers can also be controlled.

Slide the TV/CABLE/SAT/DVD switch to CABLE/SAT.

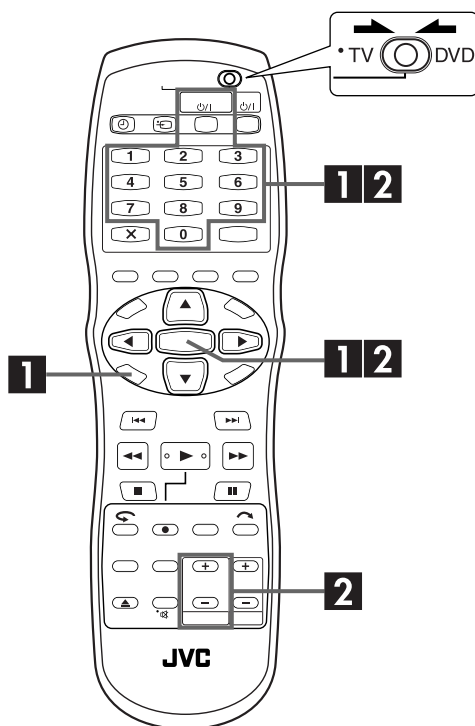

IMPORTANT:

Although the provided remote control unit is compatible with JVC satellite receivers, as well as many other models, it may not work with your satellite receiver, or in some instances, may have limited function capability.

1 Set the satellite receiver brand code.

Keep pressing **SET UP** down during step **1**. Enter your satellite receiver's brand code using the **number keys**, then press **ENTER**.

Press **TV/CBL/SAT** $\psi/1$ on the unit's remote control to turn on the satellite receiver and try operations (step **2**).

- Once you have set the remote control to operate the satellite receiver, you do not have to repeat this step until you replace your remote control's batteries.
- Some brands of satellite receiver have more than one code. If the satellite receiver does not function with one code, try entering another.

2 Operate the satellite receiver.

Press the corresponding button: **TV/CBL/SAT** $\psi/1$, **TV/CBL DVD PR +/-**, **number keys**.

- For some brands of satellite receiver, you must press **ENTER** after having pressed the **number keys**.
- The **number keys** may not function with some satellite receivers.

BRAND NAME	CODE
JVC	73
AMSTRAD	60, 61, 62, 63, 92
CANAL SATELLITE	81
CANAL +	81
D-BOX	85
ECHOSTAR (VIA DIGITAL)	82
FINLUX	68
FORCE	89
GALAXIS	88
GRUNDIG	64, 65, 102
HIRSCHMANN	64, 78, 99
HUMAX	88
ITT NOKIA	68
KATHREIN	70, 71, 96
LUXOR	68
MASCOM	93
MASPRO	70
NOKIA	87, 94
PACE	65, 67, 74, 86, 92
PANASONIC	74, 92
PHILIPS	66, 84, 101
RADIX	78
RFT	69
SABA	97
SAGEM	83, 90
SALORA	68
SAMSUNG	83
SIEMENS	64
SKYMASTER	69, 98
TECHNISAT	66, 100
THOMSON	97
TPS	83
TRIAx	91
WISI	64

Connecting To A Satellite Receiver

Connect the satellite receiver to the L-2 IN/DECODER connector, then connect the L-1 IN/OUT connector to the TV's connector.

NOTES:

- Set "L-2 SELECT" to "VIDEO" or "S-VIDEO". (☞ pg. 85)
- You can use the Automatic Satellite Programme Recording function (☞ pg. 65) with this connection.
- To record a programme via the satellite receiver, select L-2 mode by pressing **PR +/-** so that "L-2" appears on the front display panel.
- For details, refer to the instruction manual of the satellite receiver.

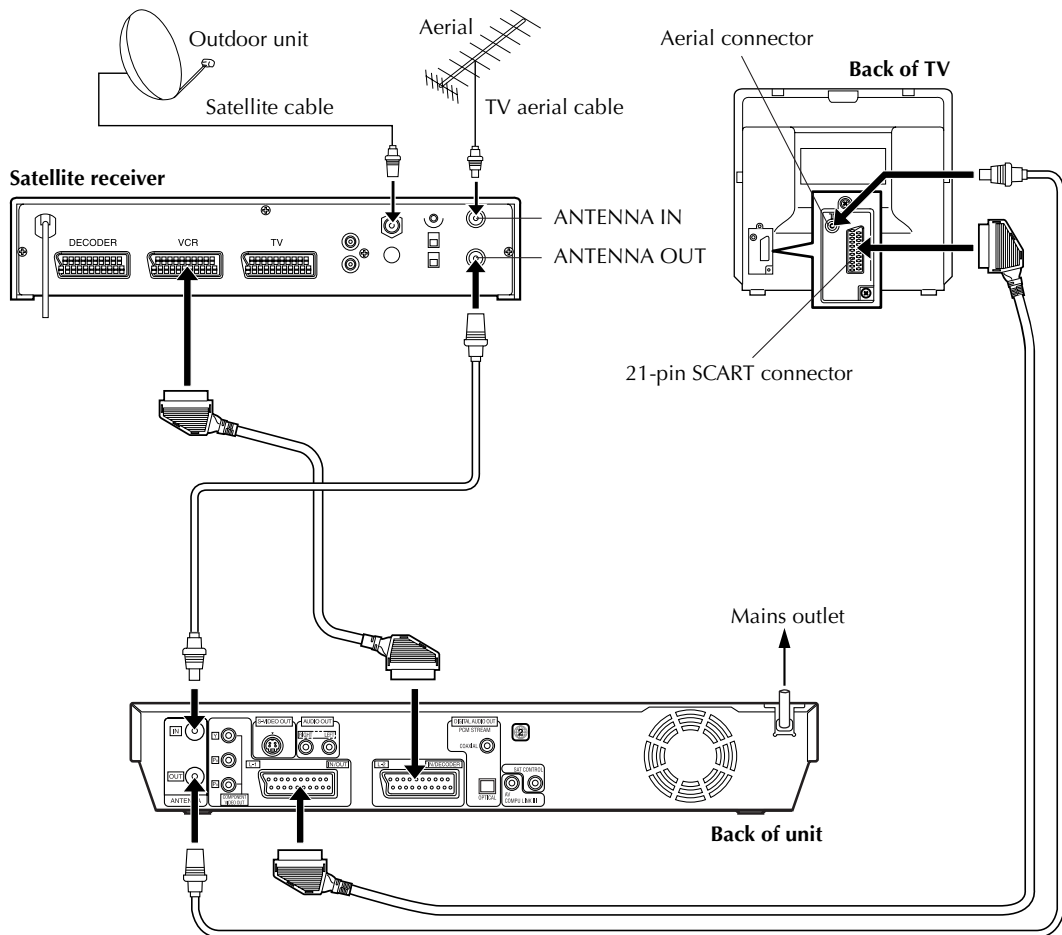

IMPORTANT:

When you set "L-2 SELECT" to "SAT VIDEO" or "SAT S-VIDEO" (☞ pg. 85, "L-2 Select Setting (L-2 SELECT)"), it is possible to view a satellite broadcast with the TV set to its AV mode even if the unit is turned off. When the unit is in Stop mode or recording, press  on the remote control to turn off the VIDEO indicator on the unit.

- If you turn on the unit when the satellite receiver's power is off, nothing appears on the TV screen. In this case, turn on the satellite receiver, or set the TV to its TV mode, or press  on the remote control to set the unit to the AV mode.

Connecting To A Dolby Digital Decoder or An Amplifier With Built-in DTS

These instructions enable you to connect your unit to a Dolby Digital decoder or an amplifier with built-in DTS.

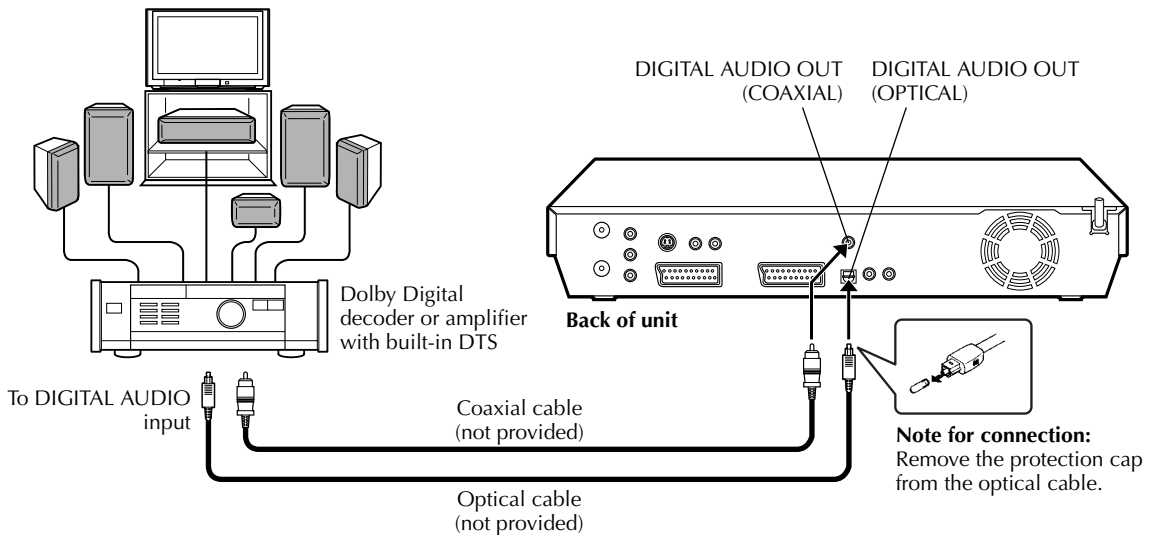

Make connections.

Connect the unit and a Dolby Digital decoder or an amplifier with built-in DTS using either an optional optical cable or an optional coaxial cable.

NOTES:

- For Dolby Digital sound, set "DIGITAL AUDIO OUT" to "DOLBY DIGITAL/PCM". (☞ pg. 93)
- For DTS sound, set "DIGITAL AUDIO OUT" to "STREAM/PCM". (☞ pg. 93)

CAUTIONS:

- This unit has a dynamic range of more than 110 dB with regards to its Hi-Fi audio capability. It is recommended that you check the maximum level if you are going to listen to the Hi-Fi audio signals through a stereo amplifier. A sudden surge in the input level to the speakers may damage them.
- Some speakers and televisions are specially shielded to prevent television interference. If both are of the non-shielded type, do not place the speakers adjacent to the TV set as this can adversely affect the playback picture.

When you can't switch the audio channel of a bilingual programme

When the unit is connected with a digital audio device using an optional optical cable and "DIGITAL AUDIO OUT" is set to "DOLBY DIGITAL/PCM", it is not possible to switch the audio channel of a bilingual programme recorded on a DVD-RAM or DVD-RW (VR mode) disc. In this case, perform the following steps using the remote control to switch "DIGITAL AUDIO OUT" from "DOLBY DIGITAL/PCM" to "PCM ONLY".

- 1 Press **SET UP** to access the Main Menu screen.
- 2 Press $\triangleleft \triangleright$ to select "DVD SET UP", then press **ENTER**.
- 3 Press $\triangleleft \triangleright$ to select "AUDIO OUTPUT", then press **ENTER**.
- 4 Press $\triangle \nabla$ to select "DIGITAL AUDIO OUT", then press **ENTER**.
- 5 Press $\triangle \nabla$ to select "PCM ONLY", then press **ENTER**. (☞ pg. 93)
- 6 Press **SET UP** to complete the setting.
- 7 Press **AUDIO** to select the desired audio channel. (☞ pg. 36, "Audio Channel Selection")

Mode Set

- Turn on the unit.
- Turn on the TV and select the AV mode.
- Slide the TV/CABLE/SAT/DVD switch to DVD.

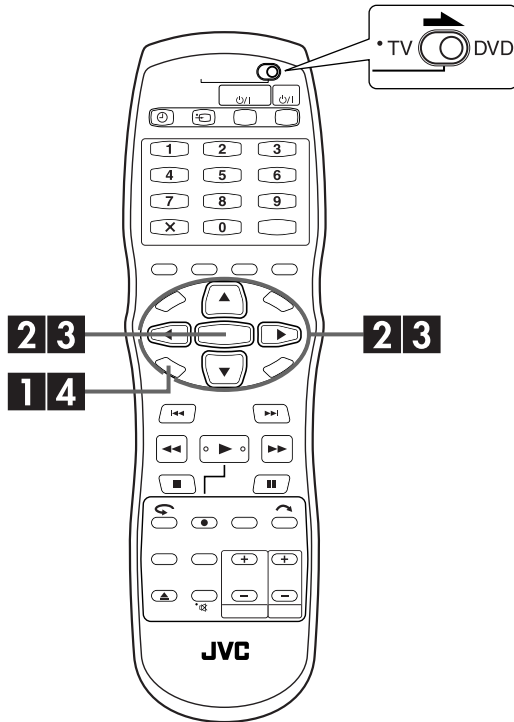

Various modes of this unit are categorized into menus nested in 2 levels shown in the following table. To change the settings of these modes, find the desired mode in the menu (for details on each menu, see pages 93 through 96), then follow the procedure below.

DVD SET UP	LANGUAGE SET (☞ pg. 26) AUDIO OUTPUT (☞ pg. 93) UTILITY (☞ pg. 49, 106, 107)
FUNCTION SET UP	VIDEO IN/OUT (☞ pg. 25, 84) RECORDING SET (☞ pg. 94) DISPLAY SET (☞ pg. 95) OTHERS (☞ pg. 96)
INITIAL SET UP	AUTO CH SET (☞ pg. 98) MANUAL CH SET (☞ pg. 99) SAT/GUIDE PR (☞ pg. 29, 97) CLOCK SET (☞ pg. 104)

- The procedure below shows how to set the desired option of the "AUDIO REC" mode as an example.

1 Access the Main Menu screen.

Press **SET UP**.

2 Access the "RECORDING SET" screen.

- 1 Press $\triangleleft \triangleright$ to select "FUNCTION SET UP", then press **ENTER**.
- 2 Press $\triangleleft \triangleright$ to select "RECORDING SET", then press **ENTER**.

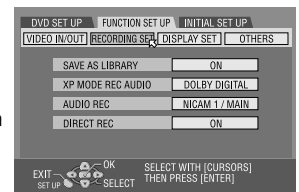

3 Select the desired option.

- 1 Press $\triangle \nabla$ to select "AUDIO REC", then press **ENTER**.
- 2 Press $\triangle \nabla$ to select the desired option, then press **ENTER**.

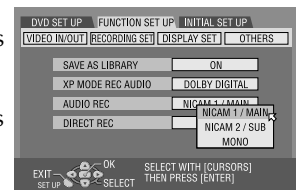

4 Complete the setting.

Press **SET UP**.

AUDIO OUTPUT

(The **boldface** settings in the table below indicate the settings at your purchase.)

<p>■ DIGITAL AUDIO OUT DOLBY DIGITAL/PCM STREAM/PCM PCM ONLY</p>	<p>Set to the appropriate mode according to the type of the device connected to DIGITAL AUDIO OUT connector.</p> <p>DOLBY DIGITAL/PCM: Select this when you connect the digital input connector of a Dolby Digital decoder or an amplifier with a built-in Dolby Digital decoder.</p> <p>STREAM/PCM: Select this when you connect the digital input connector of an amplifier with a built-in DTS, Dolby Digital, or MPEG multichannel decoder.</p> <p>PCM ONLY: Select this when you connect the linear PCM digital input of other audio equipment (amplifier, MD or DAT deck, etc.).</p>
<p>■ ANALOG AUDIO OUT STEREO DOLBY SURROUND</p>	<p>Select the appropriate setting to accommodate the unit to the connected A/V equipment. This function takes effect when a DVD VIDEO disc is played back.</p> <p>STEREO: Select this when listening to conventional two-channel stereo audio with the unit's AUDIO OUT connectors connected to a stereo amplifier/receiver or TV set, or in case you want to record the audio from a DVD VIDEO disc to a Mini Disc, etc.</p> <p>DOLBY SURROUND: Select this when listening to multichannel surround audio with the unit's AUDIO OUT connectors connected to an amplifier/receiver with a built-in surround decoder or a surround decoder.</p>
<p>■ D. RANGE CONTROL NORMAL WIDE RANGE TV MODE</p>	<p>The dynamic range (the difference between the loudest sound and the quietest one) can be compressed during playback of a programme encoded in Dolby Digital format. This function takes effect when a DVD VIDEO disc recorded in Dolby Digital format is played back at low or middle volume.</p> <p>NORMAL: Normally select this setting to activate this function.</p> <p>WIDE RANGE: Select this to deactivate this function when you enjoy wide dynamic range programme.</p> <p>TV MODE: Select this when you hear the sound through the TV's speaker(s).</p> <p>NOTES:</p> <ul style="list-style-type: none"> • This function takes no effect on programmes other than that recorded in Dolby Digital format. • This function dose not work when Simulated Surround Effect is activated. (☞ pg. 47) • The effect of "NORMAL" and "WIDE RANGE" may not be different depending on discs.
<p>■ OUTPUT LEVEL STANDARD LOW</p>	<p>You can lower the output level of analog audio to accommodate the unit to the connected A/V equipment.</p> <p>STANDARD: Normally select this setting.</p> <p>LOW: The output level of analog audio is lowered.</p>

RECORDING SET

(The **boldface** settings in the table below indicate the settings at your purchase.)

<p>■ SAVE AS LIBRARY OFF ON</p>	<p>When this function is set to "ON", the recording information is automatically stored in the library. For details, refer to "Modify Library Information" (☞ pg. 76).</p>
<p>■ XP MODE REC AUDIO DOLBY DIGITAL LINEAR PCM</p>	<p>You can select the audio format when you record a programme in XP mode. When this function is set to "LINEAR PCM", you can obtain a high-quality audio sound.</p> <p>DOLBY DIGITAL: To record in Dolby Digital format.</p> <p>LINEAR PCM: To record in Linear PCM format.</p>
<p>■ AUDIO REC NICAM 1/MAIN NICAM 2/SUB MONO</p>	<p>You can select the desired NICAM audio channel to be recorded on a DVD-R/RW (Video mode) disc.</p> <p>NICAM 1/MAIN: To record the main language of NICAM audio.</p> <p>NICAM 2/SUB: To record the sub language of NICAM audio.</p> <p>MONO: To record the standard (monaural) sound of NICAM audio.</p> <p>NOTE: This function works only for the NICAM bilingual programme.</p>
<p>■ DIRECT REC OFF ON</p>	<p>When this function is set to "ON", you can easily start recording the programme that you are watching on your TV. Press and hold ● and press ► on the remote control, or press ● on the unit.</p> <p>NOTES:</p> <ul style="list-style-type: none"> ● When you use the Direct Rec function, be sure to use a TV offering T-V LINK, etc. and connect a fully-wired 21-pin SCART cable between the unit and the TV. (☞ pg. 18) ● If "DIRECT REC" is set to "OFF", the ● button functions as described in "Basic Recording" (☞ pg. 53). ● During Direct Rec, "—" appears on the front display panel. ● If a programme is recorded with the Direct Rec, the station name will not be registered in the library. "—" will be displayed for the station name. ● Even if there is no power supply for more than 60 minutes, the unit keeps the setting.

DISPLAY SET

(The **boldface** settings in the table below indicate the settings at your purchase.)

<p>■ SUPERIMPOSE OFF AUTO ON</p>	<p>You can select the modes of indications superimposed on the TV screen.</p> <p>OFF: To turn off superimposed indications.</p> <p>AUTO: To superimpose operational indications for approximately five seconds just after the corresponding operation.</p> <p>ON: To superimpose operational indications all the time.</p> <p>NOTES:</p> <ul style="list-style-type: none"> • When you use this unit as the source player for editing, be sure to set "SUPERIMPOSE" to "OFF" before starting. (☞ pg. 83, "Edit To Or From Another Recorder") • When you select "AUTO", during playback, the operation mode indicators may be disturbed depending on the type of disc being used.
<p>■ GREY BACK OFF ON</p>	<p>When this function is set to "ON", the TV screen becomes all grey when receiving a channel not in use.</p> <p>NOTE: When you want to receive an unstable channel with poor signals, set this function to "OFF".</p>
<p>■ DIMMER BRIGHT DARK</p>	<p>You can change the brightness of the front display panel.</p> <p>BRIGHT: Normally select this.</p> <p>DARK: To dim the front display panel. (Blue lamp on the front display panel is turned off.)</p>
<p>■ POWER SAVE OFF ON</p>	<p>When this function is set to "ON", you can reduce the power consumption while the unit is turned off.</p> <p>NOTES:</p> <ul style="list-style-type: none"> • During Power Save mode — — the front display panel will be turned off. — the Just Clock function (☞ pg. 104) does not work. • Power Save does not work when — — the unit is in the Timer mode. — the unit's power is turned off after timer-recording or Instant Timer Recording. — the Automatic Satellite Programme Recording mode is engaged. (☞ pg. 65) — "L-2 SELECT" is set to "DECODER", "SAT VIDEO" or "SAT S-VIDEO". (☞ pg. 85) • It takes some time for the unit to complete initialisation after you turn on unit power, with "WAKE UP" blinking on the front display panel.

OTHERS

(The **boldface** settings in the table below indicate the settings at your purchase.)

<p>■ AUTO TIMER OFF ON</p>	<p>When this function is set to "ON", the timer is automatically engaged when the unit power is turned off, and automatically disengaged when the unit is powered back on.</p> <p>NOTE: For safety, when "AUTO TIMER" is set to "OFF", all other functions are disabled while the Timer mode is engaged. To disengage the timer, press ⊖ (TIMER).</p>
--	---

VIDEO Plus+® System Setup

IMPORTANT:

Normally, Auto Set Up (ⓘ pg. 21), Preset Download (ⓘ pg. 23) or Auto Channel Set (ⓘ pg. 98) sets the Guide Program numbers automatically. You need to set the Guide Program numbers manually only in the following cases.

- When timer-programming with the VIDEO Plus+ system, the channel position, where the station you wish to record is received on your unit, is not selected,
OR
when you add a channel after Auto Set Up, Preset Download or Auto Channel Set has taken place,
—Set the Guide Program number for that station manually.
- When you wish to timer-record a satellite programme with the VIDEO Plus+ system,
—Set the Guide Program numbers for all satellite broadcasts received on your satellite receiver.

- Turn on the unit.
- Turn on the TV and select the AV mode.
- Slide the TV/CABLE/SAT/DVD switch to DVD.

Guide Program Number Set

1 Access the Main Menu screen.

Press **SET UP**.

2 Access the "SAT/GUIDE PR" screen.

- 1 Press $\triangleleft \triangleright$ to select "INITIAL SET UP", then press **ENTER**.
- 2 Press $\triangleleft \triangleright$ to select "SAT/GUIDE PR", then press **ENTER**.

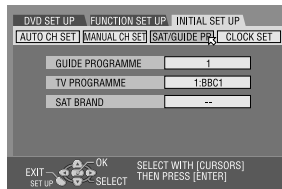

3 Enter the Guide Program number.

- 1 Press $\triangle \nabla$ to select "GUIDE PROGRAMME", then press **ENTER**.
 - 2 Press $\triangle \nabla$ to select the Guide Program number for the desired station as shown in the TV listings. Then press **ENTER**.
- To change the Guide Program number in 10 increments, press and hold $\triangle \nabla$.

4 Enter the receiving channel position number.

- 1 Press $\triangle \nabla$ to select "TV PROGRAMME", then press **ENTER**.
 - 2 Press $\triangle \nabla$ to select the number of the unit's channel position on which the Guide Program number's broadcast is received by the unit or the satellite receiver. Then press **ENTER**.
- Pressing **AUX** changes "TV PROGRAMME" to "SAT".
 - To timer-record a satellite programme with the VIDEO Plus+ system, you need to install a provided Satellite Controller and perform the procedure described in "Satellite Receiver Control Setting" (ⓘ pg. 28).
 - Repeat steps **3** and **4** as necessary.

5 Complete the setting.

Press **SET UP**.

Guide Program Number

"Guide Program (GUIDE PROGRAMME) number" refers to the assigned TV station numbers, according to broadcast area, for the VIDEO Plus+ timer recording. The Guide Program numbers can be found in most TV listings.

Tuner Set

- Turn on the unit.
- Turn on the TV and select the AV mode.
- Slide the TV/CABLE/SAT/DVD switch to DVD.

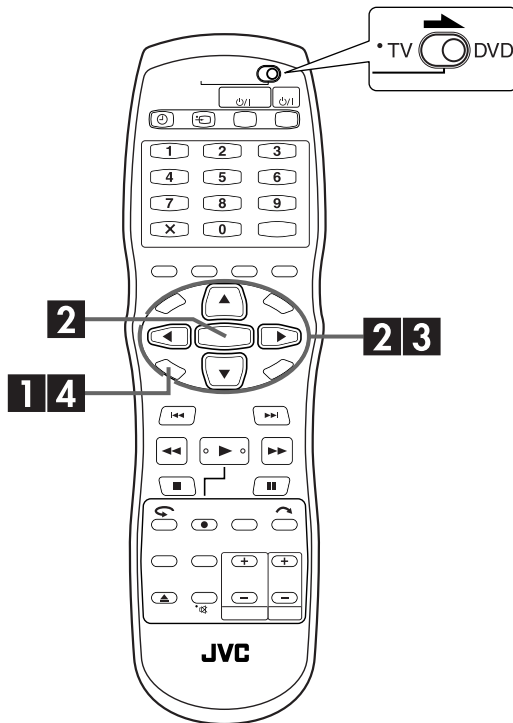

IMPORTANT:

Perform the following steps only if —
 — Auto Channel Set has not been set correctly by Auto Set Up or by Preset Download. (pg. 21, 23)
 — you have moved to a different area or if a new station starts broadcasting in your area.

Your unit needs to memorise all necessary stations in channel positions in order to record TV programmes. Auto Channel Set automatically assigns all receivable stations in your area to call them up by using the **PR +/-** buttons without going through any vacant channels.

Auto Channel Set

1 Access the Main Menu screen.

Press **SET UP**.

2 Perform Auto Channel Set.

- 1 Press **<>** to select "INITIAL SET UP", then press **ENTER**.
- 2 Press **<>** to select "AUTO CH SET", then press **ENTER**.

- When you have connected the unit to a TV offering T-V Link via a fully-wired 21-pin SCART cable (pg. 18), the unit automatically performs the Preset Download and the T-V LINK screen will appear. (pg. 23)

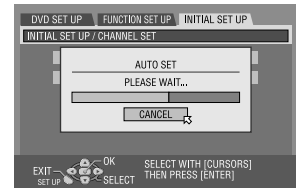

- The Auto Set screen appears, and remains on screen while the unit searches for receivable stations. Wait until the TV screen as shown in step 3 appears.

3 View the Confirmation screen.

"SCAN COMPLETED" is displayed on the TV screen. Press "OK", then the Confirmation screen appears. The confirmation screen lists the channel position number (PR), station channel number (CH), and station name (ID)

(pg. 102, "TV Station And ID List") of all stored broadcast stations. The programme currently received on the selected channel position appears behind the confirmation screen. To view the next page, press **<>**.

PR	CH	ID	PR	CH	ID
01	25	ARD	08	C26	E-SP
02	C08	SKY1	09	S8	WEST
03	10	ZDF	10	C24	SAT1
04	D65	DAH	11	C23	OSF
05	C31	BBC1	12	C25	ESPN
06	C32	BBC2	13	C37	OMN
07	C33	3SAT	14	C35	

- The Guide Program numbers will also be set automatically during Auto Channel Set.

4 Complete the setting.

Press **SET UP**.

- Using the Confirmation screen, you can skip or add channel positions, enter station names and perform other operations. Refer to pages 99 – 101 for the procedures.
- Depending on reception conditions, the stations may not be stored in order, and the station names may not be stored correctly.

IMPORTANT:

- In certain reception conditions, station names may not be stored correctly, and Auto Guide Program Number Set may not work properly. When the Guide Programme numbers are not set properly, the programme that you do not intend to record will be timer-recorded by the VIDEO Plus+ system of the unit. When programming the timer using the VIDEO Plus+ system, be sure to check the desired channel is selected correctly. (☞ pg. 56, "VIDEO Plus+ Timer Programming")
- Your unit memorises all receivable stations even if reception of some of them is poor. You can delete those stations with an unacceptable picture from the list. (☞ pg. 100, "Delete A Channel")

NOTES:

- Fine tuning is performed automatically during Auto Channel Set. If you want to perform tuning manually, refer to "Fine-Tuning Channels Already Stored" (☞ pg. 101).
- If you perform Auto Channel Set when the aerial cable is not connected properly, "SCAN COMPLETED -NO SIGNAL-" appears on the TV screen in step 3. In such a case, make sure of the aerial connection and press **ENTER**; Auto Channel Set will start again.

Manual Channel Set

Store channels that were not stored during Auto Set Up (☞ pg. 21), Preset Download (☞ pg. 23) or Auto Channel Set (☞ pg. 98).

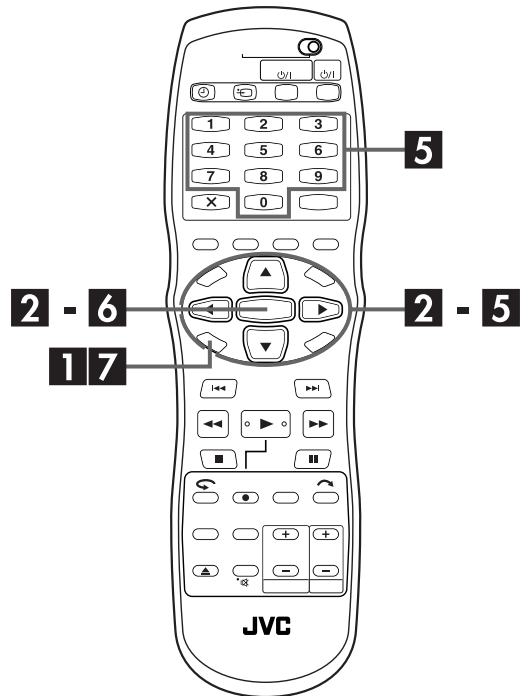
**1 Access the Main Menu screen.**

Press **SET UP**.

2 Access the Confirmation screen.

- 1 Press **◀ ▶** to select "INITIAL SET UP", then press **ENTER**.
 - 2 Press **◀ ▶** to select "MANUAL CH SET", then press **ENTER**.
- The Confirmation screen appears.

3 Select the channel position.

Press **△ ▽ ◀ ▶** to select a blank position in which you want to store a channel, then press **ENTER** twice. The Manual Channel Set screen appears.

(Example) To store in position 6.

DVD SET UP			FUNCTION SET UP			INITIAL SET UP		
INITIAL SET UP / CHANNEL SET								
PR	CH	ID	PR	CH	ID			
01	26	BBC1	08	----	----			
02	33	BBC2	09	----	----			
03	23	ITV	10	----	----			
04	30	CH4	11	----	----			
05	37	CH5	12	----	----			
06	----	----	13	----	----			
07	----	----	14	----	----			

EXIT OK SELECT WITH [CURSORS] THEN PRESS [ENTER]

The programme currently received on the selected channel position appears behind the confirmation screen.

4 Select the band.

- Press Δ / ∇ to select "BAND", then press **ENTER**.
- Press Δ / ∇ to change the band between CH (regular) and CC (cable), then press **ENTER**.

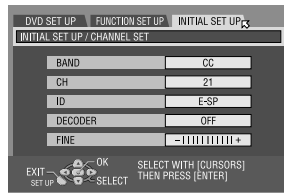

5 Enter the channel.

- Press Δ / ∇ to select "CH", then press **ENTER**.
- Press Δ / ∇ to input the channel number you want to store.
 - To enter the registered station name (☞ pg. 102, "TV Station And ID List"), press Δ / ∇ to select "ID", then press **ENTER**. Press Δ / ∇ .
 - For fine tuning adjustment, press Δ / ∇ to select "FINE", then press **ENTER**. Press Δ / ∇ to perform fine-tuning.
 - When "L-2 SELECT" is set to "VIDEO", "S-VIDEO", "SAT VIDEO" or "SAT S-VIDEO", the "DECODER" setting cannot be changed. (☞ pg. 85, "L-2 Select Setting (L-2 SELECT)")

6 Enter new channel information.

- Press **ENTER**. The Confirmation screen appears.
- Repeat steps **3** – **6** as necessary.

7 Close the Confirmation screen.

- Press **SET UP**.
- To change positions, see "Change Station Channel Position" (☞ pg. 100).
 - If you wish to set station names other than the ones registered in your unit, see "Set Stations (B)" (☞ pg. 101).

ATTENTION:

Guide Program numbers are not set when channels are stored manually. (☞ pg. 97, "VIDEO Plus+" System Setup")

Delete A Channel

Perform steps **1** and **2** of "Manual Channel Set" on page 99 to access the Confirmation screen before continuing.

1 Select the item.

Press Δ / ∇ \triangleleft / \triangleright to select the item you want to delete.

2 Delete a channel.

- Press **X**.
- The item next to the cancelled one moves up one line.
 - Repeat steps **1** and **2** as necessary.

3 Close the Confirmation screen.

Press **SET UP**.

Change Station Channel Position

Perform steps **1** and **2** of "Manual Channel Set" on page 99 to access the Confirmation screen before continuing.

1 Select the item.

Press Δ / ∇ \triangleleft / \triangleright to select the item you want to move, then press **ENTER**.

2 Select the new position.

Press Δ / ∇ \triangleleft / \triangleright to select the new channel position, then press **ENTER**.

Example: If you moved the station in position 4 to position 2, the stations originally in positions 2 and 3 each move down one space.

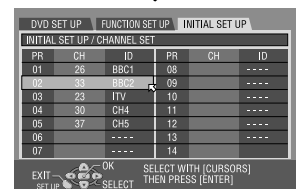
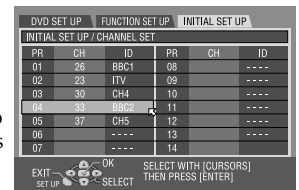

- Repeat steps **1** and **2** as necessary.

3 Close the Confirmation screen.

Press **SET UP** twice.

Set Stations (A)

Set station names that are registered in your unit.

Perform steps **1** and **2** of "Manual Channel Set" on page 99 to access the Confirmation screen before continuing.

1 Select the item.

Press $\Delta \nabla \triangleleft \triangleright$ to select the item you want.

2 Access the Manual Channel Set screen.

Press ENTER twice.

3 Select the new station.

- 1 Press $\Delta \nabla$ to select "ID", then press ENTER.
- 2 Press $\Delta \nabla$ until the new station's name (ID) you want to store appears, then press ENTER. Registered station names (pg. 102, "TV Station And ID List") appear as you press $\Delta \nabla$.

4 Switch the stations.

Press $\triangleleft \triangleright$ to select "OK", then press ENTER.
 • Repeat steps **1** – **4** as necessary.

5 Close the Confirmation screen.

Press SET UP twice.

Set Stations (B)

Set station names other than the ones registered in your unit.

Perform steps **1** and **2** of "Manual Channel Set" on page 99 to access the Confirmation screen and then perform steps **1** and **2** of "Set Stations (A)" (pg. 101) before continuing.

1 Select the character for station name.

- 1 Press $\Delta \nabla$ to select "ID", then press ENTER.
- 2 Press ENTER twice.

2 Enter the new character.

- 1 Press $\triangleleft \triangleright$ to locate the character insertion point.
- 2 Press $\Delta \nabla$ to cycle through the characters (A–Z, 0–9, –, *, +, _ (space)) and stop when the desired character is indicated, then press \triangleright to enter.
- 3 Enter the remaining characters the same way (maximum of 4).
- 4 After entering all characters, press $\triangleleft \triangleright$ to select "OK", then press ENTER.

3 Close the Confirmation screen.

Press SET UP twice.

NOTE:

The characters available for the station name (ID) are A–Z, 0–9, –, *, +, _ (space) (maximum of 4).

Fine-Tuning Channels Already Stored

Perform steps **1** and **2** of "Manual Channel Set" on page 99 to access the Confirmation screen before continuing.

1 Select the channel to fine-tune.

- 1 Press $\Delta \nabla \triangleleft \triangleright$ to select the channel you want to fine-tune, then press ENTER.
- 2 Press ENTER twice.

2 Access the Manual Channel Set screen.

Press ENTER. The Manual Channel Set screen appears.

3 Perform fine-tuning.

- 1 Press $\Delta \nabla$ to select "FINE".
- 2 Press $\triangleleft \triangleright$ until the picture appears in its best quality.
 • Repeat steps **1** – **3** as necessary.

4 Close the Confirmation screen.

Press SET UP three times.

TV Station And ID List

STATION NAME	ID*
Anglia TV	ANGL
ARD	ARD
ARTE	ARTE
BBC Group	BBC
BBC1	BBC1
BBC2	BBC2
BBCW	BBCW
Berlin 1	BLN1
Berlin 2	BLN2
Border TV	BORD
Bayern1	BR1
Bayern3	BR3
BRT1	BRT1
BRT2	BRT2
Children Ch	CHLD
Canal +	CH+
CNN	CNN
Channel TV	CHNL
Central TV	CNTR
Channel 4	CH 4
Channel 5	CH 5
DISC	DISC
DRS	DRS
DR TV	DRTV
DSF	DSF
Euronews	EURN
Euronews	EURO
Eurosports	EURS
France1	FR1
France2	FR2
France3	FR3
Granada TV	GRNA
Grampian TV	GRMP
Hessen1	HR1
Hessen3	HR3
HRT	HRT
HTV	HTV
ITV Network	ITV1
Kabelkanal	KABL
London	LNDN
MDR	MDR
MTV	MTV
Nord3	N3
NDR1	NDR1
NDR3	NDR3
NED1	NED1
NED2	NED2
NED3	NED3
Network 2	NET2
NRK	NRK
N-TV	N-TV
Offener Kanal	OKAN
ORF1	ORF1
ORF2	ORF2
ORF3	ORF3
OWL 3	OWL3
Premiere	PRMI
PR07	PR07
RAI1	RAI1
RAI2	RAI2
RAI3	RAI3
RB1	RB1
RB3	RB3
Rikisutvarpid-S	RKPS
RTBF 1	RTB1
RTBF 2	RTB2
RTE 1	RTE1
RTL	RTL
RTL 2	RTL2
RTP	RTP

STATION NAME	ID*
SAT	SAT
SAT 1	SAT1
Scottish TV	SCOT
SC4	SC4
SDR	SDR
SDR1	SDR1
SFB1	SFB1
SFB3	SFB3
SKY	SKY
Sky One	SKY1
Sky Net	SKYN
Sport	SPRT
SR 1	SR1
Super RTL	SRTL
STV Test	STVT
STV 1	STV1
STV 2	STV2
Suedwest3	SWR
SWF 1	SWF1
Schweiz4	SWZ4
TYNE TEES	TEES
Text	TEXT
TF1	TF1
TNT int	TNT
TRT int	TRT
TSI	TSI
TSR	TSR
TSW	TSW
TVE	TVE
TV Polonia	TVPA
TVP 1	TVP1
TVP 2	TVP2
TVS	TVS
TV2	TV2
TV5	TV5
Tele Zurich	TZUR
Ulster TV	ULST
Veronica	VERN
VIVA	VIVA
VIVA2	VIVA2
VOX	VIV2
VTM	VOX
VT4	VTM
West1	VT4
West3	WDR1
YLE 1	WDR3
YLE 2	YLE1
Yorkshire TV	YLE2
ZDF	YORK
Zurich 1	ZDF
3SAT	ZUR1
	3SAT

* The "ID" abbreviation is what is shown on-screen in lieu of the station name. The "ID" abbreviation is listed in the Confirmation screen and is displayed on the TV screen when the unit is tuned to a different station.

TV Station Channel Number Guide

Only the main stations are listed. There are in addition many relay stations, and full lists are available from the BBC and ITV.

	BBC1	BBC2	ITV	CH4	CH5		BBC1	BBC2	ITV	CH4	CH5
London & South-East						North-West					
Bluebell Hill.....	40	46	43	65	—	Caldbeck.....	30	34	28	32	56
Crystal Palace.....	26	33	23	30	37	Winter Hill.....	55	62	59	65	48
Dover.....	50	56	66	53	—	North-East					
Heathfield.....	49	52	64	67	—	Bilsdale West Moor.....	33	26	29	23	35
Oxford.....	57	63	60	53	49	Chatton.....	39	45	49	42	—
South-West						Pontop Pike.....	58	64	61	54	68
Beacon Hill.....	57	63	60	53	—	Scotland					
Caradon Hill.....	22	28	25	32	—	Angus.....	57	63	60	53	—
Huntshaw Cross.....	55	62	59	65	67	Black Hill.....	40	46	43	50	37
Redruth.....	51	44	41	47	37	Sandale.....	22	—	—	—	—
Stockland Hill.....	33	26	23	29	—	Caldbeck.....	—	34	28	32	56
Channel Islands						Creigkelly.....	31	27	24	21	48
Fremont Point.....	51	44	41	47	—	Darvel.....	33	26	23	29	35
South						Durris.....	22	28	25	32	67
Hannington.....	39	45	42	66	35	Eitshal.....	33	26	23	29	—
Midhurst.....	61	55	58	68	—	Keelylang Hill.....	40	46	43	50	—
Rowridge.....	31	24	27	21	—	Knock More.....	33	26	23	29	—
West						Rosemarkie.....	39	45	49	42	67
Mendip.....	58	64	61	54	37	Rumster Forest.....	31	27	24	21	—
East						Selkirk.....	55	62	59	65	52
Sandy Heath.....	31	27	24	21	39	Wales					
Sudbury.....	51	44	41	47	35	Blaenplwyf.....	31	27	24	21	56
Tacolneston.....	62	55	59	65	52	Carmel.....	57	63	60	53	—
Midlands						Llanddona.....	57	63	60	53	—
Ridge Hill.....	22	28	25	32	35	Moel-y-Parc.....	52	45	49	42	—
Sutton Coldfield.....	46	40	43	50	37	Presely.....	46	40	43	50	37
The Wrekin.....	26	33	23	29	35	Wenvoe.....	44	51	41	47	—
Waltham.....	58	64	61	54	35	Northern Ireland					
North						Brougher Mountain.....	22	28	25	32	—
Belmont.....	22	28	25	32	56	Divis.....	31	27	24	21	37
Emley Moor.....	44	51	47	41	37	Limavady.....	55	62	59	65	—

Clock Set

- Turn on the unit.
- Turn on the TV and select the AV mode.
- Slide the **TV/CABLE/SAT/DVD** switch to **DVD**.

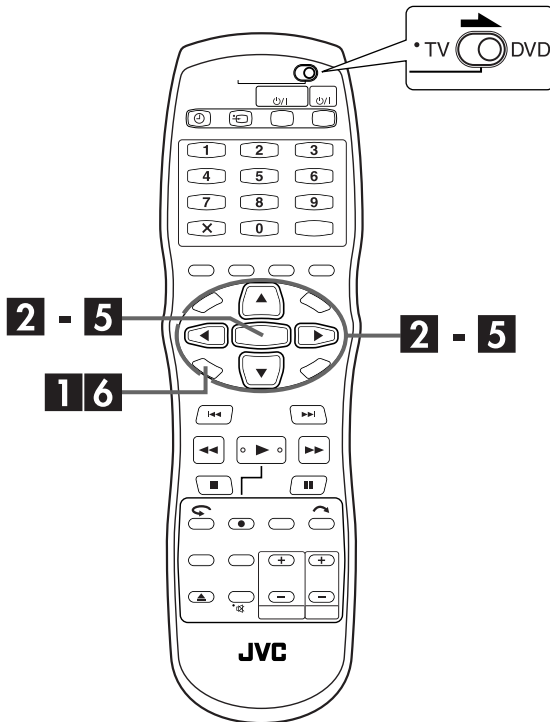

Just Clock

The Just Clock function provides accurate time keeping through automatic adjustments at regular intervals, by reading data from a PDC signal.

The Just Clock option can be set to "ON" or "OFF" at the Clock Set screen (the default setting is "OFF"). (pg. 105)

IMPORTANT: If you turn off Just Clock, the accuracy of your unit's built-in clock may be reduced, which could adversely affect timer recording. We recommend you to keep Just Clock on. In cases where the clock setting data from a PDC signal is incorrect, however, you are advised to keep Just Clock set to "OFF".

IMPORTANT:

If you performed Auto Set Up (pg. 21) or Preset Download (pg. 23), without ever having set the clock previously, the unit's built-in clock is also set automatically. Perform the following steps only if —

- Auto Clock Set has not been performed correctly by Auto Set Up or Preset Download.

OR

- you want to change Just Clock setting. (pg. "Just Clock" in the left column)

1 Access the Main Menu screen.

Press **SET UP**.

2 Access the "CLOCK SET" screen.

- 1 Press **◀ ▶** to select "INITIAL SET UP", then press **ENTER**.
- 2 Press **◀ ▶** to select "CLOCK SET", then press **ENTER**.

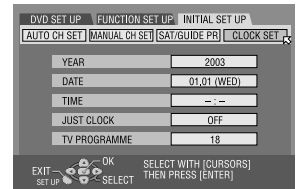

3 Set the date and time.

- 1 Press **△ ▽** to select "YEAR", then press **ENTER**.
- 2 Press **△ ▽** to set the year, then press **ENTER**.
 - Repeat the same procedure to set the date and time. When you set the time, press and hold **△ ▽** to change the time by 30 minutes.
 - When you set the date, press and hold **△ ▽** to change the date by 15 days.

4 Set Just Clock.

The default setting is "OFF".

- 1 Press $\Delta\nabla$ to select "JUST CLOCK", then press **ENTER**.
 - 2 Press $\Delta\nabla$ to set to the desired mode, then press **ENTER**.
- For the Just clock function, refer to "Just Clock" on page 104.
 - If you set to "OFF", you can disregard the next step as you won't be able to receive regular clock adjustments.

5 Set the source channel position for clock data.

The unit is preset to receive clock setting and adjustment data from channel position 1.

- 1 Press $\Delta\nabla$ to select "TV PROGRAMME", then press **ENTER**.
- 2 Press $\Delta\nabla$ to set the channel position to the number representing the station transmitting clock setting data, then press **ENTER**.

6 Start the clock operation.

Press **SET UP**.

NOTES:

- Just Clock (when set to "ON") adjusts the unit's built-in clock every hour, except for 23:00, 0:00, 1:00 and 2:00.
- Just Clock is not effective when:
 - the unit's power is on.
 - the unit is in the Timer mode.
 - a difference of more than 3 minutes exists between the built-in clock's time and the actual time.
 - the unit is in the Automatic Satellite Programme Recording mode. (☞ pg. 65)
 - the unit is in the Power Save mode. (☞ pg. 95)
 - "L-2 SELECT" is set to "SAT VIDEO" or "SAT S-VIDEO". (☞ pg. 85)
- If Just Clock is set to "ON", the unit's clock is automatically adjusted at the start/end of Summer Time.
- Just Clock may not function properly depending on the reception condition.

Format a disc



Some DVD-RAM/RW discs are unformatted. Format the disc when you use an unformatted disc or you want to delete all recordings and data on the disc.

ATTENTION:

- When a disc is formatted, all recordings and data are erased. It is impossible to restore them.
- Never turn off the unit or disconnect the mains power cord while "NOW FORMATTING..." is displayed on the TV screen.

- Turn on the unit.
- Turn on the TV and select the AV mode.
- Slide the TV/CABLE/SAT/DVD switch to DVD.
- Load a DVD-RAM/RW disc to format.

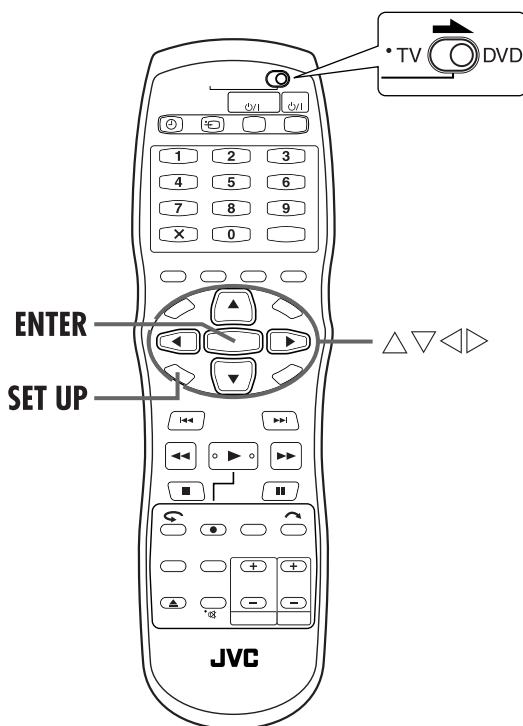

Format a DVD-RAM disc

1 Access the Main Menu screen.

Press **SET UP**.

2 Access the "UTILITY" screen.

- 1 Press $\Delta \nabla \triangleleft \triangleright$ to select "DVD SET UP", then press **ENTER**.
- 2 Press $\triangleleft \triangleright$ to select "UTILITY", then press **ENTER**.

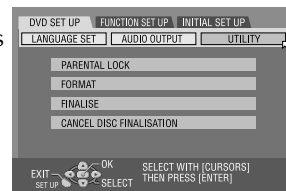

3 Format the disc.

- 1 Press $\Delta \nabla$ to select "FORMAT", then press **ENTER**. Press $\triangleleft \triangleright$ to select "YES", then press **ENTER** when "DISC WILL BE FORMATTED" appears on the TV screen.
- 2 Press $\triangleleft \triangleright$ to select "OK", then press **ENTER** when "DISC FORMATTING WAS SELECTED" appears on the TV screen.

Format a DVD-RW disc

Perform steps **1** to **2** of "Format a DVD-RAM disc" on the above before continuing.

1 Format the disc.

- 1 Press $\Delta \nabla$ to select "FORMAT", then press **ENTER**. Press $\triangleleft \triangleright$ to choose "VR MODE" or "VIDEO MODE", then press **ENTER** when "DISC WILL BE FORMATTED" appears on the TV screen.
 - "VR MODE": To be chosen when you want to record, erase, or edit data on the disc repeatedly.
 - "VIDEO MODE": To be chosen when you want to erase all the data on the disc once played back to record new data, or play the disc on other DVD players.
- 2 Press $\triangleleft \triangleright$ to select "YES", then press **ENTER** when "DISC WILL BE FORMATTED IN VR MODE/VIDEO MODE" appears on the TV screen.

NOTES:

- It is impossible to format Version 1.0 DVD-RW discs in Video mode.
- It is impossible to format DVD-R discs.
- All the programmes on a disc will be deleted even if they are protected titles. (pg. 70, "Protect title")

Finalise a disc



Finalising DVD-R/RW discs recorded on this unit makes it possible for the discs to be played back on other DVD players. DVD-RW discs are finalised in the mode that the discs were formatted, enabling playback on compatible DVD players. Titles input in the Library Database DVD Navi are registered as titles in the DVD menu. (☞ pg. 32, 70)

- Turn on the unit.
- Turn on the TV and select the AV mode.
- Slide the **TV/CABLE/SAT/DVD** switch to **DVD**.
- Load a DVD-R/RW disc to finalise.

Before finalising

- It is possible to record on a blank space.
- It is possible to enter a programme title. (☞ pg. 70, "Modify Programme Name")
- It is possible to delete programmes. (☞ pg. 71, "Delete programme")
- It is impossible to overwrite recorded areas of DVD-R discs.
- Available recording capacity does not increase even if a recorded programme is deleted from a DVD-R disc.
- It is impossible to record or edit DVD-R/RW discs recorded on other devices even if they have not been finalised.

After finalising (For DVD-R/RW (Video mode) discs)

- Video and audio that have been recorded by then are recorded in conformity to the DVD Video standard, enabling you to play back the discs as DVD VIDEO discs. (☞ pg. 7, "Discs for Playback Only")
- Although DVD-R/RW discs finalised on this unit become playable on DVD players compatible with DVD-R/RW discs, some discs still may not play, for which JVC cannot take responsibility.
- Marked points marked before finalising will be deleted, and programmes will be divided automatically into "chapters" approximately every 5 minutes. (☞ pg. 34, "Marking positions to play again later")
- Depending on the DVD players and DVD-R/RW discs used, and on the conditions of recording, it may not be possible to play back the discs. In this case, play back the discs on this unit.
- Additional recordings become impossible.

Finalise a DVD-R/RW disc

Perform steps **1** to **2** of "Format a DVD-RAM disc" (☞ pg. 106) before continuing.

1 Finalise the disc.

- 1 Press $\triangle\nabla$ to select "FINALISE", then press **ENTER**. Press $\triangleleft\rangle$ to select "YES", then press **ENTER** when "DISC WILL BE FINALISED" appears on the TV screen.
- 2 Press $\triangleleft\rangle$ to select "OK", then press **ENTER** when "FINALISING WILL MAKE DISC READ-ONLY" appears on the TV screen.

2 Return to the normal screen.

Press **SET UP**.

- Menu screen is cleared.
- The Library Database DVD Navi screen is not displayed once a DVD-R/RW (Video mode) disc has been finalised. The DVD menu appears instead. On the other hand, the Library Database DVD Navi screen is displayed even after a DVD-RW (VR mode) disc has been finalised. (☞ pg. 66)
- Recording and editing can be performed, even after finalising, on a DVD-RW (VR mode) disc finalised on this unit.
- Once a DVD-RW (VR mode) disc has been finalised, it can be played on DVD players compatible with VR mode.

Cancel the finalisation of a DVD-RW disc

Load a DVD-RW disc to cancel the disc finalisation, and perform steps **1** to **2** of "Format a DVD-RAM disc" (☞ pg. 106) before continuing.

1 Cancel the disc finalisation.

- 1 Press $\triangle\nabla$ to select "CANCEL DISC FINALISATION", then press **ENTER**.
- 2 Press $\triangleleft\rangle$ to select "OK", then press **ENTER** when "CANCEL DISC FINALISATION" appears on the TV screen.

2 Return to the normal screen.

Press **SET UP**.

- When the disc finalisation is cancelled, the mode in which the disc was formatted is restored, making the disc recordable. (☞ pg. 8, 106)

Scan Mode Set

You can select the scan mode from two modes: Interlaced scan mode which is used in the conventional TV system, and Progressive scan mode which enables reproduction of higher-quality images. For details, refer to "GLOSSARY" (pg. 113).

- Turn on the unit.
- Turn on the TV and select the AV mode.
- Slide the **TV/CABLE/SAT/DVD** switch to **DVD**.

ATTENTION:

Your TV needs to be compatible with PAL Progressive.

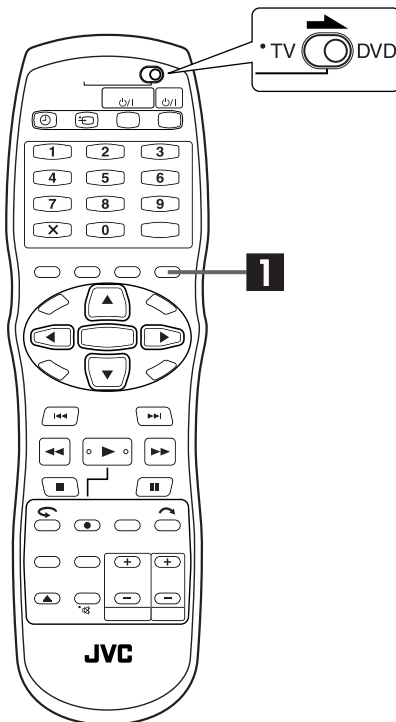

1 Set the scan mode.

Press **PROGRESSIVE SCAN** for 2 or more seconds.

- Video output indicator (P) lights on the front display panel if Progressive scan mode has been established. (pg. 14)
- Each press of **PROGRESSIVE SCAN** for 2 or more seconds switches the scan mode.

NOTES:

- When the progressive mode is set, be sure to set "L-1 OUTPUT" to "COMPONENT". (pg. 84, "L-1 Output and L-1 Input Setting (L-1 OUTPUT and L-1 INPUT)") Progressive scan is output only from COMPONENT VIDEO OUT connector.
- Interlaced scan mode is the setting at your purchase.
- When Progressive scan mode is engaged, no video signal is output from S-VIDEO OUT connector and L-1 IN/OUT connector.
- Interlaced scan mode might be suitable depending on video material.
- Scan mode cannot be set while menu screen is displayed.

Before requesting service for a problem, use this chart and see if you can solve the trouble yourself. Small problems are often easily solved, and this can save you the trouble of sending your unit off for repair.

GENERAL

SYMPTOM	POSSIBLE CAUSE	CORRECTIVE ACTION
1. No power is supplied to the unit.	<ul style="list-style-type: none"> The AC power plug is disconnected from the mains. 	Connect the AC power plug to the mains securely. (☞ pg. 18)
2. The channel cannot be changed.	<ul style="list-style-type: none"> Recording or Live Memory recording is in progress. 	Press II to pause recording, change the channel, then press ▶ to resume recording.
3. The remote control does not operate the unit.	<ul style="list-style-type: none"> The setting of the remote control code is inappropriate. The batteries are discharged. 	Set the same remote control code (1, 2, 3, or 4) on both the unit and the remote control. (☞ pg. 87) Replace the dead batteries with new ones.
4. Dubbing from the external equipment is not possible.	<ul style="list-style-type: none"> The setting of the input channel position is inappropriate. 	Select the input channel position ("F-1", "L-1", or "L-2") that corresponds to the input terminal connected to the external equipment. (☞ pg. 83)
5. The on-screen display superimposed on the programme played back/ received on this unit is recorded when you dub the programme to an external recording equipment.	—	Set "SUPERIMPOSE" to "OFF". (☞ pg. 95)
6. The remote control does not work properly.	<ul style="list-style-type: none"> The batteries are discharged. 	Remove the batteries, wait for 5 minutes or more, then load the batteries again. Replace the dead batteries with new ones.
7. The unit does not operate.	<ul style="list-style-type: none"> There are cases when the operation is prohibited on the disc. Lightning or static electricity may cause malfunction of the unit. 	— Press ⏻ to turn the power off, then press the button again to turn the power on.

PLAYBACK

SYMPTOM	POSSIBLE CAUSE	CORRECTIVE ACTION
1. Images do not appear on the TV screen.	<ul style="list-style-type: none"> The TV is not set to the AV mode. When interlace scanned programme is played back, progressive scan mode is selected. 	Set the TV to the AV mode. Press and hold PROGRESSIVE SCAN until P disappears from the front display panel.
2. Playback does not start or stop immediately after playback is started by pressing ▶ . On the front display panel, "NO DISC" appears.	<ul style="list-style-type: none"> The disc is loaded upside down. A disc not being compatible with the unit is loaded. A dirty disc is loaded. Defective disc is loaded. 	Place the disc on the disc tray with the playback surface facing downward. (☞ pg. 10) Load a playable disc on the unit. (☞ pg. 6, 7) Clean the disc. (☞ pg. 10) Replace the warped or scratched disc with a normal one.
3. Images are blurred or distorted when you start High-Speed Search.	—	Images are blurred or distorted at the point where the playback speed changes and this is not a malfunction of the unit.
4. Playback does not start.	—	Playback does not start for approximately 30 seconds after recording is stopped and this is not a malfunction of the unit.
5. Playback does not start when you select a title or a chapter.	<ul style="list-style-type: none"> The Parental Lock is engaged and the disc is rated higher than the set level. 	Release the Parental Lock temporarily or change the set level. (☞ pg. 49)

RECORDING

SYMPTOM	POSSIBLE CAUSE	CORRECTIVE ACTION
1. The desired programme cannot be recorded.	<ul style="list-style-type: none"> The channel position does not correspond to that in the receiving area. 	Set the correct channel position for the receiving broadcast. (☞ pg. 98)
2. Recording cannot be made.	<ul style="list-style-type: none"> No disc or a disc not being compatible with the unit is loaded. The disc loaded is not formatted. A finalised DVD-R disc is loaded. The disc is full or does not have enough space for the programme to be recorded. 	Load a recordable disc on the unit. (☞ pg. 6) Format the disc. (☞ pg. 106) Recording cannot be made on finalised discs. (☞ pg. 107) Load a recordable disc on the unit. Clear unnecessary programmes on the disc or load a blank disc. (☞ pg. 71)
3. Timer programming cannot be made.	<ul style="list-style-type: none"> Date and time is not correct. 	Set date and time correctly. (☞ pg. 104)
4. Timer programming recording does not start.	<ul style="list-style-type: none"> Power failure occurred before the timer programmed recording starts. 	Check the timer programming. (☞ pg. 63)
5. VIDEO Plus+ Timer Programming cannot be made.	<ul style="list-style-type: none"> Date and time set on the unit is not correct. The channel position does not correspond to that in the receiving area. 	Set date and time correctly. (☞ pg. 104) Set the correct channel position for the receiving broadcast. (☞ pg. 98)
6. Automatic Satellite Programming recording does not start.	<ul style="list-style-type: none"> The satellite receiver is not connected properly to this unit. 	Connect the satellite receiver to the L-2 IN/DECODER connector properly. (☞ pg. 90)
7. On the front display panel, “- :- -” appears.	<ul style="list-style-type: none"> Power failure occurred. 	Set date and time correctly. (☞ pg. 104)
8. “PROGRAM FULL” appears on the TV screen during timer programming.	<ul style="list-style-type: none"> Eight programmes have already been timer programmed. 	Clear unnecessary programmes on the unit, then try timer programming again. (☞ pg. 63)
9. The disc space does not increase when recorded programmes are cleared.	<ul style="list-style-type: none"> The PC's data recorded on a DVD-RAM drive cannot be cleared on this unit. 	Format the disc. (When the disc is soiled, wipe the disc with a soft dry cloth before formatting.) (☞ pg. 10, 106)

INITIALIZING

SYMPTOM	POSSIBLE CAUSE	CORRECTIVE ACTION
1. Malfunction occurs on the unit.	—	Press $\psi/1$ to turn off the unit, press and hold $\psi/1$, then press \blacksquare for two seconds or more.

ATTENTION:

This unit contains microcomputers. External electronic noise or interference could cause malfunctioning. In such cases, switch the unit off and unplug the mains power cord. Then plug it in again and turn the unit on. Take out the disc. After checking the disc, operate the unit as usual.

ON-SCREEN MESSAGES

MESSAGE	DESCRIPTION
MEMORY IS FULL NOTHING MORE CAN BE REGISTERED IN THE LIBRARY IF YOU DELETE UNNECESSARY TITLE INFORMATION, YOU CAN THEN REGISTER ADDITIONAL INFORMATION	The memory is full for registration for the Navigation system. The recording cannot be started even though the capacity for the recording is enough. (☞ pg. 71)
AVAILABLE MEMORY IS LOW SOON YOU WILL NO LONGER BE ABLE TO REGISTER INFORMATION IN THE LIBRARY IF YOU DELETE UNNECESSARY TITLE INFORMATION, YOU CAN THEN REGISTER ADDITIONAL INFORMATION	The remaining capacity of the memory is not enough for registration for the Navigation system. The recording cannot be started even though the capacity for the recording is enough. (☞ pg. 71)
DISC NOT REGISTERED IN THE LIBRARY REGISTER DISC?	A disc that is not registered in the library has been inserted. Register the disc as necessary. (☞ pg. 77)
INSERT DISC #XXXX	Appears when a title that has been selected in the library is not contained in the loaded disc. (☞ pg. 76)
CAN NOT RECORD OR MAKE PLAY LIST DELETE UNWANTED TITLES	<ul style="list-style-type: none"> ● Recording and/or editing cannot be performed with a loaded DVD-RAM disc. ● The number of titles exceeds 99. ● The number of play lists exceeds 999.
SET CLOCK BEFORE TIMER PROGRAMMING	To set the timer programme, the clock must be set in advance. (☞ pg. 104)
PROGRAMME FULL DELETE UNWANTED TIMER PROGRAMME	You can programme this unit to timer-record as many as 8 programmes. To programme more, you need to cancel a timer programme already set. (☞ pg. 63)
CAN NOT SET DISC TIMER PROGRAMMING WITH THIS DISC PREPARE A FORMATTED DISC AS DESCRIBED BELOW DVD-RAM DVD-RW (VR MODE)	On-Disc Timer Programming has been attempted when a disc that is not compatible with the function is loaded. (☞ pg. 60)
NO DISC INSERTED	On-Disc Timer Programming has been attempted when a disc is not loaded, or loaded upside down. (☞ pg. 10, 60)
DISC NOT RECORDABLE INSERT RECORDABLE DISC	When a playback-only disc or a finalised disc is loaded, ● has been pressed. (☞ pg. 7, 107)
PLUSCODE NO. ERROR CONFIRM PLUSCODE NO. THEN RETRY	An invalid PlusCode number has been input. (☞ pg. 56)
GUIDE PROGRAMME IS NOT SET SELECT CHANNEL YOU WANT TO RECORD	To set the timer programme using the VIDEO Plus+ system, the Guide Program number must be set in advance. (☞ pg. 97)
CAN NOT SET VIDEO PLUS TIMER PROGRAMMING DURING TIMER RECORDING OR INSTANT TIMER RECORDING CANCEL TIMER RECORDING OR INSTANT TIMER RECORDING, THEN ENTER THE PLUSCODE CODE AGAIN	Appears when you tried to input a PlusCode number during timer recording or instant timer recording.
REGION CODE ERROR CHECK DISC	A disc loaded cannot be played back on this unit since the region number of the disc does not match that of the unit. (☞ pg. 7)
UNREADABLE DISC CHECK DISC	When an incompatible disc is loaded, ► has been pressed. (☞ pg. 7)
COULD NOT FORMAT THE DISC CHECK THE DISC	Formatting is not complete since the disc may be dirty or damaged. Take out the disc, clean it and retry. (☞ pg. 10, 106)
COULD NOT FINALISE THE DISC CHECK THE DISC	Finalising is not complete since the disc may be dirty or damaged. Take out the disc, clean it and retry. (☞ pg. 10, 107)
COULD NOT CANCEL DISC FINALISATION CHECK THE DISC	Cancelling disc finalisation is not complete since the disc may be dirty or damaged. Take out the disc, clean it and retry. (☞ pg. 10, 107)

ON-SCREEN MESSAGES (cont.)

MESSAGE	DESCRIPTION
PRESS [STOP] AGAIN TO STOP RECORDING	During Live Memory playback, ■ has been pressed. (☞ pg. 40)
TIMER RECORDING COMPLETED	Timer recording has finished during Live Memory playback.
PLAYBACK WILL STOP THEN TIMER RECORDING WILL START	Timer recording finished during Live Memory playback, then the next timer recording is about to begin while playback continues.
COPY PROHIBITED CAN NOT RECORD	<ul style="list-style-type: none"> ● An attempt has been made to record copy-protected contents. ● An attempt has been made to record copy-once contents on a disc that is not CPRM compatible, such as DVD-R.
COPY PROHIBITED CAN NOT PLAY	The unit has detected invalid contents at the start or in the middle of playback.
THE i.LINK DEVICE THAT YOU HAVE CONNECTED IS NOT RECOGNIZED MAKE SURE THAT THE DEVICE IS CONNECTED PROPERLY AND POWERED ON	An attempt has been made to start DV dubbing when a digital video camera is not properly connected to the unit. Check the connection. (☞ pg. 80)

■ Aspect ratio

The ratio of vertical and horizontal sizes of a displayed image. The horizontal vs. vertical ratio of conventional TVs is 4:3, and that of wide-screens is 16:9.

■ Chapter

Refers to individual chapters included in a title.

■ Composite video signal

Refers to video signal comprised of three kinds of signals combined: an image signal made up of luminance and chrominance signals using the frequency multiplication technique; burst signal providing the basis for colour reproduction; and synchronization signal.

■ Component video signal

A video signal system where parts of information necessary for reproducing image signal comprised of the three primary colours of light are transmitted via separate signal lines. Types of signal, such as R/G/B, Y/P_B/P_R, etc., are available.

■ Disc menu

A screen display prepared for allowing selection of images, sounds, subtitles, multiangles, etc. recorded on a DVD disc.

■ Dolby Digital (AC-3)

A six-channel system consisting of left, centre, right, left rear, right rear and LFE (Low-Frequency Effect channel, for use with a sub-woofer) channels. All processing is done in the digital domain.

Not all Dolby Digital discs contain six (5.1) channels of information.

■ Down-mix

Internal stereo mix of multichannel surround audio by a DVD player. The down-mix signals are output from stereo output connectors.

■ DTS

A Digital Surround audio encoding format configured with six (5.1) channels, similar to Dolby Digital. It requires a decoder, either in the player or in an external receiver. DTS stands for Digital Theater Systems.

Not all DTS discs contain six (5.1) channels of information.

■ Interlaced scan

In the conventional video system, a picture is shown on the display monitor in two halves. The Interlaced scan system places lines of the second half of the picture in-between lines of the first half of the picture.

■ JPEG

A still-picture data compression system proposed by the Joint Photographic Expert Group, which features small decrease in image quality in spite of its high compression ratio.

■ Letter box

A method of displaying wide images like movies in the centre of a 4:3 TV screen with no part of the image deleted, by placing black bands on the top and bottom of the screen. This name has resulted from the screen form looking literally like a letter box.

■ Linear PCM (PCM: Pulse Code Modulation)

A system for converting analog sound signal to digital signal for later processing, with no data compression used in conversion.

■ MP3

A file format with a sound data compression system. "MP3" is the abbreviation of Motion Picture Experts Group 1 (or MPEG-1) Audio Layer 3. By using MP3 format, one CD-R/RW can contain about 10 times as much data volume as a regular CD can.

■ MPEG

A family of Standards for compressing audio-visual information. "MPEG" standards include MPEG-1, MPEG-2 and MPEG-4. Video CD and MP3 are based on MPEG-1, while DVD is based on MPEG-2. MPEG stands for Moving Picture coding Experts Group.

■ Multiangle

By recording multiple scenes progressing at the same time in a single title, the user can select view angles. This feature is called the multiangle function.

■ Multichannel

DVD is specified to have each sound track constitute one sound field. Multichannel refers to a structure of sound tracks having three or more channels.

■ Multilanguage

When a title is created to cope with multiple languages, it is generally called a multilanguage title.

■ NTSC (National television system committee)

A black and white and colour television system format used in the U.S.A., Canada, Mexico and Japan.

■ PAL (Phase Alternation by Line)

A colour television system format used extensively in Western Europe.

■ Parental Lock

A feature of this system to automatically determine whether or not to reproduce particular DVD software by comparing its parental lock level (a measure of undesirability of scenes, etc. from educational viewpoint) set for the software beforehand with that set on this system by the user; if the software's level is less restrictive than the user-set level, it will be reproduced.

■ Playback control (PBC)

Refers to the signal recorded on Video CDs for controlling reproduction. By using menu screens recorded on a Video CD that supports PBC, you can enjoy interactive-type software as well as software having a search function.

■ Progressive scan

Progressive scan displays all the horizontal lines of a picture at one time, as a single frame. This system can convert the interlaced video from DVD into progressive format for connection to a progressive display. It dramatically increases the vertical resolution.

■ Region Code

A system for allowing discs to be played back only in the regions designated beforehand. All the countries in the world are grouped into six regions, each region being identified by a specified Region Code (or region number). If the Region Code given to a disc includes a numeral which matches one in the Region Code of a player, the player can play back the disc.

■ Sampling frequency

Frequency of sampling data when analog data is converted to digital data. Sampling frequency numerically represents how many times the original analog signal is sampled per second.

■ Surround

A system for creating three-dimensional sound fields full of realism by arranging multiple speakers around the listener.

■ Transfer rate

The rate of transferring digital data. Usually the measure is in baud per second. The DVD system applies a variable transfer rate system for high efficiency.

GENERAL

Power requirement : AC 220 V – 240 V~, 50 Hz/60 Hz
 Power consumption
 Power on : 34 W
 Power off : 18.5 W
 Temperature
 Operating : 5°C to 40°C
 Storage : –20°C to 60°C
 Operating position : Horizontal only
 Dimensions (WxHxD)
 : 435 mm x 70 mm x 346 mm
 Weight : 4.5 kg

VIDEO/AUDIO

Pickup
 CD
 Wavelength : 780 nm
 Maximum output power : 0.5 mW
 DVD
 Wavelength : 650 nm
 Maximum output power : 1.0 mW
 Recordable disc : DVD-RAM 12 cm (4.7 GB/9.4 GB)
 DVD-RAM 8 cm (1.4 GB/2.8 GB)
 DVD-R (12 cm: 4.7 GB,
 8 cm: 1.4 GB for General Ver. 2.0)
 DVD-RW (4.7 GB for Ver. 1.0/1.1)
 Recording format
 DVD-RAM : DVD Video Recording format
 DVD-R : DVD-Video format
 DVD-RW : DVD-Video format, DVD Video Recording format
 Recording time
 Maximum 6 hours (with 4.7 GB disc)
 (XP) : Approx. 1 hour
 (SP) : Approx. 2 hours
 (LP) : Approx. 4 hours
 (EP) : Approx. 6 hours
 (FR) : Approx. 1 hour – 6 hours
 Playable disc : DVD-RAM 12 cm (4.7 GB/9.4 GB)
 DVD-RAM 8 cm (1.4 GB/2.8 GB)
 DVD-R (12 cm: 4.7 GB,
 8 cm: 1.4 GB for General Ver. 2.0)
 DVD VIDEO, DVD-RW (4.7 GB)
 Music CD (CD-DA)
 Video CD
 CD-R/RW (CD-DA, Video CD formatted discs)
 Audio recording system
 : Dolby Digital (2 ch)
 Linear PCM (XP mode only)
 Video recording compression system
 : MPEG2 (CBR/VBR)

Input/Output

S-video input
 Y : 0.8 – 1.2 Vp-p, 75 ohms
 C : 0.2 – 0.4 Vp-p, 75 ohms
 S-video output
 Y : 1.0 Vp-p, 75 ohms
 C : 0.3 Vp-p, 75 ohms
 RGB output
 R : 0.7 Vp-p, 75 ohms
 G : 0.7 Vp-p, 75 ohms
 B : 0.7 Vp-p, 75 ohms
 Video input : 0.5 – 2.0 Vp-p, 75 ohms (pin jack)
 Video output : 1.0 Vp-p, 75 ohms (pin jack)
 Audio input : –8 dB, 50 kilohms (pin jack)
 Corresponding to mono (left)
 Audio output : –8 dB, 1 kilohms (pin jack)
 i.Link : 4-pin for DV input
 Component video output
 Y : 1.0 Vp-p, 75 ohms
 CB/CR, PB/PR : 0.7 Vp-p, 75 ohms
 Corresponding to copy protection
 Optical digital audio output
 : –18 dBm, 660 nm
 Corresponding to Dolby Digital and
 DTS Digital Surround
 Bit stream
 Selectable in digital audio output
 setting menu

TUNER/TIMER

Signal system : PAL-type colour signal and CCIR monochrome signal, 625 lines 50 fields
 TV channel storage capacity : 99 positions (+AUX position)
 Tuning system : Frequency synthesized tuner
 Channel coverage : VHF 44.5 MHz – 143 MHz/
 143 MHz – 470 MHz
 UHF 470 MHz – 862 MHz
 Memory backup time : Approx. 60 min.

ACCESSORIES

Provided accessories
 : RF cable,
 21-pin SCART cable,
 Satellite Controller,
 Infrared remote control unit,
 “AA” battery x 2

Specifications shown are for SP mode unless otherwise specified.
 E.& O.E. Design and specifications subject to change without notice.

A		R	
A-B Repeat Playback	44	Random Playback	45
Adjusting the picture quality	48	Recordable/playable discs	6
Angle Selection	35	Recording Medium and Format	8
Audio Channel Selection	36	Recording Resume Function	53
Audio Language/Sound Selection	35	RECORDING SET	94
AUDIO OUTPUT	93	Recording Speed	54
Auto Channel Set	98	Region Number	7
C		Register disc	77
Check, cancel and change programmes	63	Repeat Playback	44
D		Resume Function	34
Delete programme	71	S	
Disc menu	32	Scan Mode Set	108
Discs for Playback Only	7	Select the switching interval of the slide show	48
DISPLAY SET	95	Setting the progressive mode	48
DVD menu	32	Simulated Surround Effect	47
F		Skip Search	33
File Structure of Discs	8	Slow Motion	33
Free Rate Function	55	Still Picture/Frame-By-Frame Playback	33
G		Subtitle Selection	35
Guide Program Number	97	T	
H		Time Search	47
High-Speed Search	33	Top menu	32
I		TV Station Channel Number Guide	103
Instant Timer Recording (ITR)	54	U	
J		Unplayable Discs	7
Just Clock	104		
L			
Letter Box	25		
Library Database DVD Navi	66		
Live Memory	37		
M			
Manual Channel Set	99		
Marking positions to play again later	34		
Menu/Audio/Subtitle Language Set	26		
O			
On-Disc Timer Programming	60		
One Touch Replay	41		
P			
Pan&Scan	25		
Parental Lock	49		
PDC Recording	59		
Play List	72		
Play Set Up Menu	42		
Playback Control (PBC)	36		
Programme Playback	45		



Free Manuals Download Website

<http://myh66.com>

<http://usermanuals.us>

<http://www.somanuals.com>

<http://www.4manuals.cc>

<http://www.manual-lib.com>

<http://www.404manual.com>

<http://www.luxmanual.com>

<http://aubethermostatmanual.com>

Golf course search by state

<http://golfingnear.com>

Email search by domain

<http://emailbydomain.com>

Auto manuals search

<http://auto.somanuals.com>

TV manuals search

<http://tv.somanuals.com>