

JVC

ENGLISH

HDD & S-VHS VIDEO RECORDER

HM-HDS1EU

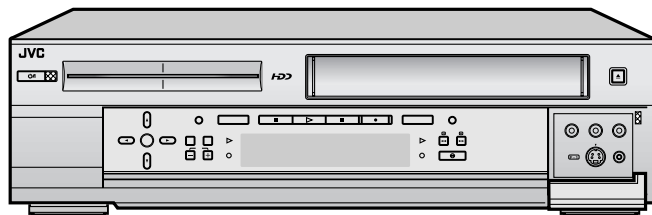

HDD **S-VHS**
625

SHOWVIEW® *Hi-Fi*
DELUXE

Super VHS ET

INSTRUCTIONS

CONTENTS

SAFETY FIRST	2
Safety Precautions	2
INDEX	5
INSTALLING YOUR NEW RECORDER	12
Basic Connection	12
S-VIDEO Connection	13
INITIAL SETTINGS	14
Auto Set Up	14
Preset Download	16
Language	18
SAT CONTROL SET	19
Satellite Receiver Control Setting	19
T-V LINK	21
T-V Link Functions	21
RECORDING/PLAYBACK ON HDD DECK	22
Basic Recording	22
Basic Playback	23
Playback with HDD Navigation	24
Live Memory Playback	26
Playback Features	27
Recording Features	29
RECORDING/PLAYBACK ON VHS DECK	30
Basic Recording	30
Basic Playback	31
Playback with VCR Navigation	32
Playback Features	34
Recording Features	37
B.E.S.T. Picture System	41
TIMER RECORDING	42
SHOWVIEW® Timer Programming	42
Express Timer Programming	44
Automatic Satellite Programme Recording	47
REMOTE CONTROL FUNCTIONS	48
EDITING	51
About Hybrid Navigation	51
Modify Information	52
Dubbing	56
Normal Dubbing (from HDD to VHS)	58
Normal Dubbing (from VHS to HDD)	59
Random Assemble Editing	60
Edit From A Camcorder	62
Output/Input Set	64
Edit To Or From Another Video Recorder	66
Audio Dubbing	68
SYSTEM CONNECTIONS	70
Connecting To A Satellite Receiver	70
Connecting/Using A Decoder	72
Connecting/Using A Stereo System	73
SUBSIDIARY SETTINGS	74
Mode Set	74
SHOWVIEW® System Setup	79
Tuner Set	80
Clock Set	88
TROUBLESHOOTING	90
QUESTIONS AND ANSWERS	97
SPECIFICATIONS	98
LISTE OF TERMS	99

LPT0606-001A

EN

Safety Precautions

The rating plate and the safety caution are on the rear of the unit.

WARNING: DANGEROUS VOLTAGE INSIDE

WARNING: TO PREVENT FIRE OR SHOCK HAZARD, DO NOT EXPOSE THIS UNIT TO RAIN OR MOISTURE.

CAUTION

- When you are not using the recorder for a long period of time, it is recommended that you disconnect the power cord from the mains outlet.
- Dangerous voltage inside. Refer internal servicing to qualified service personnel. To prevent electric shock or fire hazard, remove the power cord from the mains outlet prior to connecting or disconnecting any signal lead or aerial.

WARNING

There are two different types of SECAM colour systems: SECAM-L, used in FRANCE (also called SECAM-West), and SECAM-B, used in Eastern European countries (also called SECAM-East).

1. This recorder can also receive SECAM-B colour television signals for recording and playback.
2. Recordings made of SECAM-B television signals produce monochrome pictures if played back on a video recorder of SECAM-L standard, or do not produce normal colour pictures if played back on a PAL video recorder with SECAM-B system incorporated (even if the TV set is SECAM-compatible).
3. SECAM-L prerecorded cassettes or recordings made with a SECAM-L video recorder produce monochrome pictures when played back with this recorder.
4. This recorder cannot be used for the SECAM-L standard. Use a SECAM-L recorder to record SECAM-L signals.

IMPORTANT

- Please read the various precautions on pages 2 and 4 before installing or operating the recorder.
- It should be noted that it may be unlawful to re-record pre-recorded tapes, records, or discs without the consent of the owner of copyright in the sound or video recording, broadcast or cable programme and in any literary, dramatic, musical, or artistic work embodied therein.



- Cassettes marked "S-VHS" and "VHS" can be used with this video cassette recorder. However, S-VHS recordings are possible only with cassettes marked "S-VHS".
By using the S-VHS ET function, it is possible to record and play back with S-VHS picture quality on VHS cassettes with this recorder.
- SHOWVIEW is a registered trademark of Gemstar Development Corporation. The SHOWVIEW system is manufactured under licence from Gemstar Development Corporation.
- This product incorporates copyright protection technology that is protected by method claims of certain U.S. patents and other intellectual property rights owned by Macrovision Corporation and other rights owners. Use of this copyright protection technology must be authorized by Macrovision Corporation, and is intended for home and other limited viewing users only unless otherwise authorized by Macrovision Corporation. Reverse engineering or disassembly is prohibited.

For Italy:

"It is declared that this product, brand JVC, conforms to the Ministry Decree n. 548 of 28 Aug.'95 published in the Official Gazette of the Italian Republic n. 301 of 28 Dec.'95"

The STANDBY/ON ϕ /I button does not completely shut off mains power from the unit, but switches operating current on and off. " ϕ " shows electrical power standby and "I" shows ON.

Video tapes recorded with this video recorder in the LP/EP (Long Play/Extended Play) mode cannot be played back on a single-speed video recorder.

When the equipment is installed in a cabinet or a shelf, make sure that it has sufficient space on all sides to allow for ventilation (10 cm or more on both sides, on top and at the rear.)

When discarding batteries, environmental problems must be considered and the local rules or laws governing the disposal of these batteries must be followed strictly.

Failure to heed the following precautions may result in damage to the recorder, remote control or video cassette.

1. DO NOT place the recorder ...

- ... in an environment prone to extreme temperatures or humidity.
- ... in direct sunlight.
- ... in a dusty environment.
- ... in an environment where strong magnetic fields are generated.
- ... on a surface that is unstable or subject to vibration.

2. DO NOT block the recorder's ventilation openings or holes.

(If the ventilation openings or holes are blocked by a newspaper or cloth, etc., the heat may not be able to get out.)

3. DO NOT place heavy objects on the recorder or remote control.

4. DO NOT place anything which might spill on top of the recorder or remote control.

(If water or liquid is allowed to enter this equipment, fire or electric shock may be caused.)

5. DO NOT expose the apparatus to dripping or splashing.

6. DO NOT use this equipment in a bathroom or places with water. Also DO NOT place any containers filled with water or liquids (such as cosmetics or medicines, flower vases, potted plants, cups, etc.) on top of this unit.

7. DO NOT place any naked flame sources, such as lighted candles, on the apparatus.

8. AVOID violent shocks to the recorder during transport.

MOISTURE CONDENSATION

Moisture in the air will condense on the recorder when you move it from a cold place to a warm place, or under extremely humid conditions—just as water droplets form in the surface of a glass filled with cold liquid. Moisture condensation on the head drum will cause damage to the tape. In conditions where condensation may occur, keep the recorder turned on for a few hours to let the moisture dry.

PRECAUTION FOR Hard Disk Drive

1. Before installing the recorder

This recorder has a built-in hard disk drive, which is a device to read minute magnetic changes.

The inside of the device is precision-built, which, when installing the recorder, requires you to note the following:

- DO NOT use the recorder in a location prone to vibration or dust.
- DO NOT place the recorder where difference in temperatures is large (condensation can occur), or where humidity is high.
 - When condensation occurs
Water droplets form on the hard disc or head drums inside, possibly causing hard disc and heads to be damaged.
 - About condensation
When well-cooled beer is poured into a glass, water droplets often form around its outside. This phenomenon is called condensation.
- DO NOT install the recorder where the cooling fans in its back may be blocked, or where the recorder may be closed in.
- DO NOT use the recorder placed vertically.

NOTE:

The hard disk may produce mechanical noise, but it is not a malfunction.

2. Before using the recorder

When the power of the unit is on, the hard disc is constantly rotating at high speed.

This requires you to note the following:

- DO NOT impart vibration or shock.
If given a heavy shock, not only is the data recorded damaged but also the hard disk itself can be damaged.
- DO NOT allow anything having strong magnetism or emitting strong electromagnetic waves (cell phones, etc.) near the recorder.
- DO NOT disconnect the power plug from the wall outlet when the power of the recorder is on.
If the power supply is cut off while the hard disc is in operation, it can be damaged or the data stored on it may be damaged. Be sure to push the power button before turning off the power.

3. While using the recorder

When viewing a program by selecting HDD (Hard Disk Drive), there occurs a slight time lag relative to the actual program being broadcast. This is because pictures received are once stored on the hard disk, and then played back. The time lag is about three seconds. If you turn the power on with the hard disk already selected, it will take about 30 seconds before the pictures received appear on the screen. Up until then, any operation is disabled. But it is not a malfunction.

FRONT VIEW

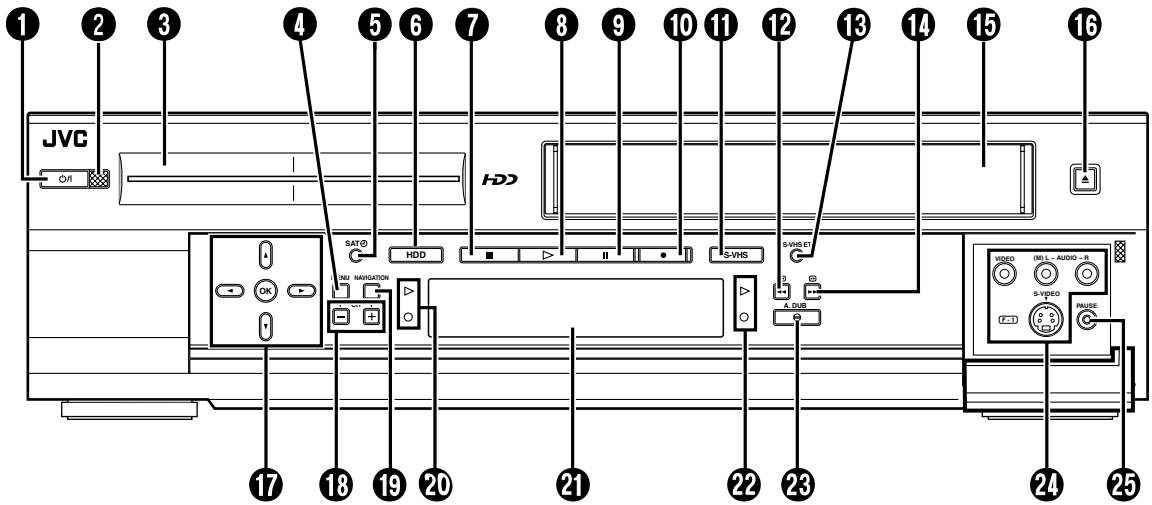

- ❶ STANDBY/ON ψ/I Button \hookrightarrow pg. 14
- ❷ Infrared Beam Receiving Window
- ❸ Hard Disk Drive Illumination
- ❹ MENU Button \hookrightarrow pg. 18
- ❺ SAT \oplus Button \hookrightarrow pg. 47
- ❻ HDD Button \hookrightarrow pg. 22
- ❼ Stop \blacksquare Button \hookrightarrow pg. 22
- ❽ Play \blacktriangleright Button \hookrightarrow pg. 23
- ❾ Pause \parallel Button \hookrightarrow pg. 23
- ❿ Record \bullet Button \hookrightarrow pg. 22
- ⓫ S-VHS Button \hookrightarrow pg. 30
- ⓬ Rewind \blacktriangleleft Button \hookrightarrow pg. 27
- ⓭ S-VHS ET Button \hookrightarrow pg. 39
- ⓮ Fast Forward \blacktriangleright Button \hookrightarrow pg. 27
- ⓯ Cassette Loading Slot
- ⓰ Eject \blacktriangle Button \hookrightarrow pg. 30
- ⓱ \blacktriangle \blacktriangledown \blacktriangleleft and OK Buttons (same as \triangle \triangledown \triangleleft \triangleright buttons on the remote control) \hookrightarrow pg. 14
- ⓲ PR +/- Buttons \hookrightarrow pg. 22
- ⓳ NAVIGATION Button \hookrightarrow pg. 24
- ⓴ HDD mode Indicators \hookrightarrow pg. 22
- ⓵ Front Display Panel \hookrightarrow pg. 7
- ⓶ VHS mode Indicators \hookrightarrow pg. 30
- ⓷ Audio Dubbing (A.DUB) Button \hookrightarrow pg. 69
- ⓸ S-VIDEO/VIDEO/AUDIO Input Connectors \hookrightarrow pg. 62
- ⓹ Remote PAUSE Connector \hookrightarrow pg. 62

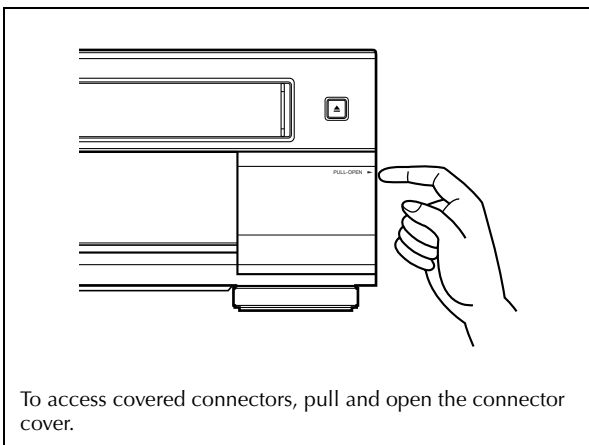

REAR VIEW

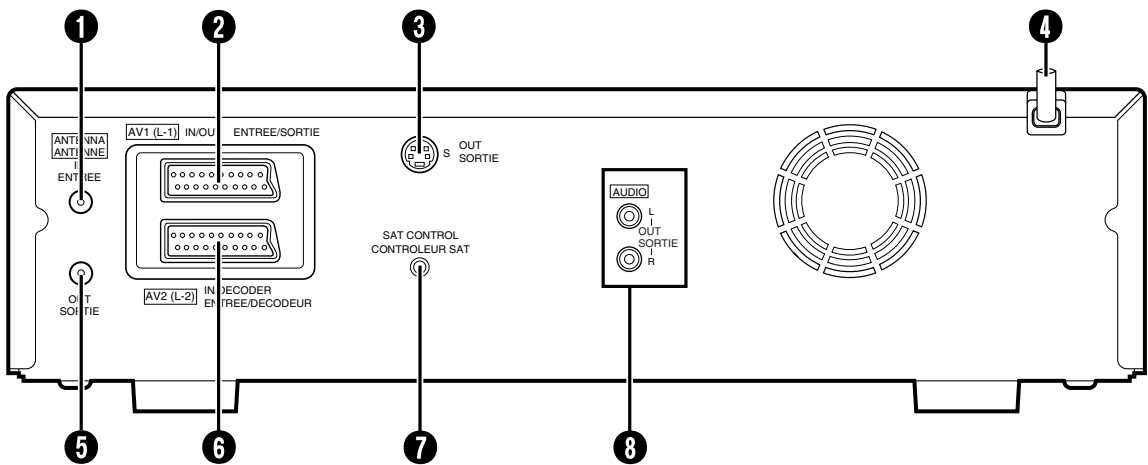

- ❶ ANTENNA IN Connector ☞ pg. 12
- ❷ AV1 (L-1) IN/OUT Connector
☞ pg. 12, 66, 70, 71, 72
- ❸ S OUT Connector ☞ pg. 13
- ❹ Mains Power Cord ☞ pg. 12

- ❺ ANTENNA OUT Connector ☞ pg. 12
- ❻ AV2 (L-2) IN/DECODER Connector
☞ pg. 19, 66, 70, 71, 72
- ❼ SAT CONTROL Connector ☞ pg. 19
- ❽ AUDIO OUT (L/R) Connectors ☞ pg. 73

FRONT DISPLAY PANEL

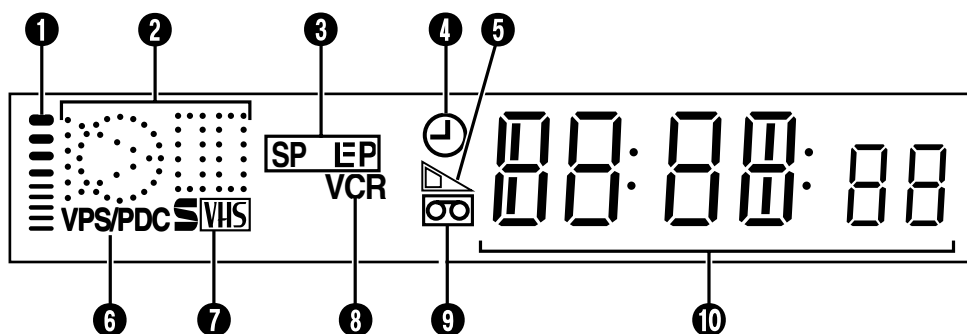

- ❶ B.E.S.T. Picture System Display ☞ pg. 41
- ❷ Symbolic Mode Indicators

PLAY: FF/REW VARIABLE SEARCH:	▶	STILL:	▶
		SLOW:	◉
		RECORD:	◉
AUDIO DUBBING:		☀	
AUDIO DUBBING PAUSE:		☀	

- ❸ Recording Speed Indicators ☞ pg. 22
- ❹ "Timer" Indicator ☞ pg. 43, 45
- ❺ Tape Remaining Time Indicator ☞ pg. 38
- ❻ VPS/PDC Indicator ☞ pg. 45
- ❼ S-VHS Indicator ☞ pg. 39, 75
- ❽ VCR Indicator
- ❾ "Cassette Loaded" Mark
- ❿ Counter/Channel/Clock/Remain Display
(The counter can display up to +/- "99:99:99". If the playback or recording time exceeds this limit, the display starts to count from "0:00:00".)

ON-SCREEN DISPLAY (for HDD deck)

When "O.S.D." is set to "ON" (pg. 78), various operational indicators appear on the TV screen.

When playing back a recorded programme

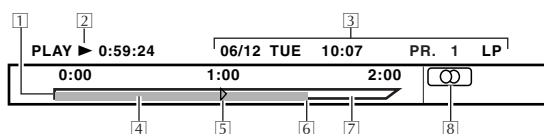

- 1 The beginning of the programme
- 2 Playback mode and time
- 3 Recording information
(Date, start time, channel and recording speed)
- 4 Time scale of the current programme
(This programme has an hour and a half contents.)
- 5 Current playback point
- 6 The end of the programme
- 7 Time scale
- 8 Audio mode

When watching a programme on air

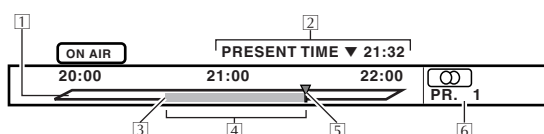

- 1 Time scale around the current time
- 2 Current time
- 3 The beginning point of this programme
(The recorder starts receiving this programme at about 20:30.)
- 4 Length of the time available for Live Memory Playback
- 5 Pointer for current time
(The recorder has been receiving this programme for an hour.)
- 6 Current channel

When pressing PAUSE

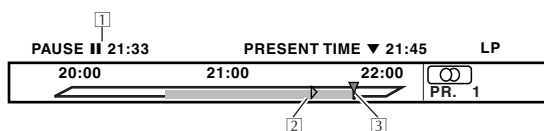

- 1 **||** (pause) is pressed at 21:33.
- 2 Pointer for current picture
- 3 The recorder is now capturing new pictures in this point.

When using Live Memory playback

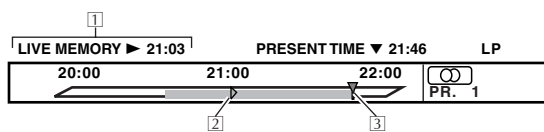

- 1 The time counter using actual time
- 2 Pointer for current picture
- 3 The recorder is now capturing new pictures in this point.

While recording

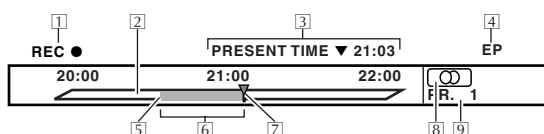

- 1 Recording indicator
- 2 Time scale around the current time
- 3 Current time
- 4 Recording speed
- 5 Start point of the recording
- 6 Length of the time available for Live Memory Playback
- 7 Current recording point
- 8 Audio mode
- 9 Recording channel

ON-SCREEN DISPLAY (for VHS deck)

When "O.S.D." is set to "ON" (☞ pg. 78), various operational indicators appear on the TV screen.

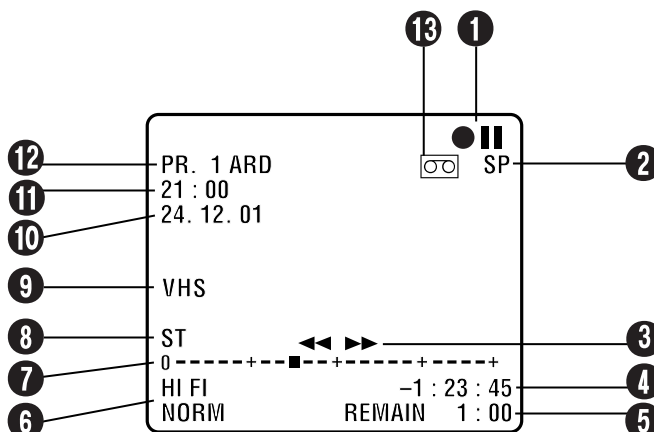

- ❶ Operation Mode Indicators
- ❷ Tape Speed SP/LP/EP
- ❸ Tape Direction
- ❹ Counter Display
- ❺ Tape Remaining Time Indicator ☞ pg. 38
- ❻ Audio Mode Display ☞ pg. 36
- ❼ Tape Position Indicator
- ❽ Type of Broadcast ☞ pg. 40
- ❾ VHS Indicator
- ❿ Current Day/Month/Year
- ⓫ Clock Display
- ⓬ Channel Position Number and Station Name/
Auxiliary Input Indicator (L-1, L-2, F-1, DUB or SAT*)
- * When "L-2 SELECT" is set to "SAT" (☞ pg. 65), "SAT" appears instead of "L-2".
- ⓭ "Cassette Loaded" Mark

The tape position indicator appears on the TV screen when you press ◀◀ or ▶▶ from the Stop mode or perform an Index Search (☞ pg. 35). The position of "■" in relation to "0" (beginning) or "+" (end) shows you where you are on the tape.

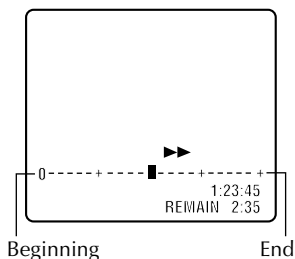

NOTE:

Depending on the type of tape being used, the tape position indicator may not appear correctly.

REMOTE CONTROL

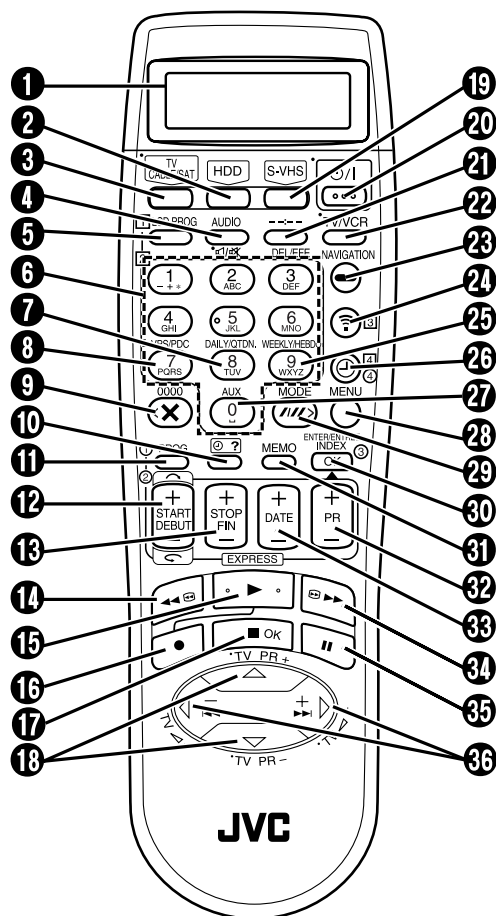

Buttons with a small dot on the left side of the name can also be used to operate your TV. (☞ pg. 49)

- ❶ LCD Panel ☞ pg. 42
- ❷ HDD Button ☞ pg. 22
- ❸ TV/CABLE/SAT Button ☞ pg. 49, 50
- ❹ AUDIO Button ☞ pg. 28, 36
⏻/⏻ (TV Muting) Button ☞ pg. 49
- ❺ LCD PROG Button ☞ pg. 42
- ❻ Number Keys ☞ pg. 22, 42
- ❼ DAILY Button ☞ pg. 43, 45
- ❽ VPS/PDC Button ☞ pg. 43, 45
- ❾ Counter Reset 0000 Button ☞ pg. 38
Cancel × Button ☞ pg. 42
< Button ☞ pg. 53
- ❿ Programme Check ⊕ ? Button ☞ pg. 46
- ⓫ PROG Button ☞ pg. 44
- ⓬ START +/- Button ☞ pg. 44
- ⓭ STOP +/- Button ☞ pg. 44
- ⓮ Rewind << Button ☞ pg. 27
- ⓯ Play ▶ Button ☞ pg. 23
- ⓰ Record ● Button ☞ pg. 22
- ⓱ Stop ■ Button ☞ pg. 22, 23
OK Button ☞ pg. 15
- ⓲ △ ▽ Button ☞ pg. 14
TV PR +/- Button ☞ pg. 49
- ⓳ S-VHS Button ☞ pg. 30
- ⓴ STANDBY/ON ⏻/⏻ Button ☞ pg. 14
- ⓵ Display --:-- Button ☞ pg. 38
DEL Button ☞ pg. 53
- ⓶ TV/VCR Button
- ⓷ NAVIGATION Button ☞ pg. 24
- ⓸ Transmit ⓡ Button ☞ pg. 42
- ⓹ WEEKLY Button ☞ pg. 43, 45
- ⓺ Timer ⌚ Button ☞ pg. 43, 45
- ⓻ AUX Button ☞ pg. 63
- ⓼ MENU Button ☞ pg. 18
- ⓽ Auto Tracking IIII Button ☞ pg. 36
MODE Button ☞ pg. 22
> Button ☞ pg. 53
- ⓿ OK Button ☞ pg. 15
INDEX Button ☞ pg. 52
- ⓿ MEMO Button ☞ pg. 25
- ⓿ PR +/- Button ☞ pg. 22
- ⓿ DATE +/- Button ☞ pg. 44
- ⓿ Fast Forward >>> Button ☞ pg. 27
- ⓿ Pause || Button ☞ pg. 27
- ⓿ <> Button ☞ pg. 18, 27
TV ⏻ +/- Button ☞ pg. 49

How To Use

The remote control can operate most of your video recorder's functions, as well as basic functions of TV sets and satellite receivers of JVC and other brands. (☞ pg. 49, 50)

- Point the remote control toward the receiving window.
- The maximum operating distance of the remote control is about 8 m.

NOTES:

- When inserting the batteries, be sure to insert in the correct directions as indicated under the battery cover.
- If the remote control doesn't work properly, remove its batteries, wait a short time, replace the batteries and then try again.

Remote Control LCD

The remote control can operate not only the video recorder but also some of your TV and satellite receiver's functions. The LCD indicates which of these (VIDEO, TV or CABLE/SAT) the remote control can currently operate. When you first purchase the remote control, or after you have just replaced the batteries, VIDEO A (A code) is selected.

- 1 To operate your video recorder, first press the **HDD** or **S-VHS**. To switch the remote control's A/B/C/D code, refer to page 48.

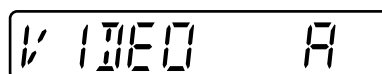

- 2 To operate your TV, first press **TV/CABLE/SAT** until "TV" appears on the LCD. (☞ pg. 49)

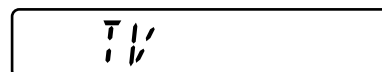

- 3 To operate your satellite receiver, first press **TV/CABLE/SAT** until "CABLE SAT" appears on the LCD. (☞ pg. 50)

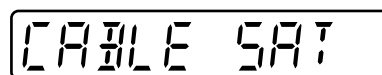

NOTES:

Even if "TV" is displayed on the LCD, the following operations can be performed without switching the mode.

- Basic operations for the recorder
After an operation is completed, "TV" reappears on the LCD.
- Express timer programming and SHOWVIEW timer programming operations
To perform a TV operation again, switch to TV mode first.
- Accessing main menu
To perform a TV operation again, switch to TV mode first.

Basic Connection

It's essential that your video recorder be properly connected.

THESE STEPS MUST BE COMPLETED BEFORE ANY VIDEO OPERATION CAN BE PERFORMED.

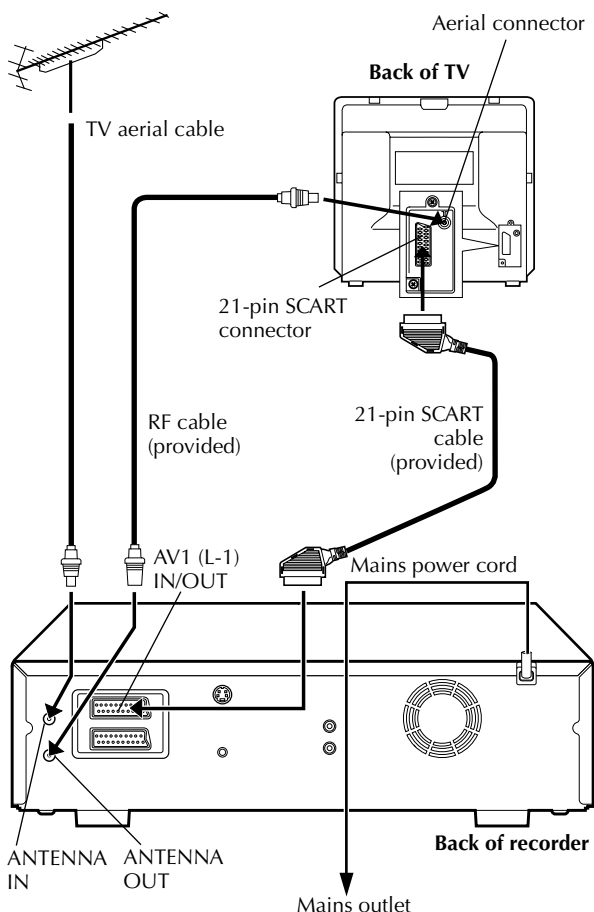

ATTENTION:

Your TV must have a 21-pin AV input connector (SCART) for the connection to the recorder.

1 Check the contents.

Make sure the package contains all of the accessories listed in "SPECIFICATIONS" on page 98.

2 Situate the recorder.

Place the recorder on a stable, horizontal surface.

3 Connect the recorder to TV.

- 1 Disconnect the TV aerial cable from the TV.
 - 2 Connect the TV aerial cable to the ANTENNA IN connector on the rear panel of the recorder.
 - 3 Connect the provided RF cable between the ANTENNA OUT connector on the rear panel of the recorder and the TV's aerial connector.
 - 4 Connect the provided 21-pin SCART cable between the AV1 (L-1) IN/OUT connector on the rear panel of the recorder and the TV's 21-pin SCART connector.
- The AV1 (L-1) IN/OUT connector accepts and delivers either a composite signal (regular video signal) or a Y/C signal (a signal in which the luminance and chrominance signals are separated). If your TV's 21-pin AV input connector (SCART) is compatible with the Y/C signal, set "L-1 OUTPUT" to "S-VIDEO" after the connection and the initial settings are completed (pg. 64). You can obtain high-quality S-VHS pictures. (For connection, be sure to use a 21-pin SCART cable that is compatible with the Y/C signal.)
 - Set your TV to the VIDEO (or AV), Y/C, or RGB mode according to the type of your TV's SCART connector.
 - For switching the TV's mode, refer to the instruction manual of your television.
 - To obtain high-quality S-VHS pictures, you can also use the S-VIDEO connection described on page 13.

4 Connect the recorder to mains.

Plug the end of the mains power cord into a mains outlet.

After the connection is completed, perform "Auto Set Up" on page 14.

S-VIDEO Connection

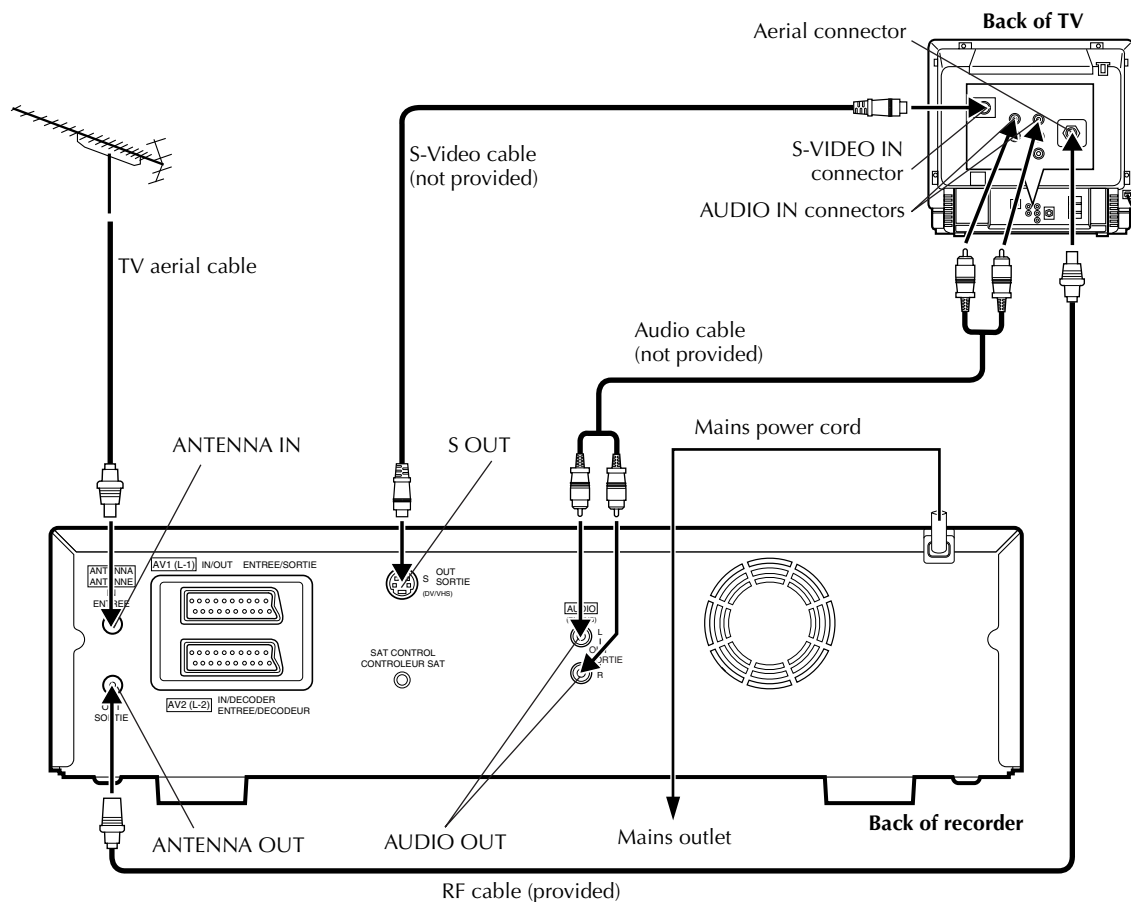

■ To connect to a TV with S-VIDEO/AUDIO IN connectors . . .

1 Connect the recorder to TV.

- 1 Connect the aerial, recorder and TV as per "Basic Connection" (☞ pg. 12).
- 2 Connect the recorder's S OUT connector to the TV's S-VIDEO IN connector.
- 3 Connect the recorder's AUDIO OUT connectors to the TV's AUDIO IN connectors.

2 Connect the recorder to mains.

Plug the end of the mains power cord into a mains outlet.

NOTES:

- You can obtain high-quality S-VHS pictures.
- If your TV is not stereo-capable, use the recorder's AUDIO OUT connectors to connect to an audio amplifier for Hi-Fi stereo sound reproduction. (☞ pg. 73)
- To operate the recorder with your TV using the S-VIDEO connection, set your TV to its AV mode.
- For switching the TV's mode, refer to the instruction manual of your television.

After the connection is completed, perform "Auto Set Up" on page 14.

Auto Set Up

Auto Channel Set/Auto Clock Set/ Auto Guide Program Number Set

After the $\psi/1$ button on the recorder or remote control is pressed for the first time to power on the recorder, by simply selecting your country*, the Auto Set Up function sets the tuner channels, clock** and Guide Program numbers automatically.

* If you live in Belgium (BELGIUM) or Switzerland (SUISSE), you also need to select your language.

* If you live in Hungary (MAGYARORSZÁG), Czech Republic (ČESKÁ REPUBLIKA), Poland (POLSKA) or other countries in Eastern Europe (OTHER EASTERN EUROPE), set the clock manually.

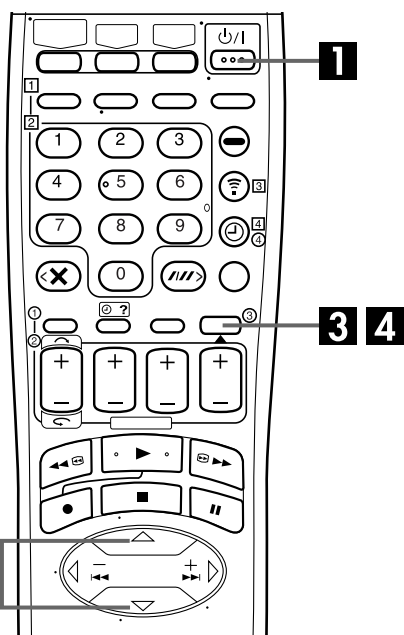

Before starting, make sure of the following:

- The TV aerial cable should be connected to the recorder.
- The recorder's mains power cord should be connected to a mains outlet.
- If you want to use the on-screen display, the TV should be set to its AV mode.

1 Turn on the recorder.

Press $\psi/1$ on the recorder or remote control. The Country Set display appears on the front display panel and/or on the TV screen.

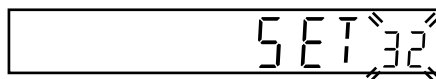

NOTE:

For a few seconds after you pressed $\psi/1$, you can not stop Auto Set Up, even if you press **MENU** to cancel this procedure.



2 Select your country.

On the front display panel

Press \triangle/∇ to select your international telephone country code of your country referring to the chart in the left column.

(Example) DEUTSCHLAND (49) is selected.

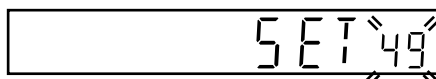

On the on-screen display

Press \triangle/∇ to move the highlight bar (pointer) to your country's name.



NOTES:

- If you have selected BELGIUM (32) or SUISSE (41), go to step 3.
- If you have selected MAGYARORSZÁG (36), ČESKÁ REPUBLIKA (42), POLSKA (48) or OTHER EASTERN EUROPE (EE), press **OK**. The Clock Set screen appears. Set the clock manually (pg. 88), then go to step 4.
- If you have selected any other country name (code), press **OK** and go to step 4.

International Telephone Country Code

BELGIUM	: 32	NORGE	: 47
ČESKÁ REPUBLIKA	: 42	ÖSTERREICH	: 43
DANMARK	: 45	POLSKA	: 48
DEUTSCHLAND	: 49	PORTUGAL	: 351
ESPAÑA	: 34	SUISSE	: 41
GREECE	: 30	SUOMI	: 358
ITALIA	: 39	SVERIGE	: 46
MAGYARORSZÁG	: 36	OTHER WESTERN EUROPE	: --
NEDERLAND	: 31	OTHER EASTERN EUROPE	: EE

3 Select the language.

Press **OK**. The Language Set display appears on the front display panel and/or on the TV screen.

On the front display panel

Press Δ / ∇ to select your language code.

Language Code			
ENGLISH	: 01	NEDERLANDS	: 06
DEUTSCH	: 02	SVENSKA	: 07
FRANCAIS	: 03	NORSK	: 08
ITALIANO	: 04	SUOMI	: 09
CASTELLANO	: 05	DANSK	: 10

(Example) DEUTSCH (02) is selected for SUISSE (41).

International telephone country code Language code

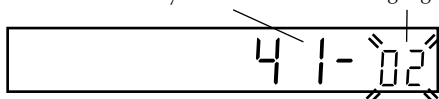

On the on-screen display

Press Δ / ∇ to move the highlight bar (pointer) to the language of your choice.



4 Perform Auto Set Up.

Press **OK**. The AUTO SET/T-V LINK display appears on the front display panel and/or on the TV screen.

On the front display panel

Press Δ / ∇ to select "Auto" and press **OK** or \triangleright .



On the on-screen display

Press Δ / ∇ to move the highlight bar (pointer) to "AUTO SET" and press **OK** or \triangleright .

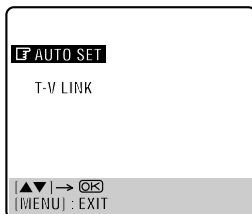

"Auto" blinks on the front display panel; do NOT press any button on the recorder or remote control until the front display panel shows clock time, "(CH) 1" or "--:--" as illustrated on page 17.

- If you are using the on-screen display, the AUTO SET screen will appear. As Auto Set Up progresses, the "█" mark on the TV screen moves from left to right. When the Auto Set Up is completed, "SCAN COMPLETED" appears for about 5 seconds, then the normal screen appears.

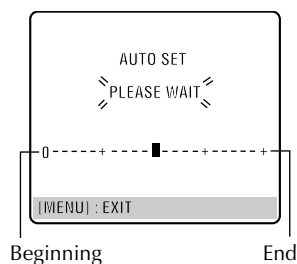

- If you have connected the recorder to a TV offering T-V Link via a 21-pin SCART cable (☞ pg. 12) and the TV is turned on, the recorder automatically performs "Preset Download" (☞ pg. 16) even if you select "Auto" in step 4.

ATTENTION

Once you have performed Auto Set Up, even if the recorder's memory backup has expired, all the stored stations and their Guide Program numbers remain in the recorder's memory and the recorder will not perform Auto Set Up again. You only need to set the clock. (☞ pg. 88)

If you have moved to a different area, perform each setting as required.

- Tuner Set (☞ pg. 80)
- Clock Set (☞ pg. 88)

If a new station starts broadcasting in your area, perform tuner setting (☞ pg. 80).

NOTES:

- In the area where no TV station transmits a PDC (Programme Delivery Control) signal, the recorder can perform neither Auto Clock Set nor Auto Guide Program Number Set.
- If there is a power cut, or if you press ⏻ or **MENU** while Auto Set Up is in progress, Auto Set Up will be interrupted; be sure to turn off the recorder power once and try again from step 1.
- Auto Clock Set may not function properly depending on the reception condition.
- If no sound accompanies the picture or the audio sounds unnatural on some channels that have been stored by Auto Set Up, the TV system setting for those channels may be incorrect. Select the appropriate TV system for those channels (☞ pg. 86, "INFORMATION").

Preset Download

Auto Channel Set by Downloading from TV/Auto Clock Set/Auto Guide Program Number Set

ATTENTION

You can use this function only with a TV offering T-V Link, etc.* Be sure to use a fully-wired 21-pin SCART cable.

* Compatible with TVs offering T-V Link, EasyLink, Megalocic, SMARTLINK, Q-Link or DATA LOGIC via fully-wired 21-pin SCART cable. The degree of compatibility and available functions may differ by system.

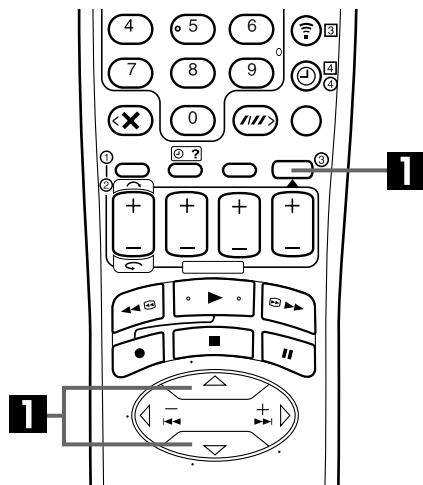

NOTES:

- For details, refer to the instruction manual of your TV.
- In the area where no TV station transmits a PDC (Programme Delivery Control) signal, the recorder can perform neither Auto Clock Set nor Auto Guide Program Number Set.
- If there is a power cut, or if you press $\mathcal{O}/1$ or **MENU** while downloading or set up is in progress, it will be interrupted; be sure to turn off the recorder power once and try again from the beginning.
- Auto Clock Set may not function properly depending on the reception condition.
- On this recorder, the characters available for station names (ID) are A-Z, 0-9, -, *, + and _ (space). Some names of downloaded stations may differ from those of your TV (see pg. 85).

If you have connected the recorder to your TV via a 21-pin SCART cable (see pg. 12), the recorder will automatically perform Preset Download instead of the Auto Set Up in step 4 on page 15. After downloading, the recorder sets the clock and Guide Program numbers automatically.

Perform steps 1 to 3 of "Auto Set Up" on page 14 before continuing.

1 Perform Preset Download.

Press **OK**. The AUTO SET/T-V LINK display appears on the front display panel and/or on the TV screen.

On the front display panel

Press Δ/∇ to select "CH --" and press **OK** or \triangleright .

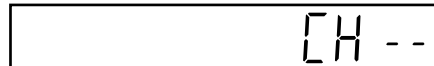

On the on-screen display

Press Δ/∇ to move the highlight bar (pointer) to "T-V LINK" and press **OK** or \triangleright .

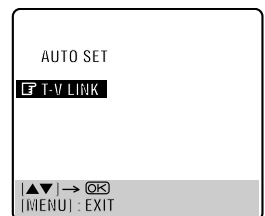

Preset positions on the front display panel increase from "CH1"; do NOT press any button on the recorder or remote control until the front display panel shows clock time, "(CH) 1" or "--:--" as illustrated on page 17.

- If you are using the on-screen display, the T-V LINK screen will appear. Then the GUIDE PROG SET screen will appear during Guide Program Number Set. When Preset Download is completed, "COMPLETED" appears for about 5 seconds, then the normal screen appears.
- If you press any button on the recorder or remote control while downloading is in progress, it will be interrupted.

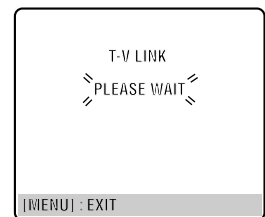

Results of Auto Set Up/Presets Download appear on the front display panel

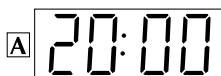

If both Auto Channel Set and Auto Clock Set have been performed successfully, the correct current time is displayed.

Turn on the TV and select its AV mode, then make sure that all necessary stations have been stored in the recorder's memory by using the **PR** button(s).

- If station names (ID – [pg. 87](#)) have also been stored in the recorder's memory, the station name will be displayed at the top left corner of the TV screen for about 5 seconds when the recorder is tuned to a different station.
- If you want to set the tuner manually such as to add or skip channels, to change channel positions, or to set or change station names, see pages 82 – 87.



If Auto Channel Set has succeeded but Auto Clock Set has not, "1" (channel position) is displayed.

- 1 Turn on the TV and select its AV mode, then make sure that all necessary stations have been stored in the recorder's memory by using the **PR** button(s).
 - If station names (ID – [pg. 87](#)) have also been stored in the recorder's memory, the station name will be displayed at the top left corner of the TV screen for about 5 seconds when the recorder is tuned to a different station.
 - If you want to set the tuner manually such as to add or skip channels, to change channel positions, or to set or change station names, see pages 82 – 87.
- 2 Perform "Clock Set" on page 88.

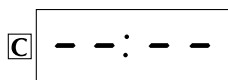

If both Auto Channel Set and Auto Clock Set have failed, "--:--" is displayed.

Make sure the cables are connected properly and turn off the recorder's power once, then turn the recorder's power back on again.

The Country Set display appears on the front display panel and/or on the TV screen; perform "Auto Set Up" on page 14 or "Preset Download" on page 16 again.

IMPORTANT

- To check if the Guide Program numbers have been set correctly, perform the SHOWVIEW Timer Programming ([pg. 42](#)).
- In certain reception conditions, station names may not be stored correctly, and auto Guide Program Number Set may not work properly. If the Guide Program numbers are not set properly when you timer-record a TV programme using the SHOWVIEW system, the recorder will record a TV programme of a different station. When programming the timer using the SHOWVIEW system, be sure to check the desired channel is selected correctly ([pg. 42](#), "SHOWVIEW" Timer Programming").
- Your video recorder memorizes all detected stations even if reception of some of them is poor. You can delete those stations with an unacceptable picture ([pg. 83](#), "Delete A Channel").

INFORMATION

Language for the on-screen display

Auto Set Up also selects the language automatically for the on-screen display depending on the Country setting you have made in step **2** on page 14 (unless you have selected BELGIUM or SUISSE), as shown below.

SUOMI	→ SUOMI	DANMARK	→ DANSK	NEDERLAND	→ NEDERLANDS
PORTUGAL	→ ENGLISH	ÖSTERREICH	→ DEUTSCH	GREECE	→ ENGLISH
DEUTSCHLAND	→ DEUTSCH	ČESKÁ REPUBLIKA	→ ENGLISH	OTHER WESTERN EUROPE	→ ENGLISH
POLSKA	→ ENGLISH	ITALIA	→ ITALIANO	OTHER EASTERN EUROPE	→ ENGLISH
NORGE	→ NORSK	MAGYARORSZÁG	→ ENGLISH		
SVERIGE	→ SVENSKA	ESPAÑA	→ CASTELLANO		

If you want to change the language setting manually, see "Language" on page 18.

Just Clock

Your recorder is equipped with the Just Clock function which provides accurate time keeping through automatic adjustments at regular intervals, by reading data from a PDC signal. If you want to take advantage of this function, simply set it to "ON" ([pg. 88](#), "Just Clock").

Language

Turn on the TV and select the AV mode.

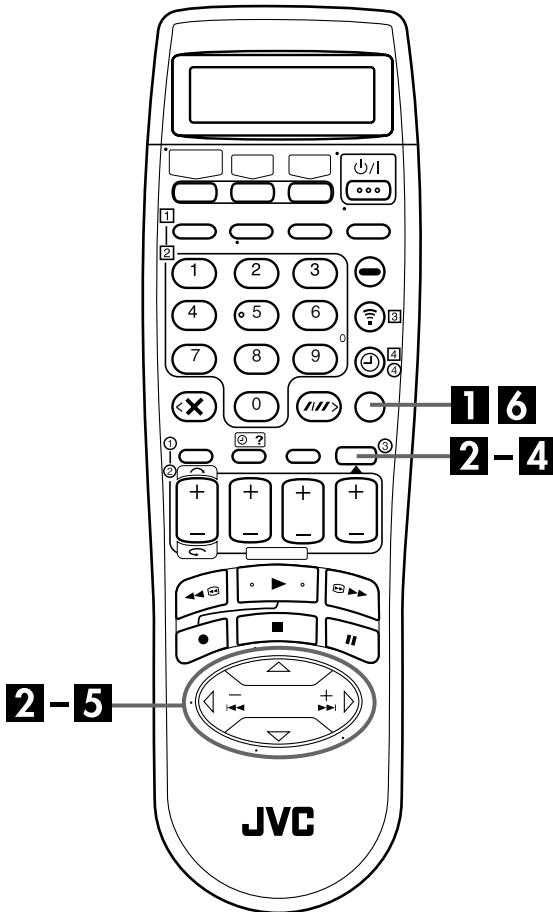

This recorder offers you the choice to view on-screen messages in 10 different languages. Though Auto Set Up selects the language automatically (pg. 17), you can change the language setting manually as required.

1 Access the Main Menu screen.

Press **MENU**.

2 Access the Tuner Set screen.

- Press \triangleleft \triangleright to move the arrow to "INITIAL SET UP", then press ∇ or **OK**.
- Press \triangleleft \triangleright to move the arrow to "TUNER SET", then press **OK**.

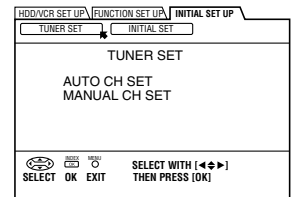

3 Access the Country Set screen.

Press \triangle ∇ to move the highlight bar (pointer) to "AUTO CH SET", then press **OK** or \triangleright .

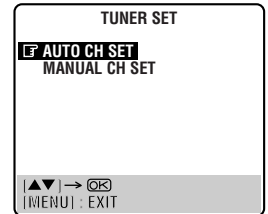

4 Select your country.

Press \triangle ∇ to move the highlight bar (pointer) to your country's name, then press **OK** or \triangleright .

5 Select the language.

Press \triangle ∇ to move the highlight bar (pointer) to the language of your choice.

- You do not have to press **OK**; pressing **OK** enters AUTO SET/T-V LINK screen.



6 Return to the normal screen.

Press **MENU**.

Satellite Receiver Control Setting

The following procedure is required if you receive satellite channels through a satellite receiver. Approximately 20 seconds before the SHOWVIEW timer programming (ⓘ pg. 42) or Express timer programming (ⓘ pg. 44) starts, the recorder sets its input mode to "L-2" and automatically switches the satellite receiver's channels using the provided Satellite Controller.

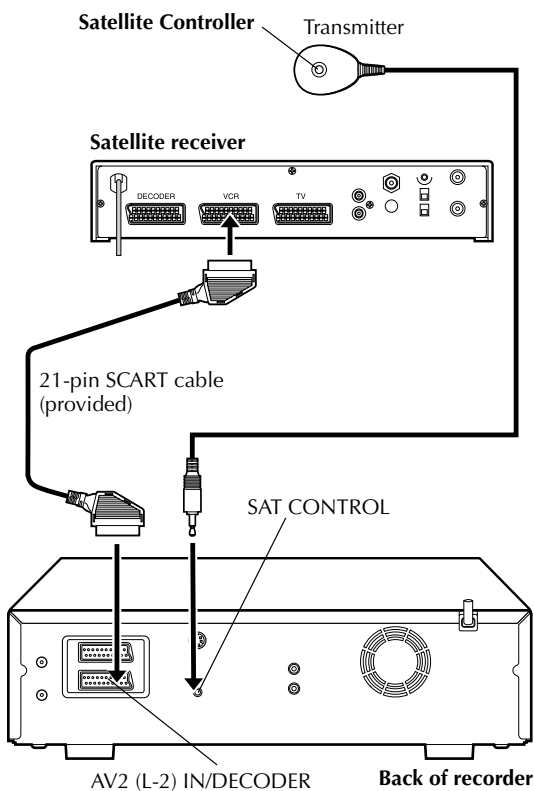
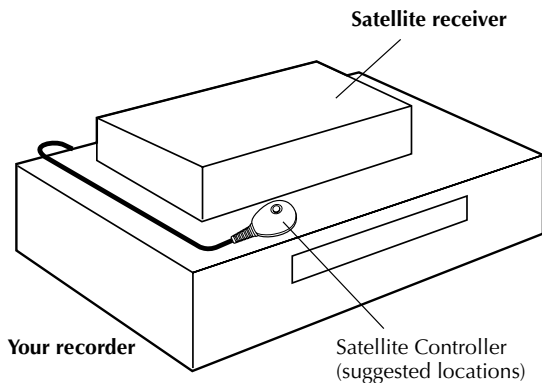

Installing Satellite Controller

1 Situate the Satellite Controller.

Place the Satellite Controller so that the path between its transmitter and the satellite receiver's remote sensor is unobstructed.

2 Attach the Satellite Controller.

Fix securely using the adhesive strip attached on the back of the Satellite Controller.

3 Make connections.

Be sure to connect the recorder's AV2 (L-2) IN/DECODER connector to the satellite receiver's 21-pin SCART connector.

NOTE:

When connecting your satellite receiver, refer to its instruction manual.

4 Connect the Satellite Controller to recorder.

Connect the Satellite Controller to the SAT CONTROL connector on the rear panel.

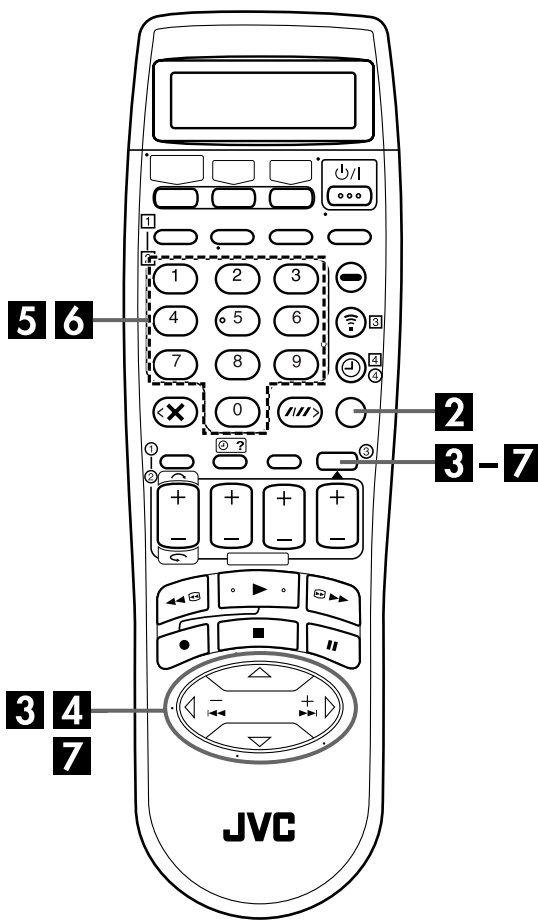

Setting satellite receiver's brand and channel

After installation, set the satellite receiver's brand and channel correctly; otherwise, the Satellite Controller cannot work correctly.

Turn on the TV and select the AV mode.

1 Turn on the satellite receiver.

Turn on the satellite receiver's power.

2 Access the Main Menu screen on the recorder.

Press MENU.

3 Access the Initial Set screen.

- Press \triangle ∇ to move the arrow to "INITIAL SET UP", then press ∇ or OK.
- Press \triangle ∇ to move the arrow to "INITIAL SET", then press OK.

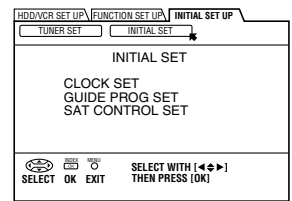

4 Access the Sat Control Set screen.

Press \triangle ∇ to move the highlight bar (pointer) to "SAT CONTROL SET", then press OK or \triangleright .

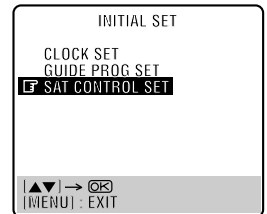

5 Enter the satellite receiver's brand.

Press the appropriate **number keys** to enter the brand code from the list on page 21, then press OK.

- If the brand code you entered is invalid, the code field will be reset. Enter the correct brand code again.
- If the recorder is in playback or recording mode, you cannot set the brand code.

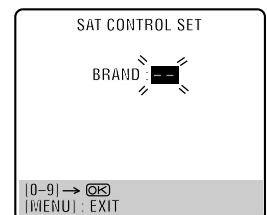

6 Select the satellite receiver's channel for testing.

Press the appropriate **number keys** to enter one of the channel positions on the satellite receiver, then press OK.

- You can select the channel position between 1 to 999.
- After pressing OK, the recorder enters the Test mode.

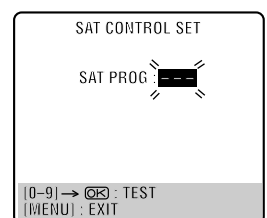

7 Check the result of the test.

If the satellite receiver's channel number has been changed to the same one as you set in step 6 ...

Press Δ / ∇ to move the highlight bar (pointer) to "CHANGED TO ...", then press **OK** or \triangleright to finish the Sat Control Set mode.

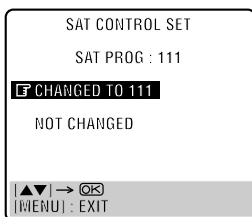

If the satellite receiver's channel number has not been changed correctly ...

Press Δ / ∇ to move the highlight bar (pointer) to "NOT CHANGED", then press **OK** or \triangleright . Then perform the procedure again from step 5.

BRAND NAME	CODE
JVC	73
AMSTRAD	60, 61, 62, 63, 92
CANAL SATELLITE	81
CANAL +	81
D-BOX	85
ECHOSTAR	78, 79, 80
ECHOSTAR (VIA DIGITAL)	82
FINLUX	68
FORCE	89
GALAXIS	88
GRUNDIG	64, 65
HIRSCHMANN	64, 78
ITT NOKIA	68
JERROLD	75
KATHREIN	70, 71
LUXOR	68
MASCOM	93
MASPRO	70
NOKIA	87
PACE	65, 67, 74, 86, 92
PANASONIC	74
PHILIPS	66, 84
RFT	69
SAGEM	83
SALORA	68
SIEMENS	64
SKYMASTER	69
TPS	83
TRIAX	91
WISI	64

NOTES:

- The Satellite Controller may not work with all types of satellite receiver.
- For some satellite receivers, you need to set its channel input mode to 2-digit.
- If your satellite receiver has more than two channel modes, be sure to set to "All Channel Mode". For details, refer to the instruction manual of the satellite receiver.
- When selecting the satellite receiver's channel (step 6), signals from the remote control may interfere with signals transmitted from the Satellite Controller. In this case, move the remote control as close to the recorder's infrared beam receiving window as possible.

T-V Link Functions

When you connect the recorder to your TV via a fully-wired 21-pin SCART cable (see pg. 12), the following functions are available. You can use these functions only with a TV offering T-V Link, etc.*

For details, refer to the instruction manual of your TV.

* Compatible with TVs offering T-V Link, EasyLink, Megalogic, SMARTLINK, Q-Link or DATA LOGIC via fully-wired 21-pin SCART cable. The degree of compatibility and available functions may differ by system.

TV Auto Power On

The TV will turn on and be set to its AV mode automatically whenever you play a tape.

For details, refer to the instruction manual of your TV.

VCR Auto Standby

You can use your TV's remote control to turn off the recorder.

For details, refer to the instruction manual of your TV.

Direct Rec

You can easily start recording the programme that you are watching on your TV. When you use this function, set "DIRECT REC" to "ON" (see pg. 78).

Basic Recording

- Turn on the TV and select the AV mode.
- If the recorder is turned on with HDD deck selected, there may be about 30 seconds' delay in starting to show pictures on the screen.

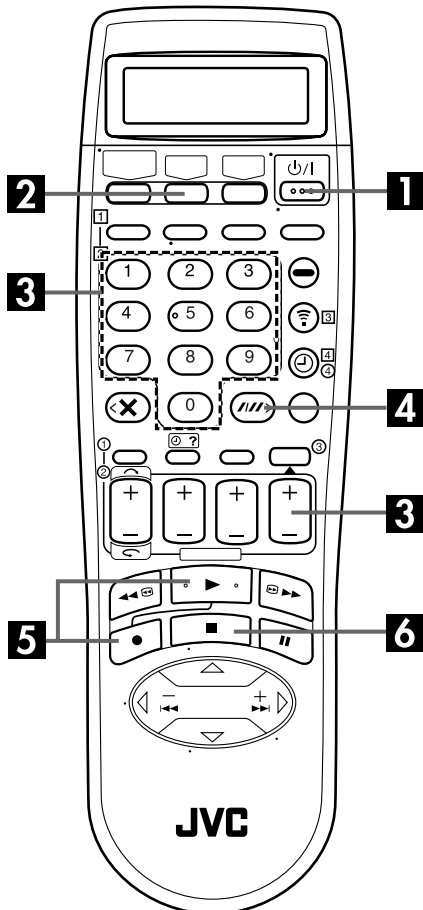
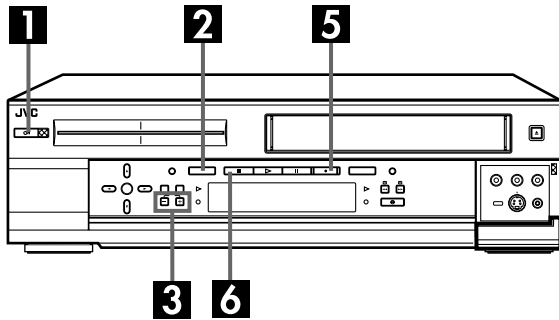

1 Turn on the recorder.

Press ψ/I .

- The button corresponding to the previously selected deck lights on the recorder.

2 Select the HDD deck.

Press **HDD**.

- The HDD button lights on the recorder.

3 Choose a programme.

Press **PR +/-** or the **number keys** to select the channel you wish to record.

- When you switch channels on the HDD deck, the picture appears a few seconds behind. It is not a malfunction.

4 Set the recording speed.

Press **MODE (//)**.

- For details on the recording speed, see page 23.

5 Start recording.

Press and hold \bullet and press \blacktriangleright on the remote control, or press \bullet on the recorder.

- The HDD recording indicator lights on the recorder.

6 Stop recording.

Press \blacksquare .

- The HDD recording indicator turns off.
- There may be a few seconds' delay in resuming normal screen. It is not a malfunction.

NOTES:

- It is not possible to record a TV programme on both the HDD deck and the VHS deck simultaneously. In addition, it is not possible to record simultaneously from the same external input.
- It is not possible to pause recording on the HDD deck while recording from the channels other than "L-1", "F-1", "DUB". (pg. 59, 63)
- While recording a programme, you can play back the previously recorded part by "Live Memory Playback" (pg. 26).

Basic Playback

- Turn on the TV and select the AV mode.
- If the recorder is turned on with HDD deck selected, there may be about 30 seconds' delay in starting to show pictures on the screen.

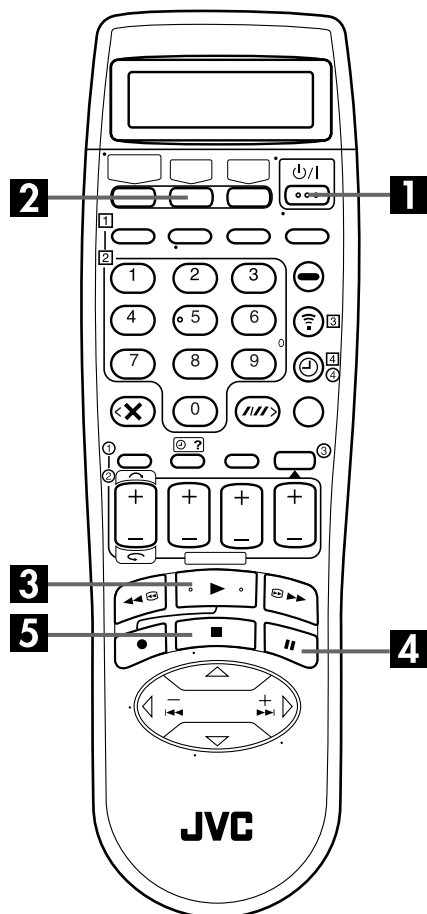
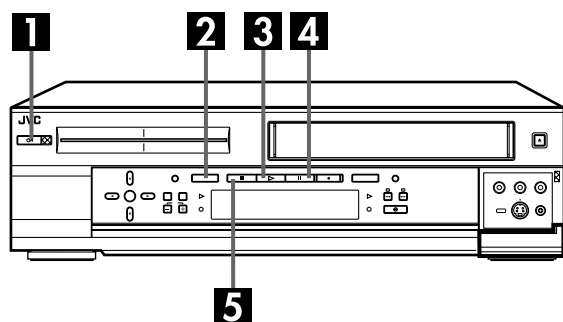

1 Turn on the recorder.

Press $\psi/1$.

- The button corresponding to the previously selected deck lights on the recorder.

2 Select the HDD deck.

Press **HDD**.

- The HDD button lights on the recorder.

3 Start playback.

Press \blacktriangleright .

- The HDD playback indicator lights on the recorder.

One of the following screens will appear:

- the programme which has been recorded on the HDD deck at last time and has not been played back yet
- the programme which has been stopped during playback
- the HDD Navigation screen (☞ pg. 24)
- There are some programmes for demonstration on the HDD deck when it is shipped from the factory.

4 Pause playback.

Press **II**.

- To resume normal playback, press \blacktriangleright .

5 Stop playback.

Press **■**.

- The HDD playback indicator turns off.

NOTE:

While recording a programme, you can play back the previously recorded part by "Live Memory Playback" (☞ pg. 26).

Recording Speed on the HDD deck

This recorder has a 40 Gbyte hard disk drive. The pictures and sounds recorded on the HDD deck and other information are written down on the hard disk drive.

As recording format for the HDD deck, MPEG2 format, the same for DVD, is used. As a guide for picture quality, the "bps" unit is used to represent how much data can be recorded per second. The larger this value, the better the picture quality is but the more capacity is required for recording. Select SP for programmes where quick movement occurs, such as sports programmes, and SEP for talk shows, etc. where relativity less movement.

The recording speeds of the recorder are set as follows:

Recording speed	Recording amount (approx.)	Maximum recording time (approx.)
SP	6.4 Mbps	14 hours
LP	4.5 Mbps	20 hours
EP	3.2 Mbps	28 hours
SEP	2.2 Mbps	40 hours

Playback with HDD Navigation

The HDD Navigation enables you to search and select the desired programmes recorded on the HDD deck very easily. There is a 40 Gbyte hard disk drive on this recorder. You can record up to 60 programmes for the HDD deck.

Each time a programme is recorded on the HDD deck, the information of the programme are registered for the HDD Navigation automatically.

So, you can confirm the information of the programmes recorded on the HDD with the HDD Navigation screen. And, you can also select one of the programmes recorded on the HDD deck using the HDD Navigation.

The following screen appears as the HDD Navigation screen when you press **NAVIGATION** with the HDD deck selected. You can move the arrow to select the desired position on the screen by pressing \triangle \triangleright \triangleright \triangleright on the remote control (or \blacktriangleleft \blacktriangleright \blacktriangleright \blacktriangleright on the recorder).

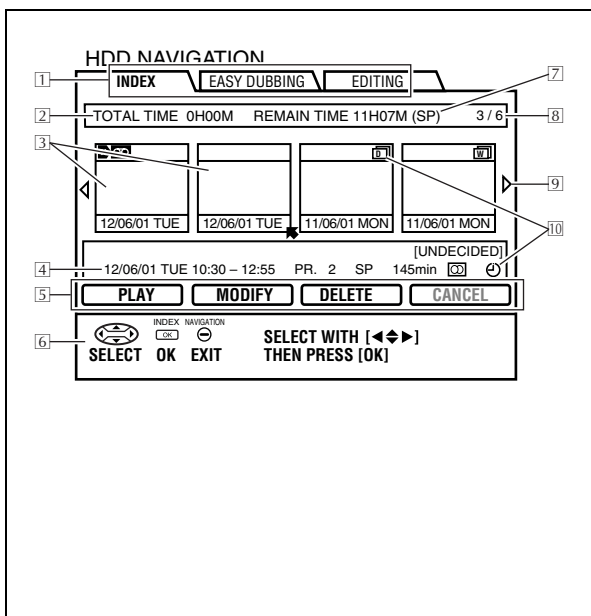







The screenshot shows the HDD Navigation screen with the following elements:

- 1**: Names of functions: INDEX, EASY DUBBING, EDITING.
- 2**: Total time for the selected programme(s): TOTAL TIME 0H00M.
- 3**: Index: A grid of small still pictures representing recorded programmes.
- 4**: Recording information for the programme indicated by the arrow: 12/06/01 TUE 10:30 - 12:55 PR. 2 SP 145min.
- 5**: Operational commands: PLAY, MODIFY, DELETE, CANCEL.
- 6**: Guidance for operations: SELECT WITH [LEFT/RIGHT] THEN PRESS [OK].
- 7**: Remaining time: REMAIN TIME 11H07M (SP).
- 8**: Current/Total number of programme(s): 3 / 6.
- 9**: This mark appears when there are over 4 registered programmes.
- 10**: Icons: Small icons indicating recording situations for each programme.

- 1 Names of functions
INDEX (☞ pg. 25)
EASY DUBBING (☞ pg. 56)
EDITING (☞ pg. 60)
- 2 Total time for the selected programme(s)
- 3 Index
(Small still picture of the each programme)
- 4 Recording information for the programme indicated by the arrow
- 5 Operational commands
- 6 Guidance for operations
- 7 Remaining time
(Based on the recording speed currently selected)
- 8 Current/Total number of programme(s)
(For example, there are 6 recorded programmes and the programme indicated by the arrow is the 3rd one.)
- 9 This mark appears when there are over 4 registered programmes.
(By pressing \triangleleft \triangleright (or \blacktriangleleft \blacktriangleright), you can select the other programme.)
- 10 Icons
(Indicate the recording situation for each programme.)

The Icons and their meanings

	You cannot dub this programme from the HDD deck to the VHS deck.
	This programme was recorded with daily mode of timer recording.
	This programme was recorded with weekly mode of timer recording.
	This programme has stereo sounds.
	This programme has bilingual sounds.
	This programme was recorded with timer recording.

Scan for Beginning(s) of Programme(s)

- Turn on the TV and select the AV mode.
- If the recorder is turned on with HDD deck selected, there may be about 30 seconds' delay in starting to show pictures on the screen.

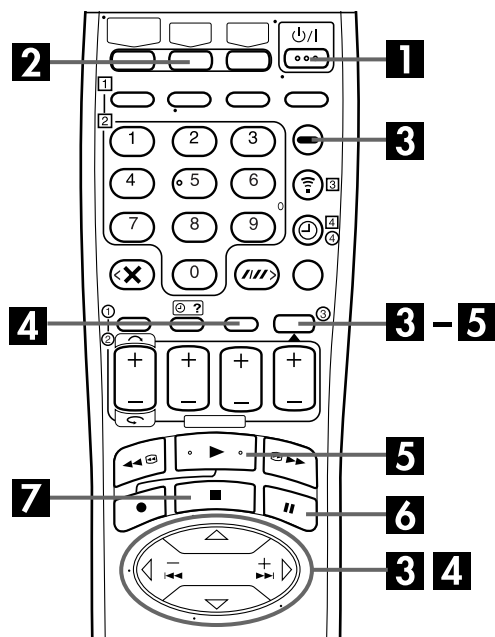

You can scan the beginning of the programme easily with the HDD Navigation.

3 Access the Index screen.

- 1 Press **NAVIGATION**. The HDD Navigation screen appears.
- 2 Confirm that "INDEX" screen appears. Then, press **▽** or **OK**.

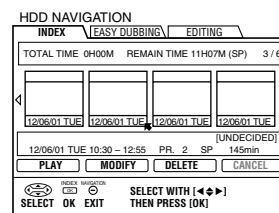

4 Select the programme(s).

Press **◀▶** to move the arrow on the index (small still pictures) of the desired programme.

- When you want the plural programmes to be played back continuously, press **MEMO** after selecting the desired programme. The numbers of the playback order appear on the index. You can select up to 8 programmes.
- When you want to correct the order, move the arrow on the desired index and press **MEMO**. The number disappears and the recorder re-numbers the other programmes automatically.
- When you want to cancel the order, move the arrow to "CANCEL" and press **OK**.

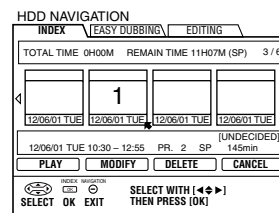

5 Start playback.

Press **OK** to move the arrow to "PLAY" on the Index screen, then press **OK** again. Or simply press **▶**. The playback starts.

6 Pause playback.

- Press **⏸**.
- To resume normal playback, press **▶**.

7 Stop playback.

Press **■**.

1 Turn on the recorder.

Press **⏻/I**.

2 Select the HDD deck.

Press **HDD**.

Live Memory Playback

Equipped with a hard disk drive, this recorder allows information to be written to and read from the hard disk at high speeds. Taking advantage of this feature, you can temporarily record programmes received with the tuner or from an externally connected equipment, and can watch them only a few seconds behind actual air time.

In this recorder, viewing a programme through HDD (not a recorded programme) means you are always watching the programme temporarily recorded on it. This feature enables you to reverse the programme back to view any previous part of it. This is called "Live Memory Playback", which was impossible until now. You can select the length of the time for temporary recording from off, 30 minutes, 1 hour, and 3 hours (☞ pg. 75).

About "Live Memory Playback"

With a certain amount of space (for 30 minutes, 1 hour and 3 hours) reserved on the hard disk, the recorder records broadcasts being received or signals input from an externally connected equipment.

Even while you are reversing the programme to review any previous part, the recorder continues recording the same programme or externally-input signals.

NOTE:

When the reserved amount of time (or space) runs out, the recorder overwrites the previous recordings on the hard disk, starting with the oldest one, repeatedly if necessary. After having recorded a certain number of programmes, if you try to increase the amount of your reserved time on HDD, you may not be allowed to do so because of possible lack of available space, and the recorder will inform you of this by displaying a message on the screen.

- Turn on the TV and select the AV mode.
- If the recorder is turned on with HDD deck selected, there may be about 30 seconds' delay in starting to show pictures on the screen.

1 Turn on the recorder.

Press \odot /I.

2 Select the HDD deck.

Press **HDD**.

3 Choose a programme.

Press **PR +/-** or the **number keys** to select the channel you wish to record.

- The temporary recording begins.

4 Start Live Memory Playback.

Press \triangleleft or \blacktriangleleft to search for the previous part of the programme, then press \blacktriangleright .

5 Stop Live Memory Playback.

Press \blacksquare .

- The on-air screen resumes.

NOTES:

- You can use various playback features during Live Memory Playback. (☞ pg. 27)
- If you have started actual recording by pressing \bullet , pressing \blacksquare in step 5 only resumes the on-air screen. To stop actual recording, press \blacksquare again.

About limitation on Live Memory Playback

The temporary recording for Live Memory is canceled in the following cases, and will start all over again when it is to resume.

- When channels are changed
- When the power is turned off
- When the thumbnails are changed
- When the setting for Live Memory playback is changed
- When recording is started via the HDD deck or the VHS deck
- When a recorded programme is played back or deleted

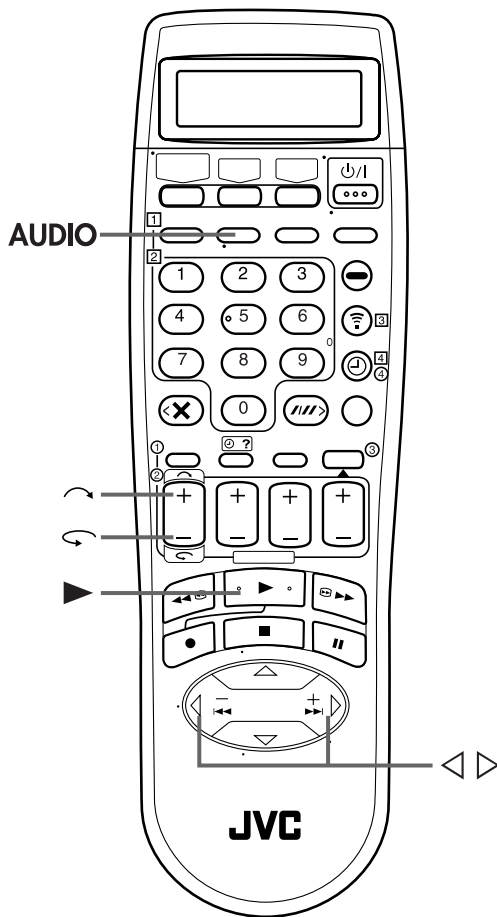

Quick Rewind a little

During playback (or Live Memory Playback), press \leftarrow (START -). The recorder rewinds the picture a little (about 7 seconds) and resumes playback.

- If the button is pressed repeatedly, the recorder rewinds the pictures continuously and resumes playback.

Quick Skip Forward

During playback (or Live Memory Playback), press \rightarrow (START +). The recorder skips forward (about 30 seconds at a time) and resumes playback.

- If the button is pressed repeatedly, the recorder skips continuously and resumes playback.

Repeat Playback

Your recorder can automatically play back the whole programme 100 times repeatedly.

During playback, press \blacktriangleright and hold for over 5 seconds, then release.

- The Play indicator (\blacktriangleright) on the front display panel and the HDD playback indicator blink slowly.
- To resume normal playback, press \blacktriangleright .

NOTE:

Repeat playback is not possible during Live Memory Playback.

Soundtrack Selection

The HDD deck can record 2 soundtracks (L and R).

During Playback

Pressing **AUDIO** changes the soundtrack as follows:

TRACK	USE
On-Screen Display	
	For stereo programme
	For monaural programme
	For main audio of bilingual programme
	For sub audio of bilingual programme
	For NICAM stereo programme
	For NICAM monaural programme
	For NICAM main audio of bilingual programme
	For NICAM sub audio of bilingual programme
	For NICAM FM programme
	For AUX input sounds (L+R)
	For AUX input sound (L)
	For AUX input sound (R)

Variable Speed Search

During playback (or Live Memory Playback), press \triangleright for forward variable-speed search, or \triangleleft for reverse variable-speed search.

- The playback speed changes for each direction by pressing \triangleright or \triangleleft repeatedly. Refer to the illustration below.
- To resume normal playback, press \blacktriangleright .

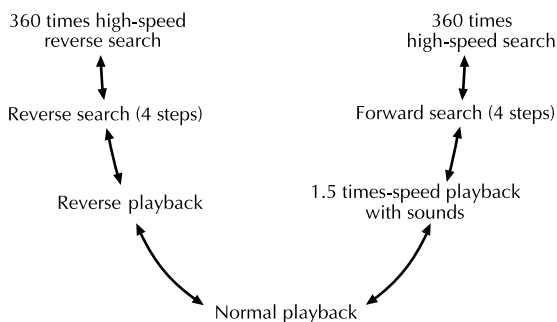

Recording Features

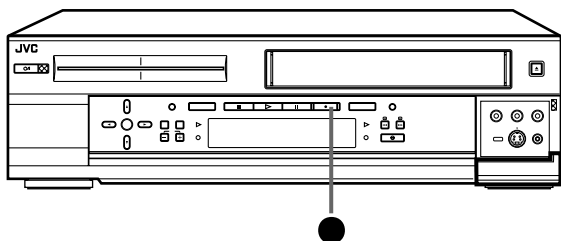

Record One Programme While Watching Another

Once recording is in progress, all you need to do is to set the channel controls on the TV for the station you wish to view.

- The programme selected with the TV's channel controls appears on the TV screen, while the one selected with the recorder's **PR** buttons is recorded on the tape.
- If a decoder is connected to the recorder (see pg. 72), you can select a scrambled channel as well with the TV channel controls.

Instant Timer Recording (ITR)

This easy method lets you record for from 30 minutes to 6 hours (selectable in 30-min. increments), and shuts the recorder off after recording is finished.

1 Start recording.

Press **R** on the recorder.

2 Engage the ITR mode.

Press **R** again. "ITR" blinks and "0:30" appears on the front display panel.

3 Set the recording duration.

If you want to record for more than 30 minutes, press **R** to extend the time. Each press extends recording time by 30 minutes.

NOTE:

You can only perform ITR using the **R** button on the recorder's front panel.

Receiving Stereo and Bilingual Programmes

Your recorder is equipped with a Sound-Multiplex decoder (A2) and a Digital stereo sound decoder (NICAM) making reception of stereo and bilingual broadcasts possible.

When the channel is changed, the type of broadcast being received will be displayed on the TV screen for a few seconds.

Type of Broadcast Being Received	On-screen Display
A2 Stereo	
A2 Bilingual	
Regular Monaural	
NICAM Stereo	
NICAM Bilingual	
NICAM Monaural	
NICAM FM Sound	

NOTE:

"O.S.D." must be set to "ON" or the on-screen displays will not appear (see pg. 78).

To Record Stereo and Bilingual Programmes (A2)

Stereo programmes are automatically recorded in stereo.

- Bilingual programmes are automatically recorded in bilingual.

To Record NICAM Bilingual Programmes

Set "AUDIO REC" to "NICAM" to record the NICAM bilingual programme (see pg. 75).

NOTES:

- If the quality of stereo sound being received is poor, the broadcast will be received in monaural with better quality.
- Before playing back a programme recorded in stereo, or a bilingual programme, refer to "Soundtrack Selection" on page 28.

Basic Recording

- Turn on the TV and select the AV mode.
- If the recorder is turned on with HDD deck selected, there may be about 30 seconds' delay in starting to show pictures on the screen.

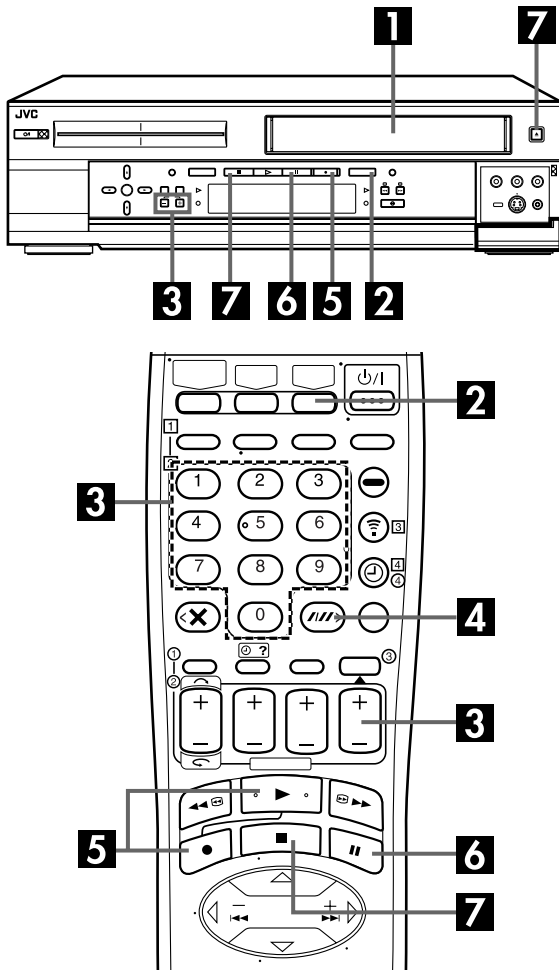

NOTE:

It is not possible to record a TV programme on both the HDD deck and the VHS deck simultaneously. In addition, it is not possible to record simultaneously from the same external input.

1 Load a cassette.

Insert a cassette with the record safety tab intact. Make sure the window side is up, the rear label side is facing you and the arrow on the front of the cassette is pointed toward the recorder.

- Do not apply too much pressure when inserting.
- The recorder's power comes on automatically.
- While "----" is blinking on the front display panel, the tape will run for a few seconds to search for the tape number.
- If you want to use VCR Navigation to select the programme after recording with this recorder, set "NAVIGATION" to "ON" (☞ pg. 75).

2 Select the VHS deck.

Press **S-VHS**.

- The S-VHS button lights on the recorder.

3 Choose a programme.

Press **PR +/-** or the **number keys** to select the channel you wish to record.

4 Set the tape speed.

Press **MODE (///)**. Check the SP/LP/EP indicator on the recorder's front display panel to confirm the selected tape speed.

- In EP mode, the recording time is extended three times.
- If you record a programme in EP mode on this recorder, it is recommended to play back the EP-recorded tape on this recorder.
- It is not possible to select EP mode if "COLOUR SYSTEM" is set to "MESECAM". (☞ pg. 76)

5 Start recording.

Press and hold **●** and press **▶** on the remote control, or press **●** on the recorder.

- The VHS recording indicator lights on the recorder.

B.E.S.T. takes place at the beginning of both the first SP and the first LP (or EP) recording after inserting the cassette. (☞ pg. 41)

If "DIRECT REC" is set to "ON", the programme that appears on the TV screen will be recorded (☞ pg. 78).

6 Pause/Resume recording.

Press **||**. Press **▶** to resume recording.

7 Stop recording.

Press **■**. Then press **▲** to remove the cassette.

Basic Playback

- Turn on the TV and select the AV mode.
- If the recorder is turned on with HDD deck selected, there may be about 30 seconds' delay in starting to show pictures on the screen.

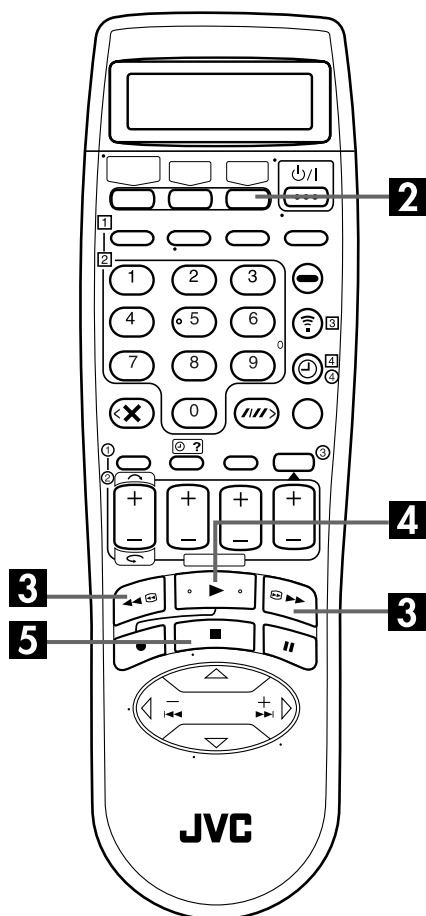
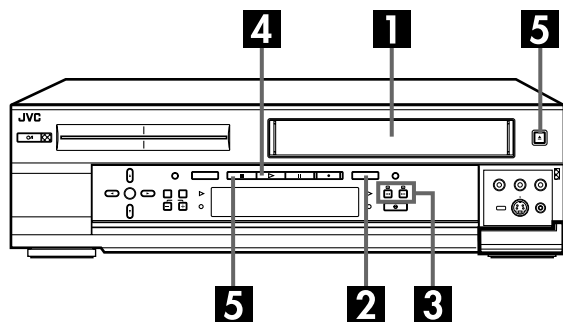

1 Load a cassette.

Make sure the window side is up, the rear label side is facing you and the arrow on the front of the cassette is pointed toward the recorder.

- Do not apply too much pressure when inserting.
- The recorder's power comes on automatically.
- While "----" is blinking on the front display panel, the tape will run for a few seconds to search for the tape number.
- If the record safety tab has been removed, playback begins automatically.

2 Select the VHS deck.

Press **S-VHS**.

- The S-VHS button lights on the recorder.

3 Find the programme start point.

If the tape is advanced past the start point, press ◀◀. To go forward, press ▶▶.

4 Start playback.

Press ▶. "BEST" appears blinking in the recorder's front display panel during automatic tracking. (☞ pg. 41)

- The VHS playback indicator lights on the recorder.

5 Stop playback.

Press ■. Then press ▲ to remove the cassette.

Usable cassettes

- Compact VHS camcorder recordings can be played on this video recorder. Simply place the recorded cassette into a VHS Cassette Adapter and it can be used just like any full-sized VHS cassette.
- This video recorder can record on regular VHS and Super VHS cassettes. While only VHS signals can be recorded on regular VHS cassettes*, both VHS and Super VHS signals can be recorded and played back using Super VHS cassettes.

* By using the S-VHS ET function, it is possible to record and play back with S-VHS picture quality on VHS cassettes with this recorder.

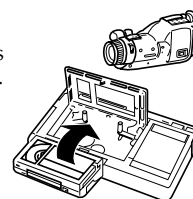

Playback with VCR Navigation

The VCR Navigation enables you to search and select the desired programmes recorded on the VHS deck very easily.

When you record a programme with the VHS deck for more than 8 minutes in SP mode (for more than 15 minutes in LP mode or for more than 23 minutes in EP mode) with "NAVIGATION" set to "ON" (pg. 75), its information are registered for the VCR Navigation automatically.

When the first programme is recorded on a cassette, the VCR Navigation gives the register number to the cassette. The VCR Navigation memorizes the cassette by the number. You can confirm the register number of the cassette when the cassette is loaded or ejected.

The VCR Navigation can register up to 2000 programmes or up to 680 cassettes.

The following screen appears as the VCR Navigation screen when you press **NAVIGATION** with the VHS deck selected. You can move the arrow to select the desired position on the screen by pressing \triangle ∇ \rightarrow \leftarrow on the remote control (or \blacktriangle \blacktriangleright \blacktriangledown on the recorder).

The screenshot shows the VCR Navigation screen with the following elements and callouts:

- 1: Loaded cassette number (0001)
- 2: Date when the loaded cassette registered (12/06/01 TUE)
- 3: Index (represented by a small still picture icon)
- 4: Operational commands (PLAY, STOP, MODIFY, DELETE)
- 5: 3 ways to navigate (DATE, CATEGORY, CASSETTE #)
- 6: Total time and blank time of the loaded cassette (120M, BLANK, 87M (SP))
- 7: Recording information for the programme indicated by the arrow (12/06/01 TUE, 12:00 - 12:30, PR. 8, SP, 30min)
- 8: Icons (UNDECIDED, [UNDECIDED])
- 9: Guidance for operations (SELECT WITH [←→], THEN PRESS [OK])

The Icons and their meanings

	This programme has a little gap at the beginning.
	This programme has stereo sounds.
	This programme has bilingual sounds.
	This programme was recorded with Timer recording.

Scan for Beginning of Programme with VCR Navigation

The VCR Navigation can take effect for the programme which has been recorded, and whose information has been registered with this recorder. Once the VHS (S-VHS) cassettes have been used for recording with this recorder, they have the register number given by this recorder.

- Turn on the TV and select the AV mode.
- If the recorder is turned on with HDD deck selected, there may be about 30 seconds' delay in starting to show pictures on the screen.

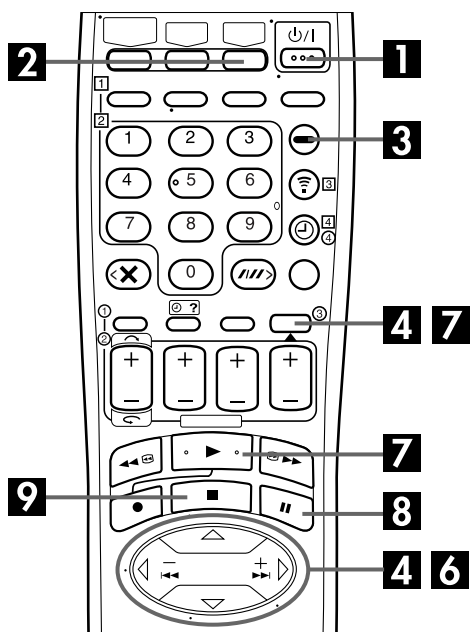

1 Turn on the recorder.

Press **1**.

2 Select the VHS deck.

Press **2**.

3 Access the VCR Navigation screen.

Press **3**. The VCR Navigation screen appears.

- If a registered cassette has been loaded, the contents of the loaded cassette will appear. To select the programme from the loaded cassette, go to step **6**.

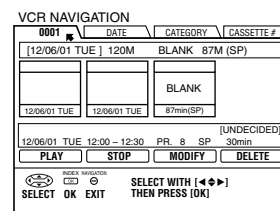

4 Search for the programme.

Press **4** to move the arrow to select one of the 3 search types, then press **OK** or **▽**.

- 1 Select "DATE" if you want to search for the registered programme by the recording date.
- 2 Select "CATEGORY" if you want to search for the registered programme by the category in which you have classified the programme.
- 3 Select "CASSETTE #" if you want to search for the programme by each registered cassette.

5 Load the cassette.

After you have found the programme and checked its cassette number, insert the cassette.

6 Select the programme.

Press **6** to move the arrow on the index (small still pictures) of the desired programme.

7 Start playback.

Press **OK** to move the arrow to "PLAY" on the Index screen, then press **OK** again. Or simply press **▶**. The playback starts.

8 Pause playback.

Press **II**.

- To resume normal playback, press **▶**.

9 Stop playback.

Press **■**.

Playback Features

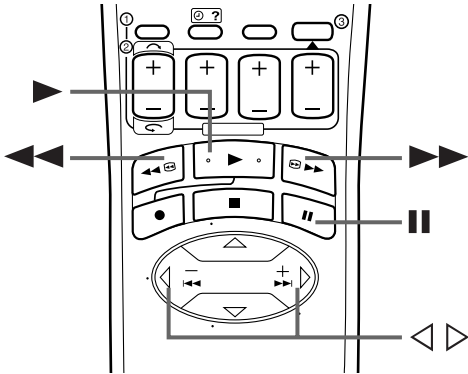

ATTENTION

- Picture may not appear during high-speed search with an LP/EP-recorded tape.
- Noise may appear or the picture may appear distorted with an EP-recorded tape during still, slow motion, frame-by-frame playback or variable speed search.
- In the high-speed search, still, slow motion or frame-by-frame playback mode, the picture will be distorted, and there will be a loss of colour.
- When normal playback resumes from search, still, slow motion or frame-by-frame playback, the picture may jitter vertically momentarily depending on the type of TV being used.

Clean the video heads using a dry cleaning cassette — TCL-2UX — when:

- Rough, poor picture appears while a tape is played back.
- The picture is unclear or no picture appears.
- "USE CLEANING CASSETTE" appears on the screen (only with "O.S.D." set to "ON" (pg. 78)).

High-Speed Search

During playback or still, press ►► for forward high-speed search, or ◀◀ for reverse high-speed search.

- To resume normal playback, press ►.

NOTE:

For short searches, press and hold ►► or ◀◀ for over 2 seconds during playback or still picture. When released, normal playback resumes.

Still Picture/Frame-By-Frame Playback

1 Pause during playback.

Press II.

2 Activate frame-by-frame playback.

Press II repeatedly to advance one frame at a time.

OR

Press II for over 2 seconds to start frame-by-frame playback.

- To resume normal playback, press ►.

Slow Motion

1 Pause during playback.

Press II.

2 Activate slow motion playback.

Press and hold ▷ or ◁ for over 2 seconds.

- The playback speed changes for each direction by pressing ▷ or ◁ repeatedly.
- To resume normal playback, press ►.

Variable Speed Search

During playback, press ▷ for forward variable-speed search, or ◁ for reverse variable-speed search.

- The playback speed changes for each direction by pressing ▷ or ◁ repeatedly. Refer to the illustration below.
- To resume normal playback, press ►.

Reverse search (3 steps)

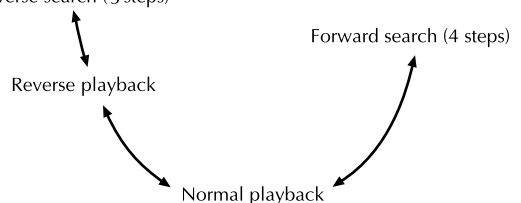

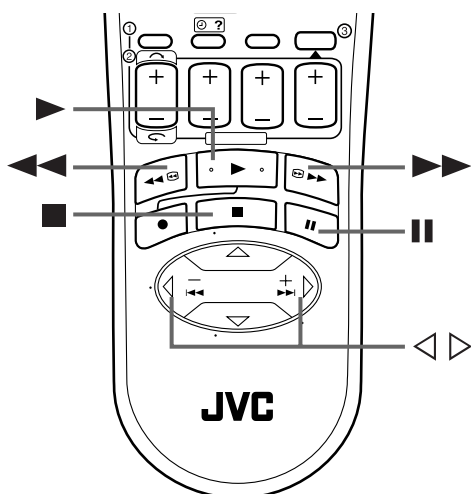

Repeat Playback

Your recorder can automatically play back the whole tape 100 times repeatedly.

1 Start playback.

Press ►.

2 Activate Repeat Playback.

Press ► and hold for over 5 seconds, then release.

- The Play indicator (▶) on the front display panel and the VHS play indicator blink slowly.
- After playing back a tape 100 times, the recorder stops automatically.

3 Stop Repeat Playback.

Press ■ at any time.

- Pressing ►, ◀, ▶ or || also stops Repeat Playback.

NOTE:

Repeat playback is not possible with a cassette recorded in EP mode.

Index Search

Your recorder automatically marks index codes at the beginning of each recording. This function gives you quick access to any one of 9 index codes in either direction.

NOTE:

Before starting, make sure the recorder is in the Stop mode.

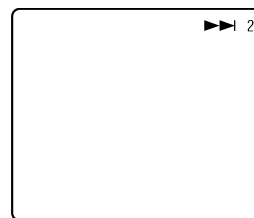

Activate Index Search.

Press ◀ or ▶ (◀◀ or ▶▶). "◀◀ 1" or "▶▶ 1" is displayed on the TV screen and search begins in the corresponding direction.

- To access index codes 2 through 9, press ◀ or ▶ repeatedly until the correct index number is displayed.

Example:

To locate the beginning of B from the current position, press ◀ twice.

To locate the beginning of D from the current position, press ▶ once.

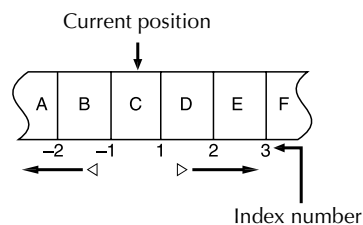

- When the specified index code is located, playback begins automatically.

Next Function Memory

The Next Function Memory "tells" the recorder what to do after rewinding. Before continuing, make sure the recorder is in the Stop mode.

- For Automatic Start Of Playback
Press ◀◀, then press ► within 2 seconds.
- For Automatic Cassette Ejection After Tape Rewind
Press ◀◀, then press ▲ within 2 seconds.

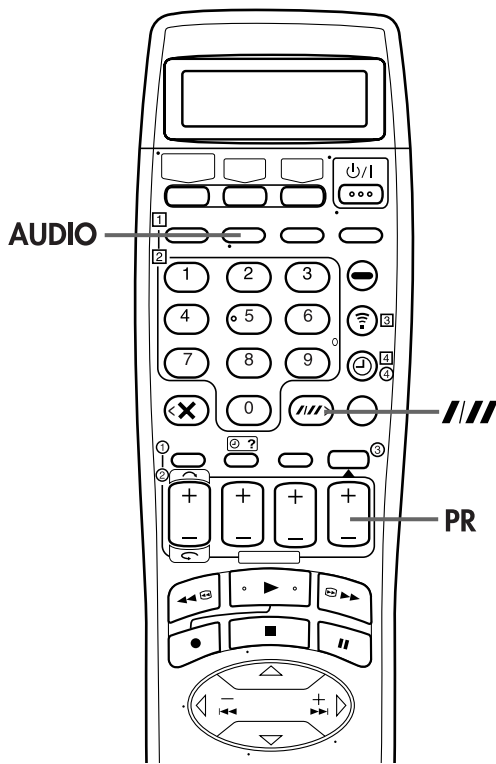

Soundtrack Selection

Your recorder is capable of recording three soundtracks (HI-FI L, HI-FI R and NORM) and will play back the one you select.

During Playback

Pressing **AUDIO** changes the soundtrack as follows:

TRACK	USE
On-Screen Display	
HI FI L R	For Hi-Fi stereo tapes
HI FI L	For main audio of Bilingual tapes
HI FI R	For sub audio of Bilingual tapes
NORM	For audio-dubbed tapes
HI FI NORM	For audio-dubbed tapes

NOTES:

- "HI FI L R" should normally be selected. In this mode, Hi-Fi stereo tapes are played back in stereo, and the normal audio track is played back automatically for tapes with only normal audio.
- For instructions on recording stereo and bilingual programmes, refer to page 40.
- "O.S.D." must be set to "ON" or the on-screen displays will not appear (pg. 78).

Manual Tracking

Your recorder is equipped with automatic tracking control. During playback, you can override this and adjust the tracking manually by pressing the **PR** buttons.

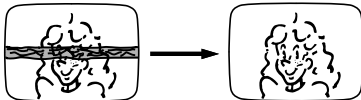

1 Override automatic tracking.

Press on the remote control.

2 Adjust the tracking manually.

Press **PR +** or **-**.

- Press again to return to automatic tracking.

NOTE:

When a new tape is inserted, the recorder enters the automatic tracking mode automatically.

Recording Features

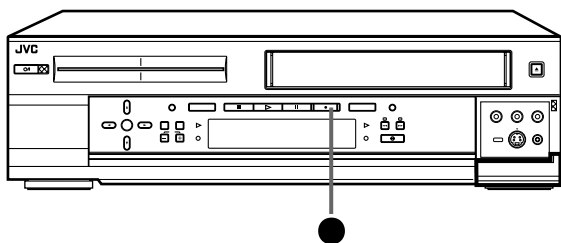

Recording Resume Function

If there is a power outage during recording, Instant Timer Recording (in the right column) or timer recording (pg. 42, 44), the recording will resume automatically when power is restored to the recorder unless the recorder's memory backup has expired.

Accidental erasure prevention

To prevent accidental recording on a recorded cassette, remove its safety tab. To record on it later, cover the hole with adhesive tape.

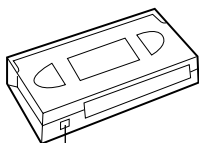

Record safety tab

Record One Programme While Watching Another

Once recording is in progress, all you need to do is to set the channel controls on the TV for the station you wish to view.

- The programme selected with the TV's channel controls appears on the TV screen, while the one selected with the recorder's **PR** buttons is recorded on the tape.
- If a decoder is connected to the recorder (pg. 72), you can select a scrambled channel as well with the TV channel controls.

Instant Timer Recording (ITR)

This easy method lets you record for from 30 minutes to 6 hours (selectable in 30-min. increments), and shuts the recorder off after recording is finished.

1 Start recording.

Press ● on the recorder.

2 Engage the ITR mode.

Press ● again. "○" blinks and "0:30" appears on the front display panel.

3 Set the recording duration.

If you want to record for more than 30 minutes, press ● to extend the time. Each press extends recording time by 30 minutes.

NOTE:

You can only perform ITR using the ● button on the recorder's front panel.

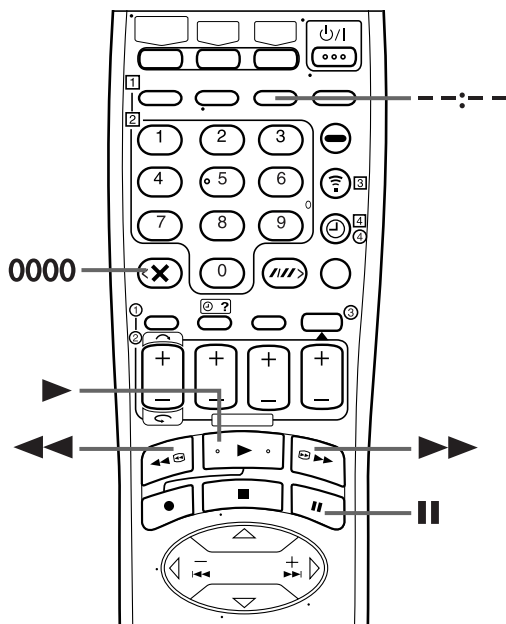

Elapsed Recording Time Indication

1 Set the counter display.

Press **--:--** until a counter reading appears on the front display panel.

2 Reset the counter.

Press **0000** before starting recording or playback.

- The counter is reset to "0:00:00" and shows the exact elapsed time as the tape runs. You can check the exact time of a recording or playback.

Tape Remaining Time

Press **--:--** until the time remaining on the tape appears.

- The front display panel shows the tape remaining time with "▶" displayed.
- By pressing the **--:--** button, you can change the display to show the counter reading, channel position*, clock time or tape remaining time.

* Channel position is not displayed during playback.

NOTE:

Depending on the type of tape being used, the tape remaining time reading may not appear right away, or is not correct.

"--:--" may sometimes appear, or the display may blink on occasion.

Retake

You can cut out unnecessary parts of a TV programme while you are recording it.

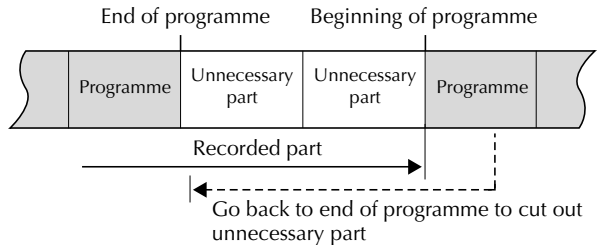

1 Engage the Record-Pause mode.

Press **II** during recording.

2 Locate the start point.

Hold down **◀◀** or **▶▶** and release it when you reach the point where you want to resume recording.

- Your recorder returns to the Record-Pause mode.

3 Resume recording.

Press **▶** when you wish to resume recording.

NOTES:

- Retake function does not work during Direct Rec (pg. 21, 78).
- Noise may appear when Retake function is used at the part that is recorded in EP mode.

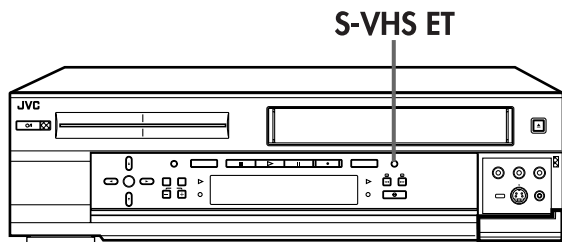

Super VHS ET (S-VHS ET)

— Recording on VHS cassettes with S-VHS quality

You can record in SP mode on VHS cassettes with S-VHS picture quality. Tapes recorded using this function can be played back on a recorder equipped with the S-VHS ET function.

- You can activate the S-VHS ET function only before you start recording on a VHS cassette.
- Before recording, make sure that "B.E.S.T." is set to "ON". (☞ pg. 77)

Engage the S-VHS ET mode.

Press **S-VHS ET** on the recorder.

- "S-VHS ET : ON" appears on the TV screen, if "O.S.D." is set to "ON".
- To disengage the S-VHS ET mode, press **S-VHS ET**.

NOTES:

- You cannot activate the S-VHS ET function ...
 - ... while recording is in progress.
 - ... while timer-recording or Instant Timer Recording (☞ pg. 37) is in progress.
 - ... while B.E.S.T. (☞ pg. 41) is in progress.
- The S-VHS ET function does not work ...
 - ... with S-VHS cassettes.
 - ... with recordings in LP/EP mode.
- To keep the highest quality recording and playback pictures over a long period of time, S-VHS recording on S-VHS cassettes is recommended.
- Use of high grade tapes is recommended for S-VHS ET recordings. On some tapes, picture quality will not improve even if the S-VHS ET function is used. Check the recording quality before you start important recordings.
- You can play back a tape recorded using the S-VHS ET function on most of S-VHS recorders and of VHS recorders equipped with SQPB (S-VHS QUASI PLAYBACK) function. (Notice some recorders are not compatible with the S-VHS ET function.)
- While playing back a tape recorded using the S-VHS ET function on some recorders, noise may appear. (If playback picture becomes blurred or interrupted, use a cleaning cassette.)
- In the high-speed search, still, slow-motion or frame-by-frame playback modes (☞ pg. 34), noise may appear. If these modes are performed frequently on a tape recorded using the S-VHS ET function, the tape may be damaged and the picture may be deteriorated.

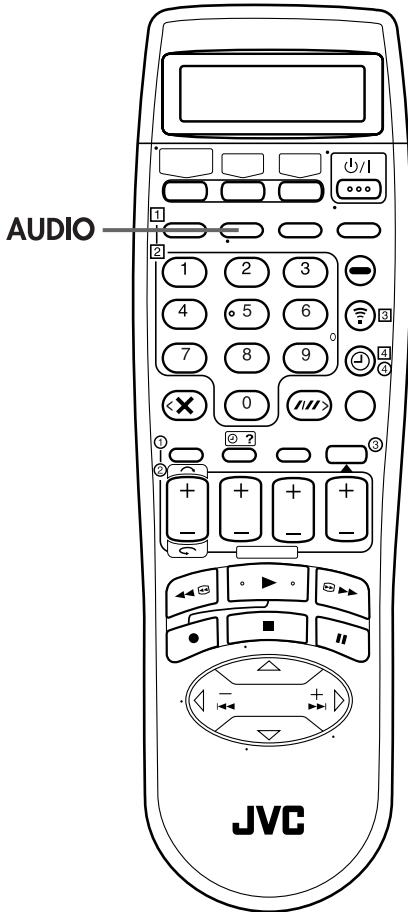

Receiving Stereo and Bilingual Programmes

Your recorder is equipped with a Sound-Multiplex decoder (A2) and a Digital stereo sound decoder (NICAM) making reception of stereo and bilingual broadcasts possible.

When the channel is changed, the type of broadcast being received will be displayed on the TV screen for a few seconds.

Type of Broadcast Being Received	On-screen Display
A2 Stereo	ST
A2 Bilingual	BIL.
Regular Monaural	(none)
NICAM Stereo	ST NICAM
NICAM Bilingual	BIL. NICAM
NICAM Monaural	NICAM

- To listen to a stereo programme, press **AUDIO** until "HIFI L R" appears on the TV screen.
- To listen to a bilingual programme, press **AUDIO** until "HIFI L R" or "HIFI R" appears on the TV screen (as required).
- To listen to the standard (Regular Monaural) audio while receiving a NICAM broadcast, press **AUDIO** until "NORM" appears on the TV screen.

NOTE:

"O.S.D." must be set to "ON" or the on-screen displays will not appear (pg. 78).

To Record Stereo and Bilingual Programmes (A2)

Stereo programmes are automatically recorded in stereo on the Hi-Fi audio track (with the normal audio track recording mixed L and R channel sound).

- Bilingual programmes are automatically recorded in bilingual on the Hi-Fi audio track. The main soundtrack will be recorded on the normal audio track.

To Record NICAM Stereo and Bilingual Programmes

The NICAM audio programme will be recorded on the Hi-Fi audio track, and the standard audio programme will be recorded on the normal audio track.

NOTES:

- If the quality of stereo sound being received is poor, the broadcast will be received in monaural with better quality.
- Before playing back a programme recorded in stereo, or a bilingual programme, refer to "Soundtrack Selection" on page 36.

B.E.S.T. Picture System

The B.E.S.T. (Biconditional Equalised Signal Tracking) system checks the condition of the tape in use during playback and recording, and compensates to provide the highest-possible playback and recording pictures. You can set "B.E.S.T." to "ON" or "OFF" to your preference (☞ pg. 77).

Playback

The recorder assesses the quality of the tape once you initiate playback.

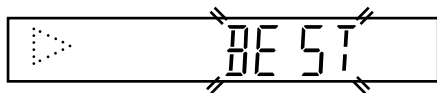

- The recorder adjusts the playback picture quality based on the quality of the tape in use.
- B.E.S.T. is active during automatic tracking. "BEST" appears blinking on the recorder's front display panel.

NOTES:

- When watching a tape recorded with "B.E.S.T." set to "ON", it is recommended that you leave B.E.S.T. on during playback as well.
- When watching a rental tape or one recorded on another video recorder, or when using this recorder as the player for editing, set B.E.S.T. to your preference (☞ pg. 77).
- "BEST" only appears at the beginning of automatic tracking. Even though it doesn't appear after that, the B.E.S.T. function is operative.

Recording

The recorder assesses the quality of the tape once you initiate recording.

DURING B.E.S.T.

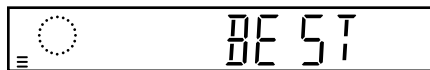

B.E.S.T. COMPLETE

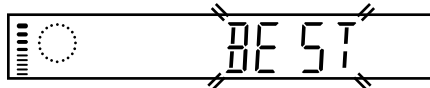

- The recorder spends approximately 7 seconds assessing the condition of the tape, then begins recording.

NOTES:

- The B.E.S.T. system works for both SP and LP (or EP) modes only after a tape has been inserted and the Record mode is first initiated. It does not work during recording.
- The B.E.S.T. system does not work while Automatic Satellite Programme Recording is in progress (☞ pg. 47).
- In the case of timer recordings, the B.E.S.T. system works before recording is initiated.
- Once the cassette is ejected, the B.E.S.T. data is cancelled. The next time the cassette is used for recording, B.E.S.T. is re-performed.
- Pressing the recorder's ● button while "BEST" is displayed does not start Instant Timer Recording (☞ pg. 37).

ATTENTION

Since the B.E.S.T. system works before recording actually starts, there is a delay of approximately 7 seconds after ● and ▶ on the remote control are pressed, or ● on the recorder is pressed. To make sure you record the desired scene or programme in its entirety, first perform the following steps:

- 1 Press and hold || and press ● to engage the Record Pause mode.
- The recorder then automatically checks the condition of the tape and, after approximately 7 seconds, re-enters Record Pause mode.
- 2 Press ▶ to start recording.

If you want to bypass the B.E.S.T. system and begin recording immediately, set "B.E.S.T." to "OFF" (☞ pg. 77).

SHOWVIEW® Timer Programming

You can programme this recorder to timer-record as many as 16 programmes.

With the SHOWVIEW system, timer programming is greatly simplified because each TV programme has a corresponding code number which your recorder is able to recognize. You can use the remote control with LCD panel to enter the SHOWVIEW number.

Before performing the SHOWVIEW Timer Programming:

- Make sure that the recorder's built-in clock is set properly.
- Turn on the TV and select the AV mode.

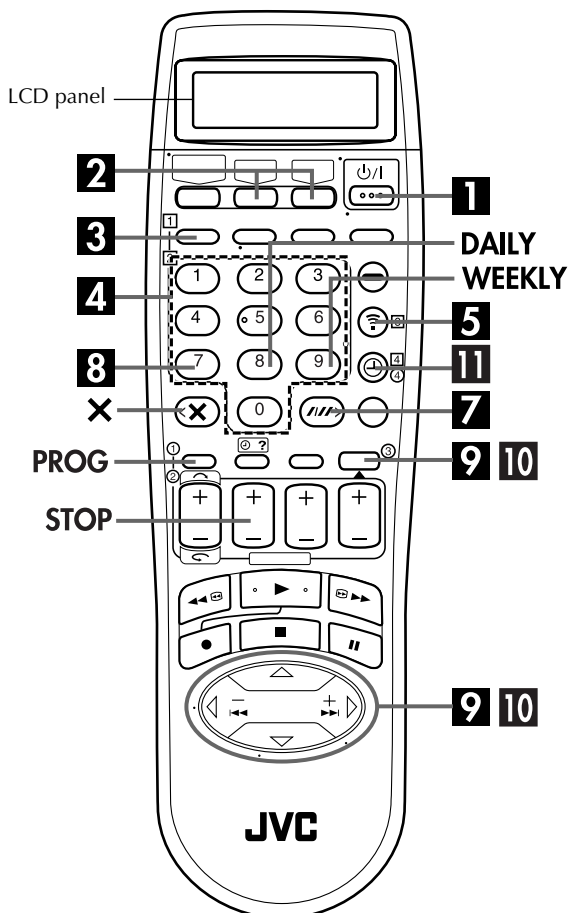

1 Turn on the recorder.

Press ψ /I.

2 Select the deck.

Press **HDD** or **S-VHS**.

- **For the VHS deck:**
Insert a cassette with the record safety tab intact.

3 Access the SHOWVIEW display.

Press **LCD PROG**.

The LCD panel looks like this:



4 Enter the SHOWVIEW number.

Press the **number keys** to enter the SHOWVIEW number of a programme you wish to record.

- If you make a mistake, press **X** and input the correct number. The SHOWVIEW number you enter appears on the LCD panel:

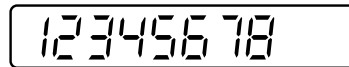

5 Transfer the SHOWVIEW number.

Press $\overline{\text{w}}$ to transmit the SHOWVIEW number from the remote control to the recorder.

- If the number you entered is invalid, "SHOWVIEW NO. ERROR CONFIRM SHOWVIEW NO. THEN RETRY" appears on the TV screen. Input a valid SHOWVIEW number.
- If "SET GUIDE PROG THEN RETRY" appears on the TV screen, set Guide Program Numbers (see pg. 79) manually.
- When "PROGRAMME FULL DELETE UNWANTED TIMER PROGRAMME" appears on the TV screen, you need to cancel some of the reserved programmes. (see pg. 46)

6 Check the programme data.

The SHOWVIEW number you entered and the matching timer-recording information are displayed on the TV screen. Check they are correct.

- To cancel this setting, press \triangleleft to move the arrow to "CANCEL", then press **OK**. Or, press **PROG**.

PROGRAMME			
SHOWVIEW NO. 1 2 3 4 5 6 7 8			
RECORD TO HDD	REC MODE SEP	WEEKLY/DAILY WEEKLY	VPS/PROC ON
START 23:30	STOP 00:00	DATE 12/06/01 TUE	TV PROG 5 CH
CONFIRM	CANCEL	CATEGORY	UNDECODED
<small> CHANGING SETTINGS BY REMOTE THEN CONFIRM </small>			

IMPORTANT

Make sure the channel position number you wish to record is displayed; if not, see "SHOWVIEW System Setup" on page 79 and set the Guide Program number correctly.

7 Set the recording speed.

Press **MODE** (//).

• For the VHS deck:

It is not possible to select EP mode if "COLOUR SYSTEM" is set to "MESECAM". (pg. 76)

8 Set the VPS/PDC mode.

Press **VPS/PDC** to select "ON" or "OFF".

- If "VPS/PDC ON" is displayed on the TV screen, VPS/PDC is set to ON.
- If "VPS/PDC OFF" is displayed on the TV screen, VPS/PDC is set to OFF.
 "VPS/PDC Recording" on page 45.

9 Set the category.

- 1 Press $\triangleleft \triangleright$ to move the arrow to "CATEGORY", then press **OK**. The category set screen appears.
- 2 Press $\triangleleft \triangle \triangleright \triangleright$ to select the desired category, then press **OK**.
- 3 Confirm the arrow is on "RETURN", then press **OK**. The programme screen resumes.

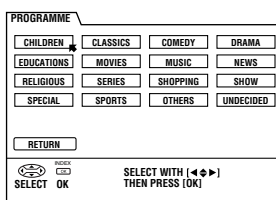

10 Return to the normal screen.

Press $\triangleleft \triangle \triangleright \triangleright$ to move the arrow to "CONFIRM", then press **OK**. "PROGRAMME COMPLETED" appears on the TV screen for about 5 seconds, then the normal screen appears.

- If "PROGRAMME OVERLAPPED" appears on the TV screen, see page 46.

11 Engage the recorder's timer mode.

Press **⊖ (TIMER)**. The recorder turns off automatically and "⊖" appears on the front display panel.

- To disengage the timer mode, press **⊖ (TIMER)** again.

NOTES:

- To Change The Stop Time . . .
 . . . press **STOP +/-** in step **6**. You can compensate for anticipated programme schedule delays.
- To Timer-Record Weekly Or Daily Serials . . .
 . . . in step **6**, press **WEEKLY** (number key "9") for weekly serials or **DAILY** (number key "8") for daily serials (Monday — Friday). Either "WEEKLY" or "DAILY" appears on the TV screen. Pressing the button again makes the corresponding indication disappear.
- During timer recording . . .
 . . . it is not possible to disengage the timer mode.
 . . . it is not possible to change the recording deck (HDD or VHS).
- It is not possible to timer-record a TV programme with a **SHOWVIEW** number which starts with "0".

Satellite Receiver Users

To timer-record a satellite broadcast using the **SHOWVIEW** system:

- 1 Perform "Automatic Satellite Programme Recording" on page 47.
- 2 Perform steps **1** — **11**. In step **6**, the front display panel shows "L2" for the channel position. In step **8**, you cannot set "VPS/PDC" to "ON".
- 3 Leave the satellite receiver's power on.

Express Timer Programming

You can programme this recorder to timer-record as many as 16 programmes.

If you do not know the SHOWVIEW number for the programme you wish to record, use the following procedure to set your recorder to timer-record the programme.

Before performing Express Timer Programming:

- Make sure that the recorder's built-in clock is set properly.
- Turn on the TV and select the AV mode.

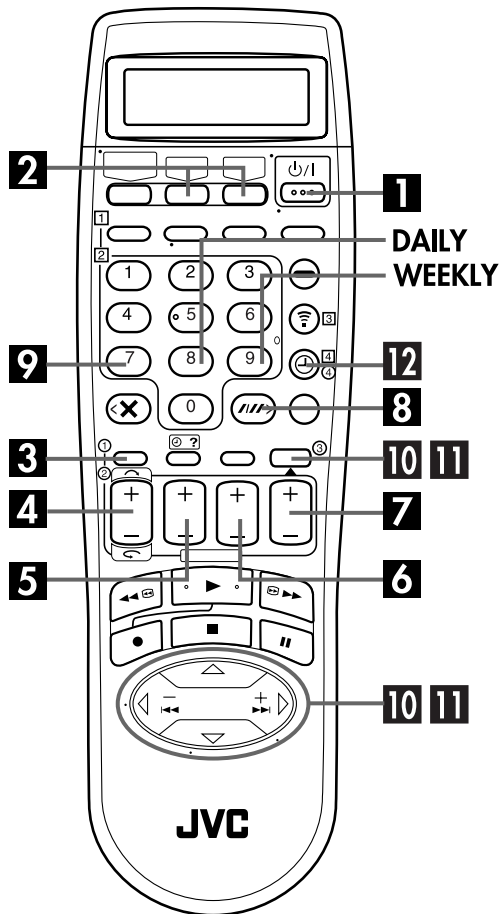

1 Turn on the recorder.

Press ψ /I.

2 Select the deck.

Press **HDD** or **S-VHS**.

- **For the VHS deck:**
Insert a cassette with the record safety tab intact.

3 Access the programme screen.

Press **PROG.**

- When "PROGRAMME FULL DELETE UNWANTED TIMER PROGRAMME" appears on the TV screen, you need to cancel some of the reserved programmes. (See pg. 46)

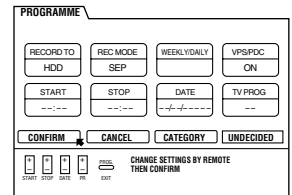

4 Enter the programme start time.

Press **START+/-** to enter the time you want recording to start.

- Press and hold **START+/-** to move in 30-minute increments, or press and release repeatedly to move 1 minute at a time.

5 Enter the programme stop time.

Press **STOP+/-** to enter the time you want recording to stop.

- Press and hold **STOP+/-** to move in 30-minute increments, or press and release repeatedly to move 1 minute at a time.

6 Enter the programme date.

Press **DATE+/-**.

- The current date appears on the TV screen. The date you enter appears in its place.

7 Enter the channel position.

Press **PR+/-**.

8 Set the tape speed.

Press **MODE** (///).

- **For the VHS deck:**
It is not possible to select EP mode if "COLOUR SYSTEM" is set to "MESECAM". (See pg. 76)

9 Set the VPS/PDC mode.

Press **VPS/PDC** to select "ON" or "OFF".

- If "VPS/PDC ON" is displayed on the TV screen, VPS/PDC is set to ON.
 - If "VPS/PDC OFF" is displayed on the TV screen, VPS/PDC is set to OFF.
- ☞ "VPS/PDC Recording" in the right column

10 Set the category.

- 1 Press \triangle \triangleright to move the arrow to "CATEGORY", then press **OK**. The category set screen appears.
- 2 Press \triangle \triangleright \triangleright \triangleright to select the desired category, then press **OK**.
- 3 Confirm the arrow is on "RETURN", then press **OK**. The programme screen resumes.

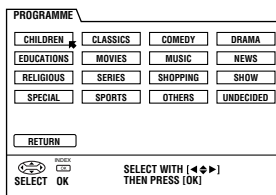

11 Return to the normal screen.

Press \triangle \triangleright \triangleright \triangleright to move the arrow to "CONFIRM", then press **OK**. "PROGRAMME COMPLETED" appears on the TV screen for about 5 seconds, then the normal screen appears.

- If "PROGRAMME OVERLAPPED" appears on the TV screen, see page 46.

12 Engage the recorder's timer mode.

Press **⊖ (TIMER)**. The recorder turns off automatically and "⊖" appears on the front display panel.

- To disengage the timer mode, press **⊖ (TIMER)** again.

NOTES:

- To Timer-Record Weekly Or Daily Serials anytime during steps 4 through 9, press **WEEKLY** (number key "9") for weekly serials or **DAILY** (number key "8") for daily serials (Monday – Friday). Either "WEEKLY" or "DAILY" appears on the TV screen. Pressing the button again makes the corresponding indication disappear.
- During timer recording it is not possible to disengage the timer mode. . . . it is not possible to change the recording deck (HDD or VHS).

Satellite Receiver Users

To timer-record a satellite broadcast using Express Timer Programming:

- 1 Perform "Automatic Satellite Programme Recording" on page 47.
- 2 Perform steps 1 – 12. In step 7, press the **number key "0"** to change "TV PROG" to "SAT". The front display panel shows "L2" for the channel position. Then press **PR+/-** to enter the channel position for the satellite broadcast. In step 9, you cannot set "VPS/PDC" to "ON".
- 3 Leave the satellite receiver's power on.

VPS/PDC Recording

Now available from some TV stations, PDC (Programme Delivery Control) and VPS (Video Programme System) are service designed to assure safe, accurate timer recording. With this system, special code signals are transmitted together with the audio/video signals. These code signals control your video recorder and have precedence over the advertised times you may have preset into the timer. This means that your recorder will start and stop recording when the preset TV programmes actually start and end — even if the broadcast time of a preset TV programme is changed.

NOTES:

- When you use Express Timer Programming, set the start time (VPS or PDC time) exactly as advertised in the TV listing. A different time than advertised will result in no recording.
- VPS/PDC recording is also possible when a satellite receiver or a cable system is connected to AV2 (L-2) IN/DECODER connector on your recorder.
- VPS/PDC recording is also possible via the AV1 (L-1) IN/OUT connector.

How to check if the station being received transmits a VPS/PDC signal (VHS deck only)

- 1 Press **--:--** until the channel position appears on the front display panel.
- 2 Hold down **START+** for about 5 seconds. "VPS/PDC" appears blinking on the front display panel. If a VPS/PDC signal is detected from the station, "VPS/PDC" will stop blinking. If no VPS/PDC signal is detected from the station, "VPS/PDC" will blink at a slower rate.
- 3 Press **--:--** or **START+** again to return to normal display.

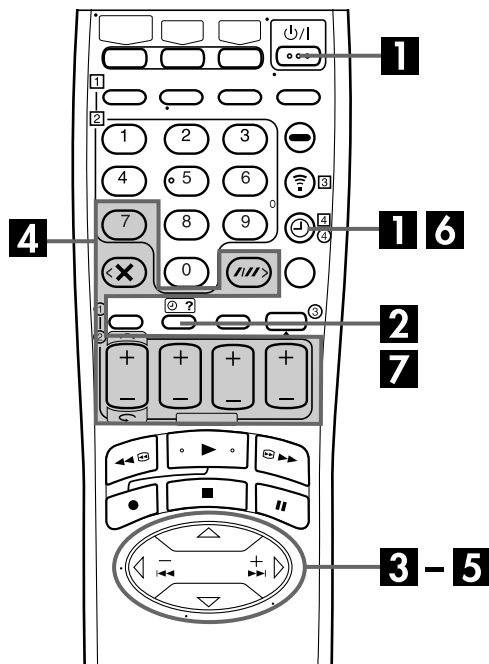

Check, cancel and change programmes

1 Disengage the timer mode. (VHS deck only)

Press **⏻** (TIMER), then press **⏻/I**.

2 Access the Programme Check screen.

Press **?**.

PROGRAMME CHECK						
DATE	START-STOP	PROG.	RECORD TO	REC MODE	VPS/PDC	
12/06/01 TUE	15:40 - 16:00	PR. 1	HDD	SP	ON	
12/06/01 TUE	15:40 - 16:00	PR. 2	S-VHS/VHS	SP	OFF	

SELECT WITH [**+**] THEN PRESS [**OK**]

3 Access the Programme screen.

Press **△** **▽** to select the programme, then press **OK**.

PROGRAMME			
RECORD TO HDD	REC MODE SEP	WEEKLY ONLY WEEKLY	VPS/PDC ON
START 23:30	STOP 00:00	DATE 12/06/01 TUE	TV PROG 5 CH
CONFIRM	CANCEL	CATEGORY	UNDECIDED
CHANGE SETTINGS BY REMOTE THEN CONFIRM			

To cancel or change a programme...

4 Cancel or change a programme.

To cancel the programme, press **◀** **▶** **△** **▽** to move the arrow to "CANCEL", then press **OK**.

To change programme settings, press the appropriate button: **START+/-**, **STOP+/-**, **DATE+/-**, **PR+/-**, **VPS/PDC** and/or **MODE (///)**.

- You can change "TV PROG" to "SAT" for the channel position by pressing the **number key "0"**.

5 Return to the normal screen.

Press **◀** **▶** **△** **▽** to move the arrow to "CONFIRM", then press **OK**.

6 Return to the timer mode.

Press **⏻** (TIMER).

Automatic Satellite Programme Recording

NOTE:

This function is available for the HDD deck only.

This function allows you to automatically record a satellite programme which is timer-programmed on your external satellite receiver. Connect a satellite receiver to the recorder's AV2 (L-2) IN/DECODER connector and programme the timer on the satellite receiver. When the signals come into the recorder from the satellite receiver, the recorder automatically turns on and starts recording on HDD deck.

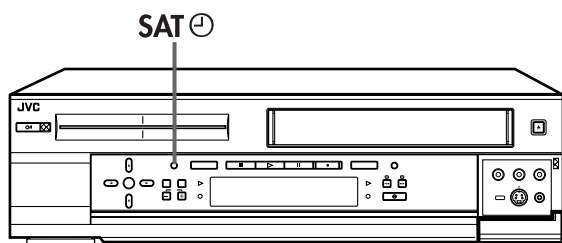

ATTENTION

- Be sure not to turn on the satellite receiver before the programme is executed; otherwise, the recorder will start recording when the satellite receiver's power is turned on.
- If you have connected another appliance other than a satellite receiver to the AV2 (L-2) IN/DECODER connector, be sure not to engage the Automatic Satellite Programme Recording mode; otherwise, the recorder will start recording when the connected appliance's power is turned on.
- Automatic Satellite Programme Recording and timer-recording cannot be done at the same time.

Before performing the following steps:

- Make sure the satellite receiver is connected to the recorder's AV2 (L-2) IN/DECODER connector. (☞ pg. 70, 71)
- Programme the timer on the satellite receiver.

1 Select the L-2 SELECT mode.

- Set "L-2 SELECT" to "A/V" or "SAT" (☞ pg. 65).
- When you select "SAT", refer to "IMPORTANT" on page 70.

2 Set the recording speed.

Press **MODE** (//).

3 Engage the Automatic Satellite Programme Recording mode.

Press and hold **SAT** for about 2 seconds. The **SAT** button lights up.

NOTES:

- To disengage the Automatic Satellite Programme Recording mode, press **SAT**.
- If the recorder's power is off, it is not possible to engage the Automatic Satellite Programme Recording mode.
- In step 1, if the **SAT** button does not light but instead blinks quickly even though your satellite receiver's power is off, Automatic Satellite Programme Recording will not work properly with that satellite receiver*. If this is the case, perform "Express Timer Programming" (☞ pg. 44) to timer-record a satellite programme.
* Some satellite receivers output signals even if the power is off. Automatic Satellite Programme Recording is not possible with those satellite receivers.
- The **SAT** button blinks while Automatic Satellite Programme Recording is in progress.
- For timer programming of the satellite receiver, refer to the instruction manual of the satellite receiver.
- Automatic Satellite Programme Recording is not possible if your satellite receiver does not have a timer.
- Pressing the recorder's **STOP** button while Automatic Satellite Programme Recording is in progress turns off the recorder's power and disengages the Automatic Satellite Programme Recording mode.
- If there are more than one satellite programmes you wish to record with Automatic Satellite Programme Recording, it is not possible to set different recording speeds for each programme.
- Depending on the type of satellite receiver, the recorder may not record a slight portion of the beginning of the programme or may record slightly longer than the actual length of the programme.
- If you engage the Automatic Satellite Programme Recording mode when the satellite receiver's power is on, the recorder will not start Automatic Satellite Programme Recording even though the **SAT** button blinks. When the satellite receiver shuts off once and is turned back on again, the recorder starts recording.
- You can also record a programme from your cable system in the same way if the system has a timer.
- Just Clock (☞ pg. 88) does not work when the Automatic Satellite Programme Recording mode is engaged.
- When the Automatic Satellite Programme Recording mode is engaged, or the recorder's power is turned off after Automatic Satellite Programme Recording is finished, the recorder will not enter the Timer mode even though "AUTO TIMER" is set to "ON" (☞ pg. 78).

Remote A/B/C/D Code Switching

The remote control is capable of controlling four JVC video recorders independently. Each of recorders can respond to one of four codes (A, B, C or D). The remote control is preset to send A code signals because your video recorder is initially set to respond to A code signals. You can easily modify your video recorder to respond to B, C or D code signals.

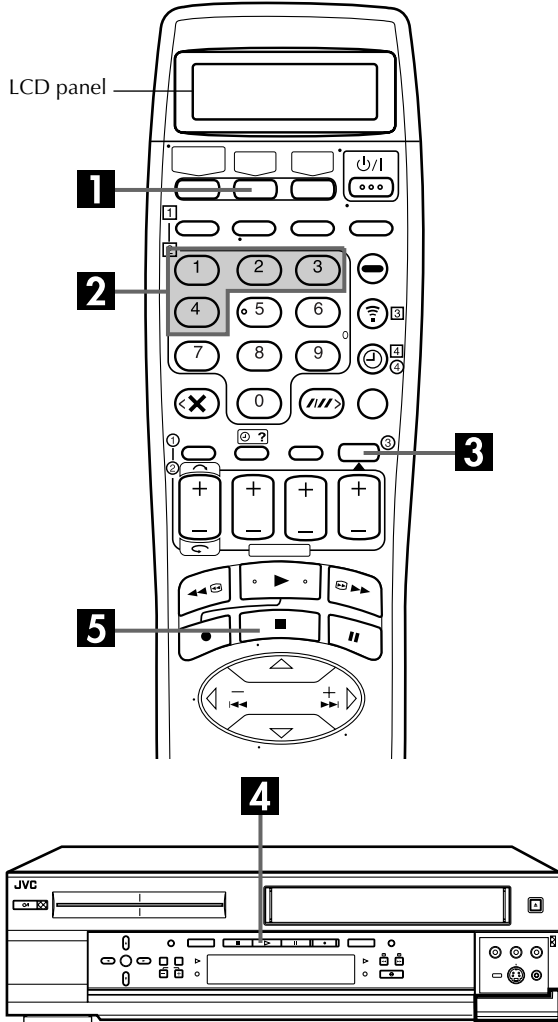

On the remote control

1 Display the code.

Press and hold **HDD** on the remote control for over 2 seconds. The code currently set blinks on the LCD panel.

2 Change the remote control code.

Press the **number key "1"** for A, **"2"** for B, **"3"** for C or **"4"** for D.

3 Set the remote control code.

Press **OK** to set the code.

On the recorder

4 Display the code.

Press **▶** on the recorder for over 5 seconds while the recorder is turned off. The code currently set appears on the front display panel.

- If the code displayed on the front display panel is different from the code set on the remote control, go to step **5**.

5 Change the recorder's code.

Press **■** on the remote control. The code currently set on the remote control will be applied to the recorder.

TV Multi-Brand Remote Control

Your remote control can operate the basic functions of your TV set. In addition to JVC TVs, other manufacturer's TVs can also be controlled.

Before performing the following steps:

Turn off the TV using its remote control.

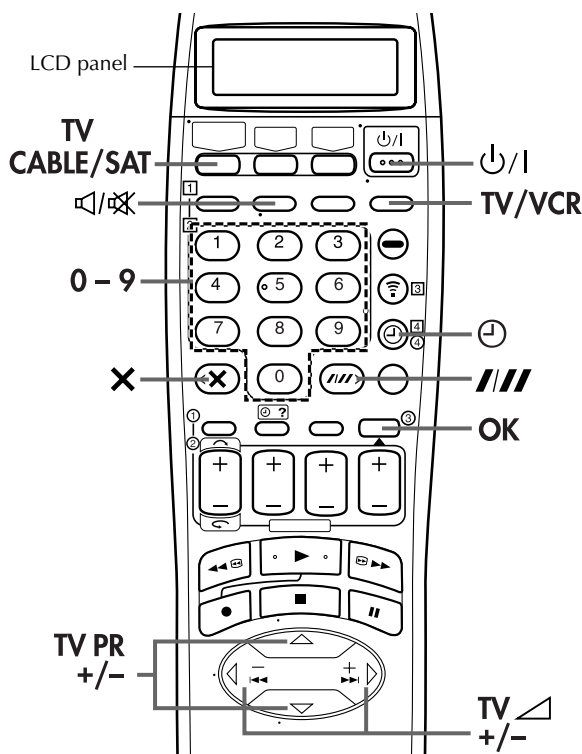

Control Your TV Using Additional Buttons

Use the **number keys**, and the **///** button, **X** button or **⊖** button to select the TV's channel.

- With televisions under Code 01, 02, 07, 10, 11, 14, 20, 23, 24, 25, 27, 33 or 35, the **///** button corresponds to the 1-digit/2-digit entry switching button (often labelled -/-) of your TV's remote control.
- With televisions under Code 01, 28, 29 or 34, the **X** button corresponds to the 10 + button, and the **⊖** button corresponds to the 20 + button of your TV's remote control.

NOTE:

The way these buttons are used is determined by your TV. Use these buttons as instructed for your TV's remote control.

1 Set the TV brand code.

Press **TV/CABLE/SAT** to switch the display to "TV" and keep pressing the button down until "TV_ _" appears. Enter your TV's brand code using the **number keys**, then press **OK**.

Press **⏻/⏪** on the recorder's remote control to turn on the TV and try operations (⏻ step 2).

- Once you have set the remote control to operate the TV, you do not have to repeat this step until you replace your remote control's batteries.
- Some brands of TV have more than one code. If the TV does not function with one code, try entering another.

2 Operate the TV.

First, press **TV/CABLE/SAT** to switch the display to "TV". Then press the corresponding button: **⏻/⏪**, **TV/VCR**, **TV PR +/-**, **TV ⏴/+/-** (Volume), **🔇** (TV Muting), **number keys**.

- For some brands of TV, you must press **OK** after having pressed the **number keys**.

IMPORTANT

Although the provided remote control unit is compatible with JVC televisions, as well as many other models, it may not work with your TV, or in some instances, may have limited function capability.

BRAND NAME	CODE
JVC	01, 23, 24, 25
BLAUPUNKT	19
BRANDT	26
FERGUSON	27
FINLUX	30
FUNAI	32
LG/GOLDSTAR	18
GRAETZ	28
GRUNDIG	19
HITACHI	10
ITT	28
LUXOR	28
MITSUBISHI	03
MIVAR	29
NEC	20
NOKIA	31
NORDMENDE	26
PANASONIC	11
PHILIPS	02
SABA	26
SALORA	28
SAMSUNG	02, 12, 33, 34, 35
SELECO	28
SHARP	06
SONY	07
TELEAVIA	26
TELEFUNKEN	26
THOMSON	26
TOSHIBA	14

Satellite Receiver Multi-Brand Remote Control

Your remote control can operate the basic functions of your satellite receiver set. In addition to JVC satellite receivers, other manufacturer's satellite receivers can also be controlled.

Before performing the following steps:

Turn off the satellite receiver using its remote control.

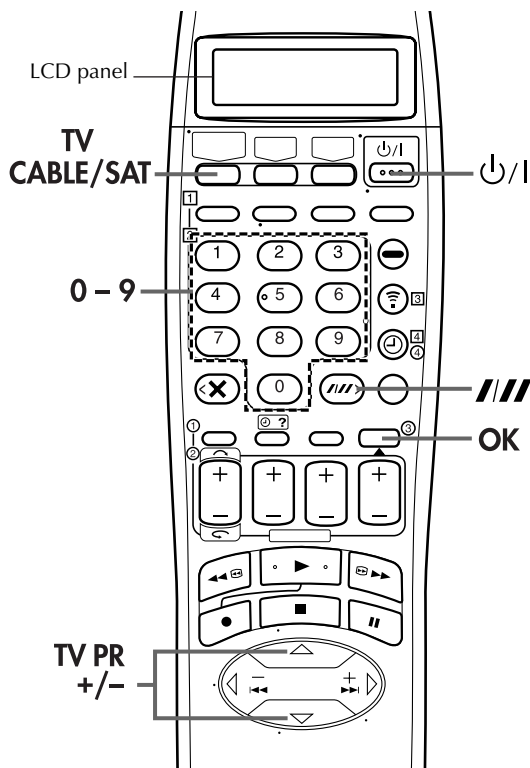

IMPORTANT

Although the provided remote control unit is compatible with JVC satellite receivers, as well as many other models, it may not work with your satellite receiver, or in some instances, may have limited function capability.

1 Set the satellite receiver brand code.

Press **TV/CABLE/SAT** to switch the display to "CABLE SAT" and keep pressing the button down until "SATCBL_ _" appears.

Enter your satellite receiver's brand code using the **number keys**, then press **OK**.

Press **power/I** on the recorder's remote control to turn on the satellite receiver and try operations (see step **2**).

- Once you have set the remote control to operate the satellite receiver, you do not have to repeat this step until you replace your remote control's batteries.
- Some brands of satellite receiver have more than one code. If the satellite receiver does not function with one code, try entering another.

2 Operate the satellite receiver.

First, press **TV/CABLE/SAT** to switch the display to "CABLE SAT".

Then press the corresponding button: **power/I**, **TV PR +/-**, **number keys**.

- For some brands of satellite receiver, you must press **///** after having pressed the **number keys**.
- The **number keys** may not function with some satellite receivers.

BRAND NAME	CODE
JVC	73
AMSTRAD	60, 61, 62, 63, 92
CANAL SATELLITE	81
CANAL +	81
D-BOX	85
ECHOSTAR	78, 79, 80
ECHOSTAR (VIA DIGITAL)	82
FINLUX	68
FORCE	89
GALAXIS	88
GRUNDIG	64, 65
HIRSCHMANN	64, 78
ITT NOKIA	68
JERROLD	75
KATHREIN	70, 71
LUXOR	68
MASCOM	93
MASPRO	70
NOKIA	87
PACE	65, 67, 74, 86, 92
PANASONIC	74
PHILIPS	66, 84
RFT	69
SAGEM	83
SALORA	68
SIEMENS	64
SKYMASTER	69
TPS	83
TRIAx	91
WISI	64

About Hybrid Navigation

In the sections “Playback with HDD Navigation” (pg. 24) and “Playback with VCR Navigation” (pg. 32), it is briefly described how to search for the beginning of each recorded programme using the Navigation functions. More detailed explanations are provided in this section using HDD Navigation by way of example.

This recorder has a built-in Hybrid Navigation system, which consists of two Navigation systems (HDD Navigation and VCR Navigation). Using Navigation system, you can easily modify registered information or edit the programme when dubbing from the HDD deck to VHS deck, as well as search for the beginning of each programme.

About registration of information

The following information is automatically registered for each programme when ordinary recording or timer recording is performed, then stored in an area specified on the hard disk. For the VHS deck, set “NAVIGATION” to “ON” (pg. 75).

- index* (reduced still pictures to show programme titles)
- programme title*
- category*
- date and time
- channel
- recording speed
- length of recording time

The items marked with an asterisk (*) can be easily modified and registered again after recording by using Navigation system.

About editing of programmes

Navigation system has four functions for editing of programmes.

- “Modify Information” (pg. 52)
- “Delete Information” (pg. 55)
- “Easy Dubbing from HDD deck to VHS deck” (pg. 56)
- “Random Assemble Editing” (pg. 60)

The limitations of registration

You can register information up to 60 programmes in HDD Navigation. In VCR Navigation, you can register information up to 2000 programmes or up to 680 cassettes.

To register the information for VCR Navigation, you need to record a programme for more than 8 minutes in SP mode (for more than 15 minutes in LP mode or for more than 23 minutes in EP mode).

When the amount of information is at the limits of registration, you cannot record new programme any more. In this case, you need to delete old programmes to register new one (pg. 55).

The display for modification or deletion

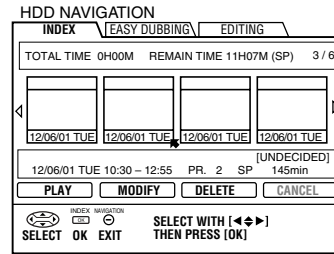

The display for easy dubbing

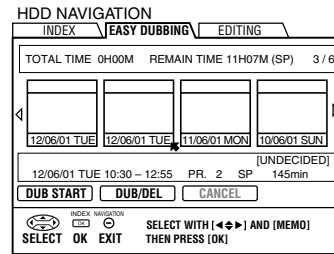

The display for editing

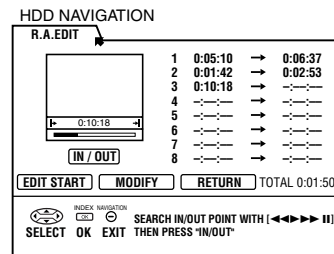

Modify Information

NOTE:

The Navigation systems cannot work during recording on the HDD deck or in SAT mode (pg. 47).

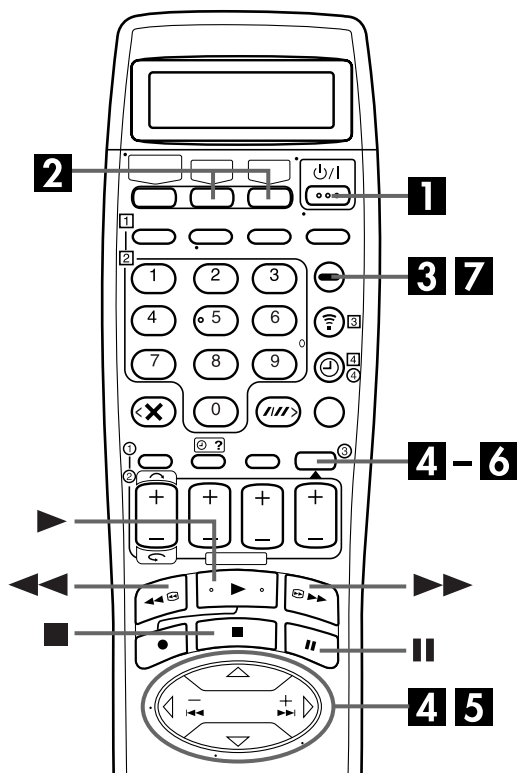

3 Access the Navigation screen.

Press **NAVIGATION**.

- The Navigation screen corresponding to the selected deck appears.
- **For the VHS deck:**
When "NAVIGATION" is set to "OFF" (pg. 75), the Navigation screen does not appear.

4 Select the programme.

Press $\triangleleft \triangleright$ to move the arrow to select one programme you want to modify, then press ∇ or **OK**.

5 Access the modify screen.

- 1 Press $\triangleleft \triangleright$ to move the arrow to "MODIFY", then press **OK**.
- 2 Press $\triangleleft \triangleright$ to move the arrow to "MODIFY INDEX", then press **OK**. The "MODIFY INDEX" screen appears.

6 Register new index.

- 1 Search for the picture from the programme by pressing the appropriate buttons ($\triangleleft \triangleright$, $\triangleright \triangleright$, or **II**). The pictures of the programme appear on the left window.
- 2 Confirm the arrow is on "REPLACE", then press **OK** to register new index. New index appears on the right window.

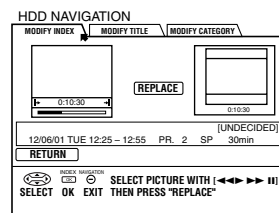

- When you press **OK** with the arrow on "RETURN" you can return the previous screen.

7 Return to the normal screen.

Press **NAVIGATION**.

- **For the VHS deck:**
Press \blacksquare to cancel pause mode after pressing **NAVIGATION**.

Modify Index

1 Turn on the recorder.

Press $\text{power}/\text{standby}$.

2 Select the deck.

Press **HDD** or **S-VHS**.

- **For the VHS deck:**
Insert a cassette with the record safety tab intact.

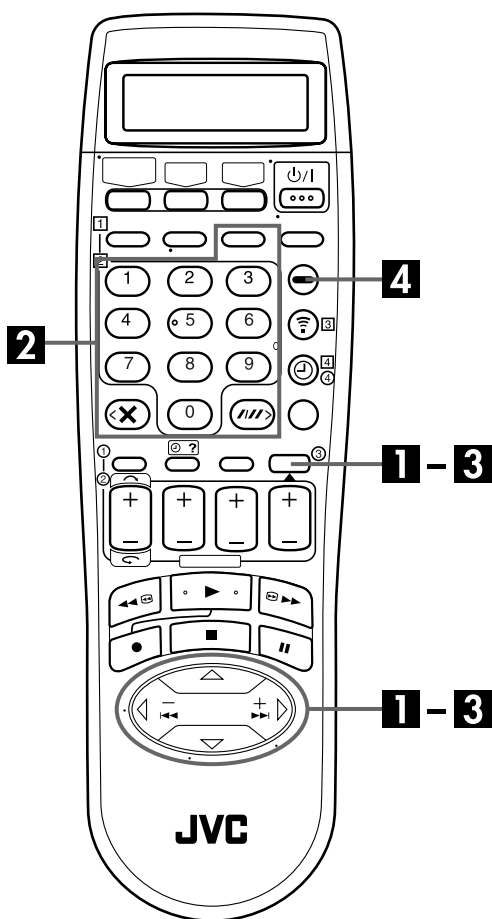

Modify Programme Title

Perform steps **1** to **4** of "Modify Index" (pg. 52) before continuing.

1 Access the modify screen.

- 1 Press \triangle \triangleright to move the arrow to "MODIFY", then press **OK**.
- 2 Press \triangle \triangleright to move the arrow to "MODIFY TITLE", then press **OK**. The "MODIFY TITLE" screen appears.

2 Enter new title.

Press \triangle \triangleright \triangle \triangleright ∇ to move the arrow to the desired letter or command, then press **OK**. Repeat this process to complete the title.

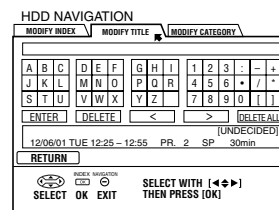

- To correct a letter, press \triangle \triangleright \triangle \triangleright ∇ to move the arrow to "DELETE" or "DELETE ALL", then press **OK**.
- You can enter the letters up to 15.
- You can also enter the new title with **number keys**. For example, when you press **2** repeatedly, "A", "B", "C", "2", "A" appears by turns. You can use the following buttons.

Number keys: for entering letters, numbers, marks (-, +, *) and blank space
< > buttons: for moving the entering or inserting point
DEL button: for correcting a letter

3 Register new title.

Press \triangle \triangleright \triangle \triangleright ∇ to move the arrow to "ENTER", then press **OK**.

4 Return to the Navigation screen.

Press \triangle \triangleright \triangle \triangleright ∇ to move the arrow to "RETURN", then press **OK**. The Navigation screen appears again.

5 Return to the normal screen.

Press **NAVIGATION**.

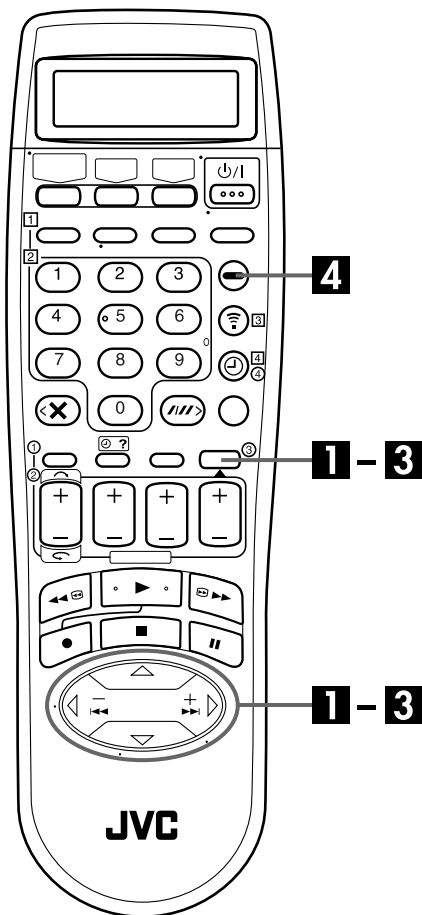

Modify Category

Perform steps **1** to **4** of “Modify Index” (pg. 52) before continuing.

1 Access the modify screen.

- 1 Press \triangle \triangleright to move the arrow to “MODIFY”, then press **OK**.
- 2 Press \triangle \triangleright to move the arrow to “MODIFY CATEGORY”, then press **OK**. The “MODIFY CATEGORY” screen appears.

2 Select new category.

Press \triangle \uparrow \triangleright ∇ to move the arrow to the desired category, then press **OK**.

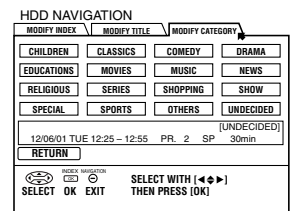

3 Register new category.

Press \triangle \uparrow \triangleright ∇ to move the arrow to “RETURN”, then press **OK**. The Navigation screen appears again.

4 Return to the normal screen.

Press **NAVIGATION**.

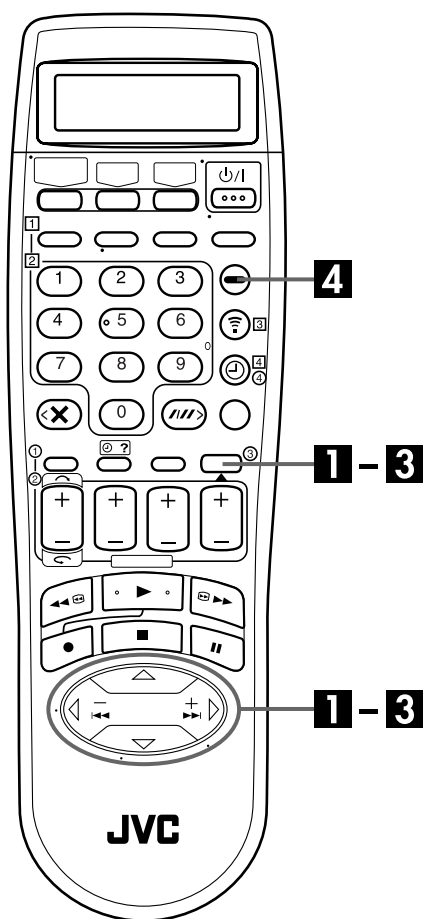

Delete Information

For HDD Navigation:

When you delete the registered information of a programme, the recorder delete the programme itself on the hard disk drive. The deleted programme is never resumed.

For VCR Navigation:

When you delete the registered information of a programme, the recorder delete only the information on the hard disk drive. The programme itself cannot be deleted with VCR Navigation.

Perform steps **1** to **3** of "Modify Index" (pg. 52) before continuing.

1 Select the programme.

Press ◀▶ to move the arrow to select one programme whose information you want to delete, then press ▼ or OK.

- For the VHS deck:

You can delete all the information of a cassette at the "CASSETTE #".

2 Access the delete screen.

Press ◀▶ to move the arrow to "DELETE", then press OK. The message appears for your confirmation.

3 Confirm the deletion.

Press ◀▶ to select "DELETE", then press OK.

- When you cancel the deletion, select "CANCEL", then press OK.

4 Return to the normal screen.

Press NAVIGATION.

Dubbing

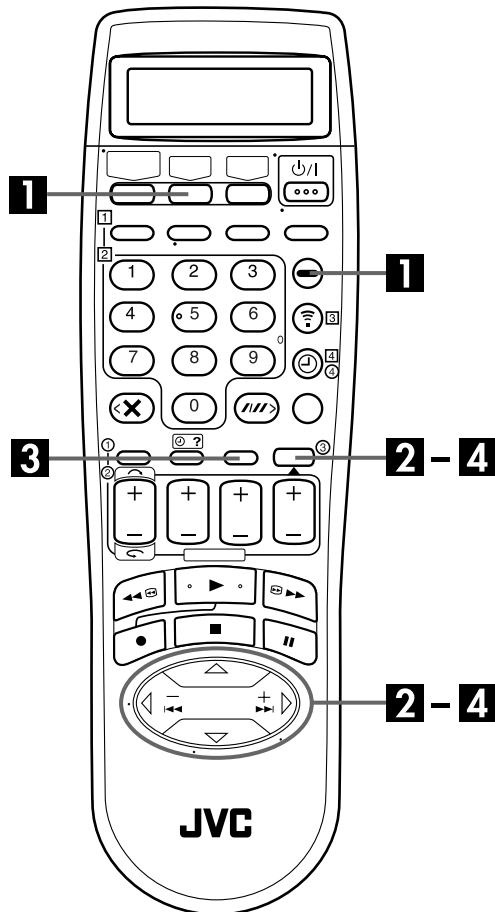

Easy Dubbing from HDD deck to VHS deck

Because this recorder includes both HDD deck and VHS deck, you can easily use it for dubbing without connecting any other equipment.

1 Access the HDD Navigation screen.

Press **HDD**, then press **NAVIGATION**. The HDD Navigation screen appears.

2 Access the Easy Dubbing screen.

Press \triangle to move the arrow to "EASY DUBBING", then press **OK**. The Easy Dubbing screen appears.

3 Select the programme(s).

Press \triangle to move the arrow to the desired programme, then press **OK**.

- When you want to select the plural programmes, press **MEMO** after selecting the desired programme. The numbers of the playback order appear on the index. You can select up to 8 programmes.
- When you want to correct the order, move the arrow on the desired index and press **MEMO**. The number disappears and the recorder re-numbers the other programmes automatically.
- When you want to cancel the order, move the arrow to "CANCEL" and press **OK**.

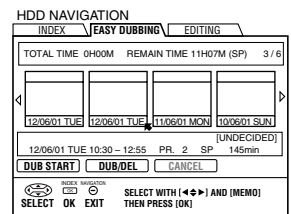

4 Select the dubbing option.

Press \triangle ∇ to move the arrow to "DUB START" or "DUB/DEL", then press **OK**. The message for preparing a cassette appears.

- When "DUB START" is selected, the programmes remains on the hard disk after dubbing.
- When "DUB/DEL" is selected, the recorder delete the programmes on the hard disk after dubbing automatically.

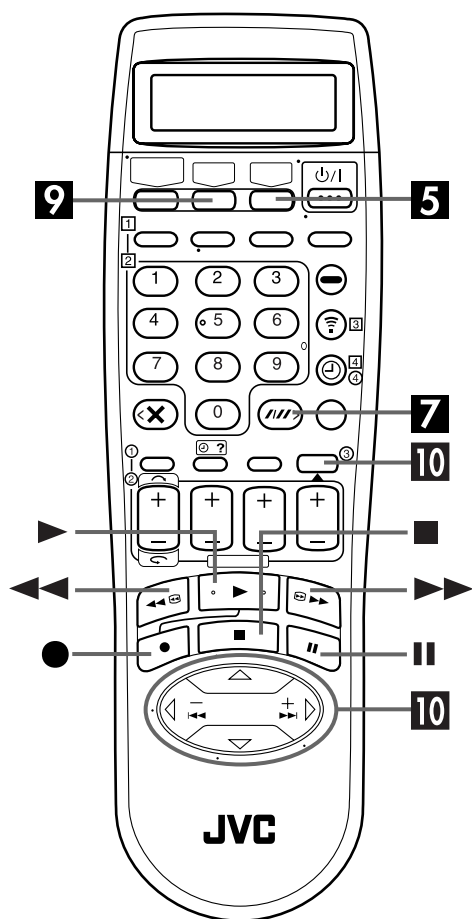

5 Select the VHS deck.

Press **S-VHS**.

6 Load a cassette.

Insert a cassette with the record safety tab intact.

7 Set the recording speed.

Press **MODE** (//).

- **For the VHS deck:**

It is not possible to select EP mode if "COLOUR SYSTEM" is set to "MESECAM". (pg. 76)

8 Locate the start point.

- 1 Search for the point where you want to start dubbing by pressing ▶, ▶▶ or ◀◀ then press ■.
- 2 Press ● and || simultaneously to enter the Record-Pause mode.

9 Select the HDD deck.

Press **HDD**. The Easy Dubbing screen appears again.

- To cancel dubbing, select "CANCEL".

10 Start dubbing.

Press ◀▶ to move the arrow to "DUB START", then press **OK**. When the dubbing completes successfully, the message "DUBBING COMPLETED" appears on the TV screen.

- To stop dubbing, press ■.
- Once the dubbing is stopped, it can not be resumed. In this case, the message appears on the TV screen, and the programmes on the hard disk drive are not deleted even though "DUB/DEL" is selected.

NOTE:

If you start dubbing without setting the VHS deck to Record Pause mode in step 8, you can watch the preview.

Normal Dubbing

(from HDD to VHS)

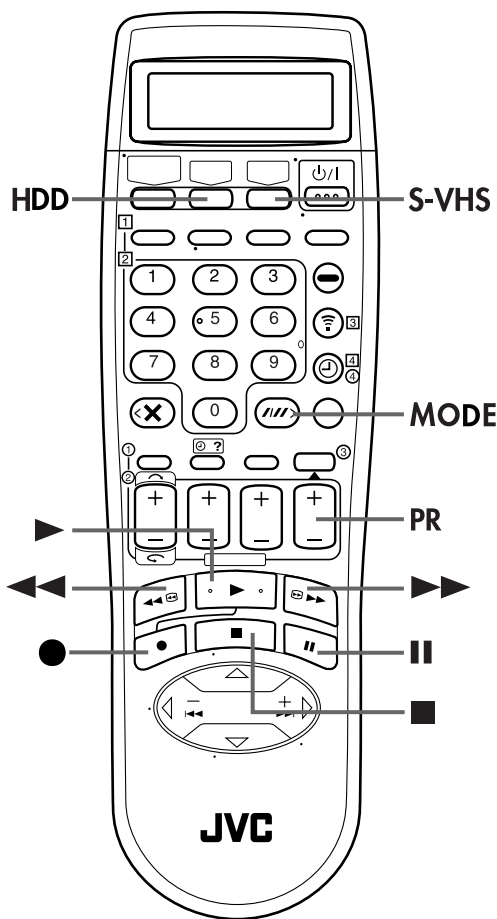

You can dub selected scenes from the HDD deck to a cassette, starting and stopping wherever you wish.

1 Load a cassette.

Insert a cassette with the record safety tab intact.

2 Prepare the HDD deck for dubbing.

- 1 Press **HDD** and select the programme to be dubbed. You can select the programme by HDD Navigation. (☞ pg. 24)
- 2 Press **PR+/-** to set the channel other than "DUB".

3 Locate the start point.

- 1 Search for the point where you want to start dubbing by pressing **▶**, **▶▶** or **◀◀** then press **■**.
- 2 Press **◀◀** a little, then press **▶** to start playback.
- 3 Press **||** to pause playback a little before the start point.

4 Prepare the VHS deck for dubbing.

- 1 Press **S-VHS**.
- 2 Press **PR+/-** to set the channel "DUB".
- 3 Press **MODE (////)** to select tape speed.
- 4 Search for the point where you want to start dubbing by pressing **▶**, **▶▶** or **◀◀** then press **■**.

5 Start dubbing.

- 1 Press **HDD** and **▶** to start playback.
- 2 Press **S-VHS** and **●** (● and **▶** on the remote control) to start dubbing.

6 End dubbing.

Press **■**. Then press **HDD** and press **■**.

NOTES:

- There may be a discrepancy of several seconds between where you intend editing to start, and where it actually starts.
- The superimposed indication during the operation or dubbing is not recorded.

Normal Dubbing

(from VHS to HDD)

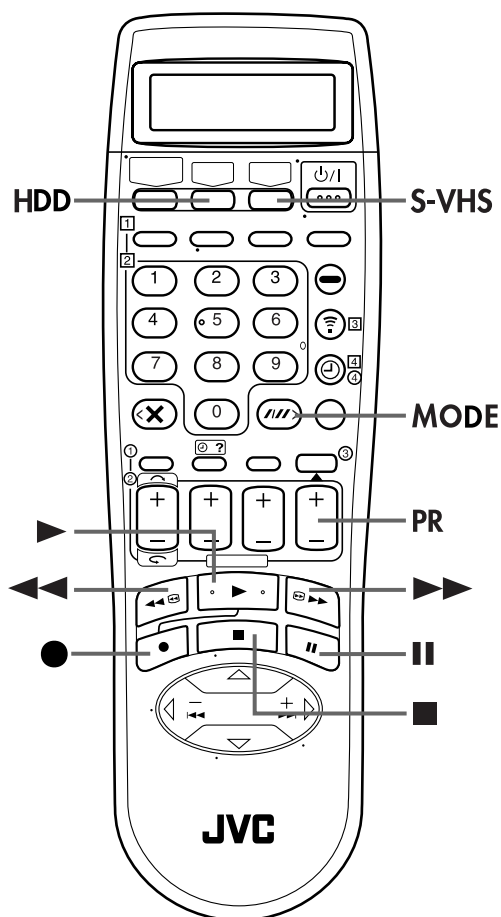

You can dub selected scenes from a cassette to the HDD deck, starting and stopping wherever you wish.

1 Load a cassette.

Insert a cassette with the record safety tab intact.

2 Prepare the VHS deck for dubbing.

- 1 Press **S-VHS** and select the programme to be dubbed. You can select the programme by VCR Navigation. (☞ pg. 32)
- 2 Press **PR+/-** to set the channel other than "DUB".
 - Set "PICTURE CONTROL" to "EDIT" (☞ pg. 77).

3 Locate the start point.

- 1 Search for the point where you want to start dubbing by pressing **▶**, **▶▶** or **◀◀** then press **■**.
- 2 Press **◀◀** a little, then press **▶** to start playback.
- 3 Press **||** to pause playback a little before the start point.

4 Prepare the HDD deck for dubbing.

- 1 Press **HDD**.
- 2 Press **PR+/-** to set the channel "DUB".
- 3 Press **MODE (///)** to select recording speed.

5 Start dubbing.

- 1 Press **S-VHS** and **▶** to start playback.
- 2 Press **HDD** and **●** (**●** and **▶** on the remote control) to start dubbing.
 - To enter Record-Pause mode, press and hold **●** and press **||** on the remote control. To resume recording, press and hold **●** and press **▶** on the remote control.

6 End dubbing.

Press **■**. Then press **S-VHS** and press **■**.

NOTES:

- There may be a discrepancy of several seconds between where you intend editing to start, and where it actually starts.
- The superimposed indication during the operation or dubbing is not recorded.
- For HDD deck, the recording pause takes effect only when the recorder is recording on the HDD deck with the channel set to "L-1", "F-1", or "DUB". The recording pause is released in 5 minutes automatically. Picture and sound may be distorted at the point where the recording pause is released.
- Dubbing copyright guarded tape is not possible.
- When you select "EDIT" to dub tapes in step 2, be sure to select "AUTO" (or "NORM" when "B.E.S.T." is set to "OFF") after you finish dubbing the tapes.

Random Assemble Editing

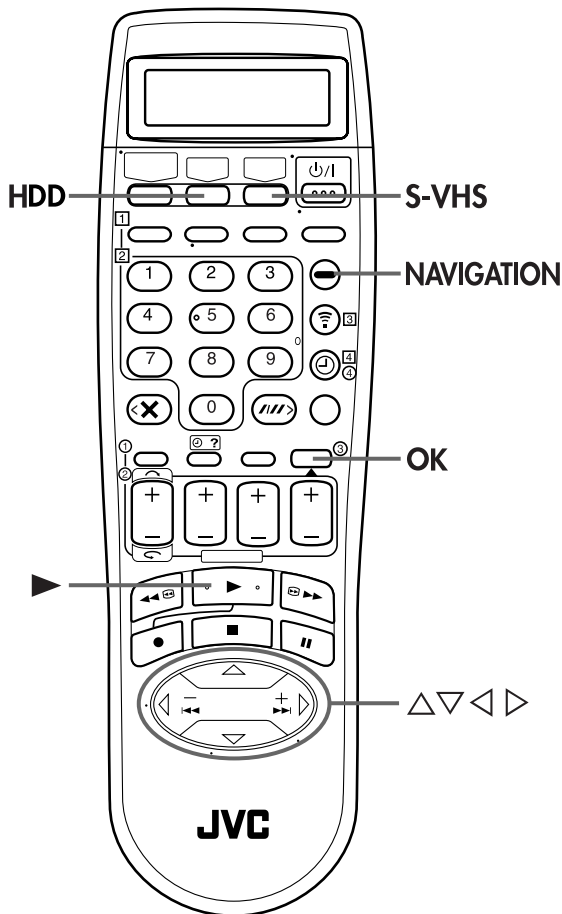

8-programme Editing Memory (1 programme x 8 scenes)

By using the Random Assemble Editing function, you can select up to 8 scenes from a previously recorded programme on the HDD deck and automatically dub them onto a cassette on the VHS deck.

Random Assemble Editing is possible only when dubbing from the HDD deck to the VHS deck.

1 Load a cassette.

Insert a cassette with the record safety tab intact.

2 Select the HDD deck.

Press **HDD**.

3 Access the HDD Navigation screen.

Press **NAVIGATION**. The HDD Navigation screen appears.

4 Access the edit screen.

Press $\triangleleft \triangleright$ to move the arrow to "EDITING", then press **OK**.

5 Select the programme.

Press $\triangleleft \triangleright$ to move the arrow to select one programme you want to edit, then press ∇ or **OK**.

6 Access the R.A.Edit screen.

Press **OK** at the "R.A.EDIT". The R.A.Edit screen appears.

7 Start playback of the source programme.

Press \blacktriangleright to start playback. The playback pictures appear in the window of the R.A.Edit screen. The first edit-in time starts counting with the arrow to "IN/OUT".

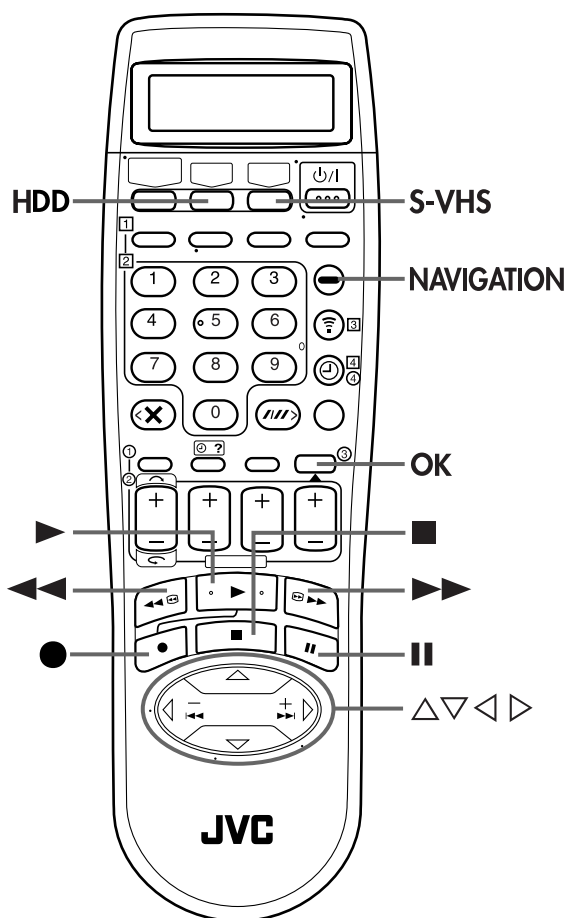

9 Select other edit-in and edit-out points.

Repeat step 8. You can select up to 8 pairs of edit-in and edit-out points.

To modify the points

- 1 Move the arrow to "MODIFY", then press **OK**.
- 2 Press \triangle \triangleright \triangleright \triangleright to select the desired point, then press **OK**. The selected point starts counting.
- 3 Repeat step 8.

10 Access the Start Editing screen.

Press \triangle \triangleright \triangleright \triangleright to move the arrow to "EDIT START", then press **OK**. The Start Editing screen with message appear.

11 Prepare the VHS deck for dubbing.

- 1 Press **S-VHS**.
- 2 Search for the point where you want to start dubbing by pressing \triangleright , $\triangleright\triangleright$ or $\triangleleft\triangleleft$ then press \blacksquare .
- 3 Press \bullet and \parallel simultaneously to enter the Record-Pause mode.

12 Access the Start Editing screen.

Press **HDD**. The Start Editing screen with message appear again.

13 Start editing.

Press \triangle \triangleright \triangleright \triangleright to move the arrow to "OK", then press **OK**. The editing starts. The message "EDITING COMPLETED" appears when the editing is complete successfully.

14 Return to R.A.Edit screen.

Press **OK**.

- If you want to continue to edit, start from step 7.

15 Stop editing.

Press **NAVIGATION**. The VHS deck stops recording and enters the Record-Pause mode. Press **S-VHS**, then press \blacksquare .

8 Set edit-in and edit-out points.

- 1 Find the point where you want the edited scene to begin, then press **OK** with the arrow to "IN/OUT". The edit-in time is fixed and the edit-out time starts counting.

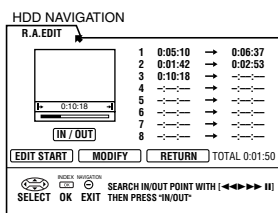

- 2 Find the point where you want the edited scene to end, then press **OK** with the arrow to "IN/OUT". The edit-out time is fixed and the next edit-out time starts counting.

- Press $\triangleleft\triangleleft$, \triangleright , $\triangleright\triangleright$ or \parallel to find the edit-in and edit-out points.

Edit From A Camcorder

You can use a camcorder as the source player and your recorder as the recording deck.

1 Make connections.

1 If the camcorder has no S-VIDEO output connector ...
... connect the camcorder's AUDIO OUT and VIDEO OUT connectors to the recorder's front panel AUDIO and VIDEO input connectors.

2 If the camcorder has an S-VIDEO output connector ...
... connect the camcorder's AUDIO OUT and S-VIDEO OUT connectors to the recorder's front panel AUDIO and S-VIDEO input connectors.

- When using a monaural camcorder, connect its AUDIO OUT connector to the AUDIO L input connector on your recorder.

For the VHS deck:

When a Master Edit Control-equipped JVC camcorder is used, the camcorder is capable of controlling the recorder. Refer to the camcorder's instruction manual for operating procedure.

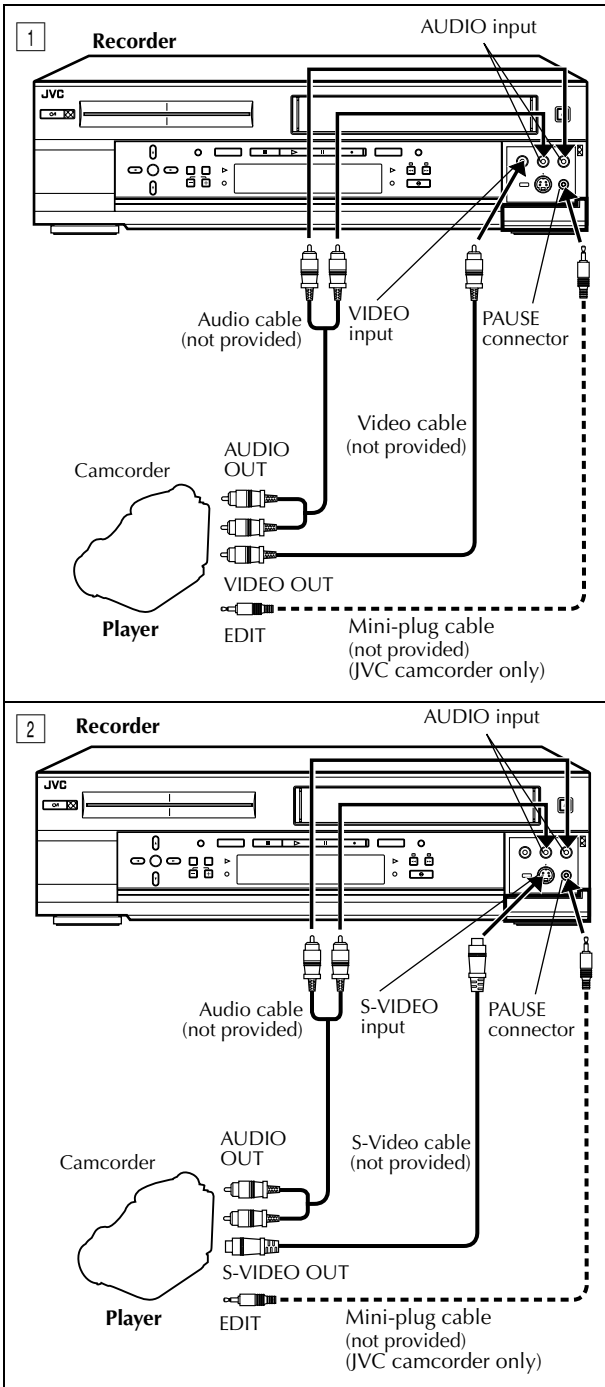

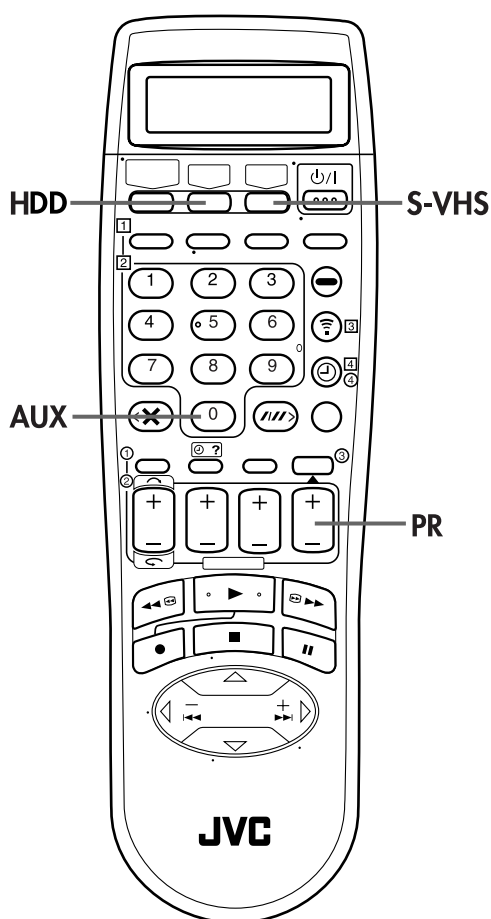

2 Select the recording deck.

Press **HDD** or **S-VHS**.

3 Set the recorder's input mode.

Press **AUX** (number key "0") and/or **PR** to select "F-1".

- Set "F-1 INPUT" to "VIDEO" for the VIDEO input connector, or "S-VIDEO" for the S-VIDEO input connector, depending on the connector being used (see pg. 65).

4 Set the edit mode. (VHS deck only)

See "PICTURE CONTROL" on page 77.

5 Start the camcorder.

Engage the Play mode of the camcorder.

6 Start the recorder.

Engage the Record mode of the recorder.

NOTES:

- All necessary cables can be obtained from your dealer.
- When you select "EDIT" to dub tapes in step 4, be sure to select "AUTO" (or "NORM" when "B.E.S.T." is set to "OFF") after you finish dubbing the tapes.
- For HDD deck, the recording pause takes effect only when the recorder is recording on the HDD deck with the channel set to "L-1", "F-1", or "DUB". The recording pause is released in 5 minutes automatically. Picture and sound may be distorted at the point where the recording pause is released.

Output/Input Set

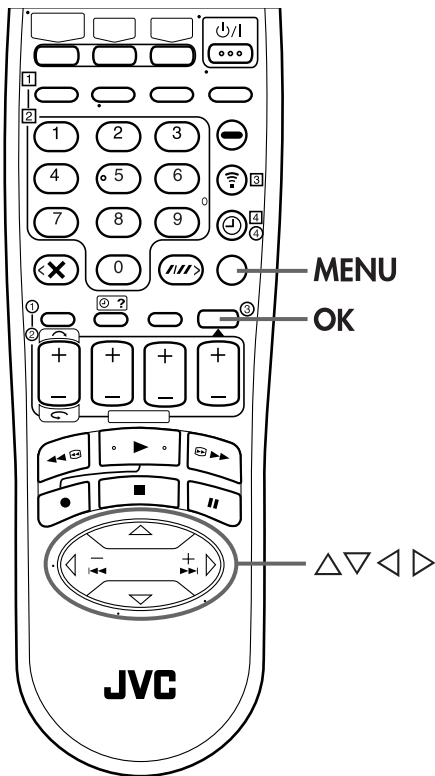

L-1 OUTPUT and L-1 INPUT Setting

The AV1 (L-1) IN/OUT connector accepts and delivers either a composite signal (regular video signal) or a Y/C signal (a signal in which the luminance and chrominance signals are separated). Set "L-1 OUTPUT" and "L-1 INPUT" to the appropriate mode depending on the type of appliance connected to the recorder's AV1 (L-1) IN/OUT connector.

1 Access the Main Menu screen.

Press **MENU**.

2 Access the Input/Output Set screen.

- 1 Press $\triangleleft \triangleright$ to move the arrow to "FUNCTION SET UP", then press ∇ or **OK**.
- 2 Press $\triangleleft \triangleright$ to move the arrow to "INPUT/OUTPUT", then press **OK**.

3 Select the output or input mode for the AV1 (L-1) IN/OUT connector.

- 1 Press $\triangle \nabla$ to move the arrow to "L-1 OUTPUT" or "L-1 INPUT", then press **OK**.
- 2 Press $\triangle \nabla$ to select the appropriate setting, then press **OK**.

* The default setting is **bold** in the table below.

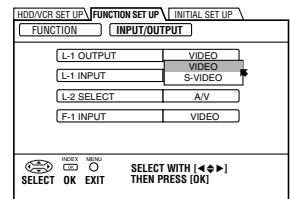

■ L-1 OUTPUT

- VIDEO:** If a connected appliance's input is compatible only with regular video signals, set to "VIDEO".
- S-VIDEO:** If a connected appliance's input is compatible with Y/C signals, set to "S-VIDEO". You can obtain high-quality S-VHS picture. (For connection, be sure to use a 21-pin SCART cable that is compatible with the Y/C signal.)

■ L-1 INPUT

- VIDEO:** If a connected appliance's output is compatible only with regular video signals, set to "VIDEO".
- S-VIDEO:** If a connected appliance's output is compatible with Y/C signals, set to "S-VIDEO". You can obtain high-quality S-VHS picture. (For connection, be sure to use a 21-pin SCART cable that is compatible with the Y/C signal.)

4 Return to the normal screen.

Press **MENU**.

NOTES:

- If "L-1 OUTPUT" is set to "S-VIDEO", it is impossible to set "L-1 INPUT" to "S-VIDEO".
- If "L-2 SELECT" is set to "DECODER", it is impossible to set "L-1 INPUT" to "S-VIDEO".

L-2 SELECT Setting

Set "L-2 SELECT" to the appropriate mode depending on the type of appliance connected to the recorder's AV2 (L-2) IN/DECODER connector.

Perform steps **1** and **2** of "L-1 OUTPUT and L-1 INPUT Setting" on page 64.

1 Select the input mode for the AV2 (L-2) IN/DECODER connector.

- Press Δ / ∇ to move the arrow to "L-2 SELECT", then press **OK**.
- Press Δ / ∇ to select the appropriate setting, then press **OK**.

* The default setting is **bold** in the table below.

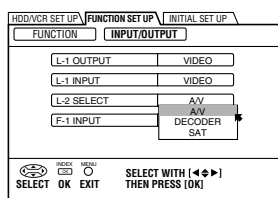

L-2 SELECT

AV: To use this recorder as the recording deck with the player connected to the AV2 (L-2) IN/DECODER connector, or to use the satellite receiver connected to the AV2 (L-2) IN/DECODER connector.

DECODER: To use a decoder connected to the AV2 (L-2) IN/DECODER connector.

SAT: To view a satellite programme with the TV set while the recorder is turned off. (pg. 70)

2 Return to the normal screen.

Press **MENU**.

NOTES:

- If you have a satellite receiver or a decoder connected to the AV2 (L-2) IN/DECODER connector, be sure to set "L-2 SELECT" back to appropriate mode after editing.
- If you are not connecting a satellite receiver or a decoder to the AV2 (L-2) IN/DECODER connector, leave "L-2 SELECT" set to "AV".
- The default setting is "AV"; if the recorder's memory backup has expired due to a power cut or because the AC was removed from the recorder, "AV" will be automatically selected when the power is restored to the recorder. If you are using a satellite receiver or a decoder, be sure to set "L-2 SELECT" back to appropriate mode.
- When "L-2 SELECT" is set to "SAT", "SAT" appears on TV screen or front display panel instead of "L-2" or "L2".
- If "L-1 OUTPUT" is set to "S-VIDEO", it is impossible to set "L-2 SELECT" to "DECODER".

F-1 INPUT Setting

Set "F-1 INPUT" to the appropriate mode depending on the connector (VIDEO or S-VIDEO) being used on the front panel.

Perform steps **1** and **2** of "L-1 OUTPUT and L-1 INPUT Setting" on page 64.

1 Select the input mode for the VIDEO/S-VIDEO connector.

- Press Δ / ∇ to move the arrow to "F-1 INPUT", then press **OK**.
- Press Δ / ∇ to select the appropriate setting, then press **OK**.

* The default setting is **bold** in the table below.

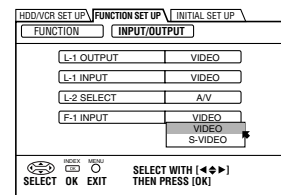

F-1 INPUT VIDEO:

When connecting an appliance to the VIDEO input connector, set to "VIDEO".

S-VIDEO: When connecting an appliance to the S-VIDEO input connector, set to "S-VIDEO".

2 Return to the normal screen.

Press **MENU**.

Edit To Or From Another Video Recorder

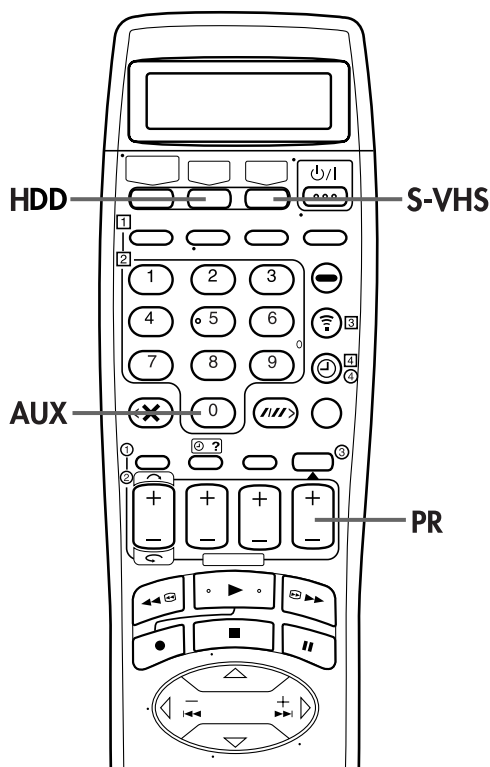

Advantages of S-VHS video recorders

You can edit from VHS to S-VHS, S-VHS to VHS, or, from S-VHS to S-VHS.

- From VHS to S-VHS: Record VHS playback signals in the S-VHS mode. Although the picture quality is inherently limited by that of the original, the edited tape has better picture quality than those made by VHS-to-VHS editing.
- From S-VHS to VHS: Because the picture quality of the source material is very high, the edited tape has better picture quality than those made by VHS-to-VHS editing.
- From S-VHS to S-VHS: All signals will be transferred with minimum degradation.

You can use your recorder as the source player or as the recording deck.

1 Make connections.

Connect the player's 21-pin SCART connector to the recorder's 21-pin SCART connector as illustrated on page 67.

- 1 When using your recorder as the source player ... connect its AV1 (L-1) IN/OUT connector to the recording deck.
- 2 When using your recorder as the recording deck ... connect its AV1 (L-1) IN/OUT or AV2 (L-2) IN/DECODER connector to the source player.
- 3 If another recorder is compatible with the Y/C signal ... connect your recorder's AV1 (L-1) IN/OUT connector to another recorder.

With 3 connection ...

- When using your recorder as the recording deck, set "L-1 INPUT" to "S-VIDEO" and "L-2 SELECT" to "AV" (☞ pg. 64, 65).
- When using your recorder as the source player, set "L-1 OUTPUT" to "S-VIDEO" (☞ pg. 64).

2 Select the recording deck.

Press **HDD** or **S-VHS**.

3 Set the input mode of recording deck.

With this video recorder, press **AUX** (number key "0") and/or **PR** to select "L-1" for the AV1 (L-1) IN/OUT connector, or "L-2" for the AV2 (L-2) IN/DECODER connector, depending on the connector being used.

- When using another recorder as the recording deck, refer to its instruction manual.
- When using the AV2 (L-2) IN/DECODER connector, set "L-2 SELECT" to "AV" (☞ pg. 65).

4 Set the edit mode.

See "PICTURE CONTROL" on page 77.

5 Start the source player.

Engage the Play mode of the source player.

6 Start the recording deck.

Engage the Record mode of the recording deck.

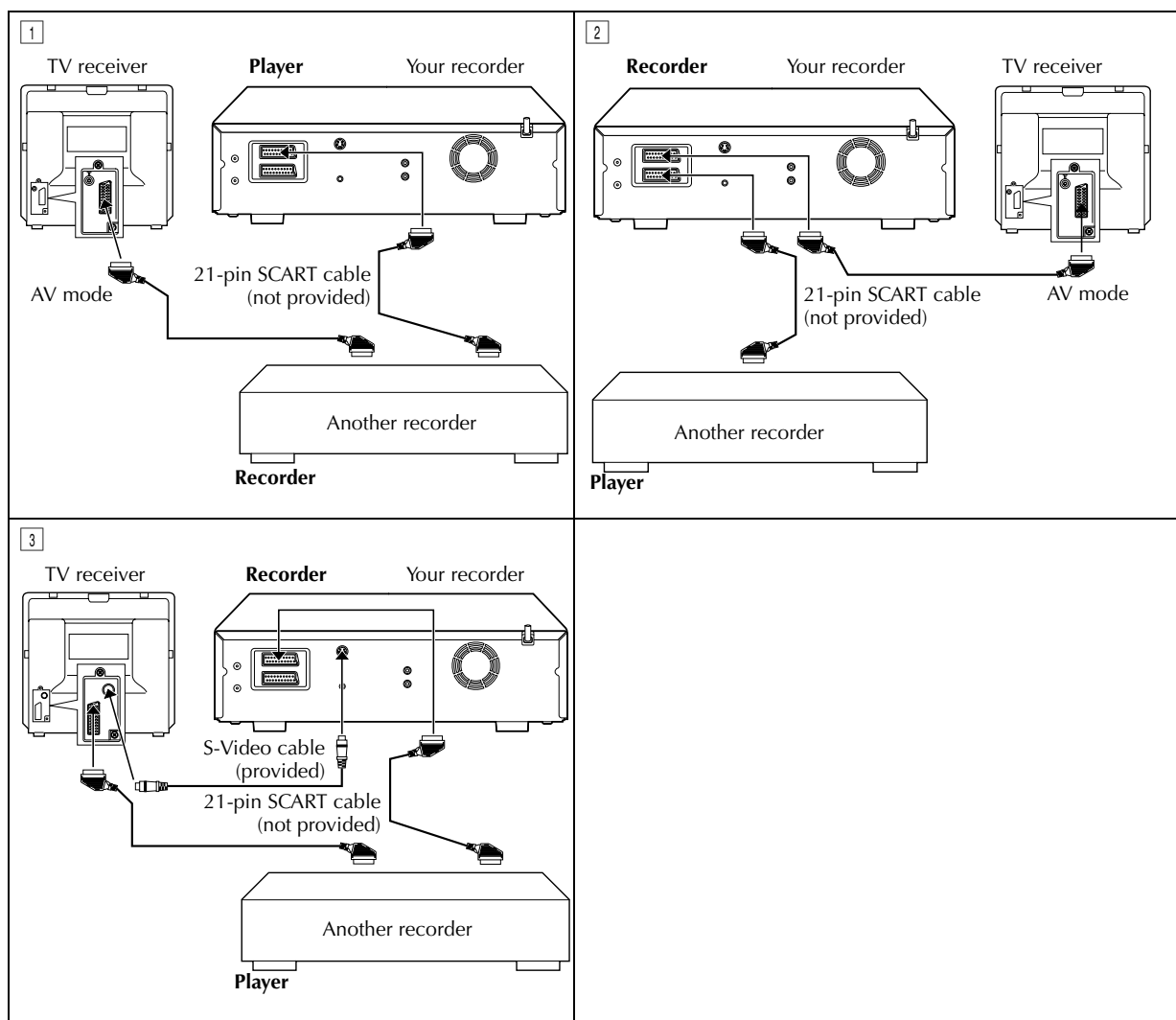

NOTES:

- All necessary cables can be obtained from your dealer.
- For Y/C signal input/output, be sure to use a 21-pin SCART cable that is compatible with the Y/C signal.
- When you select "EDIT" to dub tapes in step **1**, be sure to select "AUTO" (or "NORM" when "B.E.S.T." is set to "OFF") after you finish dubbing the tapes.
- When you use this recorder as the source player for editing, be sure to set "O.S.D." to "OFF" before starting (☞ pg. 78).
- If you are using another recorder with S-Video and Audio input/output connectors, you can connect those connectors to this recorder's S-VIDEO and AUDIO input/output connectors.
 - When using your recorder as the source player ...
 - ... connect its rear panel S OUT and AUDIO OUT connectors to the recording deck's S-Video and Audio input connectors.
 - When using your recorder as the recording deck ...
 - ... connect its front panel S-VIDEO and AUDIO input connectors to the source player's S-Video and Audio output connectors. Then, set the recorder's input mode to "F-1", and set "F-1 INPUT" to "S-VIDEO" (☞ pg. 65).

Audio Dubbing

Audio Dubbing replaces the normal audio sound of a previously recorded tape with a new soundtrack.

ATTENTION:

- Audio dubbing is not possible on the HDD deck.
- Audio dubbing is not possible with a cassette recorded in EP mode.

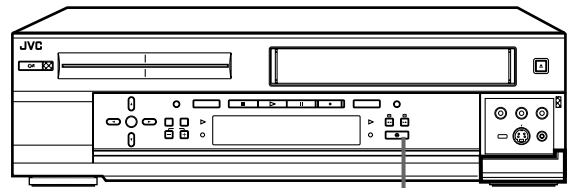
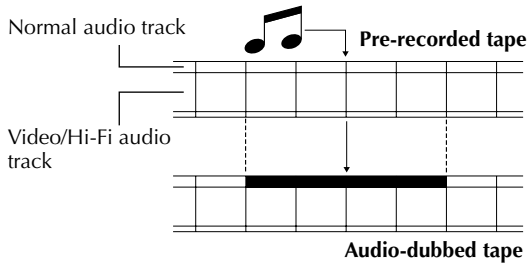

A.DUB

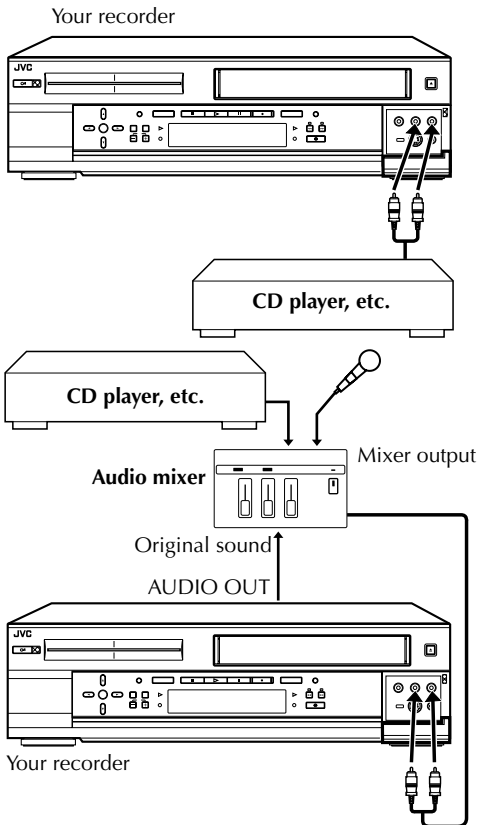
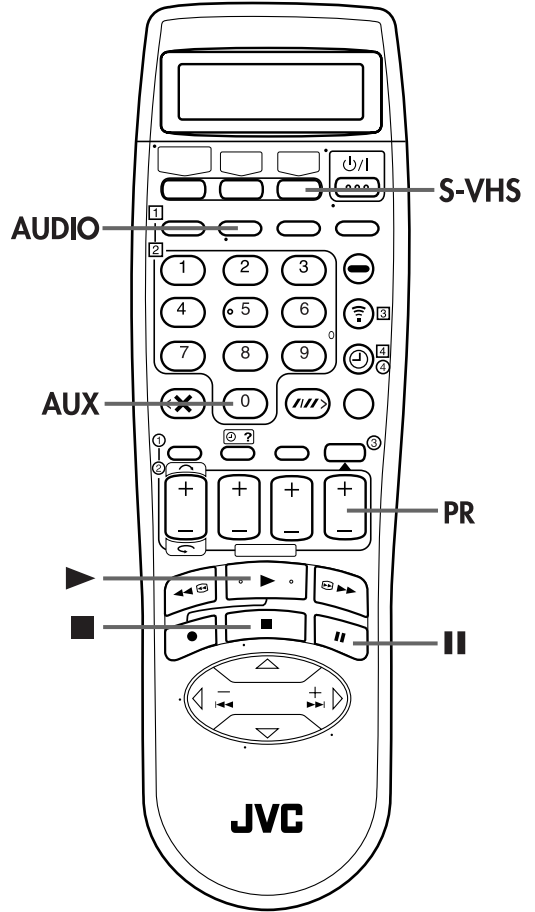

1 Make connections.

Connect an audio component to the AUDIO L + R input connectors on the recorder's front panel.

- When connecting a monaural audio component, use only the recorder's AUDIO L input connector.

2 Select the VHS deck.

Press **S-VHS**.

3 Set the recorder's input mode.

Press **AUX** (number key "0") and/or **PR** to select "F-1".

4 Locate the start point.

Press **▶** to start playback of the tape in your recorder, and press **II** when you reach the point where you want to start dubbing.

5 Engage the Audio Dubbing mode.

Press **A.DUB**.

- Your recorder enters the Audio Dubbing Pause mode. ("⦿" blinks, "▶" and "■" light up on the front display panel.)
- To perform Audio Dubbing with audio mixing, press **AUDIO** to select "L ▶ R" at this point.

* *Audio Dubbing with audio mixing is not possible if you are using a monaural audio component, or if you don't have an audio mixer.*

6 Start dubbing.

Engage the audio component's Play mode, then press **▶** to start the tape in your recorder; Audio Dubbing begins at this point.

- "⦿" blinks and "▶" is displayed on the front display panel.
- To stop dubbing temporarily, press **II**. Press **▶** to resume dubbing.

7 End Audio Dubbing.

Press **■** to stop the tape in your recorder, and engage the audio component's Stop mode.

NOTES:

- *When monitoring the sound during Audio Dubbing, the normal soundtrack is automatically selected. If you wish to hear the mixed sound (Hi-Fi + Normal soundtracks), press **AUDIO** to select "HI FI NORM" (☞ pg. 36).*
- *Audio Dubbing stops automatically when the counter reaches "0:00:00", and the recorder enters the Play mode. Check the counter reading before dubbing.*
- *Audio Dubbing is also possible using the rear panel AV1 (L-1) IN/OUT or AV2 (L-2) IN/DECODER connector. When using these 21-pin SCART connectors, be sure to select the correct input mode ("L-1" or "L-2") in step 3.*
- *Audio Dubbing is not possible with cassettes whose record safety tab has been removed.*
- *When playing back an audio-dubbed tape, press **AUDIO** to select the soundtrack you wish to hear. (☞ pg. 36)*

Connecting To A Satellite Receiver

Simple Connections

This is an example of simple connection if your TV has one 21-pin AV input (SCART) connector.

Connect the satellite receiver to the AV2 (L-2) IN/DECODER connector, then connect the AV1 (L-1) IN/OUT connector to the TV's connector.

NOTES:

- Set "L-2 SELECT" to "AVV" (☞ pg. 65).
- You can use Automatic Satellite Programme Recording function (☞ pg. 47) with this connection.
- To record a programme via the satellite receiver, select L-2 mode by pressing **AUX** (number key "0") and/or **PR** so that "L-2" appears on the front display panel.
- For details, refer to the instruction manual of the satellite receiver.

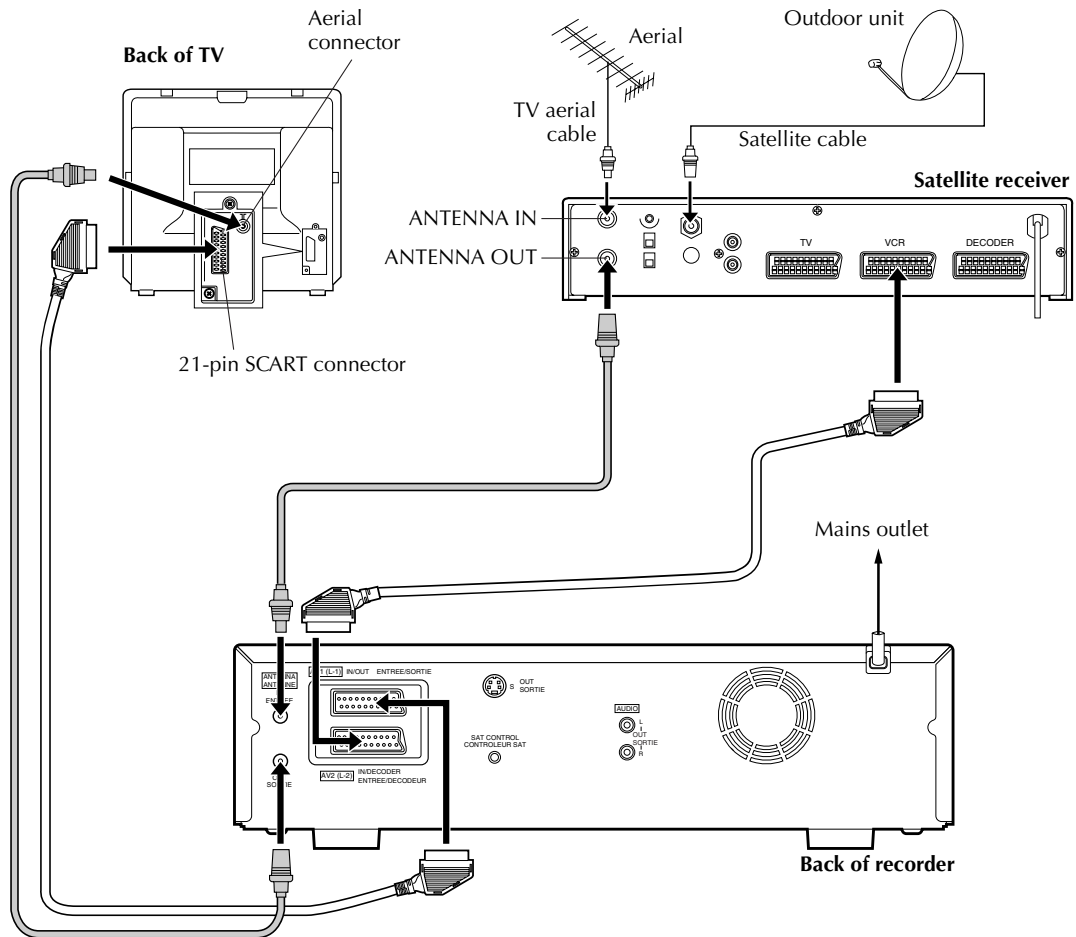

IMPORTANT

When you set "L-2 SELECT" to "SAT" (☞ pg. 65), it is possible to view a satellite broadcast with the TV set to its AV mode even if the recorder is turned off. When the recorder is in Stop mode or recording, press **TV/VCR** on the remote control to turn off the VCR indicator on the front display panel.

- If you turn on the recorder when the satellite receiver's power is off, nothing appears on the TV screen. In this case, turn on the satellite receiver, or set the TV to its TV mode, or press **TV/VCR** on the remote control to set the recorder to the video mode.

Perfect Connections

This is an example of recommended connection if your TV has two 21-pin AV input (SCART) connectors.

Connect the decoder to the satellite receiver's connector if you have a decoder, AV1 (L-1) IN/OUT connector to TV's connector, and AV2 (L-2) IN/DECODER connector to the satellite receiver's connector. Then connect the satellite receiver and TV.

NOTES:

- Set "L-2 SELECT" to "AV" (☞ pg. 65).
- You can use Automatic Satellite Programme Recording function (☞ pg. 47) with this connection.
- To record a programme via the satellite receiver, select L-2 mode by pressing **AUX (number key "0")** and/or **PR** so that "L-2" appears on the front display panel.
- To receive a scrambled broadcast, descramble the signal with the satellite receiver.
- For details, refer to the instruction manual of the satellite receiver and decoder.

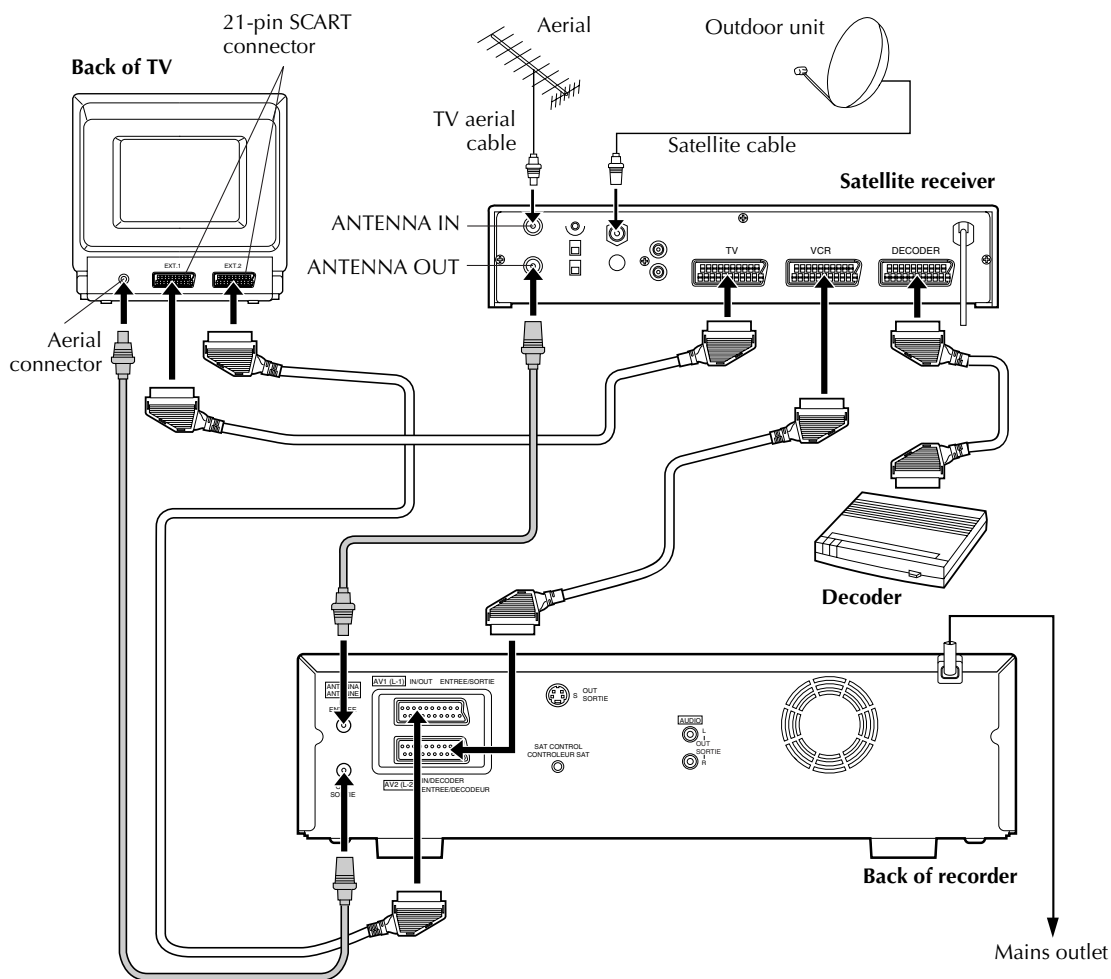

Connecting/Using A Decoder

The AV2 (L-2) IN/DECODER connector can be used as an input connector for an external decoder (descrambler). Simply connect a decoder and you can enjoy the variety of programming that is available through scrambled channels.

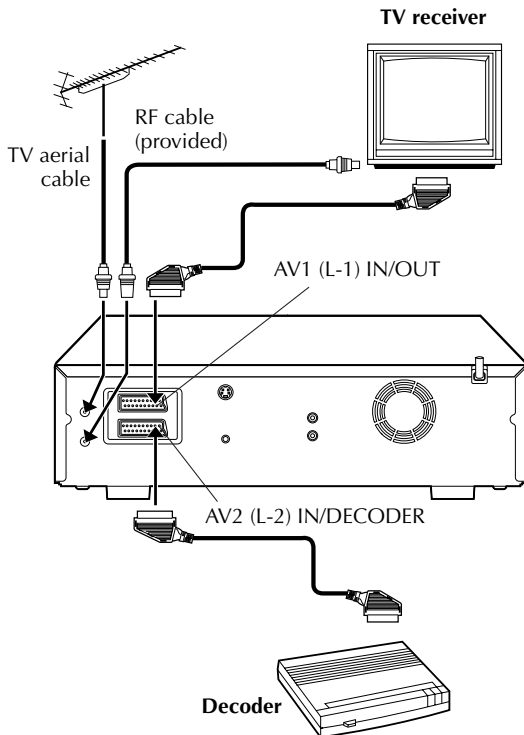

1 Select the input mode.

Set "L-2 SELECT" to "DECODER". (☞ pg. 65)

2 Connect the decoder.

Connect your recorder's AV2 (L-2) IN/DECODER connector to the decoder's 21-pin SCART connector using a 21-pin SCART cable.

3 Set the tuner.

Perform the procedure as described in "When Receiving A Scrambled Broadcast" on page 86.

Connecting/Using A Stereo System

These instructions enable you to connect your video recorder to your Hi-Fi stereo system (if you have one) and listen to the soundtrack through the stereo.

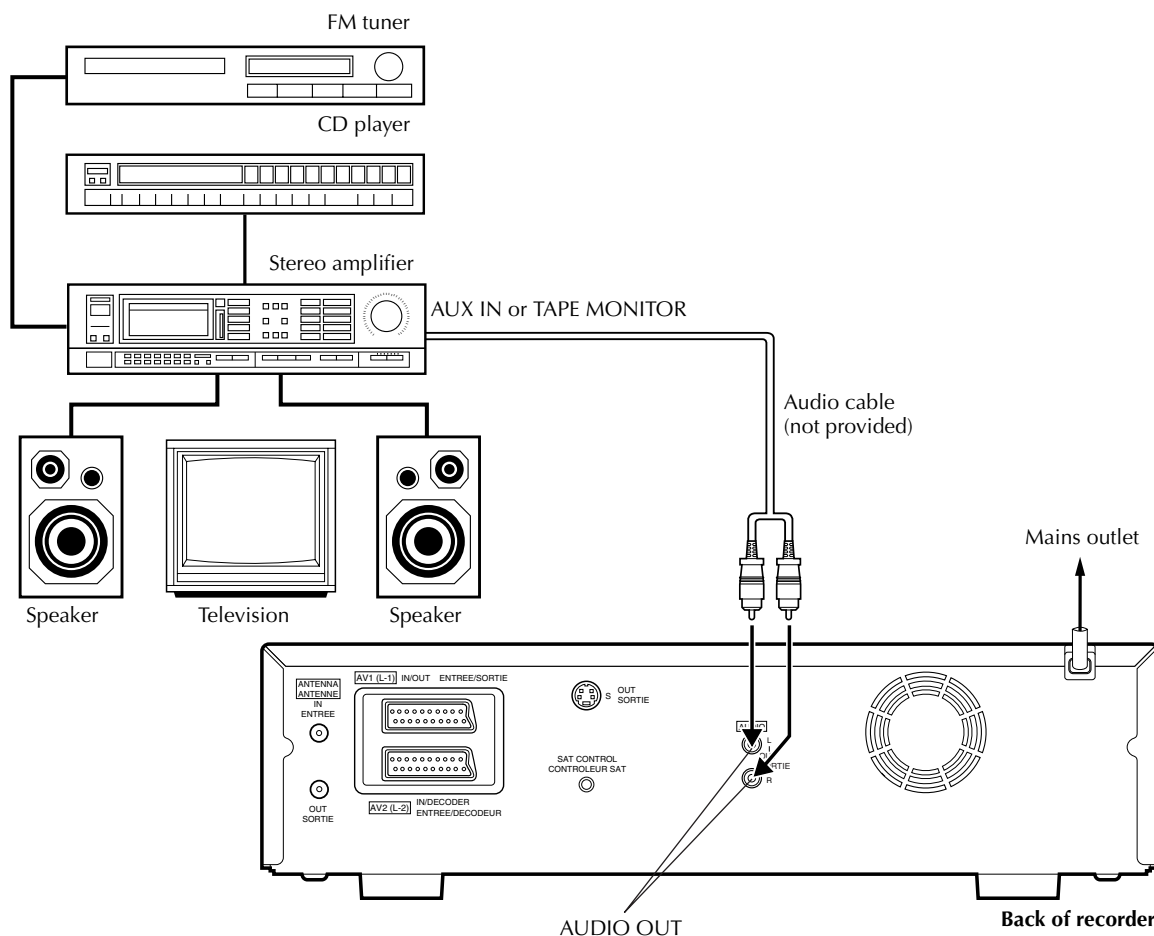

Make connections.

Connect the AUDIO OUT L and R connectors on your video recorder to the AUX IN or TAPE MONITOR connectors on your stereo system's receiver or amplifier.

NOTE:

When listening to sound through the connected stereo system, turn the TV's volume down completely.

CAUTIONS:

- This recorder has a dynamic range of more than 80 dB with regards to its Hi-Fi audio capability. It is recommended that you check the maximum level if you are going to listen to the Hi-Fi audio signals through a stereo amplifier. A sudden surge in the input level to the speakers may damage them.
- Some speakers and televisions are specially shielded to prevent television interference. If both are of the non-shielded type, do not place the speakers adjacent to the TV set as this can adversely affect the video playback picture.

Mode Set

Turn on the TV and select the AV mode.

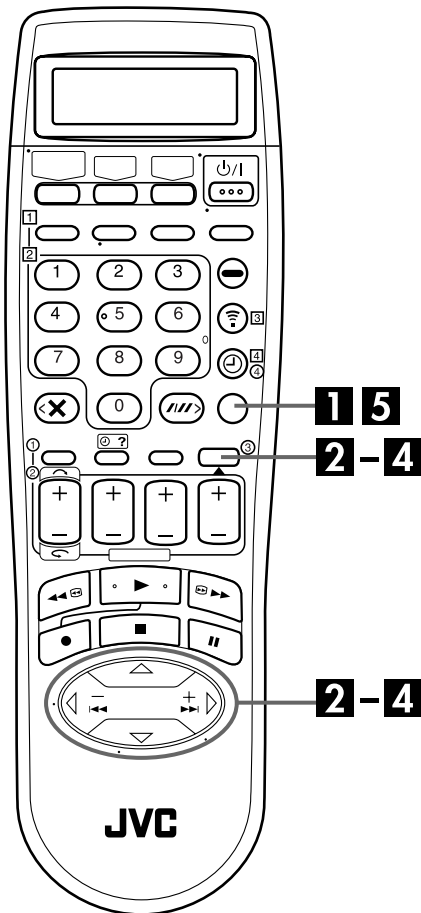

You can change various mode settings on the TV screen by following the procedure described below. The table below shows the structure of the menu system.

HDD/VCR SET UP	HDD SET UP (☞ pg. 75) VCR SET UP 1 (☞ pg. 75) VCR SET UP 2 (☞ pg. 77)
FUNCTION SET UP	FUNCTION (☞ pg. 78) INPUT/OUTPUT (☞ pg. 64)
INITIAL SET UP	TUNER SET (☞ pg. 80) INITIAL SET (☞ pg. 20, 79, 88)

- For each mode setting, see pages 75 to 78.
- The procedure shows how to set "LIVE MEMORY" to "3HR" on the "HDD SET UP" screen as an example.

1 Access the Main Menu screen.

Press **MENU**.

2 Access the HDD Set Up screen.

- 1 Press $\triangleleft \triangleright$ to move the arrow to "HDD/VCR SET UP", then press ∇ or **OK**.
- 2 Press $\triangleleft \triangleright$ to move the arrow to "HDD SET UP", then press **OK**.

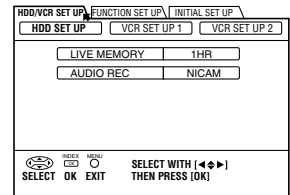

3 Select the mode.

Press $\triangle \nabla$ to move the arrow to "LIVE MEMORY", then press **OK**.

4 Select the mode setting.

Press $\triangle \nabla$ to select "3HR", then press **OK**.

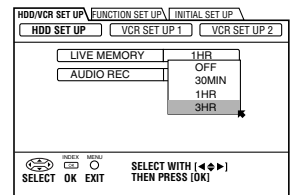

5 Return to the normal screen.

Press **MENU**.

HDD SET UP

* The default setting is **bold** in the table below.

<p>■ LIVE MEMORY OFF 30MIN 1HR 3HR</p>	<p>When this function is set to "30MIN", "1HR" or "3HR", you can enjoy the selected length of the time for "Live Memory Playback" (☞ pg. 26).</p>
<p>■ AUDIO REC NICAM MONO</p>	<p>When this function is set to "NICAM", the NICAM audio programme will be recorded. When this function is set to "MONO", the Standard (monaural) audio programme will be recorded.</p> <p>NOTE: <i>This function works only on the NICAM bilingual programme.</i></p>

VCR SET UP 1

* The default setting is **bold** in the table below.

<p>■ NAVIGATION ON OFF</p>	<p>When a programme is recorded on the cassette with this function set to "ON", you can use VCR Navigation (☞ pg. 32, 51).</p>
<p>■ S-VHS AUTO OFF</p>	<p>Your recorder can record in S-VHS (Super VHS), S-VHS ET or VHS.</p> <p>● To record in S-VHS: Set "S-VHS" to "AUTO". Then, insert a cassette marked "S-VHS". The S-VHS indicator lights up on the front display panel. The S-VHS recording mode is selected.</p> <p>● To record in S-VHS ET on a VHS cassette: See "Super VHS ET (S-VHS ET)" on page 39.</p> <p>● To record in VHS: Insert a cassette marked "VHS". If the S-VHS ET mode is activated, press S-VHS ET. "S-VHS ET : OFF" appears on the TV screen, if "O.S.D." is set to "ON". The VHS recording mode is automatically selected regardless of the "S-VHS" mode setting.</p> <p>● To record in VHS on an S-VHS cassette: Insert a cassette marked "S-VHS". The S-VHS indicator lights up on the front display panel. Then, set "S-VHS" to "OFF". The S-VHS indicator goes off. The VHS recording mode is selected.</p> <p>NOTE: <i>When playing back a tape that has been recorded in S-VHS or S-VHS ET, the S-VHS indicator lights up on the front display panel regardless of the "S-VHS" mode setting.</i></p>

VCR SET UP 1 (cont.)

* The default setting is **bold** in the table below.

<p>■ AUTO SP→LP TIMER ON OFF</p>	<p>When this function is set to “ON”, the recorder automatically switches to LP mode to allow complete recording if there is not enough tape to record the entire programme while timer-recording in SP mode.</p> <p>For Example . . . Recording a programme of 210 minutes in length onto a 180-minute tape</p> <table border="1" data-bbox="467 359 1055 417"> <tr> <td style="text-align: center;">Approximately 150 minutes</td> <td style="text-align: center;">Approximately 60 minutes</td> </tr> <tr> <td style="text-align: center;">SP mode</td> <td style="text-align: center;">LP mode</td> </tr> </table> <p style="text-align: center;">Total 210 minutes</p> <p>Make sure you set this function to “ON”, before the timer-recording starts.</p> <p>NOTES:</p> <ul style="list-style-type: none"> • If you have programmed the recorder to timer-record 2 or more programmes, the second programme and those thereafter may not fit on the tape if you set “AUTO SP→LP TIMER” to “ON”. In this case, make sure the mode is not engaged, then set the tape speed manually during timer programming. • In order to ensure that the recording fits on the tape, this feature may leave a slight non-recorded section at the end of the tape. • There may be some noise and sound disturbance at the point on the tape where the recorder switches from SP to LP mode. • The Auto SP→LP Timer feature is not available during ITR (Instant Timer Recording), and the feature will not work properly with any tapes longer than E-180, or with some tapes of shorter lengths. • If you perform timer recording with both VPS/PDC and the Auto SP→LP Timer activated, and the programme goes beyond its originally scheduled length, there may be times when the programme cannot be recorded in its entirety. 	Approximately 150 minutes	Approximately 60 minutes	SP mode	LP mode
Approximately 150 minutes	Approximately 60 minutes				
SP mode	LP mode				
<p>■ COLOUR SYSTEM PAL/NTSC MESECAM</p>	<p>You can play back PAL, NTSC and MESECAM tapes, or record PAL and SECAM* signals on this recorder. Select the appropriate colour system.</p> <p>PAL/NTSC: To record PAL signals, or play back a PAL or NTSC tape. MESECAM: To record SECAM signals, or play back a MESECAM tape.</p> <p>* SECAM signals will be recorded as MESECAM on this recorder; MESECAM is the designation for tapes with SECAM signals that have been recorded on a MESECAM-compatible PAL video cassette recorder.</p> <p>NOTES:</p> <ul style="list-style-type: none"> • It is not possible to record in S-VHS if “MESECAM” is selected. The recording mode is forced to change to VHS. • If “MESECAM” is selected when the tape speed is set to EP mode, the tape speed will be forced to change to LP mode. • It is not possible to select EP mode if “MESECAM” is selected. <p>About NTSC Playback</p> <ul style="list-style-type: none"> • Some TVs shrink the picture vertically and place black bars at the top and bottom of the TV screen. This is not a malfunction on the part of either the video recorder or the TV. • The picture may roll up and down. This can be corrected using the V-HOLD control found on some TVs. (This cannot be corrected if the TV does not have a V-HOLD control.) • The counter and tape remaining time readings will be incorrect. • During search, still, or frame-by-frame playback, the picture will be distorted, and there may be a loss of colour. • Depending on the type of TV, the top and bottom portions of superimposed displays may be cut off during NTSC playback. 				

VCR SET UP 2

* The default setting is **bold** in the table below.

<p>■ B.E.S.T. ON OFF</p>	<p>You can set the B.E.S.T. (Biconditional Equalised Signal Tracking) system to "ON" or "OFF" (☞ pg. 41).</p>
<p>■ PICTURE CONTROL AUTO EDIT SOFT SHARP</p>	<p>This feature helps you to adjust the playback picture quality according to your preference. Normally select "AUTO".</p> <p>AUTO: Provides the optimised picture benefits of the B.E.S.T. Picture System.</p> <p>EDIT: Minimizes picture degradation during editing (recording and playback).</p> <p>SOFT: Reduces image coarseness when viewing overlapped tapes containing a lot of noise.</p> <p>SHARP: Clearer, sharper-edged picture when viewing images with lots of flat, same-coloured surfaces such as cartoons.</p> <p>NOTES:</p> <ul style="list-style-type: none"> • When you select "EDIT", "SOFT" or "SHARP", the selected mode will not change until you select another mode. • When you select "EDIT" to dub tapes, be sure to select "AUTO" after you finish dubbing the tapes. • When "B.E.S.T." is "OFF", "PICTURE CONTROL" switches automatically from "AUTO" to "NORM".
<p>■ DIGITAL 3R ON OFF</p>	<p>When this function is set to "ON", the Digital 3R picture system applies edge correction to the luminance signal to enhance detail.</p> <p>NOTES:</p> <ul style="list-style-type: none"> • Normally it is recommended to keep "DIGITAL 3R" set to "ON". • Depending on the type of tape being used, picture quality may be better with "DIGITAL 3R" set to "OFF". • If you use the recorder as the source player for editing, be sure to set "DIGITAL 3R" to "OFF" before starting.
<p>■ DIGITAL TBC/NR ON OFF</p>	<p>Your recorder is equipped with the Digital TBC (Time Base Corrector) that removes jitter from fluctuating video signals to deliver a stable picture even with old tapes and rental cassettes.</p> <p>The on/off of Digital 3-DNR (Noise Reduction) which cuts noise and enables clear picture reproduction is also linked to this function.</p> <p>We recommend that you set "DIGITAL TBC/NR" to "ON" when...</p> <p>... playing back a tape recorded on a camcorder.</p> <p>... playing back a tape repeatedly used.</p> <p>... using this video recorder as the source player for editing.</p> <p>NOTES:</p> <ul style="list-style-type: none"> • If you play back a tape recorded under poor TV reception condition, the picture may become more stable with Digital TBC/NR set to off. • When "DIGITAL TBC/NR" is set to "ON", if you play back a tape where certain types of signals are recorded (using a PC or some character generators), the playback picture may be distorted. If this is the case, set "DIGITAL TBC/NR" to "OFF". • When playing back a MESECAM tape, Digital TBC/NR does not function even though "DIGITAL TBC/NR" is set to "ON".

VCR SET UP 2 (cont.)

* The default setting is **bold** in the table below.

<p>■ VIDEO STABILIZER ON OFF</p>	<p>When this function is set to "ON", you can automatically correct vertical vibration in the picture when playing back unstable recordings made on another recorder.</p> <p>NOTES:</p> <ul style="list-style-type: none"> • When you finish viewing a tape, be sure to set this function to "OFF". • Regardless of the setting, this function has no effect during recording and during special effects playback. • The on-screen display may jitter vertically when this function is set to "ON". • To watch recordings with close-caption, set this function to "OFF". • Video Stabilizer and Digital TBC/NR cannot be used at the same time. If you activate Digital TBC/NR when "VIDEO STABILIZER" is set to "ON", Video Stabilizer will be automatically turned "OFF".
---	--

FUNCTION

* The default setting is **bold** in the table below.

<p>■ O.S.D. ON OFF</p>	<p>When this function is set to "ON", various operational indicators appear on the TV screen. Messages appear in the selected language (☞ pg. 17, 18).</p> <p>NOTES:</p> <ul style="list-style-type: none"> • When you use this recorder as the source player for editing, be sure to set "O.S.D." to "OFF" before starting. • During playback, the operation mode indicators may be disturbed depending on the type of tape being used.
<p>■ AUTO TIMER ON OFF</p>	<p>When this function is set to "ON", the timer is automatically engaged when the recorder power is turned off, and automatically disengaged when the recorder is powered back on.</p> <p>NOTE:</p> <p>For safety, when "AUTO TIMER" is set to "OFF", all other recorder functions are disabled while the Timer mode is engaged. To disengage the timer, press ⊕ (TIMER).</p>
<p>■ DIRECT REC ON OFF</p>	<p>When this function is set to "ON", you can easily start recording the programme that you are watching on your TV. Press and hold ● and press ► on the remote control, or press ● on the recorder.</p> <p>NOTES:</p> <ul style="list-style-type: none"> • When you use the Direct Rec function, be sure to use a TV offering T-V LINK, etc. and connect a fully-wired 21-pin SCART cable between the recorder and the TV (☞ pg. 12). • If "DIRECT REC" is set to "OFF", the ● button functions as described in "Basic Recording" (☞ pg. 22, 30). • During the Direct Rec, "--" appears on the front display panel. • If a programme is recorded with the Direct Rec, the station name will not be registered for the Navigation. "----" will be displayed for the station name. • Retake function (☞ pg. 38) does not work during Direct Rec. • Even if there is no power supply for more than 60 minutes, the recorder keeps the setting. • If you use the remote control of your TV to record the programme with the Direct Rec, the programme will be recorded on the HDD deck, even if you select the VHS deck. In this case, first few seconds of the programme will not be recorded.

SHOWVIEW® System Setup

IMPORTANT

Normally, Auto Set Up (pg. 14), Preset Download (pg. 16) or Auto Channel Set (pg. 80) sets the Guide Program numbers automatically. You need to set the Guide Program numbers manually only in the following cases.

- When timer-programming with the SHOWVIEW system, the channel position, where the station you wish to record is received on your recorder, is not selected,
OR
when you add a channel after Auto Set Up, Preset Download or Auto Channel Set has taken place,
—Set the Guide Program number for that station manually.
- When you wish to timer-record a satellite programme with the SHOWVIEW system,
—Set the Guide Program numbers for all satellite broadcasts received on your satellite receiver.

Turn on the TV and select the AV mode.

Guide Program Number Set

1 Access the Main Menu screen.

Press **MENU**.

2 Access the Initial Set screen.

- 1 Press $\triangleleft \triangleright$ to move the arrow to "INITIAL SET UP", then press ∇ or **OK**.
- 2 Press $\triangleleft \triangleright$ to move the arrow to "INITIAL SET", then press **OK**.

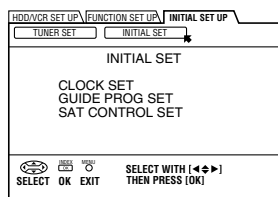

3 Access the Guide Program Set screen.

Press $\triangle \nabla$ to move the highlight bar (pointer) to "GUIDE PROG SET", then press **OK** or \triangleright .

4 Enter the Guide Program number.

Press $\triangle \nabla$ to enter the Guide Program number for the desired station as shown in the TV listings. Then press **OK** or \triangleright .

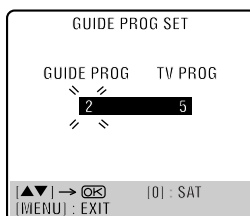

(Example) When inputting the Guide Program number 2 for ZDF.

5 Enter the receiving channel position number.

Press the **number key "0"** to select "TV PROG" or "SAT". Then press $\triangle \nabla$ to input the number of the recorder's channel position on which the Guide Program number's broadcast is received by the recorder or the satellite receiver. Then press **OK** or \triangleright .

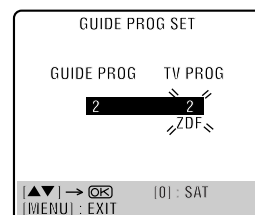

- To timer-record a satellite programme with the SHOWVIEW system, you need to install the provided Satellite Controller and perform the procedure described in "Satellite Receiver Control Setting" (pg. 19).
- Repeat steps 4 and 5 as necessary.

(Example) If ZDF is received on channel position 2.

6 Return to the normal screen.

Press **MENU**.

Guide Program Number

"Guide Program (GUIDE PROG) number" refers to the assigned TV station numbers, according to broadcast area, for the SHOWVIEW timer recording. The Guide Program numbers can be found in most TV listings.

Tuner Set

Turn on the TV and select the AV mode.

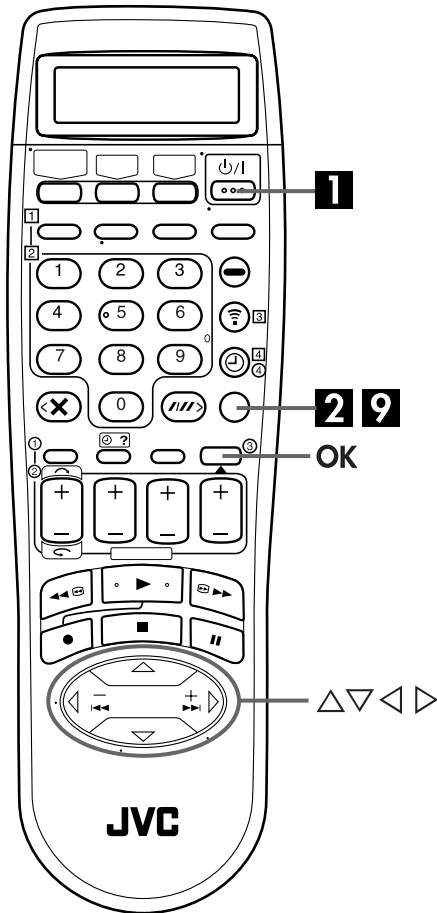

IMPORTANT

Perform the following steps only if —
 — Auto Channel Set has not been set correctly by Auto Set Up or by Preset Download (pg. 14, 16).
 — you have moved to a different area or if a new station starts broadcasting in your area.

Your recorder needs to memorize all necessary stations in channel positions in order to record TV programmes. Auto Channel Set automatically assigns all receivable stations in your area to call them up by using the **PR** buttons without going through any vacant channels.

Auto Channel Set

1 Turn on the recorder.

Press **⏻/I**.

2 Access the Main Menu screen.

Press **MENU**.

3 Access the Tuner Set screen.

- 1 Press **◀ ▶** to move the arrow to "INITIAL SET UP", then press **▽** or **OK**.
- 2 Press **◀ ▶** to move the arrow to "TUNER SET", then press **OK**.

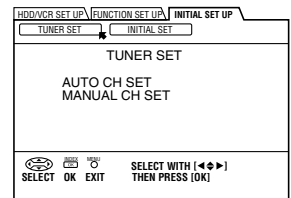

4 Access the Auto Channel Set screen.

Press **△▽** to move the highlight bar (pointer) to "AUTO CH SET", then press **OK** or **▶**.

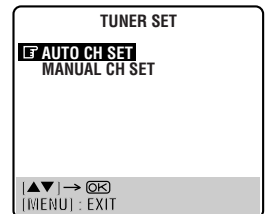

5 Select your country.

Press **△▽** to move the highlight bar (pointer) to your country's name, then press **OK** or **▶**.

6 Select the language.

Press **△▽** to move the highlight bar (pointer) to the language of your choice.

7 Perform Auto Channel Set.

Press **OK** twice.

- You can set up the recorder's tuner also by Preset Download. (☞ pg. 16)
- The Auto Set screen appears, and remains on screen while the recorder searches for receivable stations. As Auto Channel Set progresses, the "█" mark on the TV screen moves from left to right. Wait until the TV screen as shown in step 8 appears.

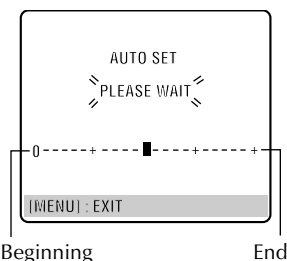

Beginning

End

IMPORTANT

- In certain reception conditions, station names may not be stored correctly, and Auto Guide Program Number Set may not work properly. If the Guide Program numbers are not set properly when you timer-record a TV programme using the SHOWVIEW system, the recorder will record a TV programme of a different station. When programming the timer using the SHOWVIEW system, be sure to check the desired channel is selected correctly (☞ pg. 42, "SHOWVIEW Timer Programming").
- Your video recorder memorizes all detected stations even if reception of some of them is poor. You can delete those stations with an unacceptable picture (☞ pg. 83, "Delete A Channel").

8 View the Confirmation screen.

After "SCAN COMPLETED" is displayed on the TV screen for about 5 seconds, the Confirmation screen looking like the one to the right appears. The stations your recorder located appear on a Confirmation screen — channel positions (PR), channels (CH) and station names (ID — ☞ pg. 87). The blueback screen and the programme currently being broadcast by the blinking station appear alternately for 8 seconds each. To view the next page, use the $\Delta \nabla \triangleleft \triangleright$ button on the remote control.

PR	CH	ID	PR	CH	ID
01	25	ARD	08	C26	E.SP
02	C08	SKY1	09	55	WEST
03	10	ZDF	10	C24	SAT1
04	C65	RAI1	11	C23	OSF
05	C31	BBC1	12	---	---
06	C32	BBC2	13	---	---
07	C33	3SAT	14	---	---

$\blacktriangle \blacktriangleright$: EDIT
 \rightarrow | \times : DELETE
 [MENU] : EXIT

- The stations located in the selected country appear at the top of the list.
- The Guide Program numbers will also be set automatically during Auto Channel Set.

9 Return to the normal screen.

Press **MENU**.

- Using the Confirmation screen, you can skip or add channel positions, enter station names and perform other operations. Refer to pages 82 – 86 for the procedures.
- Depending on reception conditions, the stations may not be stored in order, and the station names may not be stored correctly.
- For information on scrambled broadcasts, refer to page 86.

NOTES:

- Fine tuning is performed automatically during Auto Channel Set. If you want to perform tuning manually, refer to page 86.
- If you perform Auto Channel Set when the aerial cable is not connected properly, "SCAN COMPLETED –NO SIGNAL–" appears on the TV screen in step 8. When this happens, make sure of the aerial connection and press **OK**; Auto Channel Set will take place again.
- If no sound accompanies the picture or the audio sounds unnatural on some channels that have been stored by Auto Set Up, the TV system setting for those channels may be incorrect. Select the appropriate TV system for those channels (☞ pg. 86, "INFORMATION").

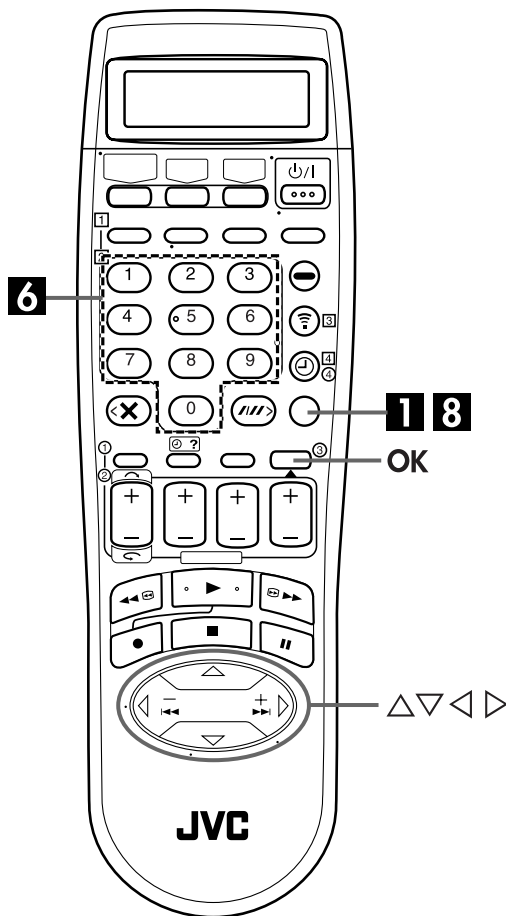

Manual Channel Set

Store channels that were not stored during Auto Set Up (☞ pg. 14), Preset Download (☞ pg. 16) or Auto Channel Set (☞ pg. 80).

1 Access the Main Menu screen.

Press MENU.

2 Access the Tuner Set screen.

- Press ◀▶ to move the arrow to "INITIAL SET UP", then press ▼ or OK.
- Press ◀▶ to move the arrow to "TUNER SET", then press OK.

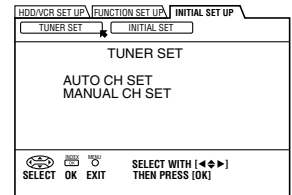

3 Access the Confirmation screen.

Press ▲▼ to move the highlight bar (pointer) to "MANUAL CH SET", then press OK or ▶. The Confirmation screen appears.

4 Select the channel position.

Press ▲▼ ◀▶ until an open position in which you want to store a channel begins blinking, then press OK. The Manual Channel Set screen appears.

- The blueback screen and the programme currently being broadcast by the selected channel appear alternately for 8 seconds each.

PR	CH	ID	PR	CH	ID
01	25	ARD	08	C26	E-SP
02	C08	SKY1	09	55	WEST
03	10	ZDF	10	C24	SAT1
04	C65	RAI1	11	C23	OSF
05	C31	BBC1	12	---	---
06	C32	BBC2	13	---	---
07	C33	3SAT	14	---	---

Navigation options shown below the table:

- ▲▼ : SELECT
- ◀▶ : CURSOR ←→
- OK : OK
- IMENU : EXIT

(Example) To store in position 12.

5 Select the band.

Press ▲▼ to change the band between CH (regular) and CC (cable), then press ▶.

PR	CH	ID	FINE	DECODER
12	CH01	---	+/-	OFF

Navigation options shown below the table:

- ▲▼ : SELECT
- ◀▶ : CURSOR ←→
- OK : OK
- IMENU : EXIT

6 Input the channel.

Press the **number keys** to input the channel number you want to store.

- Input "0" before any single number entries.
- To input the registered station name (ID – [☞](#) pg. 87), press $\Delta \nabla$ until "----" (ID setting) begins blinking, then press $\Delta \nabla$.
- For fine tuning adjustment, press \triangleright until "+/-" begins blinking, then press $\Delta \nabla$. While tuning, "+" or "-" appears.
- When storing a channel that sends scrambled broadcasts, press \triangleright until "OFF" (Decoder setting) blinks, then press $\Delta \nabla$ to set "DECODER" to "ON" ("OFF" is the default setting).
- When "L-2 SELECT" is set to "AV" or "SAT", the "DECODER" setting cannot be changed ([☞](#) pg. 65).

7 Enter new channel information.

Press **OK** and the Confirmation screen appears.

- Repeat steps **4** – **7** as necessary.

8 Close the Confirmation screen.

Press **MENU**.

- To change positions, see "Change Station Channel Position" ([☞](#) pg. 84).
- If you wish to set station names other than the ones registered in your recorder, see "Set Stations (B)" ([☞](#) pg. 85).

ATTENTION

Guide Program numbers are not set when channels are stored manually. If an attempt is made at timer programming with the SHOWVIEW system in this state, "SET GUIDE PROG THEN RETRY" appears on the TV screen; set the Guide Program Numbers ([☞](#) pg. 79) manually.

Delete A Channel

Perform steps **1** and **3** of "Manual Channel Set" on page 82 to access the Confirmation screen before continuing.

1 Select the item.

Press $\Delta \nabla \triangleleft \triangleright$ until the item you want to delete begins blinking.

2 Delete a channel.

Press **X**.

- The item directly beneath the cancelled one moves up one line.
- Repeat steps **1** and **2** as necessary.

3 Close the Confirmation screen.

Press **MENU**.

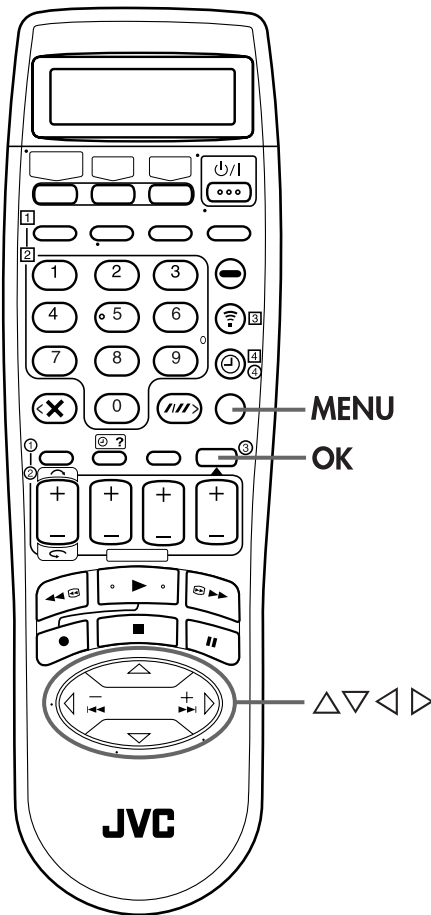

Change Station Channel Position

Perform steps **1** and **3** of “Manual Channel Set” on page 82 to access the Confirmation screen before continuing.

1 Select the item.

Press $\Delta \nabla \triangleleft \triangleright$ until the item you want to move begins blinking. Then press **OK** and the station name (ID) and its channel (CH) number begin blinking.

2 Select the new position.

Press $\Delta \nabla \triangleleft \triangleright$ to move the station to the new channel position, then press **OK**.

Example: If you moved the station in position 4 to position 2, the stations originally in positions 2 and 3 each move down one space.

PR	CH	ID	PR	CH	ID
01	25	ARD	08	C26	E-SP
02	C08	SKY1	09	55	WEST
03	10	ZDF	10	C24	SAT1
04	C65	RAI1	11	C23	OSF
05	C31	BBC1	12	C25	ESPM
06	C32	BBC2	13	----	----
07	C33	3SAT	14	----	----

$\Delta \nabla \triangleleft \triangleright$: MOVE
 OK : MANUAL CH SET
 [MENU] : EXIT

PR	CH	ID	PR	CH	ID
01	25	ARD	08	C26	E-SP
02	C65	RAI1	09	55	WEST
03	C08	SKY1	10	C24	SAT1
04	10	ZDF	11	C23	OSF
05	C31	BBC1	12	C25	ESPM
06	C32	BBC2	13	----	----
07	C33	3SAT	14	----	----

$\Delta \nabla \triangleleft \triangleright$: MOVE \rightarrow OK
 [MENU] : EXIT

- Repeat steps **1** and **2** as necessary.

3 Close the Confirmation screen.

Press **MENU**.

Set Stations (A)

Set station names that are registered in your recorder.

Perform steps **1** and **3** of "Manual Channel Set" on page 82 to access the Confirmation screen before continuing.

1 Select the item.

Press $\Delta \nabla \triangleleft \triangleright$ until the item you want begins blinking.

2 Access the Manual Channel Set screen.

Press **OK** twice.

3 Select the new station.

Press \triangleright until the station name (ID) begins blinking, then press $\Delta \nabla$ until the new station's name (ID) you want to store begins blinking. Registered station names (☞ pg. 87) appear as you press $\Delta \nabla$.

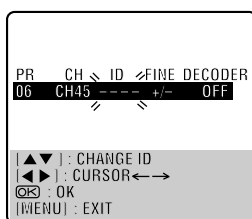

4 Switch the stations.

Press **OK**.

- The Confirmation screen appears.
- Repeat steps **1** – **4** as necessary.

5 Close the Confirmation screen.

Press **MENU**.

Set Stations (B)

Set station names other than the ones registered in your recorder.

Perform steps **1** and **3** of "Manual Channel Set" on page 82 to access the Confirmation screen and then perform steps **1** and **2** of "Set Stations (A)" in the left column before continuing.

1 Select the character for station name.

Press \triangleright until the first letter of the station name begins blinking.

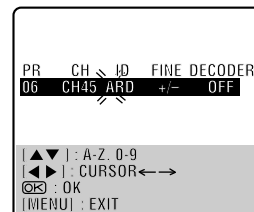

2 Enter the new character.

Press $\Delta \nabla$ to cycle through the characters (A–Z, 0–9, –, *, +, _ (space)) and stop when the desired character is indicated, then press \triangleright to enter. Enter the remaining characters the same way (maximum of 4). After entering all characters, press **OK**.

- The Confirmation screen appears.
- If you make a mistake, press \triangleleft until the incorrect character begins blinking. Then enter the correct character by pressing $\Delta \nabla$.

3 Close the Confirmation screen.

Press **MENU**.

NOTE:

The characters available for the station name (ID) are A–Z, 0–9, –, *, +, _ (space) (maximum of 4).

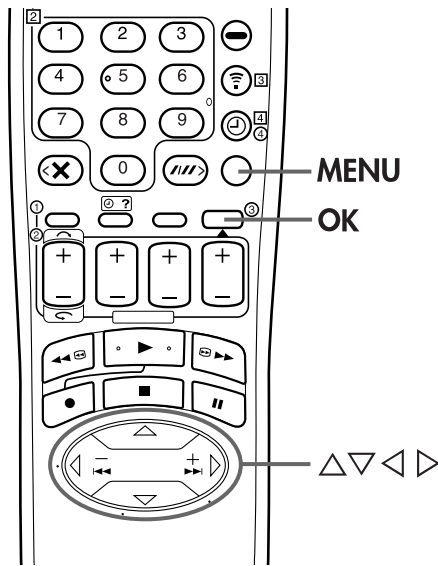

When Receiving A Scrambled Broadcast

1 Select the decoder mode.

Set "L-2 SELECT" to "DECODER" (pg. 65).

2 Access the Confirmation screen.

Perform steps 1 and 3 of "Manual Channel Set" on page 82.

3 Select the position.

Press $\Delta \nabla \triangleleft \triangleright$ to select the channel position broadcasting scrambled programmes, then press **OK** twice.

4 Change the decoder setting.

Press \triangleright until "OFF" (decoder setting) begins blinking, and set it to "ON" by pressing $\Delta \nabla$.

5 Return to the Confirmation screen.

Press **OK**.
 • Repeat steps 3 – 5 as necessary.

6 Close the Confirmation screen.

Press **MENU**.

Fine-Tuning Channels Already Stored

Perform steps 1 and 2 of "Manual Channel Set" on page 82 to access the Confirmation screen before continuing.

1 Select the channel to fine-tune.

Press $\Delta \nabla \triangleleft \triangleright$ until the channel you want to tune begins blinking.

2 Access the Manual Channel Set screen.

Press **OK** twice. The Manual Channel Set screen appears.

3 Perform tuning.

Press \triangleright until "+/-" begins blinking, then press $\Delta \nabla$ until the picture is its clearest. Then press **OK**.

- The Confirmation screen appears.
- Repeat steps 1 – 3 as necessary.

4 Close the Confirmation screen.

Press **MENU**.

INFORMATION

If you live in Eastern Europe, "TV SYSTEM" setting appears instead of "DECODER" setting on the Manual Channel Set screen. When you can see the picture but can hear no audio, select appropriate TV system (D/K or B/G). Normally, TV programmes are broadcasted as follows.

For Eastern Europe : D/K
 For Western Europe : B/G

- 1 Select a country in Eastern Europe in step 5 on page 80.
- 2 Press \triangleright until the TV system (D/K or B/G) blinking on the Manual Channel Set screen in step 5 on page 82.
- 3 Press $\Delta \nabla$ to select appropriate TV System (D/K or B/G).

TV Station And ID List

ID*	STATION NAME
1000	TV1000
3SAT	3SAT
ADLT	ADULT
ANT3	ANTENA3
ARD	ARD
ARTE	ARTE
BBC	BBC GROUP
BBC1	BBC1
BBC2	BBC2
BR3	BAYERN3
C+	CANAL PLUS
C1	PORTUGUSES
CAN5	CANALE5
CANV	KETNET CANVAS
CH4	CHANNEL4
CH5	CHANNEL5
CHLD	CHILD
CINE	CINEMA
CLUB	TELECLUB
CMT	CMT
CNN	CNN
CSUR	ANDALUCIA
DISC	DISCOVERY
DR	DR TV
DRS	DRS
DSF	DSF
ETB1	ETB1
ETB2	ETB2
EURO	EURONEWS
EUSP	EUROSPORTS
FEMM	FEMMAN
FILM	FILM
FNET	FILMNET
FR2	France2
FR3	France3
GALA	GALAVISION
HR3	HESSEN3
INFO	INFO-KANAL
ITA1	ITALIA1
ITA7	ITALIA7
ITV	ITV
JSTV	JSTV
KA2	KA2
KAB1	KABEL1
KAN2	KANAL2
LOCA	LOCAL
M6	M6
MBC	MBR
MCM	MCM
MDR	MDR
MOVE	MOVIE
MTV	MTV
MTV3	MTV3
N3	NORD3
N-TV	N-TV
NBC	NBC SUPER
NDR3	NDR
NED1	NED1
NED2	NED2
NED3	NED3
NEWS	
NICK	NICKELODEON
NRK	NRK
NRK2	NRK2
ODE	ODEON
ORF1	ORF1
ORF2	ORF2

ID*	STATION NAME
ORF3	ORF3
OWL3	OWL3
PREM	PREMIERE
PRO7	PRO7
RAI1	RAI1
RAI2	RAI2
RAI3	RAI3
RET4	RETE4
21	TELE21
RTBF	RTBF1 or 2
RTL	RTL
RTL2	RTL2
RTL4	RTL4
RTL5	RTL5
RTP	RTP
S4	SCHWEIZ4
SAT1	SAT1
SBS	SBS
SHOW	SHOW
SIC	SOCIEDADE
SKY	SKY CHANNEL
SKYN	SKY NEWS
SPRT	SPORT
SRTL	SUPER RTL
STAR	STAR-TV
SVT1	SVT1
SVT2	SVT2
SWR	SUEDWEST3
TCC	TCC
TELE	TELE
TEL5	TELE5
TF1	TF1
TM3	TM3
TMC	TELEMONTECARLO
TNT	TNT INT
TRT	TRT INT
TSI	TSI
TSR	TSR
TV1	BRTN TV1
TV2	TV2
TV3	TV3
TV4	TV4
TV5	TV5
TV6	TV6
TVE1	TVE1
TVE2	TVE2
TVG	TV GALICIA
TVI	TV INDEPENDENT
TVN	TV NORGE
VCR	VIDEO
VERO	VERONICA
VH-1	VH-1
VIVA	VIVA
VIV2	VIVA2
VMTV	VIDEO MUSIC
VOX	VOX
VT4	VT4
VTM	VTM
WDR1	West1
WDR3	West3
YLE1	YLE1
YLE2	YLE2
ZDF	ZDF
ZTV	ZTV

* The "ID" abbreviation is what is shown on-screen in lieu of the station name. The "ID" abbreviation is listed in the Confirmation screen and is displayed on the TV screen when the recorder is tuned to a different station.

Clock Set

Turn on the TV and select the AV mode.

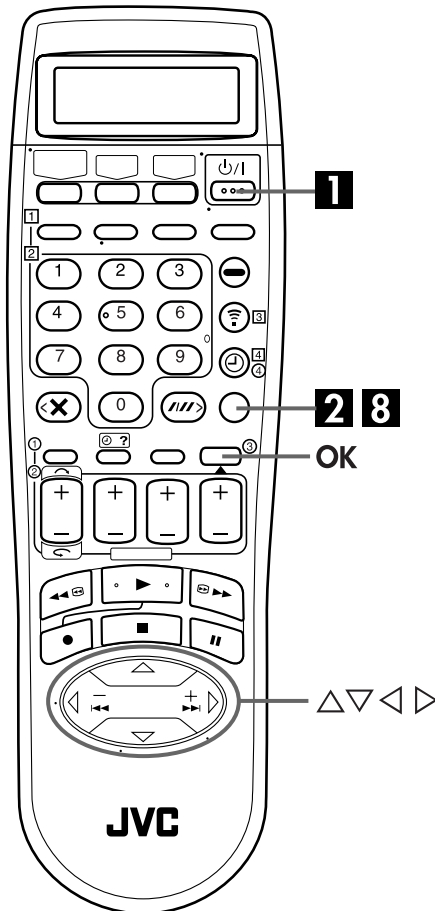

Just Clock

The Just Clock function provides accurate time keeping through automatic adjustments at regular intervals, by reading data from a PDC signal.

The Just Clock option can be set "ON" or "OFF" at the Clock Set screen (the default setting is "OFF"). Press **OK** until the Just Clock setting begins blinking, then press $\Delta \nabla$ to change the setting.

IMPORTANT: If you turn off Just Clock, the accuracy of your recorder's built-in clock may be reduced, which could adversely effect timer recording. We recommend you to keep Just Clock on. In cases where the clock setting data from a PDC signal is incorrect, however, you are advised to keep Just Clock set to "OFF".

IMPORTANT

If you performed Auto Set Up (pg. 14), Preset Download (pg. 16) or Auto Channel Set (pg. 80), without ever having set the clock previously, the recorder's built-in clock is also set automatically.

Perform the following steps only if —

—Auto Clock Set has not been performed correctly by Auto Set Up, Preset Download or Auto Channel Set.

OR

—the recorder's memory backup has expired.

OR

—you want to change Just Clock setting (pg. "Just Clock" in the left column).

1 Turn on the recorder.

Press power .

2 Access the Main Menu screen.

Press **MENU**.

3 Access the Initial Set screen.

1 Press $\triangleleft \triangleright$ to move the arrow to "INITIAL SET UP", then press ∇ or **OK**.

2 Press $\triangleleft \triangleright$ to move the arrow to "INITIAL SET", then press **OK**.

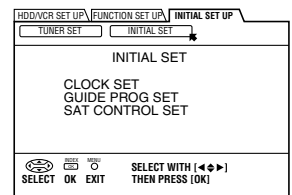

4 Access the Clock Set screen.

Press $\Delta \nabla$ to move the highlight bar (pointer) to "CLOCK SET", then press **OK** or \triangleright . The Clock Set screen appears.

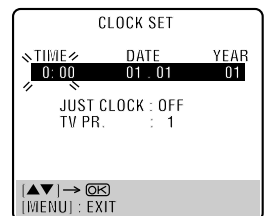
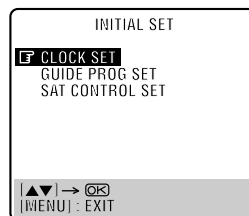

NOTE:

When you have selected *MAGYARORSZÁG (36)*, *ČESKÁ REPUBLIKA (42)*, *POLSKA (48)*, or *OTHER EASTERN EUROPE (EE)* for the country setting (pg. 14, 18), you cannot use Just Clock function. Skip steps **3** and **4** on page 89.

5 Set the date and time.

Press $\Delta\nabla$ to set the time, then press **OK** or \triangleright . The "DATE" display begins blinking. Repeat the same procedure to set the date and year.

- When you set the time, press and hold $\Delta\nabla$ to change the time by 30 minutes.
- When you set the date, press and hold $\Delta\nabla$ to change the date by 15 days.

6 Set Just Clock.

The default setting is "OFF". Set as desired by pressing $\Delta\nabla$, then press **OK** or \triangleright .

- For the Just clock function, refer to "Just Clock" on page 88.
- If you set to "OFF", you can disregard the next step as you won't be able to receive regular clock adjustments.

7 Set the source channel position for clock data.

The recorder is preset to receive clock setting and adjustment data from channel position 1. Press $\Delta\nabla$ to set the channel position to the number representing the station transmitting clock setting data, then press **OK** or \triangleright .

8 Start the clock operation.

Press **MENU**.

NOTES:

- *Just Clock* (when set to "ON") adjusts the recorder's built-in clock every hour, except for 23:00, 0:00, 1:00 and 2:00.
- *Just Clock* is not effective when ...
 - ... the recorder's power is on.
 - ... the recorder is in the Timer mode.
 - ... a difference of more than 3 minutes exists between the built-in clock's time and the actual time.
 - ... the recorder is in the Automatic Satellite Programme Recording mode (☞ pg. 47).
 - ... "L-2 SELECT" is set to "SAT" (☞ pg. 65).
- If *Just Clock* is set to "ON", the recorder's clock is automatically adjusted at the start/end of Summer Time.
- *Just Clock* may not function properly depending on the reception condition.

Before requesting service for a problem, use this chart and see if you can repair the trouble yourself. Small problems are often easily corrected, and this can save you the trouble of sending your video recorder off for repair.

POWER

SYMPTOM	POSSIBLE CAUSE	CORRECTIVE ACTION
1. No power is supplied to the recorder.	● The mains power cord is disconnected.	Connect the mains power cord.
2. The clock is functioning properly, but the recorder cannot be powered.	● "⊖" is displayed on the front display panel with "AUTO TIMER" set to "OFF".	Press the ⊖ button to turn the "⊖" indicator off.
3. The remote control won't function.	● The batteries are discharged.	Replace the dead batteries with new ones.

TAPE TRANSPORT

SYMPTOM	POSSIBLE CAUSE	CORRECTIVE ACTION
1. The tape does not run during recording.	● "⏏" is displayed on the front display panel.	Press ▶ to turn the "⏏" indicator off.
2. The tape will not rewind or fast-forward.	● The tape is already fully rewound or fast-forwarded.	Check the cassette.









PLAYBACK

SYMPTOM	POSSIBLE CAUSE	CORRECTIVE ACTION
1. The playback picture does not appear while the tape is running.	● The TV receiver is not set to the AV mode.	Set the TV to its AV mode.
2. Noise appears during visual search.	● This is normal.	
3. Noise appears during normal playback.	● The automatic tracking mode is engaged.	Try manual tracking. (☞ pg. 36)
4. The playback picture is blurred or interrupted while TV broadcasts are clear or "USE CLEANING CASSETTE" message appears on the screen.	● The video heads may be dirty.	Use a dry cleaning cassette TCL-2UX or consult your JVC dealer.
5. Breaks are noticeable in Hi-Fi soundtrack.	● The automatic tracking mode is engaged.	Try manual tracking. (☞ pg. 36)

RECORDING

SYMPTOM	POSSIBLE CAUSE	CORRECTIVE ACTION
1. Recording cannot be started.	<ul style="list-style-type: none"> ● There is no cassette loaded, or the cassette loaded has had its record safety tab removed. 	Insert a cassette, or using adhesive tape, cover the hole where the tab was removed.
2. TV broadcasts cannot be recorded.	<ul style="list-style-type: none"> ● "L-1", "L-2", "F-1", "DUB" or "SAT" has been selected as the input mode. 	Set to the desired channel.
3. Tape-to-tape editing is not possible.	<ul style="list-style-type: none"> ● The source (another video recorder, camcorder) has not been properly connected. ● All necessary power switches have not been turned on. ● The input mode is not correct. 	<p>Confirm that the source is properly connected.</p> <p>Confirm that all units' power switches are turned on.</p> <p>Set the input mode to "L-1", "L-2" or "F-1".</p>
4. Camcorder recording is not possible.	<ul style="list-style-type: none"> ● The camcorder has not been properly connected. ● The input mode is not correct. 	<p>Confirm that the camcorder is properly connected.</p> <p>Set the input mode to "L-1", "L-2" or "F-1".</p>

TIMER RECORDING

SYMPTOM	POSSIBLE CAUSE	CORRECTIVE ACTION
1. Timer recording won't work.	<ul style="list-style-type: none"> • The clock and/or the timer have been set incorrectly. • The timer is not engaged. 	<p>Re-perform the clock and/or timer settings.</p> <p>Press  and confirm that "" is displayed on the front display panel.</p>
2. Timer programming is not possible.	<ul style="list-style-type: none"> • Timer recording is in progress. 	<p>Timer programming can't be performed while a timer recording is in progress. Wait until it finishes.</p>
3. "  and "  " on the front display panel won't stop blinking.	<ul style="list-style-type: none"> • The timer is engaged but there's no cassette loaded. • The loaded cassette has had its record safety tab removed. • The end of the tape was reached during timer recording. 	<p>Load a cassette with the record safety tab intact, or cover the hole using adhesive tape.</p> <p>Remove the cassette and cover the hole with adhesive tape, or insert a cassette with the record safety tab intact.</p> <p>The programme may not have been recorded in its entirety. Next time make sure you have enough time on the tape to record the entire programme.</p>
4. "  blinks for 10 seconds and the Timer mode is disengaged.	<ul style="list-style-type: none"> •  has been pressed when there are no programs in memory. 	<p>Check the programmed data and re-program as necessary, then press  again.</p>
5. The SHOWVIEW system does not timer-record properly.	<ul style="list-style-type: none"> • The recorder's channel positions have been set incorrectly. 	<p>Refer to "Guide Program Number Set" ( pg. 79) and re-perform the procedure.</p>

OTHER PROBLEMS

SYMPTOM	POSSIBLE CAUSE	CORRECTIVE ACTION
1. Whistling or howling is heard from the TV during camcorder recording.	<ul style="list-style-type: none"> • The camcorder's microphone is too close to the TV. • The TV's volume is too high. 	<p>Position the camcorder so its microphone is away from the TV.</p> <p>Turn the TV's volume down.</p>
2. When scanning channels, some of them are skipped over.	<ul style="list-style-type: none"> • Those channels have been designated to be skipped. 	<p>If you need the skipped channels, restore them (☞ pg. 82).</p>
3. The channel cannot be changed.	<ul style="list-style-type: none"> • Recording is in progress. 	<p>Press II to pause the recording, change channels, then press ▶ to resume recording.</p>
4. Channel settings that were made manually seem to have changed or disappeared.	<ul style="list-style-type: none"> • After the manual settings were made, Auto Channel Set was performed. 	<p>Perform manual setting again.</p>
5. No channels are stored in the recorder's memory.	<ul style="list-style-type: none"> • The TV aerial cable was not connected to the recorder when Auto Set Up was performed. • The fully-wired 21-pin SCART cable was not connected between TV and the recorder when Preset Download was performed. 	<p>Turn off the recorder once and connect the TV aerial cable to the recorder properly, then turn on the recorder again. The recorder will try Auto Set Up again (☞ pg. 14).</p> <p>Turn off the recorder once and connect the fully-wired 21-pin SCART cable to the recorder properly, then turn on the recorder again. Then perform Preset Download again (☞ pg. 16).</p>
6. The remote control won't operate the TV or satellite receiver.	<ul style="list-style-type: none"> • The remote control brand setting is incorrect. 	<p>Re-set the remote control to the correct brand. (☞ pg. 49, 50)</p>

ATTENTION

This recorder contains microcomputers. External electronic noise or interference could cause malfunctioning. In such cases, switch the recorder off and unplug the mains power cord. Then plug it in again and turn the recorder on. Take out the cassette. After checking the cassette, operate the unit as usual.

ON-SCREEN MESSAGES

MESSAGE	DESCRIPTION
CAN NOT MODIFY LIVE MEMORY TIME, MORE CAPACITY NEEDED DELETE UNWANTED PROGRAMME THEN RETRY	There is not enough memory on the hard disk drive for Live Memory Playback. To increase the free space, dub some programmes to cassettes or delete the unwanted programmes. (☞ pg. 26, 55)
DO YOU WANT TO DELETE SELECTED PROGRAMME?	Appears when you tried to delete the selected programme from the hard disk drive. Make sure you really want to delete the programme. (☞ pg. 55)
DO YOU WANT TO DELETE SELECTED PROGRAMME INFORMATION?	Appears when you tried to delete the selected programme information from the hard disk drive. Make sure you really want to delete the programme information. (☞ pg. 55)
DO YOU WANT TO DELETE SELECTED CASSETTE INFORMATION?	Appears when you tried to delete the selected cassette's all information from the hard disk drive. Make sure you really want to delete the cassette's information. (☞ pg. 55)
INSERT #XXXX CASSETTE	Appears when you tried to modify the information for VCR Navigation, but the cassette is not loaded. To modify the information for VCR Navigation, the cassette must be loaded. (☞ pg. 52)
CAN NOT MODIFY INDEX WHILE HDD IS RECORDING RETRY WHEN HDD RECORDING IS STOPPED	It is not possible to modify the index of a programme while the hard disk drive is in recording. Wait until the recording finishes or stop recording to modify the index. (☞ pg. 52)
NO CASSETTE	For VCR Navigation, load a cassette before pressing NAVIGATION . (☞ pg. 32)
NAVIGATION IS PRESENTLY OFF CHANGE TO ON	For VCR Navigation, set "NAVIGATION" to "ON" on the "VCR SET UP 1" screen, then press NAVIGATION . (☞ pg. 32, 75)

MESSAGE	DESCRIPTION
UNABLE TO SET TIMER PROGRAMME DUE TO SHORTAGE OF CAPACITY DELETE UNWANTED PROGRAMME FROM HDD	There is not enough memory on the hard disk drive for recording. To increase the free space, dub some programmes to cassettes or delete the unwanted programmes. (☞ pg. 55)
PROGRAMME FULL DELETE UNWANTED TIMER PROGRAMME	You can programme this recorder to timer-record as many as 16 programmes. To programme more, you need to cancel a timer programme already set. (☞ pg. 46)
PLEASE ADJUST CLOCK BEFORE TIMER PROGRAMMING	To set the timer programme, the clock must be set in advance. (☞ pg. 88)
SET GUIDE PROG THEN RETRY	To set the timer programme using the SHOWVIEW system, the Guide Program number must be set in advance. (☞ pg. 79)
SHOWVIEW NO. ERROR CONFIRM SHOWVIEW NO. THEN RETRY	An invalid SHOWVIEW number is input. (☞ pg. 42)
PROGRAMME NOT COMPLETED PROGRAMME OVERLAPPED PLEASE CONFIRM AND MODIFY	The timer programme you set is overlapping with another timer programme. (☞ pg. 46)
TIMER PROGRAMMING STOPPED	Appears when you stop setting timer programme.
PROGRAMME COMPLETED PRESS "OK" THEN PRESS [⊙]	Timer programming is completed properly.
TIMER RECORDING WILL START SOON INSERT CASSETTE AND PRESS [⊙]	The recorder is not in the timer-standby mode. The timer recording will start in about 5 minutes.

ON-SCREEN MESSAGES (cont.)

MESSAGE	DESCRIPTION
REMAINING CAPACITY IS SMALL DELETE UNWANTED PROGRAMME FROM HDD	The remaining capacity of the hard disk drive is in short for the current recording. (☞ pg. 55)
CAPACITY IS FULL, RECORDING STOPPED	The recording stopped due to the shortage of the free space on the hard disk drive.
CAPACITY IS FULL, UNABLE TO RECORD DELETE UNWANTED PROGRAMME FROM HDD	The recording cannot be started due to the shortage of the free space on the hard disk drive. (☞ pg. 55)
TITLE MEMORY IS FULL, UNABLE TO RECORD DELETE UNWANTED PROGRAMME FROM HDD	The remaining capacity is full for registration for the Navigation system. The recording cannot be started even though the capacity for the recording is enough. (☞ pg. 55)
COPY PROHIBITED, UNABLE TO RECORD ON HDD	It is not possible to record a copy-protected programme.
NO PROGRAMME TO PLAYBACK	There is no recorded programme on the hard disk drive.
UNABLE TO GO BACK ANYMORE	It is not possible to go back beyond the start point of the recording for Live Memory Playback. (☞ pg. 26)
DUBBING COMPLETED	Appears when Easy Dubbing is completed. (☞ pg. 56)
DUBBING STOPPED	Appears when Easy Dubbing is stopped. (☞ pg. 56)
TAPE ENDED, DUBBING STOPPED	Appears when the tape ends during Easy Dubbing. (☞ pg. 56)
EDITING COMPLETED	Appears when Random Assemble Editing is completed. (☞ pg. 60)
EDITING STOPPED	Appears when Random Assemble Editing is stopped. (☞ pg. 60)
TAPE ENDED, EDITING STOPPED	Appears when the tape ends during Random Assemble Editing. (☞ pg. 60)
COPY PROHIBITED	It is not possible to dub a copy-protected programme.

PLAYBACK

Q. What happens if the end of the tape is reached during playback or search?

A. The tape is automatically rewound to the beginning.

Q. Can the video recorder indefinitely remain in the still mode?

A. No. It stops automatically after 5 minutes to protect the heads.

Q. When returning from variable-speed search to normal playback, the picture is disturbed. Should I be concerned about this?

A. No, it is normal.

Q. Sometimes, during Index Search, the video recorder can't find the programme I want to see. Why not?

A. There may be index codes too close together.

RECORDING

Q. When I pause and then resume a recording, the end of the recording before the pause is overlapped by the beginning of the continuation of recording. Why does this happen?

A. This is normal. It reduces distortion at the pause and resume points.

Q. Can the video recorder indefinitely remain in the Record-Pause mode?

A. No. The video recorder goes to its Stop mode automatically after 5 minutes to protect the heads.

Q. What happens if the tape runs out during recording?

A. The video recorder automatically rewinds it to the beginning.

TIMER RECORDING

Q. "○" and "⊖" remain lit on the front display panel. Is there a problem?

A. No. This is a normal condition for a timer recording in progress.

Q. Can I programme the timer while I'm watching a tape or a TV broadcast?

A. You won't see the picture as it is replaced by the on-screen menu, but the audio from the programme or tape you're viewing can be heard.

GENERAL

Power requirement	: AC 220 V – 240 V~, 50 Hz/60 Hz
Power consumption	
Power on	: 41 W
Power off	: 16 W
Temperature	
Operating	: 5°C to 40°C
Storage	: -20°C to 60°C
Operating position	: Horizontal only
Dimensions (WxHxD)	
	: 435 mm x 124 mm x 385 mm
Weight	: 7.3 kg
Input/Output	: 21-pin SCART connectors:
	IN/OUT x 1, IN/DECODER x 1
	RCA connectors:
	VIDEO IN x 1, AUDIO IN x 1,
	AUDIO OUT x 1
	S-Video connectors:
	IN x 1, OUT x 1

HDD DECK VIDEO/AUDIO

Video format	: MPEG2 (VBR)
Audio format	: MPEG1 Layer2
Maximum recording time (approx.)	
(SP)	: 14 hours
(LP)	: 20 hours
(EP)	: 28 hours
(SEP)	: 40 hours

VHS DECK VIDEO/AUDIO

Signal system	: PAL-type colour signal and CCIR monochrome signal, 625 lines 50 fields
Recording system	: DA4 (Double Azimuth) head helical scan system
Format	: S-VHS/VHS PAL standard
Signal-to-noise ratio	: 45 dB
Horizontal resolution	
(SP/LP)	: 250 lines (VHS) 400 lines (S-VHS)
(EP)	: 220 lines (VHS) 350 lines (S-VHS)
Frequency range	: 70 Hz to 10,000 Hz (Normal audio) 20 Hz to 20,000 Hz (Hi-Fi audio)
Maximum recording time	
(SP)	: 240 min. with E-240 video cassette
(LP)	: 480 min. with E-240 video cassette
(EP)	: 720 min. with E-240 video cassette

TUNER/TIMER

TV channel storage capacity	: 99 positions (+AUX position)
Tuning system	: Frequency synthesized tuner
Channel coverage	: VHF 47 MHz – 89 MHz/ 104 MHz – 300 MHz/ 302 MHz – 470 MHz UHF 470 MHz – 862 MHz
Aerial output	: UHF channels 22 – 69 (Adjustable)
Memory backup time	: Approx. 60 min.

ACCESSORIES

Provided accessories	
	: RF cable, 21-pin SCART cable, Satellite Controller, Infrared remote control unit, "R6" battery x 2

Specifications shown are for SP mode (VHS) unless otherwise specified.

E. & O.E. Design and specifications subject to change without notice.

A		O	
Audio Dubbing	68	O.S.D.	78
Auto Channel Set	80	ON-SCREEN DISPLAY	8, 9
Auto Set Up	14	Output/Input Set	64
AUTO SP→LP TIMER	76	P	
AUTO TIMER	78	PICTURE CONTROL	77
Automatic Satellite Programme Recording	47	Playback with HDD Navigation	24
B		Playback with VCR Navigation	32
B.E.S.T. Picture System	41, 77	Preset Download	16
C		R	
Change Station Channel Position	84	Random Assemble Editing	60
Check, cancel and change programmes	46	Record One Programme While Watching Another	29, 37
Clock Set	88	Recording Resume Function	37
COLOUR SYSTEM	76	RECORDING/PLAYBACK ON HDD DECK	22
Connecting To A Satellite Receiver	70	RECORDING/PLAYBACK ON VHS DECK	30
D		Repeat Playback	28, 35
Delete A Channel	83	Retake	38
DIGITAL 3R	77	S	
DIGITAL TBC/NR	77	Satellite Controller	19
DIRECT REC	21, 78	Satellite Receiver Control Setting	19
Dubbing	56	Set Stations (A)	85
E		Set Stations (B)	85
EDITING	51	SHOWVIEW® System Setup	79
Elapsed Recording Time Indication	38	SHOWVIEW® Timer Programming	42
Express Timer Programming	44	Slow Motion	27, 34
F		Soundtrack Selection	28, 36
F-1 INPUT	65	Still Picture/Frame-By-Frame Playback	27, 34
Fine-Tuning Channels Already Stored	86	Super VHS ET (S-VHS ET)	39, 75
G		S-VHS	66, 75
Guide Program Number Set	43, 79	T	
H		Tape Position Indicator	9
High-Speed Search	27, 34	Tape Remaining Time	38
I		TIMER RECORDING	42
Index Search	35	Tuner Set	80
Instant Timer Recording (ITR)	29, 37	T-V LINK	21
J		TV Station And ID List	87
Just Clock	88	V	
L		Variable Speed Search	28, 34
L-1 INPUT	64	VIDEO STABILIZER	78
L-1 OUTPUT	64	VPS/PDC Recording	45
L-2 SELECT	65	W	
Language	18	When Receiving A Scrambled Broadcast	86
Live Memory Playback	26	M	
M		Manual Channel Set	82
Manual Tracking	36	Manual Tracking	36
Mode Set	74	Mode Set	74
N		N	
Next Function Memory	35	Next Function Memory	35
Normal Dubbing (from HDD to VHS)	58	Normal Dubbing (from HDD to VHS)	58
Normal Dubbing (from VHS to HDD)	59	Normal Dubbing (from VHS to HDD)	59

Auto Set Up — referring to the front display panel

The Auto Set Up function sets the tuner channels, clock and Guide Program numbers automatically.

BEFORE YOU START PLEASE MAKE SURE THAT:

- The TV aerial cable is connected to the ANTENNA IN connector on the rear panel of the video recorder.
- The video recorder's mains power cord is connected to a mains outlet.
- The video recorder is turned off.
- Load batteries into the remote control.

1 Press O/I (recorder/remote).

2 Press Δ/∇ (remote) to select the international telephone country code.

(Example) DEUTSCHLAND (49) is selected.

International Telephone Country Code

BELGIUM	: 32	NORGE	: 47
ČESKÁ REPUBLIKA	: 42	ÖSTERREICH	: 43
DANMARK	: 45	POLSKA	: 48
DEUTSCHLAND	: 49	PORTUGAL	: 351
ESPAÑA	: 34	SUISSE	: 41
GREECE	: 30	SUOMI	: 358
ITALIA	: 39	SVERIGE	: 46
MAGYARORSZÁG	: 36	OTHER WESTERN EUROPE	: --
NEDERLAND	: 31	OTHER EASTERN EUROPE	: EE

- If you have selected 32 (BELGIUM) or 41 (SUISSE), press **OK** (remote) and select the language code by pressing Δ/∇ (remote), then go to step 3.

(Example) FRANCAIS (03) is selected for BELGIUM (32)

International telephone country code Language code

Language Code

ENGLISH	: 01	NEDERLANDS	: 06
DEUTSCH	: 02	SVENSKA	: 07
FRANCAIS	: 03	NORSK	: 08
ITALIANO	: 04	SUOMI	: 09
CASTELLANO	: 05	DANSK	: 10

- If you have selected 36 (MAGYARORSZÁG), 42 (ČESKÁ REPUBLIKA), 48 (POLSKA) or EE (OTHER EASTERN EUROPE), press **OK**. The Clock Set screen appears. Set the clock manually (☞ pg. 88), then go to step 3.
- If you have selected any other country name (code), press **OK** and go to step 3.

3 Press **OK** (remote). "Auto" appears on the front display panel.

4 Press **OK** (remote) to start Auto Set Up. Do NOT press any button on the video recorder or remote control during "Auto" is blinking.

- If you have connected the recorder to a TV offering T-V Link via a 21-pin SCART cable (☞ pg. 12) and the TV is turned on, the recorder automatically performs "Preset Download" (☞ pg. 16) even if you select "Auto" in step 4.
- If "--:--" appears on the front display panel, see page 17 of the instructions.

* Once you have performed Auto Set Up, even if the recorder's memory backup has expired, the recorder will not perform Auto Set Up again. Perform tuner setting (☞ pg. 80) and/or clock setting (☞ pg. 88) as required.

FOR MORE INFORMATION SEE INSTRUCTIONS ON PAGE 14

JVC

VICTOR COMPANY OF JAPAN, LIMITED

Free Manuals Download Website

<http://myh66.com>

<http://usermanuals.us>

<http://www.somanuals.com>

<http://www.4manuals.cc>

<http://www.manual-lib.com>

<http://www.404manual.com>

<http://www.luxmanual.com>

<http://aubethermostatmanual.com>

Golf course search by state

<http://golfingnear.com>

Email search by domain

<http://emailbydomain.com>

Auto manuals search

<http://auto.somanuals.com>

TV manuals search

<http://tv.somanuals.com>