

FEATURES

Thank you for purchasing the JVC KB-500 stereo keyboard. To make the best and proper use of your KB-500, be sure to read this instruction manual carefully and thoroughly. After reading it, retain the manual for future reference.

IMPORTANT (In the United Kingdom) Mains Supply (AC 240 V~, 50 Hz only)

IMPORTANT

Do not make any connection to the Larger Terminal coded E or Green. The wires in the mains lead are coloured in accordance with following code:



If these colours do not correspond with the terminal identifications of your plug, connect as follows: Blue wire to terminal coded N (Neutral) or coloured Black. Brown wire to terminal coded L (Live) or coloured Red.

If in doubt – consult a competent electrician.

Note

Disconnect the mains plug from the supply socket when not in use.

WARNING

Dangerous voltage inside

CAUTION

To prevent electric shock, do not remove screws, covers or cabinet.

No user-serviceable parts inside. Refer servicing to qualified service personnel.

Eftersom denna apparat använda det sekundär strömknappsystem, konsumeras en liten mängd ström (ungefär 1 W) även om POWER knappen står på ON. För att stänga av strömen helt och hållet, drag ut strömkontakten från AC mynningen.

FEATURES

- 10 high-quality tone characteristics developed from JVC's extensive audio experience with "VICTRON" electronic organs and the most advanced LSI technology.
- JVC-developed two-speaker stereo effect and spacious ENSEMBLE orchestral sound.
- Audio system compatibility – stereo connection terminals provided.
- Three-way power supply flexibility (batteries, AC outlet, car battery); lightweight, convenient portability.
- Fascinating chord automatic accompaniment – easiest ever professional sounds; bass lines, chords and arpeggios at the push of a button.
- Compucorder memorizes 42 bars of chords for up to 3 separate musical selections.

- Magical one-finger **Ultra Chord** adds harmony to right-hand melody lines.
- **Auto Rhythm** – 10 different automatic rhythm lines with visual **Beat Conductor** count and tempo display.
- Voice accompaniment facility – MIC terminal provided for automatic or keyboard accompanied singing.
- Pitch control facilitates ensemble work with other instruments.
- Automatic power cut-off system – If the KB-500 is not played for about 6 minutes, power will automatically be cut off.

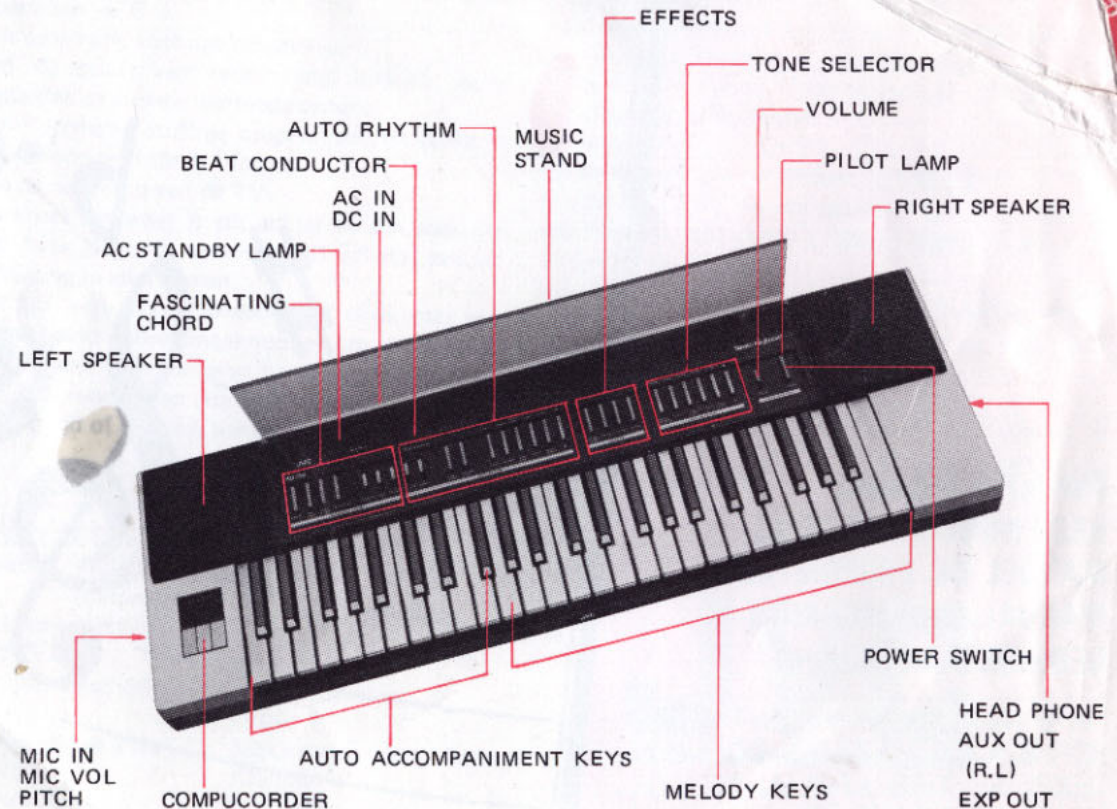

PART 1

POWER SUPPLY

SETTING UP THE MUSIC STAND

TOTAL CONTROL

PART 2

POWER SUPPLY

A. Household AC power outlet:

When using ordinary household current, the AC STANDBY lamp illuminates, even with the power switch set to OFF.

B. Car battery:

To prevent malfunction due to reversed polarity, use only the car adapter designated.

Car battery (12 V)

Rear of the main body

AC outlet

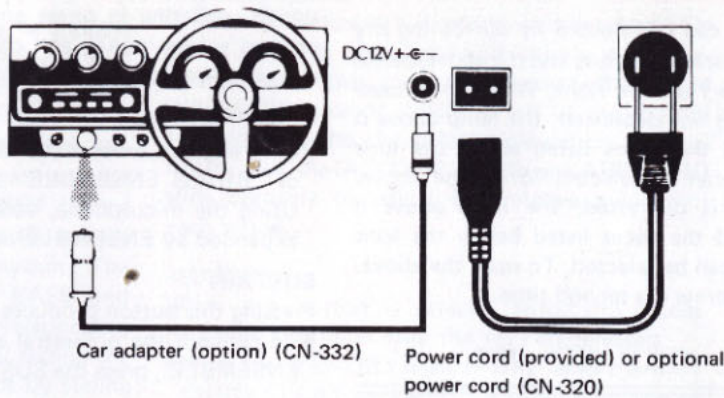

TOTAL CONTROL

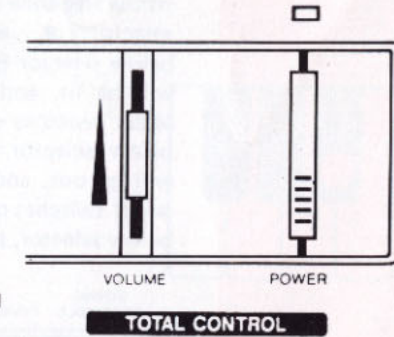

C. Dry cell batteries:

1. Turn the instrument over and place it on a soft, flat surface.
2. Open the battery compartment.
3. Load 8 dry cells (R20) through the holder into the compartment, pressing them against the loading springs and aligning them for correct polarity.
4. Close the battery compartment.
 - When supplying power from an AC household outlet, or if the instrument is not used for a

long period of time, remove the dry cells to prevent corrosion due to battery leakage.

- When the pilot lamp flickers, even though sound is not being produced, it's indicating that the batteries are low and you may not get 100 % performance.
- When the instrument is used in cold environments, the battery operating efficiency may deteriorate and the battery life may also be shortened.

•POWER SWITCH

To switch power on, press the front end (ridged portion) of the POWER button (the lamp lights).

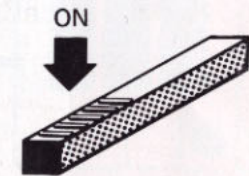

Push the button a second time to shut the power off (the lamp goes out).

(Other buttons are operated in the same way.)

* Don't press the power switch on and off quickly or repeatedly.

* If the KB-500 is not played for about 6 minutes, power will automatically be cut off to conserve electricity.

•VOLUME

To increase the volume, slide the volume control towards you; to decrease the volume, slide the volume control away from you.

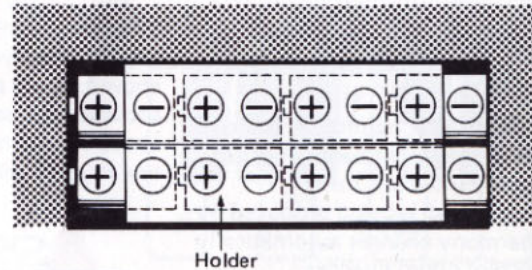
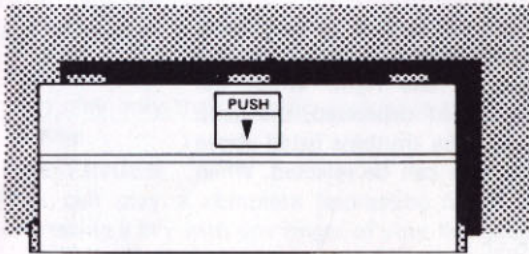

SETTING UP THE MUSIC STAND

- Flip up the transparent board covering the control panel, and it serves as a music stand. Don't push the cover too far back (in the direction of the arrow).

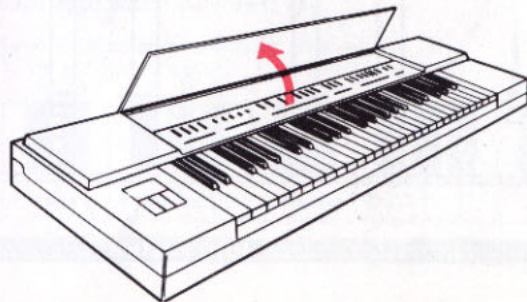

TONE SELECTOR EFFECTS AUTO RHYTHM

TONE SELECTOR

10 preset tones can be selected by combining any of the five tone select buttons and the above/below selector (▲, ▼) on the right. When the above/below selector is not depressed, the lamp above it will be lit, and the tones listed **above** the tone select switches can be selected. When the above/below selector is depressed, the lamp above it will go out, and the tones listed **below** the tone select switches can be selected. To reset the above/below selector, press it a second time.

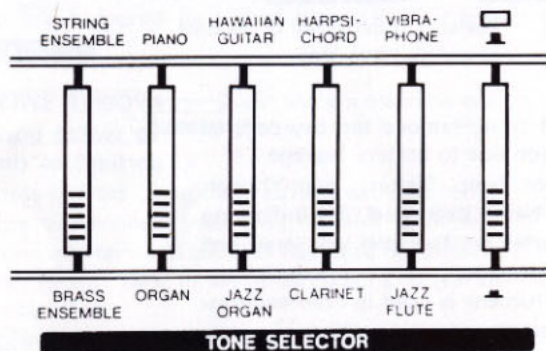

EFFECTS — ADDING TO THE BASIC TONES

ULTRA CHORD

In the automatic accompaniment mode (either the ONE FINGER or the MULTI-FINGER button must be depressed — see PART 4), pressing the ULTRA CHORD button adds harmonizing sound to the melody played by the right hand, in accordance with chord chosen by the left hand.

- Even when the same sound is being produced by the right hand, the harmony changes automatically when the accompaniment chord changes.

ENSEMBLE

Pressing this button produces the rich, orchestral sound of many individual instruments playing together.

STEREO

The stereo effect was developed especially for the KB-500 by JVC. Pressing this button expands the dimensions of the sound for a spacious stereo

effect. A special circuit generates two separate signals, differing in phase and volume, from one original source signal, and channels them through two amplifiers and two separate speakers.

- ENSEMBLE and STEREO effects are automatically engaged when either STRING ENSEMBLE or BRASS ENSEMBLE tones are selected. Using the microphone, voice can also be richly expanded by ENSEMBLE or STEREO effects.

SUSTAIN

Pressing this button produces the sustain effect.

- To enhance the orchestral effect of the STRING ENSEMBLE, press the SUSTAIN button.

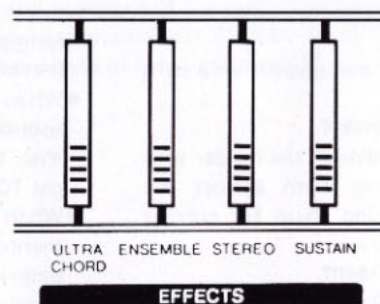

AUTO RHYTHM SELECTOR

10 rhythm varieties can be selected by combining any of the five rhythm select buttons and the above/below selector on the right. When the above/below selector is not depressed, the lamp above it will be lit, and the rhythms listed **above** the rhythm select buttons can be selected. When

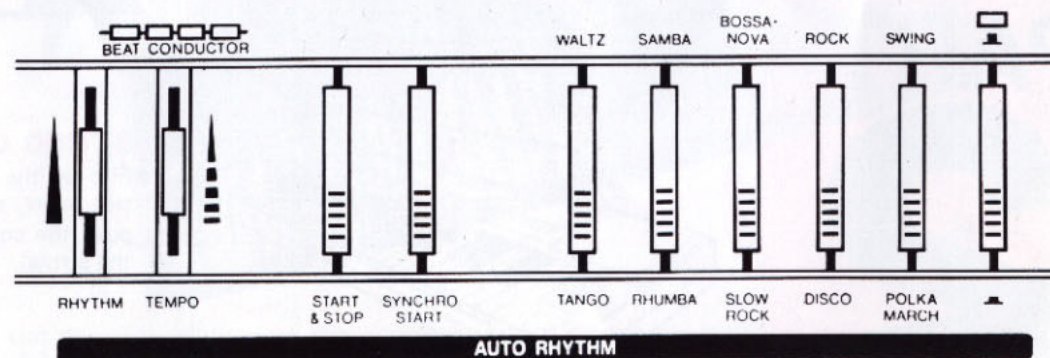

the above/below selector is depressed, the lamp above it will go out, and the rhythms listed **below** the rhythm select buttons can be selected. To reset the above/below selector, press it a second time.

START & STOP

Pressing this button starts the rhythm beating. Press it a second time to stop the rhythm.

SYNCHRO START

When this button is depressed, the rhythm will automatically start when an auto accompaniment-introducing key, (from lowest C to F# in the octave above, that's the range indicated by the dotted line on the keyboard.) is pressed. To stop the rhythm, press the START & STOP button.

BEAT CONDUCTOR

A visual indicator that displays the tempo and count of the beat.

TEMPO

Slide this control towards you to increase the tempo of the rhythm. Slide it away from you to decrease the tempo.

RHYTHM

Slide this control towards you to increase the volume of the rhythm sound. Slide it to the uppermost position to mute the rhythm sound.

PART 3

FASCINATING CHORD

"Fascinating Chord" is a JVC original automatic accompaniment device that employs a micro-computer. When an automatic accompaniment button (ONE FINGER or MULTI-FINGER) is depressed, the keys from lowest C to F# in the octave above become automatic accompaniment keys. Pressing them introduces ACCOMP (chord accompaniment), BASS and ARPEGGIO sounds which are synchronized with the rhythm. The volume of each sound (ACCOMP, BASS and ARPEGGIO) can be adjusted with a corresponding slide control; increase the volume by sliding the controls towards you, mute the sounds by sliding the controls away from you.

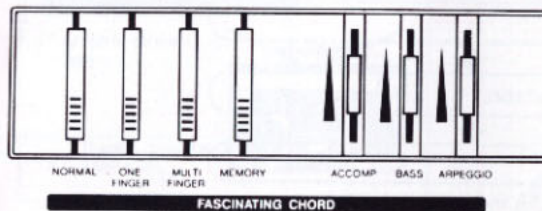

NORMAL

Pressing this button disengages the automatic accompaniment device; all keys on the keyboard then play only their specific pitches, in the selected tone.

ONE FINGER

You can play a complete fascinating chord by depressing a key with one finger of your left hand.

The figure below shows the chords produced by each auto accompaniment key.

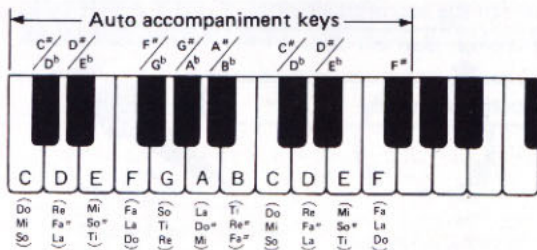

MULTI-FINGER

This is an automatic accompaniment system for those who can play left-hand chords on a keyboard. When this button is pressed, BASS and ARPEGGIO sounds synchronized to the rhythm are added to the chord being played on the keyboard. Use the ACCOMP, BASS and ARPEGGIO slide controls to adjust the relative volume of each sound.

MEMORY

When this button is pressed, automatic accompaniment continues after the keys are released.

- With the MEMORY switch OFF, and the SYNCHRO START switch ON, automatic accompaniment and rhythm are audible only when an automatic accompaniment key is pressed; when the key is released, all accompanying sound and rhythm stops. Press a key again, and automatic accompaniment and rhythm restart from beat 1.
- If the automatic accompaniment system is used without AUTO RHYTHM, ACCOMP (accompaniment chord) and BASS will be continuous sounds.

MAJOR CHORDS: Example: C major

Press one of the C keys and the C major chord (Do-Mi-So harmony) is produced, as shown in the figure.

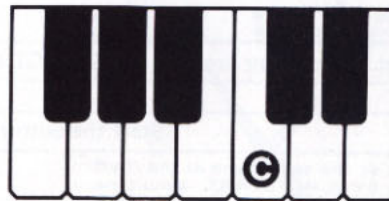

- Besides the major chords, 3 other basic chords can be played in the one-finger mode: minor, sevenths and minor sevenths.

MINOR CHORDS: Example: C minor

Press the C key together with any black key to the left of it.



SEVENTHS: Example: C7

Press the C key together with any other white key to the left of it.

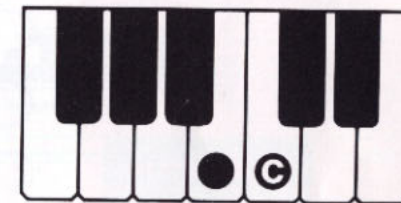

MINOR SEVENTHS: Example: Cm7

Press the C key together with any black key and any white key to the left (all three keys together).



COMPUCORDER

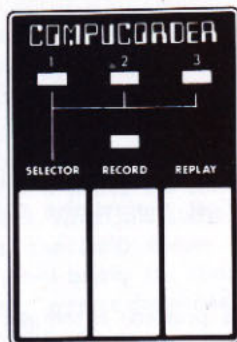

Accompaniment for three separate pieces can be memorized (RECORD) and played back at any time (REPLAY), complete with all auto accompaniment and auto rhythm sounds. The tempo of the recorded accompaniment is variable, so that a recording made at a slow speed can be replayed at a faster (or slower) tempo. What is actually recorded is the chord progression, so other elements such as rhythm pattern, rhythm volume, ACCOMP, BASS and ARPEGGIO volume, can be freely modified. Chords memorized by compucorder can be stored for about 7 days. If you want to store them for longer, the power must be turned on once every 7 days.

- At the rate of 2 chords per bar, it is possible to record up to 42 bars of accompaniment in each of the three memories. The record lamp turns off when the recording capacity has been reached.
- If keys are not pressed and released in good timing with the rhythm, chords may be misplaced in the recording. It is recommended that chords be played exactly on the first and third beat of each bar, that the last chord and the rhythm in each tune be stopped at the fourth beat by pressing the START & STOP button.
- Accompaniment recorded in WALTZ time (3/4) should be replayed only in WALTZ time; they cannot be correctly played with the 4-count rhythms.

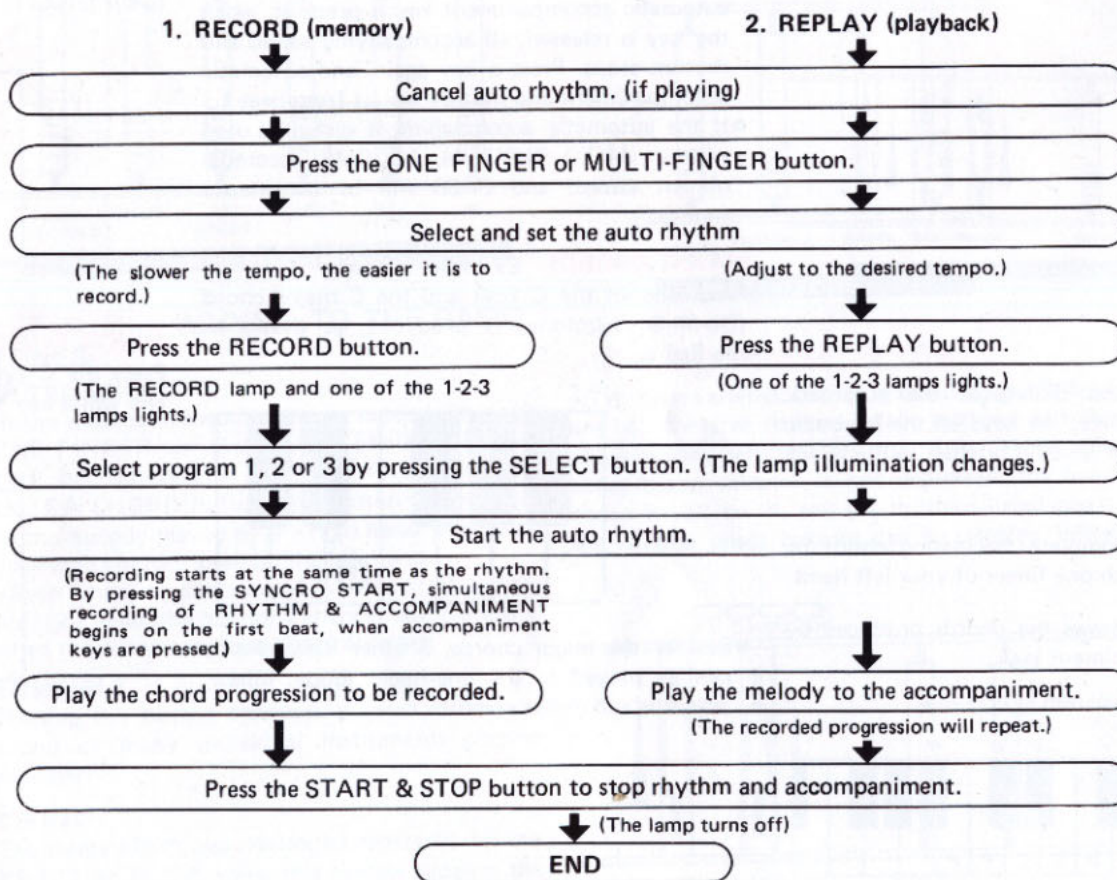

UNLIMITED
AUDIO
SYSTEMS
COMPATI-
BILITY

**FOR HIGH QUALITY SOUND
USING STEREO EQUIPMENT**

Stereo component system

FOR OUTDOOR ENJOYMENT

Portable stereo system
Radio cassette recorder

**FOR PROFESSIONAL PER-
FORMANCE WITH VICTRON**

A Victron M series
B Victron G series

VICTRON

* VICTRON G-250 and G-350 cannot be connected to the instrument.

CONNECTION CORD

A connection cord CN-160
(extension cord CN-163)

B " CN-132

C plug adapter AP-100
To convert mini-plug into phone-plug

CARRYING CASE — STAND

KC-10 KS-10

**FOR ENSEMBLE STAGE
PERFORMANCE WITH
OTHER INSTRUMENTS**

SEA equalizer
Audio mixer
Cassette deck
Guitar amplifier

MIC VOL MIC IN PITCH EXP PEDAL R AUX OUT L HEAD PHONE

Singing through MIC Listening through headphones Volume adjustment

Microphone's volume can be adjusted by MIC VOL.

Dynamic microphone MD-280, 380

Headphone with mic H-V1

Fly-weight stereo headphone H-M7T

Stereo headphone H-707

Volume adjustment with Expression foot pedal KX-10

With two cassette decks, various dubbing and mixing tasks can be performed using the various tones.

Cassette deck

Cassette deck

PART
6

• Parts and products on this page, other than the main body of "keyboard", are all optionally available.

TROUBLESHOOTING

SAFETY PRECAUTIONS

SPECIFICATIONS

PART 7

TROUBLESHOOTING — Problems which are not malfunctions.

- It is not unusual for the keyboard to generate small sounds even when no tone selector is depressed.
- When playing with multi-finger accompaniment, some left-hand chords will conflict with the bass and arpeggio accompaniment device only plays bass and arpeggios on the 4 ACCOMP chords; majors, minors, sevenths and minor sevenths. Unusual chords recorded with the COMPUCORDER will also be converted to one of the four basic chords when the accompaniment is played back.
- The keyboard can produce a maximum of eight sounds. If more than eight keys are pressed, sound from the eight highest keys will be produced.
- Always press the REPLAY button after recording (memory) has been made with the compucorder. With no memory stored in the compucorder, pressing the REPLAY button immediately after the power is switched on may prevent the keyboard from working. If you experience this problem, cut the power and switch it on again.
- With the expression pedal connected and being operated at a lower volume than that of the lowest sounds of the main body, automatic power cut-off may function.
- When operating in a condition that may produce static electricity, the built-in computer may malfunction. If this occurs, cut off the power switch and turn the switch back on.

SAFETY PRECAUTIONS

- Power should be supplied to the KB-500 from an ordinary household AC outlet. To avoid malfunctions or accidents, use only the power cord provided.
- Carefully handle all power and connection cords:
 - To disconnect, be sure to grasp the plug, not the cord.
 - Never handle cords with wet hands.
 - Avoid unnecessary or excessive bending of the cords.
 - Do not damage the cords.
 - Never splice cords.
 - Disconnect the power cord immediately in the event of all electrical storm.
- Even with the power switched off, the KB-500 uses a small amount of current. If you do not use the instrument for a long period of time, disconnect the power cord for safety.
- Do not open the KB-500, or attempt any adjustments or repairs of its internal components; a serious accident or malfunction could result. For maintenance and repairs, leave the matter to a qualified JVC dealer.
- To prevent accidents or malfunctions, avoid using the KB-500 under the following conditions:
 - Under the direct rays of the sun.
 - In environments where the temperature exceeds 40°C (104°F) or falls below -5°C (23°F).
 - Under high-humidity conditions.
 - Near a heater, stove, fireplace or other heat source.
 - In extremely dusty environments, or places subject to high vibrations.
 - Near a TV set.
- Never leave the instrument in a car on a hot day, malfunctions or external damage may result.
- To clean the KB-500, use a dry cloth, or one moistened with water or a neutral detergent. Never use benzine or thinner, as they may crack, discolor, or otherwise damage the surface finish.

SPECIFICATIONS:

STEREO KEYBOARD KB-500

Keys: 49 (Accompaniment keys plus melody keys)

Tone selectors:

<u>ABOVE</u>	<u>BELOW</u>
STRING ENSEMBLE	BRASS ENSEMBLE
PIANO	ORGAN
HAWAIIAN GUITAR	JAZZ ORGAN
HARPSICHORD	CLARINET
VIBRAPHONE	JAZZ FLUTE

Effects: ULTRA CHORD, ENSEMBLE, STEREO, SUSTAIN

Auto Rhythm:

START & STOP, SYNCHRO START, TEMPO, RHYTHM VOLUME, BEAT CONDUCTOR.

Rhythm selectors:

<u>ABOVE</u>	<u>BELOW</u>
WALTZ	TANGO
SAMBA	RHUMBA
BOSSA NOVA	SLOW ROCK
ROCK	DISCO
SWING	POLKA/MARCH

Fascinating chord:

NORMAL, ONE FINGER, MULTI-FINGER, MEMORY, ACCOMP volume, BASS volume, ARPEGGIO volume, COMPUCORDER (SELECTOR, RECORD, REPLAY).

Others: POWER switch, TOTAL VOLUME, Expression pedal terminal, Output terminals (left and right), Headphone terminal, DC IN, AC IN, Microphone terminal, Microphone volume, Pitch control, AC STANDBY lamp, Pilot lamp.

Speakers: 12 cm x 2

Amplifier output: 2.5 W x 2

Weight: 6.8 kg (without batteries)

Dimensions: 860 (W) x 290 (D) x 85 (H) mm

Rated power consumption: 26 W

Battery life: 3 hours of continuous operation at maximum output

Applicable battery: R20 x 8

Design & specifications are subject to change without notice.

Free Manuals Download Website

<http://myh66.com>

<http://usermanuals.us>

<http://www.somanuals.com>

<http://www.4manuals.cc>

<http://www.manual-lib.com>

<http://www.404manual.com>

<http://www.luxmanual.com>

<http://aubethermostatmanual.com>

Golf course search by state

<http://golfingnear.com>

Email search by domain

<http://emailbydomain.com>

Auto manuals search

<http://auto.somanuals.com>

TV manuals search

<http://tv.somanuals.com>