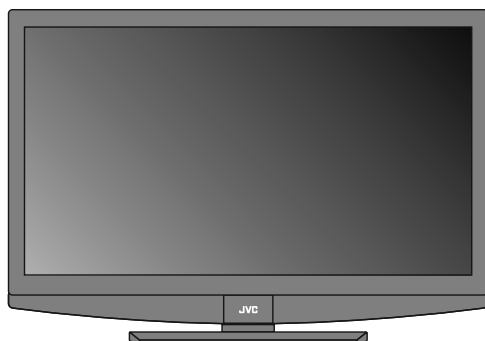




LCD Television Users Guide

LT-42P789 42" class (42" Diagonal)
LT-47P789 47" class (46.9" Diagonal)
LT-52P789 52" class (52" Diagonal)

1080p HDTV



iPod is a trademark of Apple Inc., registered in the U.S. and other countries.

Important Note:

In the spaces below, enter the model and serial number of your television (located at the rear of the television cabinet). Staple your sales receipt or invoice to the inside cover of this guide. Keep this user's guide in a convenient place for future reference. Keep the carton and original packaging for future use.

Serial Number: _____

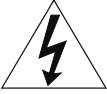
Model Number: _____

LCT2383-002A-A
0708TSH-II-IM


Table of Contents

Warnings	3	Add Channel	31
Precautions	6	Edit Channel	31
Remote Control	10	V-Chip	31
TV Basic Controls	12	Guide	31
Setup	16	TV (V-Chip)	32
Initial Setup	16	Password	33
Key Features	18	MPA	33
Remote Control Functions	19	Can. Eng.	34
Sleep	19	Can. Fre.	35
Return+ TV	19	TVPG	36
Favorite	19	Sound	37
Aspect	20	MTS	37
Sound	20	Digital Audio (ML)	37
Video	20	Surround	37
Guide	21	Sound Status	38
SUB CH	21	Audio Reset	38
ML/MTS	21	Power	39
Customizing your TV	22	Sleep Timer	39
Picture	23	Power Indicator	39
Video Status	23	Illumination	39
Color Temp	24	Setting	40
Color Management	24	Plug-In Menu	40
Dynamic Gamma	24	Time Zone	40
Smart Picture	25	D.S.T.	40
Digital VNR	25	Language	40
MPEG NR	25	Noise Mute	40
Natural Cinema	25	Front Panel Lock	41
Video Reset	25	Transparency	41
Display	26	Auto Shut Off	41
Video Input Label	26	System Info	41
Photo Viewer	26	Auto Demo	41
Aspect	28	Optical Out	41
TV	29	Enjoy Movies/Music from your iPod	42
Closed Caption	29	Connecting Your Devices	47
C. C. Setting	29	Programming Your Remote	52
Tuner Mode	30	Troubleshooting	59
Auto Scan	30	Specifications	61
		Warranty	62

Warnings



CAUTION
RISK OF ELECTRIC SHOCK
DO NOT OPEN



CAUTION: To reduce the risk of electric shock. Do not remove cover (or back). No user serviceable parts inside. Refer servicing to qualified service personnel.

The lightning flash with arrowhead symbol, within an equilateral triangle is intended to alert the user to the presence of uninsulated “dangerous voltage” within the product’s enclosure that may be of sufficient magnitude to constitute a risk of electric shock to persons.

The exclamation point within an equilateral triangle is intended to alert the user to the presence of important operating and maintenance (servicing) instructions in the literature accompanying the appliance.

WARNING: TO PREVENT FIRE OR SHOCK HAZARDS, DO NOT EXPOSE THIS APPARATUS TO RAIN OR MOISTURE.

CAUTION: TO INSURE PERSONAL SAFETY, OBSERVE THE FOLLOWING RULES REGARDING THE USE OF THIS UNIT.

1. Operate only from the power source specified on the unit.
2. Avoid damaging the AC plug and power cord.
3. Avoid improper installation and never position the unit where good ventilation is unattainable.
4. Do not allow objects or liquid into the cabinet openings.
5. In the event of trouble, unplug the unit and call a service technician. Do not attempt to repair it yourself or remove the rear cover.

Changes or modifications not approved by JVC could void the warranty.

- * When you don't use this TV set for a long period of time, be sure to disconnect both the power plug from the AC outlet and antenna for your safety.
- * To prevent electric shock do not use this polarized plug with an extension cord, receptacle or other outlet unless the blades can be fully inserted to prevent blade exposure.




- As an “ENERGY STAR®” partner, JVC has determined that this product or product model meets the “ENERGY STAR®” guidelines for energy efficiency.

Warnings

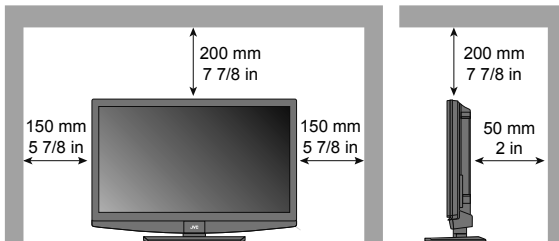
IMPORTANT RECYCLING INFORMATION

This product has a fluorescent lamp that contains mercury. Disposal of these materials may be regulated in your community due to environmental considerations. For disposal or recycling information, please contact your local authorities or for USA, the Electronic Industries Alliance: <http://www.eiae.org>

IMPORTANT SAFETY INSTRUCTIONS

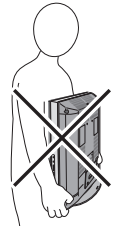
- 1) Read these instructions.
 - 2) Keep these instructions.
 - 3) Heed all warnings.
 - 4) Follow all instructions.
 - 5) Do not use this apparatus near water.
 - 6) Clean only with dry cloth.
 - 7) Do not block any ventilation openings. Install in accordance with the manufacturer's instructions.
 - 8) Do not install near any heat sources such as radiators, heat registers, stoves, or other apparatus (including amplifiers) that produce heat.
 - 9) Do not defeat the safety purpose of the polarized or grounding-type plug. A polarized plug has two blades with one wider than the other. A grounding type plug has two blades and a third grounding prong. The wide blade or the third prong are provided for your safety. If the provided plug does not fit into your outlet, consult an electrician for replacement of the obsolete outlet.
 - 10) Protect the power cord from being walked on or pinched particularly at plugs, convenience receptacles, and the point where they exit from the apparatus.
 - 11) Only use attachments/accessories specified by the manufacturer.
 - 12) Use only with a cart, stand, tripod, bracket, or table specified by the manufacturer, or sold with the apparatus. When a cart is used, use caution when moving the cart/apparatus combination to avoid injury from tip-over.
- 
- 13) Unplug this apparatus during lightning storms or when unused for long periods of time.
 - 14) Refer all servicing to qualified service personnel. Servicing is required when the apparatus has been damaged in any way, such as power-supply cord or plug is damaged, liquid has been spilled or objects have fallen into the apparatus, the apparatus has been exposed to rain or moisture, does not operate normally, or has been dropped.
 - 15) Apparatus shall not be exposed to dripping or splashing and no objects filled with liquids, such as vases, shall be placed on the apparatus.

- 16) Place the television on a stable, flat surface. Failure to do so can result in the television falling, causing injury.
- 17) **DO NOT** allow young children to play around or on the television. Do not hang from the TV. Failure to do so can result in the television falling, causing injury.
- 18) **DO NOT** allow young children to play with the plastic bag that came with the television when you unpacked it. Failure to do so can result in suffocation, causing injury.
- 19) Avoid improper installation and never position the unit where good ventilation is impossible. When installing this TV, distance recommendations must be maintained between the set and the wall, as well as inside a tightly enclosed area or piece of furniture. Keep to the minimum distance guidelines shown for safe operation.



20) Cautions for installation

- Do not tilt the TV towards the left or right, or towards the back.
- Install the TV in a corner on the floor so as to keep cords out of the way.
- The TV will generate a slight amount of heat during operation. Ensure that sufficient space is available around the TV to allow satisfactory cooling.
- Have two people remove the TV from the box with the screen facing away from you. It's possible your clothing, (such as a belt buckle or button) may scratch the front of the TV. Do the same when moving the TV to another location.



- 21) When attaching to a wall, use the optional JVC wall mounting unit.

For LT-42P789: JVC-XUF-2637 LCD FLAT WALL MOUNT

For LT-47P789: JVCPCM-MS2 TILT/FLAT WALL MOUNT

For LT-52P789: JVCPCM-MS2 TILT/FLAT WALL MOUNT

Caution

- Consult qualified installers.
 - See the included manual on mounting procedures.
 - JVC is not responsible for damages or injuries due to improper mounting.
 - Use with other wall mounting unit is capable of resulting in instability or causing possible injury.
- 22) Make enough room for inserting and removing the power plug. Place the TV as close to the outlet as possible. The main power supply for this TV is controlled by inserting or removing the power plug.
 - 23) Batteries shall not be exposed to excessive heat such as sunshine, fire or the like.
 - 24) When this TV is connected to the wall outlet, it is always on standby even when all the LED lamps are not lit. To shut down the TV, unplug the TV from the wall outlet.

Warnings

FCC Notice:

Caution: Changes or modifications not expressly approved by party responsible for compliance could void the user's authority to operate the equipment.

We have an important note for customers who subscribe to basic cable services (do not have a separate cable box) and plan to use their JVC TV remote control to select channels.

Once you run the Auto Tuner Setup (which detects and programs all the channels your TV is receiving through the RF input), every channel number available from your cable company will appear in your television's Channel Summary and they will all be marked as available for scanning. Even though every channel is detected and appears as available, you will only be able to view those that you specifically subscribe to from your cable company. This will likely mean there are blank channels between those channels you wish to scan or "surf".

We apologize for any inconvenience this may cause but it is important to note that this is not a malfunction of your television. If you want to sequentially scan those channels you subscribe to without blank ones in between, you can contact your cable company for their cable box and remote, or manually deselect them using the edit / skip feature on page 30.

Precautions

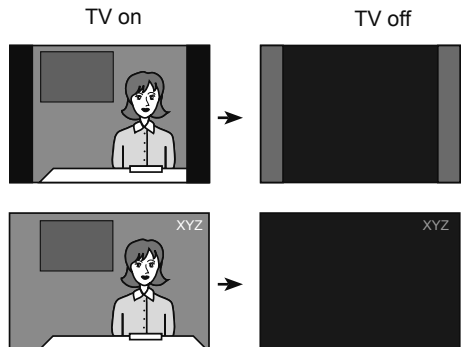
Avoiding Temporary Burn-in

Displaying fixed images for extended periods of time can leave a subtle but temporary burn-in image on your screen. To avoid this, mix your viewing pattern.

Examples include, but are not limited to the following:

- Stock-market report bars
- Shopping channel logos and pricing displays
- Video game patterns or scoreboards
- Bright station logos
- Internet web sites or other computer-style images
- DVD discs, video tapes, laser discs
- Broadcast, cable, satellite channels or digital television tuners/converters

For example...



Caring for the Cabinet

Normally, light dusting with a soft, non-scratching duster will keep your TV clean.

If you wish to wipe down the television, first unplug it. Then wipe gently with a soft cloth, slightly moistened with water. You can add a few drops of mild liquid detergent to the water to help remove spots of oily dirt.

- DO NOT allow liquid to enter the TV through the ventilation slots.
- DO NOT use strong or abrasive cleaners on the TV.
- DO NOT spray liquids or cleaners directly on the TV's surface.
- DO NOT rub or scrub the TV harshly. Wipe the set gently with a soft cloth.

Caring for the Screen

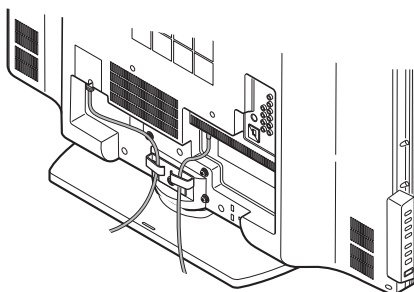
The screen is treated with an electrostatic-proof coating. When it gets dirty, wipe it gently with a soft cloth. If the screen is very dirty, wipe it down with a cloth dipped in a diluted kitchen cleaner and thoroughly wrung-out. Then wipe immediately after with a clean, dry cloth.

Do not apply alcohol, organic solvents (like acetone), acidic or alkaline cleansers to the screen. These will remove the coating layer and cause discolorations.

Do not push or hit the screen. This could cause scratches on the screen surface and image distortions.

Tidying the cables

A cable holder which keeps your connection cables tidy is attached to the back of the stand.

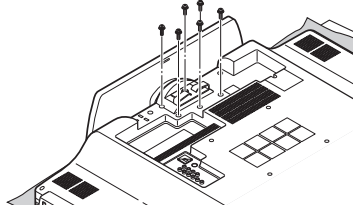


Precautions

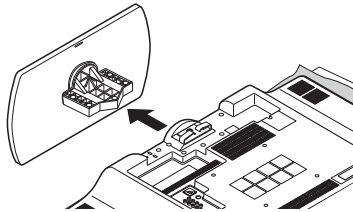
Disconnecting the stand

If you disconnect the stand, attach the bottom cover and the screw (supplied) into the hole.

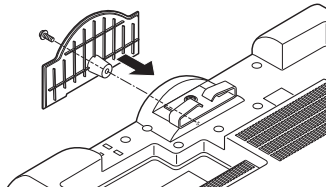
- 1) Place the TV face down on a soft cloth on a table.
- 2) Remove the screws from the back of the TV.



- 3) Pull out the stand from the TV.



- 4) Cover the hole with the supplied bottom cover and tighten the screw.

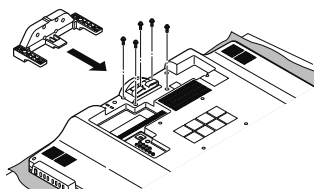
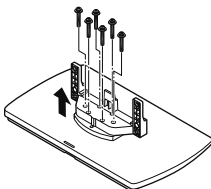


Notes:

- To re-install the stand, reverse the procedure from 4) to 1).
- If you find it difficult to remove the screws from inset screw wells, use a magnetized screwdriver.

* In the case of placing the 52" TV on the wall, please follow the next steps.

- 1) Remove the TV base from the upper body
- 2) Attach the upper stand body to the TV.



Precautions

Package Contents

Make sure you have the following.

Television x 1



Remote Control x 1



AA Batteries x 2



Screw x 1

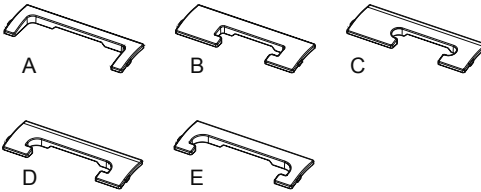


Bottom Cover x 1



(42/47 inch only)

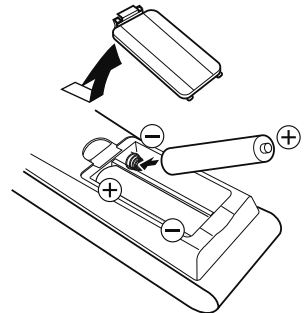
Dock Adapter x 5



Insert the batteries

Use two "AA" batteries (included).

Place the "-" end in the unit first, making sure the "+" and "-" markings are correct. Place the "-" end in the unit first.



If this symbol is shown, it is only valid in the European Union

Remote Control

The following pages gives you a brief description of each button's function. For more detailed information on the remote control buttons, see pages 19 - 21. This remote can also control up to four other devices. See page 52 - 58.



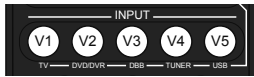
Choose how long the TV will stay on before turning off. See page 19.



Turns the TV on or off.

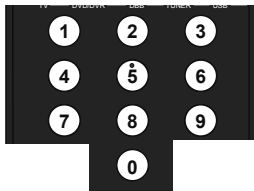


Switch between "TV / STB / VCR / DVD / AUDIO" devices. See page 52.



Switch between devices connected to Video-1, 2, 3, 4 and 5.

For V4 (Video-4) and V5 (Video-5) you must select the signal input type first (ie. composite, S-Video, or component). To do so, you need to press the V4 or V5 button until the correct type is highlighted. Select "Composite 1" for composite video signal input, "S-Video" for S-video signal input, or "Component 1" for component video signal input. Select "Composite 2" for composite video signal input or "Component 2" for component video signal input.



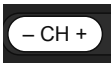
Change channels. Input remote codes. See page 52.



Lets you decide the input channel and select it. After pressing the remote 0 - 9 buttons, press TUNE.



Lets you go back to the previously selected channel. See page 19.



Move sequentially through the channels.



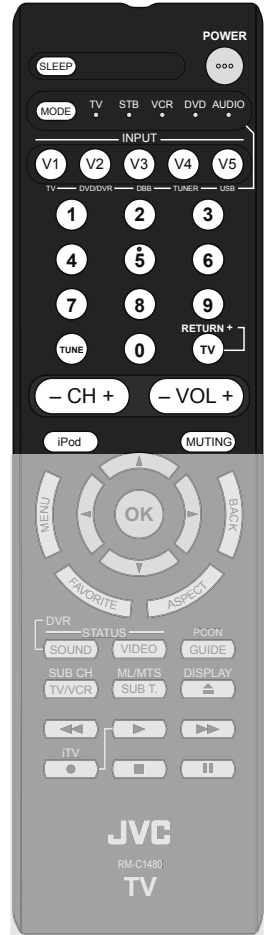
Raise or lower the volume.



Control your iPod connected to the TV. See page 42.



Turns the TV volume to 0. Press again to restore the volume.



Remote Control



Used to access the TV's onscreen menus.
See page 22.



Used to navigate through the TV's onscreen menus.



Go back to a previous onscreen menu or to correct a mistake.



Save your favorite channels. See page 19.



Change the aspect ratio of the image on your TV screen. See page 20.



Choose several types of sound frequencies.
See page 20.



Choose different display settings according to personal preferences. See page 20.



Programming information. **(Digital channels only)**. See page 21.



Used to select sub channels.
(Digital channels only). See page 21.



Listen to a program in stereo, mono or another language (SAP). **(Depending on availability in the program)**. See page 21.



View current channel information.

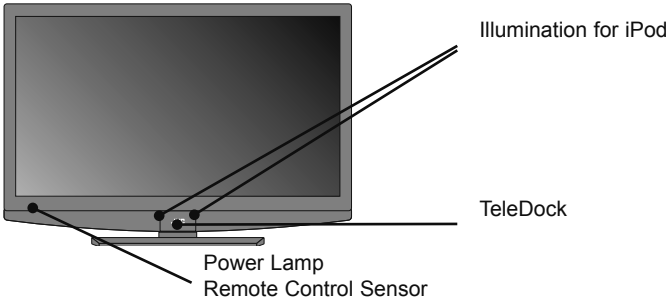


* See page 52 for buttons that control your external devices.

TV Basic Controls

Before you connect your television to another device, please refer to the proper diagrams for your specific TV and remote. These will help assist you in understanding how to connect your television to another device, as well as use the remote to set up your television. Some of the connection terminals are color coded for easy connection with the proper cables.

Front Panel



Notes:

- Do not use unreasonable force to the TeleDock.
- When not using the TeleDock, close the cover.
- Do not touch the connector pins of the TeleDock or the iPod terminal pins.
- Do not put different devices on the TeleDock. It may cause a connection failure.

Side Panel



Input

Change the input

MENU

Used to access the TV's onscreen menus.

+CH-

Move sequentially through the channels.

+VOL-

Raises or lowers the volume.

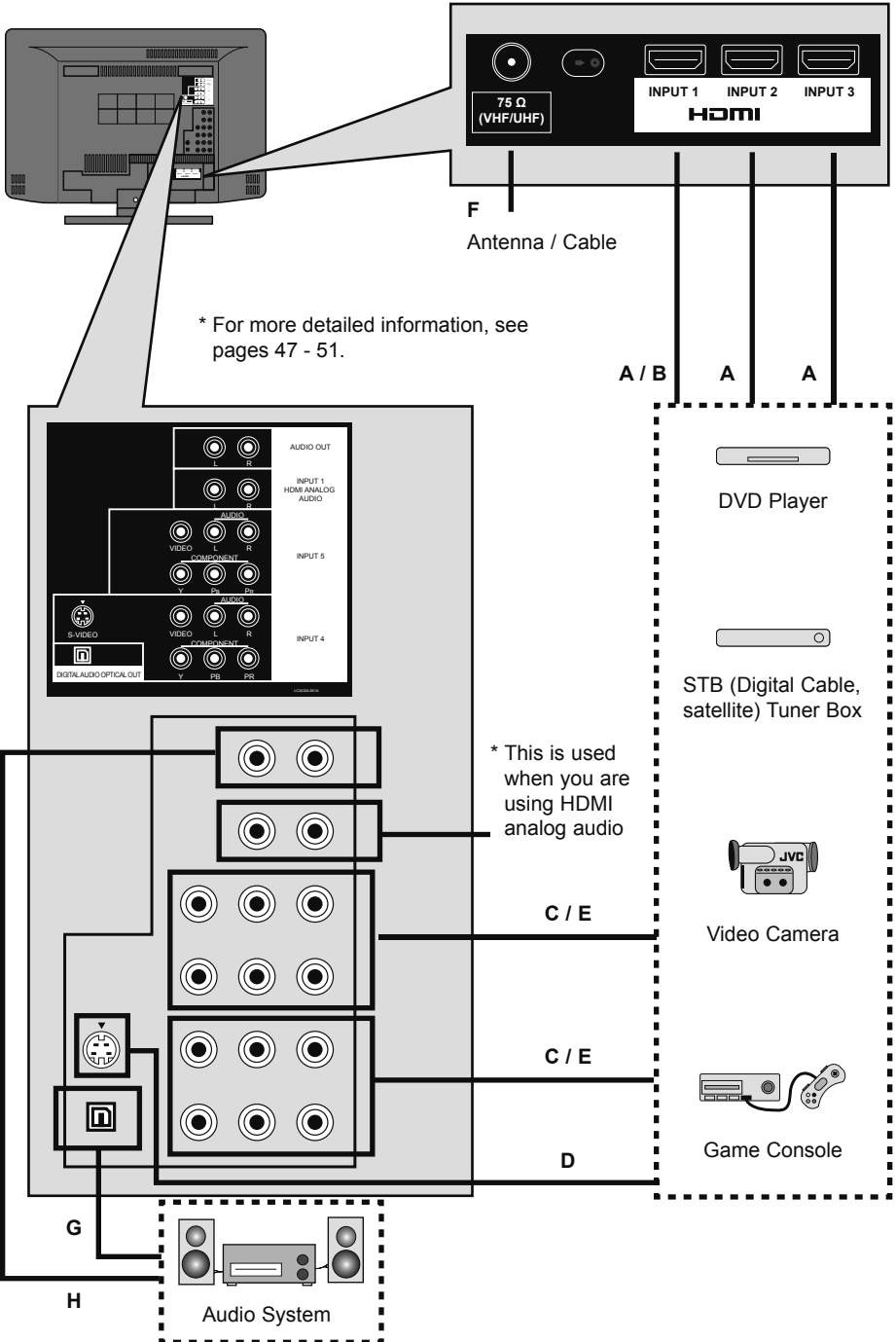
POWER

Turn the TV on or off.




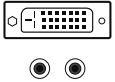
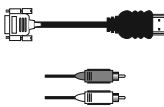
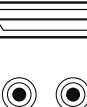
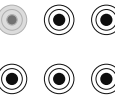
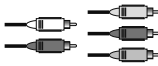
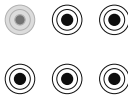

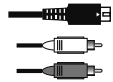
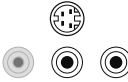












Photo Viewer Connector

- Do not use Photo Viewer connector to connect the iPod

TV Basic Controls



TV Basic Controls

		Device Side	With Cables	TV Side
VIDEO and AUDIO	↑ Best ↓ Good	 HDMI	 HDMI Cable	 INPUT 1, 2 or 3
		 DVI + Audio	 DVI – HDMI Cable, Audio Cable	 Input 1 + HDMI ANALOG AUDIO
		 Component Video + Audio	 Component Video + Audio	 INPUT 4 or 5
		 S-Video + Audio	 S-Video Cable, Audio Cable	 INPUT 4 + AUDIO Input
		 Composite Video + Audio	 Composite Video + Audio	 INPUT 4 or 5
		 Antenna / Cable (VHF / UHF)	 RF Cable	 75Ω (VHF / UHF)
AUDIO	↑ Best ↓ Good	 OPTICAL INPUT	 OPTICAL AUDIO Cable	 DIGITAL AUDIO OPTICAL OUT
		 AUDIO INPUT (L / R)	 Audio Cable	 AUDIO OUT (L / R)

TV Basic Controls

Compatible Signal	Notes
Input <ul style="list-style-type: none">HDMI (Digital) SD: 480i, 480p HD: 1080i, 1080p/60Hz, 720p Audio L/R	See page 51.
Input <ul style="list-style-type: none">DVI (Digital) SD: 480i, 480p HD: 1080i, 1080p/60Hz, 720pAudio L/R (Analog)	See page 50.
Input <ul style="list-style-type: none">Component (Analog) SD: 480i, 480p HD: 1080i, 720pAudio L/R (Analog)	See page 48.
Input <ul style="list-style-type: none">S-Video (Analog)Audio L/R (Analog)	
Input <ul style="list-style-type: none">Composite (Analog)Audio L/R (Analog)	See page 48.
ATSC (Digital) NTSC (Analog) Clear QAM (Digital)	See page 47.
Output <ul style="list-style-type: none">Audio L/R (Digital) (PCM or Dolby Digital)	See page 49.
Output <ul style="list-style-type: none">Audio L/R (Analog) (Fixed)	See page 49.

Setup

Initial setup

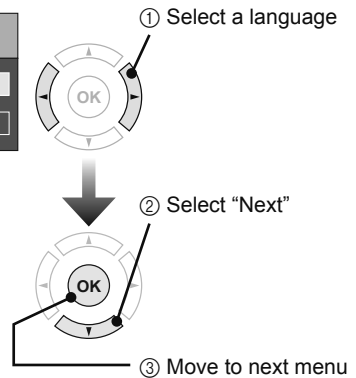
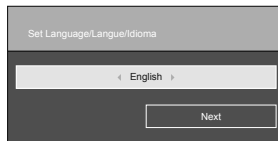
When you turn on your TV for the first time, the Initial Setup menu appears automatically. These menus will help you setup your TV with basic information for **Language**, **Time** and **Tuner Setup**. You can also set this setting in the "Plug in Menu".



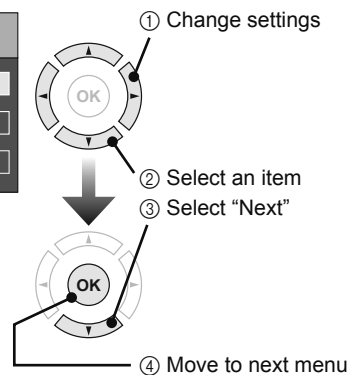
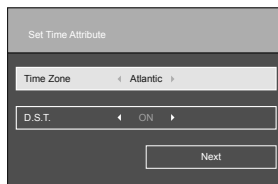
1) Turn on the TV



2) Set the language



3) Set time attribute

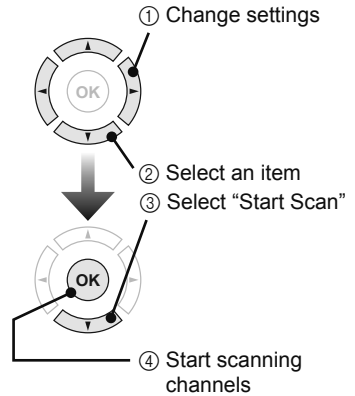
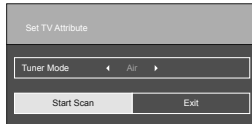


Time Zone	Choose the time zone you live in.
D.S.T.	Changes the clock automatically for daylight saving time. On / Off

Initial setup (Continued)



4) Set TV attribute



Tuner Mode	Choose Air (antenna) or Cable
------------	-------------------------------

* If you use a set top box (satellite or cable box), press "Exit" to skip this step.

Cable Users: After your auto tuner setup is complete, you may, (depending on the type of hookup), have only 1 channel, usually 2, 3 or 4 in the auto tuner memory. This is normal.

"Thank you! Setup is now complete"

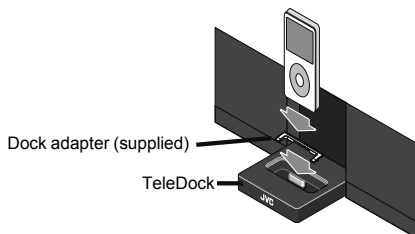
Note:

- If you want to turn off the Auto Demo, press the **MENU** button.

Key Features

Your JVC TV is equipped with many features. Here is some key features highlighted in detail.

- 1 Simple playback of video and music on TV. You can charge your iPod. You can watch a program while listening to the iPod (source of program must be from TV's Internal Tuner). You can view photos from the iPod while listening to the iPod.



- 2 Stunning picture quality via 1920x1080 Full HD panel. Dynamic Gamma and Color Management give further fine tuned picture reproduction. Smart Picture adjusts the best possible picture quality automatically scene by scene based on the incoming signal from any source!



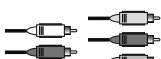
- 3 JVC exclusive oblique cone speakers provide excellent TV sound quality. OmniSurround sound provides you 4 different settings based on the program you are watching. The equalizer will fine tune your listening preferences.



- 4 Full connectivity with 3 HDMI, 2 Component, 1 S-video and others. The variety of connections are explained in pages. 47 to 51.



x 3



x 2



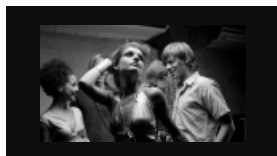
x 1

- 5 Aspect mode will show every pixel you are getting in High Definition. The Native mode will show 100% of 1080p. Full – with slight overscan. Panarama, Cinema will fill the screen with various aspect settings. Mini Mode will show a better picture with a smaller screen for low resolution content from your iPod.



Full or Widescreen Mode – For high quality iPod sources.

Or...



Mini Mode – For low quality iPod sources.

Remote Control Functions



Sleep

Allows you to choose how long the TV will stay on before turning off.

Notes:

- When you press the **SLEEP** button several times, you can set the interval at Off, 15, 30, 45, 60, 90, 120, 150 and 180 minutes.
- 60 seconds before the TV turns off, a message will appear and it will count the remaining time. If you want to extend the time, press the **SLEEP** button and you can change the interval. If you don't press the **SLEEP** button, within 60 seconds the TV will turn off.



Return+ TV

Has three functions.

Return – Returns to the channel viewed just before the channel currently onscreen.

Return+ – Lets you program a specific channel to return to while scanning through the channels using the **- CH +** button as you memorize the channel.

TV – Returns to the TV mode as you are watching a video, DVD, etc.

Note:

- Press **TUNE** and **RETURN+ TV** buttons. This will memorize the current channel to return to while you scan through the other channels. To cancel, press **TUNE** and **RETURN+ TV** buttons again.



Favorite

Allows you to save channels you like so you can view them easily. First you must register the channels you like.

Notes:

- Go to the channel you want to register and press the **FAVORITE**. A list will appear. Press the **FAVORITE** button again to register your channel.
- To view your favorite channels, press **FAVORITE**. Move **▲ ▼** to select your channel and press **OK**.
- To erase your favorite channels, press **FAVORITE**. Move **▲ ▼** to select your channel and press **►**.
- Both analog and digital channels can be registered.
- The channels you registered will appear in numerical order at the top of the list.

Remote Control Functions



Aspect

Allows you to adjust the way the image appears on your TV based on the format that is being received.

Panorama / Cinema / Full / Panorama Zoom / Cinema Zoom / Full Native / Regular / Slim

See page 28.

Notes:

- You can select the aspect mode by pressing the **ASPECT** button.
- You can also access the aspect modes using the buttons on the side of the TV, by using the **MENU** button, then the **- CH +** button.



Sound

You can choose several types of sound modes. **Speech / Jazz / Classic / Rock / User**

Notes:

- You can choose the different sound modes by pressing the **SOUND** button.
- If you select **User**, you can customize the various sound frequencies.



Video

Allows you to choose different picture settings according to personal preferences. You can access this feature for each input (TV, V1, V2, V3, V4, V5).

Standard / Dynamic / Theater / Game

See page 23.

Remote Control Functions

GUIDE

Guide

You can view program information for Digital Channels.

Note:

- When the program information is not being broadcast, the correct information will not be displayed.
- The GUIDE will not show the correct time and date depending on the Time Zone and D.S.T. settings. See page 40.

SUB CH
TV/VCR

SUB CH

Digital broadcast sometimes offers sub channels. By using the **SUB CH** button, you can select a sub channel easily.

For example, to move to sub channel 123-45:

- 1) Press **1**, **2** and **3** in order
- 2) Press the **SUB CH** button
- 3) Press **4** and **5** in order
- 4) Press the **TUNE** button

ML/MTS
SUB T.

ML/MTS

Allows you to listen to a program in stereo, mono sound or another language (SAP) if available. First you must set the **MODE** to **TV** on your remote.

Notes:

- When you are receiving a digital broadcast, if there are other languages, you can change the language by pressing the **ML/MTS** button.
- Keep the TV in stereo mode to get the best sound quality. The sound will work in stereo mode even if a certain broadcast is in mono sound only.
- Choose the mono setting to reduce excessive noise on a certain channel or broadcast.
- MTS is unavailable if your television's Input source is (**V1**, **V2**, **V3**, **V4**, **V5**).
- ML/MTS will not work when you are using HDMI.

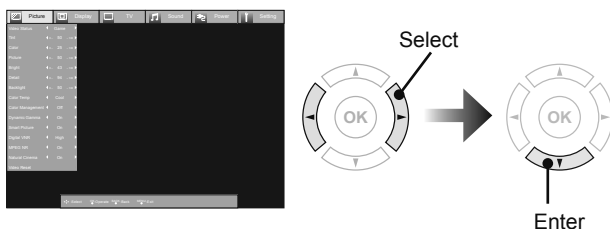
Customizing your TV



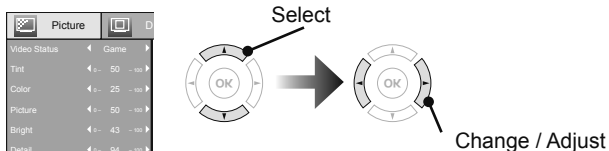
1) Display the menu bar



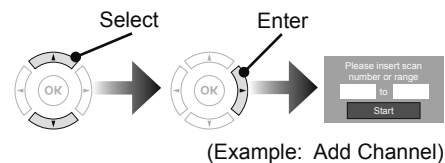
2) Display the desired menu



3) Change or adjust the setting



■ To enter an item's sub menu



■ To the previous screen



4) Close the menu



Note:

- Depending on the situation (analog channels, digital channels, video signal format, external inputs, etc.), some items will be displayed in gray and can not be selected.

Customizing your TV

Picture



Video Status

Choose different display settings according to personal preferences. You can use this feature with TV, V1, V2, V3, V4 and V5.

Standard

Resets the picture display to the factory settings.

Dynamic

Gives a vivid picture with better contrast when viewing in a brightly lit room.

Theater

Gives a rich, film-like look to video when viewing in a dimly lit room.

Game

Used for when you are playing video games connected to your TV.

Notes:

- Each mode is memorized for each input (TV, V1, V2, V3, V4, V5) connected to the TV.
- Each video status setting has a separate memory for HD (1080i/1080p/720p) and SD (480p/480i) video signal. Each video status can be chosen along with your favorite picture settings (Tint, Color, Picture, Bright, Detail and Backlight).
 - When an HD or SD signal is displayed, your HD or SD settings are recalled for the video status you are using.

Customizing your TV

Picture (Continued)

■ Allows you to change and adjust the way the picture appears on your television.

Tint

Allows you to adjust the levels of red and green on your TV.

Color

Allows you to make all the colors on your TV appear more vivid or subtle.

Picture

Allows you to adjust the level of black and white on your TV giving you a darker or brighter picture overall.

Bright

Allows you to adjust the overall brightness of the TV.

Detail

Allows you to adjust the level of fine detail on your TV.

Backlight

Allows you to adjust the brightness of the internal lamp which effects the overall brightness of the TV.

Color Temp

Allows you to adjust colors to look as accurate as possible. **Cool / Natural / Warm**

Color Management

Allows you to compensate for dull colors to ensure dull colors are reproduced with natural hues. **On / Off**

Dynamic Gamma

Allows you see more detail in very dark or bright areas so these areas don't appear "muddied". Normally, this feature should be left **On** for optimum picture quality. **On / Off**

Customizing your TV

Picture (Continued)

Smart Picture

Allows the TV to adjust the brightness level automatically to a level suitable for what you are watching. **On / Off**

Digital VNR

This function can be selected to change the effect of Digital VNR (Video Noise Reduction).

High – Adjusts the effect maximally

Low – Adjusts the effect minimally

Off – Function is turned off.

MPEG NR

This function effects the block noise removal and mosquito NR (Noise Reduction) simultaneously.

Note:

- When you are receiving digital channels, block noise removal will have no effect.

Natural Cinema

Allows you to compensate for image blurring when the original video you are watching was shot at 24 frames/sec, and is broadcast at 30 frames/sec. This conversion process is known as "TELECINE". **On / Off**

Notes:

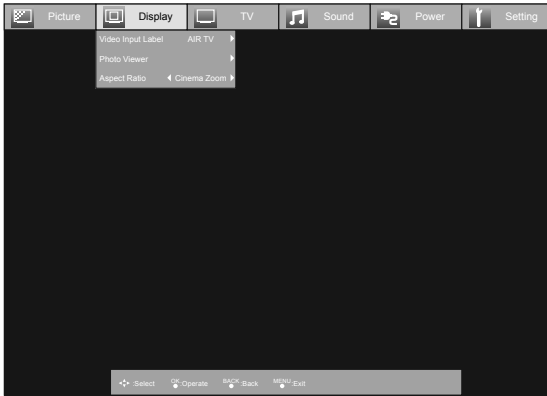
- When you are receiving a 480p, 720p or 1080p signal, Natural Cinema cannot be selected.
- Natural Cinema is only applied for SD 480i and HD 1080i signals.

Video Reset

Resets all picture adjustments at once to the default settings, except for Natural Cinema.

Customizing your TV

Display



Video Input Label

Allows you to label all the devices you have connected to the TV that use the VIDEO-1, 2, 3, 4 and 5 inputs.

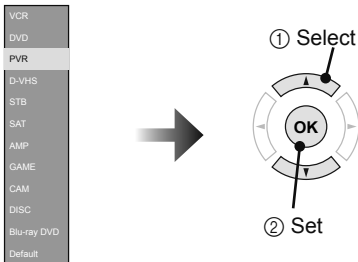
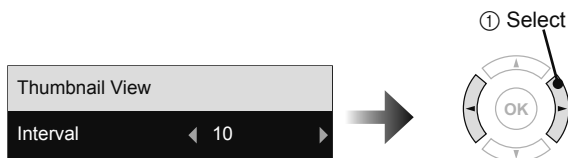


Photo Viewer

Connect your USB Mass Storage Class device to the Photo Viewer terminal on the TV.

Photo Viewer allows you to enjoy your digital pictures stored on your USB Mass Storage Class devices. You can view them on the TV in high quality.

1) Choose Slide Show Interval of 5, 10 or 20 seconds by pressing the ◀ ▶ buttons.



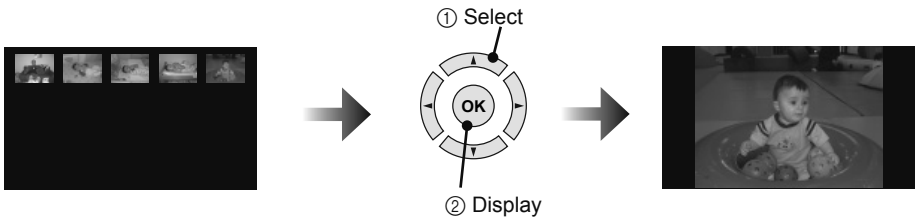
Customizing your TV

Display (continued)

2) Choose Thumbnail View by pressing the ► button, and a folder list will be displayed. Select your folder by using the ◀► or ▲▼ buttons. The screen will show the first 10 images.

* If there is more than 10 images, those images will be shown in the next page. To go to the next page, select the last image on the page and press the ► or ▼ buttons. To go back to the previous page, press the ◀ or ▲ buttons.

3) Choose a picture and press the **OK** button. It will now be shown on the screen. To move to the next picture, press the ► or ▼ buttons. To move to the previous picture, press the ◀ or ▲ buttons.



2 90° Rotation

4 180° Rotation

8 270° Rotation

6 360° Rotation

TUNE Start Slideshow

4) To go back to main menu, press the **MENU** button.

Notes:

- Gently pull out your USB device from the Photo Viewer terminal after finishing the “Photo Viewer” menu.
- Use the supplied USB cable that came with your device. Do not use HUB or USB extension cable.
- Photo Viewer cannot be guaranteed to work with all USB Mass Storage Devices. It may take some time to display or it may not display correctly.
- Please refer to the Customer Support website at www.jvc.com/support for information and notes regarding your devices you wish to connect.
- Supported file formats are “.jpg” or “.JPG”.
- All your stored data should be backed up first as a precaution before connecting to the TV.
- Depending on your stored file size, it can take extra time to display “Photo Viewer” page.
- You can not display photos using the SD card from the JVC Everio Camera.

Customizing your TV

Display (continued)

Aspect

Allows you to adjust the way the image appears on your TV based on the format that is being received.

Panorama - When watching a 4:3 aspect picture it is stretched to fit the dimensions of the 16:9 aspect screen.

Cinema - This ratio “zooms in” on the center part of a 4:3 aspect picture, blowing it up proportionally to fill the 16:9 screen.

Full - When watching a 4:3 aspect picture, it is stretched to fit the dimensions of the TV. When watching a 16:9 aspect picture, it displays 95% of the ratio.

Panorama Zoom - When watching a High-Definition 16:9 aspect picture it is stretched to eliminate the black side bars.

Cinema Zoom - This ratio “zooms in” on the center part of a High-Definition 16:9 aspect image to eliminate the black surrounding bars.

Full Native - This ratio displays 100% of the ratio. Normally, all aspects except for **Full Native** display about 95%.

Regular - When watching a 4:3 aspect picture without modifying the original picture to fit the dimensions of your 16:9 screen. Black bars will appear along the picture's sides. The picture will be centered within the boundaries of the 16:9 screen.

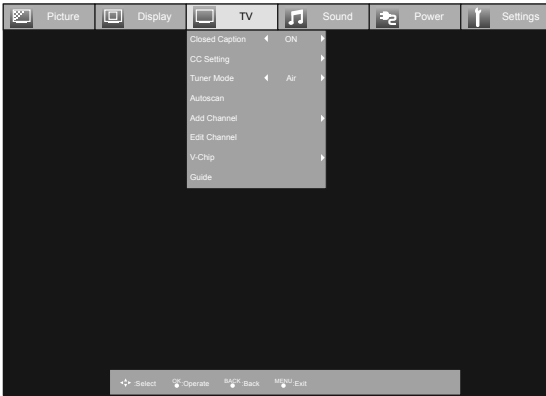
Slim - This aspect mode shrinks the screen of a 16:9 broadcast to 4:3. There are some programming that is already stretched by mistake at broadcasting companies, so this mode corrects it. Black side bars will appear.

Notes:

- Depending on the signal format, some aspect modes are unavailable.
- Slim can only be displayed when the signal is ATSC (480i, 480p, 720p, 1080i) or HD (720p, 1080i).
- If the television receives a 16:9 signal from your HDMI device, the aspect mode will turn to Full automatically. If the television receives a 4:3 signal from your HDMI device when you are in Full aspect mode, it will return to Regular aspect mode. If you change the aspect mode after the television changed it to Full automatically, the television will change to the aspect mode you choose. It also turns to Full automatically when the TV receives an HD (1080i or 720p) signal.
- You can access the aspect modes using the buttons on the side of the TV, by using the **MENU** button, then **- CH +** button.

Customizing your TV

TV

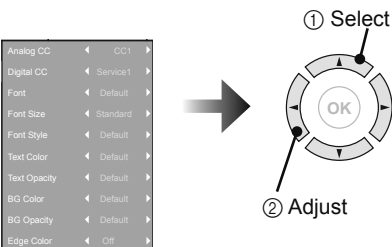


Closed Caption

Allows you to select the mode of the closed caption. First you must set the **MODE** to either **TV**, **STB** or **VCR** on your remote. **On / Smart / Off**

C.C. Setting

You can choose between caption or text in MODE to decide how closed captioning will appear.



Customizing your TV

TV (continued)

Analog CC

Choose the CC feature that you like for analog Closed Captioning.

Digital CC

Choose the CC feature that you like for digital Closed Captioning.

Font

Choose the font that you like for Closed Captioning.

Font Size

Choose how big the text appears in Closed Captioning.

Font Style

Choose the style of the font in Closed Captioning.

Text Color

Choose the color of the text in Closed Captioning.

Text Opacity

Choose how translucent the text appears in Closed Captioning.

BG Color

Choose the background box color for the Closed Captioning text.

BG Opacity

Choose how translucent the background box color for the Closed Captioning text.

Edge Color

Choose the color of the border of the background box color for the Closed Captioning text.

Note:

- The Font, Font Size, Font Style, Text Color, Text Opacity, BG Color, BG Opacity and BG Color settings will not apply to Closed Caption of analog channels. In addition, some of these settings for Closed Caption for digital channels may or may not be available, depending on the Closed Captioning data being broadcast.

Tuner Mode

If you skipped this step in the initial setup or your setup has changed, you can redo your setup in this menu. **Air / Cable**

Autoscan

Allows you to scan through all available channels your TV can receive, and memorizes them.

Note:

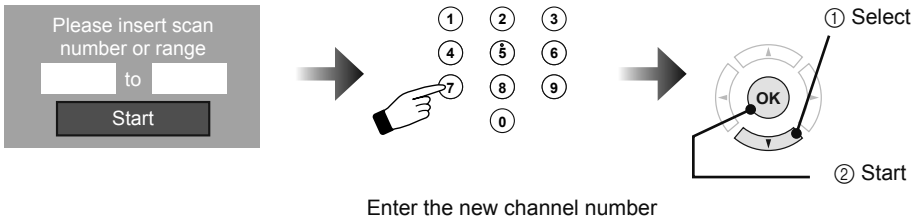
- The Autoscan is finished when the message **Scanning has completed** appears on the screen.

Customizing your TV

TV (continued)

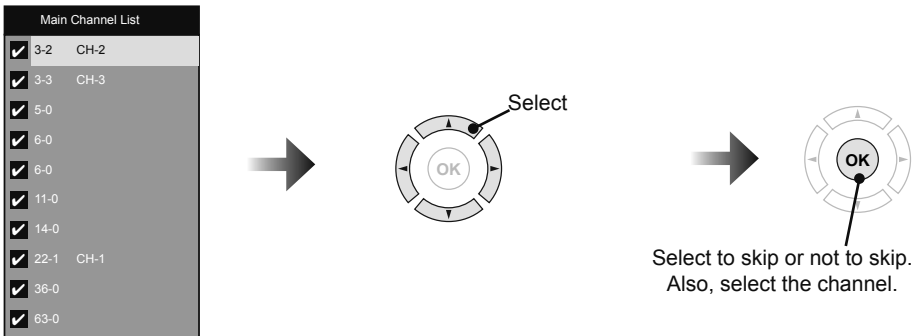
Add Channel

Allows you to add analog channels. Regarding digital channels, the only channels that will appear are the ones that are being broadcast.



Edit Channel

Allows you to skip channels when using the + CH – button. “✓” means don't skip, “ ” means to skip. You can still access those skipped channels manually using the number buttons on the remote.



V-Chip

Allows you to block channels or content that you deem inappropriate for children. See pages 32 – 36.

Guide

You can view program information. (**Digital channels only**).

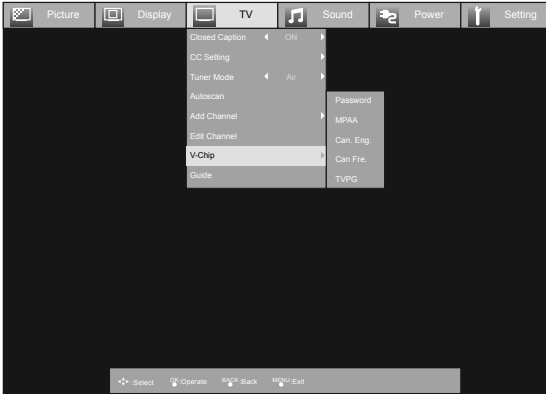
Note:

- If the programming information is not being broadcast, the guide function has no effect or may display incorrect information.

Customizing your TV

TV (V-Chip)

Allows you to block channels or content that you deem inappropriate for children.

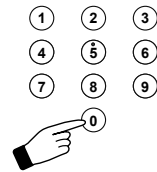
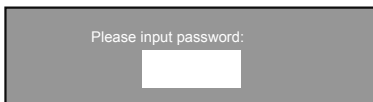


Notes:

- V-CHIP will not work with video signals from VCRs, DVD players, Blu-ray or camcorders connected to the TV.
- **(For Canadian viewers only):** V-CHIP is designed specifically for the US and may not work properly in Canada.

– When entering the password –

When you try and access the V-Chip menu, “Please input password” will appear. Press the “0” button four times on your remote to access the V-Chip menu for the first time.



– When you lock or unlock channels –

You can lock or unlock ratings as shown below.

Password	NR	🔒
MPAA	G	🔒
Can. Eng.	PG	🔒
Can. Eng.	PG13	🔒
Can Fre.	R	🔒
Can Fre.	NC-17	🔒
TVPG	X	🔒



2 Lock / Unlock

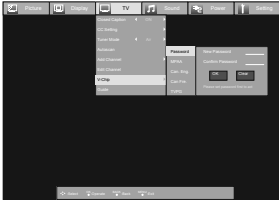
Note:

- If you lock a rating, any rating that is higher is automatically blocked.

Customizing your TV

TV (V-Chip) (continued)

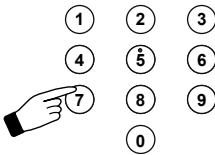
Password



You can change the four digit password using the number buttons on your remote.

* If you forget your password, unplug the TV from the wall and then plug it back in. Your password will reset to "0000"

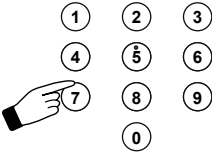
1) Set a new password



Enter the four digit number



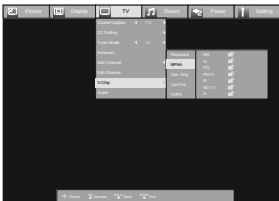
2) Confirm and set



Enter the four digit number



MPAA



This setting is based on the US Motion Picture Association of America (MPAA) ratings system.

Customizing your TV

TV (V-Chip) (continued)

MPAA (continued)

NR – Not Rated.

Any type of programming that does not contain a rating.

G – General Audience.

Suitable for all ages.

PG – Parental Guidance Suggested.

Suitable for all ages with parental guidance.

PG 13 – Parents Strongly Cautioned.

Intended for viewers 13 years or older.

R – Restricted.

Not recommended for viewers 17 years without parental guidance.

NC-17 – No One Under 17.

Not intended for viewers 17 years or younger.

X – No One Under 18.

Not intended for viewers 18 years or younger.

Viewing Guidelines:

At the beginning of a program, the program will display its rating and the content it contains. **(Except for unrated programming).**

A program can contain any or all of the following:

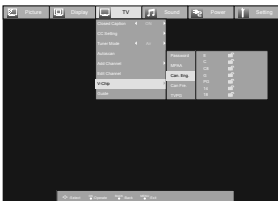
V/FV – VIOLENCE/FANTASY VIOLENCE

S – SEXUAL CONTENT

L – Strong LANGUAGE

D – Suggestive DIALOG

Can. Eng.



This setting is based on the Canada ratings system.

Customizing your TV

TV (V-Chip) (continued)

E – Exempt.

Any type of programming that does not contain a rating.

C – Intended for children.

Suitable for all ages.

C8+ – Intended for children over 8 years old.

Suitable for all ages over 8 years.

G – General Audience.

May contain material not suited for younger viewers.

PG – Parental Guidance.

May contain material not suited for younger viewers. Parents may consider some content not appropriate for children 8 - 13 years old.

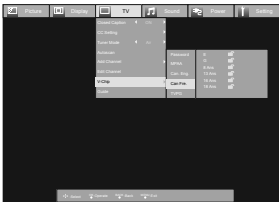
14+ – 14 Years or Older.

Parents strongly urged to use their discretion in allowing viewing by persons under 14.

18+ – Adult.

Intended for viewers 18 years or older.

Can. Fre.

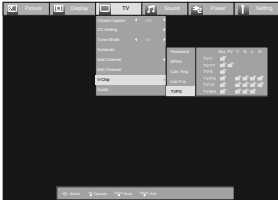


For instructions on “Can. Fre.”, please see page 35 in the French user’s guide.

Customizing your TV

TV (V-Chip) (continued)

TVPG



This setting is based on the US ratings system.

TV Y – Appropriate for all children.

Intended for all children 2 - 6 years old.

TV Y7 – Appropriate for older children.

Intended for children 7 years or older.

TV G – General Audience.

Suitable for all ages.

TV PG – Parental Guidance Suggested.

Suitable for all ages with parental guidance.

TV 14 – Parents Strongly Cautioned.

Intended for viewers 14 years or older.

TV MA – Mature Audiences Only.

Intended for viewers 18 years or older.

Viewing Guidelines:

In addition to the above ratings, you can also block or allow more specific content. **(Except for unrated programming).**

A program can contain any or all of the following:

V/FV – VIOLENCE/FANTASY VIOLENCE

S – SEXUAL CONTENT

L – Strong LANGUAGE

D – Suggestive DIALOG

Customizing your TV

Sound



MTS

Allows you to listen to a program in stereo, mono sound or another language (SAP).
(Depending if available in the program). First you must set the **MODE** to **TV** on your remote.

Notes:

- When you are receiving a digital broadcast, if there are other languages, you can change the language by pressing the **ML/MTS** button.
- Keep the TV in stereo mode to get the best sound quality. The sound will work in stereo mode even if a certain broadcast is in mono sound only.
- Choose the mono setting to reduce excessive noise on a certain channel or broadcast.
- MTS unavailable if your television's input source is **(V1, V2, V3, V4, V5)**.
- ML/MTS will not work when you are using the HDMI.

Digital Audio (ML)

You can change the language if there are other languages available. **(Digital channels only)**

Surround

You can select the surround mode you like. **Movie / Music / News / Mono / Off**

Customizing your TV

Sound (continued)

Sound Status

You can choose several types of sound modes. **Speech / Jazz / Classic / Rock / User**

Note:

- If you select **User**, you can customize the various sound frequencies.

Audio Reset

Resets all sound adjustments at once to the default settings.

Customizing your TV

Power



Sleep Timer

Allows you to choose how long the TV will stay on before turning off. First set the **MODE** to **TV**.
Off / 15Min / 30Min / 45Min / 60Min / 90Min / 120Min / 150Min / 180Min

Note:

- 60 seconds before the TV turns off, a message will appear and it will count the remaining time. If you want to extend the time, press the **SLEEP** button and you can change the interval. If you don't press the **SLEEP** button, within 60 seconds the TV will turn off.

Power Indicator

Allows you adjust the brightness of the blue power indicator light.

High – Light is brightly lit

Low – Light is dimly lit

Off – Light is off

Illumination

Allows you adjust the brightness of the center blue light around the TeleDock.

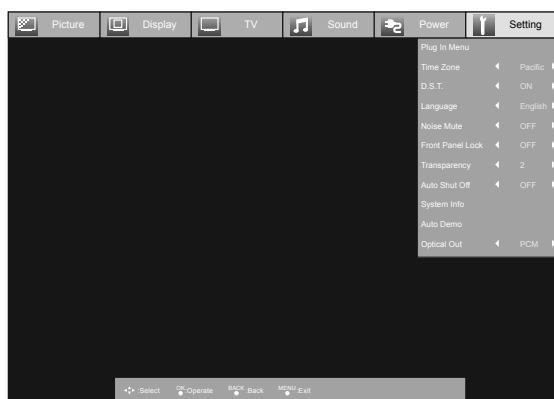
High – Light is brightly lit

Low – Light is dimly lit

Off – Light is off

Customizing your TV

Setting



Plug-In Menu

When you turn on your TV for the first time, the Initial Setup menu appears. If you skip it, or your setup has changed, you can set it up in this menu anytime.

Time Zone

Choose the time zone you live in and the clock sets automatically.
Atlantic / Eastern / Central / Mountain / Pacific / Alaska / Hawaii

D.S.T.

Adjust your TV's clock for Daylight Savings. **On / Off**

Language

Allows you to change the TV's onscreen menu languages to English, French or Spanish.

Noise Mute

Displays a blank gray screen over channels that are too weak to be received clearly.
On / Off

Customizing your TV

Setting (continued)

Front Panel Lock

This allows you to lock the buttons on the side of the TV. **On / Off**

Transparency

Change the transparency of the menu screens. **1 / 2 / 3 / 4**

Auto Shut Off

This function automatically shuts off your TV when there is no signal from the channel while the TV is on for 10 minutes. **On / Off**

System Info

You can confirm the TV's software version.

Auto Demo

Auto Demo explains this TV's features to you.

Notes:

- Please complete the Initial Setup menu first. The Auto Demo mode will start automatically when the Initial Setup menu is completed.
- If you press any button on the television or remote, with the exception of POWER or MENU, the Auto Demo mode will stop for 30 seconds. After 30 seconds have passed with no operation, the Auto Demo mode will start again.
- If you want to turn off the Auto Demo, press the **MENU** button.

Optical Out

You can select the optical digital sound output as PCM or DOLBY DIGITAL when your TV is connected to an amplifier that has a DOLBY DIGITAL decoder. If you select DOLBY DIGITAL, you can enjoy listening to 5.1ch sound when watching digital broadcasts. This only applies to digital channels.

Notes:

- If your amplifier does not have DOLBY DIGITAL decoder, select PCM. If you don't select PCM, it cannot output the sound from the speakers.
- For connecting an amplifier using the optical output, see page 49.



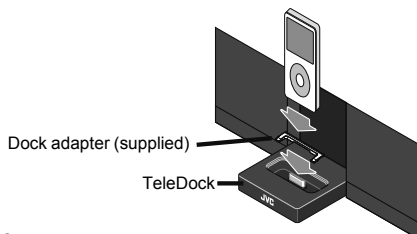
Manufactured under license from Dolby Laboratories. "Dolby", and the double-D symbol are trademarks of Dolby Laboratories.

Enjoy movies/music from your iPod

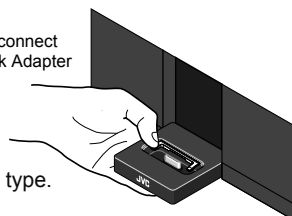
By inserting your iPod into the TeleDock, you can display movies or music on your TV from your iPod. Also, while inserted you can recharge your iPod.

Ready to play

1) Insert your iPod into the TeleDock on the front of the TV.



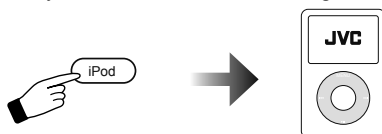
How to connect the Dock Adapter



Notes:

- For more stability, use the supplied Dock Adapter and make sure to use the proper adaptor. If an incorrect adapter is used, it may damage the iPod connector.
- It is recommended that music, pictures and movies on the iPod be saved on your PC or other hard drive for backup.
- Please be sure to connect/disconnect the iPod properly from the TeleDock and use the iPod without any accessory/case.
- Please do not jiggle the iPod in the TeleDock to avoid connection failure or damage to the connector.

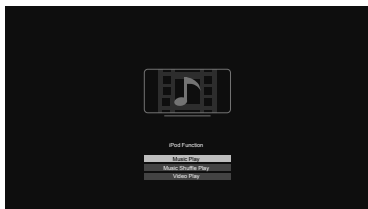
2) Press the **iPod** button on your remote, then the JVC logo will appear on the screen of the iPod.



Notes:

- You cannot operate the iPod while the Apple logo appears on the screen of the iPod.
- The iPod's menu does not appear on the TV screen.

3) TV screen will change to the iPod start screen.












4) To exit the menu, press the **iPod** button.

5) When you detach your iPod, while gently holding the base, pull the iPod gently straight upwards. Once detached the TV will return to the program you were watching.

Enjoy movies/music from your iPod

Compatible iPod Types

* If your iPod is not listed in this chart, it is incompatible with this television.

	iPod					iPod nano			iPod mini
	4G	Photo/Color	5G (Video)	Classic	Touch	1G	2G	3G	1G 2G
									
	20GB 40GB	20GB 30GB 40GB 60GB	30GB 60GB 80GB	80GB 160GB	8GB 16GB 32GB	1GB 2GB 4GB	2GB 4GB 8GB	4GB 8GB	4GB 6GB
TV Control Mode									
Music Play	✓	✓	✓	✓	✓	✓	✓	✓	✓
Music Shuffle Play	✓	✓	✓	✓	✓	✓	✓	✓	✓
Video Play			✓	✓				✓	
Pod Control Mode									
Music Play	✓ (1)	✓ (1)	✓ (1)	✓ (1)	✓ (1) (2)	✓ (1)	✓ (1)	✓ (1)	✓ (1)
Video Play			✓ (3)	✓ (3)	✓ (2) (4)			✓ (3)	
Podcasts	✓	✓	✓	✓	✓ (2)	✓	✓	✓	✓
Video Podcasts			✓ (3)	✓ (3)	✓ (2) (4)			✓ (3)	
Photo Slide Show		✓ (3)	✓ (3)	✓ (3)	(5)			✓ (3)	
Game									
Setting	✓ (6)	✓ (6)	✓ (6)	✓ (6)	✓ (2) (6)	✓ (6)	✓ (6)	✓ (6)	✓ (6)
Dock adapter type (7)									
	20GB – A	20GB – A 30GB – A	30GB – A	80GB – A	E	B	C	D	A

- 1 The registration of "On-The-Go" can be done by using the iPod.
- 2 Due to the nature of iPod Touch, lock/unlock, Main menu, and the selection of Music/Video has to be done using the iPod Touch.
- 3 For Video/Photo output, it is necessary to have the TV out on beforehand.
- 4 Due to the nature of iPod Touch, in the case of video output, the selection of TV output has to be done using the iPod Touch.
- 5 To control iPod Touch Photoviewer, it can be done only by using the the iPod Touch.
- 6 Some setups will require the selection by using the iPod. (Especially those that require wheel control).
- 7 If your iPod listed is not required to use a Dock Adapter, you do not need to use any Dock Adapters.

Enjoy movies/music from your iPod

Notes:

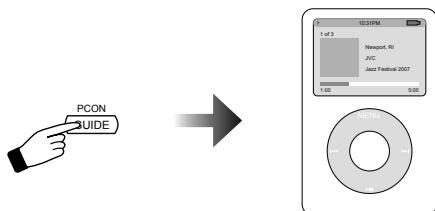
- If your iPod doesn't work correctly, gently pull out and try again.
- If the iPod does not play correctly, please update your iPod software to the latest version.
- For details about updating your iPod, check on the Apple web site, <http://www.apple.com>.
- Sound distortion may occur when playing back audio sources with high recording levels. When distortion occurs, it is recommended to turn off the equalizer of the iPod. For information on operating the iPod, see the iPod instruction manual.
- You can not operate the TV menu while in iPod mode.
- JVC is not responsible for any loss of or damage to iPod that might result from the use of this product.

iPod is a trademark of Apple Inc., registered in the U.S. and other countries.


Pod Control Mode

You can operate the iPod using the TV's remote control and the onscreen of the iPod. Press the **PCON** button to switch between Pod Control Mode and TV Control Mode.

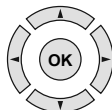
- 1) Press the **PCON** button on the remote control. JVC logo will disappear and the normal screen of your iPod will appear.




- 2) Operate with TV remote control.

 Back to TV

 Rewind

 * Operation varies from iPod type and/or mode.

 Play / Pause

 Forward

 Pause

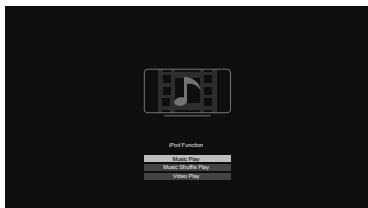
Notes:

- When operating with the TV's remote control, set the **MODE** to TV.
- TV will display a blank black screen when operating the iPod in Pod Control Mode.
- For Video/Photo output, it is necessary to have the TV out on beforehand.

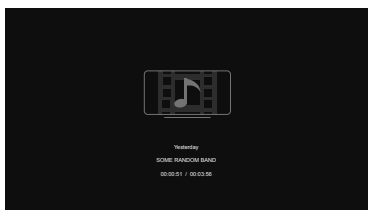
Enjoy movies/music from your iPod

TV Control Mode

You can operate the iPod by using the TV's remote control and onscreen menus.



Music Play (TV Control Mode)



Music starts in alphabetical order. Go back to the TV using the **iPod** button.

* Language Support:
English, French and Spanish



Choose sleep timer



Back to TV



Choose sound mode



Back to Initial Menu



You can view the last program you were watching while listening to your iPod (iTV Mode). Press iTV button when playing music.

• You can not change the program in iTV Mode.



Skip to the next/last song



Skip jumps 50 songs ahead in your library (depending upon the length of your library)



Rewind



Play



Forward



Pause

Music Shuffle Play (TV Control Mode)

Randomly select songs. Except for the ▲ ▼ buttons, it operates the same as the Music Play.

Enjoy movies/music from your iPod

Video Play (TV Control Mode)



The video will play from the beginning regardless of where you were when you were watching the same video from your iPod. (iPod 5G Podcasts will be skipped).



Choose sleep timer



Choose sound mode



Back to TV



Choose picture preference



Back to Initial Menu



Rewind



Skip to the next/last picture



Play



Select video content



Forward



Changes the aspect ratio



Pause

Recharge iPod

While your iPod is connected to the dock, you have the ability to recharge your iPod. The time it takes depends on how low your batteries are.

Error messages

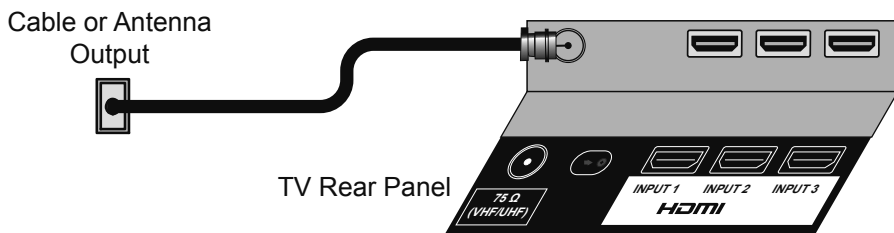
"iPod not found"	This appears when you press the iPod button without inserting an iPod.
"Communication failed Check Connection"	Insert your iPod again. This is a connection error.
"File not found"	This appears when your iPod has no files to play.

Connecting Your Devices

Notes:

- The following connection diagrams are examples on connecting some of the most common devices to your TV. Please refer to your device's instruction manual on other connection methods or for devices not shown here in this instruction book.
- When you are finished connecting your devices, turn on your TV and devices.

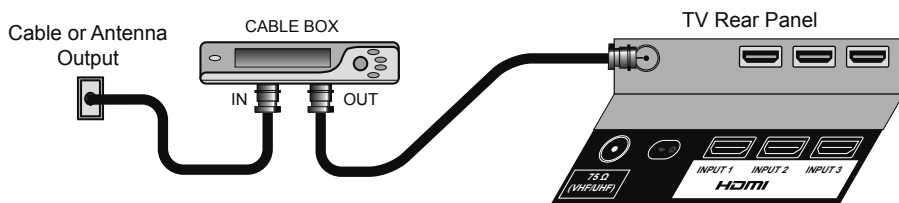
Connect an Antenna or Basic Cable



Notes:

- If you are able to receive ATSC (Digital terrestrial) signal, High Definition (HD) broadcasting can be watched.
- All digital broadcasting is not necessary High Definition. Check by pressing the **DISPLAY** button.
- Digital broadcasting is not available in all areas.

Connect a Cable Box

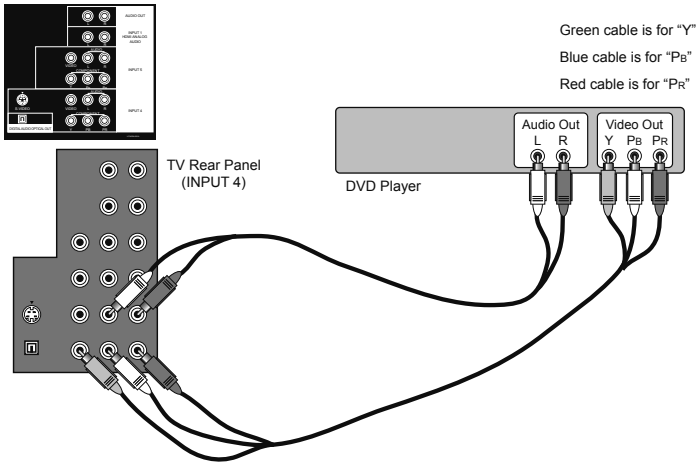


Note:

- To view channels on your cable box, make sure your TV's channel is set to 2, 3 or 4 (depending on the area you live in).

Connecting Your Devices

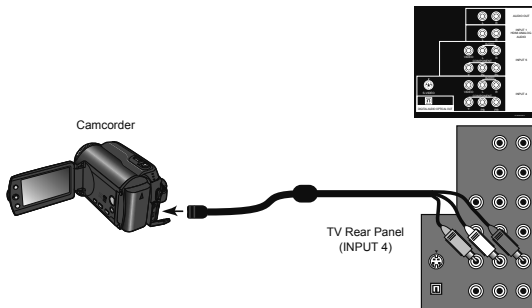
Connect a DVD Player



Notes:

- Green, blue and red are the most common colors for Component Cables. Some models may vary in color.
- To watch your DVD player, make sure your TV is displaying INPUT 4 or INPUT 5 by pressing the **V4** or **V5** button on your remote control.

Connect a Camcorder

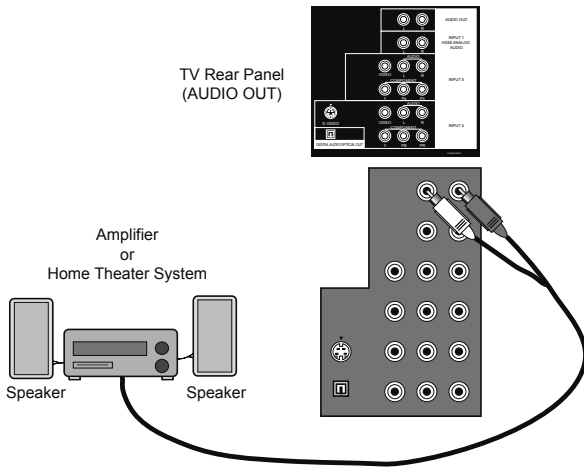


Note:

- To watch video from your camcorder, make sure your TV is displaying INPUT 4 or INPUT 5 by pressing the **V4** or **V5** button on your remote control.

Connecting Your Devices

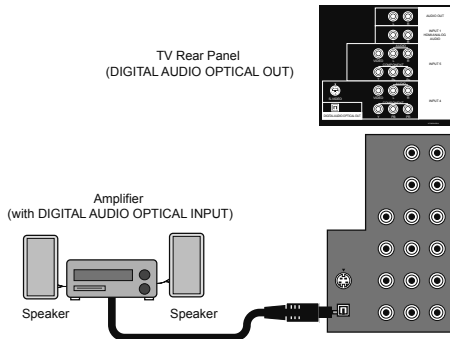
Connect an Amplifier or Home Theater System



Notes:

- Refer to your amplifier's or Home Theater System's manual for more information.
- If you have a device connected to INPUT 1, INPUT 2 or INPUT 3, you will not be able to hear any audio from the AUDIO OUT on the back of the TV otherwise.

Connect an Amplifier using the DIGITAL AUDIO OPTICAL OUT

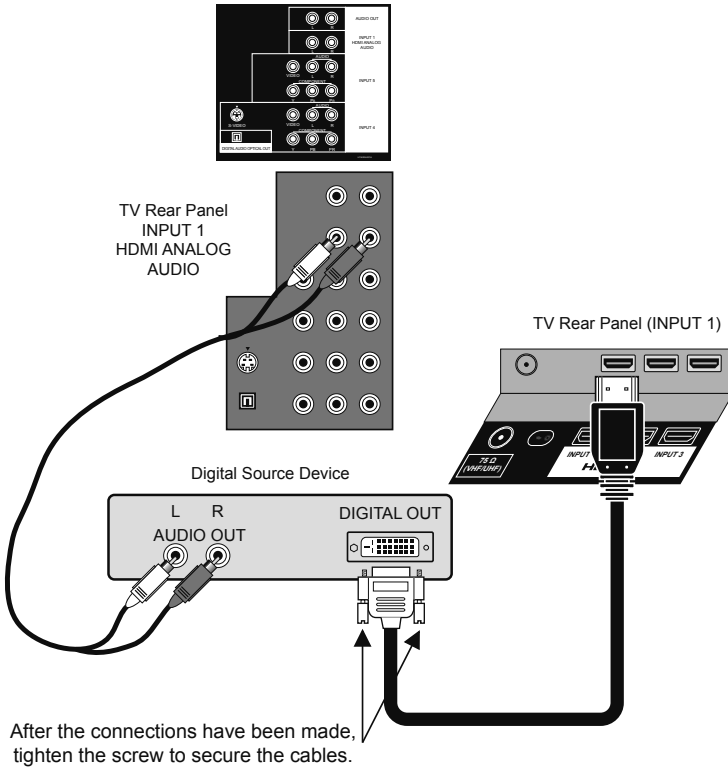


Notes:

- Refer to your amplifier's manual for more information.
- This terminal can only output digital audio (PCM or DOLBY DIGITAL).
- In order to use the optical output connection, select PCM or DOLBY DIGITAL. See page 41.
- You can not output sound from your DIGITAL AUDIO OPTICAL OUTPUT connection if the audio source is from your HDMI device.

Connecting Your Devices

Connect a Digital Source Device

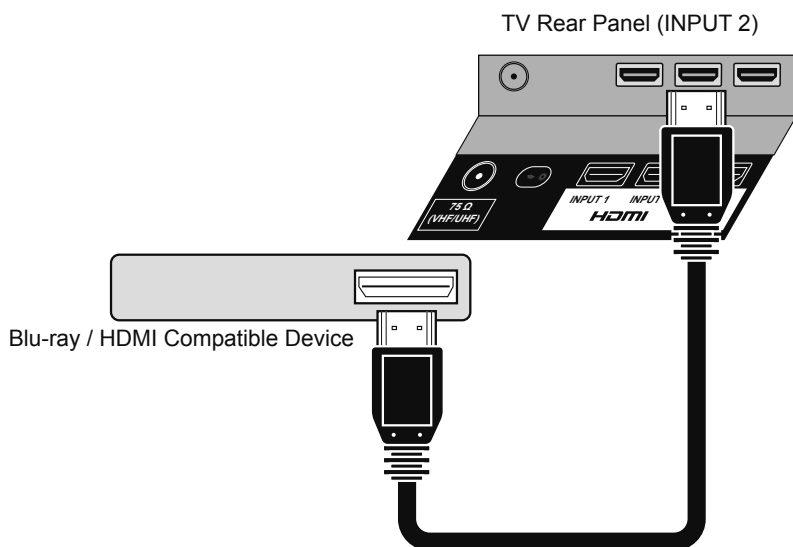


Notes:

- To watch your digital source device, make sure your TV is displaying INPUT 1 by pressing the **V1** button on your remote control.
- This TV can accept 480i, 480p, 720p, 1080i and 1080p signals via HDMI.
- The INPUT 1 HDMI ANALOG AUDIO input can only be used with INPUT 1.

Connecting Your Devices

Connect a Blu-ray or HDMI Device



Notes:

- To watch your Blu-ray or HDMI device, make sure your TV is displaying INPUT 1, INPUT 2 or INPUT 3 by pressing the **V1**, **V2** or **V3** button on your remote control.
- Some decoders may not respond depending on the equipment that is connected to the HDMI.
- This TV can accept 480i, 480p, 720p, 1080i and 1080p signals via HDMI.
- This JVC television can accept a variety of HD signals, including 720/60p, 1080/60i and 1080/60p. It does not accept a 1080/24p signal. Please note that in some cases, a Blu-ray may only offer the choice of 1080/60i or 1080/24p. In this case, it is necessary to choose the 1080/60i output. Please refer to your Blu-ray manual for complete details on choosing the correct output.
- Some HDMI Output Devices may fail to detect this TV as a 1080p device. If this occurs, manually select 1080p on the HDMI Output Device.

HDMI™
HIGH-DEFINITION MULTIMEDIA INTERFACE

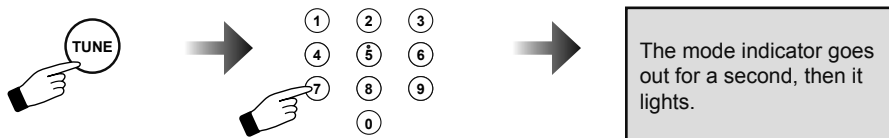
HDMI, the HDMI Logo and High-Definition Multimedia Interface are trademarks or registered trademarks of HDMI Licensing LLC.

Programming Your Remote

You can program your remote control to operate your external devices, using the instructions and codes on pages 52 - 58.

How to set the codes

- 1) Manually turn on the device.
- 2) Change the remote control mode according to the device by pressing the **MODE** button. Refer to the following list for which mode to use.
- 3) Find the remote control code for your device. See pages 54 - 58.
- 4) Set the remote code.



Press and hold

Enter the four digit number

- 5) Point the remote at the device and press power. If your device did not turn off or respond, try another code.

Notes:

- If your device doesn't respond to any of the codes listed or is not listed, see page 52.
- Some codes may have only limited functions. Try other codes that may have more functions.

Search Code Function

This function searches for codes one by one if none of the codes listed for your device has worked.

- 1) Manually turn on the device.
- 2) Change the remote control mode according to the device. Press **MODE** to select the correct mode.
- 3) Activate the search code function. Press and hold **POWER** and **RETURN+TV** until the mode indicator blinks.
- 4) Point the remote at the device and press **POWER**. If no response, try the next code by pressing **▶** and **POWER** until the device turns off.
- 5) Press **RETURN+TV** to register and set the code. Then the **MODE** indicator light goes out.

Notes:

- If your remote still doesn't work with the "Search Code Function", use the remote that came with your device. Your TV remote can not be guaranteed to work with all devices, modes or operations.

Programming Your Remote

Device	Applied for these devices
TV	JVC brand only
STB	Cable Set Top Boxes, Cable/PVR Combinations, Satellite Set Top Box DBS/PVR Combination
VCR	VCR, DBS/PVR Combination, PVR, DVD/PVR Combination
DVD	DVD Player, DVD Recorder, Home Theater in a Box, Receiver
AUDIO	Amplifier, Home Theater in a Box, Receiver

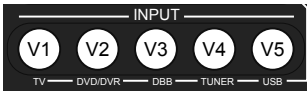
Remote Control Functions



Turns the selected device off



Changes the remote control mode



Audio Input Selection



Channel Up / Down



Displays Subtitles

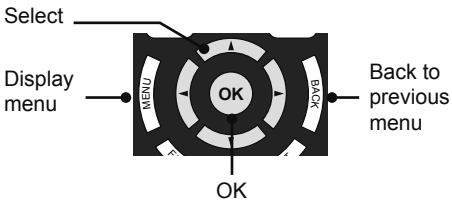


Volume Up / Down

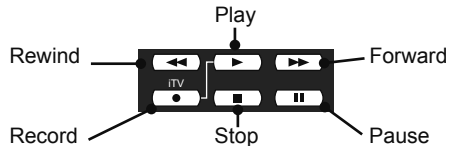


Open / Close

Operates menus



Playback / Record, etc.



Note:

- If your external devices has a TV/VCR function, refer to it's manual.

Programming Your Remote

Programming Codes

STB mode					
Cable Set Top Box		Satellite Set Top Box		Satellite Set Top Box	
ABC	0003, 0008	AlphaStar	0772	Samsung	1377, 1276, 1108, 1109, 1442, 1609
Americast	0899	Chaparral	0216		
Bell South	0899	Coolsat	1806	SKY	0856
Digeo	1187	Crossdigital	1109	Sony	0639, 1639, 1640
Director	0476	DirecTV	1377, 0392, 0566, 0639, 1639, 1142, 0247, 0749, 1749, 0724, 0819, 1856, 1076, 1108, 0099, 1109, 1414, 1442, 1609, 1392, 1640	Star Choice	0869
General Instrument	0476, 0810, 0276, 0003			Tivo	1142, 1442
GoldStar	0144			Toshiba	0749, 1749, 0790, 1285
Hamlin	0009, 0273			UltimateTV	1392, 1640
Jerrold	0476, 0810, 0276, 0003			Ultrasat	1806
Memorex	0000	Dish Network System	1505, 1005, 0775, 1170, 1775	Uniden	0724, 0722
Motorola	1376, 0476, 0810, 0276, 1187			US Digital	1535
Pace	1877, 0237, 0008	Dishpro	1505, 1005, 0775, 1775	USDTV	1535
Panasonic	0000, 0008, 0107			Voom	0869
Paragon	0000	EchoStar	1505, 1005, 0775, 1170, 1775	Zenith	0856, 1856
Philips	1305, 0317, 0025	Expressvu	0775, 1775	DBS/PVR Combination	
Pioneer	1877, 0877, 0144, 0533	GE	0566	DirecTV	1377, 0392, 0639, 1142, 1076, 0099, 1392, 1442, 1640
Pulsar	0000	General Instrument	0869		
Quasar	0000	GOI	0775, 1775		
Regal	0279, 0273	Hisense	1535	Dish Network System	1505, 0775
Runco	0000	Hitachi	0819	Dishpro	1505, 0775
Samsung	0000, 0144	HTS	0775, 1775	EchoStar	1505, 0775, 1170
Scientific Atlanta	1877, 0877, 0477, 0008	Hughes Network Systems	1142, 0749, 1749, 1442	Expressvu	0775
Sony	1006			Hughes Network Systems	1142, 1442
Starcom	0003	Humax	1790	JVC	1170
Supercable	0276	iLo	1535	Motorola	0869
Torx	0003	JVC	0775, 1170, 1775	Philips	1142, 0099, 1442
Toshiba	0000	LG	1414	Proscan	0392
Zenith	0000, 0525, 0899	Magnavox	0724, 0722	RCA	1392
		Memorex	0724	Samsung	1442
		Mitsubishi	0749	Sony	0639, 1640
		Motorola	0869	Star Choice	0869
		Next Level	0869		
		Panasonic	0247, 0701		
Americast	0899	Pansat	1807		
Digeo	1187	Paysat	0724		
General Instrument	0810	Philips	1142, 0749, 1749, 0724, 1076, 0722, 0099, 1442		
Jerrold	0810				
Motorola	1376, 0810, 1187	Proscan	0392, 0566		
Pace	1877, 0237	Proton	1535		
Pioneer	1877, 0877	RadioShack	0869		
Scientific Atlanta	1877, 0877	RCA	0566, 0855, 0143, 1392		
Sony	1006				
Supercable	0276				
Zenith	0899				

Programming Your Remote

VCR mode					
VCR		VCR		VCR	
ABS	1972	Fisher	0047, 0104, 0046	Marta	0037
Admiral	0048, 0209	Fuji	0035, 0033	Matsushita	0035, 0162, 0227,
Adventura	0000	Funai	0000, 0593, 1593		1162
Aiko	0278	Garrard	0000	Media Center PC	1972
Aiwa	0037, 0000, 0307, 0479	Gateway	1972	MEI	0035
Akai	0041, 0061, 0106	GE	0060, 0035, 0240, 0202, 0760, 0761, 0807, 1035, 1060	Memorex	0035, 0162, 0037, 0048, 0039, 0047, 0240, 0000, 0104, 0209, 0046, 0307, 0479, 1037, 1048, 1162, 1237, 1262
Alienware	1972	Go Video	0432, 0526		
America Action	0278	GoldStar	0037, 0209, 0038,		
American High	0035		0225, 1237		
Asha	0240	Gradiente	0000	MGA	0240, 0043, 0061
Audiovox	0037, 0278	Harley Davidson	0000	MGN Technology	0240
Beaumarck	0240	Harman/Kardon	0081, 0038	Microsoft	1972
Bell & Howell	0104	Harwood	0072	Mind	1972
Broksonic	0184, 0121, 0209, 0002, 0479, 1479	Headquarter	0046	Minolta	0042, 0105
Calix	0037	Hewlett Packard	1972	Mitsubishi	0081, 0037, 0043, 0041, 0061, 0173, 0807
Canon	0035	HI-Q	0047	Motorola	0035, 0048
Capehart	0020	Hitachi	0037, 0240, 0000, 0042, 0041, 0105, 1037	MTC	0240, 0000
Carver	0081	Howard Computers	1972	Multitech	0000, 0072
CCE	0072, 0278	HP	1972	NEC	0035, 0037, 0048, 0104, 0067, 0041, 0038, 0008
Citizen	0037, 0278, 1278	Hughes Network Systems	0042, 0739	Nikko	0037
Colt	0072	Humax	0739	Niveus Media	1972
Craig	0037, 0047, 0240, 0072, 0271	Hush	1972	Noblex	0240
Curtis Mathes	0060, 0035, 0162, 0041, 0760, 1035	IBUYPOWER	1972	Northgate	1972
Cyberbex	0240	Jensen	0041	Olympus	0035
CyberPower	1972	JVC	0045, 0067, 0041, 0008, 0366, 1707, 1945, 1774, 1775, 1776, 1777	Optimus	1062, 0162, 0037, 0048, 0104, 0432, 0593, 1048, 1162, 1262
Daewoo	0045, 0104, 0278, 0020, 0046, 0561, 1278	KEC	0037, 0278	Orion	0184, 0121, 0209, 0002, 0208, 0479, 1479
Daytron	0020	Kenwood	0067, 0041, 0038	Panasonic	1062, 0035, 0162, 0225, 0227, 0616, 1035, 1162, 1262
Dell	1972	KLH	0072		
Denon	0042	Kodak	0035, 0037		
DirecTV	0739	LG	0037, 0045, 0042, 0209, 0038, 1037		
Durabrand	0039, 0038	Linksys	1972		
Dynatech	0000	Lloyd's	0000, 0208		
Electrohome	0037	Logik	0240, 0072	Penney	0035, 0037, 0240, 0042, 0038, 1035, 1237
Electroponic	0037	LXI	0037		
Emerex	0032	Magnasonic	0593, 1278		
Emerson	0035, 0037, 0184, 0240, 0045, 0000, 0121, 0043, 0209, 0002, 0278, 1593, 1479, 1278, 0593, 0561, 0479, 0208, 0061	Magnavox	0035, 0039, 0081, 0000, 0149, 0563, 0593, 1593, 1781	Pentax	0042, 0105
		Magnin	0240	Philco	0035, 0000, 0038
		Marantz	0035, 0081		

Programming Your Remote

VCR mode					
VCR		VCR		PVR	
Philips	0035, 0081, 0000,	Symphonic	0000, 0593, 1593	Howard Computers	1972
	0563, 0593, 0618,	Systemax	1972	HP	1972
	0739, 1081, 1181,	Tagar Systems	1972	Hughes Network Systems	0739
	1266	Tatung	0081, 0045, 0000,	Humax	0739
Pilot	0037		0067, 0041, 0008,	Hush	1972
Pioneer	0081, 0042, 0067		0366	iBUYPOWER	1972
Polk Audio	0081	Teac	0000, 0041	JVC	1945
Portland	0020	Technics	0035, 0162	Linksys	1972
Presidian	1593	Teknika	0035, 0037, 0000	Media Center PC	1972
Profitronic	0240	Thomas	0000	Microsoft	1972
Proscan	0060, 0202, 0760,	Tivo	0618, 0636, 0739,	Mind	1972
	0761, 1060		1996	Niveus Media	1972
Protec	0072	TMK	0240, 0208	Northgate	1972
Pulsar	0039	Toshiba	0081, 0045, 0042,	Panasonic	0616, 1777
Quarter	0046		0067, 0043, 0041,	Philips	0618, 0739
	0046		0008, 0057, 0366,	RCA	0880
Quasar	0035, 0162, 1035,		0845, 1008, 1145,	ReplayTV	0614, 0616
	1162		1972, 1996	Samsung	0739
RadioShack	0000, 1037	Totevision	0037, 0240	Sonic Blue	0614, 0616
Radix	0037	Touch	1972	Sony	0636, 1972
Randex	0037	Unitech	0240	Stack 9	1972
RCA	0060, 0035, 0240,	Vector	0045	Systemax	1972
	0000, 0042, 0149,	Vector Research	0038	Tagar Systems	1972
	0105, 0106, 0202,	Video Concepts	0045, 0061	Tivo	0618, 0636, 0739
	0760, 0761, 0807,	Videomagic	0037	Toshiba	1008, 1972, 1996
	0880, 1035, 1060	Videosonic	0240	Touch	1972
Realistic	0035, 0037, 0048,	Viewsonic	1972	Viewsonic	1972
	0047, 0000, 0104,	Villain	0000	Voodoo	1972
	0046	Voodoo	1972	ZT Group	1972
ReplayTV	0614, 0616	Wards	0060, 0035, 0048,		
Ricavision	1972		0047, 0081, 0240,		
Runco	0039		0000, 0042, 0072,		
Samsung	0240, 0045, 0432,		0149, 0760	DVD/PVR Combination	Emerson 0000
	0739, 0760, 1014	White Westinghouse	0209, 0072		
Sanky	0048, 0039	XR-1000	0035, 0000, 0072		
Sansui	0000, 0067, 0209,	Yamaha	0041, 0038		
	0041, 0271, 0479,	Zenith	0039, 0033, 0000,		
Sanyo	1479		0209, 0034, 0479,		
	0047, 0240, 0104,	ZT Group	1139, 1479		
Scott	0046		1972		
	0184, 0045, 0121,				
	0043				
Sears	0035, 0037, 0047,				
	0000, 0042, 0104,	EchoStar	1945		
	0046, 0057, 0105,	Hughes Network Systems	0739		
	1237	JVC	1945		
Sharp	0048, 0209, 0807,	Philips	0739		
	0848, 1048	Samsung	0739		
Shintom	0104, 0072				
Shogun	0240				
Singer	0045, 0072				
Sonic Blue	0614, 0616				
Sony	0035, 0032, 0033,	ABS	1972		
	0000, 0034, 0636,	Alienware	1972		
	0639, 0640, 1032,	CyberPower	1972		
	1232, 1972	Dell	1972		
		DirecTV	0739		
Stack 9	1972	Dish Network System	1945		
STS	0042	EchoStar	1945		
Sylvania	0035, 0081, 0000,	Gateway	1972		
	0043, 0593, 1593,	Hewlett Packard	1972		
	1781				

Programming Your Remote

DVD mode					
DVD		DVD		DVD Recorder	
Accurian	1416	Magnavox	0503, 0539, 0646,	Accurian	1416
Advent	1016		0675, 0821, 1268	Apex Digital	1056
Aiwa	0641	Marantz	0539	Aspire Digital	1168
Akai	0695, 0770, 0899	Memorex	0695, 0831, 1270	CyberHome	1129
Alco	0790	Microsoft	0522, 1708	Denon	0490
Allegro	0869	Mintek	0839, 0717	Funai	0675, 1334
Apex Digital	0672, 0717, 0755,	Mitsubishi	1521, 0521	Gateway	1158
	0830, 1056, 1061		NAD	0741	Go Video
Arrgo	1023	NEC	0785		1730
Aspire Digital	1168	Nesa	0717	iLo	1348
Audiovox	0790	NexxTech	1402	JVC	1164
Blaupunkt	0717	Norcent	1003, 1107	LG	0741
Blue Parade	0571	Onkyo	0503, 0627	LiteOn	1158, 1416, 1440
Broksonic	0695	Orltron	0651	Magnavox	0646, 0675
Cinea	0831	Panasonic	0490, 0703, 1362,	Panasonic	0490
Cine Vision	0876, 0833, 0869		1462, 1490, 1762	Philips	0646, 1158
Citizen	1277	Philips	0503, 0539, 0646,	Pioneer	0631
Coby	0778, 1107		0675, 0854, 1158,	RCA	0522
Craig	0831		1260, 1267, 1354	Samsung	0490, 1470
Curtis Mathes	1087		Pioneer	0525, 0571, 0631	Sensory Science
CyberHome	0816, 0874, 1023,	Polaroid	1061	Sharp	0630, 0675
	1024, 1117, 1129	Polk Audio	0539	Sony	1033, 1431
Daewoo	0784, 0705, 0770,	Portland	0770	Sylvania	0675
	0833, 0869, 1169,	Presidian	0675	Zenith	0741
	1172	Prima	1016		
	Denon	0490, 0634	Proscan	0522	
Disney	0675, 1270	Pro Vision	0778		
Durabrand	1127	Qwestar	0651		
DVD2000	0521	RCA	0522, 0571, 0717,	Aiwa	0641
Emerson	0591, 0675, 0821,		0790, 0822, 1022,	1132	Audiovox
	1268	Rio	0869	JVC	1770, 1771, 1772,
Enterprise	0591	Rotel	0623	KLH	0790
ESA	0821, 1268	Sampo	0752	Koss	0651
Fisher	0670	Samsung	0490, 0573, 0744,	Orltron	0651
Funai	0675, 1268, 1334		0820, 0899, 1044,	Polk Audio	0539
Gateway	1158	1075, 1470	RCA	0790	
GE	0522, 0815, 0717	Sansui	0695	Rio	0869
Go Video	0744, 0715, 0741,	Sanyo	0670, 0695, 0873	Sonic Blue	0869
	0783, 0833, 0869,	Sensory Science	1158	Teac	0790
	1044, 1075, 1099,	Sharp	0630, 0675, 0752,	Venturer	0790
	1158, 1304, 1730		1256		
GoldStar	0741	Sharper Image	1117		
Greenhill	0717	Sherwood	0770		
Harman/Kardon	0582, 0702	Shinsonic	0533, 0839		
Hitachi	0573, 0664, 1247	Sonic Blue	0869, 1099		
Hiteker	0672	Sony	0533, 1533, 0864,		
Humax	1500, 1588		1033, 1431, 1536		
iLo	1348	Superscan	0821		
Initial	0717	Sylvania	0675, 0821, 1268		
Insignia	1268	Symphonic	0675, 0821		
Integra	0627	Teac	0717, 0790		
JBL	0702	Technics	0490, 0703		
Jensen	1016	Theta Digital	0571		
JVC	0558, 0623, 0867,	Tivo	1503		
	1164, 1602, 1770,	Toshiba	0503, 0695, 1045,		
	1771, 1772, 1773		1154, 1503, 1515,		
Kawasaki	0790		1588		
Kenwood	0490, 0534	Urban Concepts	0503		
KLH	0717, 0790, 1149	US Logic	0839		
Koss	0651	Venturer	0790		
Lasonic	0798	Xbox	0522, 1708		
Lennox	1127	Yamaha	0490, 0539, 0545		
LG	0591, 0741, 0869	Zenith	0503, 0591, 0741,		
LiteOn	1058, 1158, 1416,		0869		
	1440				

Troubleshooting

Refer to the table below to check the condition. If you think that there is a problem, contact the JVC Service Center where you purchased the television.

PROBLEMS	CHECK
There is no power	<ul style="list-style-type: none"> • See if the power cord became unplugged. • Check for a blown fuse or circuit breaker or a power outage.
There is no picture or sound	<ul style="list-style-type: none"> • The antenna could be disconnected. • The tuner could be set improperly. See page 40. • The TV station may be having difficulties. Check to see if other stations are working. • Use the HDMI cable with HDMI logo HDMI. See page 51. • If you have a device connected to INPUT-1, INPUT-2 or INPUT-3, you will not be able to hear any audio from the AUDIO OUT on the back of the TV. • You cannot output audio using the DIGITAL AUDIO OPTICAL OUTPUT when you have digital sound from an HDMI device connected to the INPUT-1, INPUT-2 or INPUT-3 connection on the back of the TV. • This TV can accept 480i (Composite / S / HDMI / Component), 480p, 720p, 1080i and 1080p signals. Please check your settings.
Remote control is not operating properly or at all	<ul style="list-style-type: none"> • Check to see that the batteries are still working and properly installed. • Make sure the remote has a clear sight path to the TV. • You may be too far from the TV. You must be within 23 feet (7 meters).
The power turns off by itself	<ul style="list-style-type: none"> • Make sure the set did not become unplugged. • Perhaps the Auto Shut Off is set. See page 41. • Check to see if the Sleep Timer was set. See page 39.
It does not operate correctly	<ul style="list-style-type: none"> • This television is operated by a microprocessor. It is possible that external noise or interference is causing the problem. If the television does not function correctly, remove the electrical plug from the wall outlet and wait a while before inserting it into the wall outlet again and operating the television.
The color quality is poor	<ul style="list-style-type: none"> • Tint and Color may be improperly adjusted. See page 24. • The Video Status mode may be turned to the wrong setting. See page 23.
There are lines across the picture	<ul style="list-style-type: none"> • There could be interference from another electrical appliance, such as a computer, another TV or VCR. Move any such appliances further away from the TV.
The picture is spotted	<ul style="list-style-type: none"> • There could be interference from a high-wattage appliance, like a hairdryer or vacuum, operating nearby. Move the antenna away from the appliance or change to a coaxial cable connection which is less prone to interference.
There are double pictures (ghosts)	<ul style="list-style-type: none"> • A building or passing airplane can reflect the original signal and produce a second, slightly delayed one. Adjust your antenna position.
Picture is snowy (image noise)	<ul style="list-style-type: none"> • Your antenna may be damaged, disconnected or turned. Check the antenna connection. If the antenna is damaged, replace it.

Troubleshooting

PROBLEMS	CHECK
Screen is 80% black	• The Closed Caption Text mode is on. Turn it off in the Closed Caption Menu, page 29.
Stereo or bilingual programs can't be heard	• Make sure the MTS settings are correct. See page 37.
Static electricity	• It is normal to feel static electricity if you brush or touch the screen.
You hear occasional crackling sounds	• It is normal for the TV to make crackling sounds when first turned on or off. Unless the sound or picture become abnormal, this is fine.
The picture is slightly cut off when you use 1080p format only	• Change the picture format setting on your external device to 1080i or other resolution.
The screen disappears except for the menu screen	• This occurs when you select a digital menu when your input source is from the HDMI connection. Press the menu button.
My HDMI device doesn't work or doesn't work properly	• This JVC television can accept a variety of HD signals, including 720/60p, 1080/60i and 1080/60p. It does not accept a 1080/24p signal. Please note that in some cases, a Blu-ray may only offer the choice of 1080/60i or 1080/24p. In this case, it is necessary to choose the 1080/60i output. Please refer to your Blu-ray manual for complete details on choosing the correct output.
No signal or signal can not be displayed	<ul style="list-style-type: none"> • This OSD appears when the digital channel that you have selected is too weak to receive or no signal is being detected for that channel. • It appears when that channel is not receiving a signal and you have the Noise Muting function OFF and you have a single screen. It moves automatically every two seconds to prevent the screen from burn-in. • Even if "No signal or signal can not be displayed" appears on the screen, your timer functions and auto shut off functions that you set, are still active.

The following are not malfunctions.

- The television may make a creaking sound if the temperature of the room or the temperature of the inside of the television changes. If there is no problem with the screen or sound, then there is no need to worry.
- The picture may be temporarily disturbed and noise may be seen on the screen if the power is turned on immediately after it has been turned off. This is not a malfunction.

Specifications

Model	LT-42P789	LT-47P789	LT-52P789
Type	LCD Flat Television		
Reception Format	NTSC, BTSC System (Multi-Channel Sound) ATSC Terrestrial, Digital Cable		
Reception Range	VHF 2 to 13, UHF 14 to 69 at ATSC, CATV 135 Sub, Mid, Super, Hyper and Ultra bands at Digital Cable		
	VHF 2 to 13, UHF 14 to 69 CATV 135 Sub, Mid, Super, Hyper and Ultra bands (191 channel frequency synthesizer system) at Analog • Reception of channel A-5 ("95" of the TV set's on-screen cable channel numbers) is not recommended for your TV set.		
Power Source	AC 120V, 60 Hz		
Power Consumption	247W	274W	276W
Screen Size	42 inch / 106.73 cm measured diagonally, 16:9 ratio	46.9 inch / 119.28 cm measured diagonally, 16:9 ratio	52 inch / 132.17 cm measured diagonally, 16:9 ratio
Audio Output	10W + 10W		
Speakers	4 x 16cm Oblique x 2		
iPod Output Power	5 V, 500 mA		
Antenna Terminal (VHF/UHF, ATSC/DIGITAL CABLE IN)	75 ohms (VHF/UHF)(F-type connector)		
Input 4, 5 Terminal	480i S (Input 4) Y: 1 Vp-p positive, 75 ohms (negative sync provided) C: 0.286 Vp-p (burst signal), 75 ohms Video: 1 Vp-p, 75 ohms Audio: 500 mVrms (-4dBs) high impedance		
Input 4, 5 Terminal (Component Terminal)	1080i / 720p / 480p / 480i Y: 1 Vp-p positive, 75 ohms (negative sync provided) Pb/Pz: 0.7 Vp-p 75 ohms		
Input 1, 2, 3 Terminal (HDMI Input Terminal)	Video: 1080p / 1080i / 720p / 480p / 480i Audio: 2ch PCM, 32 / 44.1 / 48 KHz 16 / 20 / 24 bit		
Audio Output Jacks (FIX)	FIX : 500mVrms (-4dBs), Low Impedance		
Optical Output Digital Audio	Digital Out (optical) x 1		
Dimensions (inch/mm) W X H X D	40 x 29 x 11 3/4 (with stand) 1014 x 733.7 x 296 (with stand)	44 3/8 x 31 1/2 x 11 3/4 (with stand) 1127 x 799.7 x 296 (with stand)	49 1/2 x 34 1/2 x 13 5/8 (with stand) 1258 x 875.7 x 345.7 (with stand)
	40 x 26 3/4 x 4 3/4 (without stand) 1014 x 677.2 x 117.8 (without stand)	44 3/8 x 29 3/8 x 4 3/4 (without stand) 1127 x 743.2 x 117.8 (without stand)	49 1/2 x 32 1/2 x 4 13/16 (without stand) 1258 x 825 x 122.9 (without stand)
Weight (lbs / kg)	57.2 / 26 (with stand)	63.8 / 29 (with stand)	75.0 / 34.1 (with stand)
	52.8 / 24 (without stand)	59.4 / 27 (without stand)	65.6 / 29.8 (without stand)

Specifications subject to change without notice.

- The open source software is embedded in this product. For more information, please go to:
http://software.jvc.com/opensource/Inx/DP/08_AtscQam_T/download.html



LIMITED WARRANTY

COLOR TV 1-1

For Canadian model televisions, see separate sheets for Canadian Warranty information.

JVC COMPANY OF AMERICA (JVC) warrants this product and all parts thereof, except as set forth below ONLY TO THE ORIGINAL RETAIL PURCHASER to be FREE FROM DEFECTIVE MATERIALS AND WORKMANSHIP from the date of original purchase for the period shown below. ("The Warranty Period")
FOR DIRECT-VIEW COLOR TELEVISION, PICTURE TUBE is covered for Two(2)years.

Parts	1 YEAR	Labor	1 YEAR
-------	---------------	-------	---------------

THIS LIMITED WARRANTY IS VALID ONLY IN THE FIFTY (50) UNITED STATES, THE DISTRICT OF COLUMBIA AND IN THE COMMONWEALTH OF PUERTO RICO.

WHAT WE WILL DO:

If this product is found to be defective within the warranty period, JVC will repair or replace defective parts with new or rebuilt equivalents at no charge to the original owner. Such repair and replacement services shall be rendered by JVC during normal business hours at JVC authorized service centers. Parts used for replacement are warranted only for the remainder of the Warranty Period. All products may be brought to a JVC authorized service center on a carry-in basis. Color televisions with a screen size of 27" or greater qualify for in-home service. In such cases, a technician will come to your home and either repair the TV there or remove and return it if it cannot be repaired in your home.

WHAT YOU MUST DO FOR WARRANTY SERVICE:

Please do not return your product to the retailer
Instead, return your product to the JVC authorized service center nearest you. If shipping the product to the service center, please be sure to package it carefully, preferably in the original packaging, and include a brief description of the problem(s). Please call 1-800-252-5722 to locate the nearest JVC authorized service center. Service locations can also be obtained from our website <http://www.jvc.com>. If your product qualifies for in-home service, the service representative will require clear access to the product.

If you have any questions concerning your JVC Product, please contact our Customer Care Center at 800-252-5722

WHAT IS NOT COVERED:

This limited warranty provided by JVC does not cover:

1. Products which have been subject to abuse, accident, alteration, modification, tampering, negligence, misuse, faulty installation, lack of reasonable care, or if repaired or serviced by anyone other than a service facility authorized by JVC to render such service, or if affixed to any attachment not provided with the products, or if the model or serial number has been altered, tampered with, defaced or removed;
2. Initial installation, installation and removal from cabinets or mounting systems.
3. Operational adjustments covered in the Owner's Manual, normal maintenance, video and audio head cleaning;
4. Damage that occurs in shipment, due to act of God, and cosmetic damage;
5. Signal reception problems and failures due to line power surge;
6. Video Pick-up Tubes/CCD Image Sensors are covered for 90 days from the date of purchase;
7. Accessories;
8. Batteries (except that Rechargeable Batteries are covered for 90 days from the date of purchase);
9. Products used for commercial purposes, including, but not limited to rental.

There are no express warranties except as listed above.

THE DURATION OF ANY IMPLIED WARRANTIES, INCLUDING THE IMPLIED WARRANTY OF MERCHANTABILITY, IS LIMITED TO THE DURATION OF THE EXPRESS WARRANTY HEREIN.

JVC SHALL NOT BE LIABLE FOR ANY LOSS OF USE OF THE PRODUCT, INCONVIENCE, OR ANY OTHER DAMAGES, WHETHER DIRECT, INCIDENTAL OR CONSEQUENTIAL (INCLUDING, WITHOUT LIMITATION, DAMAGE TO TAPES, RECORDS OR DISCS) RESULTING FROM THE USE OF THIS PRODUCT, OR ARISING OUT OF ANY BREACH OF THIS WARRANTY. ALL EXPRESS AND IMPLIED WARRANTIES, INCLUDING THE WARRANTIES OF MERCHANTABILITY AND FITNESS FOR PARTICULAR PURPOSE, ARE LIMITED TO THE WARRANTY PERIOD SET FORTH ABOVE.

Some states do not allow the exclusion of incidental or consequential damages or limitations on how long an implied warranty lasts, so these limitations or exclusions may not apply to you. This warranty gives you specific legal rights and you may also have other rights which vary from state to state.

JVC COMPANY OF AMERICA
DIVISION OF JVC AMERICAS CORP. <http://www.jvc.com>

1700 Valley Road
Wayne, NJ 07470

REFURBISHED PRODUCTS CARRY A SEPARATE WARRANTY, THIS WARRANTY DOES NOT APPLY. FOR DETAIL OF REFURBISHED PRODUCT WARRANTY, PLEASE REFER TO THE REFURBISHED PRODUCT WARRANTY INFORMATION PACKAGED WITH EACH REFURBISHED PRODUCT.

For customer use:

Enter below the Model No. and Serial No. which is located either on the rear, bottom or side of the cabinet. Retain this information for future reference.

Model No. :	Serial No. :
Purchase date :	Name of dealer :

TO OUR VALUED CUSTOMER ———

THANK YOU FOR PURCHASING THIS JVC PRODUCT.
WE WANT TO HELP YOU ACHIEVE A PERFECT EXPERIENCE.

**NEED HELP ON HOW TO HOOK UP?
NEED ASSISTANCE ON HOW TO OPERATE?
NEED TO LOCATE A JVC SERVICE CENTER?
LIKE TO PURCHASE ACCESSORIES?**

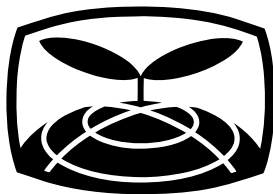
JVC[®] IS HERE TO HELP!
TOLL FREE: 1(800)252-5722
<http://www.jvc.com>

Remember to retain your Bill of Sale for Warranty Service.

————— **Do not attempt to service the product yourself** —————

Caution

To prevent electrical shock, do not open the cabinet.
There are no user serviceable parts inside.
Please refer to qualified service personnel for repairs.



JVC Loves the Earth

Digital Television Transition Notice:

This device contains a digital television tuner, so it should receive digital over the air TV programming, with a suitable antenna, after the end of full-power analog TV broadcasting in the United States on February 17, 2009.

Some older television receivers, if they rely on a TV antenna, will need a TV Converter to receive over the air digital programming, but should continue to work as before for other purposes (e.g., for watching low-power TV stations still broadcasting in analog, watching pre-recorded movies, or playing video games).

For more information, see <http://www.DTV.gov> or call 1-888-CALL-FCC. For converter box information, see <http://www.dtv2009.gov> or call the NTIA at 1-888-DTV-2009.

JVC COMPANY OF AMERICA
Division of JVC Americas Corp.
1700 Valley Road
Wayne, New Jersey, 07470

JVC[®]

JVC CANADA, INC.
21 Finchdene Square
Scarborough, Ontario
Canada, M1X 1A7

Free Manuals Download Website

<http://myh66.com>

<http://usermanuals.us>

<http://www.somanuals.com>

<http://www.4manuals.cc>

<http://www.manual-lib.com>

<http://www.404manual.com>

<http://www.luxmanual.com>

<http://aubethermostatmanual.com>

Golf course search by state

<http://golfingnear.com>

Email search by domain

<http://emailbydomain.com>

Auto manuals search

<http://auto.somanuals.com>

TV manuals search

<http://tv.somanuals.com>