



JVC

LT-17S2 LT-23S2

WIDE LCD PANEL TV

INSTRUCTIONS



5030057088

Thank you for buying this JVC WIDE LCD PANEL TV
To make sure you understand how to use your new TV, please read this manual thoroughly before you begin.
("LCD" stands for Liquid Crystal Display.)

WARNING: TO PREVENT FIRE OR SHOCK HAZARD, DO NOT EXPOSE THIS APPLIANCE TO RAIN OR MOISTURE.

WARNING

Always use the provided AC adapter and power cord.

WARNING

- Fingers may be trapped under the TV causing injuries. Hold the TV at the bottom in the middle, and do not allow it to tilt up or down.

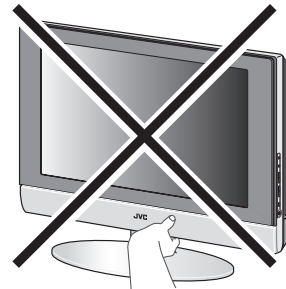

- The TV may fall causing injuries. Hold the bottom of the stand with your hand and tilt the TV up and down.
- Do not allow children to hang from the TV, place their elbows on the TV or lean against the TV. Doing so may cause the TV to fall over and lead to injuries.

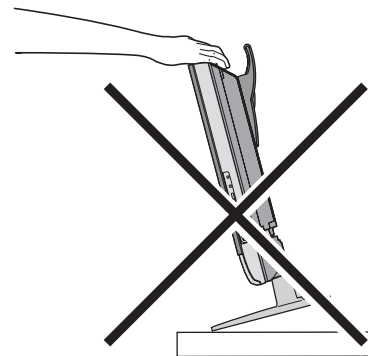

CAUTION:

- To avoid electric shock or damage to the unit, first firmly insert the small end of the power cord into the AC Adapter unit it is no longer wobbly, and then plug the larger end of power cord into an AC outlet.

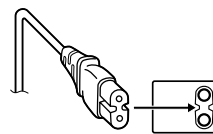

CAUTION:

- Operate only from the power source specified(AC 100 – 240 V, 50/60 Hz) on the AC adapter.
- Avoid damaging the AC plug, AC adapter and power cord.
- When you are not using this unit for a long period of time, it is recommended that you disconnect the power cord from the main outlet.

CAUTION ON HEATING OF AC ADAPTER:

- In using, the AC adapter get heat on the surface of case. It is normal, not defective.
- Don't be covered with any material on case of AC adapter while it is in operation.

NOTES:

- The rating plate (serial number plate) and safety caution are on the back of the main unit.
- The rating information and safety caution of the AC Adapter are on its upper and lower sides.

Point defects

LCDs use collections of fine pixels to display images. While there is no problem with more than 99.99% of these pixels, please understand that a very small number of pixels may not light or may light all the time.

Distance recommendations

Avoid improper installation and never position the unit where good ventilation is impossible.

When installing this TV, distance recommendations must be maintained between the set and the wall, as well as inside a tightly enclosed area or piece of furniture.

Keep to the minimum distance guidelines shown for safe operation.

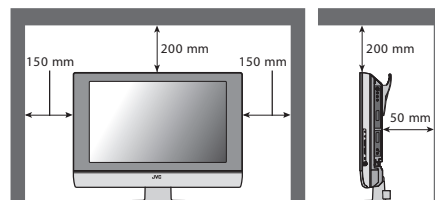

Failure to take the following precautions may cause damage to the television or remote control.

DO NOT block the TV's ventilation openings or holes.

(If the ventilation openings or holes are blocked by a newspaper or cloth, etc., the heat may not be able to get out.)

DO NOT place anything on top of the TV.

(such as cosmetics or medicines, flower vases, potted plants, cups, etc.)

DO NOT allow objects or liquid into the cabinet openings.

(If water or liquid is allowed to enter this equipment, fire or electric shock may be caused.)

DO NOT place any naked flame sources, such as lighted candles, on the TV.

DO NOT subject the TV to direct sunlight.

The surface of the TV screen is easily damaged. Be very careful with it when handling the TV.

Should the TV screen become soiled, wipe it with a soft dry cloth. Never rub it forcefully.

Never use any cleaner or detergent on it.

If there is a fault, unplug the unit and call a service technician. Do not attempt to repair it yourself or remove the rear cover and the AC adapter.

Cleaning the screen

The screen is coated with a special thin film to reduce reflection. If this film is damaged, uneven colors, discoloration, scratches, and other problems that can not be repaired may occur. Pay attention to the following when handling the screen.

- Do not use glue or adhesive tape on the screen.
- Do not write on the screen.
- Do not allow the screen to come in contact with any hard objects.
- Do not allow condensation to form on the screen.
- Do not use alcohol, thinner, benzene or other solvents on the screen.
- Do not rub the screen hard.

CONTENTS

Setting up your TV	4	SOUND	19
Installation.....	4	Sound Adjustment.....	19
Using the stand	4	HYPER SOUND	19
Putting the batteries into the Remote control.....	5	FEATURES	20
Remove the terminal cover.....	5	BLUE BACK.....	20
Connecting the aerial and video cassette recorder (VCR).....	6	CHILD LOCK.....	20
Connecting the power cord to the AC outlet	6	INSTALL	21
Initial settings	7	MANUAL.....	21
TV buttons and functions	9	AUTO PROGRAM.....	21
Turn the TV on from standby mode	9	To edit the PR LIST menu.....	22
Choose a TV channel	9	PC MENU	25
Watch images from external devices	9	PC PICTURE POSITION.....	25
Adjust the volume	9	PC PICTURE.....	25
Using the Menu.....	9	SOUND.....	25
Remote control buttons and functions	10	PC support mode list.....	26
Turn the TV on or off from standby mode	10	Additional preparation	27
Choose a TV channel	10	Connecting external equipment	27
Adjust the volume	11	Troubleshooting	29
Watch images from external equipment	11	Specifications	31
Displaying the source information.....	11		
ZOOM function.....	12		
Sleep timer funtion.....	13		
Picture mode.....	13		
Using the PCPIP function	13		
Operating a JVC brand VCR or DVD player	14		
Teletext function	15		
Basic operation	15		
Hold.....	15		
Sub-page	16		
Reveal.....	16		
Size	16		
Index	16		
Cancel.....	16		
Using the TV's menu	17		
Basic operation	17		
Picture setting	18		
PICTURE MODE	18		
Picture Adjustment.....	18		
WHITE BALANCE.....	18		
RESET.....	18		

Setting up your TV

Installation

Cautions for installation

- Install the TV in a corner on a wall or on the floor so as to keep cords out of the way.
- The TV will generate a slight amount of heat during operation. Ensure that sufficient space is available around the TV to allow satisfactory cooling. See “Distance recommendations” on page 2.

Using the stand

This TV comes with a Table Top Stand already attached.

This stand can be used to adjust the direction of the TV screen 5° up, 10° down, and 20° to the left or right.

Tilt the TV up and down:

While holding the bottom of the stand with one hand, use your other hand to hold the middle of the top of the TV and slowly tilt the TV up and down.

- As a safety measure, the stand is constructed so that it requires a certain amount of force to tilt the TV.

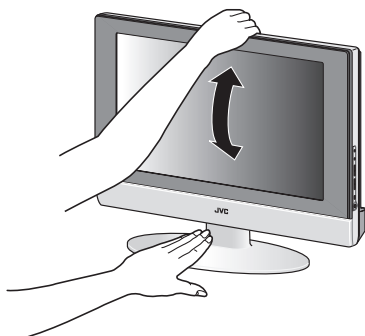

Cable holder

A cable holder which is used to keep the connection cables tidy is attached to the back of the stand.

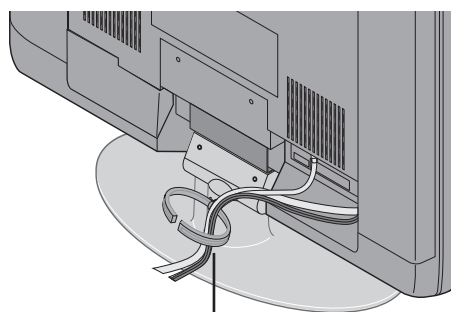

cable holder

Rotate the TV to the left and right:

While holding the bottom of the stand with one hand, use your other hand to hold the edge of the panel and slowly adjust the direction of the TV screen.

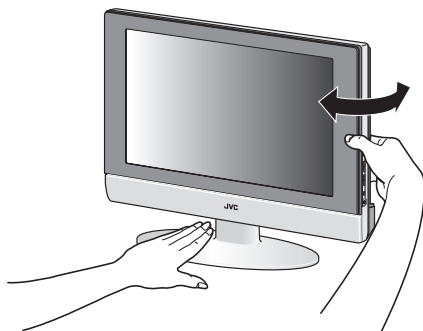

Putting the batteries into the Remote control

Use two AA/R6 dry cell batteries.

Insert the batteries from the - end, making sure the + and - polarities are correct.

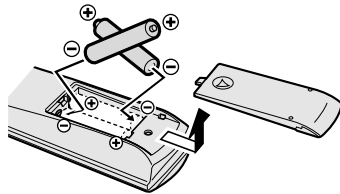

- Follow the warnings printed on the batteries.
- Battery life is about six months to one year, depending on your frequency of use.
- The batteries we supply are only for setting up and testing your TV, please replace them as soon as you need to.
- If the remote control does not work properly, replace the batteries.

Remove the terminal cover

There are connection terminals behind the covers of the rear of the TV. Remove the cover before connecting a DVD or VCR.

The covers can be removed by removing the hook at the top and then pulling out while lifting slightly. To replace the covers, first connect the hook at the bottom of the cover to the TV and then insert the hook at the top.

-
- Leave the covers off if they do not fit properly. Do not force to replace the covers. Doing so may cause damages of the connection cables and the covers.
 - Leave these covers off when mounting the TV on a wall.
-

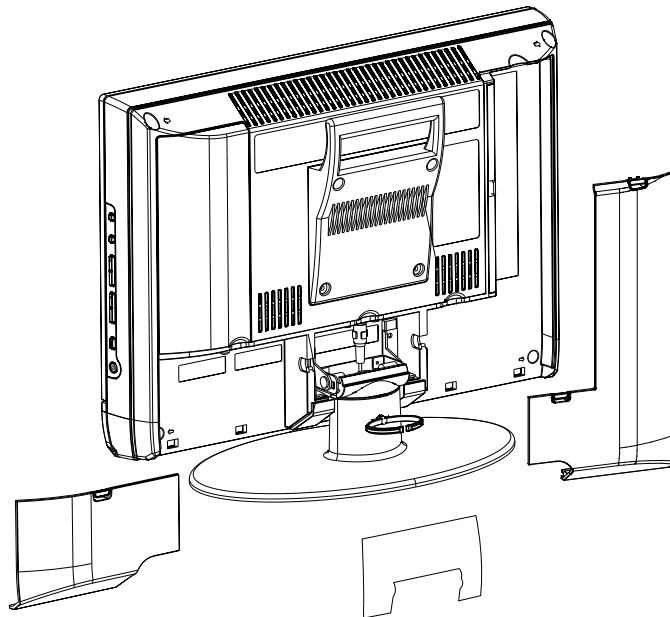

-
- 100mm mount based on VESA regulation is equipped.
 - The handle and the stand can be left by loosening the screws with a screwdriver when mounting the TV on a wall.
 - Spread a soft cloth on a flat table and then place the TV on the cloth with the screen facing downwards when you leave the handle and the stand.

Connecting the aerial and video cassette recorder (VCR)

- Aerial cable is not supplied. Use a good quality 75-ohm coaxial cable.
- Read the manual that came with the VCR before connecting.

If not connecting a VCR (follow ①):
Connect an aerial cable to the aerial socket on this TV.

If connecting a VCR:

- 1 Connect the aerial cable to the aerial input socket on the VCR, and connect the VCR and TV with another aerial cable**
- 2 Connect the VCR's VIDEO OUT (video output) terminal and the TV's VIDEO terminal with a video cable**

To connect a VCR to the TV with an S-VIDEO cable:
 Connect the VCR's S-VIDEO OUT (S-VIDEO output) terminal and TV's S-VIDEO terminal with an S-VIDEO cable (A), instead of connecting with a video cable.
 Note that the connection with a video cable will be ignored in case you connect a VCR to the TV with both video cable and S-VIDEO cable.

- 3 Connect the VCR's VIDEO OUT (audio L/R output) terminals and the TV's AUDIO input terminals with an audio cable**

- To connect additional external devices, please see "Connecting the external equipment" on page 27.
- If the VCR's audio output is in mono, connect the VCR's AUDIO OUT(audio output)terminal and the TV's audio L/MONO input terminal with an audio cable.

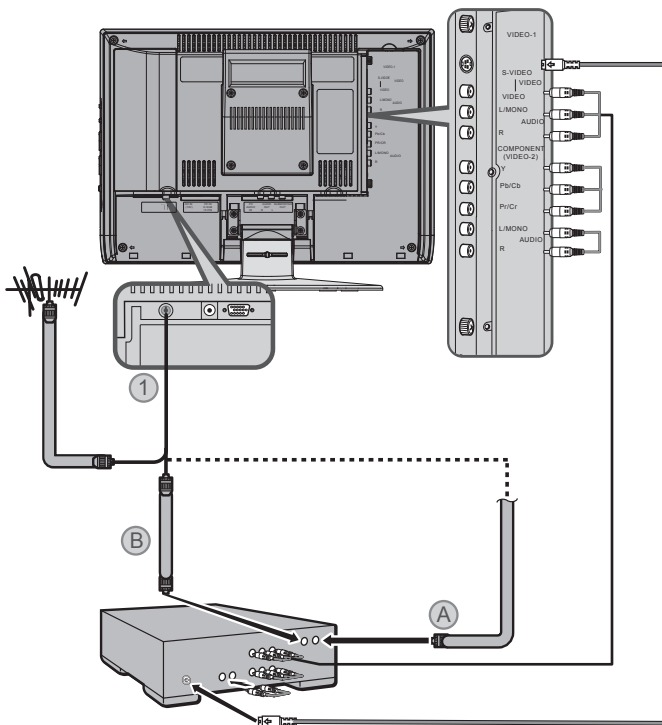

Connecting the power cord to the AC outlet

If you are connecting a AC adapter, follow (A) → (B) in the diagram below.

- Connect (A) to the TV and (B) to the AC outlet.

Caution

- Operate only from the power source specified (AC 100 – 240 V, 50/60 Hz) on the unit.

- Remove the AC plug from the outlet to completely disconnect the TV from the power supply.

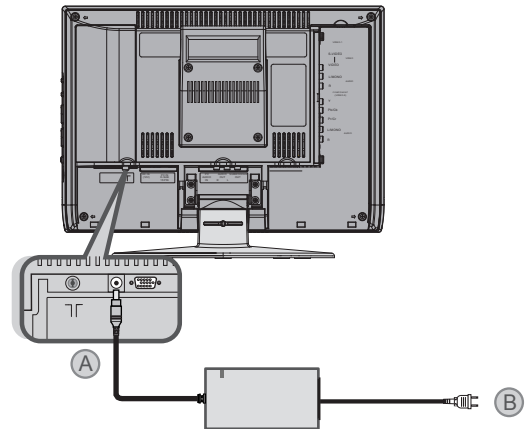

Initial settings

When the TV is first turned on, it enters the initial setting mode. Follow the instructions on the on-screen display to make the initial settings.

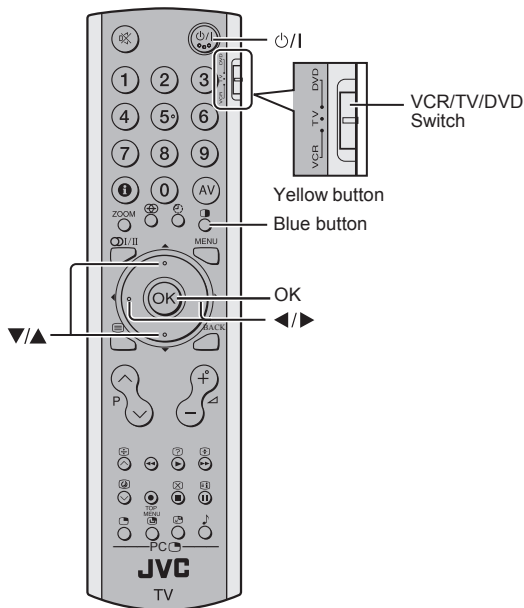

1 Make sure to set the VCR/TV/DVD switch to the TV position.

- You cannot turn the TV on when the VCR/TV/DVD switch is set to the VCR or DVD position.

2 Press the ⏻/⏪ button on the remote control

After a short interval the power lamp changes from red to green.

- Check that the AC plug on the power cord from the TV is connected to AC outlet.

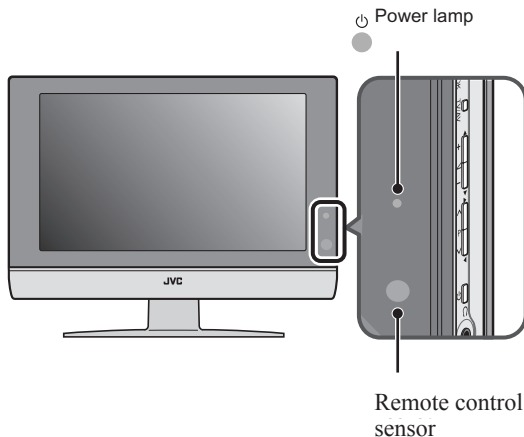

3 AUTO PROGRAM menu appears.

INSTALL
▶ LANGUAGE ENGLISH
AUTO PROGRAM ▶
▼▲: SELECT ◀▶: MOVE

4 Press the ▼/▲ buttons to choose the LANGUAGE.

5 Press the ◀/▶ buttons to choose the ENGLISH.

The on-screen display will then be in English.

6 Press the ▼/▲ buttons to choose the AUTO PROGRAM.

7 Press the ◀/▶ buttons to enter the AUTO PROGRAM.

AUTO PROGRAM
START ▶
OK : START

8 Press the OK button to start AUTO PROGRAM.

AUTO PROGRAM
NOW PROGRAMMING CH-01
◀ ▶
MENU : EXIT

The AUTO PROGRAM menu appears and received TV channels are automatically stored in the programme numbers.

- To cancel the AUTO PROGRAM function: Press the MENU button.

After the TV channels have been registered in the programme numbers, the PR LIST menu appears

PR LIST
01 ---- 11 ---- 21 ----
02 ---- 12 ---- 22 ----
03 ---- 13 ---- 23 ----
04 ---- 14 ---- 24 ----
05 ---- 15 ---- 25 ----
06 ---- 16 ---- 26 ----
07 ---- 17 ---- 27 ----
08 ---- 18 ---- 28 ----
09 ---- 19 ---- 29 ----
10 ---- 20 ---- 30 ----
■ NAME ■ DELETE
■ INSERT ■

- If you want, you can now edit the programme numbers using the AUTO PROGRAM function. For details, see “To edit the PR LIST menu” on page 22.

Now, the initial settings are complete, and you can watch the TV

- If your TV can detect the TV channel name from the TV channel broadcast signal, the TV channel name is assigned to the programme number to which the TV channel has been set. However, which TV channels are set to which programme numbers will depend on the area in which you live.
- If a TV channel you want to view is not set to a programme number, you can set it using the MANUAL function. For details, see "To edit the PR LIST menu" on page 22.
- The AUTO PROGRAM function does not set the programme number PR 0 for your video cassette recorder. You will need to set this using the MANUAL function.
- In some areas you may get TV reception from more than one transmitter, for example different ITV regions. In this case each TV channel could be set twice. If this happens, the first set of channels will have the stronger signal. If you want to delete the second set of channels, you will have to do it manually (see page 21).

TV buttons and functions

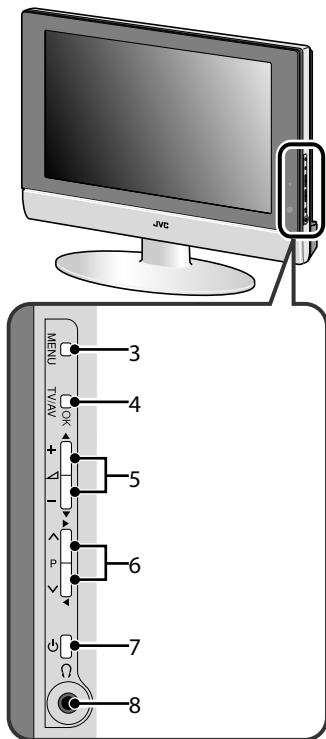
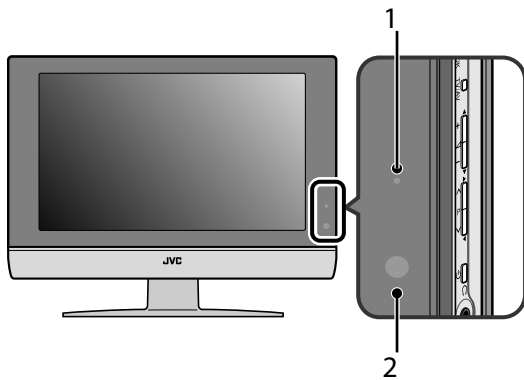

- 1 Power lamp
- 2 Remote control sensor
- 3 MENU button
- 4 TV/AV OK button
- 5 (Volume) - / + button
- 6 P V/A buttons
- 7 (Standby) button
- 8 Headphone jack (mini jack)

Turn the TV on from standby mode

Press the button or P V/A buttons to turn the TV on from standby mode

- Check that the AC plug on the power cord from the TV is connected to correctly AC outlet.

Choose a TV channel

Press the P V/A buttons to choose a programme number or an EXT terminal

Watch images from external devices

Press the TV/AV button to choose a TV/AV terminal

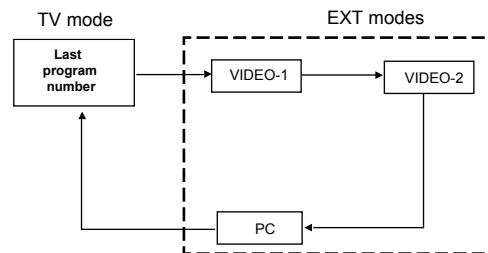

Adjust the volume

Press the - / + buttons
The volume level indicator appears.

Using the Menu

Use the MENU button.

Refer to "Using the TV's menu"(see page 17) for details of using the menu.

Remote control buttons and functions

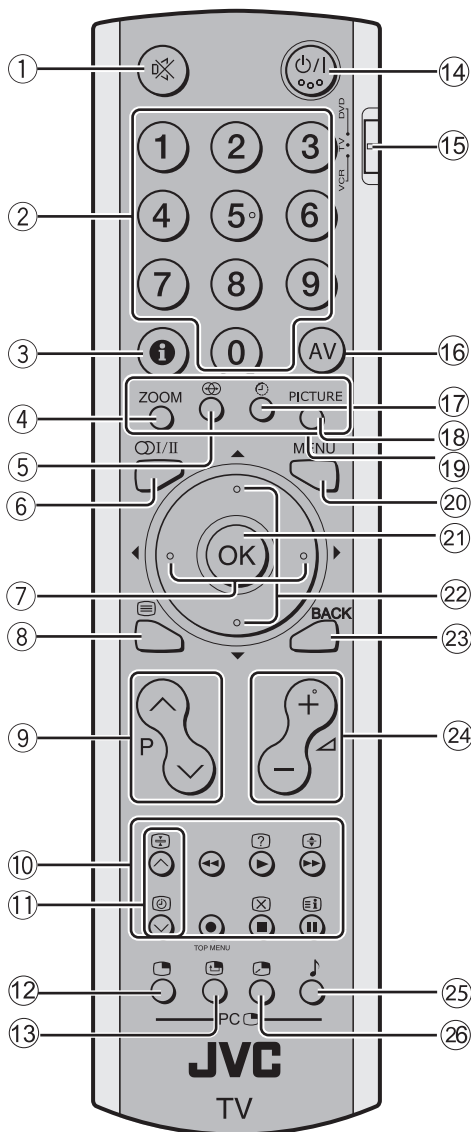

- 1 Muting button
- 2 Number buttons
- 3 Information button
- 4 ZOOM button
- 5 @ button
- 6 O/I/II button
- 7 ◀/▶ buttons
- 8 (Text) button
- 9 P V/∧ buttons
- 10 VCR/DVD/Teletext control buttons
- 11 V/∧ buttons
- 12 TV button
- 13 PC button
- 14 Standby button
- 15 VCR/TV/DVD switch
- 16 AV button
- 17 Picture button
- 18 Color buttons
- 19 MENU button
- 20 OK button
- 21 OK button
- 22 ▼/▲ buttons
- 23 BACK button
- 24 -/+ buttons
- 25 J button
- 26 @ button

Choose a TV channel

Use the number buttons:

Enter the programme number of the channel using the number buttons.

Example:

- PR 6 → press 6
- PR 12 → press 1 and 2

Use the P V/∧ buttons:

Press the P V/∧ buttons to choose the programme number you want.

- If you do not have a clear picture or no colour appears, change the colour system manually. Follow the description "MUNUAL" on page 21 to try to change COLOUR SYSTEM.
- If the SOUND SYSTEM setting for a TV channel is incorrect, it may prevent the sound from being issued. Follow the description "MANUAL" on page 21 to try to change the SOUND SYSTEM setting.

Turn the TV on or off from standby mode

1 Make sure to set the VCR/TV/DVD switch to the TV position.

- You cannot turn the TV on or off when the VCR/TV/DVD switch is set to the VCR or DVD position.

2 Press the ⏻ (standby) button to turn the TV on or off.

When the TV is turned on, the power lamp changes from red to green.

- The power can be turned on by pressing P V/∧ buttons or Number buttons.
- Check that the AC plug on the power cord from the TV is connected to AC outlet.

Adjust the volume

Press the **-/+** buttons to adjust the volume. The volume indicator appears and the volume changes as you press the **-/+** buttons.

Muting the sound

Press the (muting) button to turn off the sound.

Pressing the (muting) button again restores the previous volume level.

Watch images from external equipment

Use the AV button:

Press the AV button to choose an EXT terminal.

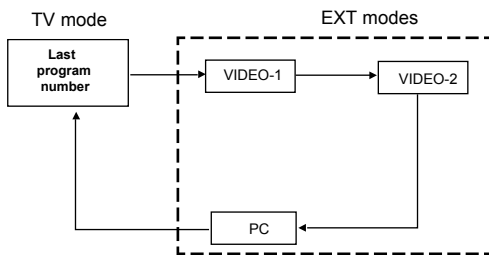

To use the Programme number 0:

When the TV and VCR are connected only by the Aerial cable, choosing the Programme number 0 allows you to view images from the VCR. Set the VCR RF channel to the Programme number 0 manually. For details, see "MANUAL" on page 21.

In the PC mode:

If following message appears, the power lamp blinks in amber and the TV goes in to reduced power mode.

- "NO SIGNAL"
- "CABLE NO INSERT"
- "OUT OF RANGE"

See "Troubleshooting" on page 30 for details of this messages.

Displaying the source information

You can display the source information and current time on the screen.

Press the (information) button to display the source information.

Pressing the (information) button changes the display as follows:

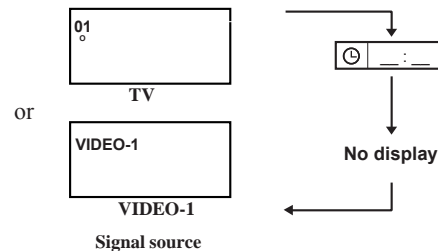

- The source information and current time switched by (information) button.
- The source type :
TV/VIDEO-1/VIDEO-2/PC
- If the programme being watched does not have Teletext transmission, only a box will be displayed at the same location.
- When watching videos, an incorrect current time is sometime displayed.
- In PC mode, the current time will not be displayed

ZOOM function

You can change the screen size according to the picture aspect ratio. Choose the optimum one from the following ZOOM modes.

AUTO:

When a WSS (Wide Screen Signalling) signal, which shows the aspect ratio of the picture, is included in the broadcast signal or the signal from an external device, the TV automatically changes the ZOOM mode to 16:9 ZOOM mode or FULL mode according to the WSS signal. If a WSS signal is not included, the picture is displayed in accordance with the ZOOM mode set with the 4:3 AUTO ASPECT function.

- When the AUTO (WSS) mode does not function correctly due to poor WSS signal quality or when you want to change the ZOOM mode, press the ZOOM button and change to another ZOOM mode.

REGULAR:

Use to view a normal picture (4:3 aspect ratio) as this is its original shape.

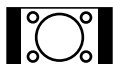

PANORAMIC:

This stretches the left and right sides of a normal picture (4:3 aspect ratio) to fill the screen, without making the picture appear unnatural.

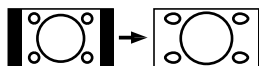

- The top and bottom of the picture are slightly cut off.

14:9 ZOOM:

This zooms up the wide picture (14:9 aspect ratio) to the upper and lower limits of the screen.



16:9 ZOOM:

This zooms up the wide picture (16:9 aspect ratio) to the full screen.



16:9 ZOOM SUBTITLE:

This zooms up the wide picture (16:9 aspect ratio) with subtitles to the full screen.



FULL:

This uniformly stretches the left and right sides of a normal picture (4:3 aspect ratio) to fill the wide TV screen.

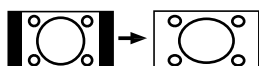

- For 16:9 aspect ratio pictures that have been squeezed into a normal picture (4:3 aspect ratio), use the FULL mode to restore the picture to its original shape.

Choose the ZOOM mode

1 Press the ZOOM button to display the ZOOM menu

- The ZOOM button does not work in the twin pictures mode.

Adjusting the visible area of the picture

If subtitles or the top (or bottom) of the picture are cut off, you can adjust the visible area of the picture manually.

1 Press the ZOOM button

The ZOOM menu appears.



2 Press the OK button to display the ZOOM mode indicator

The indicator appears.

3 While it is displayed, press the ▼/▲ buttons to change the position of the picture

- You cannot adjust the visible area in REGULAR or FULL mode.
- Only REGULAR and FULL modes are available in PC mode.

Sleep timer function

The Sleep Timer can turn the TV off for you after you fall asleep. Programme it to work in intervals of 10 minutes, for a total time of up to 120 minutes.

Press the  button.

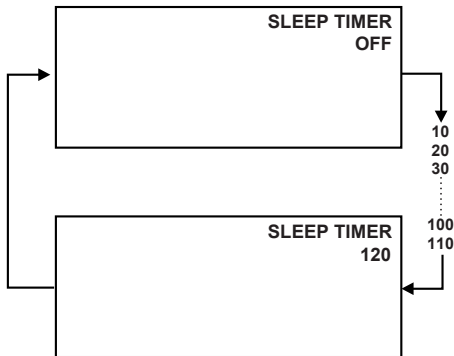

Picture mode

You can choose one of four PICTURE MODES to adjust the picture settings automatically.

Press the **PICTURE** button.

- BRIGHT:**
Heightens contrast and sharpness.
- STANDARD:**
Standardizes picture adjustment.
- SOFT:**
Softens contrast and sharpness.
- MANUAL:**
User define.

Using the PCPIP function

A PC picture and TV or a video programme from an external device can be watched at the same time.

1 Press the  button.

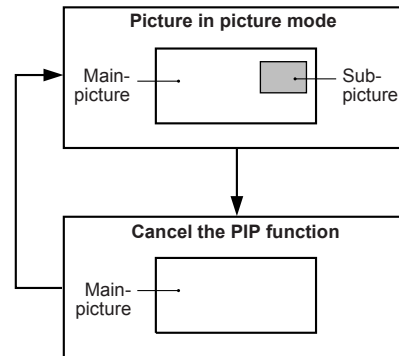

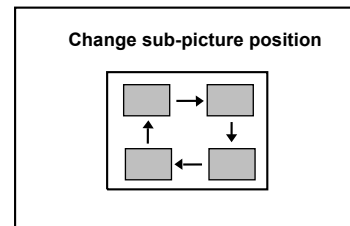

D0057

2 Press the  button to change the position of sub-picture

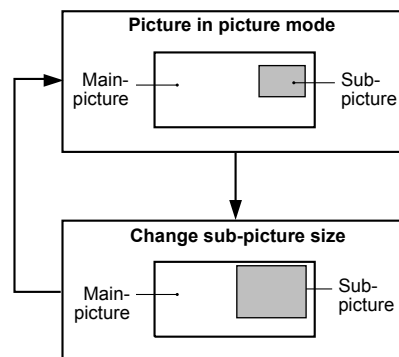

3 Press the  button to change the sub-picture size



4 Press the  button to choose the sound

- MAIN :** Main picture
- SUB :** Sub picture

-
- If the main-picture signal is poor, the quality of the sub-picture may also be poor.
 - If the pictures have different standards, the top and bottom of one of them may be missing.
-
- If you press the menu button when the PIP functions is on, PC menu will appear. To display the TV menu, change the mode to the TV mode.
-

Operating a JVC brand VCR or DVD player

These buttons will operate a JVC brand VCR or DVD player. Pressing a button that looks the same as the device's original remote control button has the same effect as the original remote control.

1 Set the VCR/TV/DVD switch to the VCR or DVD position

VCR:

When you are using a VCR, set the switch to the VCR position. You can turn the VCR on or off with the $\odot/|$ (Standby) button.

DVD:

When you are using a DVD player, set the switch to the DVD position. You can turn the DVD player on or off with the $\odot/|$ (Standby) button.

2 Press the VCR/DVD Control Button to control your VCR or DVD player

- If your device is not made by JVC, these buttons will not work.
- Even if your device is made by JVC, some of these buttons may not work, depending on the device you are using.
- You can use the pV/\wedge buttons to choose a TV channel the VCR will receive, or choose the chapter the DVD player plays back.
- Some models of DVD player use the pV/\wedge buttons for both operating the fast forward/backward functions and for choosing the chapter.
- Set the VCR/TV/DVD switch to the TV position when you turn the TV on or off.

Teletext function

Basic operation

- 1 Choose a TV channel with a teletext broadcast
- 2 Make sure to set the VCR/TV/DVD switch to the TV position.



- 3 Press  (Text) button to display the teletext
Pressing  (Text) button changes the mode as follows:

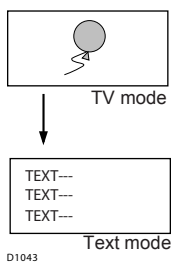

- 4 Choose a teletext page by pressing the P ∇/\wedge buttons, number buttons or colour buttons

To return to the TV mode:

Press the  (Text) button.

- If you have trouble receiving teletext broadcasts, consult your local dealer or the teletext station.
- The ZOOM function will not work in the TV and text mode or Text mode.
- You cannot operate menus when viewing a teletext programme.

Hold

You can hold a teletext page on the screen for as long as you want, even while several other teletext pages are being received.

Press the (Hold) button

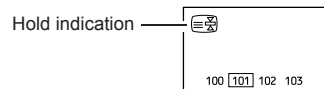

To cancel the Hold function:

Press  (Hold) button again.

Sub-page

Some teletext pages include sub-pages that are automatically displayed.

1 Choose a teletext page that includes sub-pages

Press the  button, Sub-page numbers can be viewed and displayed at the screen.

2 Press the number buttons to choose a sub-page number

Sxxxx : xxxx is the number 0 ~ 9 that you entered.

For example, sub-page 1 is S0001, you must enter 0,0,0 and 1 serially to view sub-page S0001.

Reveal

Some teletext pages include hidden text (such as the answers to a quiz). You can display the hidden text.

Each time you press the  (Reveal) button, text is hidden or revealed

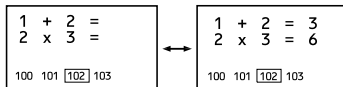

Size

You can double the height of the teletext display.

Press the  (Size) button.

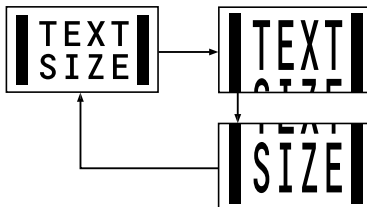

Index

You can return to the index page instantly.

Press the  (Index) button

Returns to page 100 or a previously specified page.

Cancel

You can search for a teletext page while watching TV.



1 Press the number button to enter a page number, or press a colour button

The TV searches for a teletext page.

2 Press the (Cancel) button

The TV programme appears. When the TV finds the teletext page, its page number appears in the upper left of the screen.

3 Press the (Cancel) button to return to a teletext page when the page number is on the screen

- The TV mode cannot be resumed by pressing the  (Cancel) button. To return to the TV mode press  button.

Using the TV's menu

This TV has a number of functions you can operate using menus. To use all your TV's functions, you need to understand the basic menu operating techniques fully.

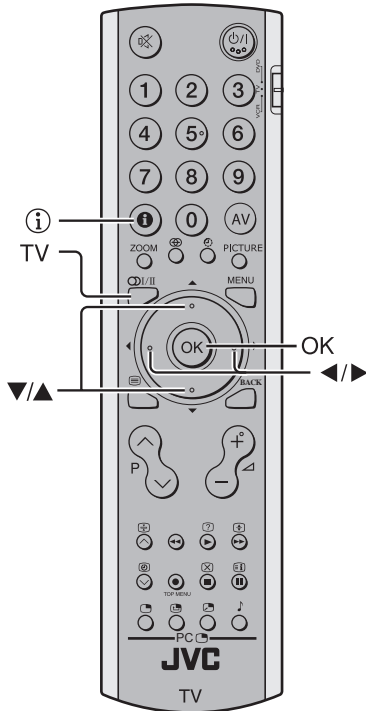

3 Press the ▼/▲ buttons to choose a function

- For details of the functions in the menus, see the following pages.

4 Press the ◀/▶ buttons to choose the setting of that function

- If you want to operate a function which appears only with its name, follow the descriptions of that function on the following pages.
- The display appearing at the bottom of a menu shows you a button on the remote control that you can use when you operate a chosen function.

5 Press the MENU button to complete the setting

The menu disappears.

- When watching the television with the NTSC system, the menus are displayed at about half of their normal vertical size.
- The menu will disappear if you press the P V / ▲ buttons, the AV button or the number buttons while the menu is displayed.

Operation with the buttons on the TV

You can also operate the menus using the buttons on the front panel of the TV.

Basic operation

1 Press the MENU button to display the MENU (main menu)

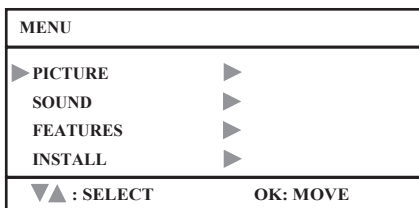

2 Press the ◀/▶ and ▼/▲ buttons to choose a menu title, and press the OK button

The menu appears.

To return to the previous menu:

Press the BACK button on the remote control or the MENU button on the TV.

To exit a menu instantly:

Press the MENU button on the remote control or press the MENU button on the TV several times.

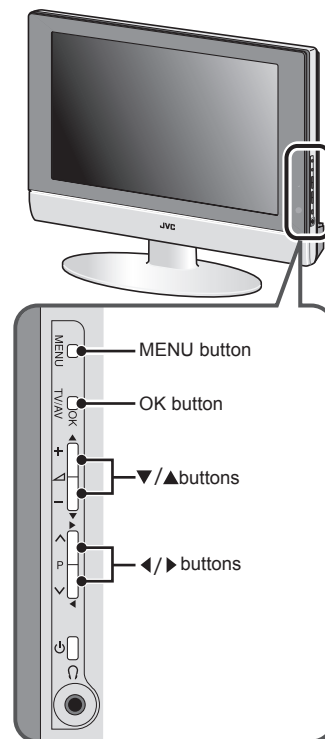

The menu will disappear after about one minute if no operation is performed.

PICTURE SETTING

Refer to “Using the TV’s menu” (see page 17) for details of displaying the menu.

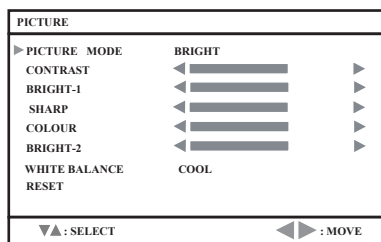

PICTURE MODE

You can choose one of four PICTURE MODEs to adjust the picture settings automatically.

BRIGHT:

Heightens contrast and sharpness.

STANDARD:

Standardizes picture adjustment.

SOFT:

Softens contrast and sharpness.

MANUAL:

User define.

Picture Adjustment

You can change the picture settings of each PICTURE MODE mode as you like.

CONTRAST:

You can adjust the picture contrast.

◀ : lower

▶ : higher

BRIGHT-1:

You can adjust the picture brightness.

◀ : darker

▶ : brighter

SHARP:

You can adjust the picture sharpness.

◀ : softer

▶ : sharper

COLOUR:

You can adjust the picture colour.

◀ : lighter

▶ : deeper

BRIGHT-2:

You can adjust the back light.

◀ : darker

▶ : lighter

TINT:

You can adjust the picture tint.

◀ : reddish

▶ : greenish

- You can change the TINT setting when the colour system is NTSC 3.58 or NTSC 4.43.

WHITE BALANCE

You can select one of three WHITE BALANCE modes (three tones of white) to adjust the white balance of the picture. Since white is the colour which is used as a reference for all the other colours, changing the WHITE BALANCE mode affects the appearance of all the other colours on the screen.

COOL:

A bluish white. Using this mode when watching bright pictures allows you to enjoy a more vivid and bright picture.

NORMAL:

The normal white colour.

WARM:

A reddish white. Using this mode when watching films allows you to enjoy colours that are characteristic of films.

RESET

You can reset the picture settings you have chosen to the default settings.

SOUND

Refer to “Using the TV’s menu” (see page 17) for details of displaying the menu.

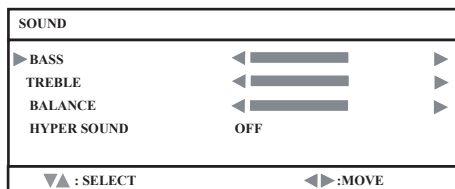

HYPER SOUND

You can enjoy Surround sound with a “live” effect by using the HYPER SOUND function.

ON:

HYPER SOUND function is turned on.

OFF:

HYPER SOUND function is turned off.

- The SOUND settings are common in the TV mode and in the PC mode.

Sound Adjustment

You can adjust the sound to your liking.

BASS:

You can adjust the low tone of the sound.

◀ : weaker

▶ : strong

TREBLE:

You can adjust the high tone of the sound.

◀ : weaker

▶ : strong

BALANCE:

You can adjust the volume balance between the left and right speaker.

◀ : turn the left speaker’s volume level up.

▶ : turn the right speaker’s volume level up.

FEATURES

Refer to “Using the TV’s menu” (see page 17) for details of displaying the menu.

FEATURES	
▶ BLUE BACK	OFF
CHILD LOCK	OFF
▼▲ : SELECT	◀▶ : MOVE

BLUE BACK

You can set the TV to automatically change to a blue screen and mute the sound if the signal is weak or absent, or when there is no input from an external device.

ON:

This function is turned on.

OFF:

This function is turned off.

CHILD LOCK

When the CHILD LOCK mode is on, the TV buttons will be locked except button. TV only can be controlled by remote controller.

ON:

This function is turned on.

OFF:

This function is turned off.

INSTALL

Refer to "Using the TV's menu" (see page 17) for details of displaying the menu.

INSTALL	
▶ LANGUAGE ENGLISH	▶▶
AUTO PROGRAM	▶▶
MANUAL	▶▶
PR LIST	▶▶
▼▲ : SELECT	◀▶ : MOVE

LANGUAGE

Press the ◀/▶ buttons to choose the ENGLISH.

The on-screen display will then be in English.

AUTO PROGRAM

AUTO PROGRAM

You can automatically store the TV channels for which you have the best reception. Store them in the TV's programme numbers list by doing the following.

1 Choose AUTO PROGRAM. Then press the OK button.

AUTO PROGRAM	
START	▶
OK : STRAT	

2 Press the OK button to start the AUTO PROGRAM

AUTO PROGRAM	
NOW PROGRAMMING	◀ —▶
MENU : EXIT	

The AUTO PROGRAM menu appears and received TV channels are automatically stored in the programme numbers.

- To cancel the AUTO PROGRAM function:
Press the MENU button.

PR LIST		
01 ----	11 ----	21 ----
02 ----	12 ----	22 ----
03 ----	13 ----	23 ----
04 ----	14 ----	24 ----
05 ----	15 ----	25 ----
06 ----	16 ----	26 ----
07 ----	17 ----	27 ----
08 ----	18 ----	28 ----
09 ----	19 ----	29 ----
10 ----	20 ----	30 ----
■ NAME	■ DELETE	
■ INSERT	■	

After the TV channels have been registered in the programme numbers, the PR LIST menu appears.

- If you want, you can now edit the program numbers using the AUTO PROGRAM function. For details, see "To edit the PR LIST menu" on page 22.

MANUAL

You can store the TV channel for which you needed. Store them in the TV's programme numbers list by setting the following.

MANUAL	
▶ PROGRAM	00
BAND	CH
CHANNEL	02
COLOUR SYSTEM	AUTO
SOUND SYSTEM	AUTO
SEARCH	◀ —▶
FINE TUNING	◀ —▶
STORE	
▼▲ : SELECT	◀▶ : MOVE

1 Select PROGRAM and press the ◀/▶ buttons to choose the programme number from 00 to 99.

2 Select BAND and press the ◀/▶ buttons to choose the band type.

CH(AIR) / CC(CATV)

3 Select CHANNEL and press the ◀/▶ buttons to choose the channel number. (CH:02-69,CC:01-99)

4 Select COLOUR SYSTEM and press the ◀/▶ buttons to choose the colour system.

AUTO / PAL / SECAM

- If you do not have a clear picture or no colour appears, change the colour system.

5 Select SOUND SYSTEM and press the ◀/▶ buttons to choose the sound system.

AUTO / B/G / D/K / I

- If the SOUND SYSTEM setting for a TV channel is incorrect, it may prevent the sound from being issued.

6 Select SEARCH and press the ◀/▶ buttons to choose the serviceable TV channel.

7 If the channel reception is poor, select FINE TUNING and press the ◀/▶ buttons to fine tune the program.

8 Select Store and press the ◀/▶ buttons to store the manual setting. When stored, OK will be displayed for short seconds.

To edit the PR LIST menu

You can edit the programme numbers.

Caution

- Using the NAME, DELETE or INSERT functions rewrites the current programme numbers list. Therefore, the programme number of some of the TV channels will change.

1 Choose PR LIST, then press the OK button

PR LIST		
01 ----	11 ----	21 ----
02 ----	12 ----	22 ----
03 ----	13 ----	23 ----
04 ----	14 ----	24 ----
05 ----	15 ----	25 ----
06 ----	16 ----	26 ----
07 ----	17 ----	27 ----
08 ----	18 ----	28 ----
09 ----	19 ----	29 ----
10 ----	20 ----	30 ----
■ NAME	■ DELETE	
■ INSERT	■	

2 Follow the operation description of a function you want to use and operate the function

NAME:

This function registers a channel name (ID) to a TV channel.

INSERT:

This function changes a programme number of a TV channel.

DELETE:

This function deletes a TV channel you do not want to list.

NAME

1 Press the ◀/▶ and ▼/▲ buttons to choose a TV channel

Every time you press the ◀/▶ and ▼/▲ buttons, the programme number changes and the picture of the TV channel stored in the programme number appears on the screen.

2 Press the red button to start the NAME function

PR LIST		
01 ----	11 ----	21 ----
02 ----	12 ----	22 ----
03 ----	13 ----	23 ----
04 ----	14 ----	24 ----
05 ----	15 ----	25 ----
06 ----	16 ----	26 ----
07 ----	17 ----	27 ----
08 ----	18 ----	28 ----
09 ----	19 ----	29 ----
10 ----	20 ----	30 ----
■ STORE	■	
■	■ CANCEL	

3 Press the ◀/▶ and ▼/▲ buttons to edit the channel name you want to give the TV channel

PR LIST		
01 ----	11 ----	21 ----
02 JVC	12 ----	22 ----
03 ----	13 ----	23 ----
04 ----	14 ----	24 ----
05 ----	15 ----	25 ----
06 ----	16 ----	26 ----
07 ----	17 ----	27 ----
08 ----	18 ----	28 ----
09 ----	19 ----	29 ----
10 ----	20 ----	30 ----
■ STORE	■	
■	■ CANCEL	

4 Press the red button to store the setting

PR LIST		
01 ----	11 ----	21 ----
02 JVC	12 ----	22 ----
03 ----	13 ----	23 ----
04 ----	14 ----	24 ----
05 ----	15 ----	25 ----
06 ----	16 ----	26 ----
07 ----	17 ----	27 ----
08 ----	18 ----	28 ----
09 ----	19 ----	29 ----
10 ----	20 ----	30 ----
■ NAME	■ DELETE	
■ INSERT	■	

To return- to the INSTALL menu:

Press the BACK-button.

To exit a menu instantly:

Press the MENU button.

INSERT

- 1 Press the ◀/▶ and ▼/▲ buttons to choose a program number for which you want**

Every time you press the ◀/▶ and ▼/▲ buttons, the programme number changes and the picture of the TV channel stored in the programme number appears on the screen.

PR LIST		
01 ----	11 ----	21 ----
02 ----	12 ----	22 ----
03 ----	13 ----	23 ----
04 ----	14 ----	24 ----
05 ----	15 ----	25 ----
06 ----	16 ----	26 ----
07 ----	17 ----	27 ----
08 ----	18 ----	28 ----
09 ----	19 ----	29 ----
10 ----	20 ----	30 ----
■ NAME	■ DELETE	
■ INSERT	■	

- 2 Press the green button to start the INSERT function-**

PR LIST		
01 ----	11 ----	21 ----
02 ----	12 ----	22 ----
03 ----	13 ----	23 ----
04 ----	14 ----	24 ----
05 ----	15 ----	25 ----
06 ----	16 ----	26 ----
07 ----	17 ----	27 ----
08 ----	18 ----	28 ----
09 ----	19 ----	29 ----
10 ----	20 ----	30 ----
■	■	
■ INSERT	■ CANCEL	

- 3 Press the ◀/▶ and ▼/▲ buttons to choose a new program number**

PR LIST		
01 ----	11 ----	21 ----
02 ----	12 ----	22 ----
03 ----	13 ----	23 ----
04 ----	14 ----	24 ----
05 ----	15 ----	25 ----
06 ----	16 ----	26 ----
07 ----	17 ----	27 ----
08 ----	18 ----	28 ----
09 ----	19 ----	29 ----
10 ----	20 ----	30 ----
■	■	
■ INSERT	■ CANCEL	

- 4 Press the green button to insert the channel into the new program number**

PR LIST		
01 ----	11 ----	21 ----
02 ----	12 ----	22 ----
03 ----	13 ----	23 ----
04 ----	14 ----	24 ----
05 ----	15 ----	25 ----
06 ----	16 ----	26 ----
07 ----	17 ----	27 ----
08 ----	18 ----	28 ----
09 ----	19 ----	29 ----
10 ----	20 ----	30 ----
■ NAME	■ DELETE	
■ INSERT	■	

To return to the INSTALL menu:

Press the BACK button.

To exit a menu instantly:

Press the MENU button.

DELETE

1 Press the ◀/▶ and ▼/▲ buttons to choose a program number for which you want

Every time you press the ◀/▶ and ▼/▲ buttons, the programme number changes and the picture of the TV channel stored in the programme number appears on the screen.

PR LIST		
01 ----	11 ----	21 ----
02 ----	12 ----	22 ----
03 ----	13 ----	23 ----
04 ----	14 ----	24 ----
05 ----	15 ----	25 ----
06 ----	16 ----	26 ----
07 ----	17 ----	27 ----
08 ----	18 ----	28 ----
09 ----	19 ----	29 ----
10 ----	20 ----	30 ----
■ NAME	■ DELETE	
■ INSERT	■	

2 Press the yellow button to start DELETE function

PR LIST		
01 ----	11 ----	21 ----
02 ----	12 ----	22 ----
03 ----	13 ----	23 ----
04 ----	14 ----	24 ----
05 ----	15 ----	25 ----
06 ----	16 ----	26 ----
07 ----	17 ----	27 ----
08 ----	18 ----	28 ----
09 ----	19 ----	29 ----
10 ----	20 ----	30 ----
■	■ DELETE	
■	■ CANCEL	

3 Press the yellow button to delete the selected TV channel

The TV channel is deleted from the programme numbers list.

PR LIST		
01 ----	11 ----	21 ----
02 ----	12 ----	22 ----
03 ----	13 ----	23 ----
04 ----	14 ----	24 ----
05 ----	15 ----	25 ----
06 ----	16 ----	26 ----
07 ----	17 ----	27 ----
08 ----	18 ----	28 ----
09 ----	19 ----	29 ----
10 ----	20 ----	30 ----
■ NAME	■ DELETE	
■ INSERT	■	

To return to the INSTALL menu:

Press the BACK button.

To exit a menu instantly:

Press the MENU button.

COLOUR SYSTEM in EXT mode

Press the ◀/▶ buttons to choose the colour system

When you are in EXT mode, you can only change the colour system in the INSTALL menu.

PC MENU (In PC mode only)

This TV also has a number of functions on PC mode, you can operate using pc menus.

PC MENU	
▶ PC PICTURE POSITION ▶	
PC PICTURE ▶	
SOUND ▶	
▼▲ : SELECT	OK : MOVE
1024 X 768	
H : 48 kHz	V : 60 Hz

PC PICTURE POSITION

You can adjust the picture settings as following functions.

PC PICTURE POSITION	
▶ AUTO SETUP	
H POSITION ◀ ██████████ ▶	
V POSITION ◀ ██████████ ▶	
CLOCK ◀ ██████████ ▶	
PHASE ◀ ██████████ ▶	
RESET	
▼▲ : SELECT	◀▶ : MOVE

AUTO SETUP:

You can adjust picture settings automatically for optimized picture position, clock and phase.

H POSITION:

You can adjust picture horizontal position.

- ◀ : left
- ▶ : right

V POSITION:

You can adjust picture vertical position.

- ◀ : down
- ▶ : up

CLOCK:

You can adjust CLOCK to fine tune picture.

PHASE:

You can adjust PHASE to fine tune picture.

RESET:

You can select RESET mode for default setting.

PC PICTURE

You can change the picture settings of each PICTURE MODE mode as you like.

PC PICTURE	
▶ CONTRAST ◀ ██████████ ▶	
BRIGHT-2 ◀ ██████████ ▶	
WHITE BALANCE	COOL
R ◀ ██████████ ▶	
G ◀ ██████████ ▶	
B ◀ ██████████ ▶	
RESET	
▼▲ : SELECT	◀▶ : MOVE

CONTRAST:

You can adjust the picture contrast.

- ◀ : lower
- ▶ : higher

BRIGHT-2:

You can adjust the back light.

- ◀ : darker
- ▶ : lighter

WHITE BALANCE:

You can adjust the picture colour mode.

COOL:

A bluish white. Using this mode when watching bright pictures allows you to enjoy a more vivid and bright picture.

NORMAL:

The normal white colour.

WARM:

A reddish white. Using this mode when watching films allows you to enjoy colours that are characteristic of films.

MANUAL:

User defined.

NOTE: When WHITE BALANCE at COOL, NORMAL and WARM, R,G,B and bars in Gray and can not move.

R:

You can adjust the Red color component.

- ◀ : reddish
- ▶ : redder

G:

You can adjust the Green color component

- ◀ : greenish
- ▶ : greener

B:

You can adjust the Blue color component.

- ◀ : blueish
- ▶ : bluer

RESET:

You can select RESET mode for default setting.

SOUND

You can adjust the sound to your liking.

SOUND	
▶ BASS ◀ ██████████ ▶	
TREBLE ◀ ██████████ ▶	
BALANCE ◀ ██████████ ▶	
HYPER SOUND	OFF
▼▲ : SELECT	◀▶ : MOVE

BASS:

You can adjust the low tone of the sound.

- ◀ : weaker
- ▶ : strong

TREBLE:

You can adjust the high tone of the sound.

- ◀ : weaker
- ▶ : strong

BALANCE:

You can adjust the volume balance between the left and right speaker.

- ◀ : turn the left speaker's volume level up.
- ▶ : turn the right speaker's volume level up.

HYPER SUOUND:

You can enjoy Surround sound with a "live" effect by using the HYPER SOUND functions.

ON: HYPER SOUND function is turned on.

OFF: HYPER SOUND function is turned off.

- The SOUND settings are common in the TV mode and in the PC mode.

PC support mode list

LT-17S2

Mode NO.	Mode Name Resolution	H Freq. (kHz) V Freq. (Hz)
1	VGA 60 Hz 640x480	31.469 59.941
2	SVGA 56 Hz 800x600	35.16 56.25
3	SVGA 60 Hz 800x600	37.879 60.317
4	XGA 60 Hz 1024x768	48.363 60.004
5	WXGA 1280x768	47.73 60

LT-23S2

Mode NO.	Mode Name Resolution	H Freq. (kHz) V Freq. (Hz)
1	VGA 70 Hz 640x350	31.469 70.087
2	VGA 60 Hz 640x480	31.469 59.941
3	SVGA 56 Hz 800x600	35.16 56.25
4	SVGA 60 Hz 800x600	37.879 60.317
5	XGA 60Hz 1024x768	48.363 60.004
6	XGA 70Hz 1024x768	56.476 70.069
7	MAC VGA 640x480	35 66.667
8	US TEXT 720x400	31.469 70.087
9	WXGA 1280x768	47.73 60

The resolution and the frequencies which are displayed on the screen may not exactly same as this list.

The Auto SETUP functions will work automatically when you change the resolution of PC mode. The picture position, clock, and phase will be optimized.

Notice when using LCD-TV under PC mode:

1. Whenever your LCD-TV is connected to the PC, or you have changed the PC display mode. Please use Auto Setup to automatically configure your display to the best settings.
2. You must perform auto setup before making any adjustment.

Additional preparation

Connecting external equipment

Connect the equipment to the TV, making the correct rear panel and front panel connections.

Before connecting anything:

- Read the manuals that came with the equipment. Depending on the equipment, the connection method may be different from the diagram. Also, the equipment settings may need to change depending on the connection method.
- Turn off all the equipment including the TV.
- The “Specifications” on page 29 give the details of the EXT terminals. If you are connecting equipment not listed in the following connection diagram, see the table to choose the best EXT terminal.
- Connecting cables are not supplied.
- If the VCR's audio output is in mono, connect the VCR's AUDIO OUT (audio output) terminal and TV's Audio L/MONO input terminal with an audio cable.
- Progressive scanning signals are not available.

- ① VCR (composite signal)
- ② VCR (composite signal/S-VIDEO signal)
- ③ DVD player (composite signal/S-VIDEO signal)
- ④ DVD player (component signal)
- ⑤ PC
- ⑥ TV game (component signal)
- ⑦ TV game (composite signal/S-VIDEO signal)
- ⑧ Headphones
- ⑨ Camcorder (composite signal/S-VIDEO signal)
- ⑩ Video cable
- ⑪ Audio cable
- ⑫ S-VIDEO cable
- ⑬ Component cable
- ⑭ Stereo mini jack
- ⑮ D-SUB cable

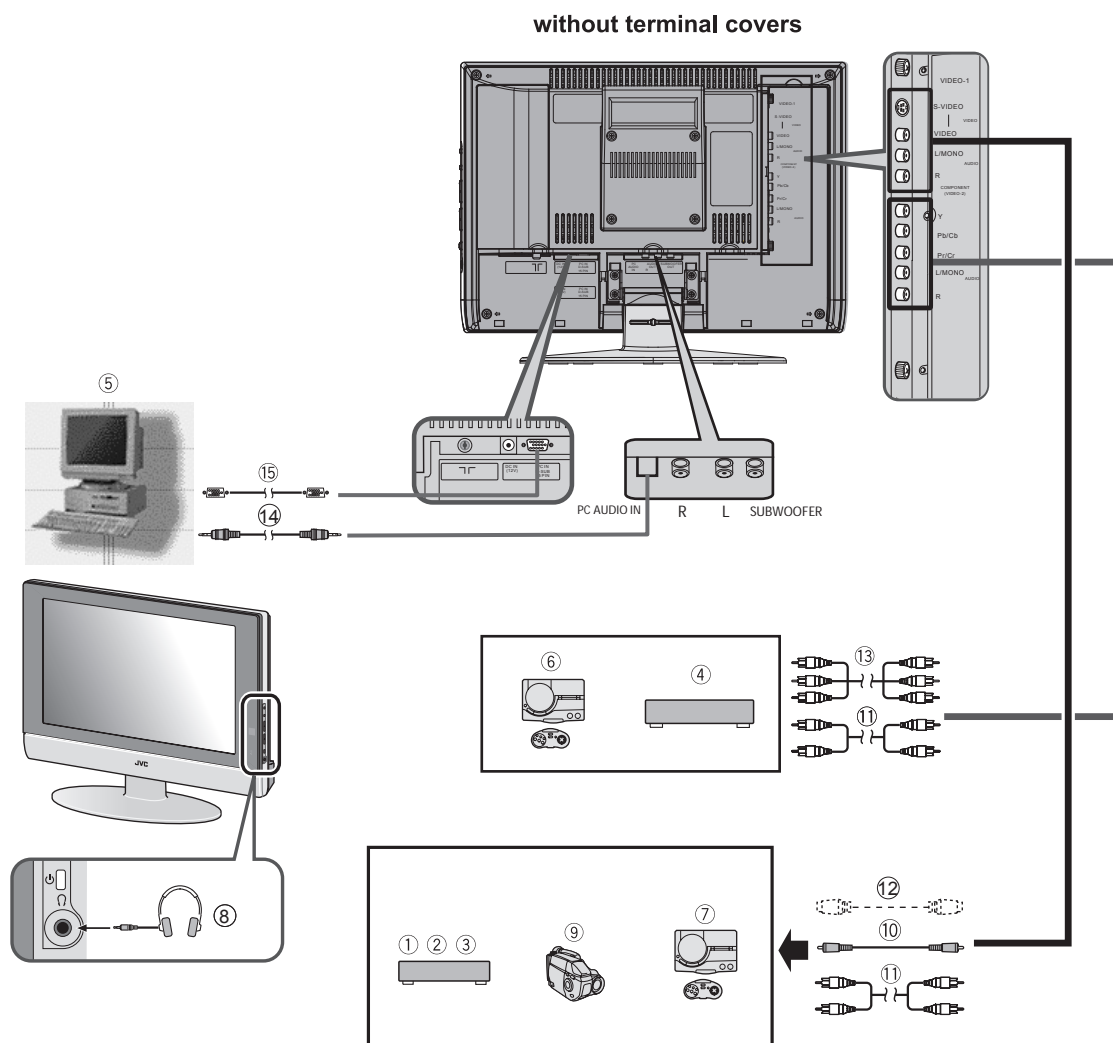

Equipment which can output the S-VIDEO signal (Y/C signal) such as an S-VHS VCR

Connect the equipment to an EXT terminal.

You can choose between an S-VIDEO signal (Y/C signal).

Connecting headphones

Connect the headphones with a stereo mini-jack (3.5 mm diameter) to the headphone socket at the TV.

Connecting the PC

Connect the PC with the D-SUB cable to the D-SUB in at the TV, and connect the sound device of PC with a stereo mini-jack to PC AUDIO IN.

You can adjust the picture by AUTO SETUP function when the PC signal is output correctly, the AUTO SETUP function can optimize the picture position, clock and phase. You can have a fine vision after AUTO SETUP function executed.

Connecting Speakers/Amplifier

See the Audio equipment connection diagram, then connect the audio equipment you desire to the TV. You can use external front speakers to listen to the TV sound instead of the TV speakers.

Before connecting anything:

- Read the manuals provided with the amplifier and speakers.
- Turn the TV and amplifier off.
- To prevent magnetism from the speakers adversely affecting the TV screen, use magnetically-shielded speakers for the front speakers.
- Note that connecting cables are not supplied.

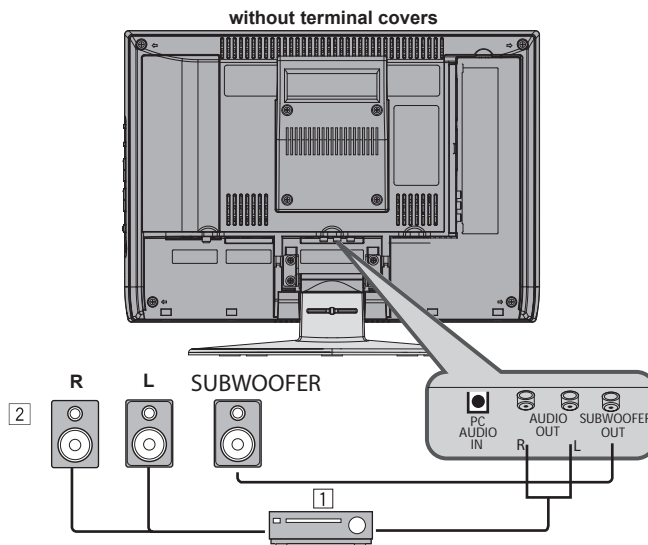

- 1 Amplifier
- 2 External speakers (Magnetic-shielded type)

- The output from the AUDIO OUT terminal is not interrupted by headphone connection to the TV. You cannot cut the sound from the front speaker even if you connect a headphone to the TV.
- Adjust the volume of the external speakers with the amplifier.
- Connect the subwoofer which carried an amplifier.
- The subwoofer is interlocked with the TV volume.
- You can not connect an amplifier and a Subwoofer at the same time.

Troubleshooting

If a problem arises while you are using the TV, please read this troubleshooting guide carefully before you ask to have the TV repaired. You may be able to fix it easily by yourself. For example, if the mains plug is disconnected from the mains outlet, or the TV aerial has problems, you may think there is a problem with the TV itself.

Important:

- This troubleshooting guide only covers problems whose causes are not easy to decide. If you have a question when you are operating a function, read the page(s) for that function carefully, not this troubleshooting guide.
- If you follow the advice in this troubleshooting guide without any success, unplug the mains plug and ask for your TV to be repaired. Do not attempt to repair the TV by yourself or to remove the rear cover of the TV.

If you cannot turn on the TV

- Are the AC plug on the power cord from the TV is connected to AC outlet?
- Make sure to set the VCR/TV/DVD switch to the TV position. You cannot turn the TV on when the VCR/TV/DVD switch is set to the VCR or DVD position.

If you cannot turn off the TV

- Make sure to set the VCR/TV/DVD switch to the TV position. You cannot turn the TV off when the VCR/TV/DVD switch is set to the VCR or DVD position.

No picture or no sound

- Have you chosen a TV channel with very poor reception? If so, the BLUE BACK function will be activated: the entire screen becomes blue, and the sound is muted. If you still want to view the TV channel, follow the description "FEATURES" on page 20 to change the BLUE BACK function setting to OFF.
- If the SOUND SYSTEM setting for a tTV channel is incorrect, it may prevent the sound from being issued. Follow the description "INSTALL" on page 21 to use the MANUAL function to try to change the SOUND SYSTEM setting.

Poor picture

- If noise (snow) totally blocks out the picture, there may be a problem with the aerial or aerial cable. Check the following to try to solve the problem:
 - Have the TV and aerial been connected properly?
 - Has the aerial cable been damaged?
 - Is the aerial pointing in the right direction?
 - Is the aerial itself faulty?
- If the TV or aerial suffers interference from other equipment, stripes or noise may appear in the picture. Move any equipment such as an amplifier, personal computer, or a hair drier, that can cause interference away from your TV. Or try moving the TV. If the aerial suffers interference from a radio tower or high-voltage wire, please contact your local dealer.
- If the TV suffers interference from signals reflecting from mountains or buildings, double-pictures (ghosting) will occur. Try to change the aerial's direction or replace it with one with better directionality.
- Have the COLOUR and BRIGHT settings been adjusted properly? Follow the description "Picture Adjustment" on page 18 to try to adjust them properly.
- Videotaping teletext is not recommended because it may not record correctly.
- When viewing images from commercially available video software products, or videos from videotapes which have been recorded improperly, the top of the image may be distorted. This is due to the condition of the video signal. There is nothing wrong with the TV.



Poor sound

- Have you adjusted BASS or TREBLE properly? If not, follow the description "Sound Adjustment" on page 19.

If the TV does not respond to the remote control

- Have the batteries of the remote control worn out? Follow the description "Putting the batteries into the Remote control" on page 5 and replace them with new batteries.
- Have you attempted to use the remote control from the sides or rear of the TV or from more than seven metres away from the TV? Use the remote control in the front of your TV or from less than seven metres away.
- When you are viewing a teletext programme, you cannot operate the menus. Press the  button to return to the ordinary TV programme, and then try operating the menus.
- If the TV suddenly stops responding, disconnect the power cord of the TV from the AC outlet. Connect them to the AC outlet again to turn on the TV. If the TV returns to a normal state, it is not a failure.

Other concerns

- When the SLEEP TIMER function operates, the TV is automatically turned off. If the TV suddenly turns off, try to press the  (standby) button to turn on the TV once again. If the TV goes back to normal, there is no problem.
- When the TV is receiving a wide-screen signal (WSS) or a signal from an external device affecting the screen size, the ZOOM mode automatically changes. When you want to resume the previous ZOOM mode, press the **ZOOM** button again.
- It takes a short period of time from the time an operation such as changing channels is performed until an image is displayed. This is not a malfunction. This is the time required for the image to stabilize before it can be displayed.
- The TV may make a crackling sound due to a sudden change in temperature. The picture or sound may be normal. If you hear crackling sounds frequently while you are viewing the TV, there may be other causes. As a precaution, ask your service technician to inspect it.
- In the twin pictures mode the sub-picture may disappear when the external device is operated. If this happens, press the  button and display the sub-picture again.
- The top of the TV and the screen may become hot during use but this has no affect on the performance of the TV. Ensure that the ventilation holes are not blocked.
- When the picture is unstable, the screen may become white for a moment. This occurs when the signal which drives the liquid crystal is missing. This is not a malfunction.
- When a still image has been displayed for a long period, a faint residual image may remain on the screen for a short time after the power has been turned off or when another image is displayed. This is not a malfunction and the image will eventually disappear.
- When the correct picture has not been displayed on screen, the following error messages will display on screen.
NO SIGNAL - TV recived no signal from PC, you may check your PC is working correctly or not.
CABLE NO INSERT - The cable is not connected correctly. Ensure that the cable is connected correctly.
OUT OF RANGE - The picture resolution is out of limit. Ensure that the PC picture resolution is set correctly.

Specifications

Item	Model	
	LT-17S2	LT-23S2
Broadcasting systems	CCIR B/G, I, D/K	
Colour systems	PAL, SECAM • The EXT terminals also support the NTSC 3.58/4.43 MHz system.	
Channels and frequencies	<ul style="list-style-type: none"> E2-E12, E21-E69, S1-S41, X, Y, Z, Z+1, Z+2, ITALY A-H, ITALY H+1, ITALY H+2, F2-F10, F21-F69, R1-R12, R21-R69, IR A-J French cable TV channel of broadcast frequencies 116 - 172 MHz and 220 - 469 MHz 	
Sound-multiplex systems	A2 (B/G, D/K), NICAM (B/G, I, D/K) system	
Teletext systems	FLOF (Fastext), WST (World Standard System)	
Power requirements	TV : 12V DC, AC adapter : 100 - 240 V AC, 50/60 Hz	TV : 24V DC, AC adapter : 100 - 240 V AC, 50/60 Hz
Power consumption	60 W, Standby: 3 W	120W, Standby: 3 W
Screen size	Viewable area 43.5cm(measured diagonally)	Viewable area 58.2cm(measured diagonally)
Display resolution	1280 X 768 (W-XGA)	
Audio output	Rated Power output: 3 W + 3 W	Rated Power output: 5 W + 5 W
Speakers	5.4 cm round x 2	
VIDEO -1 terminal	<ul style="list-style-type: none"> Video input, S-VIDEO (Y/C) input and Audio L/ MONO and R inputs are available. 	
VIDEO -2 terminal	<ul style="list-style-type: none"> Component Video(Y,Pb,Pr) input and Audio L/MONO and R inputs are available. 	
AUDIO OUT terminal	RCA connectors X 3 <ul style="list-style-type: none"> Audio L/R outputs and a subwoofer output are available. 	
PC IN terminal	Analog RGB : D-SUB (15 pins) x 1, PC AUDIO IN x 1 <ul style="list-style-type: none"> PC signal and audio inputs are available. 	
Headphone jack	Stereo mini-jack (3.5 mm in diameter)	
Dimensions (W x H x D)	465 mm x 325 mm x 78 mm (TV only) 465 mm x 363 mm x 190 mm	619 mm x 436 mm x 86 mm (TV only) 619 mm x 498 mm x 227 mm
Weight	6.1 kg (TV only) 7.3 kg	7.8 kg (TV only) 9.8 kg
Accessories	Remote control unit X 1 (RM-C1860) AA/R6 dry cell battery X 2 AC adapter x 1 (HP-OL060D033) Power cord x 1	Remote control unit X 1 (RM-C1860) AA/R6 dry cell battery X 2 AC adapter x 1 (HP-OW120A034) Power cord x 1

Design and specifications subject to change without notice.

Pictures displayed on the screen using this TV's ZOOM functions should not be shown for any commercial or demonstration purpose in public places (cafes, hotels, etc.) without the consent of the owners of copyright of the original picture sources, as this constitutes an infringement of copyright.

JVC



JVC

Free Manuals Download Website

<http://myh66.com>

<http://usermanuals.us>

<http://www.somanuals.com>

<http://www.4manuals.cc>

<http://www.manual-lib.com>

<http://www.404manual.com>

<http://www.luxmanual.com>

<http://aubethermostatmanual.com>

Golf course search by state

<http://golfingnear.com>

Email search by domain

<http://emailbydomain.com>

Auto manuals search

<http://auto.somanuals.com>

TV manuals search

<http://tv.somanuals.com>