



Presentations of outstanding quality

JVC Professional high definition LCD displays

- GD-F65 L1
- GD-F52 L1
- GD-F46L1
- CO-46LCD-BD
- GM-H40 L2

Complete Solutions for Digital Signage

JVC

The Perfect Experience / —



ACHIEVE
more together

Your competent Partner
for building finance
and private loans

Just drop in!
Building 3A, 1st floor

BORISBank
Trust through performance



The JVC complete solution for digital signage and large screen presentations

Complete hardware and software solution from a single supplier

Digital presentation screens are an efficient information and display medium with a wide range of applications. This state-of-the-art visual presentation system is both dynamic and mobile – and it can reach audiences that have never been reached before. Get your information and message across efficiently. Get it across dynamically. Get it across with digital signage.

JVC Professional offers you not only an extensive range of purpose-designed hardware and software, but also a highly experienced support network with the benefit of having already completed many, many projects. The JVC advantage is that one proven and reliable signage specialist gives you the answers to all the possible questions you could have about the right system for you.

The JVC Professional display range

All JVC Professional's LCDs have one thing in common – they have been developed and produced by professionals and for professionals. Apart from the many innovative user functions and JVC's world-famous reliability, the range offers outstanding picture quality. To be convinced, you only have to look at the images for yourself and then wonder at all the innovative features. Displays do not come better than these professional high definition monitors from JVC.

JVC's software for the dynamic distribution of information



TV-TOOLS digital signage

TV-TOOLS software package is at the heart of every digital signage installation. It ensures that the required message reaches the intended audience at the right time and in the right place. Create added value for all your target groups – whether specific visitors, customers, groups of employees or just the public at large.

Develop and distribute differentiated audio-visual information in real time in different locations – your strategy gives you the flexibility to determine which content, at which location and at what time of day. Customised messages are well received in today's information society!

With TV-TOOLS you also have all the options you need to control and monitor individual display screens and their content on a network-wide basis – the monitoring software is complemented by the power to record and analyse content for the purpose of invoicing advertisers for their time slots. Built-in intelligence and an easy-to-understand program interface leave you with more time for the essentials of signage – namely, content design and – by extension – customer satisfaction.

Electronic posters and animated pictures in your showroom capture attention and heighten your customers' emotions. Academic studies show that digital signage solutions will increase sales by an average of 60% more than classic rigid POS advertising media.

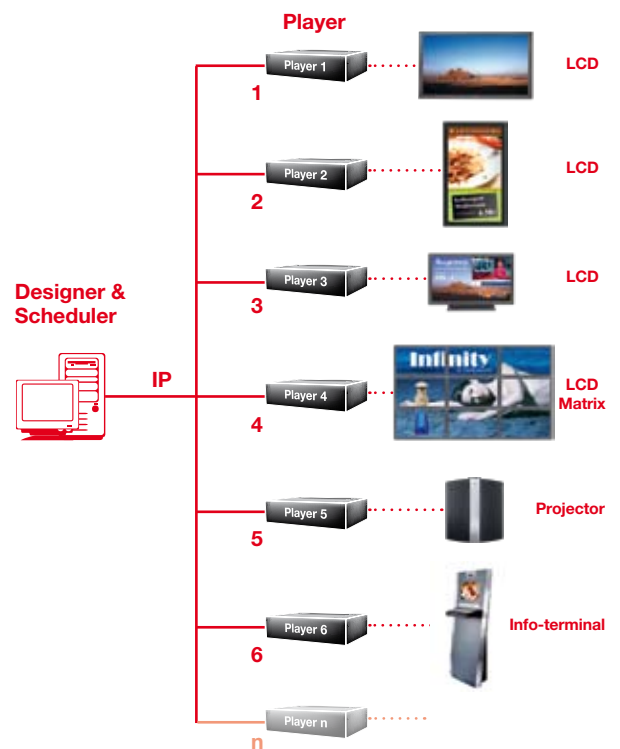
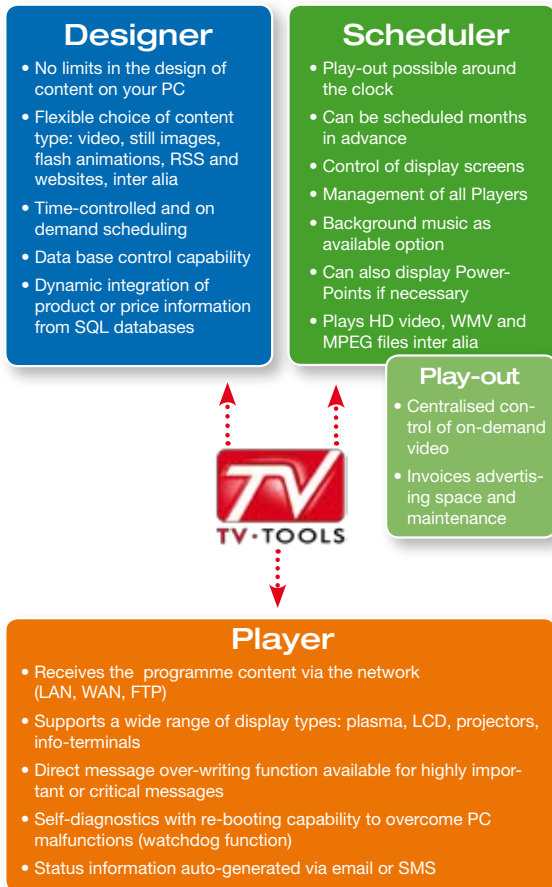

Complete network solution: JVC provides an integrated professional digital signage solution, including software and displays.



Welcome
Stanger Hotel Group wishes you a pleasant stay

Program of todays Technology Cong

- New Future Concept
- 42 Technology Demos
- Technology Auditorium
- WP Lounge
- Lands
- Outdoor I

Travelers Weather

Rome	sunny 14°
Madrid	rains 23°
Lisabon	sunny 28°
Paris	clouds 15°

Welcome
Stanger Hotel Group wishes you a pleasant stay

Program of todays Technology Cong

- New Future Concept
- 42 Technology Demos
- Technology Auditorium
- WP Lounge
- Lands
- Outdoor I

Travelers Weather

Rome	sunny 14°
Madrid	rains 23°
Lisabon	sunny 28°
Paris	clouds 15°



Let your communications be the winner

Build up the excitement in stadiums and other sporting venues

Many sports venue operators have discovered the benefit of using JVC technology to control their dynamic communications from one central point. They can provide fans and VIPs with stimulating commentary on what's happening on and off the field, whilst also offering an intuitive guidance system. It will generate revenue by displaying sponsor advertisements. Besides large sporting events, such systems can also be used in concerts and at corporate events, where they will also ensure a rapid payback.

Commerzbank Arena Frankfurt

Number of displays used	121
Sizes	26" – 46"
Control software	TV-TOOLS
Contents	Guidance system, VIP information, Advertising space



Neuchatel Stadium

Number of displays used	28
Sizes	32" – 40"
Control software	TV-TOOLS
Contents	Guidance system, Crowd information, Game statistics





Think globally, act locally – It's easy with JVC

Sanofi Aventis – France

Sanofi Aventis, a pharmaceutical multinational based in France, has just started using digital signage to communicate the latest events in a consistent way to employees in all 12 of its French plants. It was essential for the company to deploy a dynamic system so as not to interrupt the plants' normal production operations.

Sanofi defined three types of information to be communicated through the system: business, leisure and locally relevant data. Their chosen system: JVC's TV-TOOLS all-in-one solution. One of the TV-TOOLS features most valued by the company is the ability, based on central permissions, to enter content locally to supplement the nationwide information program. This allows local human resource departments to display health and safety messages that relate specifically to their own plant. Sanofi Aventis' entire installation in France consists of 80 playout screens as well as ten Designer and Scheduler stations.



Pharmaceutical manufacturer Sanofi Aventis

Number of displays used	80	
Design/Scheduler locations	10	
Connection	LAN and W-LAN	
Control software	TV-TOOLS	
Contents	Corporate data, Health & safety info	



Creative, impressive, flexible – Use the opportunities available to you

We've got the right solution for you

No matter where, no matter how – JVC Professional technology will always keep you informed. Benefit from dynamic, animated communication from JVC Professional display systems.

Point of Sale



Over half of all buying decisions are made at the point of sale. The signage gets the customers' attention in a targeted fashion and encourages them to buy certain products. Price reductions can be implemented quickly and easily. Digital signage is already the commercial language of the future.

Security



JVC Professional display systems are ideally suited for security systems and security monitoring. Several pictures can be featured at the same time in perfect picture quality on the big screens. Connecting up several surveillance cameras in combination with the PIP or Pbp functions⁽¹⁾ make it possible to create a professional security system, performing even sophisticated surveillance tasks.

Foyers and waiting areas



Displays create a positive impression in large and spacious foyers and entrance halls. Even the usual waiting period at the doctor's can be made much more acceptable by the accurate targeting of so-called infotainment. A direction finder helps visitors quickly and efficiently to get where they need to be.

Hotels, restaurants and canteens



Digital signage is the ideal tool to provide a smart looking list of that day's activities and functions. In company canteens it can recommend the dish of the day and can also tell employees about the latest company news and events. This makes for highly effective company communication.



CAD



The professional JVC signage system within the CAD function creates working conditions which will achieve optimal results. CAD designers can develop their products and produce 3D displays and drawings to a high technical standard, because the finest of lines and the minutest of details get displayed thanks to the unsurpassed high definition quality.

Trade fairs, conference centres, malls



The all-in-one solution makes it easier to find one's way in large, open public spaces such as exhibition halls, conference centres and shopping malls. Whether used for location finding or event information, the display lets you reach visitors quickly and efficiently. The ambient light control function (ALC)⁽²⁾ on the display also ensures the right level of picture brightness and brings energy savings with it.

Museums











Large rooms require large presentations. The JVC signage system draws attention in a creative manner to the major exhibits within of an art gallery or simply provides general visitor information. Used as a location finder, visitors can quickly find their way around the museum. The neutral shade of the black aluminium bezel blends gracefully in with any interior.

Video conferencing



Ideally suited for use at video conferences. The design programme will provide optimal space for important content – and with excellent picture quality. The PIP and PnP⁽¹⁾ modes allow flexible arrangement of different simultaneous video pictures.

⁽¹⁾ see page 11 ⁽²⁾ only CO-46LCD-BD

Feature Model	GD-F65L1	GD-F52L1	GD-F46L1	CO-46LCD-BD	GM-H40L2
Screen size 	65"	52"	46"	46"	40"
Full HD 	●	●	●	○	○
Portrait /Landscape 	○	●	●	○	●
Multiscreen matrix 	●	●	●	●	●
PiP/PbP 	●	●	●	●	●
RS-232C 	●	●	●	●	●
ALC 	○	○	○	●	○
24/7 operation 	●	●	●	○	●
Metal cabinet	●	●	●	●	○
Scheduling function 	●	●	●	●	●
Signal detection	●	●	●	●	●
Unbranded	○	○	○	●	○

● yes ○ no ◐ on request

Features

Professional functions with user settings

Multiscreen matrix

Ideally suited for impressive graphic displays. Delight your audiences with displays in corridors or life-sized screens in the foyer. A combination of up to 25 (5x5) screens in an image-wall brings about extensive presentation opportunities. The centralised, monitored signal distribution of TV-TOOLS ensures constant picture quality and maximum operating stability.



Multiscreen matrix: one large display through the synchronised use of several monitors (up to 25).

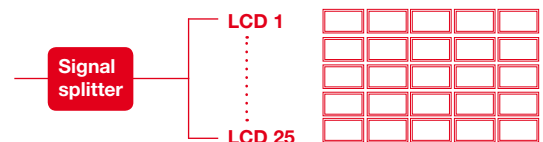

The multiscreen matrix is managed by a separate signal splitter, thus providing the added advantage of increased operational stability.

Portrait and landscape formats

Depending on the content to be displayed, the monitors may be installed in vertical or horizontal format.* The portrait format is especially suitable for display boards and guidance systems, while the landscape format is ideal for video conferencing and promotions.

* GD-F65L1 and CO-46LCD-BD are Landscape only

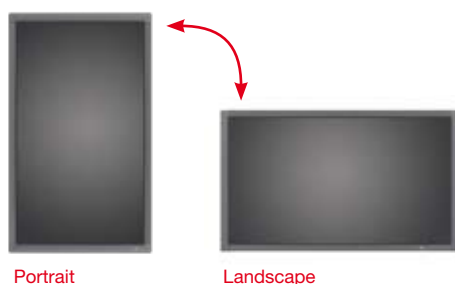

Full HD – imaging at its sharpest

JVC professional displays⁽¹⁾ provide perfect picture quality in 1,920 x 1,080 full HD resolution. See it to believe it.

⁽¹⁾ applies to GD-F65L1, GD-F52L1 and GD-F46L1

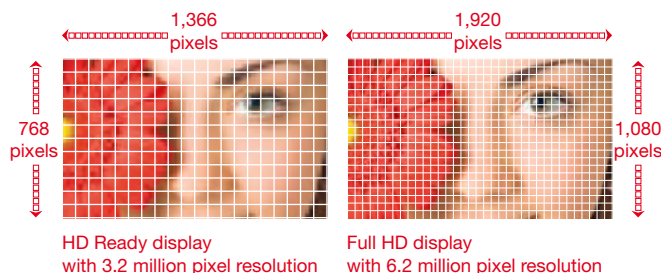

ALC (Ambient light control)



Automatic brightness control⁽²⁾ operates via a light sensor to ensure optimal adjustment of the image parameters to suit ambient conditions at all times. The advantages are:

Optimised legibility in varying light conditions. Energy savings of up to 60%, providing lower TCO (Total cost of ownership).

ALC can be switched off to allow manual adjustment.

⁽²⁾ only with CO-46LCD-BD

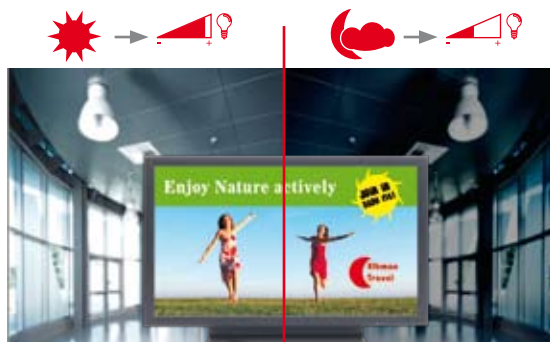

Ambient Light Control

Professional RS-232 interface

All these JVC monitors can be externally controlled via wired serial interface. Using RS-232 protocol means that all widely available remote control systems can be directly interfaced.

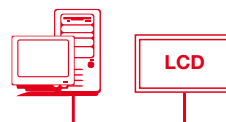

Central control via the universal RS-232 interface

Flexible image management

Images from digital sources can be input through the Picture in Picture (PiP) and Picture by Picture (PbP) functions. This can be both an attractive and effective way to display information.



Picture in Picture (PiP) Mode

Robust metal alloy cabinet – very light

Black anodised aluminium housing with VESA mountings emphasise the high-quality design and build. Light for easy transportation and rapid installation. Omission of the manufacturer's logo⁽³⁾ makes for a brand-neutral installation.

⁽³⁾ only with the CO-46LCD-BD, other displays on request

Scheduling function



With the help of this function the user can set the time of the automatic „on“ and „off“ mode and thereby save energy.

Signal detection

JVC Professional LCD monitors immediately detect and adjust themselves to the incoming signals.



Having VESA fixing points means a wide range of wall mountings and desktop stands are available.
Shown: Wall mount PE-100682-VESA

GD-F65L1

65" professional full HD, LCD display (landscape)

- Ideal for digital signage application with TV-Tools.
- Full HD resolution, 1080p (1,920 x 1,080 pixels)
- Multiscreen matrix with combination options of up to 25 (5x5) screens – 2x2, 3x3, 4x4 and 5x5.
- Professional RS-232 serial interface.
- 24/7 continuous operation, with up to 50,000 hours typical life for the back-light unit.
- A black anodised aluminium cabinet provides maximum protection.

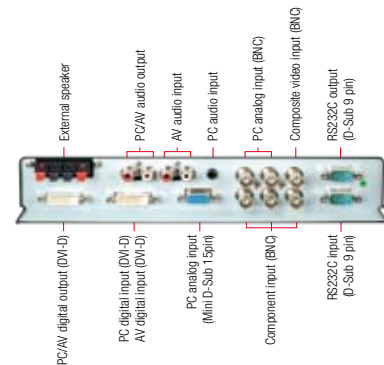
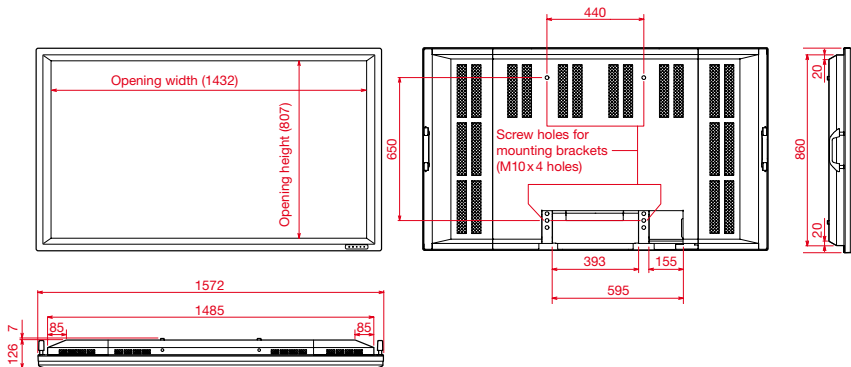

GD-F52L1

52" professional full HD, LCD display (landscape and portrait)

- Ideal for digital signage application with TV-Tools
- Full HD resolution, 1080p (1,920 x 1,080 pixels)
- Multiscreen matrix with combination options of up to 25 (5x5) screens – 2x2, 3x3, 4x4 and 5x5.
- Professional RS-232 serial interface.
- 24/7 continuous operation, with up to 50,000 hours (landscape) and 30,000 hours (portrait) typical life for the back-light unit.
- A black anodised aluminium cabinet provides maximum protection.

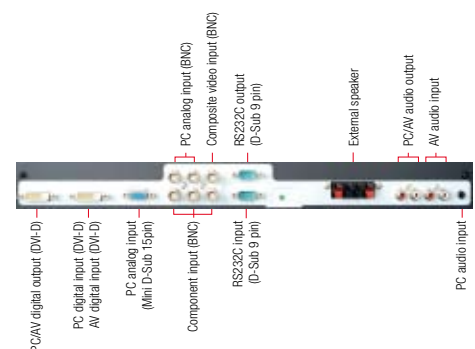
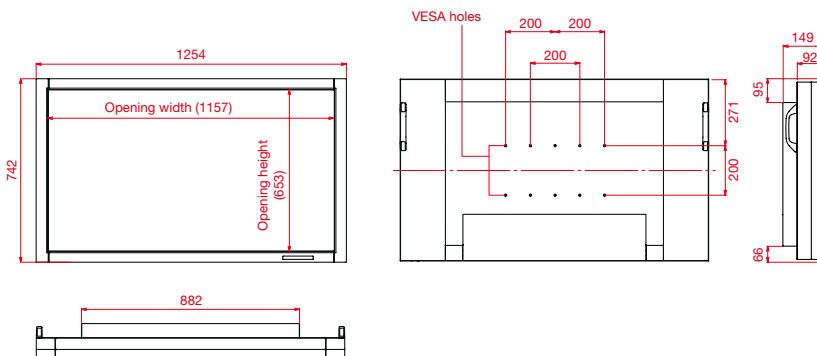
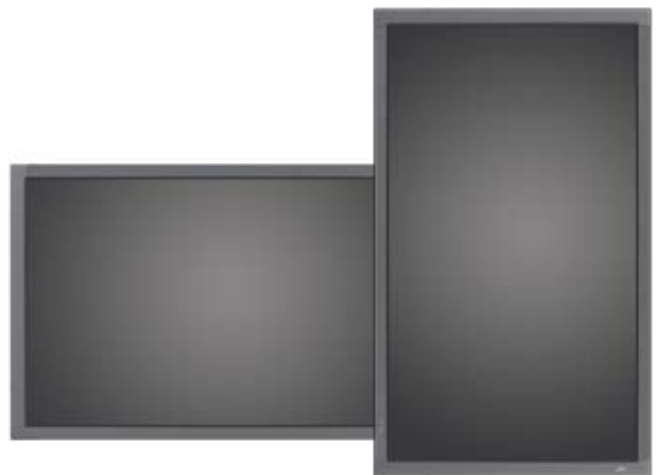

GD-F46L1

46" professional full HD, LCD display (landscape and portrait)

- Ideal for digital signage application with TV-Tools
- Full HD resolution, 1080p (1,920 x 1,080 pixels)
- Multiscreen matrix with combination options of up to 25 (5x5) screens – 2x2, 3x3, 4x4 and 5x5.
- Professional RS-232 serial interface.
- 24/7 continuous operation, with up to 50,000 hours (landscape) and 30,000 hours (portrait) typical life for the back-light unit.
- A black anodised aluminium cabinet provides maximum protection.

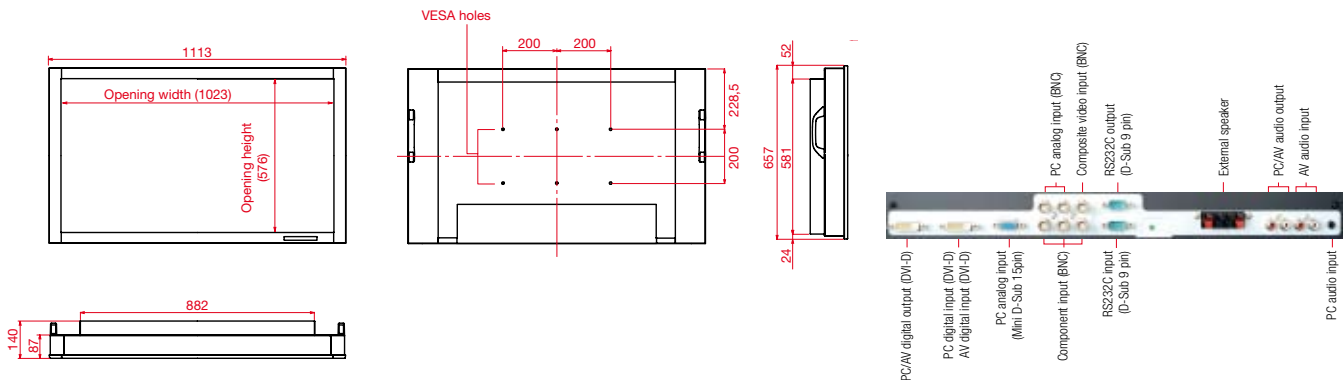
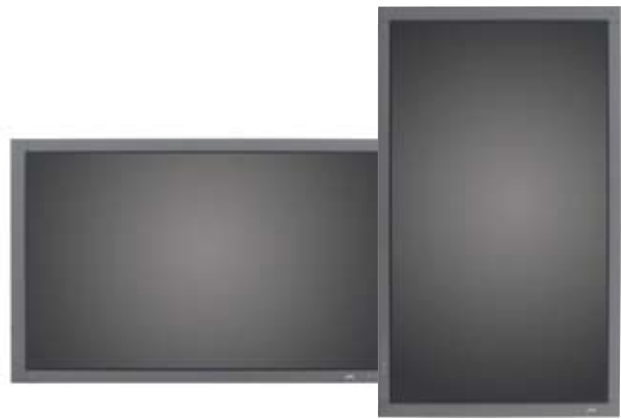

CO-46LCD-BD

46" professional LCD display (landscape)

- Ideal for digital signage use with TV-Tools.
- Multiscreen matrix with combination options of up to 16 (4x4) screens – 2x2, 2x3, 3x2, 3x3, 3x4, 4x3 and 4x4.
- Professional RS-232 serial interface.
- Picture optimisation for ambient light conditions (ALC) ensures best quality pictures and saves up to 60% on energy costs.
- 15 hours' operation per day.
- Aluminium cabinet provides maximum protection at minimum weight

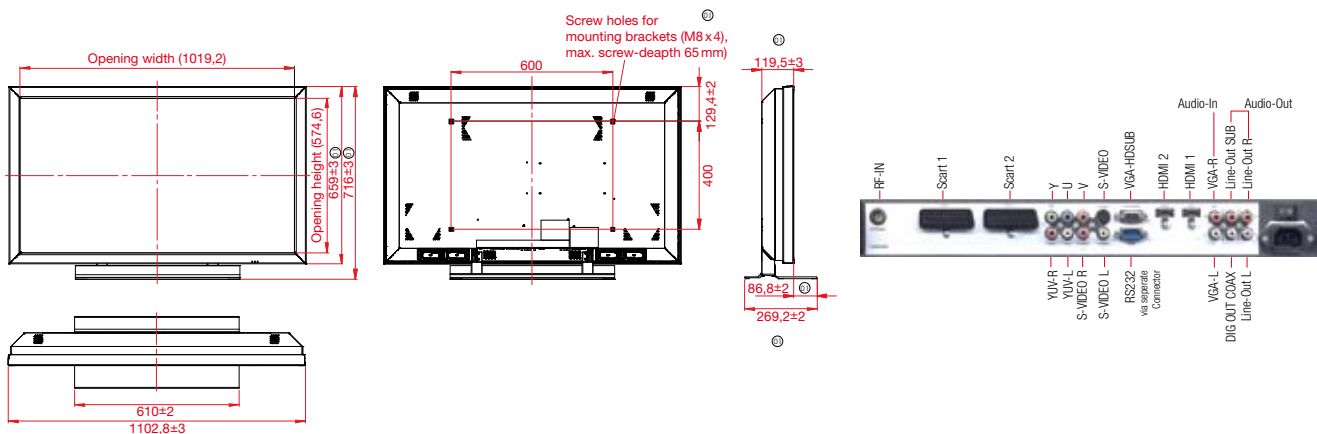

GM-H40L2



40" professional LCD display (landscape and portrait)

- Ideal for digital signage application with TV-Tools
- Housing design for flush wall-mounting, cooling by means of a side-mounted vents.
- Wide selection of input and control connections.
- Easily removable front bezel for colour change.
- Highly effective anti-burn-in systems and circuitry.
- Self-diagnosis with indicator lights.
- Anti-theft device.
- Ambient light sensor for automatic brightness adjustment and energy saving
- Rapid switching between inputs

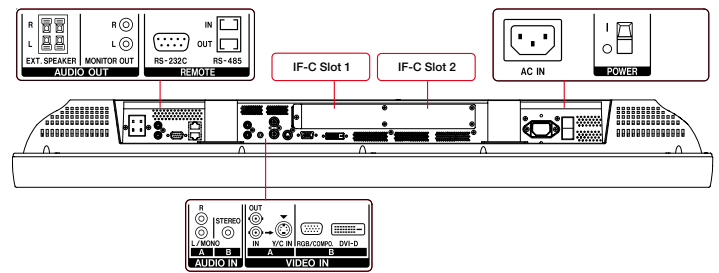
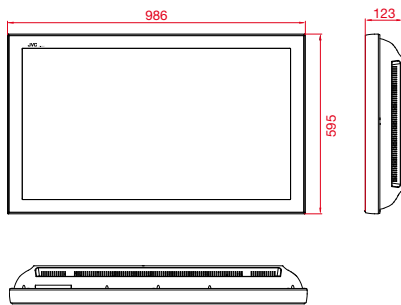

Specifications



Model	GD-F65L1	GD-F52L1	GD-F46L1	CO-46LCD-BD	GM-H40L2
Screen					
Alignment	Landscape	Landscape/Portrait	Landscape/Portrait	Landscape	Landscape/Portrait
Screen size	65"	52"	46"	46"	40"
Height to width ratio	16:9	16:9	16:9	16:9	16:9
Resolution	1,920x1,080 pixel (Full HD)	1,920x1,080 pixel (Full HD)	1,920x1,080 pixel (Full HD)	1,366x768 pixel	1,366x768 pixel
Display colours	16.7 million colours (8 bit)	16.7 million colours (8 bit)	16.7 million colours (8 bit)	16.7 million colours (8 bit)	16.7 million colours (8 bit)
Viewing angle	176° typical	176° typical	176° typical	178° typical	170° typical
Contrast	2000:1 typical	1700:1 typical	1700:1 typical	1200:1 typical/ 5.000:1 dynam.	1.000:1
Brightness	450 cd/m ² max.	TBA	450 cd/m ² max.	500 cd/m ² max.	400 cd/m ² max.
Video Standards					
Video	PAL/SECAM/NTSC	PAL/SECAM/NTSC	PAL/SECAM/NTSC	PAL/SECAM/NTSC	PAL/SECAM/NTSC, PAL60, NTSC 4.43, PAL-M, PAL-N
TV tuner (can be de-activated*)				PAL (BG, DK, I)/SECAM (BG, DK, L), 47-861 MHz (VHF, UHF, Hyperband)	
Inputs / Terminals					
PC/Video input Analogue sub-D 15-pin	VGA to HD1080	VGA to HD1080	VGA to HD1080	VGA to UXGA	VGA to UXGA
PC-video input digital	HDMI	-	-	HDCP HDTV 480p, 576p, 720p, 1080i/VGA bis UXGA	-
	DVI	HDCP HDTV 480p, 576p, 720p, 1080i/VGA to HD1080	HDCP HDTV 480p, 576p, 720p, 1080i/VGA to HD1080	HDCP HDTV 480p, 576p, 720p, 1080i/VGA to HD1080	VGA to UXGA (kein HDCP)
Loop-through option	DVI: Yes	DVI: Yes	DVI: Yes	-	CVBS Analogue RGB optional*

Model	GD-F65L1	GD-F52L1	GD-F46L1	CO-46LCD-BD	GM-H40L2
Inputs/Terminals					
Video terminals	1xDVI (HDCP) 1xRGB/HV 1xCVBS 1xYUV	1xDVI (HDCP) 1xRGB/HV 1xCVBS 1xYUV	1xDVI (HDCP) 1xRGB/HV 1xCVBS 1xYUV	2xSCART 2xHDMI (HDCP) 1xY/C 1xYUV 1xCVBS 1xRGB/HV	1xY/C or CVBS 1xRGB/HV oder 1xYUV 1xDVI More inputs through optional boards (see below)
TV tuner (can be de-activated*)	No	No	No	Yes	No
Audio IN	PC: 3.5 mm jack AV: chinch	PC: 3.5 mm jack AV: chinch	PC: 3.5 mm jack AV: chinch	PC/AV: chinch	PC: 3.5mm jack AV: chinch
Audio OUT	Chinch	Chinch	Chinch	1x digital audio 2x analogue chinch	Chinch
Loudspeaker input	10W+10W (6 Ohm)	7W+7W (6 Ohm)	7W+7W (6 Ohm)	Subwoofer Line OUT / SPDIV OUT	4.4 W, 6 Ohm
Integrated loudspeaker	(7 x 7 cm), 6 Ohm	(7 x 7 cm), 6 Ohm	(7 x 7 cm), 6 Ohm	4 x broadband	2 x (4 x 7 cm, oval), 3.4 W
IR control	Yes	Yes	Yes	Yes	Yes
Manual control	No	No	No	No	Yes
External serial control	RS-232C (IN-OUT)	RS-232C (IN-OUT)	RS-232C (IN-OUT)	RS-232C (IN)	RS-232C (IN)

Functions					
Operating functions multilingual	Yes (7)	Yes (7)	Yes (7)	Yes (10)	Yes (5)
Multiscreen	Video	-	-	max. 3x3	max. 2x2
	PC	max. 5x5	max. 5x5	max. 4x4	max. 2x2
Timer function	Yes	Yes	Yes	Yes	Yes
Screen-saver function	Yes	Yes	Yes	Yes	Yes
Inverse picture function	180° picture reversal	180° picture reversal	180° picture reversal	No	No
Cooler	No	No	No	No	Yes
Central mains switch	Yes	Yes	Yes	Yes	Yes

Operating Conditions					
Temperature	0° C to + 40° C (operation), -20° C to +60° C (in storage)	0° C to + 40° C (operation), -20° C to +60° C (in storage)	0° C to + 40° C (operation), -20° C to +60° C (in storage)	0° C to + 40° C (operation), -20° C to +60° C (in storage)	0° C to + 40° C (operation), -20° C to +60° C (in storage)
Humidity	20% to 80% (non-condensing)	20% to 80% (non-condensing)	20% to 80% (non-condensing)	20% to 65% (non-condensing)	20% to 80% (non-condensing)
Operating time	24/7	24/7	24/7	15	24/7

Mains Data					
Power supply	100/240V AC	100/240V AC	100/240V AC	115/230V AC	220/240V AC
Mains frequency	60/50Hz +/- 6%				
Power consumption	550W	TBA	266W	320W typical, <=0.6W in stand-by mode	330W

Net dimensions / Net weight					
HxWxD weight	923 x 1572 x 126 mm +/- 3 mm 65 kg +/- 10% (without stand)	(880 x 1390 x 385 mm) +/- 3 mm 44 kg +/- 10% (without stand)	(657 x 1113 x 140 mm) +/- 3 mm 35.5 kg +/- 10% (without stand)	(659 x 1103 x 119 mm) +/- 3 mm 23.3 kg +/- 10%	(595 x 986 x 123 mm) +/- 3 mm 26.8 kg +/- 10% (without stand)

General	
Housing	Aluminium alloy cabinet
Installation	VESA fixings built-in

Accessories		
Supplied as standard	Infra-red remote control incl. batteries, mains cable, desktop stand and operating instructions	
Optional: Wall mount	PE-100347-65L1 (Landscape only)	PE-100682-VESA (Landscape only)
	Landscape: PE-100245-52LH Portrait: PE-100245-52LV	Landscape: PE-100202-46LH Portrait: PE-100202-46LV
		TS-CV20WG Landscape and portrait

* GEZ acceptance must be obtained by the user.

GM-H40 L2 optional IF-C boards		
<p>IF-CF01RBG component/RGB active-through</p> <p>Input: Stereo, Y/G, PB/CB B, PR/CR R, HD/CS, VD</p> <p>Buffer OUT: Stereo, Y/G, PB/CB B, PR/CR R, HD/CS, VD</p> <ul style="list-style-type: none"> Optional IF-C unit for active-through input of analogue component signals Superb image display of up to UXGA in native resolution Compatible with 15K analogue RGB signal 	<p>IF-CF01CMG component/RGB</p> <p>Input: Stereo, Y/G, PB/CB B, PR/CR R, HD/CS, VD</p> <ul style="list-style-type: none"> Optional IF-C unit for input of analogue RGB and analogue component signals Superb image display of up to UXGA in native resolution Compatible with 15K analogue RGB signal 	<p>IF-CF21HDG HD/SD SDI with embedded audio</p> <p>OUT: R CH, L CH, IN 2, IN 1</p> <p>IN: R CH, L CH, IN 2, IN 1</p> <ul style="list-style-type: none"> SDI signal chain connection capability via bridge out Embedded audio bridged out 1080/14psF, 1080/24p and 1080/30p compatibility



TV-TOOLS



Highlights

- Real time multi-media display system with optimised syncs for really smooth transitions, video effects and animations
- The creation module, Designer, makes it easy to combine all different types of AV material
- The point on the network from which the different displays are controlled and scheduled can be different from the point of creation and located anywhere on a network because the Designer, Scheduler and Player modules all operate independently
- Different display programmes can be handled simultaneously and be scheduled months in advance
- The system can support more than one Designer station and can all be operated simultaneously
- Changes to content are transmitted invisibly at the same time as the regular transmission to the player. The network's bandwidth is protected by sending only the new or changed elements
- High level of secure communication on account of single selectable TCP port
- Infinite possibilities for scheduling ahead by date and by display programme
- Creation and management of the play-out clusters
- Control monitor can be connected to the Player PC
- Real time messaging overlays the play-out programme
- Live incorporation of data updates, all in real time
- Several players can receive update data simultaneously by using FTP servers
- Programme content can be changed locally at Player PC, but only with the necessary permissions being securely granted by central control
- Possibility also to put limited periods of scheduling under local control
- Remote control of playout devices which are equipped with RS-232C control interface

Compatibility

- Graphics: BMP, GIF, IFF, JPEG, PCX, PNG, Targa, TIFF, WMF
- Animation: TGA, Flash, AVI, Quicktime, GIF
- Audio: WAV, MP3, MIDI, CD Audio
- Video: MPEG-1, MPEG-2, MPEG-4, DivX, WMV WM9 Windows Media Video and AVI
- Fonts: TrueType®



Design and specifications subject to change without notice. All brand or product names may be trademarks and/or registered trademarks of their respective owners. Any rights not expressly granted herein are reserved. All illustrations in monitors and displays in this catalogue are simulated. Copyright © 2007, JVC Professional Europe. All rights reserved.

JVC Professional Europe Limited ■ www.jvcpro.eu

JVC
The Perfect Experience

Free Manuals Download Website

<http://myh66.com>

<http://usermanuals.us>

<http://www.somanuals.com>

<http://www.4manuals.cc>

<http://www.manual-lib.com>

<http://www.404manual.com>

<http://www.luxmanual.com>

<http://aubethermostatmanual.com>

Golf course search by state

<http://golfingnear.com>

Email search by domain

<http://emailbydomain.com>

Auto manuals search

<http://auto.somanuals.com>

TV manuals search

<http://tv.somanuals.com>