



PLASMA DISPLAY MONITOR

GM-X50U

INSTRUCTIONS

For Customer Use:

Enter below the Model No. and the Serial No. which is located on the rear panel of the cabinet. Retain this information for future reference.

Model No. _____

Serial No. _____

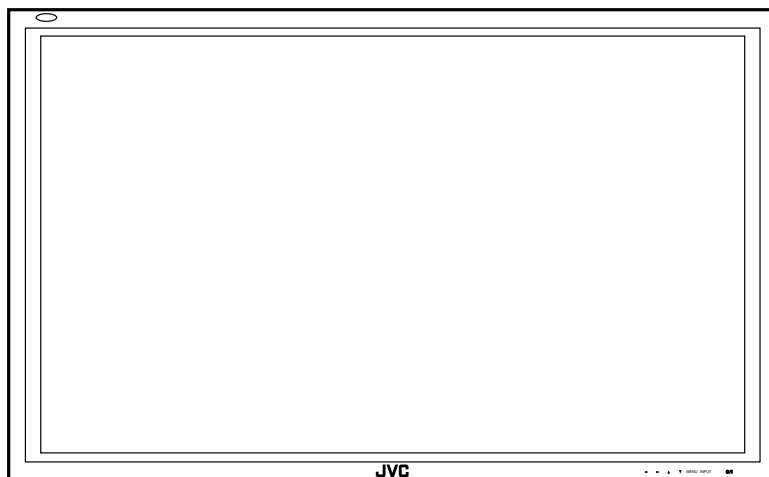



INSTRUCTIONS

Model
GM-X50U

*Thank you for purchasing this JVC Monitor.
Before using the monitor, read this manual carefully so that you know how to use the Monitor correctly.
Refer to this manual whenever questions or problems about operation arise. Be sure to read and observe the safety precautions.
Keep this manual where the user can see it easily.
* Installation and removal require special expertise.
Consult your product dealer for details.*

Contents

	Page		Page
Safety Precautions	2	Other Convenient Functions	22
Parts Identification	4	• Showing On-screen Display	22
• Monitor: Front View	4	• Showing the On-screen When Changing	
• Monitor: Rear Views ①	5	the Input Mode	23
• Monitor: Rear Views ②	6	• Prohibiting the Monitor's Button Operations	23
• Remote Control	7	• Setting the Remote-Controllable Input	24
Preparations	8	• Setting the High-Definition Signal Types	24
• Checking the Accessories	8	• Setting the Speed of the Internal Cooling Fan ..	25
• Installing the Batteries	8	• Adjusting the White Balance	25
• About the Supplied Ferrite Core	8	• Setting the Clock and the Power On/Off	
Installation	9	Timer	26
• Precautions	9	• Using the Pixel Shift Function	28
Connections	10	• Using the Power Save Function	28
• Precautions	10	• Preventing the Afterimage Effect	28
• Available Signals	10	• Refreshing the Screen	29
• Connection Diagrams	11	• Resetting All the Setup Menu Settings	30
• Connecting an External Control Unit	12	• Resetting All the Menu Settings	31
• External Speaker Connection	13	• Confirming the Use Time and Model Information ...	31
• Connecting the External Cooling Fan Unit	13	Menu Classifications	32
Basic Operations	14	• Main Menu	32
• Daily Operations	14	• Setup Menu	34
• Changing the Aspect Ratio	15	Troubleshooting	36
Video Adjustments	16	• Self-diagnostic Indication	37
• Adjusting the Picture Quality	16	Specifications	38
• Adjusting the Screen Size and Position	17		
• Adjusting the Color Temperature	19		
• Changing the Aspect Ratio	19		
• Setting the Receivable Signal Types	20		
• Setting the COMPONENT/RGB B Input	20		
• Changing the Resistance of the RGB B Input			
Terminals	21		
• Resetting the Function Selection Menu Settings	21		

Safety Precautions

FCC NOTICE

CAUTION: Changes or modifications not approved by JVC could void the user's authority to operate the equipment.

NOTE: This equipment has been tested and found to comply with the limits for a Class A digital device, pursuant to Part 15 of the FCC Rules. These limits are designed to provide reasonable protection against harmful interference when the equipment is operated in a commercial environment. This equipment generates, uses, and can radiate radio frequency energy and, if not installed and used in accordance with the instruction manual, may cause harmful interference to radio communications.

Operation of this equipment in a residential area is likely to cause harmful interference in which case the user will be required to correct the interference at his own expense.

IMPORTANT INFORMATION

WARNING: TO REDUCE THE RISK OF FIRE AND ELECTRIC SHOCK, DO NOT EXPOSE THIS PRODUCT TO RAIN OR MOISTURE.

IMPORTANT SAFEGUARDS

Electrical energy can perform many useful functions. This unit has been engineered and manufactured to assure your personal safety. But **IMPROPER USE CAN RESULT IN POTENTIAL ELECTRICAL SHOCK OR FIRE HAZARD**. In order not to defeat the safeguards incorporated into this product, observe the following basic rules for its installation, use and service. Please read these "Important Safeguards" carefully before use.

- All the safety and operating instructions should be read before the product is operated.
- The safety and operating instructions should be retained for future reference.
- All warnings on the product and in the operating instructions should be adhered to.
- All operating instructions should be followed.
- Unplug this product from the wall outlet before cleaning. Do not use liquid cleaners or aerosol cleaners. Use a damp cloth for cleaning.
- Use a vacuum cleaner to get rid of the dust around the intakes (all the openings) on the rear. If a vacuum is not available, use a cloth and wipe it off. Failure to do so will cause internal heat buildup and, therefore, cause damage to the product.
- Do not use attachments not recommended by the product manufacturer as they may be hazardous.
- Do not use this product near water. Do not use immediately after moving from a low temperature to high temperature, as this causes condensation, which may result in fire, electric shock, or other hazards.
- Do not place this product on an unstable cart, stand, or table. The product may fall, causing serious injury to a child or adult, and serious damage to the product. The product should be mounted according to the manufacturer's instructions, and should use a mount recommended by the manufacturer.

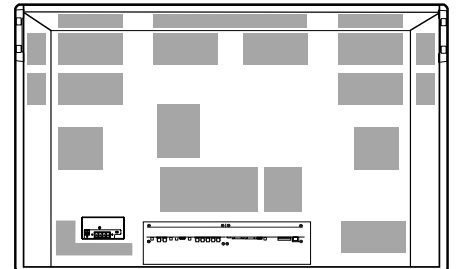

- When the product is used on a cart, care should be taken to avoid quick stops, excessive force, and uneven surfaces which may cause the product and cart to overturn, damaging equipment or causing possible injury to the operator.
- Slots and openings in the cabinet are provided for ventilation. These ensure reliable operation of the product and protect it from overheating. These openings must not be blocked or covered. (The openings should never be blocked by placing the product on bed, sofa, rug, or similar surface. It should not be placed in a built-in installation such as a bookcase or rack unless proper ventilation is provided and the manufacturer's instructions have been adhered to.)
For proper ventilation, separate the product from other equipment, which may prevent ventilation and keep distance more than 10 cm (3 ¹⁵/₁₆ inches).
- This product should be operated only with the type of power source indicated on the label. If you are not sure of the type of power supply to your home, consult your product dealer or local power company.
- This product is equipped with a three-wire plug. This plug will fit only into a grounded power outlet. If you are unable to insert the plug into the outlet, contact your electrician to install the proper outlet. Do not defeat the safety purpose of the grounded plug.
- Power-supply cords should be routed so that they are not likely to be walked on or pinched by items placed upon or against them. Pay particular attention to cords at doors, plugs, receptacles, and the point where they exit from the product.
- For added protection of this product during a lightning storm, or when it is left unattended and unused for long periods of time, unplug it from the wall outlet and disconnect the cable system. This will prevent damage to the product due to lightning and power line surges.
- Do not overload wall outlets, extension cords, or convenience receptacles on other equipment as this can result in a risk of fire or electric shock.
- Never push objects of any kind into this product through openings as they may touch dangerous voltage points or short out parts that could result in a fire or electric shock. Never spill liquid of any kind on the product.
- Do not attempt to service this product yourself as opening or removing covers may expose you to dangerous voltages and other hazards. Refer all service to qualified service personnel.
- Unplug this product from the wall outlet and refer service to qualified service personnel under the following conditions:
 - a) When the power supply cord or plug is damaged.
 - b) If liquid has been spilled, or objects have fallen on the product.
 - c) If the product has been exposed to rain or water.
 - d) If the product operated normally by following the operating instructions. Adjust only those controls that are covered by the Operation Manual, as an improper adjustment of controls may result in damage and will often require extensive work by a qualified technician to restore the product to normal operation.
 - e) If the product has been dropped or damaged in any way.
 - f) When the product exhibits a distinct change in performance – this indicates a need for service.
- When replacement parts are required, be sure the service technician has used replacement parts specified by the manufacturer or with same characteristics as the original part. Unauthorized substitutions may result in fire, electric shock, or other hazards.
- Upon completion of any service or repairs to this product, ask the service technician to perform safety checks to determine that the product is in proper operating condition.
- The product should be placed more than 30 cm (11 ¹⁵/₁₆ inches) away from heat sources such as radiators, heat registers, stoves, and other products (including amplifiers) that produce heat.
- When connecting other products such as VCR's, and personal computers, you should turn off the power of this product for protection against electric shock.
- Do not place combustibles behind the cooling fan. For example, cloth, paper, matches, aerosol cans or gas lighters that present special hazards when over heated.
- Use only the accessory cord designed for this product to prevent shock.
- ⚠ Option terminal: This terminal is intended exclusively to be used to drive the fan motor.
Do not connect any plugs to the terminal other than JVC's recommended optional parts.

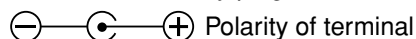

POWER CONNECTION

The power supply voltage rating of this product is AC 120 V.
Do not use other power cords than the power cord attached to this unit.

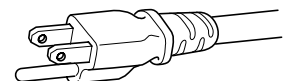

For U.S.A. and Canada: AC 120 V

Parts Identification

Monitor: Front View

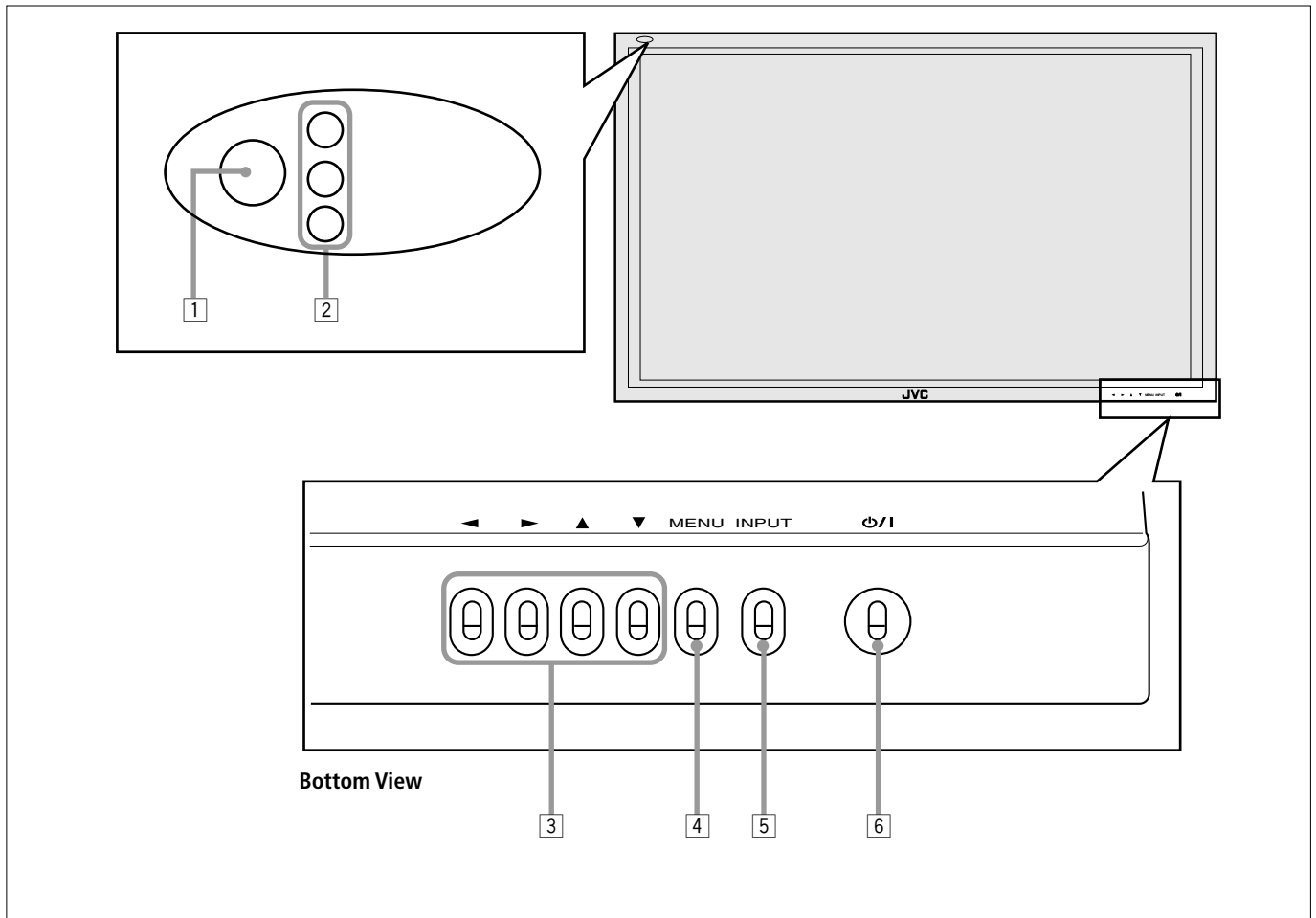

1 Remote sensor/power lamp

Point the front end of the wireless remote control toward here.

When the Monitor is turned on, the power lamp glows green. It glows orange in standby mode.

2 Self-diagnostic lamps (page 37)

These lamps light/flash if something abnormal occurs with the Monitor.

3 ◀ / ▶ / ▲ / ▼ buttons

Use these buttons to select menu items and to make adjustments.

- When no menu is displayed, you can use the ◀ / ▶ buttons to adjust the volume level.

4 MENU button

Use this button to display or erase menus.

While a sub-menu is displayed, pressing this button will move you one screen back to the preceding menu.

5 INPUT button (page 14)

Use this button to switch between inputs.

To select the COMPONENT or RGB B input, you have to set "COMPO./RGB B" correctly on the menu (see page 20).

6 ⏻/⏻ button (page 14)

Use this button to turn on and off (on standby) the Monitor when the POWER switch on the rear of the Monitor is "I (on)."

Monitor: Rear Views ①

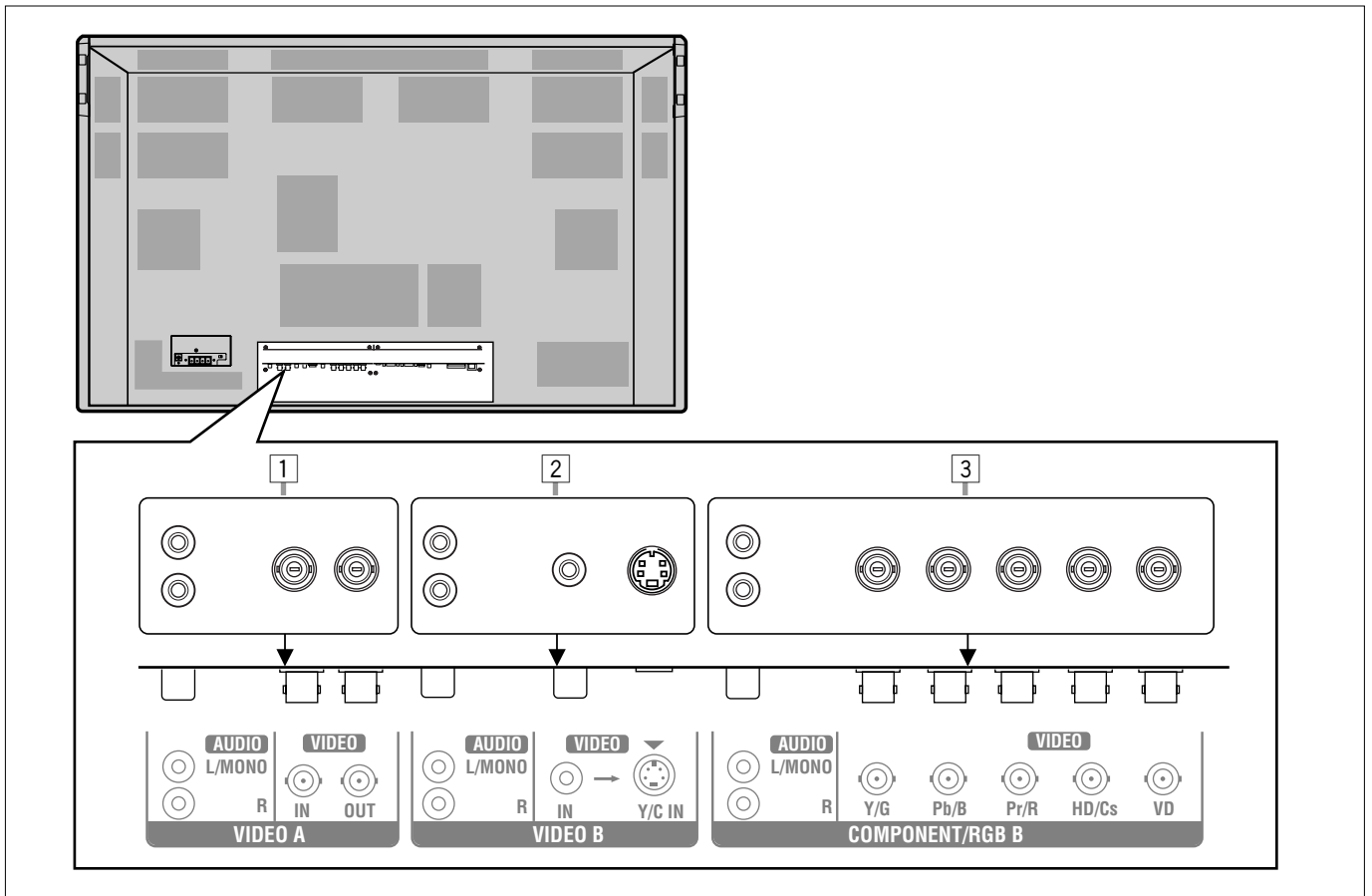

① VIDEO A terminals (page 11)

AUDIO (L/MONO, R) input terminals (pin jack)
Connect these terminals to the audio input terminals of a VCR, etc.

VIDEO IN terminal (BNC)
Connect this terminal to the video output terminal of a VCR, etc.

VIDEO OUT terminal (BNC)
Connect this terminal to the video input terminal of another monitor, etc.

Note:

- Since the video output terminals on this Monitor are loop-through terminals, the devices connected to this video output terminal should be correctly terminated. Otherwise, pictures become abnormally bright or the Monitor screen gets affected abnormally.

② VIDEO B terminals (page 11)

AUDIO (L/MONO, R) input terminals (pin jack)
Connect these terminals to the audio output terminals of a VCR, etc.

Y/C (S video) IN terminal (mini DIN 4pin)
Connect this terminal to the S-video output terminal of a VCR, etc.

VIDEO IN terminal (pin jack)
Connect this terminal to the video output terminal of a VCR, etc.

Note:

- When both the video and S-video terminals are connected, the S-video terminal will have priority.

③ COMPONENT/RGB B input terminals (page 11)

AUDIO (L/MONO, R) input terminals (pin jack)
Connect these terminals to the audio output terminals of the other equipment.

G, B, R, HD/Cs, VD (VIDEO) input terminals (BNC)
Connect these terminals to the following output terminals of a personal computer or other equipment:

- Analog RGB signal output terminals
- Horizontal sync (HD) signal or composite (Cs) signal output terminal
- Vertical sync (VD) signal output terminal

Notes:

- External sync signals are automatically detected when they come in.
- When both horizontal (HD)/vertical (VD) sync and composite (Cs) sync are connected, HD/VD sync signals will be used.

Y, Pb, Pr (VIDEO) input terminals (BNC)

Connect these terminals to the component signal output terminals of NTSC or high-vision equipment.

Note:

- When these terminals are used as the component terminals (Y, Pb, Pr)—see “Setting the COMPONENT/RGB B Input” on page 20, external sync signals (HD/Cs, VD) cannot be used.

Parts Identification (Continued)

Monitor: Rear Views ②

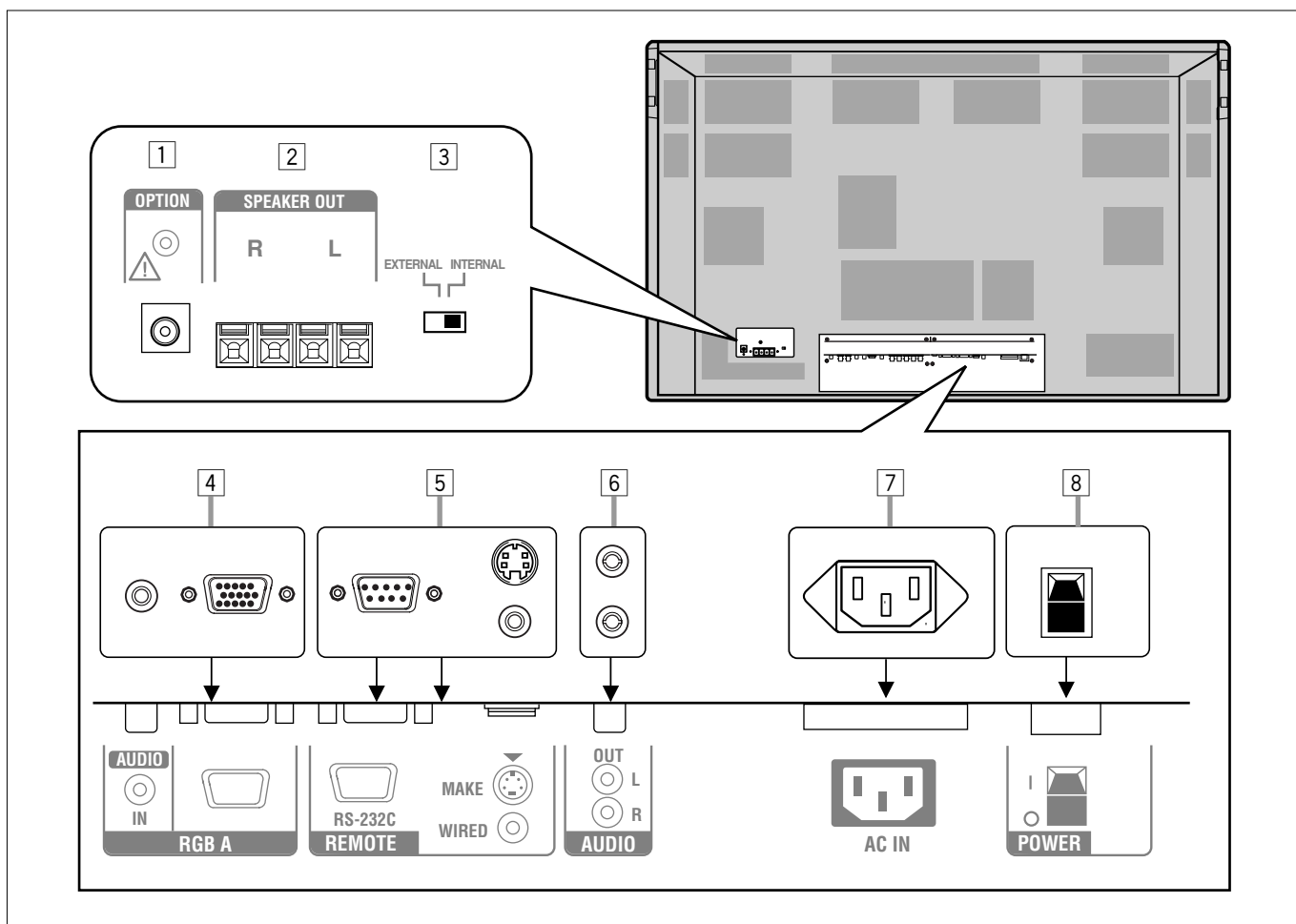

① OPTION terminal (page 13)

Connect the power cord of the Cooling Fan Unit (not supplied) when installing the Monitor vertically.

② SPEAKER OUT L/R terminals (page 13)

Connect external speakers, such as unique JVC speakers (not supplied), etc.

③ INTERNAL/EXTERNAL (built-in speaker/external speaker) selecting switch (page 13)

INTERNAL: To use built-in speakers.
EXTERNAL: To use external speakers.

④ RGB A input terminals (page 12)

Input terminal (D-sub, 15 pin)

Connect to the video output terminal of a personal computer.

Note:

- Use a cord as short as possible when connecting a personal computer to this terminal. (Recommended length is within 3 m.)

AUDIO IN terminal (stereo mini jack)

Connect to the audio output terminal of a personal computer.

⑤ REMOTE terminals (page 12)

RS-232C terminal (D-sub, 9 pin)

Connect to the RS-232C terminal of a personal computer. For the control method using this terminal, consult an authorized JVC dealer.

MAKE terminal (mini DIN, 4pin)

Connect an external control unit. (See page 12.)

WIRED terminal (stereo mini jack)

Connect a wired remote control unit to this terminal.

Note:

- When the above three terminals are used at the same time, transmitted commands through the MAKE terminal have priority over those through the other terminals.

⑥ AUDIO OUT terminals (pin jack) (page 12)

Connect to the audio input terminals of external equipment such as an amplifier.

⑦ AC IN terminal (page 12)

Connect the supplied power cord to this terminal.

⑧ POWER switch (page 14)

When this switch is set to "I (on)," you can turn on and off (on standby) the Monitor by using the POWER button on the remote control or the /I button on the Monitor.

Remote Control

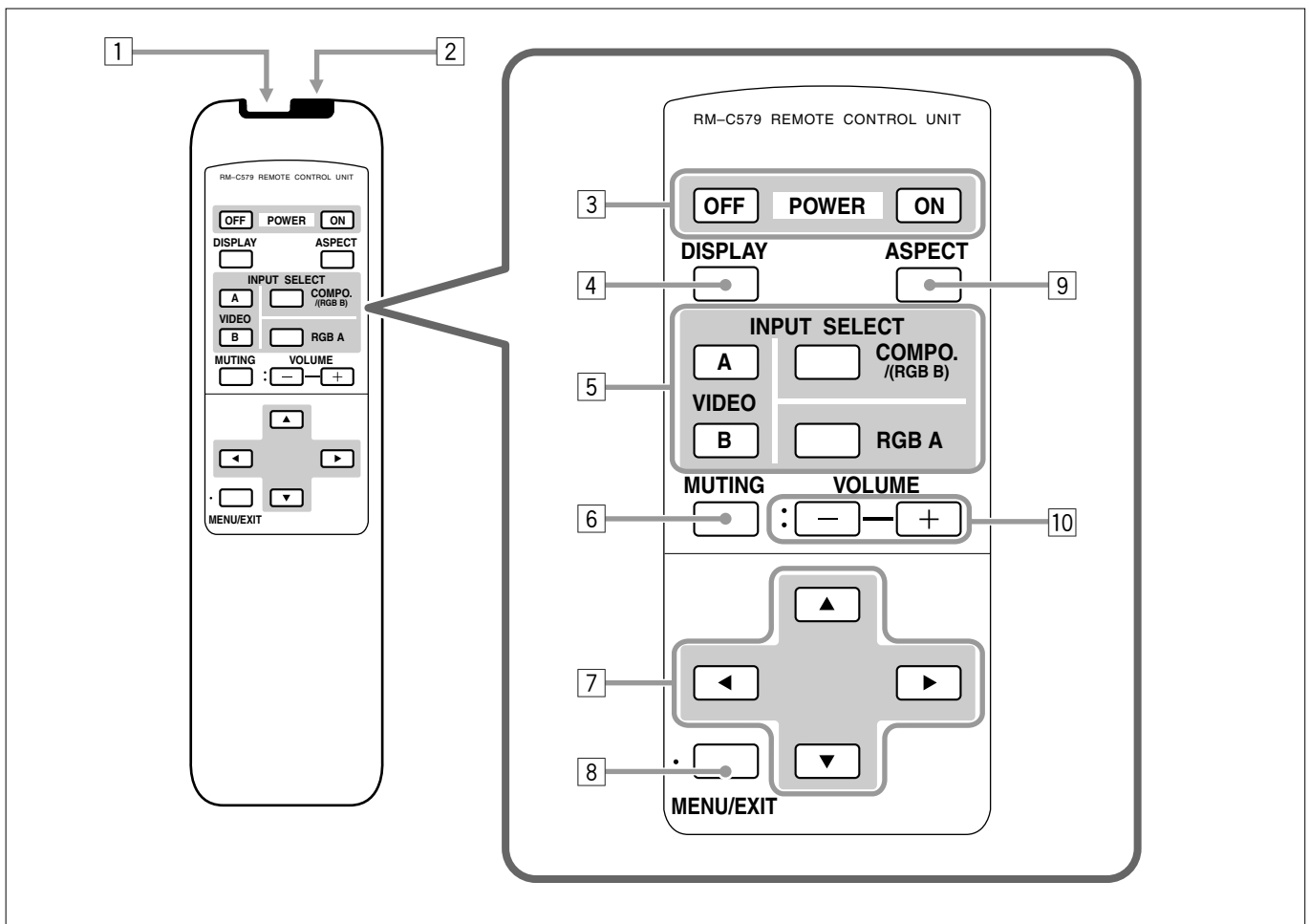

- 1 Remote control cable jack (page 12)**
Connect the remote control cable (not supplied) when using this remote control as a wired remote control.
- 2 Remote signal transmission window**
- 3 POWER ON/OFF button (page 14)**
Use this button to turn on and off (on standby) the Monitor when the POWER switch on the rear of the Monitor is "I (on)."
- 4 DISPLAY button (page 14)**
Use this button to display the input terminal, color system (for VIDEO A or VIDEO B input), scan system (for COMPONENT input) and horizontal/vertical frequency (for RGB A and RGB B input).
- 5 INPUT SELECT (VIDEO A, VIDEO B, COMPO./(RGB B) and RGB A) buttons (page 14)**
Use these buttons to switch between inputs. To select the COMPONENT or RGB B input, you have to set "COMPO./RGB B" correctly on the menu (see page 20).
- 6 MUTING button (page 14)**
Use this button to turn off the volume immediately. Pressing the button again will resume the previous volume level.
- 7 ◀ / ▶ / ▲ / ▼ buttons**
Use these buttons to select menu items or make adjustments.
- 8 MENU/EXIT button**
Use this button to display or erase menus. While a sub-menu is displayed, pressing this button will move you one screen back to the preceding menu.
- 9 ASPECT button (page 15)**
Use this button to switch between aspect ratios. Each time you press the button, the aspect ratio changes as follows:

```

      REGULAR  →  FULL  →
      ←  PANORAMIC ←  ZOOM ←
    
```
- 10 VOLUME + / - buttons (page 14)**
Use these buttons to adjust the volume level.

Preparations

Checking the Accessories

The following accessories are included with the Monitor. Check for them. If any item is missing, please contact the dealer where you purchased the Monitor.

- Remote control (RM-C579) x 1
- Power cord x 1
- Batteries (AA/R6P) x 2
- Ferrite core x 2

Installing the Batteries

Put the batteries in the remote control as follows. If the remote control has become erratic in operation, change the batteries.

1 Remove the back cover.

While pushing the release lever on the cover, remove the cover in the direction of the arrow.

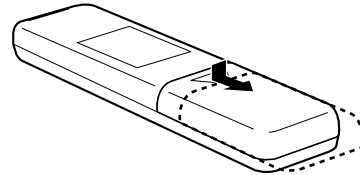

2 Place the batteries.

Put the two supplied batteries (AA/R6P), noting the ⊕ and ⊖ markings, as shown.

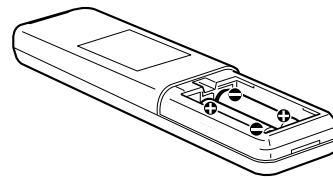

3 Replace the back cover as illustrated.

Make sure the release lever on the cover is locked in place correctly.

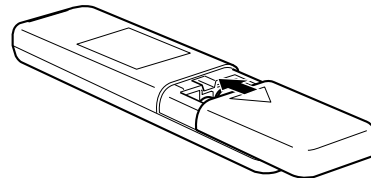

Precautions for using batteries

If batteries are used improperly, the liquid could leak out, causing a fire, injury, etc. or dirtying the vicinity.

Take notice of the following:

- Do not mix old and new batteries.
- Do not mix different types of battery as different types may have different characteristics.
- Place the batteries according to the ⊕ and ⊖ markings indicated on the battery compartment.
- When installing the batteries, insert the ⊖ end first to avoid a short circuit.
- Use only the specified batteries.
- When you are not using the remote control for a long time, remove the batteries.
- When the batteries have reached the end of their life, replace them with new ones immediately. Otherwise, the liquid may leak out, or malfunction may be caused by the leaked liquid. If the leaked liquid contacts your skin, wipe off the liquid with a soft cloth. If the affected skin is left as is, you may get a rough skin.
- Do not throw the batteries into fire or try recharging them.
- The service life of batteries is six months to one year for normal use. The supplied batteries are only for checking the operation and their life may be shorter. When the remote control operation becomes erratic, replace with new batteries.

About the Supplied Ferrite Core

Be sure to attach the supplied ferrite cores to the speaker cords when using external speakers to reduce interference from the Monitor with external devices. See page 13.

Installation

Precautions

- **When installing the Monitor vertically, make sure the following:**
 - Attach the external cooling fan unit to the Monitor. (See “Connecting the External Cooling Fan Unit” on page 13.)
 - Set the speed of the internal cooling fan to “HIGH.” (See “Setting the Speed of the Internal Cooling Fan” on page 25.)
- When installing the Monitor, be sure to use a dedicated Stand Unit, Wall Mounting Unit, or Monitor Hanger Unit, depending on a particular case. Ask your dealer for installation.
- When installing the Monitor in a special way (for example, installing it diagonally), consult your dealer.
- Route the power cord and connection cables along wall or floor corners to avoid walking on them.
- For good heat dissipation, try to leave the following distances of space (minimum) around the Monitor.
- The ambient temperature of the installation place should be within the range of 0°C to 40°C (slightly variable depending on ambient conditions for installation.)
- When installing the Monitor in a place, such as near the ceiling, the remote control may not work correctly because of possible effects from the surroundings. If this happens, use the remote control as a wired remote control or move the Monitor where it is free from these effects.

When installing the Monitor on a stand

Front View

Side View

Unit: mm (inch)

Take measures against the Monitor from overturning:
 To protect against abnormal events such as earthquakes and to prevent unexpected accidents, take appropriate measures for preventing the Monitor from overturning; should it overturn, this could lead to personal injury.
 For detailed information, refer to the manual supplied for the stand.

When mounting the Monitor on the wall

Front View

Side View

Unit: mm (inch)

When hanging the Monitor from the ceiling

Side View

Unit: mm (inch)

Notes:

- Do not allow the same image (pattern) to be continuously displayed on the screen for a long time; otherwise, the area on the screen corresponding to the image may vary in brightness, leaving an afterimage on the screen. To reduce the afterimage, you can use the Color Reverse function and the Refresh function (see pages 28 and 29).
- The Monitor is manufactured using very high-precision technology, allowing for more than 99.99% active pixels, however, be aware that only a slight number of pixels may be deficient or lit at all times.
- Do not install the Monitor in such a way that the Monitor and other AV equipment affect each other adversely. (For example, if a disturbed image or noise due to electromagnetic interference occurs, or if the infrared remote control malfunctions, change the installation place.)

Connections

Precautions

- Before making connections, turn off all the equipment.
- Use a cord whose plugs are correctly matching for the terminals on this Monitor and the equipment.
- Plugs should be firmly inserted; poor connection could cause noise.
- To unplug a cord, be sure to grasp its plug and pull it out.
- Connect the power cord after having finished all other connections.
- Refer also to the user manual of each piece of equipment.

Available Signals

Video signals

The following signals can be input to this Monitor:

- VIDEO A and VIDEO B terminals accept — NTSC, PAL M, and PAL N signals.
- COMPONENT/RGB B terminals accept — 480i, 576i, 480p, 576p, 720/60p, 720/50p, 1080/60i (1035/60i), and 1080/50i signals. (You need to set "COMPO./RGB B" to "COMPO." on the menu (see page 20).

Computer signals (Preset)

This Monitor has 27 preset video modes for the most popular industrial standard, and the signals of the following image resolutions can be input to the RGB input terminals.

No.	Signal name	Screen resolution		Horizontal Frequency (kHz)	Vertical Frequency (Hz)	Scan system
		Horizontal	Vertical			
1	PC98	640	400	24.8	56.4	Non-interlace
2	VGA400-70	640	400	31.5	70.1	Non-interlace
3	VGA480-60	640	480	31.5	59.9	Non-interlace
4	WVGA-60	852	480	31.7	60.3	Non-interlace
5	VGA480-72	640	480	37.9	72.8	Non-interlace
6	VGA480-75	640	480	37.5	75.0	Non-interlace
7	SVGA-56	800	600	35.2	56.3	Non-interlace
8	SVGA-60	800	600	37.9	60.3	Non-interlace
9	SVGA-72	800	600	48.1	72.2	Non-interlace
10	SVGA-75	800	600	46.9	75.0	Non-interlace
11	XGA-60	1024	768	48.4	60.0	Non-interlace
12	WXGA-60	1366	768	48.4	60.0	Non-interlace
13	XGA-70	1024	768	56.5	70.1	Non-interlace
14	XGA-75	1024	768	60.0	75.0	Non-interlace
15	XGA-85	1024	768	68.7	85.0	Non-interlace
16	XGA+-75	1152	864	67.5	75.0	Non-interlace
17	SXGA-60	1280	1024	64.0	60.0	Non-interlace
18	SXGA-75	1280	1024	80.0	75.0	Non-interlace
19	UXGA-60	1600	1200	75.0	60.0	Non-interlace
20	UXGA-65	1600	1200	81.3	65.0	Non-interlace
21	UXGA-70	1600	1200	87.5	70.0	Non-interlace
22	MAC13"	640	480	35.0	66.7	Non-interlace
23	MAC16"	832	624	49.7	74.6	Non-interlace
24	MAC19"	1024	768	60.2	74.9	Non-interlace
25	MAC21"	1152	870	68.7	75.1	Non-interlace
26	RGB15K-60	—	—	15.7	59.9	Interlace
27	RGB15K-50	—	—	15.6	50.0	Interlace

Notes:

- When a signal other than listed above is input, a part of the screen may become void or an unnecessary picture may appear.
- Signals, though they are within the acceptable range of frequencies, may not be displayed normally, depending on the signal type.
- Depending on the connected equipment, the Monitor may not be compatible with composite sync (Cs) or G on sync signals.
- When a preset mode signal is input, the vertical frequency displayed on the screen will have an "*" shown at its right top position.
- When the No. 4 and No. 12 signals are input, change the aspect ratio to "FULL" with the ASPECT button (page 15) on the remote control or from the "FUNCTION SELECT" menu (see page 19).
- When No. 16 to No. 21 and No. 25 signals are input, thin lines may become obscure for their signal frequencies are higher than the screen resolution. Using the RGB A input terminals makes the lines clearer than using the RGB B input terminals.
- The adjustment of the screen size and position is the setting common to the No. 14 and No. 24 signals. If you use both signals by switching them, the adjustment of either signal may not be proper.

Connection Diagrams

AV connections

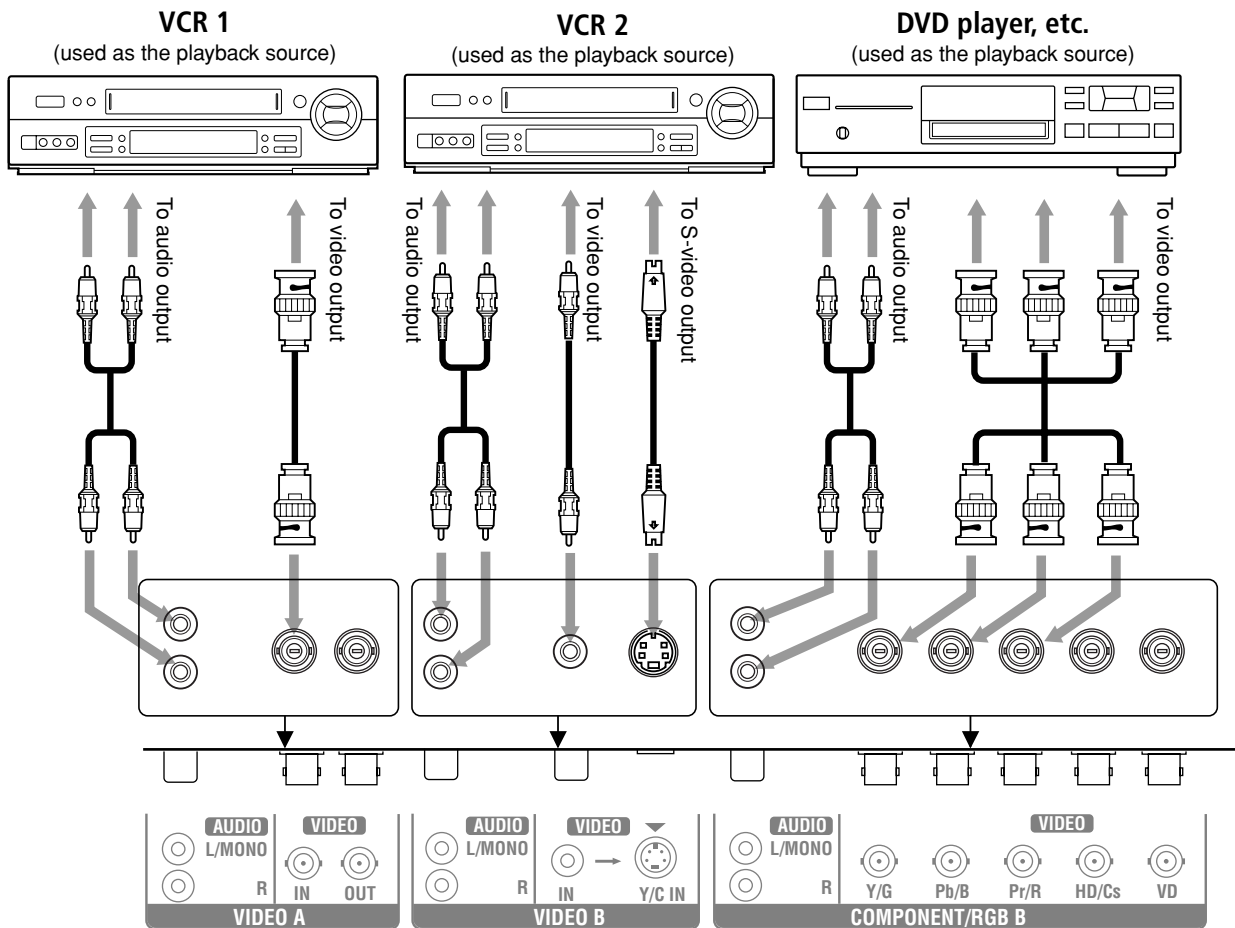

When connecting another PC to the COMPONENT/RGB B terminals, set the "COMPO./RGB B" setting to "RGB B" (see page 20).

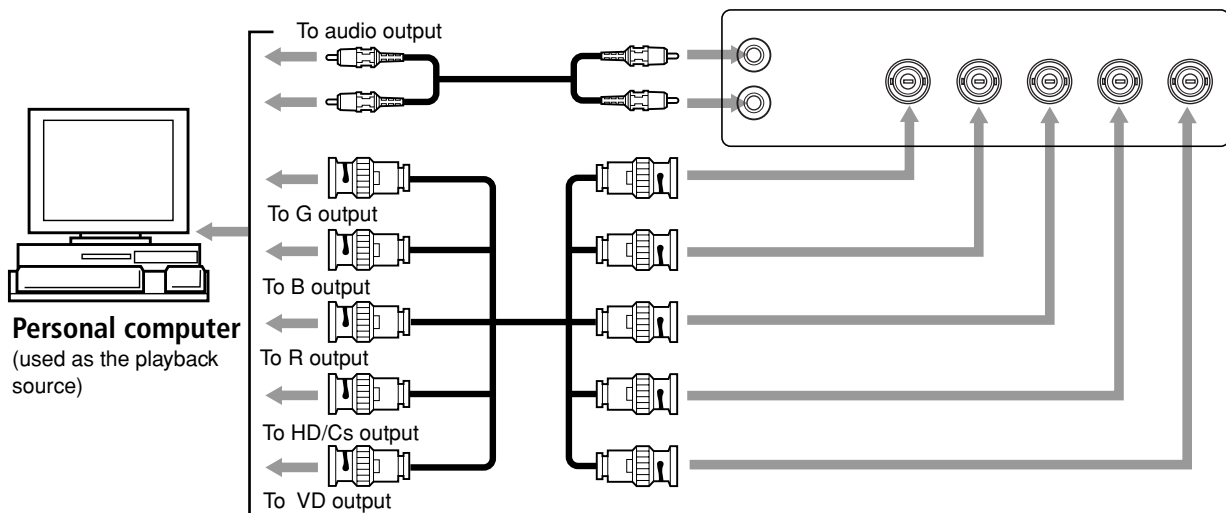

Notes:

- You can connect another VCR or Monitor to the VIDEO A OUT terminal. However, when connecting a VCR to the VIDEO A terminals, do not connect both IN and OUT terminals to the same VCR.
- When connecting a VCR to the VIDEO B terminals, you can use either the video or S-video terminals. If both terminals are used, S-video terminal will have priority.

Connections (Continued)

Typical connections

Personal computer
(used as the playback source)

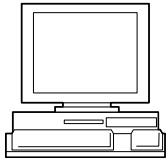

Personal computer
(used to control the Monitor)

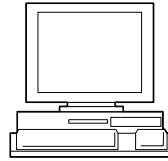

Remote control
(supplied)



* For connection, see "Connecting an External Control Unit" below.

Amplifier, etc.

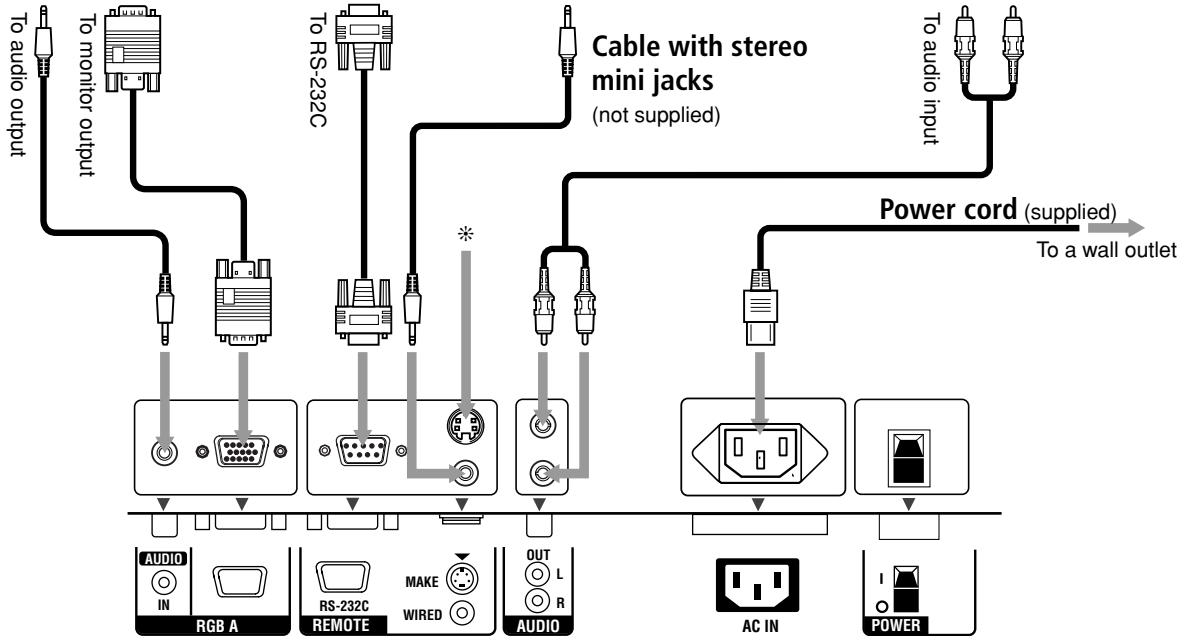
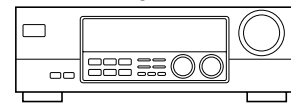

Connecting an External Control Unit

When connecting the external control unit to the MAKE terminal, you can operate the following functions through the MAKE terminal;

- Turn on or off the Monitor.
Preparation: The POWER switch on the rear must be set to "I (on)" (so that the Monitor is in standby mode).
- Select the input.
Preparation: "REMOTE SWITCH" should be set correctly to select your desired input (see page 24).

Notes:

- There is no remote control on/off switch. When a plug is inserted to the MAKE terminal, remote control through the external control unit is automatically activated.
- When the other REMOTE terminals are used at the same time, transmitted commands through the MAKE terminal have priority over those through the other terminals.

• MAKE terminal

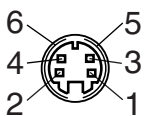

Pin number	Signal name
1	GND
2	GND
3	SW2
4	SW1
5	SW DET
6	GND

• External control unit

Signals transmitted

TTL level	
H: Power Off	L: Power On
H: Input A*	L: Input B*
H: Not connected	L: Connected

* Input A and Input B will be determined by the "REMOTE SWITCH" setting.

IMPORTANT:

External control unit is not commercially available in the market. When you need it, consult your dealer.

External Speaker Connection

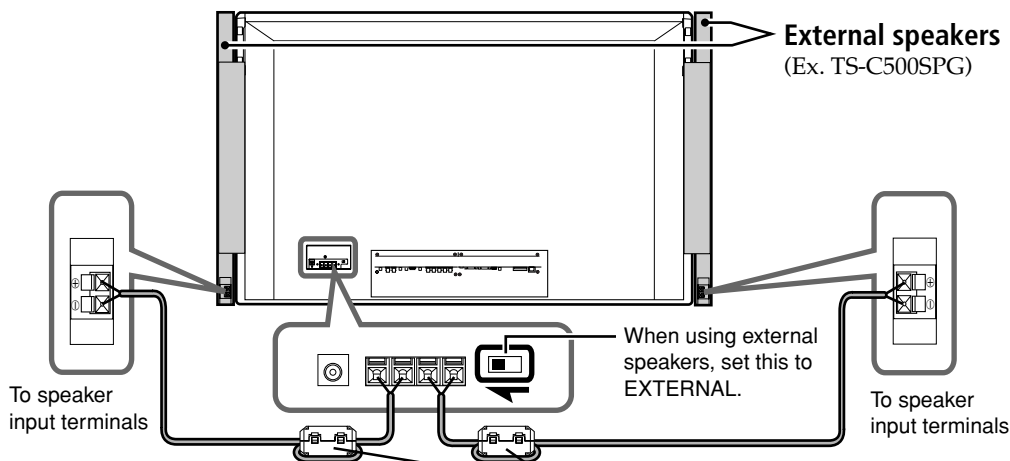

Note:

It is recommended to use the speaker unit—TS-C500SPG (not supplied) as the external speakers. You can also connect any speakers of the following specifications:

- Impedance: Between 6 Ω and 8 Ω
- Power handling capacity: More than 3 W

How to connect the cords

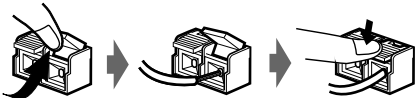

Caution:

- Do not short-circuit the \oplus and \ominus speaker cords each other. (Refer also to the instructions supplied with the speaker unit when connecting speakers.)

Ferrite core (supplied)

Attach the supplied ferrite cores to the speaker cords when using external speakers. Attach the ferrite cores as near to the SPEAKER OUT L/R terminals on the rear panel of the Monitor as possible.

How to attach the ferrite core

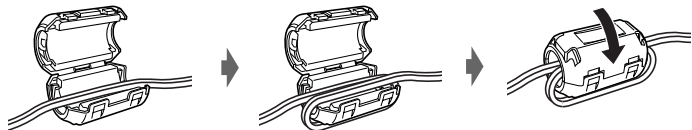

Connecting the External Cooling Fan Unit

When installing this Monitor vertically, it is required to attach the external cooling fan unit (not supplied).

Note:

- When installing this Monitor vertically, it is also required to set the speed of the internal cooling fan to "HIGH" (see page 25).
- If you install the Monitor in such a way not instructed in this manual (for example, installing it diagonally), the cooling fan unit may not be able to cool down the internal heat enough to make the Monitor operate; therefore, reinstallation or another method for cooling will be required. Consult your dealer in such a case.
- For more detailed connection, refer to the manual supplied with the external cooling fan unit.

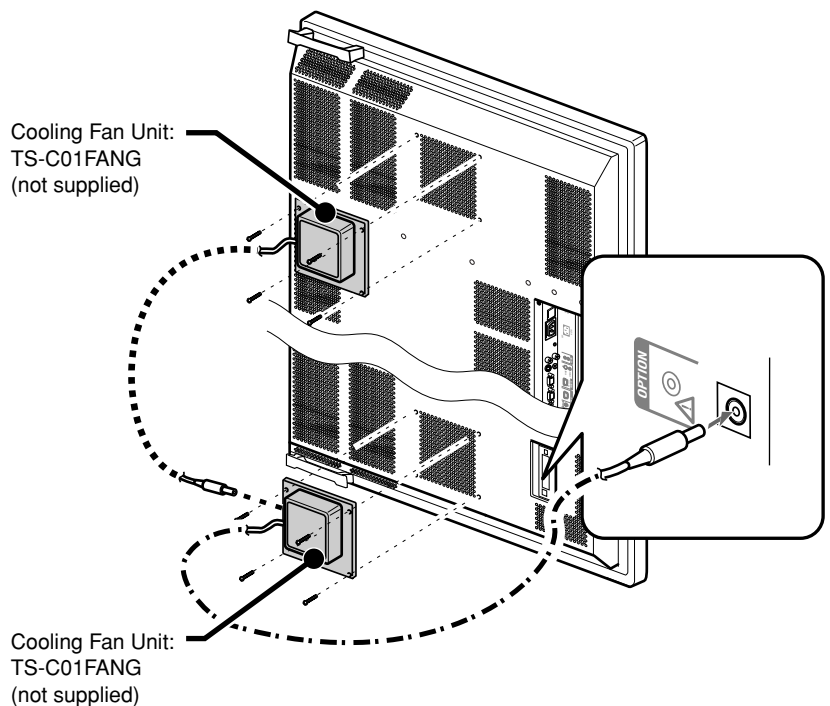

Basic Operations

Rear View

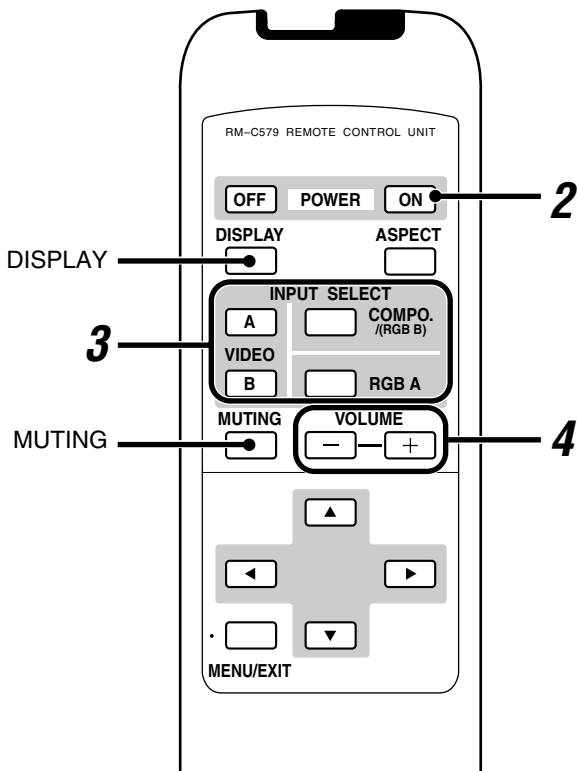
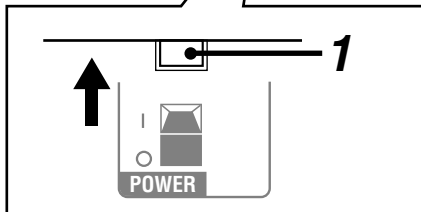
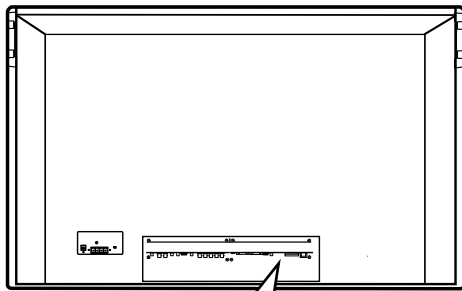

Daily Operations

1 Turn on the main power.

Set the POWER switch on the rear of the Monitor to "I (on)".

The power lamp on the upper left of the front panel lights orange.

- If you have turned off the Monitor not by using POWER ON on the remote control (or \mathcal{O}/I on the front panel), but by using the POWER switch, setting the power switch to "I (on)" lights the power lamp green and turns the Monitor on.

2 Turn on the power.

Press POWER ON on the remote control to turn the power on.

The power lamp lights green.

- You can also use \mathcal{O}/I on the front panel (lower right) to turn on the Monitor.

3 Select an input.

Select the desired input by pressing INPUT SELECT (VIDEO A, VIDEO B, COMPO./RGB B) and RGB A).

- You can also select the input by pressing INPUT on the Monitor. Each time you press the button, the input mode changes in sequence.

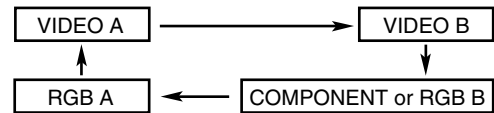

Ex. When selecting "VIDEO A" input

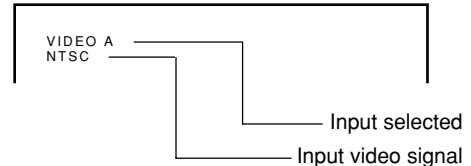

Note:

- To select "COMPONENT" or "RGB B," you need to set the "COMPO./RGB B" setting correctly.

4 Adjust the volume.

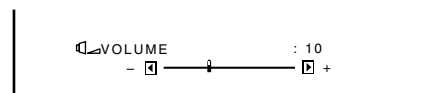

Note:

- While no menu is displayed, you can adjust the volume by pressing \blacktriangleleft / \blacktriangleright on the Monitor.

To turn off the volume immediately

Press MUTING.

"MUTING ON" is displayed, and the sound goes out.

Pressing the button again resumes the previous volume level.

To make the screen indication appear

Press DISPLAY.

The types of input and signal are indicated on the screen for about 3 seconds.

You can also make the screen indication appear using menus (page 22).

Changing the Aspect Ratio

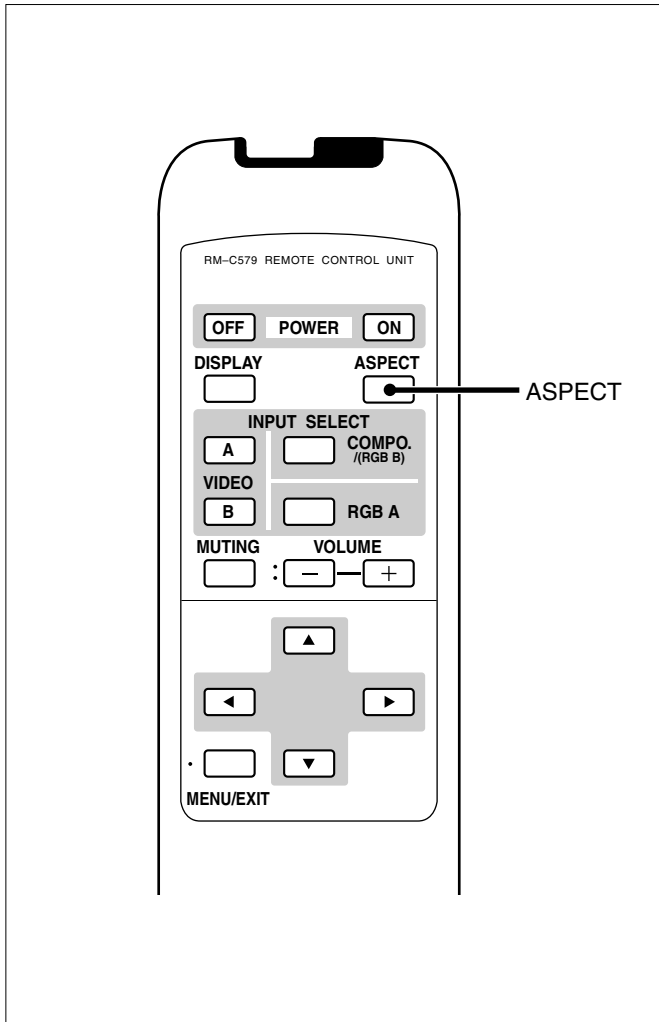

With this Monitor, you can select among three types of wide screens (FULL, ZOOM, and PANORAMIC) in addition to the REGULAR screen of conventional 4:3 aspect ratio.

Press ASPECT to select the screen size.

Each time you press the button, the screen size changes as follows:

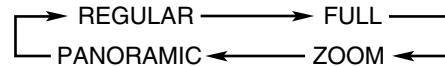

REGULAR: Displays at conventional 4:3 aspect ratio.

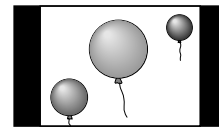

FULL: REGULAR size display is enlarged horizontally.

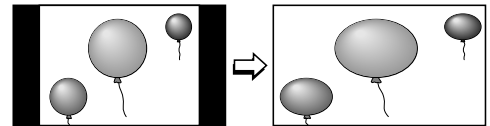

ZOOM: REGULAR size display is enlarged vertically and horizontally at the same ratio.

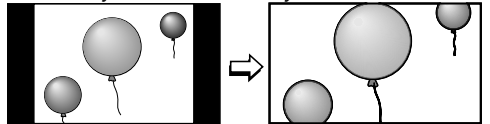

PANORAMIC: REGULAR size display is enlarged horizontally to the extent that the picture does not look abnormally.

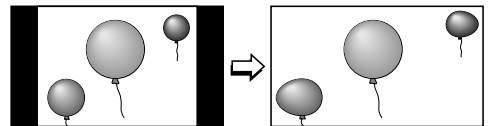

Precautions for using the screen mode switching function

- This Monitor features a screen mode switching (aspect ratio change) function. If you select a mode different in aspect ratio from software such as TV programs, the picture may look different from original picture. Be aware of this point when you are selecting a screen mode.
- If you select a wide screen mode while viewing conventional video programs of the aspect ratio 4:3, some portions (edges) of the original picture will be cut off, or deformed. To enjoy the original picture as it is, select "REGULAR" while viewing such programs.
- If you place the Monitor in a tea room, hotel, etc. for business purposes or public viewing and modify the picture by using the screen mode switching (aspect ratio change) function, this could violate the copyright protected by the copyright law, which requires your special attention.
- If you make the screen very bright and watch programs selecting "REGULAR," for a long period of time, the Monitor screen may happen to be burned in. If this occurs, watching programs using a wide screen mode for a while will reduce the burn-in gradually.

Notes:

- When one of the following signals is being input, you cannot select the aspect ratio you want.
 - 720/60p, 720/50p, 1080/60i (1035/60i), or 1080/50i signal through the COMPONENT/RGB B input terminals
You can only select FULL.
 - When any signal other than RGB15K-60 and RGB15K-50 through the RGB A or COMPONENT/RGB B input terminals
You can select only REGULAR and FULL.
- The aspect ratio can also be changed on the "FUNCTION SELECT" Menu (see page 19).

Video Adjustments

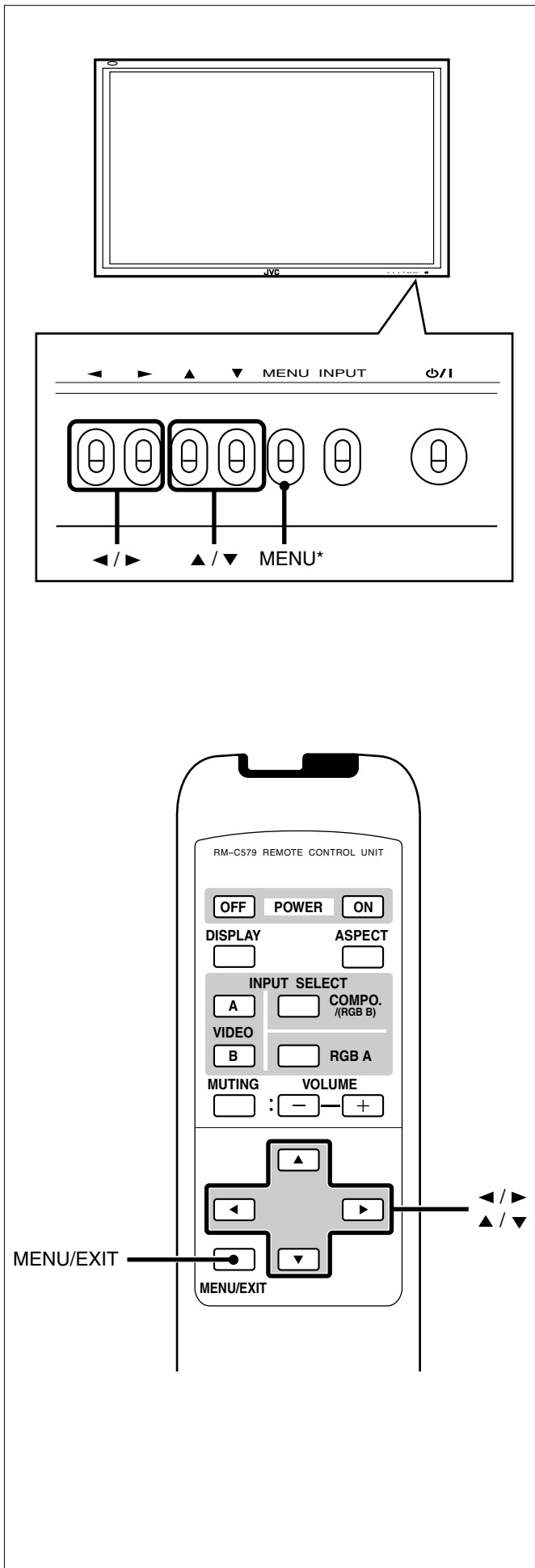

Adjusting the Picture Quality

Picture quality can be set for each input mode.

- 1 Press **MENU/EXIT** (or **MENU** on the Monitor) to display the Main Menu.

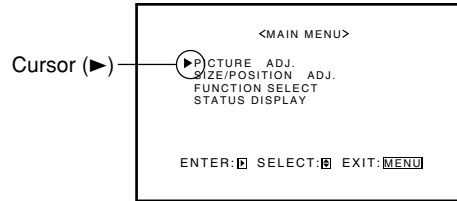

- 2 Press **▲/▼** to move the cursor (▶) to "PICTURE ADJ."

- 3 Press **▶** to display the Picture Adjustment Menu.

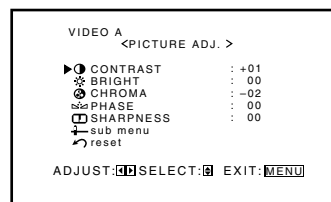

- 4 Press **▲/▼** to move the cursor (▶) to the item you want to adjust.

Item	Adjustment range	Standard (Reset)
CONTRAST	-20 to +20	+10
BRIGHT (brightness)	-20 to +20	00
CHROMA ^{*1}	-20 to +20	00
PHASE ^{*2}	-20 to +20	00
SHARPNESS	-10 to +10	00
sub menu	See "To make an adjustment while viewing the adjustment bar" on the next page.	
reset	See "To reset the adjustments" on the next page.	

^{*1} Adjustable when viewing the NTSC or PAL signal, or component signal.

^{*2} Adjustable when viewing the NTSC signal or component signal.

- 5 Press **◀/▶** to make adjustments.

- 6 Press **MENU/EXIT** (or **MENU** on the Monitor) twice to exit from the menu operations.

To make an adjustment while viewing the adjustment bar

After step 3 on page 16, proceed as follows:

- 1 Press ▲/▼ to move the cursor (▶) to "sub menu."
- 2 Press ▶ to display the Sub Menu.
The Sub Menu for CONTRAST appears on the screen.

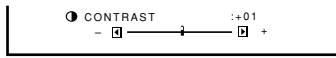

- 3 Press ▲/▼ to select the Sub Menu you want to adjust.
Each time you press the button, the Sub Menu changes as follows:

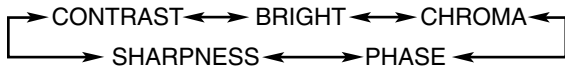

- 4 Press ◀/▶ to adjust the selected item.
- 5 Repeat steps 3 and 4 to adjust the other items.
- 6 Press MENU/EXIT (or MENU on the Monitor) three times to exit from the menu operations.

To reset the adjustments

After step 3 on page 16, proceed as follows:

- 1 Press ▲/▼ to move the cursor (▶) to "reset."
- 2 Press ▶.
The confirmation screen appears.

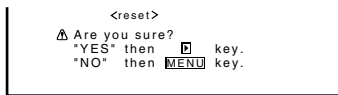

- 3 Press ▶ again to reset the adjustments.
To cancel the reset, press MENU/EXIT (or MENU on the Monitor).

Adjusting the Screen Size and Position

The screen size and position can be adjusted. Adjusted settings can be stored for each signal type; therefore, when the same signal comes in, the stored settings are recalled.

- When adjusting the size, the size cannot be adjusted proportionally, but can be enlarged rightward (or downward) only and reduced leftward (or upward) only. Therefore, it is necessary to adjust both the size and position alternately to adjust to the appropriate size.

1 Press MENU/EXIT (or MENU on the Monitor) to display the Main Menu.

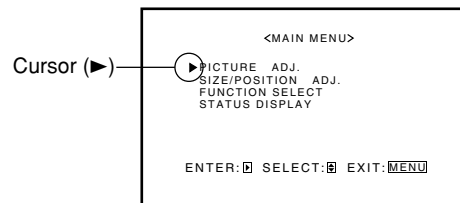

2 Press ▲/▼ to move the cursor (▶) to "SIZE/POSITION ADJ."

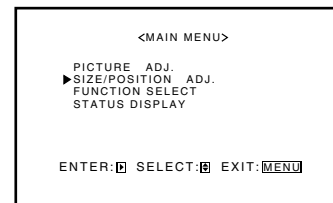

3 Press ▶ to display the Size/Position Adjustment Menu.

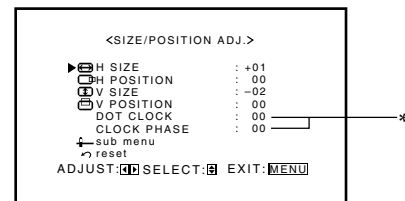

* Appearing and being adjustable only when you use RGB A or RGB B input.

(To be continued on the next page)

Video Adjustments (Continued)

4 Press ▲/▼ to move the cursor (▶) to the item you want to adjust.

Item	Adjustment range	
H (horizontal) SIZE* ¹	-40 to +40	
H POSITION* ¹	Varies depending on other settings	
V (vertical) SIZE* ¹	-40 to +40	
V POSITION* ¹	Varies depending on other settings	
	DOT CLOCK* ²	-10 to +10
	CLOCK PHASE* ²	-20 to +20
sub menu	See "To make an adjustment while viewing the adjustment bar" on the right column.	
reset	See "To reset the adjustments" on the right column.	

*¹ Size and position adjustments are so related that if one is adjusted much, the other's adjustable range will be reduced.

*² DOT CLOCK is the function to adjust the pixel sampling number of the A/D converter to the resolution (the vertical pixel number) of the input signal.

CLOCK PHASE is the function to adjust the sampling timing (phase) to the phase of the input signal. You can use the two functions to reduce flickering and blurring on the screen when using the RGB A or RGB B input.

5 Press ◀/▶ to adjust the selected item.

Note:

- During size and position adjustments, the Monitor screen may be distorted. This is normal, but not a malfunction of the Monitor.

6 Press MENU/EXIT (or MENU on the Monitor) twice to exit from the menu operations.

To make an adjustment while viewing the adjustment bar

After step 3 on page 17, proceed as follows:

1 Press ▲/▼ to move the cursor (▶) to "sub menu."

2 Press ▶ to display the Sub Menu.

The Sub Menu for H SIZE appears on the screen.

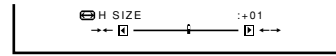

3 Press ▲/▼ to select the Sub Menu you want to adjust.

Each time you press the button, the Sub Menu changes as follows:

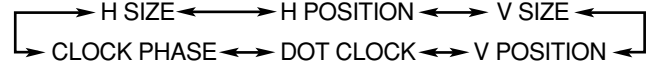

4 Press ◀/▶ to adjust the selected item.

5 Repeat steps 3 and 4 to adjust the other items.

6 Press MENU/EXIT (or MENU on the Monitor) three times to exit from the menu operations.

To reset the adjustments

After step 3 on page 17, proceed as follows:

1 Press ▲/▼ to move the cursor (▶) to "reset."

2 Press ▶.

The confirmation screen appears.

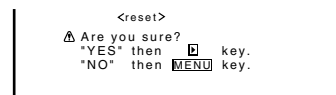

3 Press ▶ again to reset the adjustments.

To cancel the reset, press MENU/EXIT (or MENU on the Monitor).

Note:

- Adjustment values for both horizontal and vertical sizes of the screen are so related that if one is adjusted up to near the maximum value, the attainable value of the other will be decreased.

Adjusting the Color Temperature

The adjusted setting applies to all inputs.

- 1 Press **MENU/EXIT** (or **MENU** on the Monitor) to display the Main Menu.

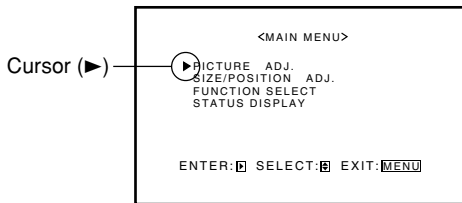

- 2 Press **▲/▼** to move the cursor (▶) to "FUNCTION SELECT."

- 3 Press **▶** to display the Function Selection Menu.

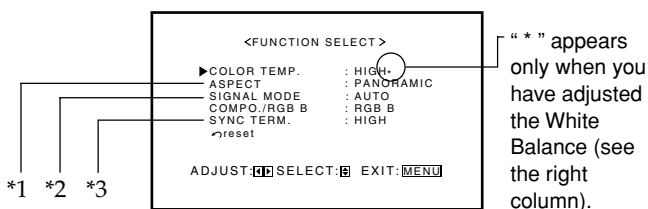

- *1 "ASPECT" does not appear when 720/60p, 720/50p, 1080/60i (1035/60i), or 1080/50i signal is being input through the COMPONENT/RGB B input terminals.
- *2 "SIGNAL MODE" appears only when VIDEO A, VIDEO B, or COMPONENT input is selected.
- *3 "SYNC TERM." appears only when the RGB B input is selected.

- 4 Press **▲/▼** to move the cursor (▶) to "COLOR TEMP."

- 5 Press **◀/▶** to make an adjustment.

Each time you press the button, the color temperature alternates between "HIGH" and "LOW."

- HIGH: To make the screen become bluish.
- LOW: To make the screen become reddish.

- 6 Press **MENU/EXIT** (or **MENU** on the Monitor) twice to exit from the menu operations.

Note:

- To make a fine adjustment, adjust "WHITE BALANCE" (see page 25).

Changing the Aspect Ratio

The setting adjusted applies to all inputs.

- You can change the aspect ratio by pressing ASPECT. (See page 15.)

- 1 Press **MENU/EXIT** (or **MENU** on the Monitor) to display the Main Menu.

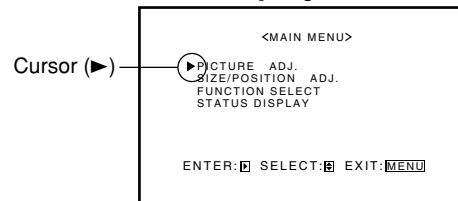

- 2 Press **▲/▼** to move the cursor (▶) to "FUNCTION SELECT."

- 3 Press **▶** to display the Function Selection Menu.

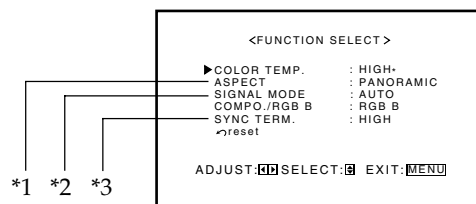

- *1 "ASPECT" does not appear when 720/60p, 720/50p, 1080/60i (1035/60i), or 1080/50i signal is being input through the COMPONENT/RGB B input terminals.
- *2 "SIGNAL MODE" appears only when VIDEO A, VIDEO B, or COMPONENT input is selected.
- *3 "SYNC TERM." appears only when the RGB B input is selected.

- 4 Press **▲/▼** to move the cursor (▶) to "ASPECT."

- 5 Press **◀/▶** to select an aspect ratio you want.

Each time you press the button, the aspect ratio changes as follows:

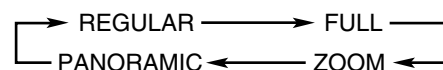

- * For detailed information on these aspect ratios, see page 15.

- 6 Press **MENU/EXIT** (or **MENU** on the Monitor) twice to exit from the menu operations.

Note:

- When one of the following signals is being input, you cannot select the aspect ratio you want.
 - 720/60p, 720/50p, 1080/60i (1035/60i), or 1080/50i signal through the COMPONENT/RGB B input terminals
Aspect ratio is fixed to FULL ("ASPECT" does not appear on the display).
 - When any signal other than RGB15K-60 and RGB15K-50 through the RGB A or COMPONENT/RGB B input terminals
You can select only REGULAR and FULL.

Video Adjustments (Continued)

Setting the Receivable Signal Types

You can set the receivable signal types. Normally, select "AUTO."

A common setting will apply to both the VIDEO A input and the VIDEO B input, and a different setting will apply to the COMPONENT input.

1 Press MENU/EXIT (or MENU on the Monitor) to display the Main Menu.

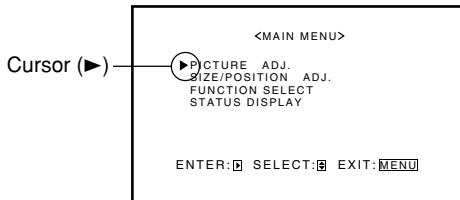

2 Press ▲/▼ to move the cursor (▶) to "FUNCTION SELECT."

3 Press ▶ to display the Function Selection Menu.

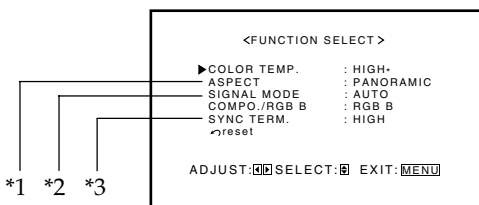

*1 "ASPECT" does not appear when 720/60p, 720/50p, 1080/60i (1035/60i), or 1080/50i signal is being input through the COMPONENT/RGB B input terminals.

*2 "SIGNAL MODE" appears only when VIDEO A, VIDEO B, or COMPONENT input is selected.

*3 "SYNC TERM." appears only when the RGB B input is selected.

4 Press ▲/▼ to move the cursor (▶) to "SIGNAL MODE."

5 Press ◀/▶ to select the receivable video signal type.

Each time you press the button, the receivable video signal type changes as follows:

- When VIDEO A or VIDEO B input is selected:

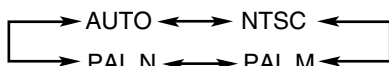

- When COMPONENT input is selected:

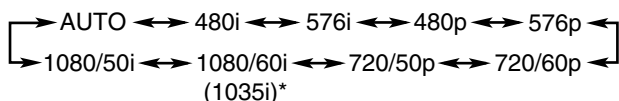

* Changes according to the "HD SIGNAL MODE" setting (see page 24).

6 Press MENU/EXIT (or MENU on the Monitor) twice to exit the menu operations.

Setting the COMPONENT/RGB B Input

After connecting the playback device such as a PC or a DVD player to the COMPONENT/RGB B terminals, you have to specify which type of signal comes into this terminal—RGB or component signals.

- Without setting "COMPO./RGB B" correctly, you cannot show any picture though you select the COMPONENT or RGB B input.

1 Press MENU/EXIT (or MENU on the Monitor) to display the Main Menu.

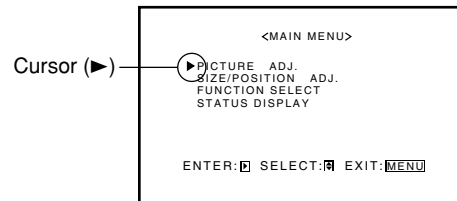

2 Press ▲/▼ to move the cursor (▶) to "FUNCTION SELECT."

3 Press ▶ to display the Function Selection Menu.

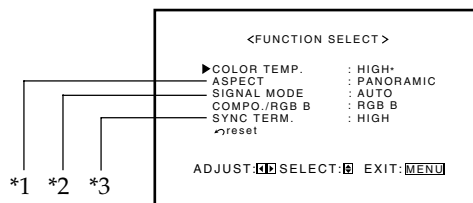

*1 "ASPECT" does not appear when 720/60p, 720/50p, 1080/60i (1035/60i), or 1080/50i signal is being input through the COMPONENT/RGB B input terminals.

*2 "SIGNAL MODE" appears only when VIDEO A, VIDEO B, or COMPONENT input is selected.

*3 "SYNC TERM." appears only when the RGB B input is selected.

4 Press ▲/▼ to move the cursor (▶) to "COMPO./RGB B"

5 Press ◀/▶ to select the type of signal.

COMPO.: When connecting the playback device such as a DVD player, which can emit the component signals.

RGB B: When connecting the playback device such as a PC, which can emit the RGB signals.

The setting changes and the "FUNCTION SELECT" Menu disappears.

Changing the Resistance of the RGB B Input Terminals

You can set the resistance of the two of the RGB B input terminals to either HIGH (1 k Ω) or LOW (75 Ω):

- HD/Cs (Horizontal sync/Composite) terminal
- VD (Vertical sync) terminal.

HIGH is the normal setting. Change the setting to LOW when you use a long connecting cord and the picture flickers and blurs on the screen.

1 Press MENU/EXIT (or MENU on the Monitor) to display the Main Menu.

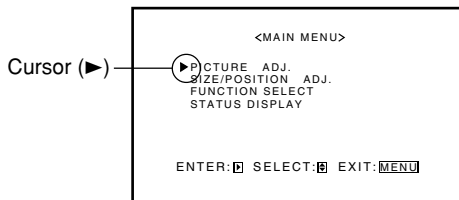

2 Press \blacktriangle / \blacktriangledown to move the cursor (\blacktriangleright) to "FUNCTION SELECT."

3 Press \blacktriangleright to display the Function Selection Menu.

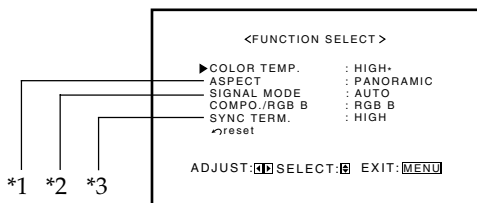

- *1 "ASPECT" does not appear when 720/60p, 720/50p, 1080/60i (1035/60i), or 1080/50i signal is being input through the COMPONENT/RGB B input terminals.
- *2 "SIGNAL MODE" appears only when VIDEO A, VIDEO B, or COMPONENT input is selected.
- *3 "SYNC TERM." appears only when the RGB B input is selected.

4 Press \blacktriangle / \blacktriangledown to move the cursor (\blacktriangleright) to "SYNC TERM."

5 Press \blacktriangleleft / \blacktriangleright to select the terminal resistance.

Each time you press the button, the resistance alternates between "HIGH" and "LOW."

HIGH: Initial setting. Normally select this.

LOW: When using a long connecting cord and the picture flickering and blurring on the screen.

6 Press MENU/EXIT (or MENU on the Monitor) twice to exit the menu operations.

Resetting the Function Selection Menu Settings

You can reset all the Function Selection Menu settings at a time.

1 Press MENU/EXIT (or MENU on the Monitor) to display the Main Menu.

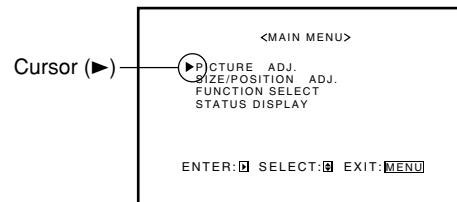

2 Press \blacktriangle / \blacktriangledown to move the cursor (\blacktriangleright) to "FUNCTION SELECT."

3 Press \blacktriangleright to display the Function Selection Menu.

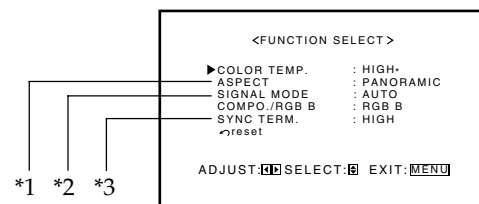

- *1 "ASPECT" does not appear when 720/60p, 720/50p, 1080/60i (1035/60i), or 1080/50i signal is being input through the COMPONENT/RGB B input terminals.
- *2 "SIGNAL MODE" appears only when VIDEO A, VIDEO B, or COMPONENT input is selected.
- *3 "SYNC TERM." appears only when the RGB B input is selected.

4 Press \blacktriangle / \blacktriangledown to move the cursor (\blacktriangleright) to "reset."

5 Press \blacktriangleright .

The confirmation screen appears.



6 Press \blacktriangleright again to reset the adjustments.

To cancel the reset, press MENU/EXIT (or MENU on the Monitor).

7 Press MENU/EXIT (or MENU on the Monitor) twice to exit the menu operations.

Other Convenient Functions

Showing On-screen Display

The input mode and signal type will be indicated on the screen.

- You can also show these information by pressing DISPLAY on the remote control. (See page 14.)

1 Press MENU/EXIT (or MENU on the Monitor) to display the Main Menu.

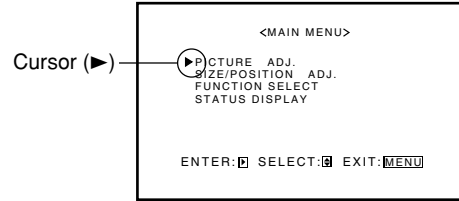

2 Press ▲/▼ to move the cursor (▶) to "STATUS DISPLAY."

3 Press ▶ to display the current input terminal and received signal type.

Ex. When selecting "VIDEO A" or "VIDEO B" input

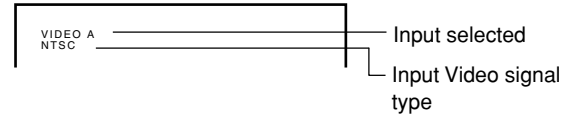

Ex. When selecting "COMPONENT" input

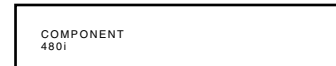

Ex. When selecting "RGB A" or "RGB B" input

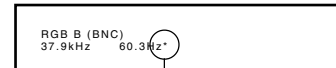

When the signal being input is a preset video mode, an "*" will be shown after the frequency.

Note:

- If you want to make these information appear automatically when you change the input mode, see "Showing the On-screen When Changing the Input Mode" on page 23.

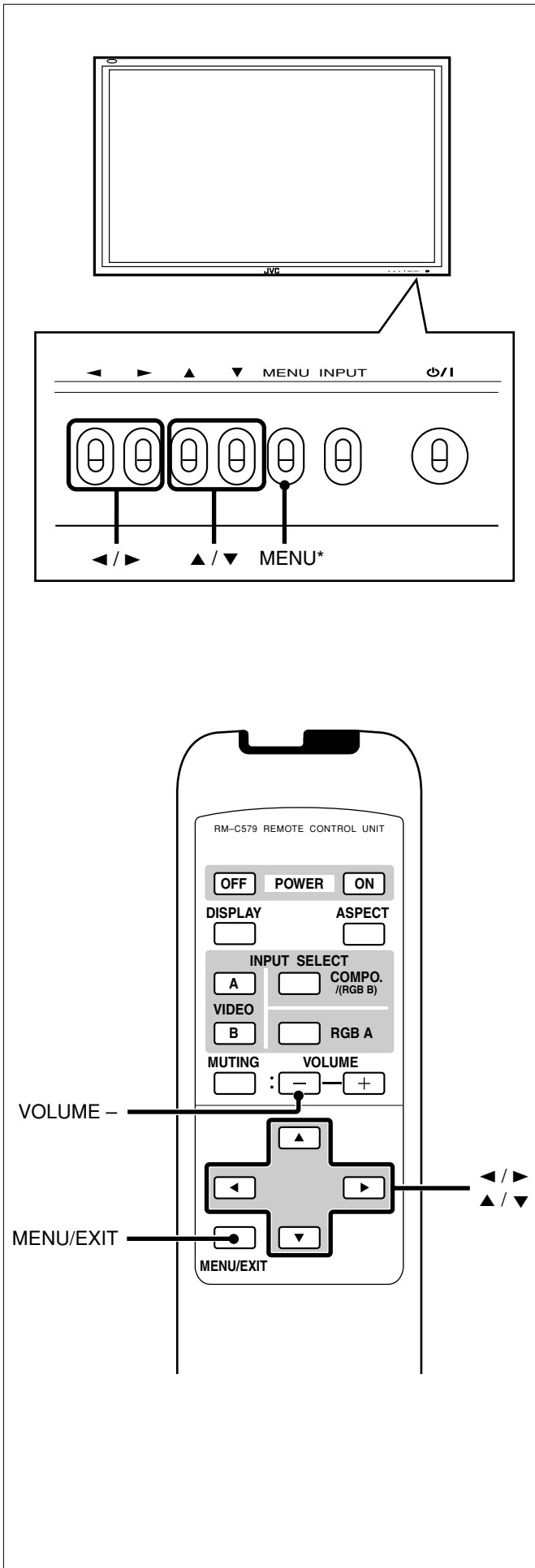

Showing the On-screen When Changing the Input Mode

With this function, you can see the selected input mode and signal type when changing the input mode.

- 1 On the remote control:**
Press **VOLUME** – while holding **MENU/EXIT** to display the Setup Menu.
On the Monitor:
Press **◀** while holding **MENU** to display the Setup Menu.

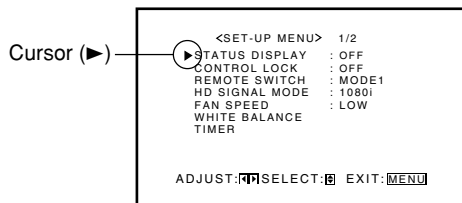

- 2 Press ▲/▼ to move the cursor (▶) to "STATUS DISPLAY."**
 - The Setup Menu consists of two pages. If you keep pressing ▲/▼, you can move to the other page from the current page.
- 3 Press ◀/▶ to select the desired setting.**
Each time you press the button, the Status Display function alternates between "ON" and "OFF."
To cancel the Status Display function, select "OFF."
- 4 Press MENU/EXIT (or MENU on the Monitor) once to exit from the menu operations.**

Prohibiting the Monitor's Button Operations

This function allows you to prohibit the button operations on the Monitor to prevent malfunction or avoid tampering.

- 1 On the remote control:**
Press **VOLUME** – while holding **MENU/EXIT** to display the Setup Menu.
On the Monitor:
Press **◀** while holding **MENU** to display the Setup Menu.

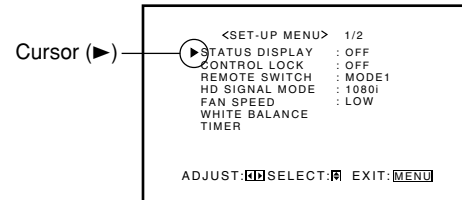

- 2 Press ▲/▼ to move the cursor (▶) to "CONTROL LOCK."**
 - The Setup Menu consists of two pages. If you keep pressing ▲/▼, you can move to the other page from the current page.
- 3 Press ◀/▶ to select the desired setting.**
Each time you press the button, the Control Lock function alternates between "ON" and "OFF."
To cancel the Control Lock function, select "OFF."
- 4 Press MENU/EXIT (or MENU on the Monitor) once to exit from the menu operations.**

Note:

- Even when the Control Lock function is in use, the following operations are possible:
 - Operation to cancel the Control Lock function
 - All operations from the remote control

Other Convenient Functions (Continued)

Setting the Remote-Controllable Input

When connecting the external control unit to the REMOTE MAKE terminal, you need to set the desired input to use, which you can select from the connected external control unit.

- 1 On the remote control:**
Press **VOLUME** – while holding **MENU/EXIT** to display the Setup Menu.

On the Monitor:
Press **◀** while holding **MENU** to display the Setup Menu.

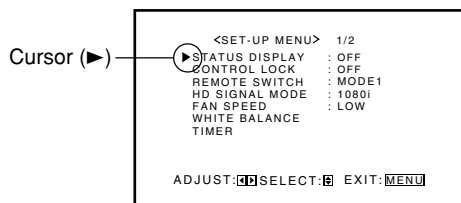

- 2 Press ▲/▼ to move the cursor (▶) to "REMOTE SWITCH."**

- The Setup Menu consists of two pages. If you keep pressing ▲/▼, you can move to the other page from the current page.

- 3 Press ◀/▶ to select the desired setting.**

Each time you press the button, the Remote Switch Mode changes as follows:

- MODE1: Input alternates between "VIDEO A" and "VIDEO B" when controlled from the external control unit.
- MODE2: Input alternates between "VIDEO A" and "COMPONENT/RGB B" when controlled from the external control unit.
- MODE3: Input alternates between "VIDEO A" and "RGB A" when controlled from the external control unit.
- MODE4: Input alternates between "VIDEO B" and "COMPONENT/RGB B" when controlled from the external control unit.
- MODE5: Input alternates between "VIDEO B" and "RGB A" when controlled from the external control unit.
- MODE6: Input alternates between "COMPONENT/RGB B" and "RGB A" when controlled from the external control unit.

- 4 Press MENU/EXIT (or MENU on the Monitor) once to exit from the menu operations.**

Setting the High-Definition Signal Types

You can select one of the High-Definition (HD) signal types through the COMPONENT/RGB B terminals — 1080i or 1035i. Normally set it to "1080i."

- Without setting "COMPO./RGB B" correctly, you cannot show any picture though you select the COMPONENT input (see page 20).

- 1 On the remote control:**
Press **VOLUME** – while holding **MENU/EXIT** to display the Setup Menu.

On the Monitor:
Press **◀** while holding **MENU** to display the Setup Menu.

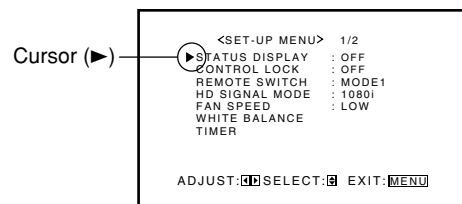

- 2 Press ▲/▼ to move the cursor (▶) to "HD SIGNAL MODE."**

- The Setup Menu consists of two pages. If you keep pressing ▲/▼, you can move to the other page from the current page.

- 3 Press ◀/▶ to select the desired setting.**

Each time you press the button, the HD signal type alternates between "1080i" and "1035i."

- You can select either "1080i" and "1035i" according to the HD signal you input — whichever gives you proportionally shaped pictures.

- 4 Press MENU/EXIT (or MENU on the Monitor) once to exit from the menu operations.**

Setting the Speed of the Internal Cooling Fan

Set the speed of the internal cooling fan to "HIGH" when installing the Monitor vertically, so that the internal heat of the Monitor is released more effectively.

Note:

- When installing the Monitor vertically, it is also required to attach the external cooling fan unit. (See page 13.)

- 1 On the remote control:**
Press **VOLUME** – while holding **MENU/EXIT** to display the Setup Menu.

On the Monitor:

Press **◀** while holding **MENU** to display the Setup Menu.

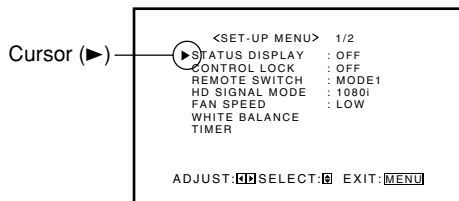

- 2 Press ▲/▼ to move the cursor (▶) to "FAN SPEED."**
 - The Setup Menu consists of two pages. If you keep pressing ▲/▼, you can move to the other page from the current page.
- 3 Press ◀/▶ to select the desired setting.**

Each time you press the button, the speed of the internal cooling fan changes as follows:

LOW: Initial setting. Normally select this.
HIGH: Select this when installing the Monitor vertically.
- 4 Press MENU/EXIT (or MENU on the Monitor) once to exit from the menu operations.**

Adjusting the White Balance

G GAIN, B GAIN and R GAIN can be finely adjusted separately for "HIGH" and "LOW" settings of the color temperature.

- 1 On the remote control:**
Press **VOLUME** – while holding **MENU/EXIT** to display the Setup Menu.

On the Monitor:

Press **◀** while holding **MENU** to display the Setup Menu.

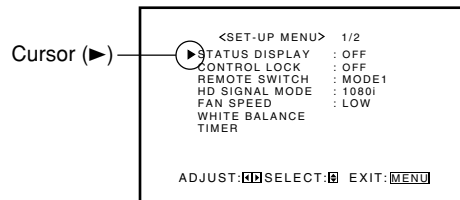

- 2 Press ▲/▼ to move the cursor (▶) to "WHITE BALANCE."**
 - The Setup Menu consists of two pages. If you keep pressing ▲/▼, you can move to the other page from the current page.
- 3 Press ▶ to display the White Balance Adjustment Menu.**

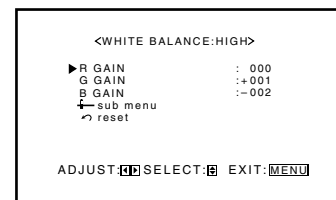

- 4 Press ▲/▼ to move the cursor (▶) to the item you want to adjust.**
- 5 Press ◀/▶ to adjust the selected item.**
- 6 Repeat steps 4 and 5 to adjust the other items.**
- 7 Press MENU/EXIT (or MENU on the Monitor) twice to exit from the menu operations.**

Notes:

- Adjustable range will vary among the Monitors.
- "MAX" may appear soon after you begin adjustment. This is normal but not a malfunction.

(To be continued on the next page)

Other Convenient Functions (Continued)

To make an adjustment while viewing the adjustment bars

After step 3 on page 25, proceed as follows:

- 1 Press ▲/▼ to move the cursor (▶) to "sub menu."
- 2 Press ▶ to display the Sub Menu.

The Sub Menu for R GAIN appears on the screen.

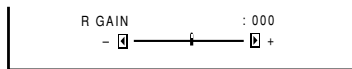

- 3 Press ▲/▼ to select the Sub Menu you want to adjust. Each time you press the button, the Sub Menu changes as follows:

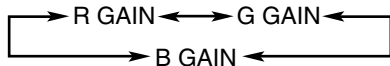

- 4 Press ◀/▶ to adjust the selected item.
- 5 Repeat steps 3 and 4 to adjust the other items.
- 6 Press MENU/EXIT (or MENU on the Monitor) three times to exit from the menu operations.

To reset the adjustments

After step 3 on page 25, proceed as follows:

- 1 Press ▲/▼ to move the cursor (▶) to "reset."
- 2 Press ▶.

The confirmation screen appears.

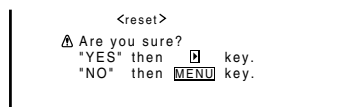

- 3 Press ▶ again to reset the adjustments.

To cancel the reset, press MENU/EXIT (or MENU on the Monitor).

Setting the Clock and the Power On/Off Timer

You can turn the Monitor on and off automatically with the Power On/Off timer.

- Since you cannot use the timer functions without setting the clock, set the clock at first.

• Setting the Clock

You can also adjust the clock with the following procedure.

- 1 **On the remote control:**
Press VOLUME – while holding MENU/EXIT to display the Setup Menu.
- On the Monitor:**
Press ◀ while holding MENU to display the Setup Menu.

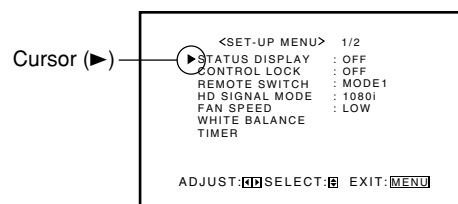

- 2 Press ▲/▼ to move the cursor (▶) to "TIMER," then press ▶ to display the Timer Menu.

- The Setup Menu consists of two pages. If you keep pressing ▲/▼, you can move to the other page from the current page.

Before the clock setting

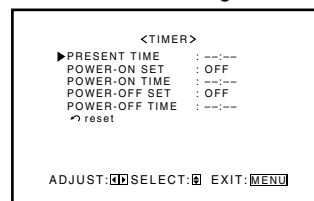

After the clock setting

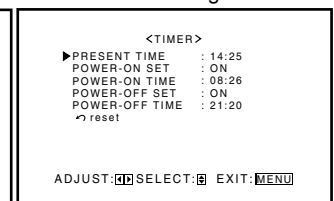

- 3 Press ▲/▼ to move the cursor (▶) to "PRESENT TIME," then press ▶.
- 4 Press ▲/▼ to move the cursor (▶) to "HOURS," then press ◀/▶ repeatedly to adjust the hour (24 hour clock).
- 5 Press ▲/▼ to move the cursor (▶) to "MINUTES," then press ◀/▶ repeatedly to adjust the minute.
- 6 Press MENU/EXIT (or MENU on the Monitor) three times to exit from the menu operations.

• Using the Power On/Off Timer

Select the item you want to set in step 3 in "Setting the Clock" (page 26) and follow the instructions below.

POWER-ON SET

You can activate/deactivate the Power-On Timer.

Press ◀/▶ to select "ON" or "OFF."

ON: The Monitor automatically turns on at the time set in "POWER-ON TIME."

OFF: The Power-On Timer is deactivated.

POWER-ON TIME

You can adjust the time to turn on the Monitor.

Set the hour and minute following steps 4 to 6 in "Setting the Clock" (page 26).

POWER-OFF SET

You can activate/deactivate the Power-Off Timer.

Press ◀/▶ to select "ON" or "OFF."

ON: The Monitor automatically turns off at the time set in "POWER-OFF TIME."

OFF: The Power-Off Timer is deactivated.

POWER-OFF TIME

You can adjust the time to turn off the Monitor.

Set the hour and minute following steps 4 to 6 in "Setting the Clock" (page 26).

To reset the timer setting

After step 2 on page 26, proceed as follows:

1 Press ▲/▼ to move the cursor (▶) to "reset."

2 Press ▶.

The confirmation screen appears.

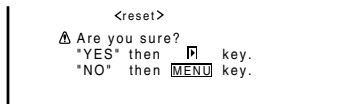

3 Press ▶ again to reset the setting.

To cancel the reset, press MENU/EXIT (or MENU on the Monitor).

About the Timer Battery

The timer clock works on the battery embedded in the Monitor.

If the battery becomes weak or has already run out, a message appears on the TIMER, COLOR-REVERSE, and REFRESH menus.

When the battery becomes weak (BATTERY LOW)

"BATTERY LOW" appears on the screen.

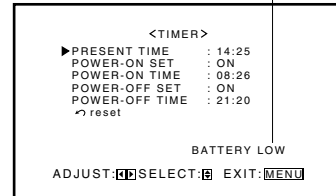

When the battery has run out (BATTERY EMPTY)

"BATTERY EMPTY" appears on the screen.

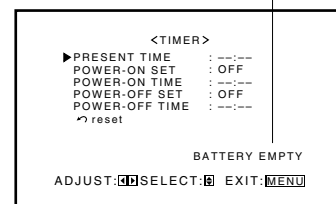

The clock is reset and "PRESENT TIME" is shown as "-- : --."

- You cannot replace the battery yourself. Please consult your dealer to replace it.
- Set the clock and the timer functions (Power On/Off Timer, Color-Reverse On/Off Timer, and Refresh On/Off Timer) again after replacing the battery.
- You can use functions other than the timer functions without replacing the battery.

Other Convenient Functions (Continued)

Using the Pixel Shift Function

This function periodically shift the position (pixels) of the displayed picture on the screen so that you can avoid the screen from being burned in.

- 1 On the remote control:**
Press **VOLUME** – while holding **MENU/EXIT** to display the Setup Menu.

On the Monitor:
Press **◀** while holding **MENU** to display the Setup Menu.

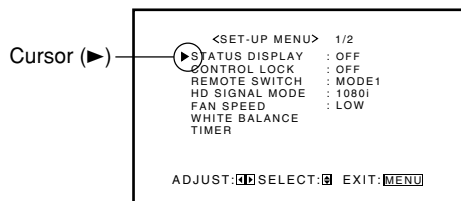

- 2 Press ▲/▼ to move the cursor (▶) to "PIXEL SHIFT" (on the second page).**
 - The Setup Menu consists of two pages. If you keep pressing ▲/▼, you can move to the other page from the current page.

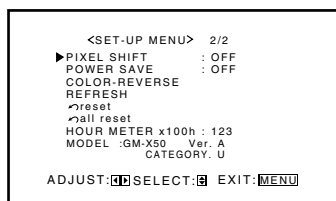

- 3 Press ◀/▶ to select the desired setting.**
Each time you press the button, the Pixel Shift function alternates between "ON" and "OFF."
To cancel the Pixel Shift function, select "OFF."
- 4 Press MENU/EXIT (or MENU on the Monitor) once to exit from the menu operations.**

Using the Power Save Function

You can use this function to reduce the electrical consumption and to extend the lifetime of the Monitor's screen.

- The brightness of the screen will be reduced.

- 1 On the remote control:**
Press **VOLUME** – while holding **MENU/EXIT** to display the Setup Menu.

On the Monitor:
Press **◀** while holding **MENU** to display the Setup Menu.

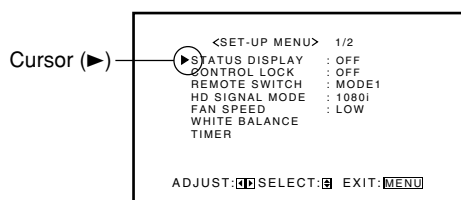

- 2 Press ▲/▼ to move the cursor (▶) to "POWER SAVE" (on the second page).**
 - The Setup Menu consists of two pages. If you keep pressing ▲/▼, you can move to the other page from the current page.

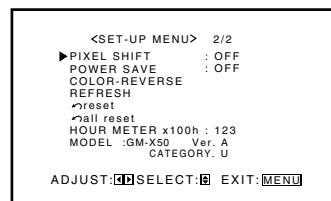

- 3 Press ◀/▶ to select the desired setting.**
SAVE1: The screen gets dim.
SAVE2: The screen gets dimmer.
OFF: The Power Save function is deactivate.
To cancel the Power Save function, select "OFF."
- 4 Press MENU/EXIT (or MENU on the Monitor) once to exit from the menu operations.**

Reducing the Afterimage Effect

If the same image (pattern) is continuously displayed on the screen for a long time, the area on the screen corresponding to the image may vary in brightness, leaving an afterimage on the screen.

You can reduce the afterimage by reversing the color of the image on the screen.

You can activate/deactivate the function with the Color-Reverse On/Off Timer.

- Display the image which has been caused the afterimage on the screen before starting the following procedure.

- 1 On the remote control:**
Press **VOLUME** – while holding **MENU/EXIT** to display the Setup Menu.
- On the Monitor:**
Press **◀** while holding **MENU** to display the Setup Menu.

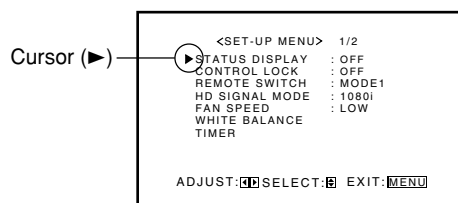

2 Press ▲/▼ to move the cursor (▶) to "COLOR-REVERSE" (on the second page), then press ▶.

- The Setup Menu consists of two pages. If you keep pressing ▲/▼, you can move to the other page from the current page.

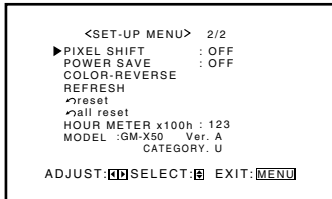

3 Press ▲/▼ to select the item you want to set and set the item as follows.

COLOR-REVERSE

You can activate/deactivate the function manually.

Press ◀/▶ to select the desired setting.

- ON: The function is activated immediately after exiting the menu operations.
- OFF: The function is deactivated.
- TIMER: Select this when you use the Color-Reverse On/Off Timer.

Note:

- Set the clock (see page 26) and select "TIMER," before using the Color-Reverse On/Off Timer.

START SET

You can activate/deactivate the Color-Reverse On Timer.

Press ◀/▶ to select "ON" or "OFF."

- ON: The function is automatically activated at the time set in "START TIME."
- OFF: The Color-Reverse On Timer is deactivated.

START TIME

You can adjust the time to activate the function.

- Set the hour and minute following steps 4 to 6 in "Setting the Clock" (page 26).

END SET

You can activate/deactivate the Color-Reverse Off Timer.

- Press ◀/▶ to select "ON" or "OFF."
 - ON: The function is automatically deactivated at the time set in "END TIME."
 - OFF: The Color-Reverse Off Timer is deactivated.

END TIME

You can adjust the time to deactivate the function.

- Set the hour and minute following steps 4 to 6 in "Setting the Clock" (page 26).

4 Press MENU/EXIT (or MENU on the Monitor) repeatedly to exit from the menu operations.

To reset the Color-Reverse setting

After step 2 on the left column, proceed as follows:

- 1 Press ▲/▼ to move the cursor (▶) to "reset."
- 2 Press ▶.

The confirmation screen appears.

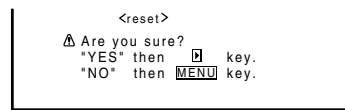

- 3 Press ▶ again to reset the setting.

To cancel the reset, press MENU/EXIT (or MENU on the Monitor).

Notes:

- The Color-Reverse function requires considerable time to reduce the afterimage. Deactivate the function temporarily at intervals of 30 minutes-1 hour and check the screen if the afterimage still remains or not. Set the function to off if the afterimage has been reduced.

Refreshing the Screen

After the power is turned off, a whitish image may be left on the screen. In that case, leave the monitor in a white back state for a while, and the image will disappear.

You can activate/deactivate the function with the Refresh On/Off Timer.

- 1 **On the remote control:**
Press VOLUME – while holding MENU/EXIT to display the Setup Menu.

- 1 **On the Monitor:**
Press ◀ while holding MENU to display the Setup Menu.

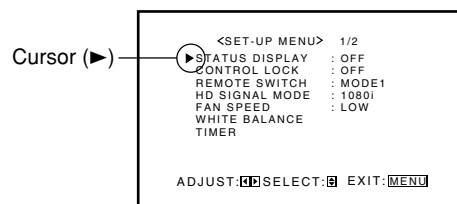

- 2 Press ▲/▼ to move the cursor (▶) to "REFRESH" (on the second page) then press ▶.

- The Setup Menu consists of two pages. If you keep pressing ▲/▼, you can move to the other page from the current page.

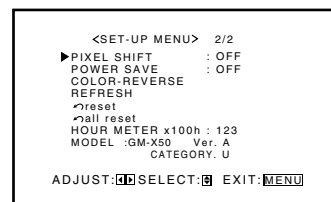

(To be continued on the next page)

Other Convenient Functions (Continued)

3 Press ▲/▼ to select the item you want to set and set the item as follows.

REFRESH

You can activate/deactivate the function manually.

- Press ◀/▶ to select the desired setting.

ON: The function is activated immediately after exiting the menu operations.

OFF: The function is deactivated.

TIMER: Select this when you use the Refresh On/Off Timer.

Note:

- Set the clock (see page 26) and select "TIMER," before using the Refresh On/Off Timer.

START SET

You can activate/deactivate the Refresh On Timer.

- Press ◀/▶ to select "ON" or "OFF."

ON: The function is automatically activated at the time set in "START TIME."

OFF: The Refresh On Timer is deactivated.

START TIME

You can adjust the time to activate the function.

- Set the hour and minute following steps 4 to 6 in "Setting the Clock" (page 26).

END SET

You can activate/deactivate the Refresh Off Timer.

- Press ◀/▶ to select "ON" or "OFF."

ON: The function is automatically deactivated at the time set in "END TIME."

OFF: The Refresh Off Timer is deactivated.

END TIME

You can adjust the time to deactivate the function.

- Set the hour and minute following steps 4 to 6 on "Setting the Clock" (page 26).

4 Press MENU/EXIT (or MENU on the Monitor) repeatedly to exit from the menu operations.

To reset the Refresh function setting

After step 2 above, proceed as follows:

- 1 Press ▲/▼ to move the cursor (▶) to "reset."

- 2 Press ▶.

The confirmation screen appears.

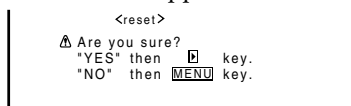

- 3 Press ▶ again to reset the setting.

To cancel the reset, press MENU/EXIT (or MENU on the Monitor).

Notes:

- The Refresh function requires considerable time to reduce the afterimage. Deactivate the function temporarily at intervals of 30 minutes-1 hour and check the screen if the afterimage still remains or not. Set the function to off if the afterimage has been reduced.

Notes on the Color-Reverse/Refresh Timer

- Once you set the Color-Reverse/Refresh timer, the timer function is still activated even if you turn off the power. If you turn on the power after the "START TIME" you set, Color-Reverse/Refresh function is activated. To cancel the function, select "OFF" in the menu (see pages 29 and 30).
- The Color-Reverse timer is deactivated when you turn on or off the Color-Reverse function manually. The Refresh timer works in the same way as mentioned above. Select "TIMER" in the menu to control the functions automatically (see pages 29 and 30).

Resetting All the Setup Menu Settings

You can reset all the following Setup Menu settings at a time, except the use time (HOUR METER).

- 1 **On the remote control:**
Press VOLUME – while holding MENU/EXIT to display the Setup Menu.
On the Monitor:
Press ◀ while holding MENU to display the Setup Menu.

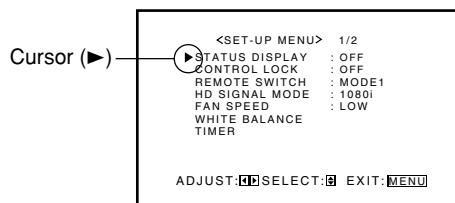

- 2 Press ▲/▼ to move the cursor (▶) to "reset" (on the second page).

- The Setup Menu consists of two pages. If you keep pressing ▲/▼, you can move to the other page from the current page.

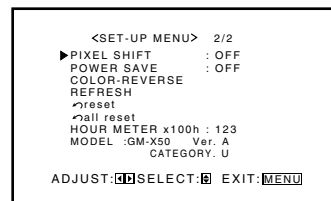

3 Press ►.

The confirmation screen appears.

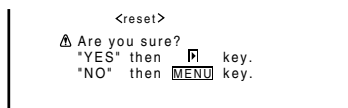

To cancel the reset, press MENU/EXIT (or MENU on the Monitor).

4 Press ► again to reset all the Setup Menu settings.

5 Press MENU/EXIT (or MENU on the Monitor) once to exit from the menu operations.

Resetting All the Menu Settings

You can reset all the Menu settings and adjustments at a time, except the use time (HOUR METER).

1 On the remote control: Press VOLUME – while holding MENU/EXIT to display the Setup Menu.

On the Monitor:
Press ◀ while holding MENU to display the Setup Menu.

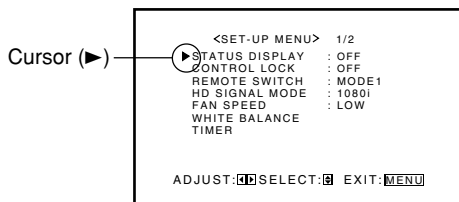

2 Press ▲/▼ to move the cursor (▶) to "all reset" (on the second page).

- The Setup Menu consists of two pages. If you keep pressing ▲/▼, you can move to the other page from the current page.

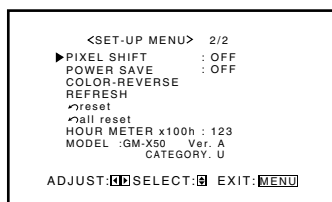

3 Press ►.

The confirmation screen appears.

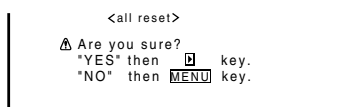

To cancel the reset, press MENU/EXIT (or MENU on the Monitor).

4 Press ► again to reset all the Menu settings and adjustments.

The power is turned off, then turned on again automatically.

Confirming the Use Time and Model Information

You can confirm the hours of use and the model information on the Setup Menu.

This may be necessary when you ask for any service.

1 On the remote control: Press VOLUME – while holding MENU/EXIT to display the Setup Menu.

On the Monitor:
Press ◀ while holding MENU to display the Setup Menu.

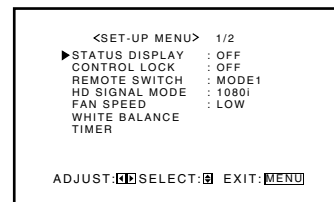

2 Keep pressing ▲/▼ until the second page of the Setup Menu appears.

- The Setup Menu consists of two pages. If you keep pressing ▲/▼, you can move to the other page from the current page.

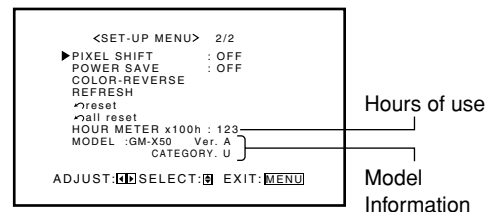

3 Confirm the hour of use and model information.

- The displayed value for the hours of use is divided by 100. To calculate the actual hours of use, multiply the displayed value by 100.

4 Press MENU/EXIT (or MENU on the Monitor) once to exit from the menu operations.

Notes:

- The value for the hours of use is added by one hour unit. If you use the monitor within one hour, it will not be added to the hours of use.
- The period when the monitor is on standby (the power lamp glows orange) will not be added to the hours of use.

Menu Classifications

Main Menu

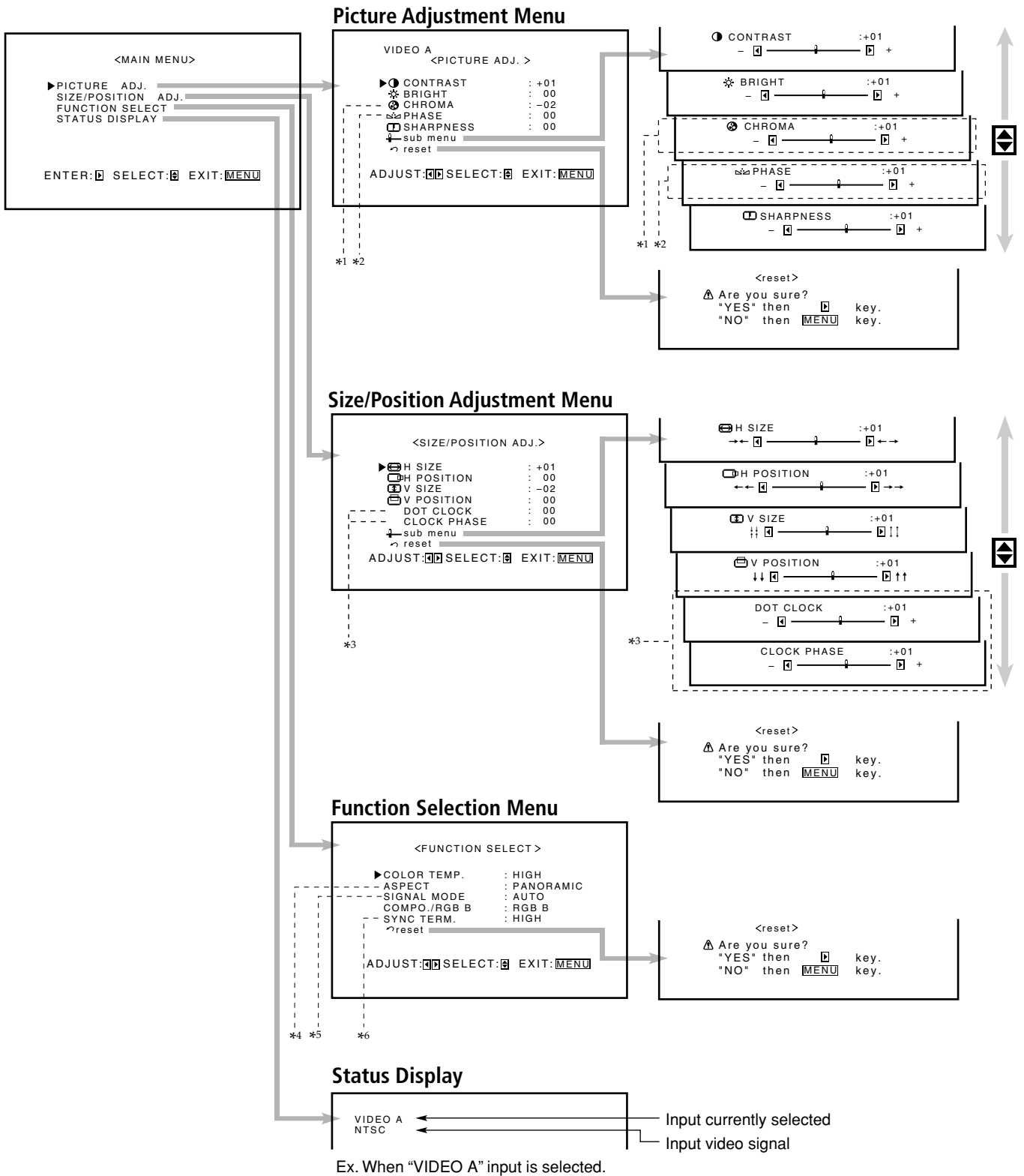

PICTURE ADJ. (Picture adjustment): See page 16.

CONTRAST	Adjusts the contrast of the picture.
BRIGHT	Adjusts the brightness of the picture.
CHROMA* ¹	Adjusts the color density of the picture.
PHASE* ²	Adjusts the color phase.
SHARPNESS	Adjusts the outlines of the picture.
sub menu	Displays the fine adjustment bar.
reset	Resets the Picture Adjustment Menu settings to defaults.

SIZE/POSITION ADJ. : See page 17.

H SIZE	Adjusts the horizontal screen size.
H POSITION	Adjusts the horizontal screen position.
V SIZE	Adjusts the vertical screen size.
V POSITION	Adjusts the vertical screen position.
DOT CLOCK* ³	Adjusts to eliminate stripes or flickering. Use with "CLOCK PHASE." Normally, no adjustment is needed.
CLOCK PHASE* ³	Adjusts to eliminate stripes or flickering. Use with "DOT CLOCK." Normally, no adjustment is needed.
sub menu	Displays the fine adjustment bar.
reset	Resets Size/position Adjustment Menu settings to defaults.

FUNCTION SELECT: See pages 19 to 21.

COLOR TEMP.	Adjusts the color temperature. Use when the picture is reddish or bluish.
ASPECT* ⁴	Selects the horizontal to vertical ratio of the screen.
SIGNAL MODE* ⁵	<ul style="list-style-type: none">• Selects a color system (NTSC, PAL M, PAL N) when VIDEO A or VIDEO B input is selected. Normally, set to "AUTO."• Selects a scan system—480i, 576i, 480p, 576p, 720/60p, 720/50p, 1080/60i (1035i), 1080/50i—when COMPONENT input is selected. Normally, set to "AUTO."
COMPO./RGB B	Selects the usage of the COMPONENT/RGB B terminals either as the COMPONENT input terminal or as the RGB B input terminal.
SYNC TERM.* ⁶	Adjusts the resistance of RGB B input terminals.
reset	Resets the Function Selection Menu settings to defaults.

STATUS DISPLAY: See page 22.

Shows the input mode and signal type on the screen.

*¹ Adjustable when viewing the NTSC or PAL signal, or component signal.

*² Adjustable when viewing the NTSC signal or component signal.

*³ Adjustable when RGB A or RGB B input is selected.

*⁴ Not adjustable when viewing the following component signals—720/60p, 720/50p, 1080/60i (1035/60i), and 1080/50i. (In such a case, "ASPECT" does not appear on the display.)

*⁵ Adjustable when VIDEO A, VIDEO B, or COMPONENT input is selected.

*⁶ Adjustable when RGB B input is selected.

Menu Classifications (Continued)

Setup Menu

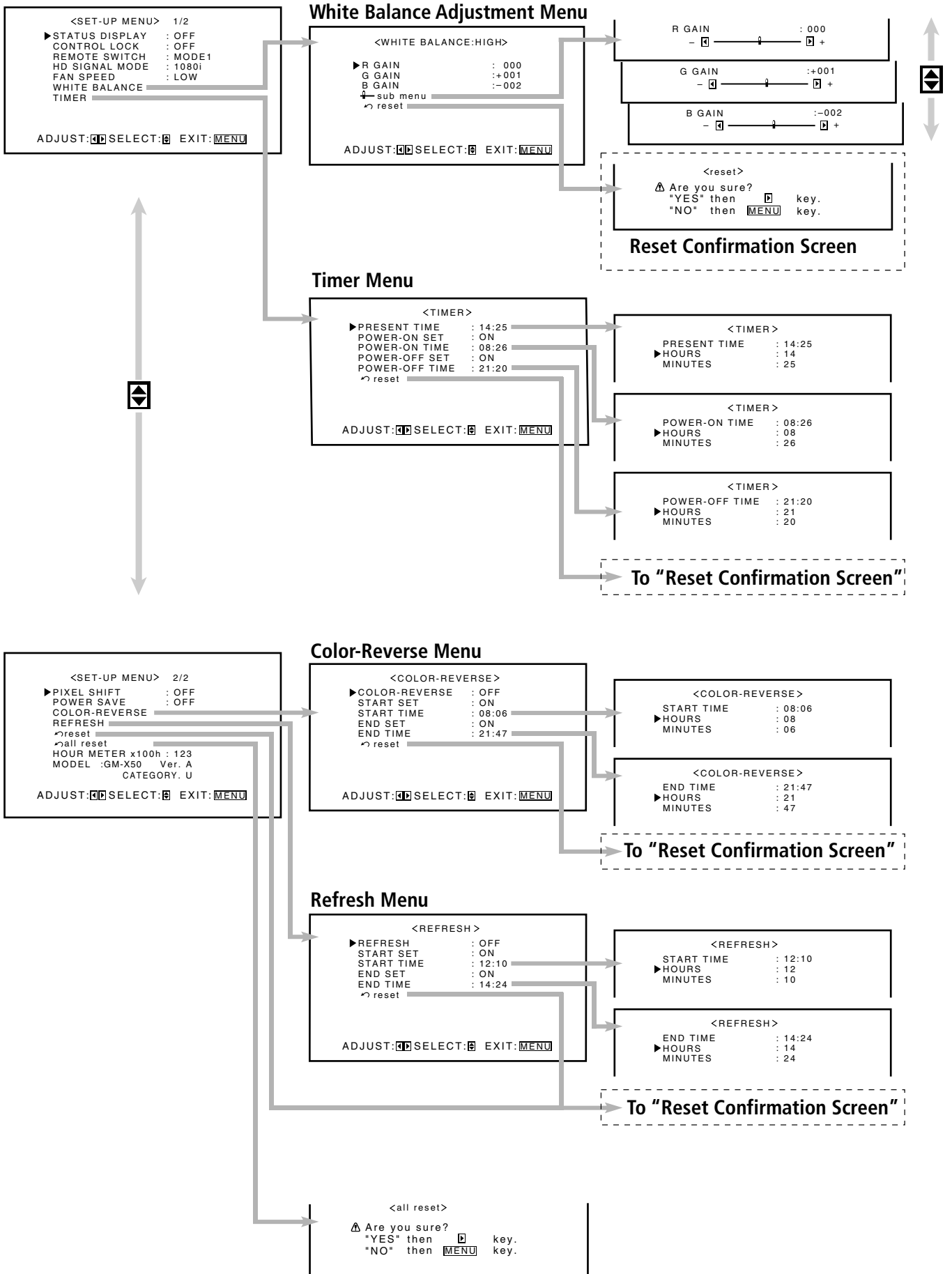

STATUS DISPLAY: See page 23.

Sets if you want the input terminal and the type of signal to be indicated on the screen just after inputs are switched.

CONTROL LOCK: See page 23.

Sets the Monitor so that it cannot be operated with the buttons on itself.

REMOTE SWITCH: See page 24.

Set the selectable input terminals when controlling the Monitor with the external control unit.

HD SIGNAL MODE: See page 24.

Select the High-Definition (HD) signal type.

FAN SPEED: See page 25.

Sets the speed of the internal cooling fan.

WHITE BALANCE: See page 25.

Adjusts R GAIN, G GAIN and B GAIN finely each for "HIGH" and "LOW" settings of the color temperature.

TIMER: See pages 26 and 27.

Sets the clock and the Power On/Off Timer.

PIXEL SHIFT: See page 28.

Sets a screen saver.

POWER SAVE: See page 28.

Sets the power save function.

COLOR-REVERSE: See page 28.

Use to reduce the afterimage on the screen of the still picture by reversing the color.

REFRESH: See page 29.

Use to reduce the whitish image remaining on the screen after turning off the power.

reset: See page 30.

Resets the Setup Menu settings to defaults.

all reset: See page 31.

Resets the all menu settings and adjustments to defaults.

HOUR METER x 100h: See page 31.

Use to confirm the hours of use.

MODEL: See page 31.

Use to confirm the model information of the Monitor.

Troubleshooting

Solutions to common problems related to the Monitor are described here. If none of the solutions presented here solves the problem, unplug the Monitor and consult an authorized dealer or service center.

Symptom	Probable cause	Corrective action	Page
Power is not supplied.	• Is the power cord disconnected?	• Insert the power cord (plug) firmly.	12
	• Is the POWER switch turned on?	• Turn on the POWER switch.	14
Power is suddenly turned on or off.	• Is the Power On/Off Timer activated?	• Set the timer to "OFF" on the menu.	26
Video image does not appear, or audio sound does not occur.	• Is the correct input selected?	• Select the correct input by pressing INPUT SELECT (VIDEO A, VIDEO B, COMPO./ (RGB B) or RGB A) on the remote control (or INPUT on the Monitor).	14
	• Are the devices connected correctly?	• Connect the devices correctly.	11, 12
	• Are signals being supplied from the connected devices?	• Set the devices correctly.	—
	• Is "COMPO./RGB B" set correctly if using the COMPONENT/RGB B terminals?	• Set it correctly.	20
	• Are input signals (scanning frequency, etc.) appropriate?	• Check if the signal is appropriate (scanning frequency, etc.), and input the appropriate signal.	10
	• Is brightness adjusted correctly?	• Adjust brightness on the menu.	16
	• Is volume set at minimum?	• Adjust volume.	14
	• Are the diagnostic lamps turned on?	• Refer to "Self-diagnostic Indication," and take an appropriate action.	37
The picture becomes blurred.	• Is the signal RGB input?	• Adjust DOT CLOCK and CLOCK PHASE using the menu.	17
	• Is the RGB B connecting cord long?	• Set the SYNC TERM. "LOW."	21
Color is abnormally dark or bright.	• Is brightness adjusted correctly?	• Adjust BRIGHT (brightness) using the menu.	16
	• Is picture quality (color density, etc.) adjusted correctly?	• Adjust picture using the menu.	16
	• "TEMP. OVER" lights (or flashes) at the right bottom of the screen.	• Refer to "Self-diagnostic Indication," and take an appropriate action.	37
Color is poor or unstable.	• Is the correct broadcast system (color system) selected?	• Set SIGNAL MODE (color system) to "AUTO."	20
	• Are signals (scanning frequency, etc.) to connected devices appropriate?	• Check if the signal is appropriate (scanning frequency, etc.), and input the appropriate signal.	10
Color is suddenly reversed or whitened.	• Is the Color-Reverse/Refresh timer activated?	• Set "COLOR-REVERSE" / "REFRESH" to "OFF" on the menu.	29, 30
The picture is cut or shifted toward one side.	• Is the size or position of the screen adjusted properly?	• Adjust H SIZE, V SIZE, H POSITION or V POSITION using the menu.	17
The remote control does not work.	• Are the batteries correctly set?	• Insert batteries correctly, observing the polarities (⊕ and ⊖).	8
	• Are the batteries exhausted?	• Replace with new batteries.	8
	• Is there any object blocking the path between the remote control and remote sensor?	• Remove any blocking object.	—
	• Is the Monitor too far away from you?	• Move toward the Monitor, then operate the remote control.	—
The buttons on the Monitor do not work.	• Is the Control Lock function in use?	• Set the Control Lock function to "OFF" using the menu.	23

Self-diagnostic Indication

When something abnormal occurs with the Monitor, this function informs you of the condition of the Monitor with self-diagnostic lamps, allowing for smooth service work.

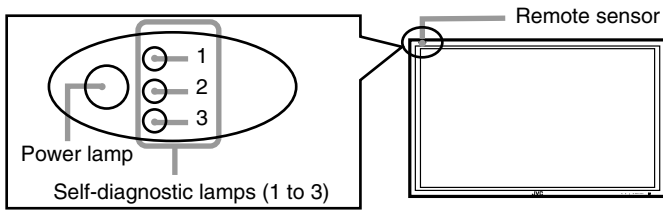

If the screen monitor turns off and self-diagnostic lamps light or flash

If the self-diagnostic lamps light or flash in red, check the following before consulting the dealer where you purchased the Monitor.

- **If self-diagnostic lamp 1 (upper) flashes, lamp 2 (middle) lights, and lamp 3 (lower) flashes**

This may be caused by the dusty intakes on the rear. If this happens, switch off the main power by POWER switch (set to "O (off)"), unplug the AC power cord, then clean the intakes by referring to the instruction on page 2.

- After cleaning, switch on the Monitor's main power again. If self-diagnostic lamps do not go off, consult your dealer immediately.

If the screen monitor dims a little and "TEMP. OVER" lights (or flashes)

If "TEMP. OVER" lights or flashes at the right bottom of the screen, check the following before consulting the dealer where you purchased the Monitor.

"TEMP. OVER" appears to warn you of the internal heat buildup, which is usually caused by accumulated dust around the intakes or by improper installation. If the cause of the internal heat buildup is eliminated, this indication disappears and the screen recovers the brightness.

- **If "TEMP. OVER" flashes in yellow**

This may be caused by the dusty intakes on the rear. If this happens, switch off the main power by POWER switch (set to "O (off)"), unplug the AC power cord, then clean the intakes by referring to the instruction on page 2.

- After cleaning, switch on the Monitor's main power again. If "TEMP. OVER" still flashes, this trouble may be caused by improper installation or improper location of the Monitor. In this case, consult your dealer immediately to solve this improper installation and to improve the circumstances around the Monitor.

- **If "TEMP. OVER" lights in red**

"TEMP. OVER" will be shown for about two minutes, the Monitor will shut off automatically, then the Self-diagonal lamps light in red. If this happens, switch off the main power by POWER switch (set to "O (off)"), unplug the AC power cord, then consult your dealer immediately.

If the trouble still persists, follow the procedure below:

1 Check which lamps are lighting or flashing.

On the Self-diagnostic Report Sheet (below), check the box next to "Lights" or "Flashes" of the corresponding lamp or lamps.

- Only one lamp may light or flash, or all three lamps may do so.

2 Switch off the POWER switch on the back of the Monitor.

3 Unplug the power cord.

4 Call your dealer and tell which lamps are lighting or flashing. (Copy and fax the Self-diagnostic Report Sheet below.)

Note:

If you switch on the main power immediately after switching it off (or after recovering from a brief power interruption), the self-diagnostic lamps may light (or flash), and no image may appear on the screen. In this case, switch off the main power again, wait for about 10 seconds, then switch it on again. If no self-diagnostic lamps light or flash, you can operate and use the Monitor as usual.

Self-diagnostic Report Sheet

Store name where you purchased the Monitor

To

Model Name:

Plasma Display Monitor

GM-X50U

The self-diagnostic lamps light or flash as listed on the following table. Please give me immediate advice or service if necessary.

Self-diagnostic lamps			
NO.	Lamp position	Conditions	
1	Upper	<input type="checkbox"/> Lights	<input type="checkbox"/> Flashes
2	Middle	<input type="checkbox"/> Lights	<input type="checkbox"/> Flashes
3	Lower	<input type="checkbox"/> Lights	<input type="checkbox"/> Flashes
TEMP. OVER		<input type="checkbox"/> Lights	<input type="checkbox"/> Flashes

Your Name:	
Telephone No.:	
Address:	

Specifications

	Model name	GM-X50U		
General	Frame color	Silver		
	Screen size	Type 50 wide format		
	Aspect ratio	16:9 (Wide format)		
	Number of pixels displayed	1366 (H) x 768 (V)		
	Number of colors displayed	16.77 million (256 colors for each of RGB)		
	Effective screen size (W x H, Diagonally)	110.7 cm x 62.2 cm (43 9/16" x 24 7/16"), 127 cm (50")		
	Weight	50 kg (110 lbs.)		
	External dimensions (W x H x D)	123.2 cm x 74.3 cm x 10.3 cm (48 5/8" x 29 3/8" x 4 1/8") * Excluding protruding parts		
	Power requirements	AC 120 V, 50 Hz/60 Hz		
	Rated input current	4.0 A		
	Compatible systems			
	VIDEO A, VIDEO B input	NTSC, PAL M, PAL N		
	COMPONENT input	480i, 576i, 480p, 576p, 720/60p, 720/50p, 1080/60i (1035/60i), 1080/50i		
Audio power output	SPEAKER OUT: 6 Ω to 8 Ω 3 W + 3 W (TYP at impedance 6 Ω)			
Operating conditions	Temperature: 0 $^{\circ}$ C to 40 $^{\circ}$ C Relative humidity: 20 % to 80 % (non-condensation) (Slightly variable depending on ambient conditions for installation.)			
Input/output terminals	VIDEO A			
	Video input	BNC terminal x 1, 1 V(p-p), 75 Ω		
	Video output	BNC terminal x 1, 1 V(p-p), 75 Ω		
	Audio input	Pin jack terminal x 2 (L/R) 500 mV(rms), high impedance		
	VIDEO B			
	Y/C input	Y/C terminal x 1 Y: 1 V(p-p), 75 Ω C: 0.286 V(p-p), 75 Ω (for NTSC) C: 0.3 V(p-p), 75 Ω (for PAL)		
	Video input	Pin jack terminal x 1, 1 V(p-p), 75 Ω		
	Audio input	Pin jack terminal x 2 (L/R) 500 mV(rms), high impedance		
	COMPONENT/RGB B *			
	COMPONENT input	BNC terminal x 3 Y: 1 V(p-p), 75 Ω P _B /B-Y: 0.7 V(p-p), 75 Ω P _R /R-Y: 0.7 V(p-p), 75 Ω		
	RGB input	BNC terminal x 5 <u>Analog RGB:</u> R: 0.7 V(p-p), 75 Ω G: 0.7 V(p-p), 75 Ω B: 0.7 V(p-p), 75 Ω G on sync: 1 V(p-p), 75 Ω (negative sync) <u>Horizontal sync/Composite sync (HD/Cs):</u> HD: 0.3 V(p-p) to 5 V(p-p), 1 k Ω (positive/negative polarity) / 75 Ω (positive/negative polarity) Cs: 0.3 V(p-p) to 5 V(p-p), 1 k Ω (positive/negative polarity) / 75 Ω (positive/negative polarity) <u>Vertical sync (VD):</u> VD: 1 V(p-p) to 5 V(p-p), 1 k Ω (positive/negative polarity) / 75 Ω (positive/negative polarity)		
	Audio input	Pin jack terminal x 2 (L/R) 500 mV(rms), high impedance		

Input/output terminals	<div style="border: 1px solid black; display: inline-block; padding: 2px;">RGB A</div> RGB input	D-sub 3-row 15-pin terminal x 1, Video signal: 0.7 V(p-p), 75 Ω G on sync: 1 V(p-p), 75 Ω (negative sync) <u>Horizontal sync/Composite sync (HD/Cs):</u> HD: 0.3 V(p-p) to 5 V(p-p), 470 Ω (positive/negative polarity) Cs: 0.3 V(p-p) to 5 V(p-p), 470 Ω (positive/negative polarity) <u>Vertical sync (VD):</u> VD: 1 V(p-p) to 5 V(p-p), 470 Ω (positive/negative polarity)
	Audio input	Stereo mini jack terminal x 1 500 mV(rms), high impedance
	REMOTE terminals	RS-232C: D-sub 9-pin terminal x 1 MAKE: Mini DIN 4 pin WIRED: Stereo mini jack terminal x 1
	OPTION terminal	Used exclusively for JVC's optional parts
	AUDIO OUT terminals	Pin jack terminal x 2 (L/R) Output impedance 600 Ω
	SPEAKER OUT (L/R) terminals	Impedance 6 Ω to 8 Ω

* To use the COMPONENT/RGB B terminals either as the COMPONENT input terminal or as the RGB B input terminal, you need to set "COMPO./RGB B" correctly (see page 20).

- For easy understanding, pictures and illustrations are shown by being emphasized, omitted or composed, and may be more or less different from actual products.
- Design and specifications are subject to change without notice.
- IBM and IBM PC are registered trademarks of International Business Machines Corporation. Macintosh is registered trademarks of Apple Computer, Inc.
 All other product names mentioned herein are used for identification purposes only, and may be the trademarks or registered trademarks of their respective companies.

Options (not supplied)

Stand Unit	TS-CL01SG, TS-CL02SG
Wall Mounting Unit	TS-C420P2W, TS-C420P6W, TS-C420P8W, TS-C420P9W
Ceiling Suspension Unit	TS-C420P3W
Cooling Fan Unit	TS-C01FANG
Speaker Unit	TS-C500SPG

- Consult your dealer to see if other options are available.

Notice on transportation

This Monitor is precision equipment and needs dedicated packing material for transportation. Never use any packing material supplied from other than JVC or JVC-authorized dealers.

Specifications (Continued)

Pin assignment (Specifications for terminals)

- Y/C terminal

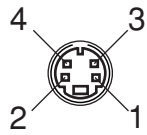

Pin number	Signal name
1	GND (Y)
2	GND (C)
3	Y
4	C

- RS-232C terminal

This is a female type connector.

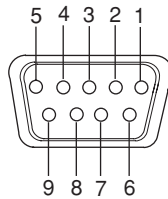

Pin number	Signal name	Pin number	Signal name
1	DCD	6	DSR
2	RD	7	RTS
3	TD	8	CTS
4	DTR	9	RI
5	GND		

- MAKE terminal

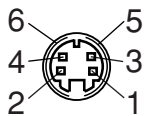

Pin number	Signal name
1	GND
2	GND
3	SW2
4	SW1
5	SW DET
6	GND

- RGB Input Terminal

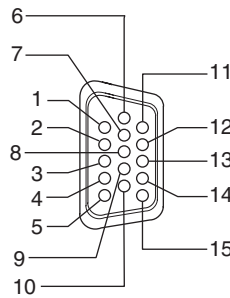

Pin number	Signal name	Pin number	Signal name
1	Red	9	N/C
2	Green	10	GND
3	Blue	11	GND
4	N/C	12	N/C
5	GND	13	HD/Cs
6	GND	14	VD
7	GND	15	N/C
8	GND	External	GND

Dimensions

Top view

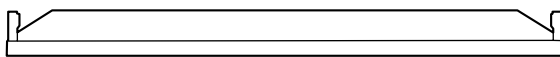

Front view

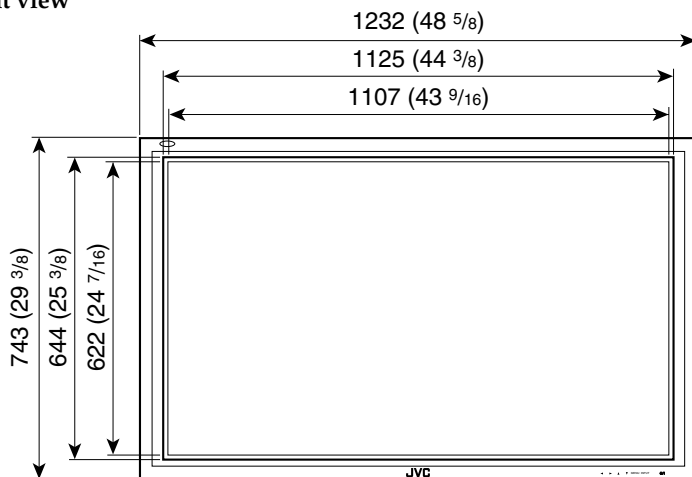

Side view

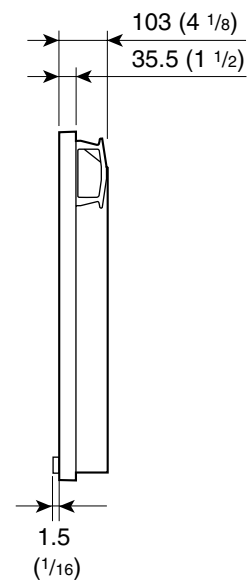

Unit: mm (inch)





ENGLISH

DEUTSCH

FRANÇAIS

ITALIANO

ESPAÑOL

PLASMA DISPLAY MONITOR

BEDIENUNGSANLEITUNG : PLASMABILDSCHIRM

MANUEL D'INSTRUCTIONS : MONITEUR DE VISUALISATION PLASMA

MANUALE D'ISTRUZIONI : MONITOR CON SCHERMO AL PLASMA

MANUAL DE INSTRUCCIONES : MONITOR DISPLAY DE PLASMA

GM-X50E

INSTRUCTIONS

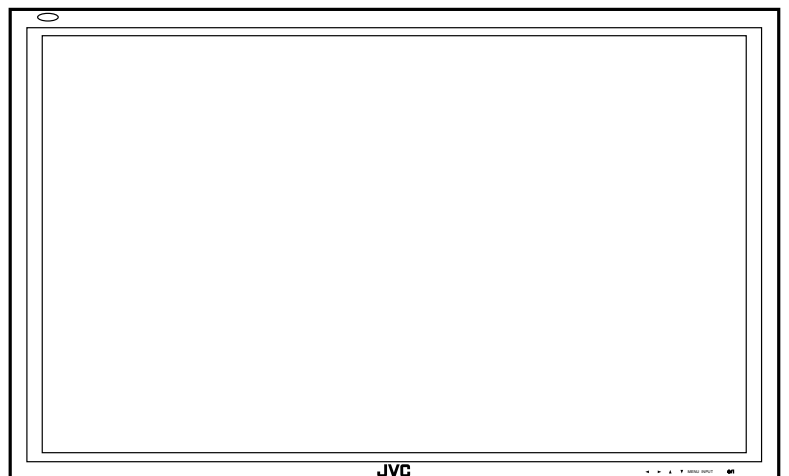

LCT1602-001A-U



INSTRUCTIONS

Model
GM-X50E

*Thank you for purchasing this JVC Monitor.
Before using the monitor, read this manual carefully so that you know how to use the Monitor correctly.
Refer to this manual whenever questions or problems about operation arise. Be sure to read and observe the safety precautions.
Keep this manual where the user can see it easily.
* Installation and removal require special expertise.
Consult your product dealer for details.*

Contents

	Page		Page
Safety Precautions	2	Other Convenient Functions	22
Parts Identification	4	• Showing On-screen Display	22
• Monitor: Front View	4	• Showing the On-screen When Changing the Input Mode	23
• Monitor: Rear Views ①	5	• Prohibiting the Monitor's Button Operations	23
• Monitor: Rear Views ②	6	• Setting the Remote-Controllable Input	24
• Remote Control	7	• Setting the High-Definition Signal Types	24
Preparations	8	• Setting the Speed of the Internal Cooling Fan ..	25
• Checking the Accessories	8	• Adjusting the White Balance	25
• Installing the Batteries	8	• Setting the Clock and the Power On/Off Timer	26
• About the Supplied Ferrite Core	8	• Using the Pixel Shift Function	28
Installation	9	• Using the Power Save Function	28
• Precautions	9	• Preventing the Afterimage Effect	28
Connections	10	• Refreshing the Screen	29
• Precautions	10	• Resetting All the Setup Menu Settings	30
• Available Signals	10	• Resetting All the Menu Settings	31
• Connection Diagrams	11	• Confirming the Use Time and Model Information ...	31
• Connecting an External Control Unit	12	Menu Classifications	32
• External Speaker Connection	13	• Main Menu	32
• Connecting the External Cooling Fan Unit	13	• Setup Menu	34
Basic Operations	14	Troubleshooting	36
• Daily Operations	14	• Self-diagnostic Indication	37
• Changing the Aspect Ratio	15	Specifications	38
Video Adjustments	16		
• Adjusting the Picture Quality	16		
• Adjusting the Screen Size and Position	17		
• Adjusting the Color Temperature	19		
• Changing the Aspect Ratio	19		
• Setting the Receivable Signal Types	20		
• Setting the COMPONENT/RGB B Input	20		
• Changing the Resistance of the RGB B Input Terminals	21		
• Resetting the Function Selection Menu Settings	21		

Safety Precautions

EUROPE EMC STANDARD NOTICE

Warning: This is a class A product. In a domestic environment this product may cause radio interference in which case the user may be required to take adequate measure.

IMPORTANT INFORMATION

WARNING: TO REDUCE THE RISK OF FIRE AND ELECTRIC SHOCK, DO NOT EXPOSE THIS APPARATUS TO RAIN, MOISTURE, DRIPPING OR SPLASHING AND THAT NO OBJECTS FILLED WITH LIQUIDS, SUCH AS VASES, SHALL BE PLACED ON THE APPARATUS.

IMPORTANT SAFEGUARDS

Electrical energy can perform many useful functions. This unit has been engineered and manufactured to assure your personal safety. But **IMPROPER USE CAN RESULT IN POTENTIAL ELECTRICAL SHOCK OR FIRE HAZARD**. In order not to defeat the safeguards incorporated into this product, observe the following basic rules for its installation, use and service. Please read these "Important Safeguards" carefully before use.

- All the safety and operating instructions should be read before the product is operated.
- The safety and operating instructions should be retained for future reference.
- All warnings on the product and in the operating instructions should be adhered to.
- All operating instructions should be followed.
- Unplug this product from the wall outlet before cleaning. Do not use liquid cleaners or aerosol cleaners. Use a damp cloth for cleaning.
- Use a vacuum cleaner to get rid of the dust around the intakes (all the openings) on the rear. If a vacuum is not available, use a cloth and wipe it off. Failure to do so will cause internal heat buildup and, therefore, cause damage to the product.
- Do not use attachments not recommended by the product manufacturer as they may be hazardous.
- Do not use this product near water. Do not use immediately after moving from a low temperature to high temperature, as this causes condensation, which may result in fire, electric shock, or other hazards.
- Do not place this product on an unstable cart, stand, or table. The product may fall, causing serious injury to a child or adult, and serious damage to the product. The product should be mounted according to the manufacturer's instructions, and should use a mount recommended by the manufacturer.
- When the product is used on a cart, care should be taken to avoid quick stops, excessive force, and uneven surfaces which may cause the product and cart to overturn, damaging equipment or causing possible injury to the operator.
- Slots and openings in the cabinet are provided for ventilation. These ensure reliable operation of the product and protect it from overheating. These openings must not be blocked or covered. (The openings should never be blocked by placing the product on bed, sofa, rug, or similar surface. It should not be placed in a built-in installation such as a bookcase or rack unless proper ventilation is provided and the manufacturer's instructions have been adhered to.)
For proper ventilation, separate the product from other equipment, which may prevent ventilation and keep distance more than 10 cm.
- This product should be operated only with the type of power source indicated on the label. If you are not sure of the type of power supply to your home, consult your product dealer or local power company.

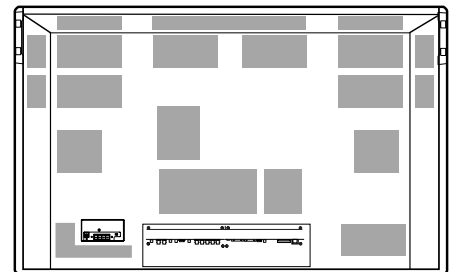

- For United Kingdom: This product is equipped with a three-wire plug. This plug will fit only into a grounded power outlet. If you are unable to insert the plug into the outlet, contact your electrician to install the proper outlet. Do not defeat the safety purpose of the grounded plug.
- Power-supply cords should be routed so that they are not likely to be walked on or pinched by items placed upon or against them. Pay particular attention to cords at doors, plugs, receptacles, and the point where they exit from the product.
- For added protection of this product during a lightning storm, or when it is left unattended and unused for long periods of time, unplug it from the wall outlet and disconnect the cable system. This will prevent damage to the product due to lightning and power line surges.
- Do not overload wall outlets, extension cords, or convenience receptacles on other equipment as this can result in a risk of fire or electric shock.
- Never push objects of any kind into this product through openings as they may touch dangerous voltage points or short out parts that could result in a fire or electric shock. Never spill liquid of any kind on the product.
- Do not attempt to service this product yourself as opening or removing covers may expose you to dangerous voltages and other hazards. Refer all service to qualified service personnel.
- Unplug this product from the wall outlet and refer service to qualified service personnel under the following conditions:
 - a) When the power supply cord or plug is damaged.
 - b) If liquid has been spilled, or objects have fallen on the product.
 - c) If the product has been exposed to rain or water.
 - d) If the product operated normally by following the operating instructions. Adjust only those controls that are covered by the Operation Manual, as an improper adjustment of controls may result in damage and will often require extensive work by a qualified technician to restore the product to normal operation.
 - e) If the product has been dropped or damaged in any way.
 - f) When the product exhibits a distinct change in performance – this indicates a need for service.
- When replacement parts are required, be sure the service technician has used replacement parts specified by the manufacturer or with same characteristics as the original part. Unauthorized substitutions may result in fire, electric shock, or other hazards.
- Upon completion of any service or repairs to this product, ask the service technician to perform safety checks to determine that the product is in proper operating condition.
- The product should be placed more than 30 cm away from heat sources such as radiators, heat registers, stoves, and other products (including amplifiers) that produce heat.
- When connecting other products such as VCR's, and personal computers, you should turn off the power of this product for protection against electric shock.
- Do not place combustibles behind the cooling fan. For example, cloth, paper, matches, aerosol cans or gas lighters that present special hazards when over heated.
- Use only the accessory cord designed for this product to prevent shock.
- ⚠ Option terminal: This terminal is intended exclusively to be used to drive the fan motor.
Do not connect any plugs to the terminal other than JVC's recommended optional parts.

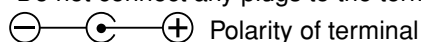

POWER CONNECTION

The power supply voltage rating of this product is AC 220 – 240 V. The power cords attached conform to the following power supply voltage and countries. Use only the power cord designated to ensure Safety and EMC regulations of each country.

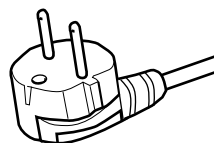

For European countries:
AC 220 – 240 V

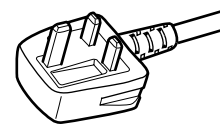

For United Kingdom:
AC 220 – 240 V

Note for the United Kingdom power cord only

The plug on the United Kingdom power cord has a built-in fuse. When replacing the fuse, be sure to use only a correctly rated approved type, re-fit the fuse cover. (Consult your dealer or qualified service personnel.)

How to replace the fuse
Open the fuse compartment with the blade screw driver, and replace the fuse.

Parts Identification

Monitor: Front View

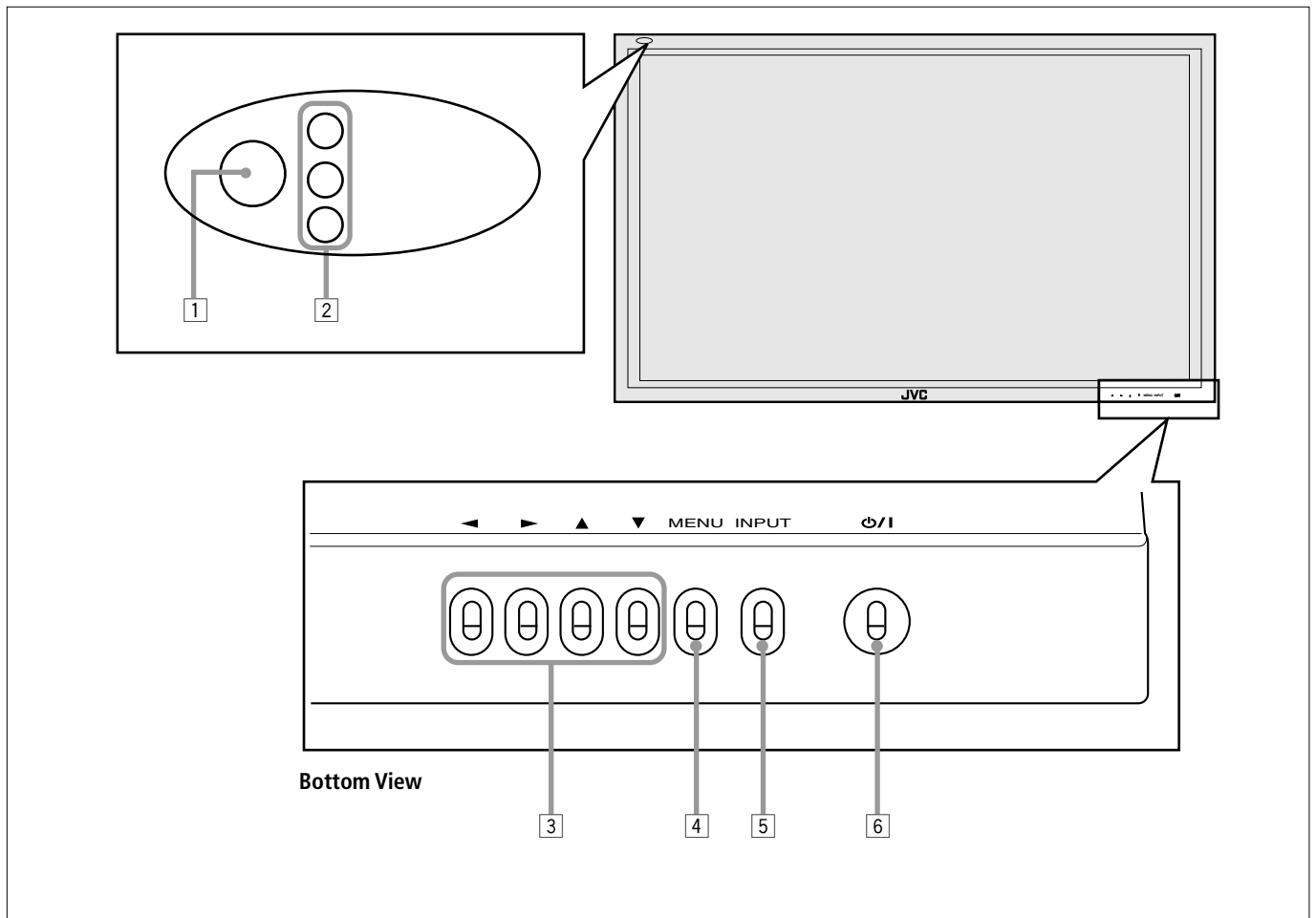

1 Remote sensor/power lamp

Point the front end of the wireless remote control toward here.

When the Monitor is turned on, the power lamp glows green. It glows orange in standby mode.

2 Self-diagnostic lamps (page 37)

These lamps light/flash if something abnormal occurs with the Monitor.

3 ◀ / ▶ / ▲ / ▼ buttons

Use these buttons to select menu items and to make adjustments.

- When no menu is displayed, you can use the ◀ / ▶ buttons to adjust the volume level.

4 MENU button

Use this button to display or erase menus.

While a sub-menu is displayed, pressing this button will move you one screen back to the preceding menu.

5 INPUT button (page 14)

Use this button to switch between inputs.

To select the COMPONENT or RGB B input, you have to set "COMPO./RGB B" correctly on the menu (see page 20).

6 ⏻/⏻ button (page 14)

Use this button to turn on and off (on standby) the Monitor when the POWER switch on the rear of the Monitor is "I (on)."

Monitor: Rear Views ①

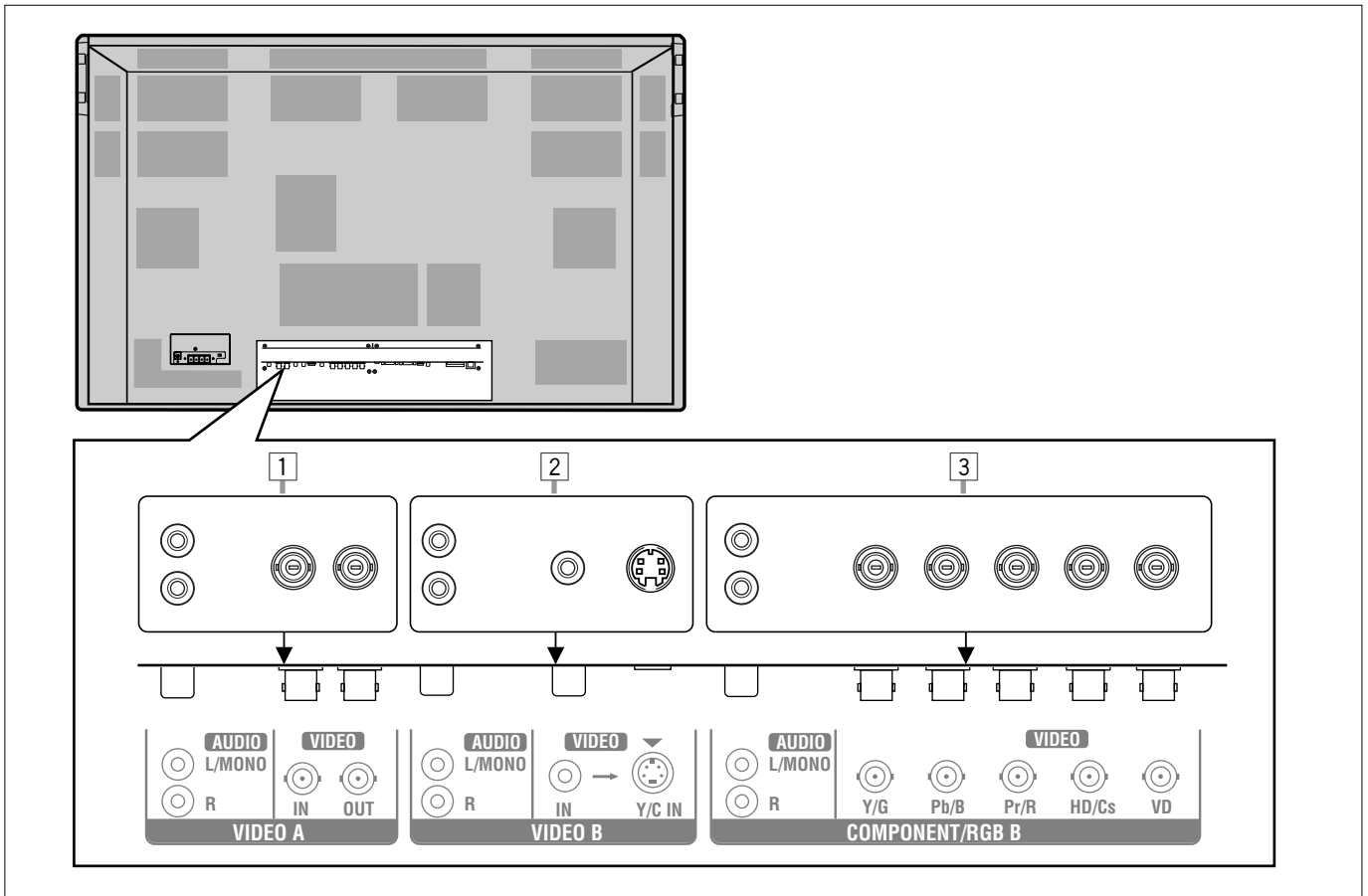

① VIDEO A terminals (page 11)

AUDIO (L/MONO, R) input terminals (pin jack)
Connect these terminals to the audio input terminals of a VCR, etc.

VIDEO IN terminal (BNC)
Connect this terminal to the video output terminal of a VCR, etc.

VIDEO OUT terminal (BNC)
Connect this terminal to the video input terminal of another monitor, etc.

Note:

- Since the video output terminals on this Monitor are loop-through terminals, the devices connected to this video output terminal should be correctly terminated. Otherwise, pictures become abnormally bright or the Monitor screen gets affected abnormally.

② VIDEO B terminals (page 11)

AUDIO (L/MONO, R) input terminals (pin jack)
Connect these terminals to the audio output terminals of a VCR, etc.

Y/C (S video) IN terminal (mini DIN, 4pin)
Connect this terminal to the S-video output terminal of a VCR, etc.

VIDEO IN terminal (pin jack)
Connect this terminal to the video output terminal of a VCR, etc.

Note:

- When both the video and S-video terminals are connected, the S-video terminal will have priority.

③ COMPONENT/RGB B input terminals (page 11)

AUDIO (L/MONO, R) input terminals (pin jack)
Connect these terminals to the audio output terminals of the other equipment.

G, B, R, HD/Cs, VD (VIDEO) input terminals (BNC)
Connect these terminals to the following output terminals of a personal computer or other equipment:

- Analog RGB signal output terminals
- Horizontal sync (HD) signal or composite (Cs) signal output terminal
- Vertical sync (VD) signal output terminal

Notes:

- External sync signals are automatically detected when they come in.
- When both horizontal (HD)/vertical (VD) sync and composite (Cs) sync are connected, HD/VD sync signals will be used.

Y, Pb, Pr (VIDEO) input terminals (BNC)
Connect these terminals to the component signal output terminals of NTSC or high-vision equipment.

Note:

- When these terminals are used as the component terminals (Y, Pb, Pr)—see “Setting the COMPONENT/RGB B Input” on page 20, external sync signals (HD/Cs, VD) cannot be used.

Parts Identification (Continued)

Monitor: Rear Views ②

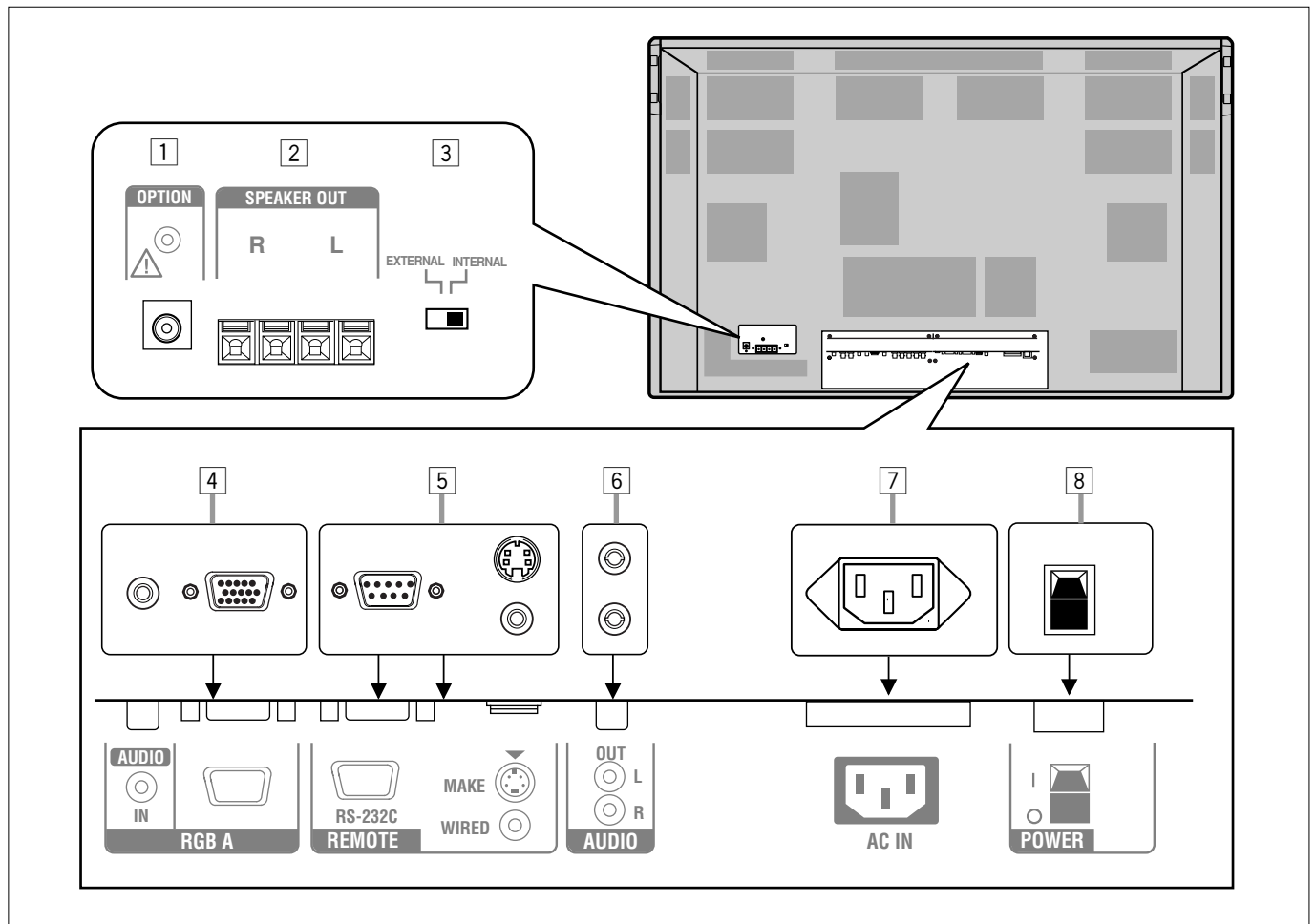

- 1 OPTION terminal (page 13)**
Connect the power cord of the Cooling Fan Unit (not supplied) when installing the Monitor vertically.
- 2 SPEAKER OUT L/R terminals (page 13)**
Connect external speakers, such as unique JVC speakers (not supplied), etc.
- 3 INTERNAL/EXTERNAL (built-in speaker/external speaker) selecting switch (page 13)**
INTERNAL: To use built-in speakers.
EXTERNAL: To use external speakers.
- 4 RGB A input terminals (page 12)**
Input terminal (D-sub, 15 pin)
Connect to the video output terminal of a personal computer.
Note:
• Use a cord as short as possible when connecting a personal computer to this terminal. (Recommended length is within 3 m.)
AUDIO IN terminal (stereo mini jack)
Connect to the audio output terminal of a personal computer.
- 5 REMOTE terminals (page 12)**
RS-232C terminal (D-sub, 9 pin)
Connect to the RS-232C terminal of a personal computer. For the control method using this terminal, consult an authorized JVC dealer.
MAKE terminal (mini DIN, 4pin)
Connect an external control unit. (See page 12.)
WIRED terminal (stereo mini jack)
Connect a wired remote control unit to this terminal.
Note:
• Control signals through the MAKE terminal have priority over those through the other REMOTE terminals.
- 6 AUDIO OUT terminals (pin jack) (page 12)**
Connect to the audio input terminals of external equipment such as an amplifier.
- 7 AC IN terminal (page 12)**
Connect the supplied power cord to this terminal.
- 8 POWER switch (page 14)**
When this switch is set to "I (on)," you can turn on and off (on standby) the Monitor by using the POWER button on the remote control or the  button on the Monitor.

Remote Control

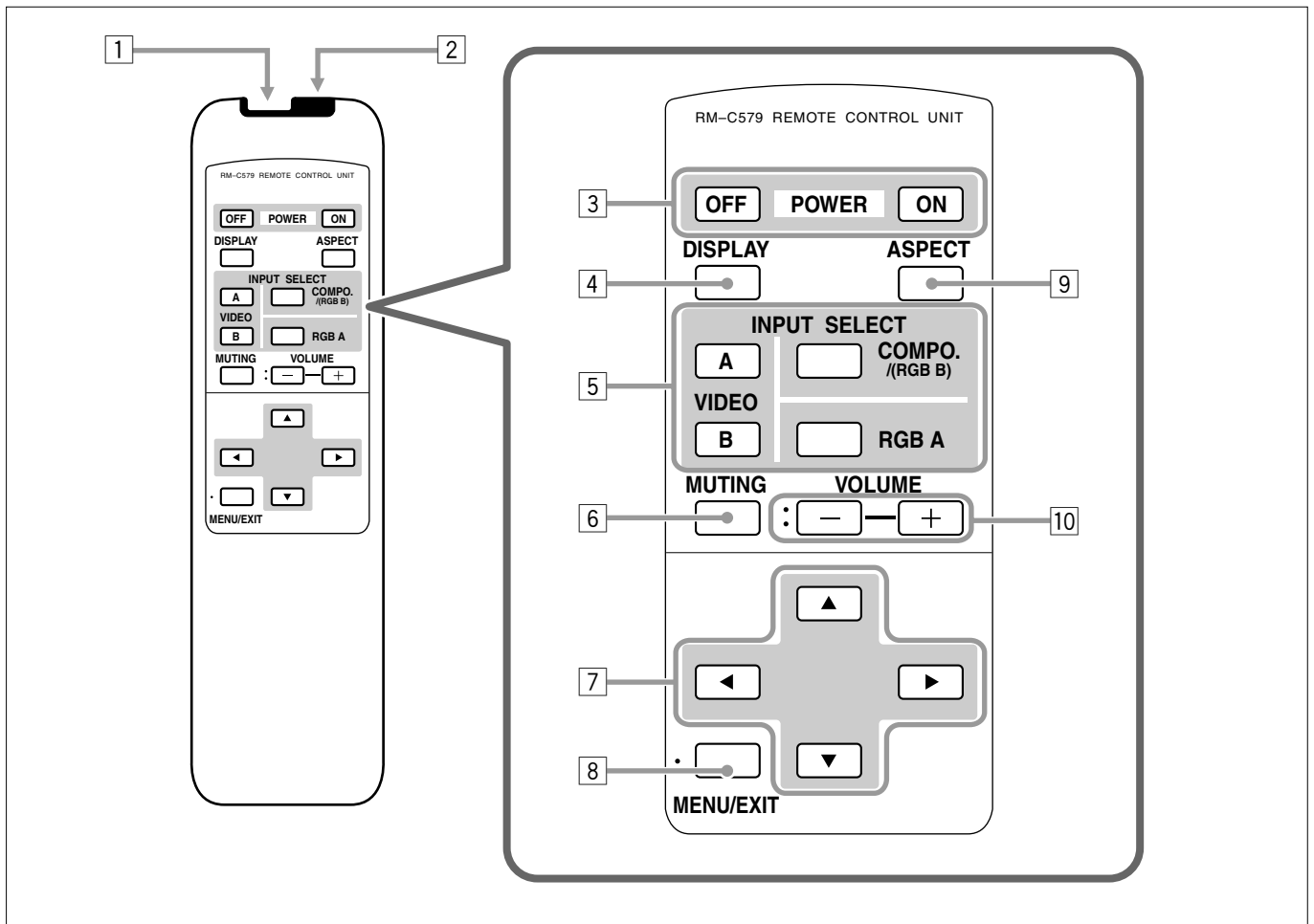

- 1 Remote control cable jack (page 12)**
Connect the remote control cable (not supplied) when using this remote control as a wired remote control.
- 2 Remote signal transmission window**
- 3 POWER ON/OFF button (page 14)**
Use this button to turn on and off (on standby) the Monitor when the POWER switch on the rear of the Monitor is "I (on)."
- 4 DISPLAY button (page 14)**
Use this button to display the input terminal, color system (for VIDEO A or VIDEO B input), scan system (for COMPONENT input) and horizontal/vertical frequency (for RGB A and RGB B input).
- 5 INPUT SELECT (VIDEO A, VIDEO B, COMPO./RGB B) and RGB A) buttons (page 14)**
Use these buttons to switch between inputs. To select the COMPONENT or RGB B input, you have to set "COMPO./RGB B" correctly on the menu (see page 20).
- 6 MUTING button (page 14)**
Use this button to turn off the volume immediately. Pressing the button again will resume the previous volume level.
- 7 ◀ / ▶ / ▲ / ▼ buttons**
Use these buttons to select menu items or make adjustments.
- 8 MENU/EXIT button**
Use this button to display or erase menus. While a sub-menu is displayed, pressing this button will move you one screen back to the preceding menu.
- 9 ASPECT button (page 15)**
Use this button to switch between aspect ratios. Each time you press the button, the aspect ratio changes as follows:

REGULAR → FULL → ZOOM → PANORAMIC → REGULAR
- 10 VOLUME + / - buttons (page 14)**
Use these buttons to adjust the volume level.

Preparations

Checking the Accessories

The following accessories are included with the Monitor. Check for them. If any item is missing, please contact the dealer where you purchased the Monitor.

- Remote control (RM-C579) x 1
- Power cord x 2 (Use the one matching the wall outlet.)
- Batteries (AA/R6P) x 2
- Ferrite core x 2

Installing the Batteries

Put the batteries in the remote control as follows. If the remote control has become erratic in operation, change the batteries.

1 Remove the back cover.

While pushing the release lever on the cover, remove the cover in the direction of the arrow.

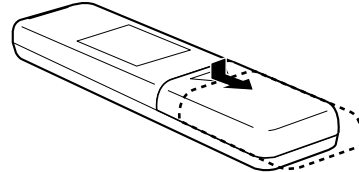

2 Place the batteries.

Put the two supplied batteries (AA/R6P), noting the ⊕ and ⊖ markings, as shown.

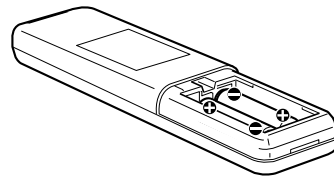

3 Replace the back cover as illustrated.

Make sure the release lever on the cover is locked in place correctly.

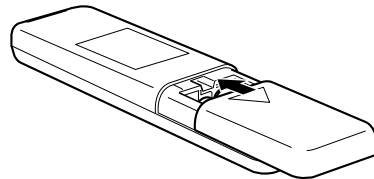

Precautions for using batteries

If batteries are used improperly, the liquid could leak out, causing a fire, injury, etc. or dirtying the vicinity.

Take notice of the following:

- Do not mix old and new batteries.
- Do not mix different types of battery as different types may have different characteristics.
- Place the batteries according to the ⊕ and ⊖ markings indicated on the battery compartment.
- When installing the batteries, insert the ⊖ end first to avoid a short circuit.
- Use only the specified batteries.
- When you are not using the remote control for a long time, remove the batteries.
- When the batteries have reached the end of their life, replace them with new ones immediately. Otherwise, the liquid may leak out, or malfunction may be caused by the leaked liquid. If the leaked liquid contacts your skin, wipe off the liquid with a soft cloth. If the affected skin is left as is, you may get a rough skin.
- Do not throw the batteries into fire or try recharging them.
- The service life of batteries is six months to one year for normal use. The supplied batteries are only for checking the operation and their life may be shorter. When the remote control operation becomes erratic, replace with new batteries.

The instruction below applies only to the use in Holland.

Gebriike batterijen:

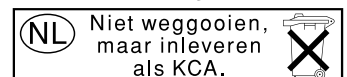

About the Supplied Ferrite Core

Be sure to attach the supplied ferrite cores to the speaker cords when using external speakers to reduce interference from the Monitor with external devices. See page 13.

Installation

Precautions

- **When installing the Monitor vertically, make sure the following:**
 - Attach the external cooling fan unit to the Monitor. (See “Connecting the External Cooling Fan Unit” on page 13.)
 - Set the speed of the internal cooling fan to “HIGH.” (See “Setting the Speed of the Internal Cooling Fan” on page 25.)
- When installing the Monitor, be sure to use a dedicated Stand Unit, Wall Mounting Unit, or Monitor Hanger Unit, depending on a particular case. Ask your dealer for installation.
- When installing the Monitor in a special way (for example, installing it diagonally), consult your dealer.
- Route the power cord and connection cables along wall or floor corners to avoid walking on them.
- For good heat dissipation, try to leave the following distances of space (minimum) around the Monitor.
- The ambient temperature of the installation place should be within the range of 0°C to 40°C (slightly variable depending on ambient conditions for installation.)
- When installing the Monitor in a place, such as near the ceiling, the remote control may not work correctly because of possible effects from the surroundings. If this happens, use the remote control as a wired remote control or move the Monitor where it is free from these effects.

When installing the Monitor on a stand

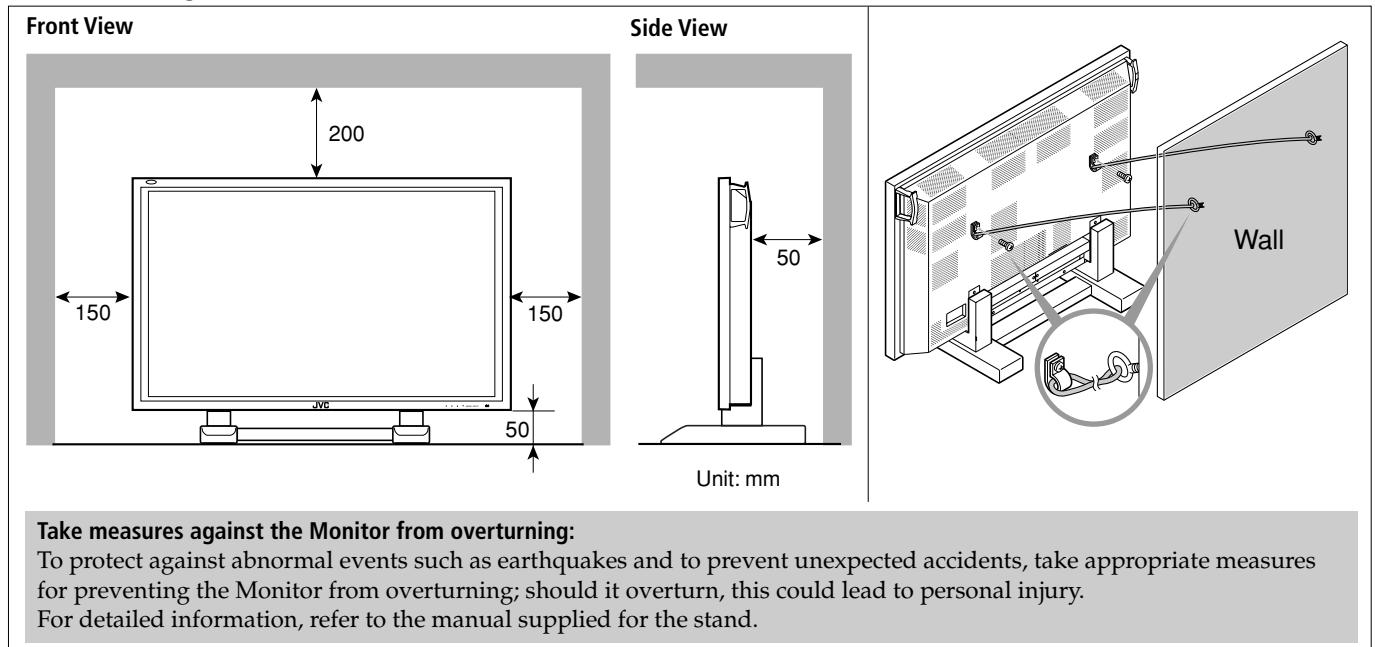

When mounting the Monitor on the wall

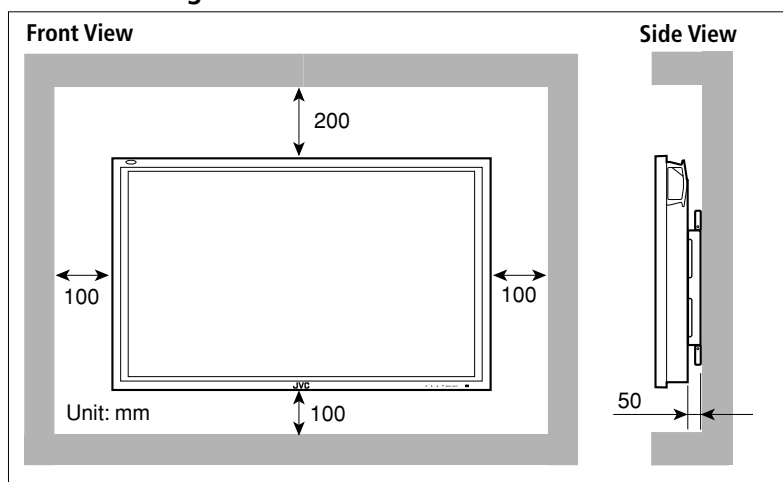

When hanging the Monitor from the ceiling

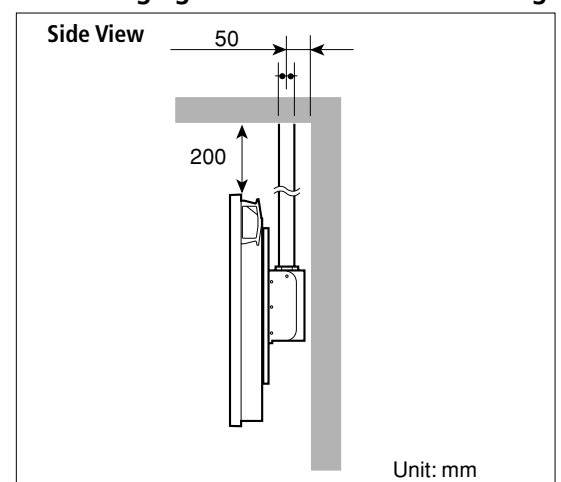

Notes:

- Do not allow the same image (pattern) to be continuously displayed on the screen for a long time; otherwise, the area on the screen corresponding to the image may vary in brightness, leaving an afterimage on the screen. To reduce the afterimage, you can use the Color Reverse function and the Refresh function (see pages 28 and 29).
- The Monitor is manufactured using very high-precision technology, allowing for more than 99.99% active pixels, however, be aware that only a slight number of pixels may be deficient or lit at all times.
- Do not install the Monitor in such a way that the Monitor and other AV equipment affect each other adversely. (For example, if a disturbed image or noise due to electromagnetic interference occurs, or if the infrared remote control malfunctions, change the installation place.)

Connections

Precautions

- Before making connections, turn off all the equipment.
- Use a cord whose plugs are correctly matching for the terminals on this Monitor and the equipment.
- Plugs should be firmly inserted; poor connection could cause noise.
- To unplug a cord, be sure to grasp its plug and pull it out.
- Connect the power cord after having finished all other connections.
- Refer also to the user manual of each piece of equipment.

Available Signals

Video signals

The following signals can be input to this Monitor:

- VIDEO A and VIDEO B terminals accept — PAL, PAL60, NTSC, NTSC 4.43, and SECAM signals.
- COMPONENT/RGB B terminals accept — 480i, 576i, 480p, 576p, 720/60p, 720/50p, 1080/60i (1035/60i), and 1080/50i signals. (You need to set “COMPO./RGB B” to “COMPO.” on the menu (see page 20).

Computer signals (Preset)

This Monitor has 27 preset video modes for the most popular industrial standard, and the signals of the following image resolutions can be input to the RGB input terminals.

No.	Signal name	Screen resolution		Horizontal Frequency (kHz)	Vertical Frequency (Hz)	Scan system
		Horizontal	Vertical			
1	PC98	640	400	24.8	56.4	Non-interlace
2	VGA400-70	640	400	31.5	70.1	Non-interlace
3	VGA480-60	640	480	31.5	59.9	Non-interlace
4	WVGA-60	852	480	31.7	60.3	Non-interlace
5	VGA480-72	640	480	37.9	72.8	Non-interlace
6	VGA480-75	640	480	37.5	75.0	Non-interlace
7	SVGA-56	800	600	35.2	56.3	Non-interlace
8	SVGA-60	800	600	37.9	60.3	Non-interlace
9	SVGA-72	800	600	48.1	72.2	Non-interlace
10	SVGA-75	800	600	46.9	75.0	Non-interlace
11	XGA-60	1024	768	48.4	60.0	Non-interlace
12	WXGA-60	1366	768	48.4	60.0	Non-interlace
13	XGA-70	1024	768	56.5	70.1	Non-interlace
14	XGA-75	1024	768	60.0	75.0	Non-interlace
15	XGA-85	1024	768	68.7	85.0	Non-interlace
16	XGA+-75	1152	864	67.5	75.0	Non-interlace
17	SXGA-60	1280	1024	64.0	60.0	Non-interlace
18	SXGA-75	1280	1024	80.0	75.0	Non-interlace
19	UXGA-60	1600	1200	75.0	60.0	Non-interlace
20	UXGA-65	1600	1200	81.3	65.0	Non-interlace
21	UXGA-70	1600	1200	87.5	70.0	Non-interlace
22	MAC13"	640	480	35.0	66.7	Non-interlace
23	MAC16"	832	624	49.7	74.6	Non-interlace
24	MAC19"	1024	768	60.2	74.9	Non-interlace
25	MAC21"	1152	870	68.7	75.1	Non-interlace
26	RGB15K-60	—	—	15.7	59.9	Interlace
27	RGB15K-50	—	—	15.6	50.0	Interlace

Notes:

- When a signal other than listed above is input, a part of the screen may become void or an unnecessary picture may appear.
- Signals, though they are within the acceptable range of frequencies, may not be displayed normally, depending on the signal type.
- Depending on the connected equipment, the Monitor may not be compatible with composite sync (Cs) or G on sync signals.
- When a preset mode signal is input, the vertical frequency displayed on the screen will have an “*” shown at its right top position.
- When the No. 4 and No. 12 signals are input, change the aspect ratio to “FULL” with the ASPECT button (page 15) on the remote control or from the “FUNCTION SELECT” menu (see page 19).
- When No. 16 to No. 21 and No. 25 signals are input, thin lines may become obscure for their signal frequencies are higher than the screen resolution. Using the RGB A input terminals makes the lines clearer than using the RGB B input terminals.
- The adjustment of the screen size and position is the setting common to the No. 14 and No. 24 signals. If you use both signals by switching them, the adjustment of either signal may not be proper.

Connection Diagrams

AV connections

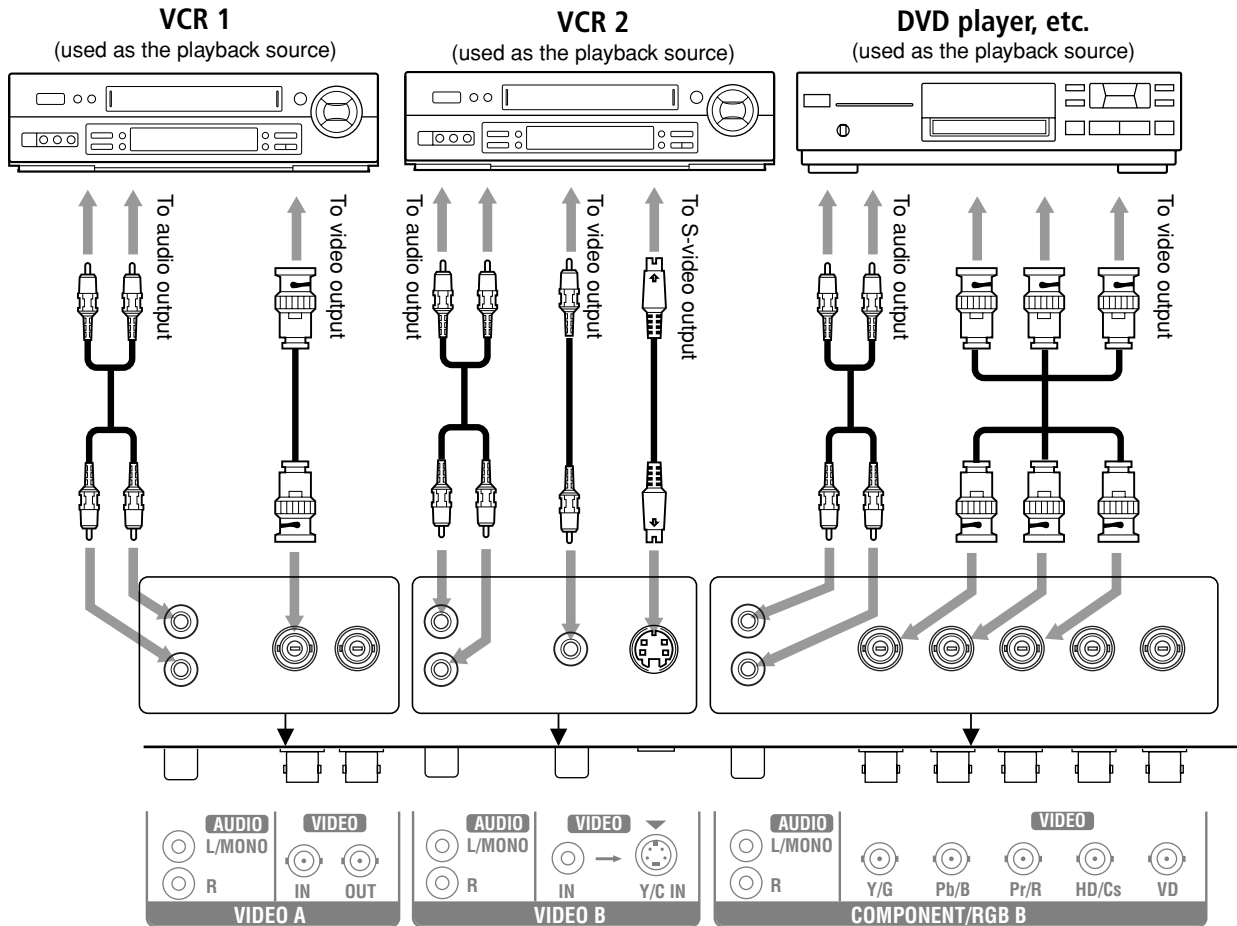

When connecting another PC to the COMPONENT/RGB B terminals, set the "COMPO./RGB B" setting to "RGB B" (see page 20).

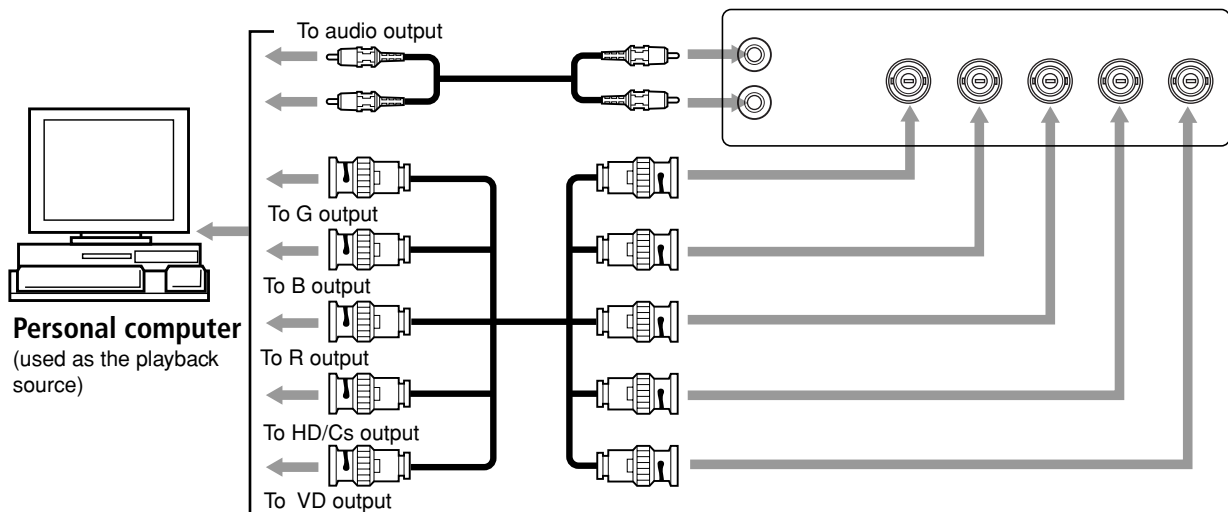

Notes:

- You can connect another VCR or Monitor to the VIDEO A OUT terminal. However, when connecting a VCR to the VIDEO A terminals, do not connect both IN and OUT terminals to the same VCR.
- When connecting a VCR to the VIDEO B terminals, you can use either the video or S-video terminals. If the both terminals are used, S-video terminal will have priority.

Connections (Continued)

Typical connections

Personal computer

(used as the playback source)

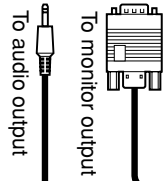

Personal computer

(used to control the Monitor)

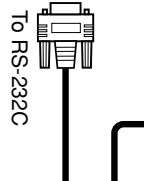
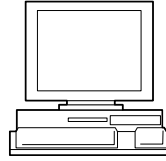

Remote control

(supplied)



Cable with stereo mini jacks
(not supplied)



Amplifier, etc.

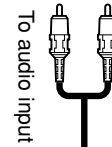
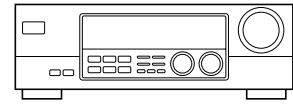

Power cord (supplied)

To a wall outlet

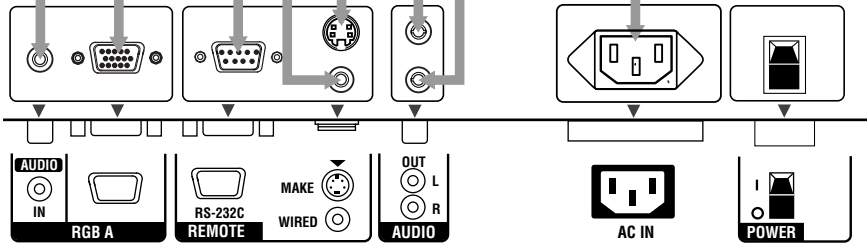

* For connection, see "Connecting an External Control Unit" below.

Connecting an External Control Unit

When connecting the external control unit to the MAKE terminal, you can operate the following functions through the MAKE terminal;

- Turn on or off the Monitor.
Preparation: The POWER switch on the rear must be set to "I (on)" (so that the Monitor is in standby mode).
- Select the input.
Preparation: "REMOTE SWITCH" should be set correctly to select your desired input (see page 24).

Notes:

- There is no remote control on/off switch. When a plug is inserted to the MAKE terminal, remote control through the external control unit is automatically activated.
- When the other REMOTE terminals are used at the same time, control signals through the MAKE terminal have priority over those through the other terminals.

• MAKE terminal

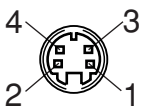

Pin number	Signal name
1	GND
2	GND
3	SW2
4	SW1

• External control unit

Opening	Short-circuiting
Power Off	Power On
Input A*	Input B*

* Input A and Input B will be determined by the "REMOTE SWITCH" setting.

IMPORTANT:

External control unit is not commercially available in the market. When you need it, consult your dealer.

External Speaker Connection

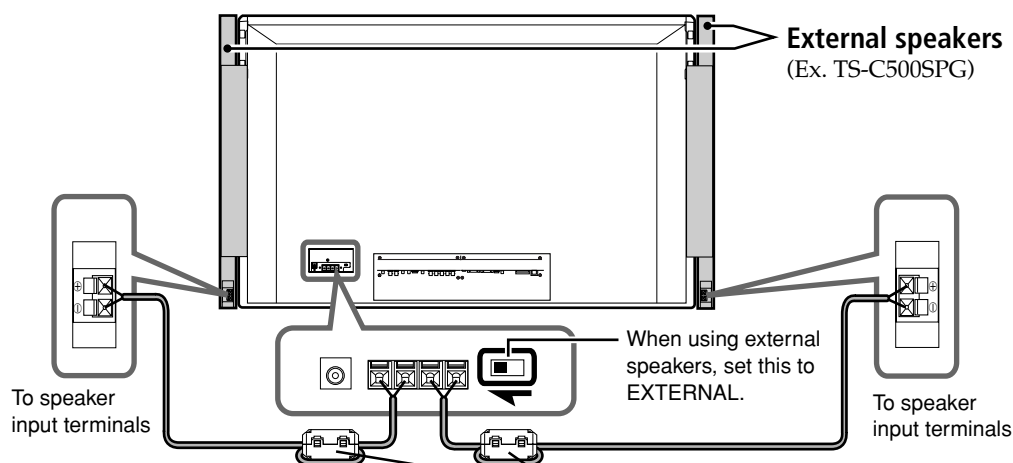

Note:

It is recommended to use the speaker unit—TS-C500SPG (not supplied) as the external speakers. You can also connect any speakers of the following specifications:

- Impedance: Between 6 Ω and 8 Ω
- Power handling capacity: More than 3 W

How to connect the cords

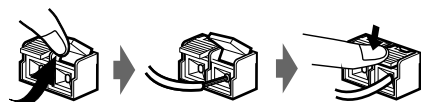

Caution:

- Do not short-circuit the ⊕ and ⊖ speaker cords each other. (Refer also to the instructions supplied with the speaker unit when connecting speakers.)

Ferrite core (supplied)

Attach the supplied ferrite cores to the speaker cords when using external speakers. Attach the ferrite cores as near to the SPEAKER OUT L/R terminals on the rear panel of the Monitor as possible.

How to attach the ferrite core

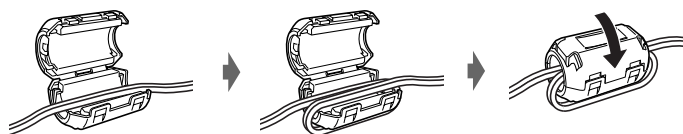

Connecting the External Cooling Fan Unit

When installing this Monitor vertically, it is required to attach the external cooling fan unit (not supplied).

Notes:

- When installing this Monitor vertically, it is also required to set the speed of the internal cooling fan to "HIGH" (see page 25).
- If you install the Monitor in such a way not instructed in this manual (for example, installing it diagonally), the cooling fan unit may not be able to cool down the internal heat enough to make the Monitor operate; therefore, reinstallation or another method for cooling will be required. Consult your dealer in such a case.
- For more detailed connection, refer to the manual supplied with the external cooling fan unit.

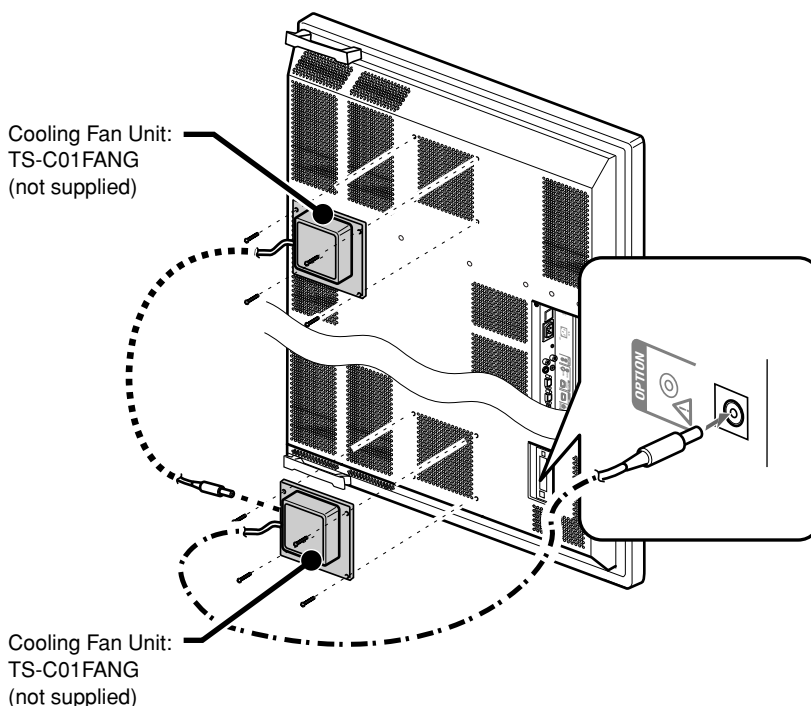

Basic Operations

Rear View

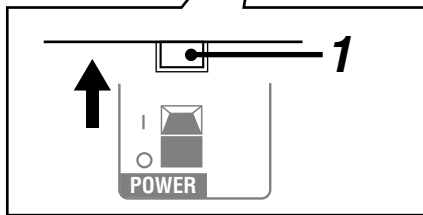
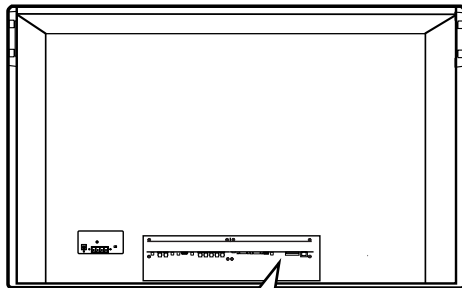

Daily Operations

1 Turn on the main power.

Set the POWER switch on the rear of the Monitor to "I (on)".

The power lamp on the upper left of the front panel lights orange.

- If you have turned off the Monitor not by using POWER ON on the remote control (or \mathcal{O}/I on the front panel), but by using the POWER switch, setting the power switch to "I (on)" lights the power lamp green and turns the Monitor on.

2 Turn on the power.

Press POWER ON on the remote control to turn the power on.

The power lamp lights green.

- You can also use \mathcal{O}/I on the front panel (lower right) to turn on the Monitor.

3 Select an input.

Select the desired input by pressing INPUT SELECT (VIDEO A, VIDEO B, COMPO./ (RGB B) and RGB A).

- You can also select the input by pressing INPUT on the Monitor. Each time you press the button, the input mode changes in sequence.



Ex. When selecting "VIDEO A" input

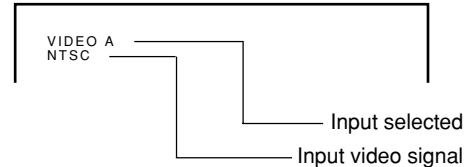

Note:

- To select "COMPONENT" or "RGB B," you need to set the "COMPO./RGB B" setting correctly.

4 Adjust the volume.

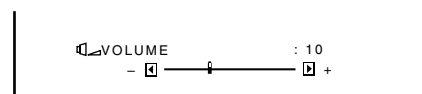

Note:

- While no menu is displayed, you can adjust the volume by pressing \blacktriangleleft / \blacktriangleright on the Monitor.

To turn off the volume immediately

Press MUTING.

"MUTING ON" is displayed, and the sound goes out.

Pressing the button again resumes the previous volume level.

To make the screen indication appear

Press DISPLAY.

The types of input and signal are indicated on the screen for about 3 seconds.

You can also make the screen indication appear using menus (page 22).

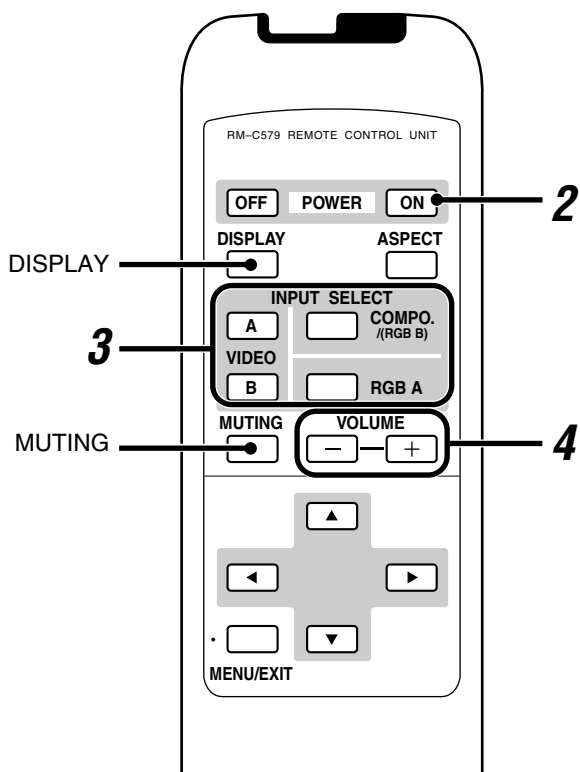

Changing the Aspect Ratio

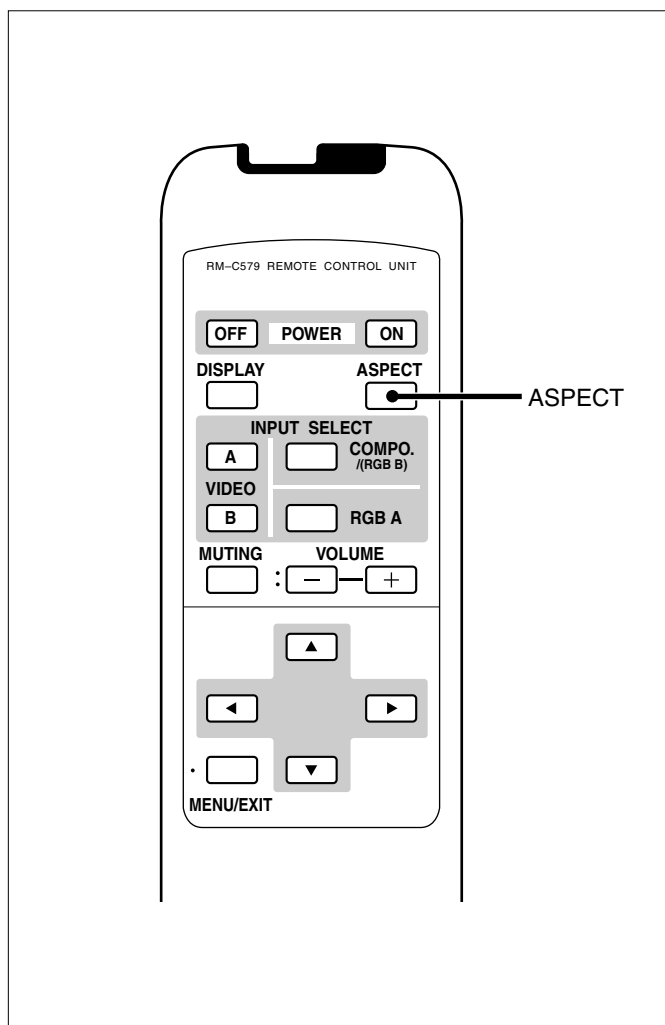

With this Monitor, you can select among three types of wide screens (FULL, ZOOM, and PANORAMIC) in addition to the REGULAR screen of conventional 4:3 aspect ratio.

Press ASPECT to select the screen size.

Each time you press the button, the screen size changes as follows:

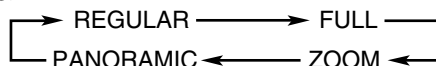

REGULAR: Displays at conventional 4:3 aspect ratio.

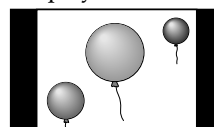

FULL: REGULAR size display is enlarged horizontally.

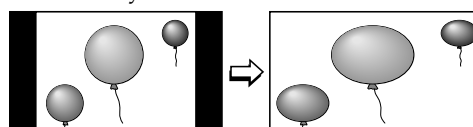

ZOOM: REGULAR size display is enlarged vertically and horizontally at the same ratio.

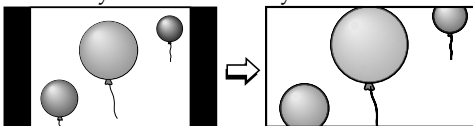

PANORAMIC: REGULAR size display is enlarged horizontally to the extent that the picture does not look abnormally.

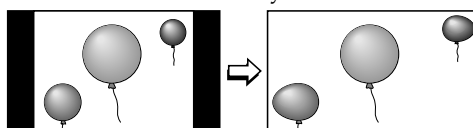

Precautions for using the screen mode switching function

- This Monitor features a screen mode switching (aspect ratio change) function. If you select a mode different in aspect ratio from software such as TV programs, the picture may look different from original picture. Be aware of this point when you are selecting a screen mode.
- If you select a wide screen mode while viewing conventional video programs of the aspect ratio 4:3, some portions (edges) of the original picture will be cut off, or deformed. To enjoy the original picture as it is, select "REGULAR" while viewing such programs.
- If you place the Monitor in a tea room, hotel, etc. for business purposes or public viewing and modify the picture by using the screen mode switching (aspect ratio change) function, this could violate the copyright protected by the copyright law, which requires your special attention.
- If you make the screen very bright and watch programs selecting "REGULAR," for a long period of time, the Monitor screen may happen to be burned in. If this occurs, watching programs using a wide screen mode for a while will reduce the burn-in gradually.

Notes:

- When one of the following signals is being input, you cannot select the aspect ratio you want.
 - 720/60p, 720/50p, 1080/60i (1035/60i), or 1080/50i signal through the COMPONENT/RGB B input terminals
You can only select FULL.
 - When any signal other than RGB15K-60 and RGB15K-50 through the RGB A or COMPONENT/RGB B input terminals
You can select only REGULAR and FULL.
- The aspect ratio can also be changed on the "FUNCTION SELECT" Menu (see page 19).

Video Adjustments

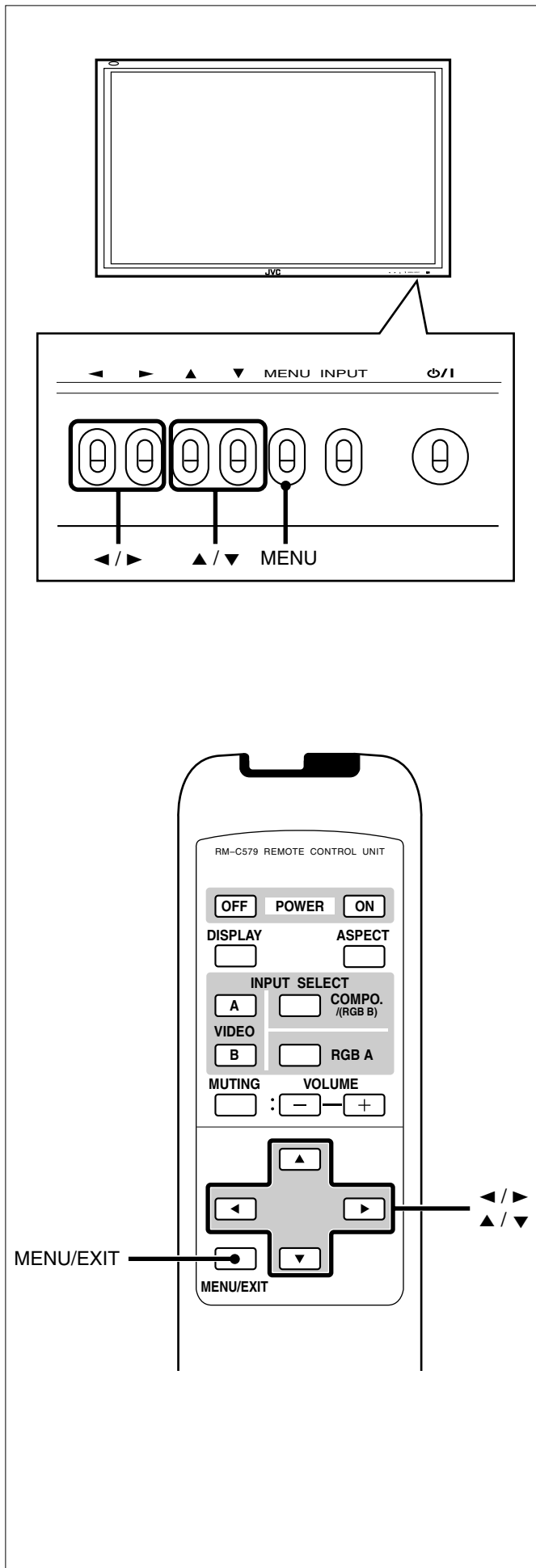

Adjusting the Picture Quality

Picture quality can be set for each input mode.

- 1 Press **MENU/EXIT** (or **MENU** on the Monitor) to display the Main Menu.

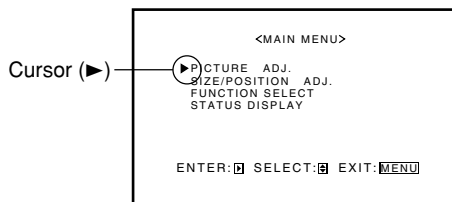

- 2 Press **▲/▼** to move the cursor (▶) to "PICTURE ADJ."

- 3 Press **▶** to display the Picture Adjustment Menu.

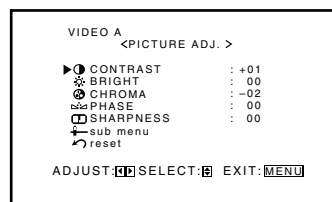

- 4 Press **▲/▼** to move the cursor (▶) to the item you want to adjust.

Item	Adjustment range	Standard (Reset)
CONTRAST	-20 to +20	+10
BRIGHT (brightness)	-20 to +20	00
CHROMA ^{*1}	-20 to +20	00
PHASE ^{*2}	-20 to +20	00
SHARPNESS	-10 to +10	00
sub menu	See "To make an adjustment while viewing the adjustment bar" on the next page.	
reset	See "To reset the adjustments" on the next page.	

^{*1} Adjustable when viewing the NTSC, PAL, or SECAM signal, or component signal.

^{*2} Adjustable when viewing the NTSC signal or component signal.

- 5 Press **◀/▶** to make adjustments.

- 6 Press **MENU/EXIT** (or **MENU** on the Monitor) twice to exit from the menu operations.

To make an adjustment while viewing the adjustment bar

After step 3 on page 16, proceed as follows:

- 1 Press ▲/▼ to move the cursor (▶) to "sub menu."
- 2 Press ▶ to display the Sub Menu.

The Sub Menu for CONTRAST appears on the screen.

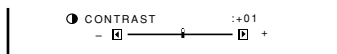

- 3 Press ▲/▼ to select the Sub Menu you want to adjust.
- Each time you press the button, the Sub Menu changes as follows:

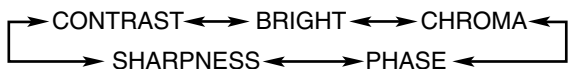

- 4 Press ◀/▶ to adjust the selected item.
- 5 Repeat steps 3 and 4 to adjust the other items.
- 6 Press MENU/EXIT (or MENU on the Monitor) three times to exit from the menu operations.

To reset the adjustments

After step 3 on page 16, proceed as follows:

- 1 Press ▲/▼ to move the cursor (▶) to "reset."
- 2 Press ▶.

The confirmation screen appears.

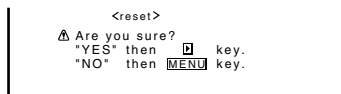

- 3 Press ▶ again to reset the adjustments.

To cancel the reset, press MENU/EXIT (or MENU on the Monitor).

Adjusting the Screen Size and Position

The screen size and position can be adjusted. Adjusted settings can be stored for each signal type; therefore, when the same signal comes in, the stored settings are recalled.

- When adjusting the size, the size cannot be adjusted proportionally, but can be enlarged rightward (or downward) only and reduced leftward (or upward) only. Therefore, it is necessary to adjust both the size and position alternately to adjust to the appropriate size.

1 Press MENU/EXIT (or MENU on the Monitor) to display the Main Menu.

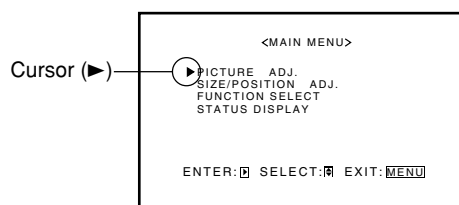

2 Press ▲/▼ to move the cursor (▶) to "SIZE/POSITION ADJ."

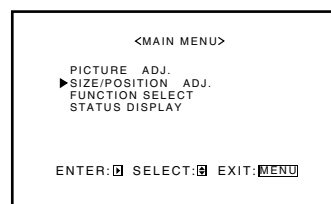

3 Press ▶ to display the Size/Position Adjustment Menu.

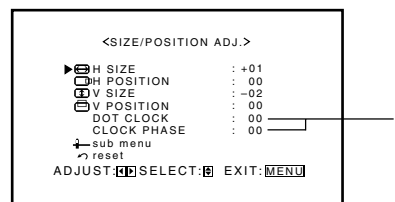







* Appearing and being adjustable only when you use RGB A or RGB B input.

(To be continued on the next page)

Video Adjustments (Continued)

4 Press ▲/▼ to move the cursor (▶) to the item you want to adjust.

Item	Adjustment range
 H (horizontal) SIZE* ¹	-40 to +40
 H POSITION* ¹	Varies depending on other settings
 V (vertical) SIZE* ¹	-40 to +40
 V POSITION* ¹	Varies depending on other settings
DOT CLOCK* ²	-10 to +10
CLOCK PHASE* ²	-20 to +20
 sub menu	See "To make an adjustment while viewing the adjustment bar" on the right column.
 reset	See "To reset the adjustments" on the right column.

*¹ Size and position adjustments are so related that if one is adjusted much, the other's adjustable range will be reduced.

*² DOT CLOCK is the function to adjust the pixel sampling number of the A/D converter to the resolution (the vertical pixel number) of the input signal.

CLOCK PHASE is the function to adjust the sampling timing (phase) to the phase of the input signal. You can use the two functions to reduce flickering and blurring on the screen when using the RGB A or RGB B input.

5 Press ◀/▶ to adjust the selected item.

Note:

- During size and position adjustments, the Monitor screen may be distorted. This is normal, but not a malfunction of the Monitor.

6 Press MENU/EXIT (or MENU on the Monitor) twice to exit from the menu operations.

To make an adjustment while viewing the adjustment bar

After step 3 on page 17, proceed as follows:

1 Press ▲/▼ to move the cursor (▶) to "sub menu."

2 Press ▶ to display the Sub Menu.

The Sub Menu for H SIZE appears on the screen.

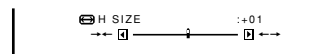

3 Press ▲/▼ to select the Sub Menu you want to adjust.

Each time you press the button, the Sub Menu changes as follows:

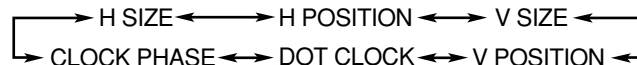

4 Press ◀/▶ to adjust the selected item.

5 Repeat steps 3 and 4 to adjust the other items.

6 Press MENU/EXIT (or MENU on the Monitor) three times to exit from the menu operations.

To reset the adjustments

After step 3 on page 17, proceed as follows:

1 Press ▲/▼ to move the cursor (▶) to "reset."

2 Press ▶.

The confirmation screen appears.



3 Press ▶ again to reset the adjustments.

To cancel the reset, press MENU/EXIT (or MENU on the Monitor).

Note:

- Adjustment values for both horizontal and vertical sizes of the screen are so related that if one is adjusted up to near the maximum value, the attainable value of the other will be decreased.

Adjusting the Color Temperature

The adjusted setting applies to all inputs.

- 1 Press **MENU/EXIT** (or **MENU** on the Monitor) to display the Main Menu.

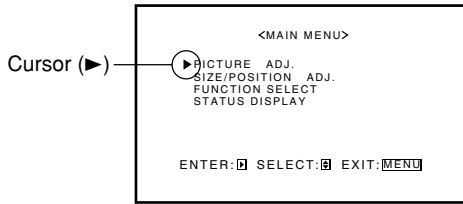

- 2 Press **▲/▼** to move the cursor (▶) to "FUNCTION SELECT."

- 3 Press **▶** to display the Function Selection Menu.

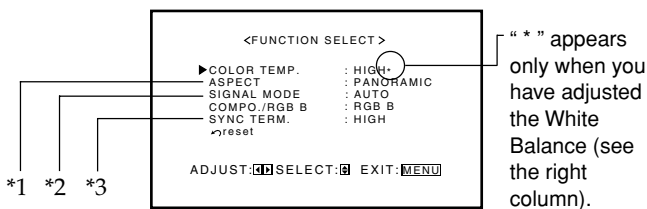

- *1 "ASPECT" does not appear when 720/60p, 720/50p, 1080/60i (1035/60i), or 1080/50i signal is being input through the COMPONENT/RGB B input terminals.
- *2 "SIGNAL MODE" appears only when VIDEO A, VIDEO B, or COMPONENT input is selected.
- *3 "SYNC TERM." appears only when the RGB B input is selected.

- 4 Press **▲/▼** to move the cursor (▶) to "COLOR TEMP."

- 5 Press **◀/▶** to make an adjustment.

Each time you press the button, the color temperature alternates between "HIGH" and "LOW."

- HIGH: To make the screen become bluish.
- LOW: To make the screen become reddish.

- 6 Press **MENU/EXIT** (or **MENU** on the Monitor) twice to exit from the menu operations.

Note:

- To make a fine adjustment, adjust "WHITE BALANCE" (see page 25).

Changing the Aspect Ratio

The setting adjusted applies to all inputs.

- You can change the aspect ratio by pressing ASPECT. (See page 15.)

- 1 Press **MENU/EXIT** (or **MENU** on the Monitor) to display the Main Menu.

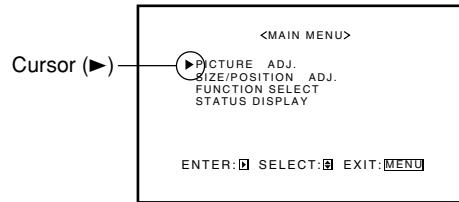

- 2 Press **▲/▼** to move the cursor (▶) to "FUNCTION SELECT."

- 3 Press **▶** to display the Function Selection Menu.

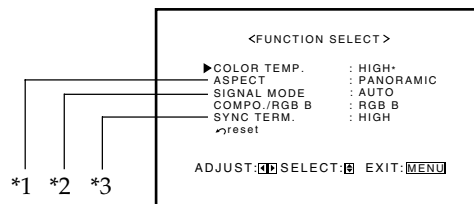

- *1 "ASPECT" does not appear when 720/60p, 720/50p, 1080/60i (1035/60i), or 1080/50i signal is being input through the COMPONENT/RGB B input terminals.
- *2 "SIGNAL MODE" appears only when VIDEO A, VIDEO B, or COMPONENT input is selected.
- *3 "SYNC TERM." appears only when the RGB B input is selected.

- 4 Press **▲/▼** to move the cursor (▶) to "ASPECT."

- 5 Press **◀/▶** to select an aspect ratio you want.

Each time you press the button, the aspect ratio changes as follows:

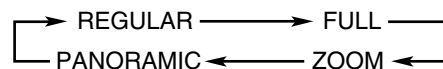

- * For detailed information on these aspect ratios, see page 15.

- 6 Press **MENU/EXIT** (or **MENU** on the Monitor) twice to exit from the menu operations.

Note:

- When one of the following signals is being input, you cannot select the aspect ratio you want.
 - 720/60p, 720/50p, 1080/60i (1035/60i), or 1080/50i signal through the COMPONENT/RGB B input terminals
Aspect ratio is fixed to FULL ("ASPECT" does not appear on the display).
 - When any signal other than RGB15K-60 and RGB15K-50 through the RGB A or COMPONENT/RGB B input terminals
You can select only REGULAR and FULL.

Video Adjustments (Continued)

Setting the Receivable Signal Types

You can set the receivable signal types. Normally, select "AUTO."

A common setting will apply to both the VIDEO A input and the VIDEO B input, and a different setting will apply to the COMPONENT input.

1 Press MENU/EXIT (or MENU on the Monitor) to display the Main Menu.

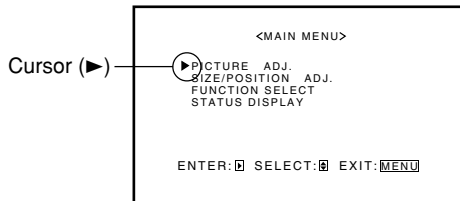

2 Press ▲/▼ to move the cursor (▶) to "FUNCTION SELECT."

3 Press ▶ to display the Function Selection Menu.

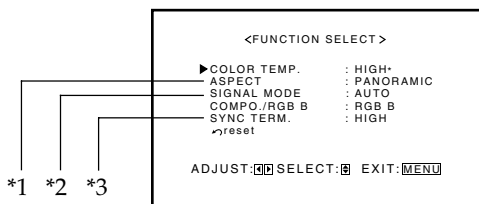

*1 "ASPECT" does not appear when 720/60p, 720/50p, 1080/60i (1035/60i), or 1080/50i signal is being input through the COMPONENT/RGB B input terminals.

*2 "SIGNAL MODE" appears only when VIDEO A, VIDEO B, or COMPONENT input is selected.

*3 "SYNC TERM." appears only when the RGB B input is selected.

4 Press ▲/▼ to move the cursor (▶) to "SIGNAL MODE."

5 Press ◀/▶ to select the receivable video signal type.

Each time you press the button, the receivable video signal type changes as follows:

- When VIDEO A or VIDEO B input is selected:

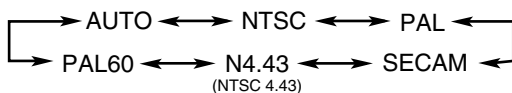

- When COMPONENT input is selected:

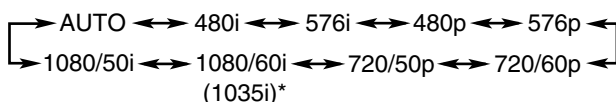

* Changes according to the "HD SIGNAL MODE" setting (see page 24).

6 Press MENU/EXIT (or MENU on the Monitor) twice to exit the menu operations.

Setting the COMPONENT/RGB B Input

After connecting the playback device such as a PC or a DVD player to the COMPONENT/RGB B terminals, you have to specify which type of signal comes into this terminal—RGB or component signals.

- Without setting "COMPO./RGB B" correctly, you cannot show any picture though you select the COMPONENT or RGB B input.

1 Press MENU/EXIT (or MENU on the Monitor) to display the Main Menu.

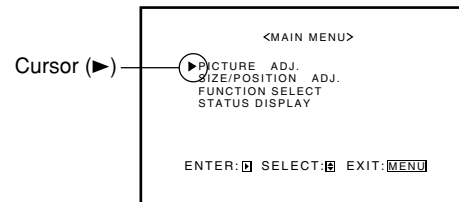

2 Press ▲/▼ to move the cursor (▶) to "FUNCTION SELECT."

3 Press ▶ to display the Function Selection Menu.

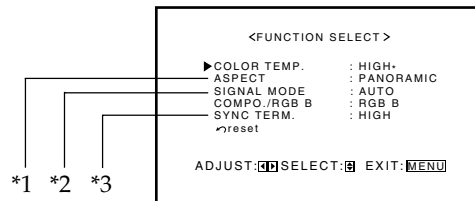

*1 "ASPECT" does not appear when 720/60p, 720/50p, 1080/60i (1035/60i), or 1080/50i signal is being input through the COMPONENT/RGB B input terminals.

*2 "SIGNAL MODE" appears only when VIDEO A, VIDEO B, or COMPONENT input is selected.

*3 "SYNC TERM." appears only when the RGB B input is selected.

4 Press ▲/▼ to move the cursor (▶) to "COMPO./RGB B"

5 Press ◀/▶ to select the type of signal.

COMPO.: When connecting the playback device such as a DVD player, which can emit the component signals.

RGB B: When connecting the playback device such as a PC, which can emit the RGB signals.

The setting changes and the "FUNCTION SELECT" Menu disappears.

Changing the Resistance of the RGB B Input Terminals

You can set the resistance of the two of the RGB B input terminals to either HIGH (1 kΩ) or LOW (75 Ω):

- HD/Cs (Horizontal sync/Composite) terminal
- VD (Vertical sync) terminal.

HIGH is the normal setting. Change the setting to LOW when you use a long connecting cord and the picture flickers and blurs on the screen.

1 Press MENU/EXIT (or MENU on the Monitor) to display the Main Menu.

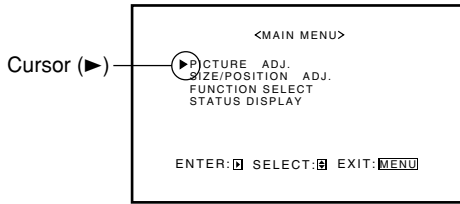

2 Press ▲/▼ to move the cursor (▶) to "FUNCTION SELECT."

3 Press ▶ to display the Function Selection Menu.

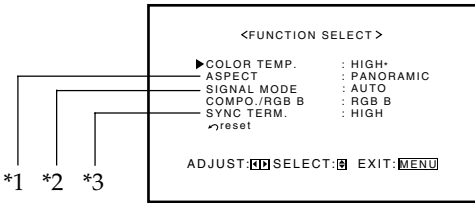

- *1 "ASPECT" does not appear when 720/60p, 720/50p, 1080/60i (1035/60i), or 1080/50i signal is being input through the COMPONENT/RGB B input terminals.
- *2 "SIGNAL MODE" appears only when VIDEO A, VIDEO B, or COMPONENT input is selected.
- *3 "SYNC TERM." appears only when the RGB B input is selected.

4 Press ▲/▼ to move the cursor (▶) to "SYNC TERM."

5 Press ◀/▶ to select the terminal resistance.

Each time you press the button, the resistance alternates between "HIGH" and "LOW."

- HIGH: Initial setting. Normally select this.
- LOW: When using a long connecting cord and the picture flickering and blurring on the screen.

6 Press MENU/EXIT (or MENU on the Monitor) twice to exit the menu operations.

Resetting the Function Selection Menu Settings

You can reset all the Function Selection Menu settings at a time.

1 Press MENU/EXIT (or MENU on the Monitor) to display the Main Menu.

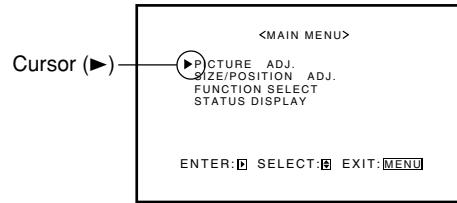

2 Press ▲/▼ to move the cursor (▶) to "FUNCTION SELECT."

3 Press ▶ to display the Function Selection Menu.

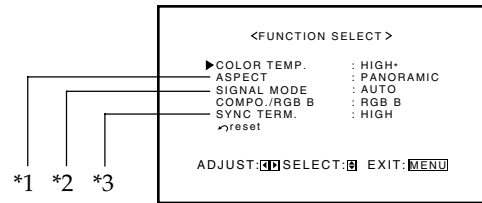

- *1 "ASPECT" does not appear when 720/60p, 720/50p, 1080/60i (1035/60i), or 1080/50i signal is being input through the COMPONENT/RGB B input terminals.
- *2 "SIGNAL MODE" appears only when VIDEO A, VIDEO B, or COMPONENT input is selected.
- *3 "SYNC TERM." appears only when the RGB B input is selected.

4 Press ▲/▼ to move the cursor (▶) to "reset."

5 Press ▶.

The confirmation screen appears.

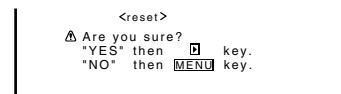

6 Press ▶ again to reset the adjustments.

To cancel the reset, press MENU/EXIT (or MENU on the Monitor).

Other Convenient Functions

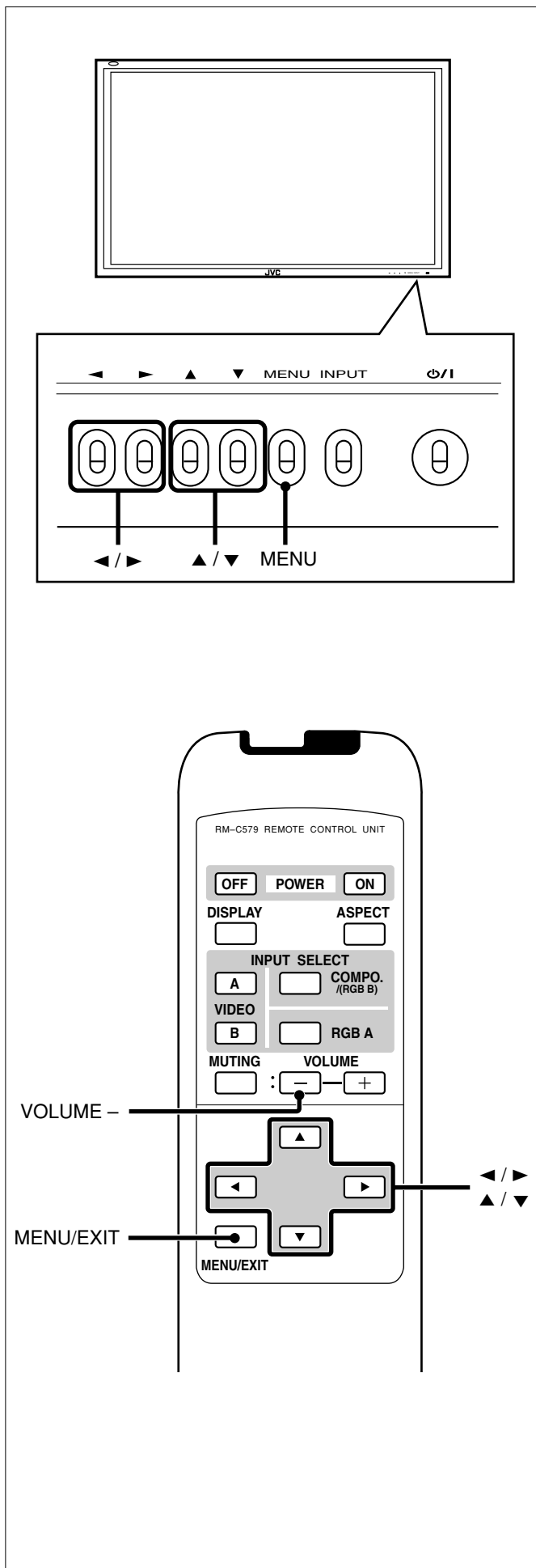

Showing On-screen Display

The input mode and signal type will be indicated on the screen.

- You can also show these information by pressing DISPLAY on the remote control. (See page 14.)

1 Press MENU/EXIT (or MENU on the Monitor) to display the Main Menu.

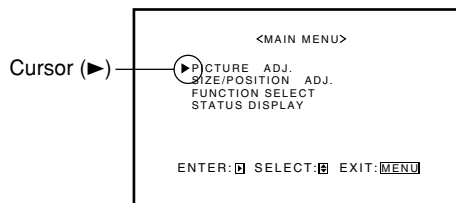

2 Press ▲/▼ to move the cursor (▶) to "STATUS DISPLAY."

3 Press ▶ to display the current input terminal and received signal type.

Ex. When selecting "VIDEO A" or "VIDEO B" input

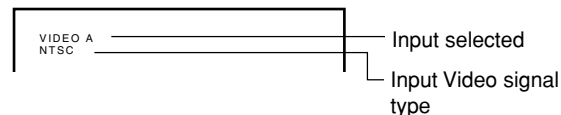

Ex. When selecting "COMPONENT" input

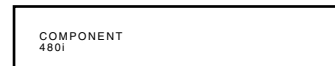

Ex. When selecting "RGB A" or "RGB B" input

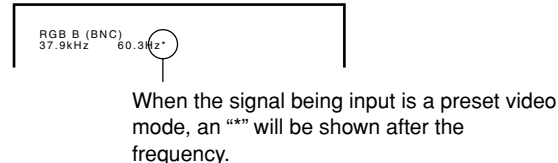

Note:

- If you want to make these information appear automatically when you change the input mode, see "Showing the On-screen When Changing the Input Mode" on page 23.

Showing the On-screen When Changing the Input Mode

With this function, you can see the selected input mode and signal type when changing the input mode.

- 1 On the remote control:**
Press **VOLUME** – while holding **MENU/EXIT** to display the Setup Menu.

On the Monitor:
Press **◀** while holding **MENU** to display the Setup Menu.

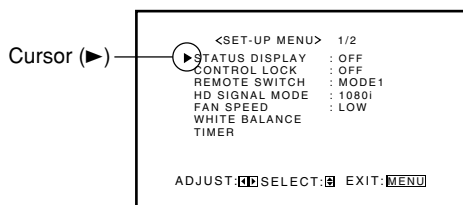

- 2 Press ▲/▼ to move the cursor (▶) to "STATUS DISPLAY."**
 - The Setup Menu consists of two pages. If you keep pressing ▲/▼, you can move to the other page from the current page.
- 3 Press ◀/▶ to select the desired setting.**
Each time you press the button, the Status Display function alternates between "ON" and "OFF."
To cancel the Status Display function, select "OFF."
- 4 Press MENU/EXIT (or MENU on the Monitor) once to exit from the menu operations.**

Prohibiting the Monitor's Button Operations

This function allows you to prohibit the button operations on the Monitor to prevent malfunction or avoid tampering.

- 1 On the remote control:**
Press **VOLUME** – while holding **MENU/EXIT** to display the Setup Menu.
On the Monitor:
Press **◀** while holding **MENU** to display the Setup Menu.

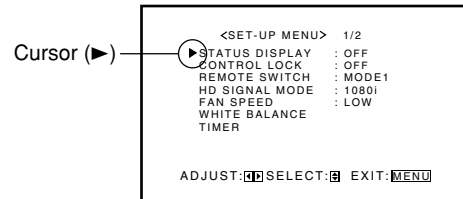

- 2 Press ▲/▼ to move the cursor (▶) to "CONTROL LOCK."**
 - The Setup Menu consists of two pages. If you keep pressing ▲/▼, you can move to the other page from the current page.
- 3 Press ◀/▶ to select the desired setting.**
Each time you press the button, the Control Lock function alternates between "ON" and "OFF."
To cancel the Control Lock function, select "OFF."
- 4 Press MENU/EXIT (or MENU on the Monitor) once to exit from the menu operations.**

Note:

- Even when the Control Lock function is in use, the following operations are possible:
 - Operation to cancel the Control Lock function
 - All operations from the remote control

Other Convenient Functions (Continued)

Setting the Remote-Controllable Input

When connecting the external control unit to the REMOTE MAKE terminal, you need to set the desired input to use, which you can select from the connected external control unit.

- On the remote control:**
Press **VOLUME** – while holding **MENU/EXIT** to display the Setup Menu.

On the Monitor:
Press **◀** while holding **MENU** to display the Setup Menu.

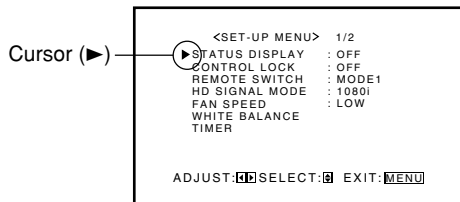

- Press **▲/▼** to move the cursor (▶) to **"REMOTE SWITCH."**

- The Setup Menu consists of two pages. If you keep pressing **▲/▼**, you can move to the other page from the current page.

- Press **◀/▶** to select the desired setting.

Each time you press the button, the Remote Switch Mode changes as follows:

- MODE1: Input alternates between "VIDEO A" and "VIDEO B" when controlled from the external control unit.
- MODE2: Input alternates between "VIDEO A" and "COMPONENT/RGB B" when controlled from the external control unit.
- MODE3: Input alternates between "VIDEO A" and "RGB A" when controlled from the external control unit.
- MODE4: Input alternates between "VIDEO B" and "COMPONENT/RGB B" when controlled from the external control unit.
- MODE5: Input alternates between "VIDEO B" and "RGB A" when controlled from the external control unit.
- MODE6: Input alternates between "COMPONENT/RGB B" and "RGB A" when controlled from the external control unit.

- Press **MENU/EXIT** (or **MENU** on the Monitor) once to exit from the menu operations.

Setting the High-Definition Signal Types

You can select one of the High-Definition (HD) signal types through the COMPONENT/RGB B terminals — 1080i or 1035i. Normally set it to "1080i."

- Without setting "COMPO./RGB B" correctly, you cannot show any picture though you select the COMPONENT input (see page 20).

- On the remote control:**
Press **VOLUME** – while holding **MENU/EXIT** to display the Setup Menu.

On the Monitor:
Press **◀** while holding **MENU** to display the Setup Menu.

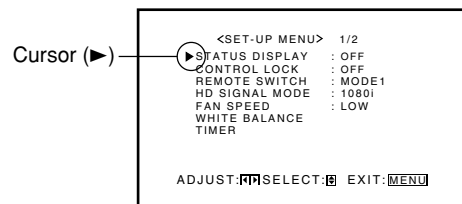

- Press **▲/▼** to move the cursor (▶) to **"HD SIGNAL MODE."**

- The Setup Menu consists of two pages. If you keep pressing **▲/▼**, you can move to the other page from the current page.

- Press **◀/▶** to select the desired setting.

Each time you press the button, the HD signal type alternates between "1080i" and "1035i."

- You can select either "1080i" and "1035i" according to the HD signal you input — whichever gives you proportionally shaped pictures.

- Press **MENU/EXIT** (or **MENU** on the Monitor) once to exit from the menu operations.

Setting the Speed of the Internal Cooling Fan

Set the speed of the internal cooling fan to "HIGH" when installing the Monitor vertically, so that the internal heat of the Monitor is released more effectively.

Note:

- When installing this Monitor vertically, it is also required to attach the external cooling fan unit. (See page 13.)

- On the remote control:**
Press **VOLUME** – while holding **MENU/EXIT** to display the Setup Menu.

On the Monitor:
Press **◀** while holding **MENU** to display the Setup Menu.

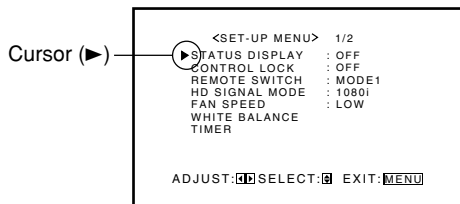

- Press **▲/▼** to move the cursor (▶) to "FAN SPEED."
 - The Setup Menu consists of two pages. If you keep pressing **▲/▼**, you can move to the other page from the current page.
- Press **◀/▶** to select the desired setting.
 Each time you press the button, the speed of the internal cooling fan changes as follows:
 LOW: Initial setting. Normally select this.
 HIGH: Select this when installing the Monitor vertically.
- Press **MENU/EXIT** (or **MENU** on the Monitor) once to exit from the menu operations.

Adjusting the White Balance

G GAIN, B GAIN and R GAIN can be finely adjusted separately for "HIGH" and "LOW" settings of the color temperature.

- On the remote control:**
Press **VOLUME** – while holding **MENU/EXIT** to display the Setup Menu.

On the Monitor:
Press **◀** while holding **MENU** to display the Setup Menu.

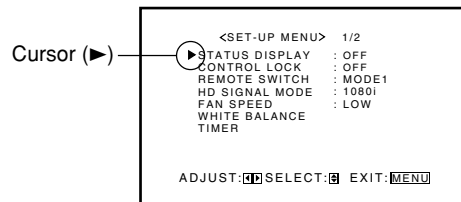

- Press **▲/▼** to move the cursor (▶) to "WHITE BALANCE."
 - The Setup Menu consists of two pages. If you keep pressing **▲/▼**, you can move to the other page from the current page.
- Press **▶** to display the White Balance Adjustment Menu.

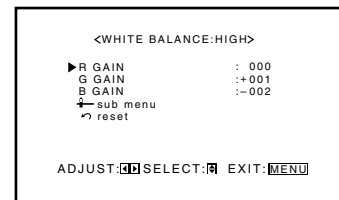

- Press **▲/▼** to move the cursor (▶) to the item you want to adjust.
- Press **◀/▶** to adjust the selected item.
- Repeat steps 4 and 5 to adjust the other items.
- Press **MENU/EXIT** (or **MENU** on the Monitor) twice to exit from the menu operations.

Notes:

- Adjustable range will vary among the Monitors.
- "MAX" may appear soon after you begin adjustment. This is normal but not a malfunction.

(To be continued on the next page)

Other Convenient Functions (Continued)

To make an adjustment while viewing the adjustment bars

After step 3 on page 25, proceed as follows:

- 1 Press ▲/▼ to move the cursor (▶) to "sub menu."
- 2 Press ▶ to display the Sub Menu.
The Sub Menu for R GAIN appears on the screen.

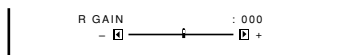

- 3 Press ▲/▼ to select the Sub Menu you want to adjust.
Each time you press the button, the Sub Menu changes as follows:

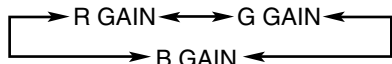

- 4 Press ◀/▶ to adjust the selected item.
- 5 Repeat steps 3 and 4 to adjust the other items.
- 6 Press MENU/EXIT (or MENU on the Monitor) three times to exit from the menu operations.

To reset the adjustments

After step 3 on page 25, proceed as follows:

- 1 Press ▲/▼ to move the cursor (▶) to "reset."
- 2 Press ▶.
The confirmation screen appears.

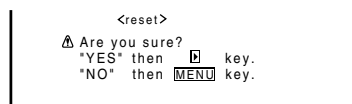

- 3 Press ▶ again to reset the adjustments.

To cancel the reset, press MENU/EXIT (or MENU on the Monitor).

Setting the Clock and the Power On/Off Timer

You can turn the Monitor on and off automatically with the Power On/Off timer.

- Since you cannot use the timer functions without setting the clock, set the clock at first.

• Setting the Clock

You can also adjust the clock with the following procedure.

- 1 **On the remote control:**
Press VOLUME – while holding MENU/EXIT to display the Setup Menu.

On the Monitor:

Press ◀ while holding MENU to display the Setup Menu.

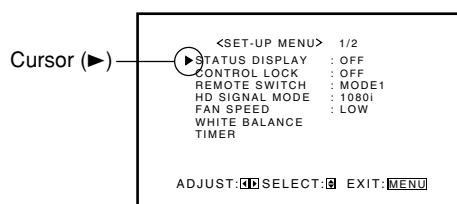

- 2 Press ▲/▼ to move the cursor (▶) to "TIMER," then press ▶ to display the Timer Menu.

- The Setup Menu consists of two pages. If you keep pressing ▲/▼, you can move to the other page from the current page.

Before the clock setting

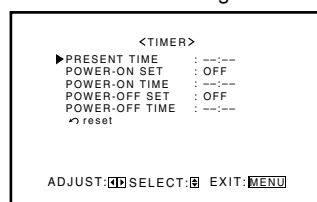

After the clock setting

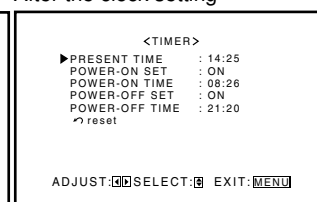

- 3 Press ▲/▼ to move the cursor (▶) to "PRESENT TIME," then press ▶.
- 4 Press ▲/▼ to move the cursor (▶) to "HOURS," then press ◀/▶ repeatedly to adjust the hour (24 hour clock).
- 5 Press ▲/▼ to move the cursor (▶) to "MINUTES," then press ◀/▶ repeatedly to adjust the minute.
- 6 Press MENU/EXIT (or MENU on the Monitor) three times to exit from the menu operations.

• Using the Power On/Off Timer

Select the item you want to set in step 3 in "Setting the Clock" (page 26) and follow the instructions below.

POWER-ON SET

You can activate/deactivate the Power-On Timer.

Press ◀/▶ to select "ON" or "OFF."

ON: The Monitor automatically turns on at the time set in "POWER-ON TIME."

OFF: The Power-On Timer is deactivated.

POWER-ON TIME

You can adjust the time to turn on the Monitor.

Set the hour and minute following steps 4 to 6 in "Setting the Clock" (page 26).

POWER-OFF SET

You can activate/deactivate the Power-Off Timer.

Press ◀/▶ to select "ON" or "OFF."

ON: The Monitor automatically turns off at the time set in "POWER-OFF TIME."

OFF: The Power-Off Timer is deactivated.

POWER-OFF TIME

You can adjust the time to turn off the Monitor.

Set the hour and minute following steps 4 to 6 in "Setting the Clock" (page 26).

To reset the timer setting

After step 2 on page 26, proceed as follows:

1 Press ▲/▼ to move the cursor (▶) to "reset."

2 Press ▶.

The confirmation screen appears.

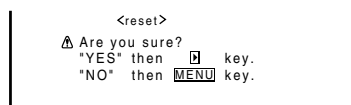

3 Press ▶ again to reset the setting.

To cancel the reset, press MENU/EXIT (or MENU on the Monitor).

About the Timer Battery

The timer clock works on the battery embedded in the Monitor.

If the battery becomes weak or has already run out, a message appears on the TIMER, COLOR-REVERSE, and REFRESH menus.

When the battery becomes weak (BATTERY LOW)

"BATTERY LOW" appears on the screen.

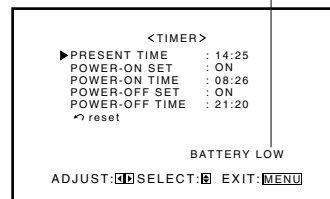

When the battery has run out (BATTERY EMPTY)

"BATTERY EMPTY" appears on the screen.

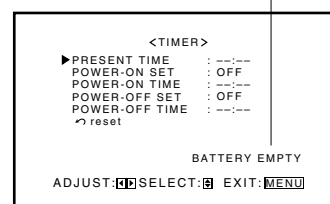

The clock is reset and "PRESENT TIME" is shown as "--:--"

- You cannot replace the battery yourself. Please consult your dealer to replace it.
- Set the clock and the timer functions (Power On/Off Timer, Color-Reverse On/Off Timer, and Refresh On/Off Timer) again after replacing the battery.
- You can use functions other than the timer functions without replacing the battery.

Other Convenient Functions (Continued)

Using the Pixel Shift Function

This function periodically shift the position (pixels) of the displayed picture on the screen so that you can avoid the screen from being burned in.

- 1 On the remote control:**
Press **VOLUME –** while holding **MENU/EXIT** to display the Setup Menu.

On the Monitor:
Press **◀** while holding **MENU** to display the Setup Menu.

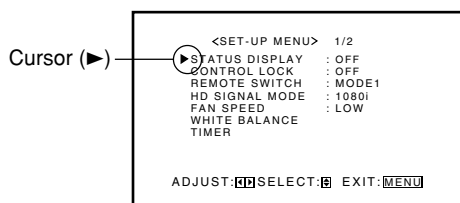

- 2 Press ▲/▼ to move the cursor (▶) to "PIXEL SHIFT" (on the second page).**
 - The Setup Menu consists of two pages. If you keep pressing ▲/▼, you can move to the other page from the current page.

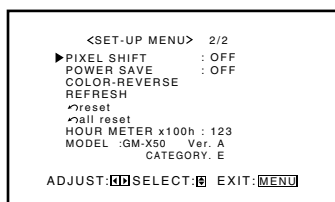

- 3 Press ◀/▶ to select the desired setting.**
Each time you press the button, the Pixel Shift function alternates between "ON" and "OFF."
To cancel the Pixel Shift function, select "OFF."
- 4 Press MENU/EXIT (or MENU on the Monitor) once to exit from the menu operations.**

Using the Power Save Function

You can use this function to reduce the electrical consumption and to extend the lifetime of the Monitor's screen.

- The brightness of the screen will be reduced.

- 1 On the remote control:**
Press **VOLUME –** while holding **MENU/EXIT** to display the Setup Menu.

On the Monitor:
Press **◀** while holding **MENU** to display the Setup Menu.

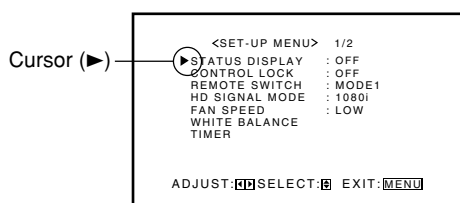

- 2 Press ▲/▼ to move the cursor (▶) to "POWER SAVE" (on the second page).**
 - The Setup Menu consists of two pages. If you keep pressing ▲/▼, you can move to the other page from the current page.

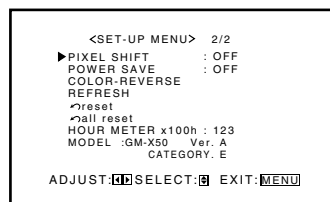

- 3 Press ◀/▶ to select the desired setting.**
SAVE1: The screen gets dim.
SAVE2: The screen gets dimmer.
OFF: The Power Save function is deactivate.
To cancel the Power Save function, select "OFF."
- 4 Press MENU/EXIT (or MENU on the Monitor) once to exit from the menu operations.**

Reducing the Afterimage Effect

If the same image (pattern) is continuously displayed on the screen for a long time, the area on the screen corresponding to the image may vary in brightness, leaving an afterimage on the screen.

You can reduce the afterimage by reversing the color of the image on the screen.

You can activate/deactivate the function with the Color-Reverse On/Off Timer.

- Display the image which has been caused the afterimage on the screen before starting the following procedure.

- 1 On the remote control:**
Press **VOLUME –** while holding **MENU/EXIT** to display the Setup Menu.

On the Monitor:
Press **◀** while holding **MENU** to display the Setup Menu.

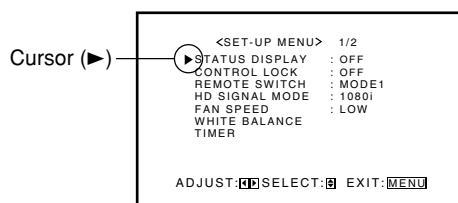

2 Press ▲/▼ to move the cursor (▶) to "COLOR-REVERSE" (on the second page), then press ▶.

- The Setup Menu consists of two pages. If you keep pressing ▲/▼, you can move to the other page from the current page.

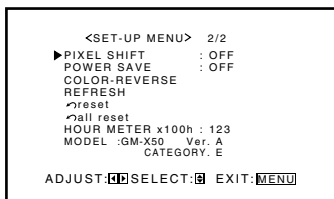

3 Press ▲/▼ to select the item you want to set and set the item as follows.

COLOR-REVERSE

You can activate/deactivate the function manually.

Press ◀/▶ to select the desired setting.

- ON: The function is activated immediately after exiting the menu operations.
- OFF: The function is deactivated.
- TIMER: Select this when you use the Color-Reverse On/Off Timer.

Note:

- Set the clock (see page 26) and select "TIMER," before using the Color-Reverse On/Off Timer.

START SET

You can activate/deactivate the Color-Reverse On Timer.

Press ◀/▶ to select "ON" or "OFF."

- ON: The function is automatically activated at the time set in "START TIME."
- OFF: The Color-Reverse On Timer is deactivated.

START TIME

You can adjust the time to activate the function.

- Set the hour and minute following steps 4 to 6 in "Setting the Clock" (page 26).

END SET

You can activate/deactivate the Color-Reverse Off Timer.

- Press ◀/▶ to select "ON" or "OFF."
 - ON: The function is automatically deactivated at the time set in "END TIME."
 - OFF: The Color-Reverse Off Timer is deactivated.

END TIME

You can adjust the time to deactivate the function.

- Set the hour and minute following steps 4 to 6 in "Setting the Clock" (page 26).

4 Press MENU/EXIT (or MENU on the Monitor) repeatedly to exit from the menu operations.

To reset the Color-Reverse setting

After step 2 on the left column, proceed as follows:

- Press ▲/▼ to move the cursor (▶) to "reset."
- Press ▶.

The confirmation screen appears.

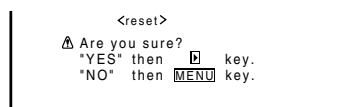

- Press ▶ again to reset the setting.

To cancel the reset, press MENU/EXIT (or MENU on the Monitor).

Note:

- The Color-Reverse function requires considerable time to reduce the afterimage. Deactivate the function temporarily at intervals of 30 minutes-1 hour and check the screen if the afterimage still remains or not. Set the function to off if the afterimage has been reduced.

Refreshing the Screen

After the power is turned off, a whitish image may be left on the screen. In that case, leave the monitor in a white back state for a while, and the image will disappear.

You can activate/deactivate the function with the Refresh On/Off Timer.

- On the remote control:
Press VOLUME – while holding MENU/EXIT to display the Setup Menu.

On the Monitor:

Press ◀ while holding MENU to display the Setup Menu.

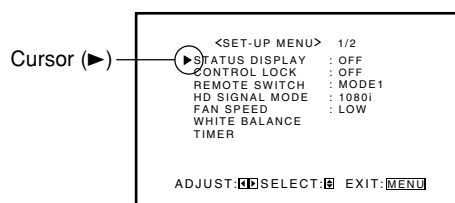

- Press ▲/▼ to move the cursor (▶) to "REFRESH" (on the second page) then press ▶.

- The Setup Menu consists of two pages. If you keep pressing ▲/▼, you can move to the other page from the current page.

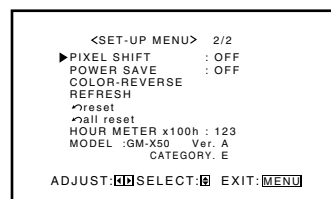

(To be continued on the next page)

Other Convenient Functions (Continued)

3 Press ▲/▼ to select the item you want to set and set the item as follows.

REFRESH

You can activate/deactivate the function manually.

- Press ◀/▶ to select the desired setting.

ON: The function is activated immediately after exiting the menu operations.

OFF: The function is deactivated.

TIMER: Select this when you use the Refresh On/Off Timer.

Note:

- Set the clock (see page 26) and select "TIMER," before using the Refresh On/Off Timer.

START SET

You can activate/deactivate the Refresh On Timer.

- Press ◀/▶ to select "ON" or "OFF."

ON: The function is automatically activated at the time set in "START TIME."

OFF: The Refresh On Timer is deactivated.

START TIME

You can adjust the time to activate the function.

- Set the hour and minute following steps 4 to 6 in "Setting the Clock" (page 26).

END SET

You can activate/deactivate the Refresh Off Timer.

- Press ◀/▶ to select "ON" or "OFF."

ON: The function is automatically deactivated at the time set in "END TIME."

OFF: The Refresh Off Timer is deactivated.

END TIME

You can adjust the time to deactivate the function.

- Set the hour and minute following steps 4 to 6 on "Setting the Clock" (page 26).

4 Press MENU/EXIT (or MENU on the Monitor) repeatedly to exit from the menu operations.

To reset the Refresh function setting

After step 2 above, proceed as follows:

- 1 Press ▲/▼ to move the cursor (▶) to "reset."

- 2 Press ▶.

The confirmation screen appears.

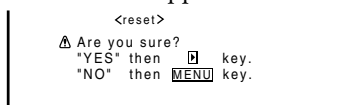

- 3 Press ▶ again to reset the setting.

To cancel the reset, press MENU/EXIT (or MENU on the Monitor).

Note:

- The Refresh function requires considerable time to reduce the afterimage. Deactivate the function temporarily at intervals of 30 minutes-1 hour and check the screen if the afterimage still remains or not. Set the function to off if the afterimage has been reduced.

Notes on the Color-Reverse/Refresh Timer

- Once you set the Color-Reverse/Refresh timer, the timer function is still activated even if you turn off the power. If you turn on the power after the "START TIME" you set, Color-Reverse/Refresh function is activated. To cancel the function, select "OFF" in the menu (see pages 29 and 30).
- The Color-Reverse timer is deactivated when you turn on or off the Color-Reverse function manually. The Refresh timer works in the same way as mentioned above. Select "TIMER" in the menu to control the functions automatically (see pages 29 and 30).

Resetting All the Setup Menu Settings

You can reset all the following Setup Menu settings at a time, except the use time (HOUR METER).

- 1 **On the remote control:**
Press VOLUME – while holding MENU/EXIT to display the Setup Menu.

On the Monitor:

Press ◀ while holding MENU to display the Setup Menu.

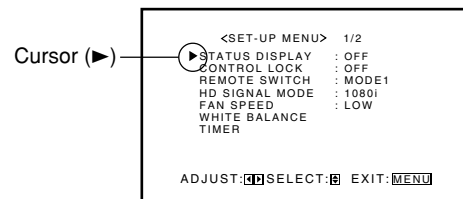

- 2 Press ▲/▼ to move the cursor (▶) to "reset" (on the second page).

- The Setup Menu consists of two pages. If you keep pressing ▲/▼, you can move to the other page from the current page.

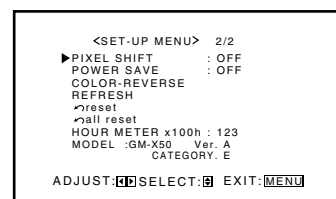

3 Press ►.

The confirmation screen appears.

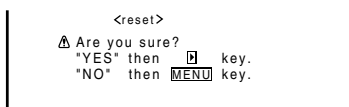

To cancel the reset, press MENU/EXIT (or MENU on the Monitor).

4 Press ► again to reset all the Setup Menu settings.

Resetting All the Menu Settings

You can reset all the Menu settings and adjustments at a time, except the use time (HOUR METER).

1 On the remote control:

Press VOLUME – while holding MENU/EXIT to display the Setup Menu.

On the Monitor:

Press ◀ while holding MENU to display the Setup Menu.

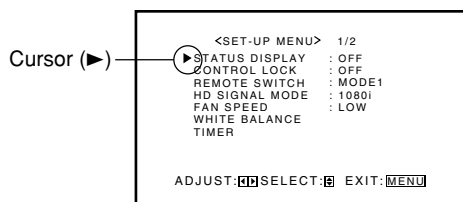

2 Press ▲/▼ to move the cursor (►) to “all reset” (on the second page).

- The Setup Menu consists of two pages. If you keep pressing ▲/▼, you can move to the other page from the current page.

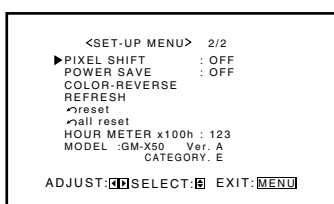

3 Press ►.

The confirmation screen appears.

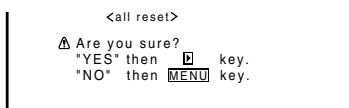

To cancel the reset, press MENU/EXIT (or MENU on the Monitor).

4 Press ► again to reset all the Menu settings and adjustments.

The power is turned off, then turned on again automatically.

Confirming the Use Time and Model Information

You can confirm the hours of use and the model information on the Setup Menu.

This may be necessary when you ask for any service.

1 On the remote control:

Press VOLUME – while holding MENU/EXIT to display the Setup Menu.

On the Monitor:

Press ◀ while holding MENU to display the Setup Menu.

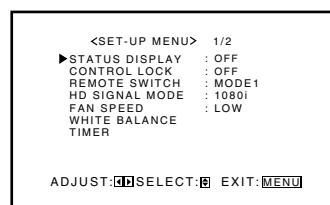

2 Keep pressing ▲/▼ until the second page of the Setup Menu appears.

- The Setup Menu consists of two pages. If you keep pressing ▲/▼, you can move to the other page from the current page.

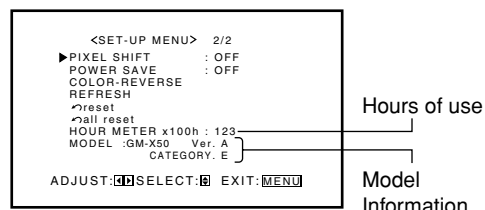

3 Confirm the hour of use and model information.

- The displayed value for the hours of use is divided by 100. To calculate the actual hours of use, multiply the displayed value by 100.

4 Press MENU/EXIT (or MENU on the Monitor) once to exit from the menu operations.

Notes:

- The value for the hours of use is added by one hour unit. If you use the monitor within one hour, it will not be added to the hours of use.
- The period when the monitor is on standby (the power lamp glows orange) will not be added to the hours of use.

Menu Classifications

Main Menu

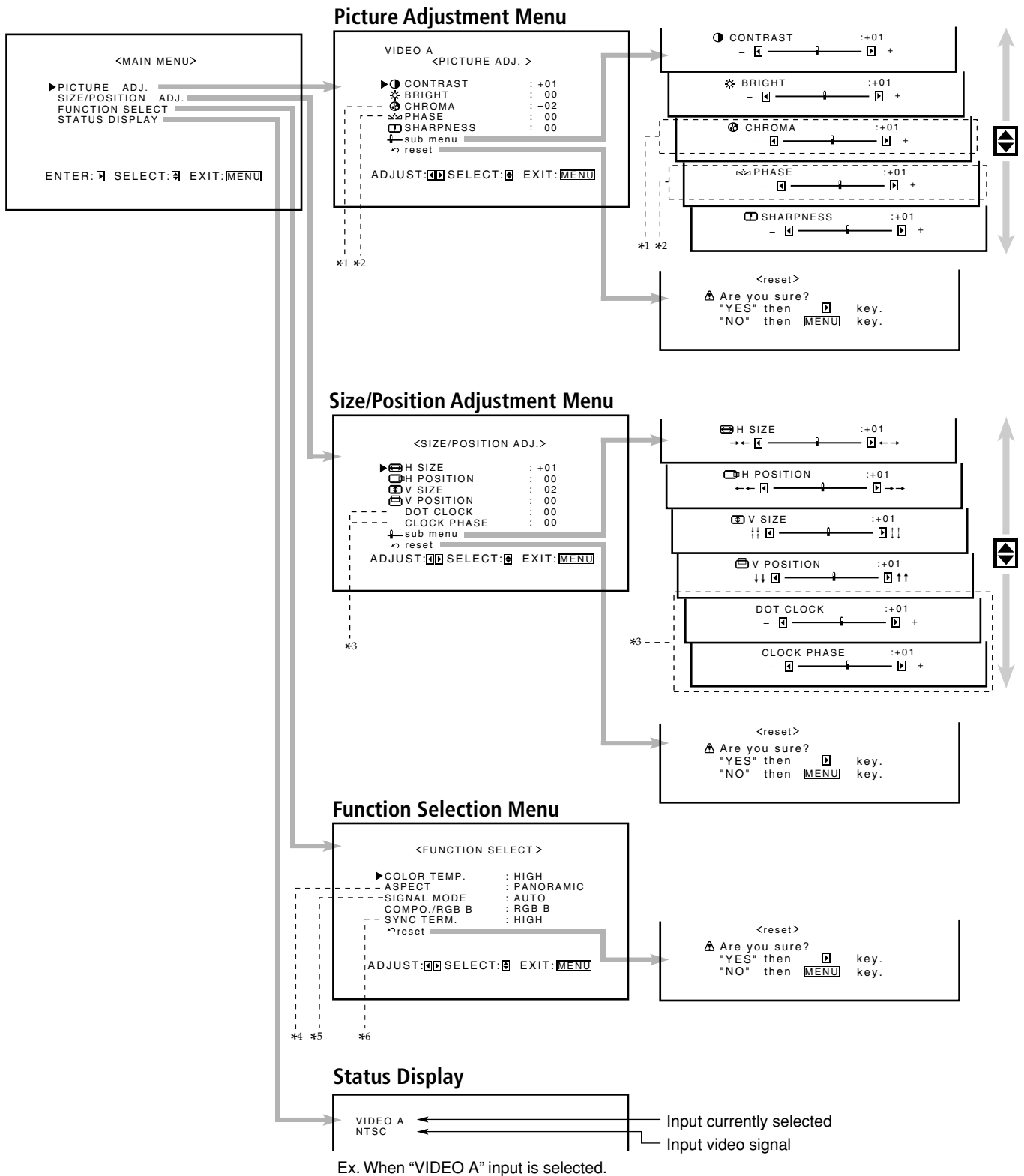

PICTURE ADJ. (Picture adjustment): See page 16.

CONTRAST	Adjusts the contrast of the picture.
BRIGHT	Adjusts the brightness of the picture.
CHROMA* ¹	Adjusts the color density of the picture.
PHASE* ²	Adjusts the color phase.
SHARPNESS	Adjusts the outlines of the picture.
sub menu	Displays the fine adjustment bar.
reset	Resets the Picture Adjustment Menu settings to defaults.

SIZE/POSITION ADJ. : See page 17.

H SIZE	Adjusts the horizontal screen size.
H POSITION	Adjusts the horizontal screen position.
V SIZE	Adjusts the vertical screen size.
V POSITION	Adjusts the vertical screen position.
DOT CLOCK* ³	Adjusts to eliminate stripes or flickering. Use with "CLOCK PHASE." Normally, no adjustment is needed.
CLOCK PHASE* ³	Adjusts to eliminate stripes or flickering. Use with "DOT CLOCK." Normally, no adjustment is needed.
sub menu	Displays the fine adjustment bar.
reset	Resets Size/position Adjustment Menu settings to defaults.

FUNCTION SELECT: See pages 19 to 21.

COLOR TEMP.	Adjusts the color temperature. Use when the picture is reddish or bluish.
ASPECT* ⁴	Selects the horizontal to vertical ratio of the screen.
SIGNAL MODE* ⁵	<ul style="list-style-type: none"> • Selects a color system (NTSC, PAL, SECAM, N4.43 (NTSC 4.43), PAL60) when VIDEO A or VIDEO B input is selected. Normally, set to "AUTO." • Selects a scan system—480i, 576i, 480p, 576p, 720/60p, 720/50p, 1080/60i (1035i), 1080/50i—when COMPONENT input is selected. Normally, set to "AUTO."
COMPO./RGB B	Selects the usage of the COMPONENT/RGB B terminals either as the COMPONENT input terminal or as the RGB B input terminal.
SYNC TERM.* ⁶	Adjusts the resistance of RGB B input terminals.
reset	Resets the Function Selection Menu settings to defaults.

STATUS DISPLAY: See page 22.

Shows the input mode and signal type on the screen.

*¹ Adjustable when viewing the NTSC, PAL, or SECAM signal, or component signal.

*² Adjustable when viewing the NTSC signal or component signal.

*³ Adjustable when RGB A or RGB B input is selected.

*⁴ Not adjustable when viewing the following component signals—720/60p, 720/50p, 1080/60i (1035/60i), and 1080/50i. (In such a case, "ASPECT" does not appear on the display.)

*⁵ Adjustable when VIDEO A, VIDEO B, or COMPONENT input is selected.

*⁶ Adjustable when RGB B input is selected.

Menu Classifications (Continued)

Setup Menu

```

<SET-UP MENU> 1/2
▶STATUS DISPLAY : OFF
CONTROL LOCK : OFF
REMOTE SWITCH : MODE1
HD SIGNAL MODE : 1080i
FAN SPEED : LOW
WHITE BALANCE
TIMER
ADJUST: [F4] SELECT: [F5] EXIT: [MENU]
    
```

White Balance Adjustment Menu

```

<WHITE BALANCE:HIGH>
▶R GAIN : 000
G GAIN : +001
B GAIN : -002
└ sub menu
  ↪ reset
ADJUST: [F4] SELECT: [F5] EXIT: [MENU]
    
```

```

R GAIN : 000
- [F4] ────┬─── [F5] +
G GAIN : +001
- [F4] ────┬─── [F5] +
B GAIN : -002
- [F4] ────┬─── [F5] +
    
```

```

<reset>
⚠ Are you sure?
"YES" then [F4] key.
"NO" then [MENU] key.
    
```

To "Reset Confirmation Screen"

Timer Menu

```

<TIMER>
▶PRESENT TIME : 14:25
POWER-ON SET : ON
POWER-ON TIME : 08:26
POWER-OFF SET : ON
POWER-OFF TIME : 21:20
↪ reset
ADJUST: [F4] SELECT: [F5] EXIT: [MENU]
    
```

```

<TIMER>
PRESENT TIME : 14:25
▶HOURS : 14
MINUTES : 25
    
```

```

<TIMER>
POWER-ON TIME : 08:26
▶HOURS : 08
MINUTES : 26
    
```

```

<TIMER>
POWER-OFF TIME : 21:20
▶HOURS : 21
MINUTES : 20
    
```

To "Reset Confirmation Screen"

```

<SET-UP MENU> 2/2
▶PIXEL SHIFT : OFF
POWER SAVE : OFF
COLOR-REVERSE : OFF
REFRESH
↪reset
↪all reset
HOUR METER x100h : 123
MODEL :GM-X50 Ver. A
CATEGORY. E
ADJUST: [F4] SELECT: [F5] EXIT: [MENU]
    
```

Color-Reverse Menu

```

<COLOR-REVERSE>
▶COLOR-REVERSE : OFF
START SET : ON
START TIME : 08:06
END SET : ON
END TIME : 21:47
↪ reset
ADJUST: [F4] SELECT: [F5] EXIT: [MENU]
    
```

```

<COLOR-REVERSE>
START TIME : 08:06
▶HOURS : 08
MINUTES : 06
    
```

```

<COLOR-REVERSE>
END TIME : 21:47
▶HOURS : 21
MINUTES : 47
    
```

To "Reset Confirmation Screen"

Refresh Menu

```

<REFRESH>
▶REFRESH : OFF
START SET : ON
START TIME : 12:10
END SET : ON
END TIME : 14:24
↪ reset
ADJUST: [F4] SELECT: [F5] EXIT: [MENU]
    
```

```

<REFRESH>
START TIME : 12:10
▶HOURS : 12
MINUTES : 10
    
```

```

<REFRESH>
END TIME : 14:24
▶HOURS : 14
MINUTES : 24
    
```

To "Reset Confirmation Screen"

```

<all reset>
⚠ Are you sure?
"YES" then [F4] key.
"NO" then [MENU] key.
    
```

STATUS DISPLAY: See page 23.

Sets if you want the input terminal and the type of signal to be indicated on the screen just after inputs are switched.

CONTROL LOCK: See page 23.

Sets the Monitor so that it cannot be operated with the buttons on itself.

REMOTE SWITCH: See page 24.

Set the selectable input terminals when controlling the Monitor with the external control unit.

HD SIGNAL MODE: See page 24.

Select the High-Definition (HD) signal type.

FAN SPEED: See page 25.

Sets the speed of the internal cooling fan.

WHITE BALANCE: See page 25.

Adjusts R GAIN, G GAIN and B GAIN finely each for "HIGH" and "LOW" settings of the color temperature.

TIMER: See pages 26 and 27.

Sets the clock and the Power On/Off Timer.

PIXEL SHIFT: See page 28.

Sets a screen saver.

POWER SAVE: See page 28.

Sets the power save function.

COLOR-REVERSE: See page 28.

Use to reduce the afterimage on the screen of the still picture by reversing the color.

REFRESH: See page 29.

Use to reduce the whitish image remaining on the screen after turning off the power.

reset: See page 30.

Resets the Setup Menu settings to defaults.

all reset: See page 31.

Resets the all menu settings and adjustments to defaults.

HOUR METER x 100h: See page 31.

Use to confirm the hours of use.

MODEL: See page 31.

Use to confirm the model information of the Monitor.

Troubleshooting

Solutions to common problems related to the Monitor are described here. If none of the solutions presented here solves the problem, unplug the Monitor and consult an authorized dealer or service center.

Symptom	Probable cause	Corrective action	Page
Power is not supplied.	•Is the power cord disconnected?	•Insert the power cord (plug) firmly.	12
	•Is the POWER switch turned on?	•Turn on the POWER switch.	14
Power is suddenly turned on or off.	•Is the Power On/Off Timer activated?	•Set the timer to "OFF" on the menu.	26
Video image does not appear, or audio sound does not occur.	•Is the correct input selected?	•Select the correct input by pressing INPUT SELECT (VIDEO A, VIDEO B, COMPO./ (RGB B) or RGB A) on the remote control (or INPUT on the Monitor).	14
	•Are the devices connected correctly?	•Connect the devices correctly.	11, 12
	•Are signals being supplied from the connected devices?	•Set the devices correctly.	—
	•Is "COMPO./RGB B" set correctly if using the COMPONENT/RGB B terminals?	•Set it correctly.	20
	•Are input signals (scanning frequency, etc.) appropriate?	•Check if the signal is appropriate (scanning frequency, etc.), and input the appropriate signal.	10
	•Is brightness adjusted correctly?	•Adjust brightness on the menu.	16
	•Is volume set at minimum?	•Adjust volume.	14
	•Are the diagnostic lamps turned on?	•Refer to "Self-diagnostic Indication," and take an appropriate action.	37
The picture becomes blurred.	•Is the signal RGB input?	•Adjust DOT CLOCK and CLOCK PHASE using the menu.	17
	•Is the RGB B connecting cord long?	•Set the SYNC TERM. "LOW."	21
Color is abnormally dark or bright.	•Is brightness adjusted correctly?	•Adjust BRIGHT (brightness) using the menu.	16
	•Is picture quality (color density, etc.) adjusted correctly?	•Adjust picture using the menu.	16
	•"TEMP. OVER" lights (or flashes) at the right bottom of the screen.	•Refer to "Self-diagnostic Indication," and take an appropriate action.	37
Color is poor or unstable.	•Is the correct broadcast system (color system) selected?	•Set SIGNAL MODE (color system) to "AUTO."	20
	•Are signals (scanning frequency, etc.) to connected devices appropriate?	•Check if the signal is appropriate (scanning frequency, etc.), and input the appropriate signal.	10
Color is suddenly reversed or whitened.	•Is the Color-Reverse/Refresh timer activated?	•Set "COLOR-REVERSE"/"REFRESH" to "OFF" on the menu.	29, 30
The picture is cut or shifted toward one side.	•Is the size or position of the screen adjusted properly?	•Adjust H SIZE, V SIZE, H POSITION or V POSITION using the menu.	17
The remote control does not work.	•Are the batteries correctly set?	•Insert batteries correctly, observing the polarities (⊕ and ⊖).	8
	•Are the batteries exhausted?	•Replace with new batteries.	8
	•Is there any object blocking the path between the remote control and remote sensor?	•Remove any blocking object.	—
	•Is the Monitor too far away from you?	•Move toward the Monitor, then operate the remote control.	—
The buttons on the Monitor do not work.	•Is the Control Lock function in use?	•Set the Control Lock function to "OFF" using the menu.	23

Self-diagnostic Indication

When something abnormal occurs with the Monitor, this function informs you of the condition of the Monitor with self-diagnostic lamps, allowing for smooth service work.

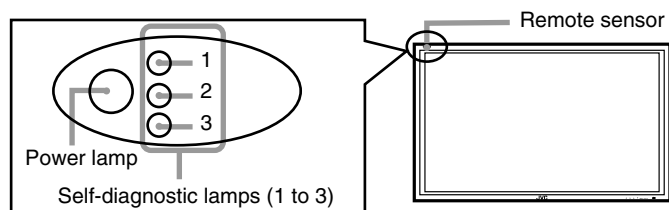

❑ If the screen monitor turns off and self-diagnostic lamps light or flash

If the self-diagnostic lamps light or flash in red, check the following before consulting the dealer where you purchased the Monitor.

- **If self-diagnostic lamp 1 (upper) flashes, lamp 2 (middle) lights, and lamp 3 (lower) flashes**

This may be caused by the dusty intakes on the rear. If this happens, switch off the main power by POWER switch (set to "O (off)"), unplug the AC power cord, then clean the intakes by referring to the instruction on page 2.

- After cleaning, switch on the Monitor's main power again. If self-diagnostic lamps do not go off, consult your dealer immediately.

❑ If the screen monitor dims a little and "TEMP. OVER" lights (or flashes)

If "TEMP. OVER" lights or flashes at the right bottom of the screen, check the following before consulting the dealer where you purchased the Monitor.

"TEMP. OVER" appears to warn you of the internal heat buildup, which is usually caused by accumulated dust around the intakes or by improper installation. If the cause of the internal heat buildup is eliminated, this indication disappears and the screen recovers the brightness.

- **If "TEMP. OVER" flashes in yellow**

This may be caused by the dusty intakes on the rear. If this happens, switch off the main power by POWER switch (set to "O (off)"), unplug the AC power cord, then clean the intakes by referring to the instruction on page 2.

- After cleaning, switch on the Monitor's main power again. If "TEMP. OVER" still flashes, this trouble may be caused by improper installation or improper location of the Monitor. In this case, consult your dealer immediately to solve this improper installation and to improve the circumstances around the Monitor.

- **If "TEMP. OVER" lights in red**

"TEMP. OVER" will be shown for about two minutes, the Monitor will shut off automatically, then the Self-diagonal lamps light in red. If this happens, switch off the main power by POWER switch (set to "O (off)"), unplug the AC power cord, then consult your dealer immediately.

If the trouble still persists, follow the procedure below:

1 Check which lamps are lighting or flashing.

On the Self-diagnostic Report Sheet (below), check the box next to "Lights" or "Flashes" of the corresponding lamp or lamps.

- Only one lamp may light or flash, or all three lamps may do so.

2 Switch off the POWER switch on the back of the Monitor.

3 Unplug the power cord.

4 Call your dealer and tell which lamps are lighting or flashing. (Copy and fax the Self-diagnostic Report Sheet below.)

Note:

If you switch on the main power immediately after switching it off (or after recovering from a brief power interruption), the self-diagnostic lamps may light (or flash), and no image may appear on the screen. In this case, switch off the main power again, wait for about 10 seconds, then switch it on again. If no self-diagnostic lamps light or flash, you can operate and use the Monitor as usual.

Self-diagnostic Report Sheet

Store name where you purchased the Monitor

To _____

Model Name:

Plasma Display Monitor
GM-X50E

The self-diagnostic lamps light or flash as listed on the following table. Please give me immediate advice or service if necessary.

Self-diagnostic lamps			
NO.	Lamp position	Conditions	
1	Upper	<input type="checkbox"/> Lights	<input type="checkbox"/> Flashes
2	Middle	<input type="checkbox"/> Lights	<input type="checkbox"/> Flashes
3	Lower	<input type="checkbox"/> Lights	<input type="checkbox"/> Flashes
TEMP. OVER		<input type="checkbox"/> Lights	<input type="checkbox"/> Flashes

Your Name:	
Telephone No.:	
Address:	

Specifications

	Model name	GM-X50E		
General	Frame color	Silver		
	Screen size	Type 50 wide format		
	Aspect ratio	16:9 (Wide format)		
	Number of pixels displayed	1366 (H) x 768 (V)		
	Number of colors displayed	16.77 million (256 colors for each of RGB)		
	Effective screen size (W x H, Diagonally)	110.7 cm x 62.2 cm, 127 cm		
	Weight	50 kg		
	External dimensions (W x H x D)	123.2 cm x 74.3 cm x 10.3 cm * Excluding protruding parts		
	Power requirements	AC 220 – 240 V, 50 Hz/60 Hz		
	Rated input current	2.2 A		
	Compatible systems			
	VIDEO A, VIDEO B input	NTSC, NTSC 4.43, PAL, PAL 60, SECAM		
	COMPONENT input	480i, 576i, 480p, 576p, 720/60p, 720/50p, 1080/60i (1035/60i), 1080/50i		
	Audio power output	SPEAKER OUT: 6 Ω to 8 Ω 3 W + 3 W (TYP at impedance 6 Ω)		
Operating conditions	Temperature: 0 °C to 40 °C Relative humidity: 20 % to 80 % (non-condensation) (Slightly variable depending on ambient conditions for installation.)			
Input/output terminals	VIDEO A			
	Video input	BNC terminal x 1, 1 V(p-p), 75 Ω		
	Video output	BNC terminal x 1, 1 V(p-p), 75 Ω		
	Audio input	Pin jack terminal x 2 (L/R) 500 mV(rms), high impedance		
	VIDEO B			
	Y/C input	Y/C terminal x 1 Y: 1 V(p-p), 75 Ω C: 0.286 V(p-p), 75 Ω (for NTSC) C: 0.3 V(p-p), 75 Ω (for PAL/SECAM)		
	Video input	Pin jack terminal x 1, 1 V(p-p), 75 Ω		
	Audio input	Pin jack terminal x 2 (L/R) 500 mV(rms), high impedance		
	COMPONENT/RGB B *			
	COMPONENT input	BNC terminal x 3 Y: 1 V(p-p), 75 Ω P _B /B-Y: 0.7 V(p-p), 75 Ω P _R /R-Y: 0.7 V(p-p), 75 Ω		
	RGB input	BNC terminal x 5 <u>Analog RGB:</u> R: 0.7 V(p-p), 75 Ω G: 0.7 V(p-p), 75 Ω B: 0.7 V(p-p), 75 Ω G on sync: 1 V(p-p), 75 Ω (negative sync) <u>Horizontal sync/Composite sync (HD/Cs):</u> HD: 0.3 V(p-p) to 5 V(p-p), 1 kΩ (positive/negative polarity) / 75 Ω (positive/negative polarity) Cs: 0.3 V(p-p) to 5 V(p-p), 1 kΩ (positive/negative polarity) / 75 Ω (positive/negative polarity) <u>Vertical sync (VD):</u> VD: 1 V(p-p) to 5 V(p-p), 1 kΩ (positive/negative polarity) / 75 Ω (positive/negative polarity)		
Audio input	Pin jack terminal x 2 (L/R) 500 mV(rms), high impedance			

Input/output terminals	<div style="border: 1px solid black; display: inline-block; padding: 2px;">RGB A</div> RGB input	D-sub 3-row 15-pin terminal x 1, Video signal: 0.7 V(p-p), 75 Ω G on sync: 1 V(p-p), 75 Ω (negative sync) <u>Horizontal sync/Composite sync (HD/Cs):</u> HD: 0.3 V(p-p) to 5 V(p-p), 470 Ω (positive/negative polarity) Cs: 0.3 V(p-p) to 5 V(p-p), 470 Ω (positive/negative polarity) <u>Vertical sync (VD):</u> VD: 1 V(p-p) to 5 V(p-p), 470 Ω (positive/negative polarity)
	Audio input	Stereo mini jack terminal x 1 500 mV(rms), high impedance
	REMOTE terminals	RS-232C: D-sub 9-pin terminal x 1 MAKE: Mini DIN 4 pin WIRED: Stereo mini jack terminal x 1
	OPTION terminal	Used exclusively for JVC's optional parts
	AUDIO OUT terminals	Pin jack terminal x 2 (L/R) Output impedance 600 Ω
	SPEAKER OUT (L/R) terminals	Impedance 6 Ω to 8 Ω

* To use the COMPONENT/RGB B terminals either as the COMPONENT input terminal or as the RGB B input terminal, you need to set "COMPO./RGB B" correctly (see page 20).

- For easy understanding, pictures and illustrations are shown by being emphasized, omitted or composed, and may be more or less different from actual products.
- Design and specifications are subject to change without notice.
- IBM and IBM PC are registered trademarks of International Business Machines Corporation. Macintosh is registered trademarks of Apple Computer, Inc.
 All other product names mentioned herein are used for identification purposes only, and may be the trademarks or registered trademarks of their respective companies.

Options (not supplied)

- Stand Unit TS-CL01SG, TS-CL02SG
- Wall Mounting Unit TS-C420P2W, TS-C420P6W, TS-C420P8W, TS-C420P9W
- Ceiling Suspension Unit TS-C420P3W
- Cooling Fan Unit TS-C01FANG
- Speaker Unit TS-C500SPG

• Consult your dealer to see if other options are available.

Notice on transportation

This Monitor is precision equipment and needs dedicated packing material for transportation. Never use any packing material supplied from other than JVC or JVC-authorized dealers.

Specifications (Continued)

Pin assignment (Specifications for terminals)

- Y/C terminal

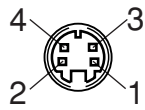

Pin number	Signal name
1	GND (Y)
2	GND (C)
3	Y
4	C

- RS-232C terminal

This is a female type connector.

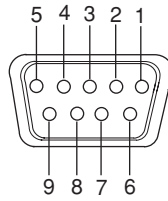

Pin number	Signal name	Pin number	Signal name
1	DCD	6	DSR
2	RD	7	RTS
3	TD	8	CTS
4	DTR	9	RI
5	GND		

- MAKE terminal

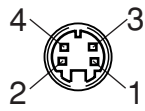

Pin number	Signal name
1	GND
2	GND
3	SW2
4	SW1

- RGB Input Terminal

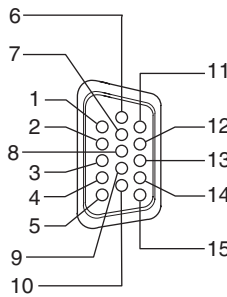

Pin number	Signal name	Pin number	Signal name
1	Red	9	N/C
2	Green	10	GND
3	Blue	11	GND
4	N/C	12	N/C
5	GND	13	HD/Cs
6	GND	14	VD
7	GND	15	N/C
8	GND	External	GND

Dimensions

Top view

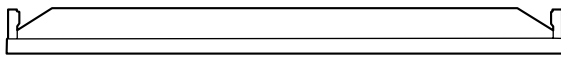

Front view

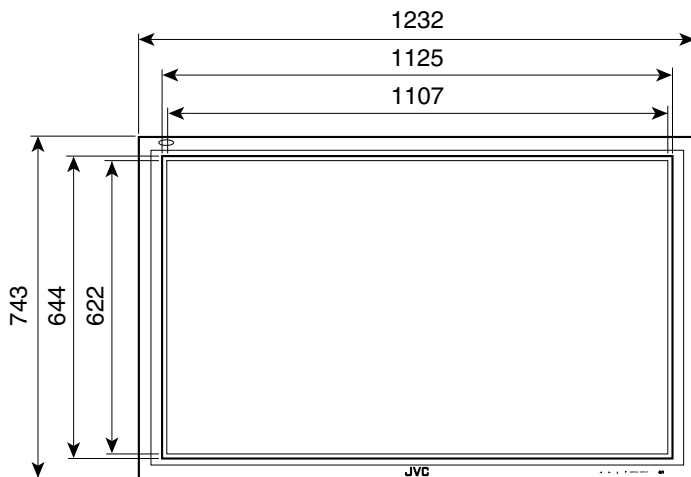

Side view

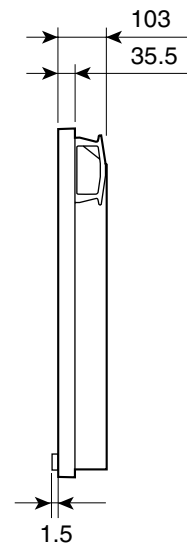

Unit: mm

JVC





ENGLISH

DEUTSCH

FRANÇAIS

ITALIANO

ESPAÑOL

中
文

PLASMA DISPLAY MONITOR

BEDIENUNGSANLEITUNG : PLASMABILDSCHIRM

MANUEL D'INSTRUCTIONS : MONITEUR DE VISUALISATION PLASMA

MANUALE D'ISTRUZIONI : MONITOR CON SCHERMO AL PLASMA

MANUAL DE INSTRUCCIONES : MONITOR DISPLAY DE PLASMA

使用说明书：等离子显示器

GM-X50S

INSTRUCTIONS

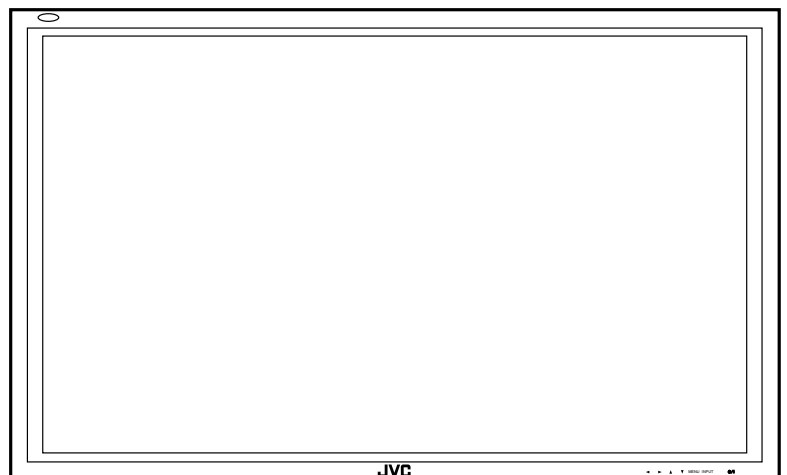

LCT1603-001A



INSTRUCTIONS

Model
GM-X50S

*Thank you for purchasing this JVC Monitor.
Before using the monitor, read this manual carefully so that you know how to use the Monitor correctly.
Refer to this manual whenever questions or problems about operation arise. Be sure to read and observe the safety precautions.
Keep this manual where the user can see it easily.
* Installation and removal require special expertise.
Consult your product dealer for details.*

ENGLISH

Contents

	Page		Page
Safety Precautions	2	Other Convenient Functions	22
Parts Identification	4	• Showing On-screen Display	22
• Monitor: Front View	4	• Showing the On-screen When Changing	
• Monitor: Rear Views ①	5	the Input Mode	23
• Monitor: Rear Views ②	6	• Prohibiting the Monitor's Button Operations	23
• Remote Control	7	• Setting the Remote-Controllable Input	24
Preparations	8	• Setting the High-Definition Signal Types	24
• Checking the Accessories	8	• Setting the Speed of the Internal Cooling Fan ..	25
• Installing the Batteries	8	• Adjusting the White Balance	25
• About the Supplied Ferrite Core	8	• Setting the Clock and the Power On/Off	
Installation	9	Timer	26
• Precautions	9	• Using the Pixel Shift Function	28
Connections	10	• Using the Power Save Function	28
• Precautions	10	• Preventing the Afterimage Effect	28
• Available Signals	10	• Refreshing the Screen	29
• Connection Diagrams	11	• Resetting All the Setup Menu Settings	30
• Connecting an External Control Unit	12	• Resetting All the Menu Settings	31
• External Speaker Connection	13	• Confirming the Use Time and Model Information ...	31
• Connecting the External Cooling Fan Unit	13	Menu Classifications	32
Basic Operations	14	• Main Menu	32
• Daily Operations	14	• Setup Menu	34
• Changing the Aspect Ratio	15	Troubleshooting	36
Video Adjustments	16	• Self-diagnostic Indication	37
• Adjusting the Picture Quality	16	Specifications	38
• Adjusting the Screen Size and Position	17		
• Adjusting the Color Temperature	19		
• Changing the Aspect Ratio	19		
• Setting the Receivable Signal Types	20		
• Setting the COMPONENT/RGB B Input	20		
• Changing the Resistance of the RGB B Input			
Terminals	21		
• Resetting the Function Selection Menu Settings	21		

Safety Precautions

EUROPE EMC STANDARD NOTICE

Warning: This is a class A product. In a domestic environment this product may cause radio interference in which case the user may be required to take adequate measure.

IMPORTANT INFORMATION

WARNING: TO REDUCE THE RISK OF FIRE AND ELECTRIC SHOCK, DO NOT EXPOSE THIS APPARATUS TO RAIN, MOISTURE, DRIPPING OR SPLASHING AND THAT NO OBJECTS FILLED WITH LIQUIDS, SUCH AS VASES, SHALL BE PLACED ON THE APPARATUS.

IMPORTANT SAFEGUARDS

Electrical energy can perform many useful functions. This unit has been engineered and manufactured to assure your personal safety. But **IMPROPER USE CAN RESULT IN POTENTIAL ELECTRICAL SHOCK OR FIRE HAZARD**. In order not to defeat the safeguards incorporated into this product, observe the following basic rules for its installation, use and service. Please read these "Important Safeguards" carefully before use.

- All the safety and operating instructions should be read before the product is operated.
 - The safety and operating instructions should be retained for future reference.
 - All warnings on the product and in the operating instructions should be adhered to.
 - All operating instructions should be followed.
 - Unplug this product from the wall outlet before cleaning. Do not use liquid cleaners or aerosol cleaners. Use a damp cloth for cleaning.
 - Use a vacuum cleaner to get rid of the dust around the intakes (all the openings) on the rear. If a vacuum is not available, use a cloth and wipe it off. Failure to do so will cause internal heat buildup and, therefore, cause damage to the product.
 - Do not use attachments not recommended by the product manufacturer as they may be hazardous.
 - Do not use this product near water. Do not use immediately after moving from a low temperature to high temperature, as this causes condensation, which may result in fire, electric shock, or other hazards.
 - Do not place this product on an unstable cart, stand, or table. The product may fall, causing serious injury to a child or adult, and serious damage to the product. The product should be mounted according to the manufacturer's instructions, and should use a mount recommended by the manufacturer.
 - When the product is used on a cart, care should be taken to avoid quick stops, excessive force, and uneven surfaces which may cause the product and cart to overturn, damaging equipment or causing possible injury to the operator.
 - Slots and openings in the cabinet are provided for ventilation. These ensure reliable operation of the product and protect it from overheating. These openings must not be blocked or covered. (The openings should never be blocked by placing the product on bed, sofa, rug, or similar surface. It should not be placed in a built-in installation such as a bookcase or rack unless proper ventilation is provided and the manufacturer's instructions have been adhered to.)
- For proper ventilation, separate the product from other equipment, which may prevent ventilation and keep distance more than 10 cm.
- This product should be operated only with the type of power source indicated on the label. If you are not sure of the type of power supply to your home, consult your product dealer or local power company.

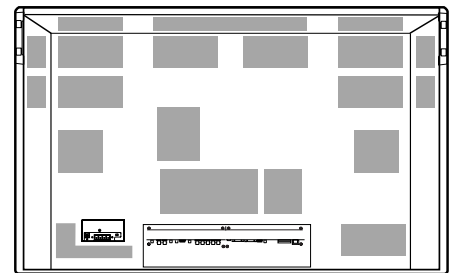

- For United Kingdom: This product is equipped with a three-wire plug. This plug will fit only into a grounded power outlet. If you are unable to insert the plug into the outlet, contact your electrician to install the proper outlet. Do not defeat the safety purpose of the grounded plug.
- Power-supply cords should be routed so that they are not likely to be walked on or pinched by items placed upon or against them. Pay particular attention to cords at doors, plugs, receptacles, and the point where they exit from the product.
- For added protection of this product during a lightning storm, or when it is left unattended and unused for long periods of time, unplug it from the wall outlet and disconnect the cable system. This will prevent damage to the product due to lightning and power line surges.
- Do not overload wall outlets, extension cords, or convenience receptacles on other equipment as this can result in a risk of fire or electric shock.
- Never push objects of any kind into this product through openings as they may touch dangerous voltage points or short out parts that could result in a fire or electric shock. Never spill liquid of any kind on the product.
- Do not attempt to service this product yourself as opening or removing covers may expose you to dangerous voltages and other hazards. Refer all service to qualified service personnel.
- Unplug this product from the wall outlet and refer service to qualified service personnel under the following conditions:
 - a) When the power supply cord or plug is damaged.
 - b) If liquid has been spilled, or objects have fallen on the product.
 - c) If the product has been exposed to rain or water.
 - d) If the product operated normally by following the operating instructions. Adjust only those controls that are covered by the Operation Manual, as an improper adjustment of controls may result in damage and will often require extensive work by a qualified technician to restore the product to normal operation.
 - e) If the product has been dropped or damaged in any way.
 - f) When the product exhibits a distinct change in performance – this indicates a need for service.
- When replacement parts are required, be sure the service technician has used replacement parts specified by the manufacturer or with same characteristics as the original part. Unauthorized substitutions may result in fire, electric shock, or other hazards.
- Upon completion of any service or repairs to this product, ask the service technician to perform safety checks to determine that the product is in proper operating condition.
- The product should be placed more than 30 cm away from heat sources such as radiators, heat registers, stoves, and other products (including amplifiers) that produce heat.
- When connecting other products such as VCR's, and personal computers, you should turn off the power of this product for protection against electric shock.
- Do not place combustibles behind the cooling fan. For example, cloth, paper, matches, aerosol cans or gas lighters that present special hazards when over heated.
- Use only the accessory cord designed for this product to prevent shock.
- ⚠ Option terminal: This terminal is intended exclusively to be used to drive the fan motor. Do not connect any plugs to the terminal other than JVC's recommended optional parts.

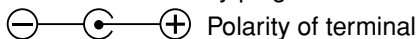

POWER CONNECTION

The power supply voltage rating of this product is AC 220 – 240 V. The power cords attached conform to the following power supply voltage and countries. Use only the power cord designated to ensure Safety and EMC regulations of each country.

Note for the United Kingdom power cord only

The plug on the United Kingdom power cord has a built-in fuse. When replacing the fuse, be sure to use only a correctly rated approved type, re-fit the fuse cover. (Consult your dealer or qualified service personnel.)

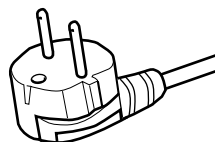

For European countries:
AC 220 – 240 V

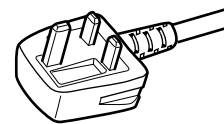

For United Kingdom:
AC 220 – 240 V

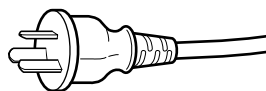

For Australia:
AC 220 – 240 V

How to replace the fuse
Open the fuse compartment with the blade screw driver, and replace the fuse.

Parts Identification

Monitor: Front View

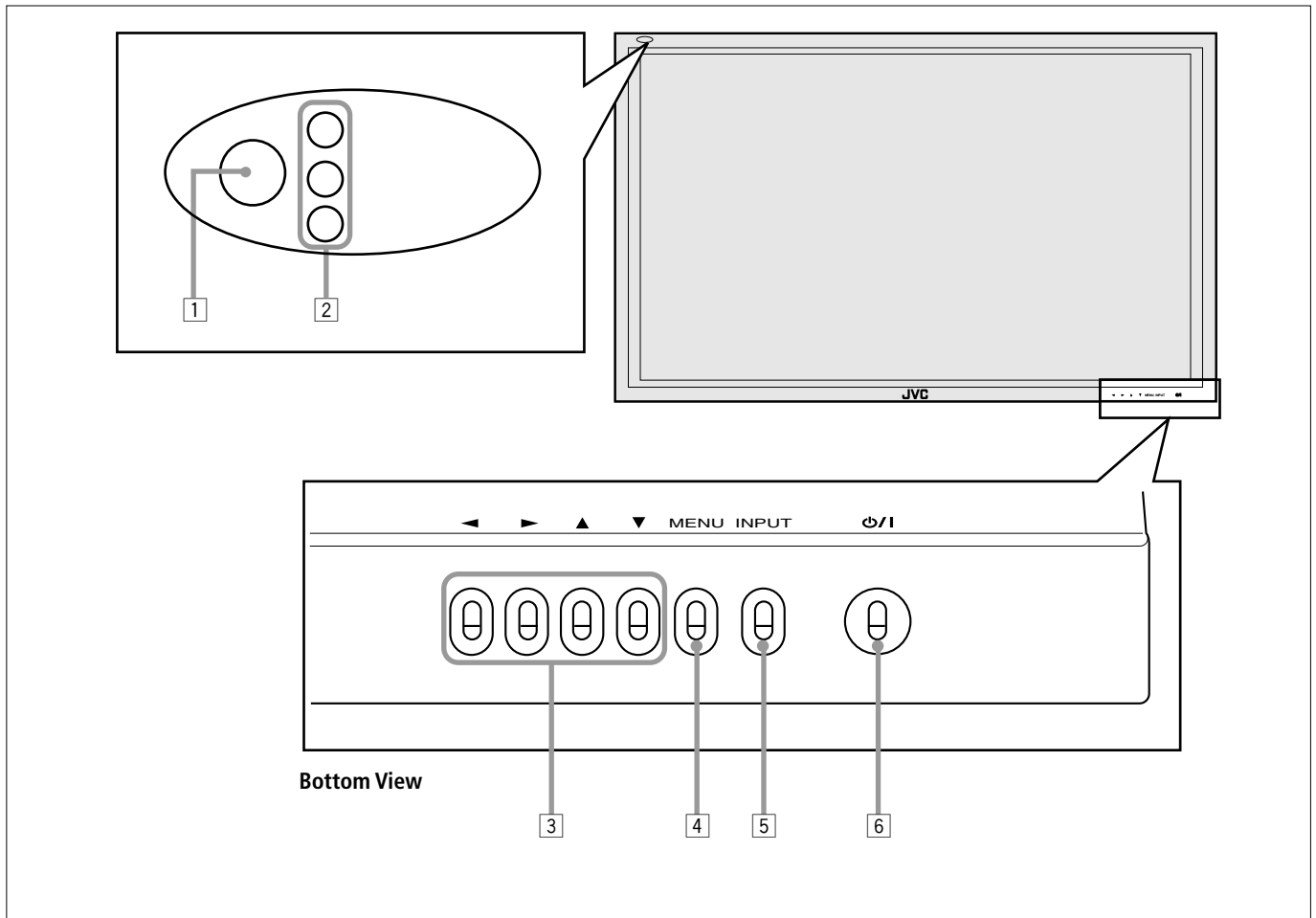

1 Remote sensor/power lamp

Point the front end of the wireless remote control toward here.
When the Monitor is turned on, the power lamp glows green. It glows orange in standby mode.

2 Self-diagnostic lamps (page 37)

These lamps light/flash if something abnormal occurs with the Monitor.

3 ◀ / ▶ / ▲ / ▼ buttons

Use these buttons to select menu items and to make adjustments.

- When no menu is displayed, you can use the ◀ / ▶ buttons to adjust the volume level.

4 MENU button

Use this button to display or erase menus.
While a sub-menu is displayed, pressing this button will move you one screen back to the preceding menu.

5 INPUT button (page 14)

Use this button to switch between inputs.
To select the COMPONENT or RGB B input, you have to set "COMPO./RGB B" correctly on the menu (see page 20).

6 ⏻/⏻ button (page 14)

Use this button to turn on and off (on standby) the Monitor when the POWER switch on the rear of the Monitor is "I (on)."

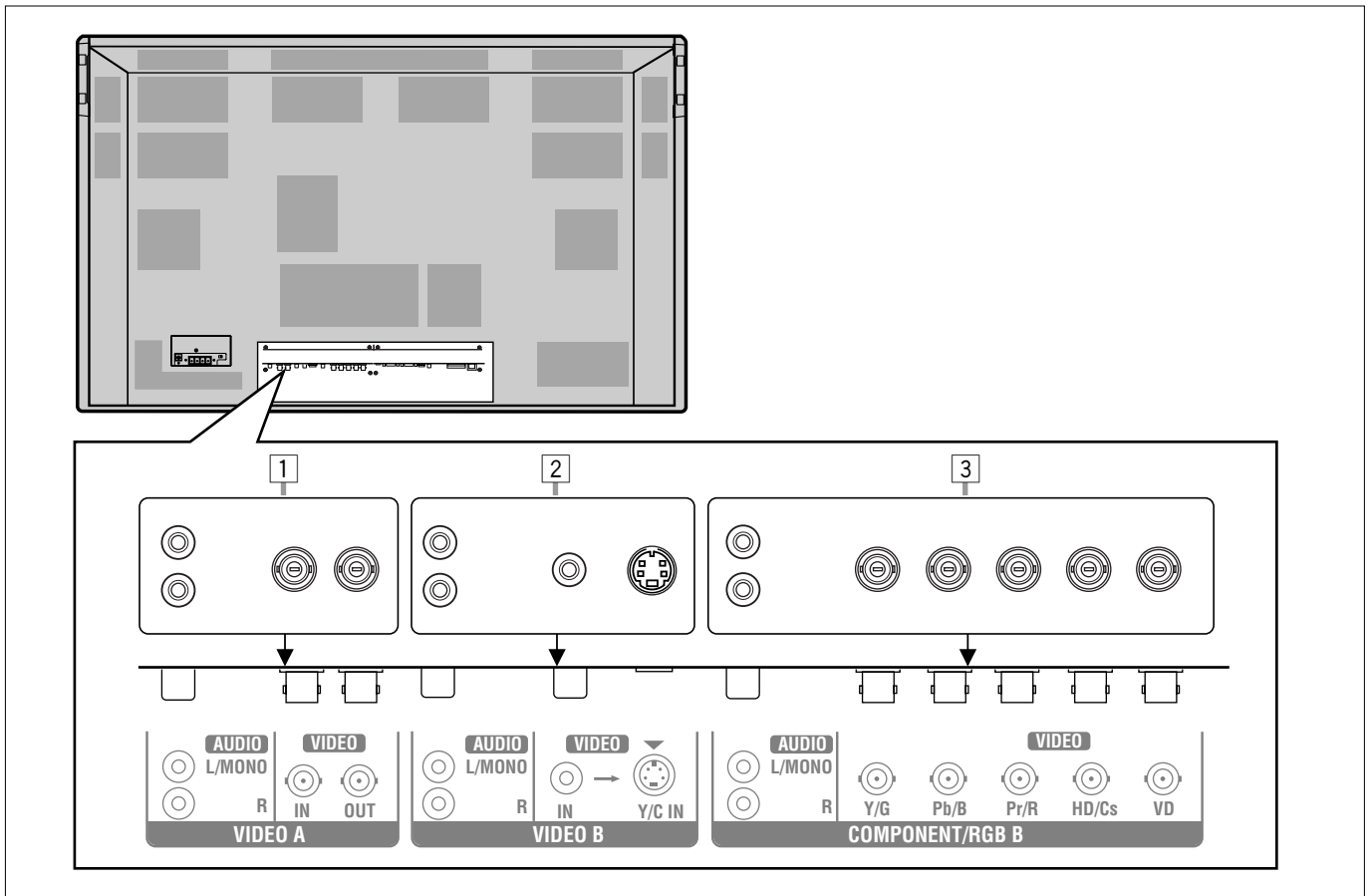
Monitor: Rear Views ①**① VIDEO A terminals (page 11)**

AUDIO (L/MONO, R) input terminals (pin jack)
Connect these terminals to the audio input terminals of a VCR, etc.

VIDEO IN terminal (BNC)
Connect this terminal to the video output terminal of a VCR, etc.

VIDEO OUT terminal (BNC)
Connect this terminal to the video input terminal of another monitor, etc.

Note:

- Since the video output terminals on this Monitor are loop-through terminals, the devices connected to this video output terminal should be correctly terminated. Otherwise, pictures become abnormally bright or the Monitor screen gets affected abnormally.

② VIDEO B terminals (page 11)

AUDIO (L/MONO, R) input terminals (pin jack)
Connect these terminals to the audio output terminals of a VCR, etc.

Y/C (S video) IN terminal (mini DIN, 4pin)
Connect this terminal to the S-video output terminal of a VCR, etc.

VIDEO IN terminal (pin jack)
Connect this terminal to the video output terminal of a VCR, etc.

Note:

- When both the video and S-video terminals are connected, the S-video terminal will have priority.

③ COMPONENT/RGB B input terminals (page 11)

AUDIO (L/MONO, R) input terminals (pin jack)
Connect these terminals to the audio output terminals of the other equipment.

G, B, R, HD/Cs, VD (VIDEO) input terminals (BNC)
Connect these terminals to the following output terminals of a personal computer or other equipment:

- Analog RGB signal output terminals
- Horizontal sync (HD) signal or composite (Cs) signal output terminal
- Vertical sync (VD) signal output terminal

Notes:

- External sync signals are automatically detected when they come in.
- When both horizontal (HD)/vertical (VD) sync and composite (Cs) sync are connected, HD/VD sync signals will be used.

Y, Pb, Pr (VIDEO) input terminals (BNC)

Connect these terminals to the component signal output terminals of NTSC or high-vision equipment.

Note:

- When these terminals are used as the component terminals (Y, Pb, Pr)—see “Setting the COMPONENT/RGB B Input” on page 20, external sync signals (HD/Cs, VD) cannot be used.

Parts Identification (Continued)

Monitor: Rear Views ②

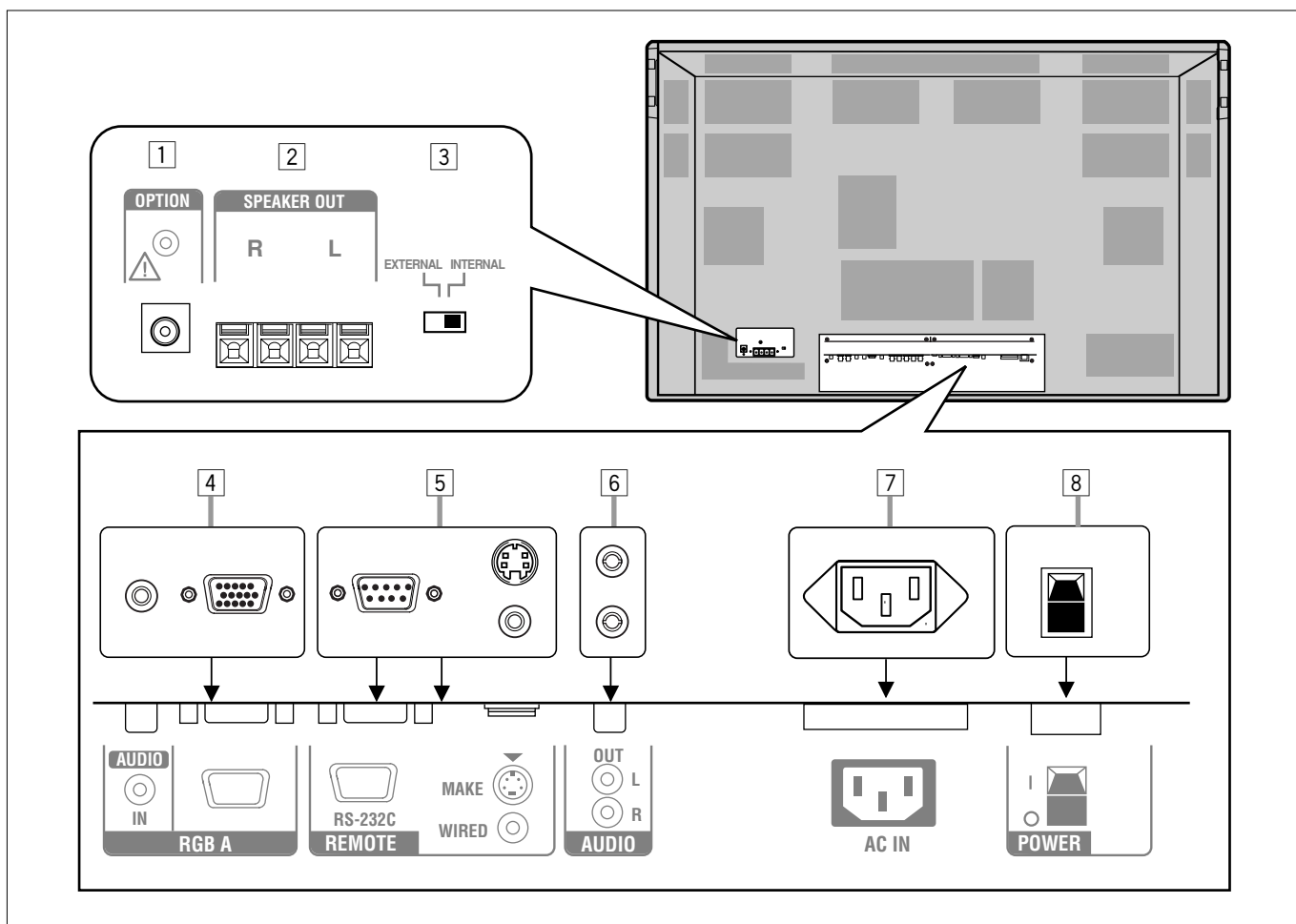

1 OPTION terminal (page 13)

Connect the power cord of the Cooling Fan Unit (not supplied) when installing the Monitor vertically.

2 SPEAKER OUT L/R terminals (page 13)

Connect external speakers, such as unique JVC speakers (not supplied), etc.

3 INTERNAL/EXTERNAL (built-in speaker/external speaker) selecting switch (page 13)

INTERNAL: To use built-in speakers.
EXTERNAL: To use external speakers.

4 RGB A input terminals (page 12)

Input terminal (D-sub, 15 pin)

Connect to the video output terminal of a personal computer.

Note:

- Use a cord as short as possible when connecting a personal computer to this terminal. (Recommended length is within 3 m.)

AUDIO IN terminal (stereo mini jack)

Connect to the audio output terminal of a personal computer.

5 REMOTE terminals (page 12)

RS-232C terminal (D-sub, 9 pin)

Connect to the RS-232C terminal of a personal computer. For the control method using this terminal, consult an authorized JVC dealer.

MAKE terminal (mini DIN, 4pin)

Connect an external control unit. (See page 12.)

WIRED terminal (stereo mini jack)

Connect a wired remote control unit to this terminal.

Note:

- When the above three terminals are used at the same time, transmitted commands through the MAKE terminal have priority over those through the other terminals.

6 AUDIO OUT terminals (pin jack) (page 12)

Connect to the audio input terminals of external equipment such as an amplifier.

7 AC IN terminal (page 12)

Connect the supplied power cord to this terminal.

8 POWER switch (page 14)

When this switch is set to "I (on)," you can turn on and off (on standby) the Monitor by using the POWER button on the remote control or the /I button on the Monitor.

Remote Control

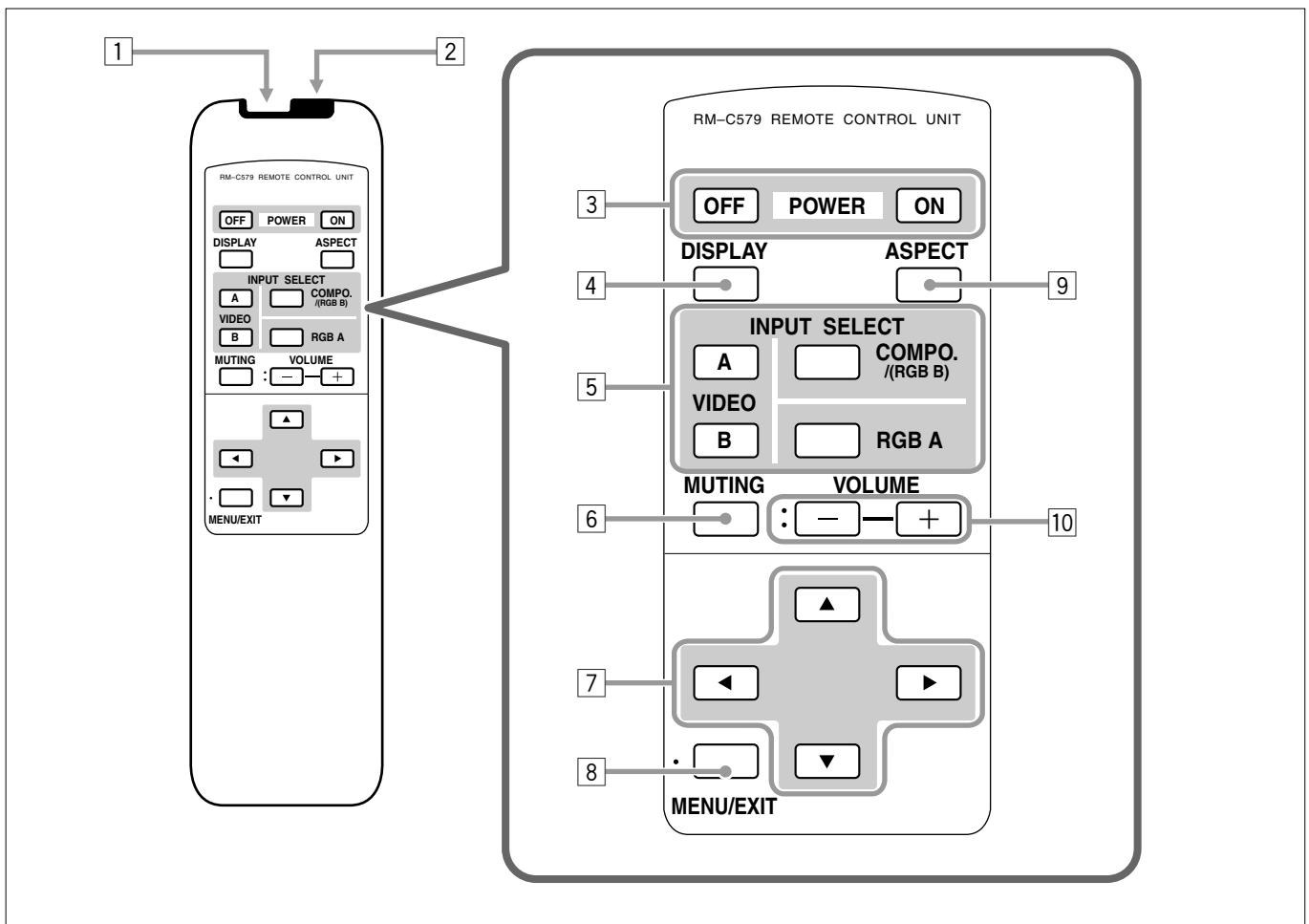

- 1 Remote control cable jack (page 12)**
Connect the remote control cable (not supplied) when using this remote control as a wired remote control.
- 2 Remote signal transmission window**
- 3 POWER ON/OFF button (page 14)**
Use this button to turn on and off (on standby) the Monitor when the POWER switch on the rear of the Monitor is "I (on)."
- 4 DISPLAY button (page 14)**
Use this button to display the input terminal, color system (for VIDEO A or VIDEO B input), scan system (for COMPONENT input) and horizontal/vertical frequency (for RGB A and RGB B input).
- 5 INPUT SELECT (VIDEO A, VIDEO B, COMPO./(RGB B) and RGB A) buttons (page 14)**
Use these buttons to switch between inputs.
To select the COMPONENT or RGB B input, you have to set "COMPO./RGB B" correctly on the menu (see page 20).
- 6 MUTING button (page 14)**
Use this button to turn off the volume immediately. Pressing the button again will resume the previous volume level.
- 7 ◀ / ▶ / ▲ / ▼ buttons**
Use these buttons to select menu items or make adjustments.
- 8 MENU/EXIT button**
Use this button to display or erase menus.
While a sub-menu is displayed, pressing this button will move you one screen back to the preceding menu.
- 9 ASPECT button (page 15)**
Use this button to switch between aspect ratios. Each time you press the button, the aspect ratio changes as follows:

```

      REGULAR  →  FULL  →
      ←  PANORAMIC ←  ZOOM ←
    
```
- 10 VOLUME + / - buttons (page 14)**
Use these buttons to adjust the volume level.

Preparations

Checking the Accessories

The following accessories are included with the Monitor. Check for them. If any item is missing, please contact the dealer where you purchased the Monitor.

- Remote control (RM-C579) x 1
- Power cord x 2 (3 for Australia) (Use the one matching the wall outlet.)
- Batteries (AA/R6P) x 2
- BNC-RCA conversion plug x 3 (For Australia)
- Ferrite core x 2

Installing the Batteries

Put the batteries in the remote control as follows. If the remote control has become erratic in operation, change the batteries.

1 Remove the back cover.

While pushing the release lever on the cover, remove the cover in the direction of the arrow.

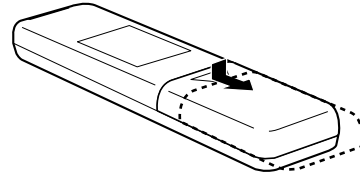

2 Place the batteries.

Put the two supplied batteries (AA/R6P), noting the ⊕ and ⊖ markings, as shown.

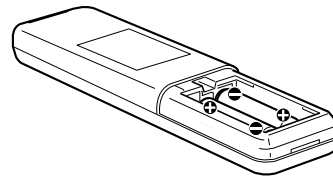

3 Replace the back cover as illustrated.

Make sure the release lever on the cover is locked in place correctly.

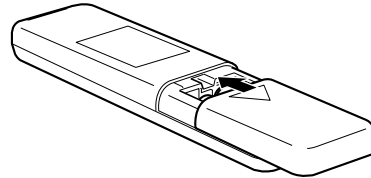

Precautions for using batteries

If batteries are used improperly, the liquid could leak out, causing a fire, injury, etc. or dirtying the vicinity.

Take notice of the following:

- Do not mix old and new batteries.
- Do not mix different types of battery as different types may have different characteristics.
- Place the batteries according to the ⊕ and ⊖ markings indicated on the battery compartment.
- When installing the batteries, insert the ⊖ end first to avoid a short circuit.
- Use only the specified batteries.
- When you are not using the remote control for a long time, remove the batteries.
- When the batteries have reached the end of their life, replace them with new ones immediately. Otherwise, the liquid may leak out, or malfunction may be caused by the leaked liquid. If the leaked liquid contacts your skin, wipe off the liquid with a soft cloth. If the affected skin is left as is, you may get a rough skin.
- Do not throw the batteries into fire or try recharging them.
- The service life of batteries is six months to one year for normal use. The supplied batteries are only for checking the operation and their life may be shorter. When the remote control operation becomes erratic, replace with new batteries.

The instruction below applies only to the use in Holland.

Gebruik batterijen:

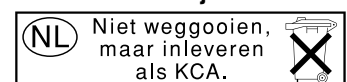

About the Supplied Ferrite Core

Be sure to attach the supplied ferrite cores to the speaker cords when using external speakers to reduce interference from the Monitor with external devices. See page 13.

Installation

Precautions

- **When installing the Monitor vertically, make sure the following:**
 - Attach the external cooling fan unit to the Monitor. (See “Connecting the External Cooling Fan Unit” on page 13.)
 - Set the speed of the internal cooling fan to “HIGH.” (See “Setting the Speed of the Internal Cooling Fan” on page 25.)
- When installing the Monitor, be sure to use a dedicated Stand Unit, Wall Mounting Unit, or Monitor Hanger Unit, depending on a particular case. Ask your dealer for installation.
- When installing the Monitor in a special way (for example, installing it diagonally), consult your dealer.
- Route the power cord and connection cables along wall or floor corners to avoid walking on them.
- For good heat dissipation, try to leave the following distances of space (minimum) around the Monitor.
- The ambient temperature of the installation place should be within the range of 0°C to 40°C (slightly variable depending on ambient conditions for installation.)
- When installing the Monitor in a place, such as near the ceiling, the remote control may not work correctly because of possible effects from the surroundings. If this happens, use the remote control as a wired remote control or move the Monitor where it is free from these effects.

When installing the Monitor on a stand

Front View

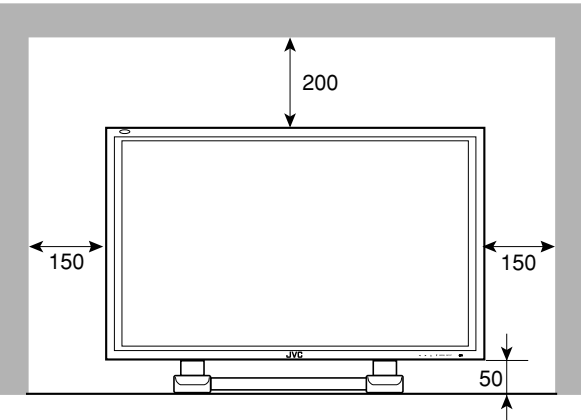

Unit: mm

Side View

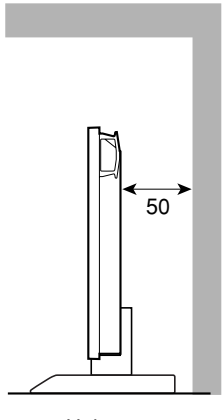

Unit: mm

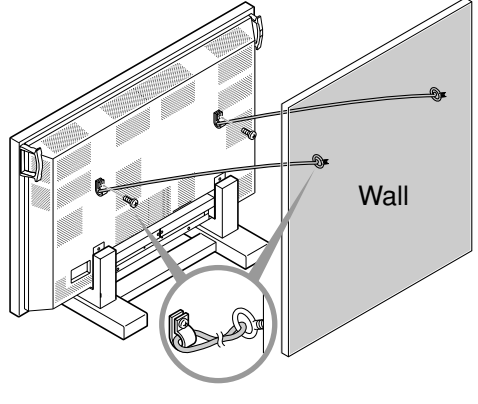

Wall

Take measures against the Monitor from overturning:
To protect against abnormal events such as earthquakes and to prevent unexpected accidents, take appropriate measures for preventing the Monitor from overturning; should it overturn, this could lead to personal injury.
For detailed information, refer to the manual supplied for the stand.

When mounting the Monitor on the wall

Front View

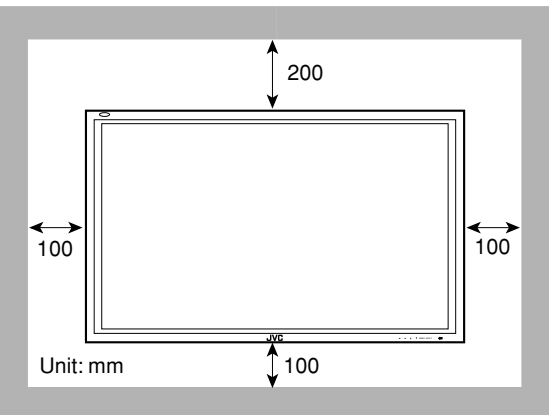

Unit: mm

Side View

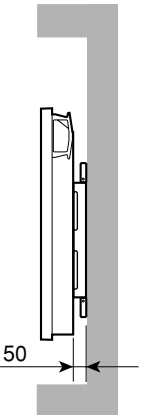

Unit: mm

When hanging the Monitor from the ceiling

Side View

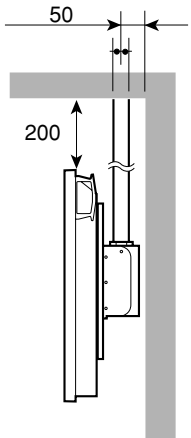

Unit: mm

Notes:

- Do not allow the same image (pattern) to be continuously displayed on the screen for a long time; otherwise, the area on the screen corresponding to the image may vary in brightness, leaving an afterimage on the screen. To reduce the afterimage, you can use the Color Reverse function and the Refresh function (see pages 28 and 29).
- The Monitor is manufactured using very high-precision technology, allowing for more than 99.99% active pixels, however, be aware that only a slight number of pixels may be deficient or lit at all times.
- Do not install the Monitor in such a way that the Monitor and other AV equipment affect each other adversely. (For example, if a disturbed image or noise due to electromagnetic interference occurs, or if the infrared remote control malfunctions, change the installation place.)

Connections

Precautions

- Before making connections, turn off all the equipment.
- Use a cord whose plugs are correctly matching for the terminals on this Monitor and the equipment.
- Plugs should be firmly inserted; poor connection could cause noise.
- To unplug a cord, be sure to grasp its plug and pull it out.
- Connect the power cord after having finished all other connections.
- Refer also to the user manual of each piece of equipment.

Available Signals

Video signals

The following signals can be input to this Monitor:

- VIDEO A and VIDEO B terminals accept — PAL, PAL60, NTSC, NTSC 4.43, and SECAM signals.
- COMPONENT/RGB B terminals accept — 480i, 576i, 480p, 576p, 720/60p, 720/50p, 1080/60i (1035/60i), and 1080/50i signals. (You need to set "COMPO./RGB B" to "COMPO." on the menu (see page 20).

Computer signals (Preset)

This Monitor has 27 preset video modes for the most popular industrial standard, and the signals of the following image resolutions can be input to the RGB input terminals.

No.	Signal name	Screen resolution		Horizontal Frequency (kHz)	Vertical Frequency (Hz)	Scan system
		Horizontal	Vertical			
1	PC98	640	400	24.8	56.4	Non-interlace
2	VGA400-70	640	400	31.5	70.1	Non-interlace
3	VGA480-60	640	480	31.5	59.9	Non-interlace
4	WVGA-60	852	480	31.7	60.3	Non-interlace
5	VGA480-72	640	480	37.9	72.8	Non-interlace
6	VGA480-75	640	480	37.5	75.0	Non-interlace
7	SVGA-56	800	600	35.2	56.3	Non-interlace
8	SVGA-60	800	600	37.9	60.3	Non-interlace
9	SVGA-72	800	600	48.1	72.2	Non-interlace
10	SVGA-75	800	600	46.9	75.0	Non-interlace
11	XGA-60	1024	768	48.4	60.0	Non-interlace
12	WXGA-60	1366	768	48.4	60.0	Non-interlace
13	XGA-70	1024	768	56.5	70.1	Non-interlace
14	XGA-75	1024	768	60.0	75.0	Non-interlace
15	XGA-85	1024	768	68.7	85.0	Non-interlace
16	XGA+-75	1152	864	67.5	75.0	Non-interlace
17	SXGA-60	1280	1024	64.0	60.0	Non-interlace
18	SXGA-75	1280	1024	80.0	75.0	Non-interlace
19	UXGA-60	1600	1200	75.0	60.0	Non-interlace
20	UXGA-65	1600	1200	81.3	65.0	Non-interlace
21	UXGA-70	1600	1200	87.5	70.0	Non-interlace
22	MAC13"	640	480	35.0	66.7	Non-interlace
23	MAC16"	832	624	49.7	74.6	Non-interlace
24	MAC19"	1024	768	60.2	74.9	Non-interlace
25	MAC21"	1152	870	68.7	75.1	Non-interlace
26	RGB15K-60	—	—	15.7	59.9	Interlace
27	RGB15K-50	—	—	15.6	50.0	Interlace

Notes:

- When a signal other than listed above is input, a part of the screen may become void or an unnecessary picture may appear.
- Signals, though they are within the acceptable range of frequencies, may not be displayed normally, depending on the signal type.
- Depending on the connected equipment, the Monitor may not be compatible with composite sync (Cs) or G on sync signals.
- When a preset mode signal is input, the vertical frequency displayed on the screen will have an "*" shown at its right top position.
- When the No. 4 and No. 12 signals are input, change the aspect ratio to "FULL" with the ASPECT button (page 15) on the remote control or from the "FUNCTION SELECT" menu (see page 19).
- When No. 16 to No. 21 and No. 25 signals are input, thin lines may become obscure for their signal frequencies are higher than the screen resolution. Using the RGB A input terminals makes the lines clearer than using the RGB B input terminals.
- The adjustment of the screen size and position is the setting common to the No. 14 and No. 24 signals. If you use both signals by switching them, the adjustment of either signal may not be proper.

Connection Diagrams

AV connections

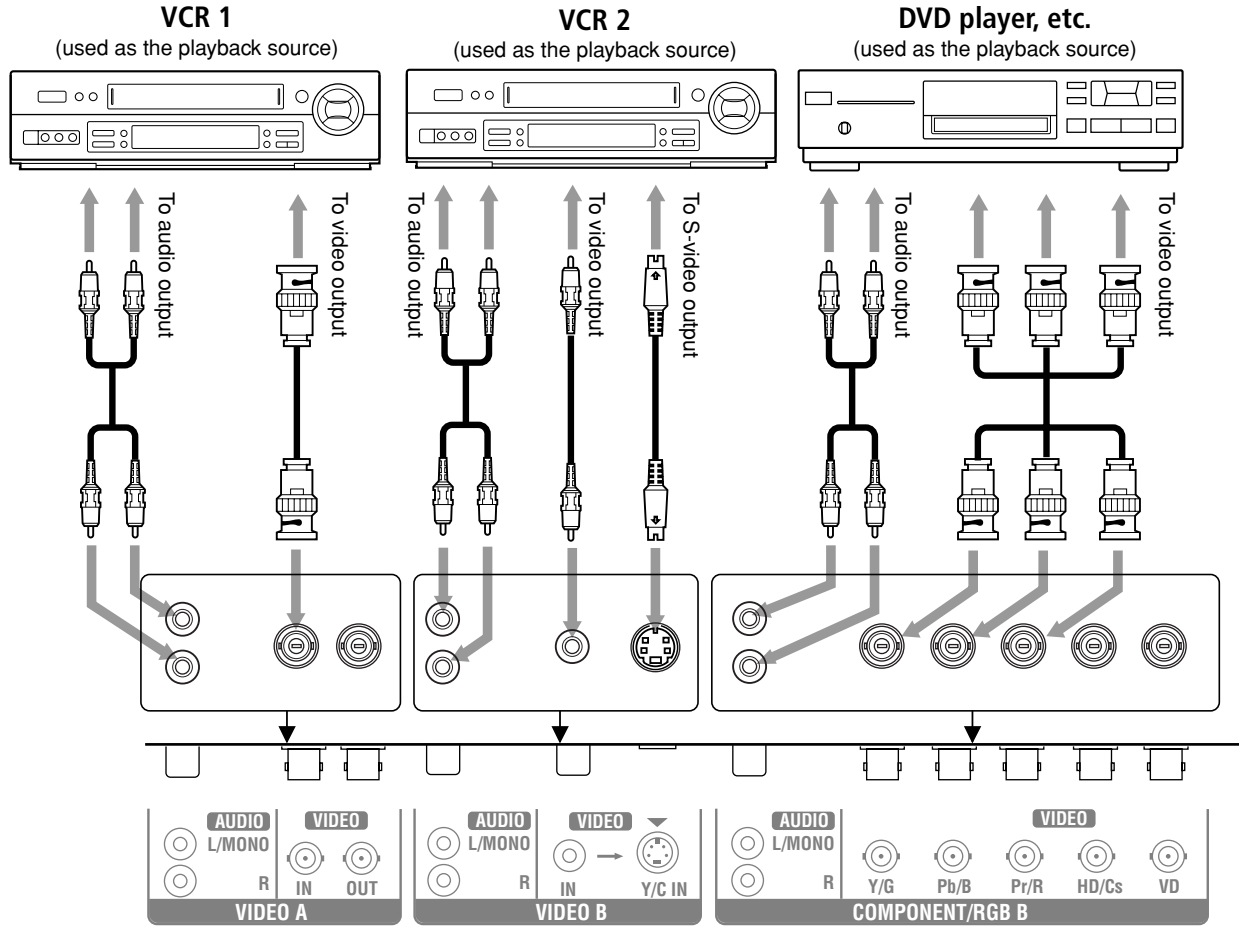

When connecting another PC to the COMPONENT/RGB B terminals, set the "COMPO./RGB B" setting to "RGB B" (see page 20).

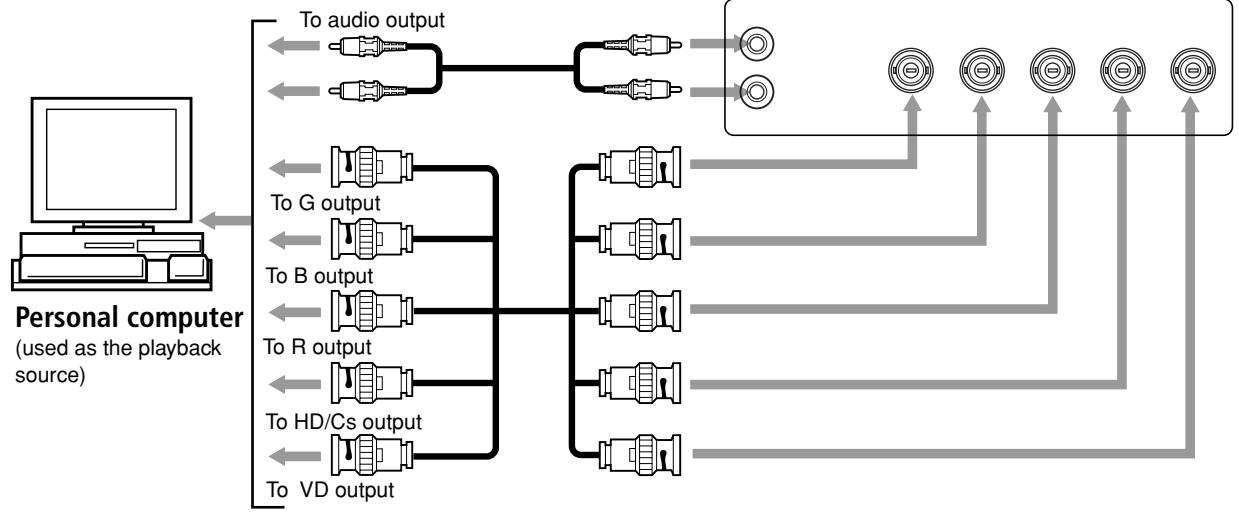

Notes:

- You can connect another VCR or Monitor to the VIDEO A OUT terminal. However, when connecting a VCR to the VIDEO A terminals, do not connect both IN and OUT terminals to the same VCR.
- When connecting a VCR to the VIDEO B terminals, you can use either the video or S-video terminals. If the both terminals are used, S-video terminal will have priority.

Connections (Continued)

Typical connections

Personal computer
(used as the playback source)

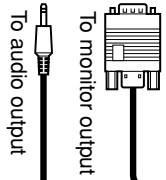
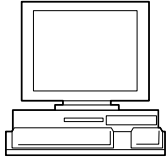

Personal computer
(used to control the Monitor)

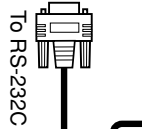
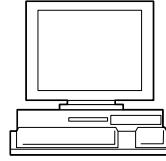

Remote control
(supplied)



* For connection, see "Connecting an External Control Unit" below.

Amplifier, etc.

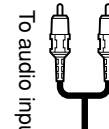
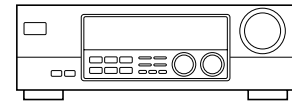

Power cord (supplied)
To a wall outlet

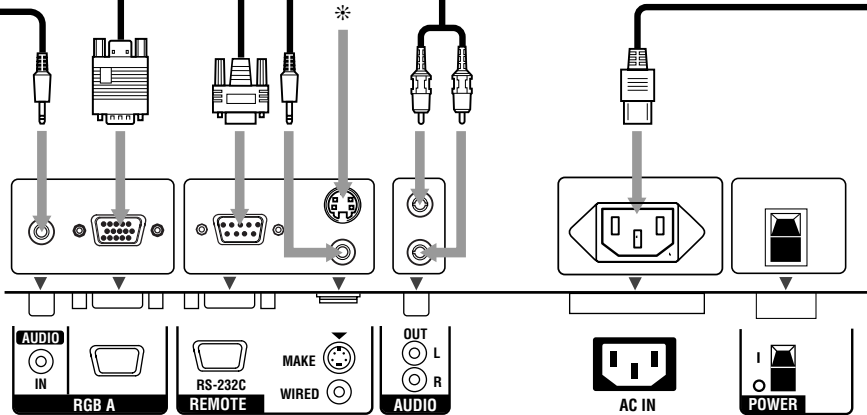

Connecting an External Control Unit

When connecting the external control unit to the MAKE terminal, you can operate the following functions through the MAKE terminal;

- Turn on or off the Monitor.
Preparation: The POWER switch on the rear must be set to "I (on)" (so that the Monitor is in standby mode).
- Select the input.
Preparation: "REMOTE SWITCH" should be set correctly to select your desired input (see page 24).

Notes:

- There is no remote control on/off switch. When a plug is inserted to the MAKE terminal, remote control through the external control unit is automatically activated.
- When the other REMOTE terminals are used at the same time, transmitted commands through the MAKE terminal have priority over those through the other terminals.

• MAKE terminal

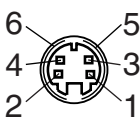

Pin number	Signal name
1	GND
2	GND
3	SW2
4	SW1
5	SW DET
6	GND

• External control unit

Signals transmitted

TTL level	
H: Power Off	L: Power On
H: Input A*	L: Input B*
H: Not connected	L: Connected

* Input A and Input B will be determined by the "REMOTE SWITCH" setting.

IMPORTANT:

External control unit is not commercially available in the market. When you need it, consult your dealer.

External Speaker Connection

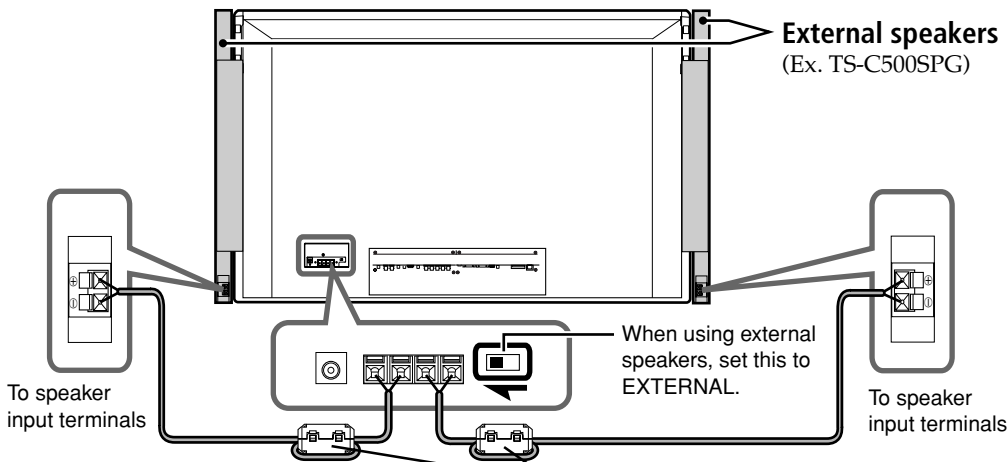

Note:

It is recommended to use the speaker unit—TS-C500SPG (not supplied) as the external speakers. You can also connect any speakers of the following specifications:

- Impedance: Between 6 Ω and 8 Ω
- Power handling capacity: More than 3 W

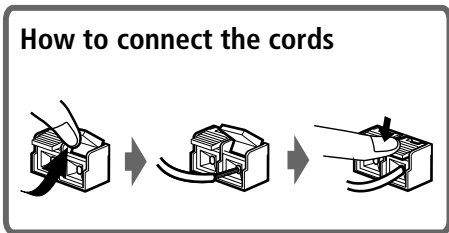

Ferrite core (supplied)

Attach the supplied ferrite cores to the speaker cords when using external speakers. Attach the ferrite cores as near to the SPEAKER OUT L/R terminals on the rear panel of the Monitor as possible.

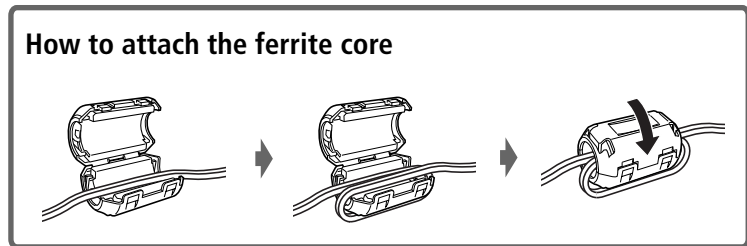

Caution:

- Do not short-circuit the ⊕ and ⊖ speaker cords each other. (Refer also to the instructions supplied with the speaker unit when connecting speakers.)

Connecting the External Cooling Fan Unit

When installing this Monitor vertically, it is required to attach the external cooling fan unit (not supplied).

Notes:

- When installing this Monitor vertically, it is also required to set the speed of the internal cooling fan to "HIGH" (see page 25).
- If you install the Monitor in such a way not instructed in this manual (for example, installing it diagonally), the cooling fan unit may not be able to cool down the internal heat enough to make the Monitor operate; therefore, reinstallation or another method for cooling will be required. Consult your dealer in such a case.
- For more detailed connection, refer to the manual supplied with the external cooling fan unit.

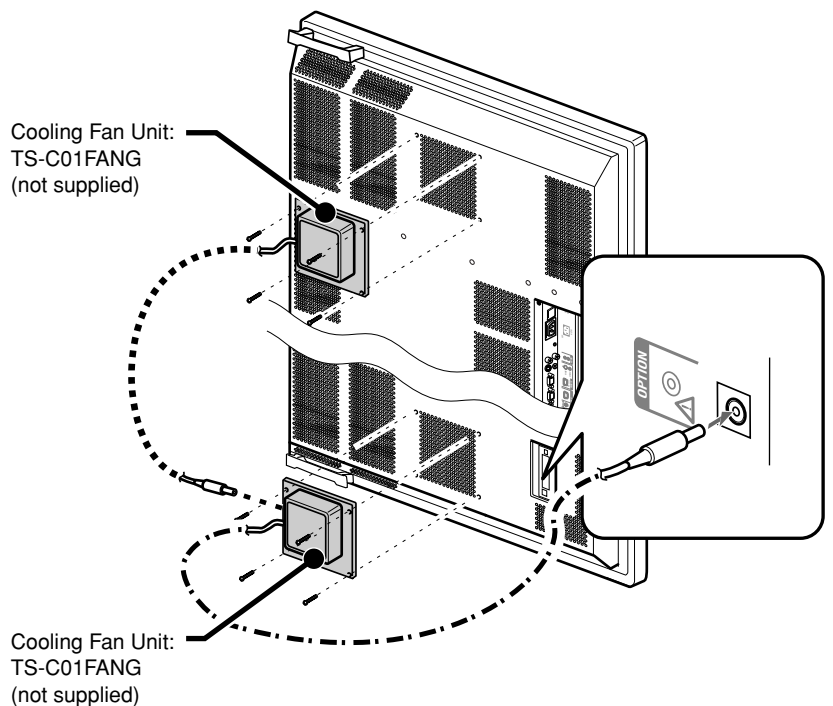

Basic Operations

Rear View

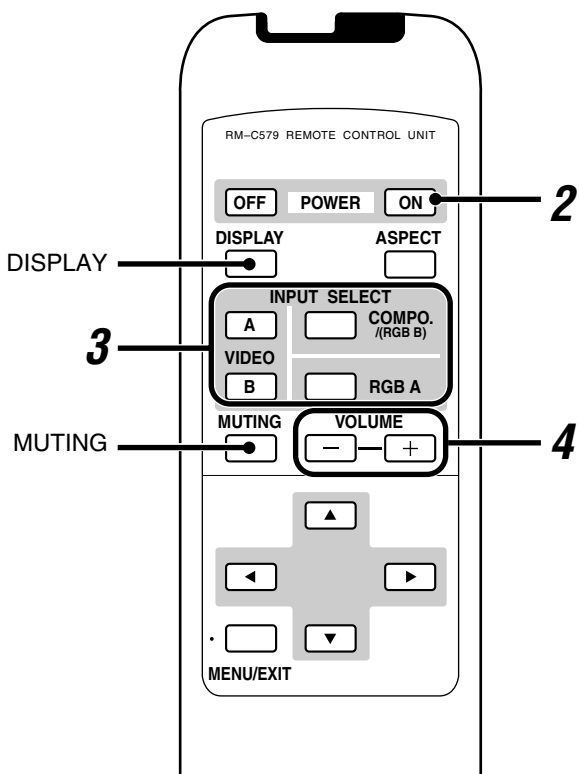
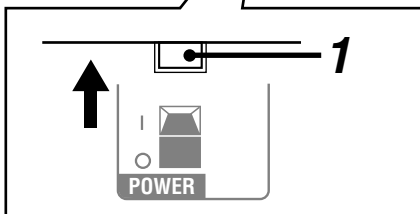
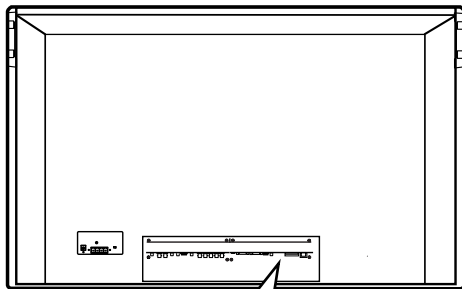

Daily Operations

1 Turn on the main power.

Set the POWER switch on the rear of the Monitor to "I (on)".

The power lamp on the upper left of the front panel lights orange.

- If you have turned off the Monitor not by using POWER ON on the remote control (or \mathcal{O}/I on the front panel), but by using the POWER switch, setting the power switch to "I (on)" lights the power lamp green and turns the Monitor on.

2 Turn on the power.

Press POWER ON on the remote control to turn the power on.

The power lamp lights green.

- You can also use \mathcal{O}/I on the front panel (lower right) to turn on the Monitor.

3 Select an input.

Select the desired input by pressing INPUT SELECT (VIDEO A, VIDEO B, COMPO./ (RGB B) and RGB A).

- You can also select the input by pressing INPUT on the Monitor. Each time you press the button, the input mode changes in sequence.



Ex. When selecting "VIDEO A" input

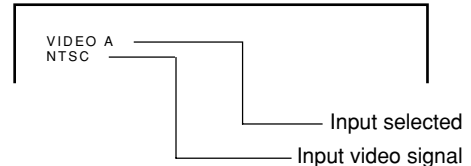

Note:

- To select "COMPONENT" or "RGB B," you need to set the "COMPO./RGB B" setting correctly.

4 Adjust the volume.

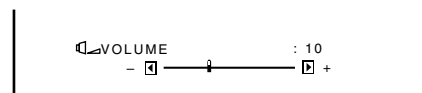

Note:

- While no menu is displayed, you can adjust the volume by pressing \blacktriangleleft / \blacktriangleright on the Monitor.

To turn off the volume immediately

Press MUTING.

"MUTING ON" is displayed, and the sound goes out.

Pressing the button again resumes the previous volume level.

To make the screen indication appear

Press DISPLAY.

The types of input and signal are indicated on the screen for about 3 seconds.

You can also make the screen indication appear using menus (page 22).

Changing the Aspect Ratio

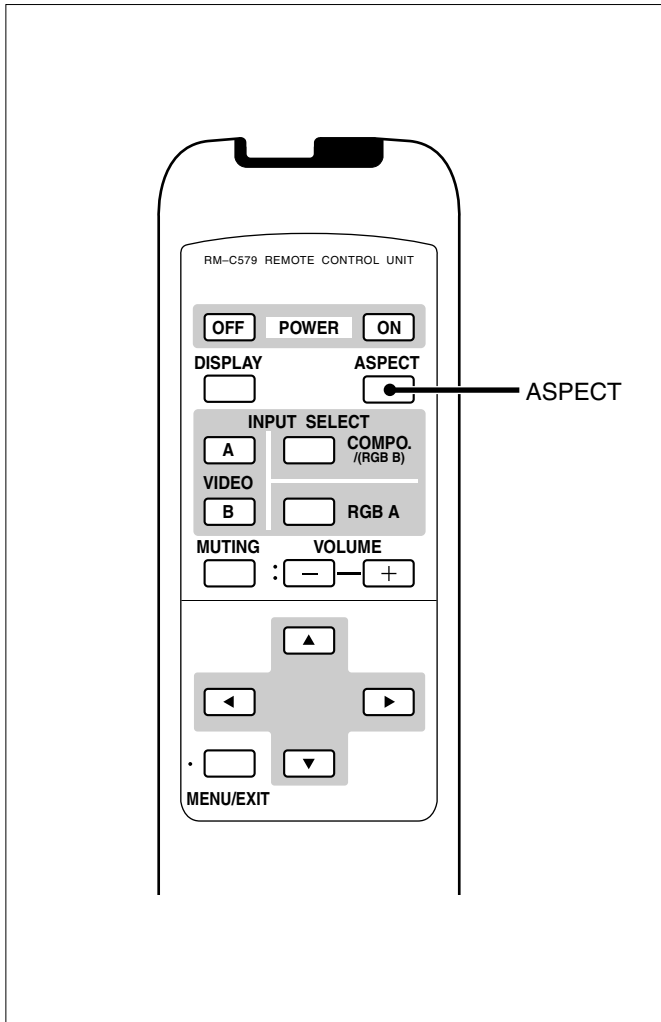

With this Monitor, you can select among three types of wide screens (FULL, ZOOM, and PANORAMIC) in addition to the REGULAR screen of conventional 4:3 aspect ratio.

Press ASPECT to select the screen size.

Each time you press the button, the screen size changes as follows:

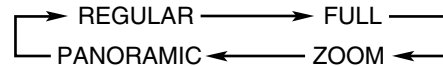

REGULAR: Displays at conventional 4:3 aspect ratio.

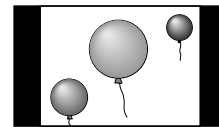

FULL: REGULAR size display is enlarged horizontally.

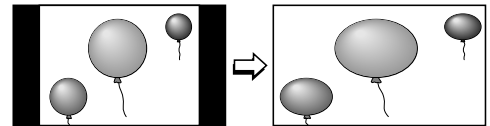

ZOOM: REGULAR size display is enlarged vertically and horizontally at the same ratio.

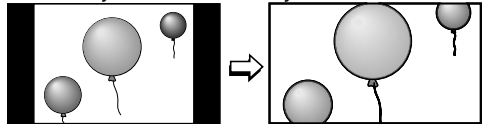

PANORAMIC: REGULAR size display is enlarged horizontally to the extent that the picture does not look abnormally.

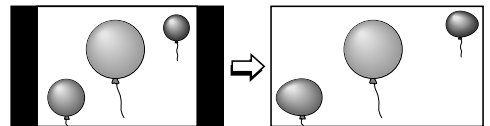

Precautions for using the screen mode switching function

- This Monitor features a screen mode switching (aspect ratio change) function. If you select a mode different in aspect ratio from software such as TV programs, the picture may look different from original picture. Be aware of this point when you are selecting a screen mode.
- If you select a wide screen mode while viewing conventional video programs of the aspect ratio 4:3, some portions (edges) of the original picture will be cut off, or deformed. To enjoy the original picture as it is, select "REGULAR" while viewing such programs.
- If you place the Monitor in a tea room, hotel, etc. for business purposes or public viewing and modify the picture by using the screen mode switching (aspect ratio change) function, this could violate the copyright protected by the copyright law, which requires your special attention.
- If you make the screen very bright and watch programs selecting "REGULAR," for a long period of time, the Monitor screen may happen to be burned in. If this occurs, watching programs using a wide screen mode for a while will reduce the burn-in gradually.

Notes:

- When one of the following signals is being input, you cannot select the aspect ratio you want.
 - 720/60p, 720/50p, 1080/60i (1035/60i), or 1080/50i signal through the COMPONENT/RGB B input terminals
You can only select FULL.
 - When any signal other than RGB15K-60 and RGB15K-50 through the RGB A or COMPONENT/RGB B input terminals
You can select only REGULAR and FULL.
- The aspect ratio can also be changed on the "FUNCTION SELECT" Menu (see page 19).

Video Adjustments

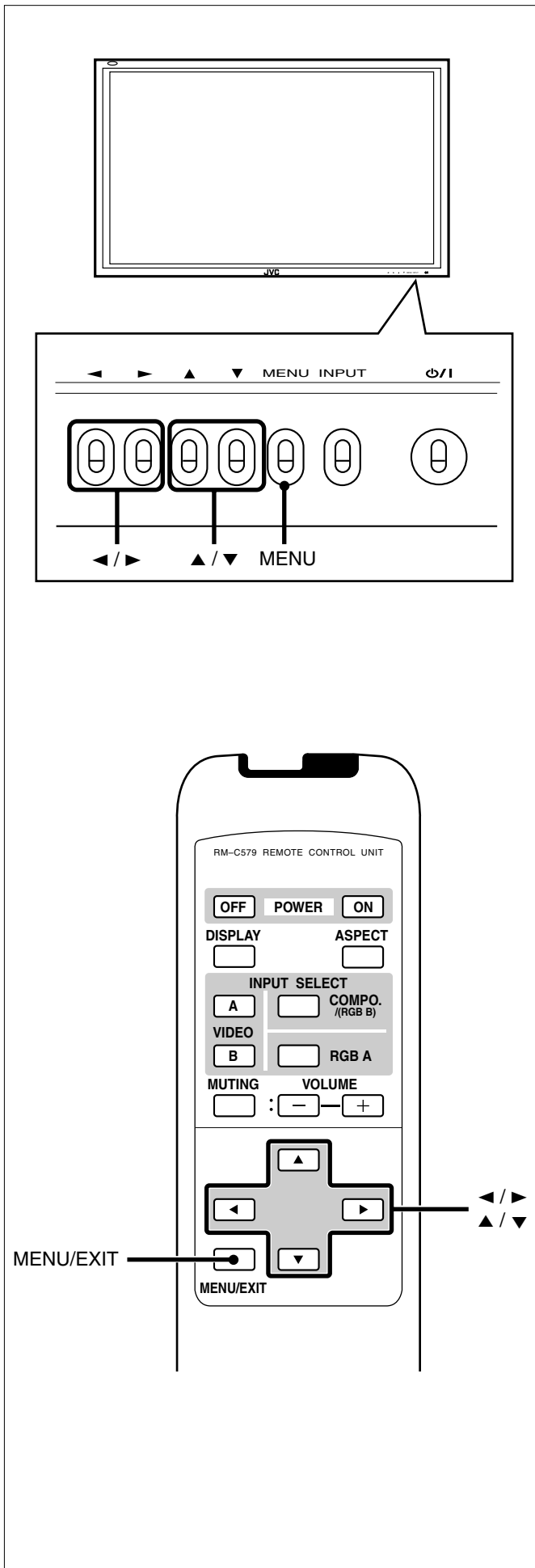

Adjusting the Picture Quality

Picture quality can be set for each input mode.

- 1 Press **MENU/EXIT** (or **MENU** on the Monitor) to display the Main Menu.

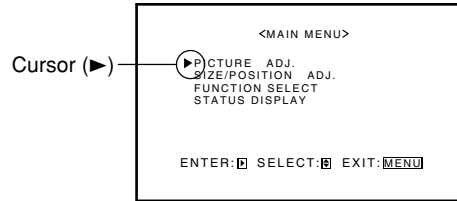

- 2 Press **▲/▼** to move the cursor (▶) to "PICTURE ADJ."

- 3 Press **▶** to display the Picture Adjustment Menu.

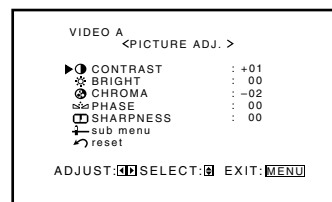

- 4 Press **▲/▼** to move the cursor (▶) to the item you want to adjust.

Item	Adjustment range	Standard (Reset)
CONTRAST	-20 to +20	+10
BRIGHT (brightness)	-20 to +20	00
CHROMA ^{*1}	-20 to +20	00
PHASE ^{*2}	-20 to +20	00
SHARPNESS	-10 to +10	00
sub menu	See "To make an adjustment while viewing the adjustment bar" on the next page.	
reset	See "To reset the adjustments" on the next page.	

^{*1} Adjustable when viewing the NTSC, PAL, or SECAM signal, or component signal.

^{*2} Adjustable when viewing the NTSC signal or component signal.

- 5 Press **◀/▶** to make adjustments.

- 6 Press **MENU/EXIT** (or **MENU** on the Monitor) twice to exit from the menu operations.

To make an adjustment while viewing the adjustment bar

After step 3 on page 16, proceed as follows:

- 1 Press ▲/▼ to move the cursor (▶) to "sub menu."
- 2 Press ▶ to display the Sub Menu.
The Sub Menu for CONTRAST appears on the screen.

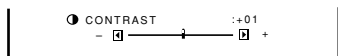

- 3 Press ▲/▼ to select the Sub Menu you want to adjust.
Each time you press the button, the Sub Menu changes as follows:

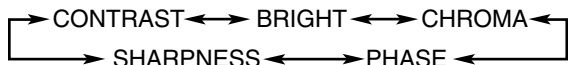

- 4 Press ◀/▶ to adjust the selected item.
- 5 Repeat steps 3 and 4 to adjust the other items.
- 6 Press MENU/EXIT (or MENU on the Monitor) three times to exit from the menu operations.

To reset the adjustments

After step 3 on page 16, proceed as follows:

- 1 Press ▲/▼ to move the cursor (▶) to "reset."
- 2 Press ▶.
The confirmation screen appears.

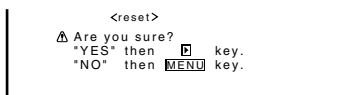

- 3 Press ▶ again to reset the adjustments.
To cancel the reset, press MENU/EXIT (or MENU on the Monitor).

Adjusting the Screen Size and Position

The screen size and position can be adjusted. Adjusted settings can be stored for each signal type; therefore, when the same signal comes in, the stored settings are recalled.

- When adjusting the size, the size cannot be adjusted proportionally, but can be enlarged rightward (or downward) only and reduced leftward (or upward) only. Therefore, it is necessary to adjust both the size and position alternately to adjust to the appropriate size.

1 Press MENU/EXIT (or MENU on the Monitor) to display the Main Menu.

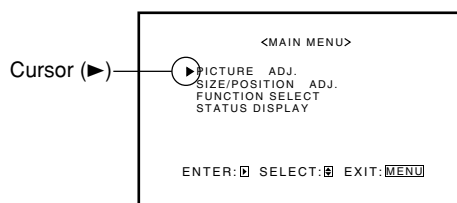

2 Press ▲/▼ to move the cursor (▶) to "SIZE/POSITION ADJ."

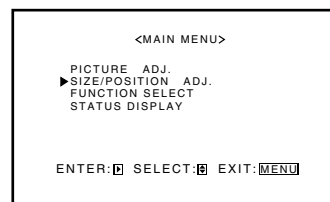

3 Press ▶ to display the Size/Position Adjustment Menu.

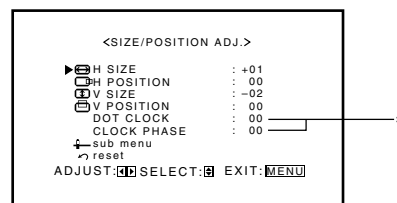

* Appearing and being adjustable only when you use RGB A or RGB B input.

(To be continued on the next page)

Video Adjustments (Continued)

4 Press ▲/▼ to move the cursor (▶) to the item you want to adjust.

Item	Adjustment range	
H (horizontal) SIZE*1	-40 to +40	
H POSITION*1	Varies depending on other settings	
V (vertical) SIZE*1	-40 to +40	
V POSITION*1	Varies depending on other settings	
	DOT CLOCK*2	-10 to +10
	CLOCK PHASE*2	-20 to +20
sub menu	See "To make an adjustment while viewing the adjustment bar" on the right column.	
reset	See "To reset the adjustments" on the right column.	

*1 Size and position adjustments are so related that if one is adjusted much, the other's adjustable range will be reduced.

*2 DOT CLOCK is the function to adjust the pixel sampling number of the A/D converter to the resolution (the vertical pixel number) of the input signal.

CLOCK PHASE is the function to adjust the sampling timing (phase) to the phase of the input signal. You can use the two functions to reduce flickering and blurring on the screen when using the RGB A or RGB B input.

5 Press ◀/▶ to adjust the selected item.

Note:

- During size and position adjustments, the Monitor screen may be distorted. This is normal, but not a malfunction of the Monitor.

6 Press MENU/EXIT (or MENU on the Monitor) twice to exit from the menu operations.

To make an adjustment while viewing the adjustment bar

After step 3 on page 17, proceed as follows:

1 Press ▲/▼ to move the cursor (▶) to "sub menu."

2 Press ▶ to display the Sub Menu.

The Sub Menu for H SIZE appears on the screen.

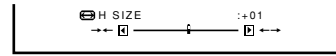

3 Press ▲/▼ to select the Sub Menu you want to adjust.

Each time you press the button, the Sub Menu changes as follows:

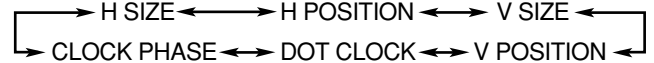

4 Press ◀/▶ to adjust the selected item.

5 Repeat steps 3 and 4 to adjust the other items.

6 Press MENU/EXIT (or MENU on the Monitor) three times to exit from the menu operations.

To reset the adjustments

After step 3 on page 17, proceed as follows:

1 Press ▲/▼ to move the cursor (▶) to "reset."

2 Press ▶.

The confirmation screen appears.

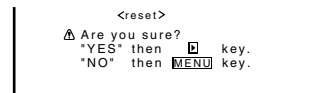

3 Press ▶ again to reset the adjustments.

To cancel the reset, press MENU/EXIT (or MENU on the Monitor).

Note:

- Adjustment values for both horizontal and vertical sizes of the screen are so related that if one is adjusted up to near the maximum value, the attainable value of the other will be decreased.

Adjusting the Color Temperature

The adjusted setting applies to all inputs.

- 1 Press **MENU/EXIT** (or **MENU** on the Monitor) to display the Main Menu.

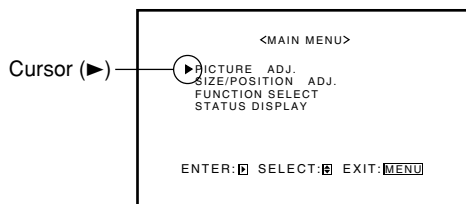

- 2 Press **▲/▼** to move the cursor (▶) to "FUNCTION SELECT."

- 3 Press **▶** to display the Function Selection Menu.

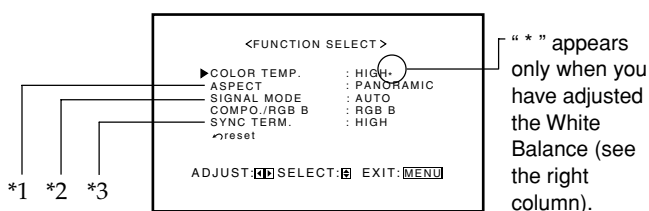

- *1 "ASPECT" does not appear when 720/60p, 720/50p, 1080/60i (1035/60i), or 1080/50i signal is being input through the COMPONENT/RGB B input terminals.
- *2 "SIGNAL MODE" appears only when VIDEO A, VIDEO B, or COMPONENT input is selected.
- *3 "SYNC TERM." appears only when the RGB B input is selected.

- 4 Press **▲/▼** to move the cursor (▶) to "COLOR TEMP."

- 5 Press **◀/▶** to make an adjustment.

Each time you press the button, the color temperature alternates between "HIGH" and "LOW."

- HIGH: To make the screen become bluish.
- LOW: To make the screen become reddish.

- 6 Press **MENU/EXIT** (or **MENU** on the Monitor) twice to exit from the menu operations.

Note:

- To make a fine adjustment, adjust "WHITE BALANCE" (see page 25).

Changing the Aspect Ratio

The setting adjusted applies to all inputs.

- You can change the aspect ratio by pressing ASPECT. (See page 15.)

- 1 Press **MENU/EXIT** (or **MENU** on the Monitor) to display the Main Menu.

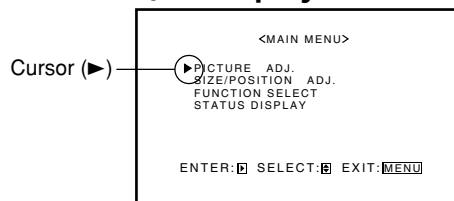

- 2 Press **▲/▼** to move the cursor (▶) to "FUNCTION SELECT."

- 3 Press **▶** to display the Function Selection Menu.

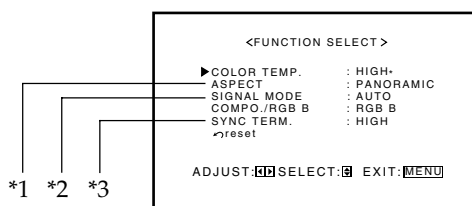

- *1 "ASPECT" does not appear when 720/60p, 720/50p, 1080/60i (1035/60i), or 1080/50i signal is being input through the COMPONENT/RGB B input terminals.
- *2 "SIGNAL MODE" appears only when VIDEO A, VIDEO B, or COMPONENT input is selected.
- *3 "SYNC TERM." appears only when the RGB B input is selected.

- 4 Press **▲/▼** to move the cursor (▶) to "ASPECT."

- 5 Press **◀/▶** to select an aspect ratio you want.

Each time you press the button, the aspect ratio changes as follows:

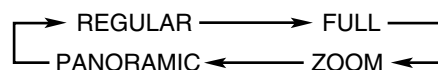

- * For detailed information on these aspect ratios, see page 15.

- 6 Press **MENU/EXIT** (or **MENU** on the Monitor) twice to exit from the menu operations.

Note:

- When one of the following signals is being input, you cannot select the aspect ratio you want.
 - 720/60p, 720/50p, 1080/60i (1035/60i), or 1080/50i signal through the COMPONENT/RGB B input terminals
Aspect ratio is fixed to FULL ("ASPECT" does not appear on the display).
 - When any signal other than RGB15K-60 and RGB15K-50 through the RGB A or COMPONENT/RGB B input terminals
You can select only REGULAR and FULL.

Video Adjustments (Continued)

Setting the Receivable Signal Types

You can set the receivable signal types. Normally, select "AUTO."

A common setting will apply to both the VIDEO A input and the VIDEO B input, and a different setting will apply to the COMPONENT input.

1 Press MENU/EXIT (or MENU on the Monitor) to display the Main Menu.

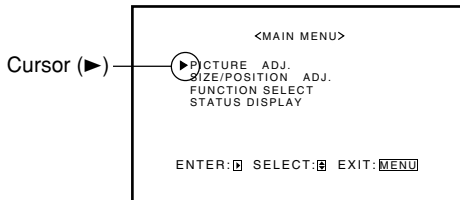

2 Press ▲/▼ to move the cursor (▶) to "FUNCTION SELECT."

3 Press ▶ to display the Function Selection Menu.

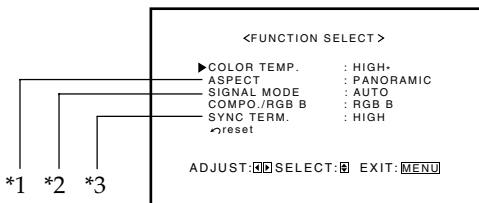

*1 *2 *3

*1 "ASPECT" does not appear when 720/60p, 720/50p, 1080/60i (1035/60i), or 1080/50i signal is being input through the COMPONENT/RGB B input terminals.

*2 "SIGNAL MODE" appears only when VIDEO A, VIDEO B, or COMPONENT input is selected.

*3 "SYNC TERM." appears only when the RGB B input is selected.

4 Press ▲/▼ to move the cursor (▶) to "SIGNAL MODE."

5 Press ◀/▶ to select the receivable video signal type.

Each time you press the button, the receivable video signal type changes as follows:

- When VIDEO A or VIDEO B input is selected:

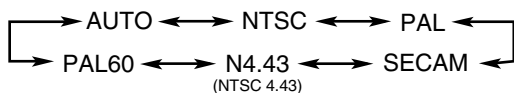

- When COMPONENT input is selected:

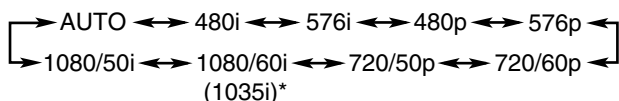

* Changes according to the "HD SIGNAL MODE" setting (see page 24).

6 Press MENU/EXIT (or MENU on the Monitor) twice to exit the menu operations.

Setting the COMPONENT/RGB B Input

After connecting the playback device such as a PC or a DVD player to the COMPONENT/RGB B terminals, you have to specify which type of signal comes into this terminal—RGB or component signals.

- Without setting "COMPO./RGB B" correctly, you cannot show any picture though you select the COMPONENT or RGB B input.

1 Press MENU/EXIT (or MENU on the Monitor) to display the Main Menu.

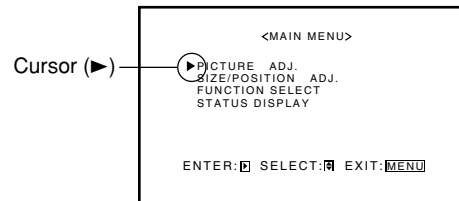

2 Press ▲/▼ to move the cursor (▶) to "FUNCTION SELECT."

3 Press ▶ to display the Function Selection Menu.

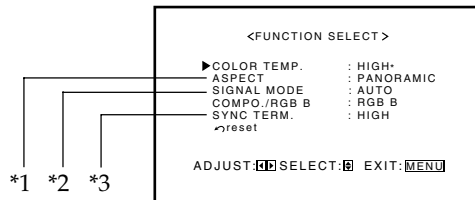

*1 *2 *3

*1 "ASPECT" does not appear when 720/60p, 720/50p, 1080/60i (1035/60i), or 1080/50i signal is being input through the COMPONENT/RGB B input terminals.

*2 "SIGNAL MODE" appears only when VIDEO A, VIDEO B, or COMPONENT input is selected.

*3 "SYNC TERM." appears only when the RGB B input is selected.

4 Press ▲/▼ to move the cursor (▶) to "COMPO./RGB B"

5 Press ◀/▶ to select the type of signal.

COMPO.: When connecting the playback device such as a DVD player, which can emit the component signals.

RGB B: When connecting the playback device such as a PC, which can emit the RGB signals.

The setting changes and the "FUNCTION SELECT" Menu disappears.

Changing the Resistance of the RGB B Input Terminals

You can set the resistance of the two of the RGB B input terminals to either HIGH (1 kΩ) or LOW (75 Ω):

- HD/Cs (Horizontal sync/Composite) terminal
- VD (Vertical sync) terminal.

HIGH is the normal setting. Change the setting to LOW when you use a long connecting cord and the picture flickers and blurs on the screen.

1 Press MENU/EXIT (or MENU on the Monitor) to display the Main Menu.

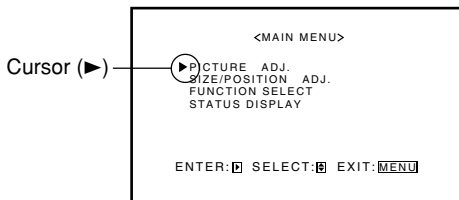

2 Press ▲/▼ to move the cursor (▶) to "FUNCTION SELECT."

3 Press ▶ to display the Function Selection Menu.

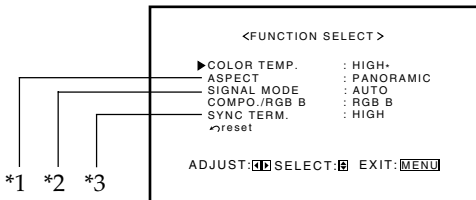

- *1 "ASPECT" does not appear when 720/60p, 720/50p, 1080/60i (1035/60i), or 1080/50i signal is being input through the COMPONENT/RGB B input terminals.
- *2 "SIGNAL MODE" appears only when VIDEO A, VIDEO B, or COMPONENT input is selected.
- *3 "SYNC TERM." appears only when the RGB B input is selected.

4 Press ▲/▼ to move the cursor (▶) to "SYNC TERM."

5 Press ◀/▶ to select the terminal resistance.

Each time you press the button, the resistance alternates between "HIGH" and "LOW."

HIGH: Initial setting. Normally select this.

LOW: When using a long connecting cord and the picture flickering and blurring on the screen.

6 Press MENU/EXIT (or MENU on the Monitor) twice to exit the menu operations.

Resetting the Function Selection Menu Settings

You can reset all the Function Selection Menu settings at a time.

1 Press MENU/EXIT (or MENU on the Monitor) to display the Main Menu.

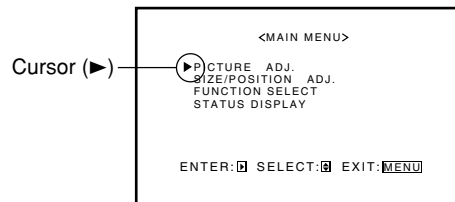

2 Press ▲/▼ to move the cursor (▶) to "FUNCTION SELECT."

3 Press ▶ to display the Function Selection Menu.

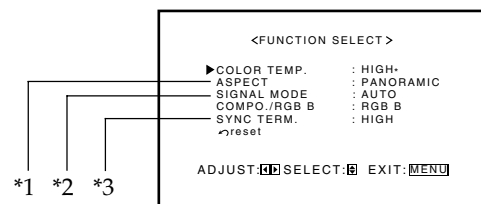

- *1 "ASPECT" does not appear when 720/60p, 720/50p, 1080/60i (1035/60i), or 1080/50i signal is being input through the COMPONENT/RGB B input terminals.
- *2 "SIGNAL MODE" appears only when VIDEO A, VIDEO B, or COMPONENT input is selected.
- *3 "SYNC TERM." appears only when the RGB B input is selected.

4 Press ▲/▼ to move the cursor (▶) to "reset."

5 Press ▶.

The confirmation screen appears.



6 Press ▶ again to reset the adjustments.

To cancel the reset, press MENU/EXIT (or MENU on the Monitor).

Other Convenient Functions

Showing On-screen Display

The input mode and signal type will be indicated on the screen.

- You can also show these information by pressing DISPLAY on the remote control. (See page 14.)

1 Press MENU/EXIT (or MENU on the Monitor) to display the Main Menu.

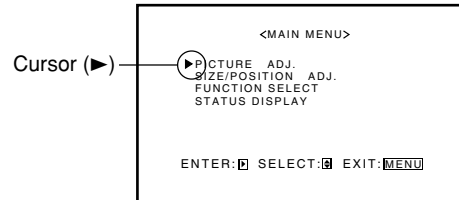

2 Press ▲/▼ to move the cursor (▶) to "STATUS DISPLAY."

3 Press ▶ to display the current input terminal and received signal type.

Ex. When selecting "VIDEO A" or "VIDEO B" input

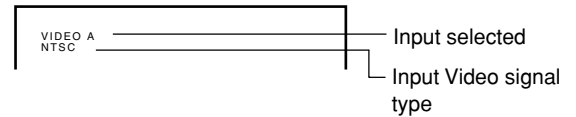

Ex. When selecting "COMPONENT" input

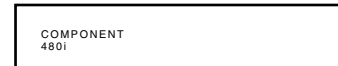

Ex. When selecting "RGB A" or "RGB B" input

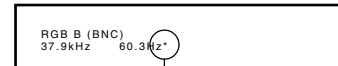

When the signal being input is a preset video mode, an "*" will be shown after the frequency.

Note:

- If you want to make these information appear automatically when you change the input mode, see "Showing the On-screen When Changing the Input Mode" on page 23.

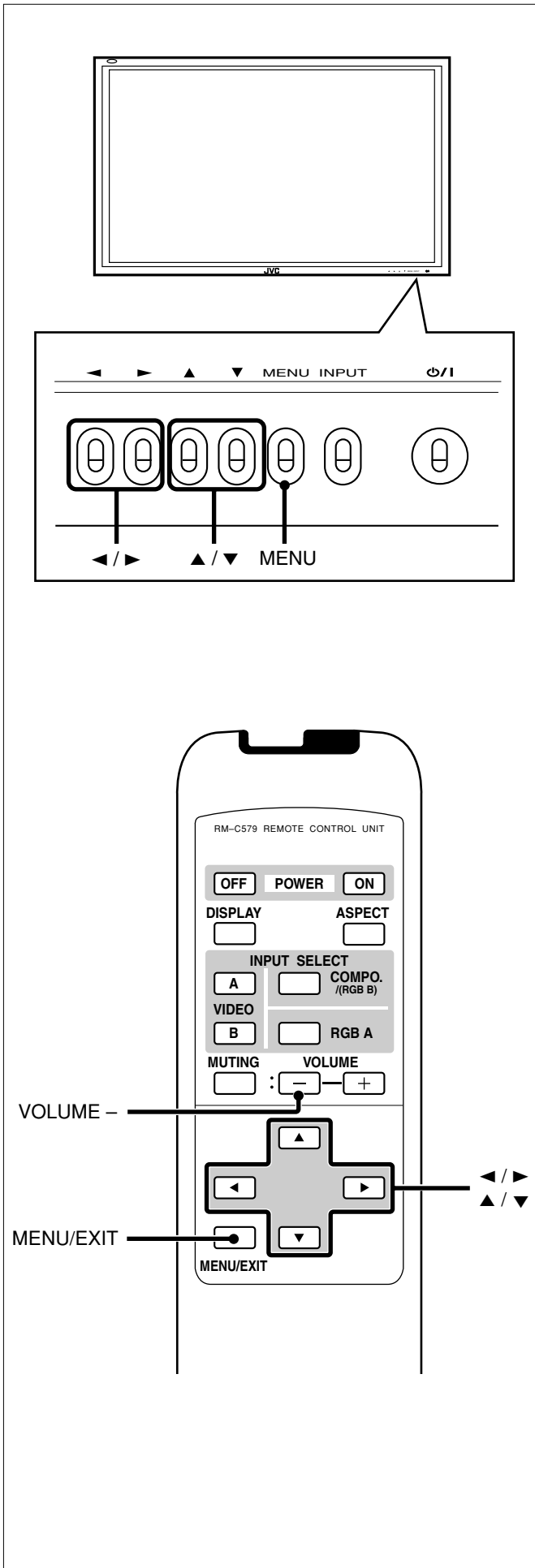

Showing the On-screen When Changing the Input Mode

With this function, you can see the selected input mode and signal type when changing the input mode.

- 1 On the remote control:**
Press **VOLUME** – while holding **MENU/EXIT** to display the Setup Menu.
On the Monitor:
Press **◀** while holding **MENU** to display the Setup Menu.

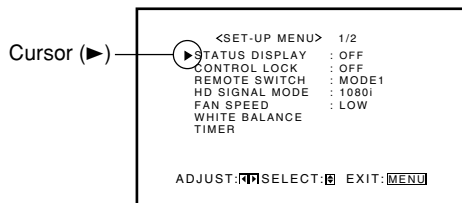

- 2 Press ▲/▼ to move the cursor (▶) to "STATUS DISPLAY."**
 - The Setup Menu consists of two pages. If you keep pressing ▲/▼, you can move to the other page from the current page.
- 3 Press ◀/▶ to select the desired setting.**
Each time you press the button, the Status Display function alternates between "ON" and "OFF."
To cancel the Status Display function, select "OFF."
- 4 Press MENU/EXIT (or MENU on the Monitor) once to exit from the menu operations.**

Prohibiting the Monitor's Button Operations

This function allows you to prohibit the button operations on the Monitor to prevent malfunction or avoid tampering.

- 1 On the remote control:**
Press **VOLUME** – while holding **MENU/EXIT** to display the Setup Menu.
On the Monitor:
Press **◀** while holding **MENU** to display the Setup Menu.

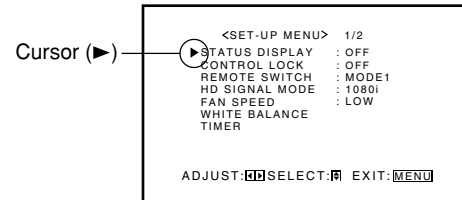

- 2 Press ▲/▼ to move the cursor (▶) to "CONTROL LOCK."**
 - The Setup Menu consists of two pages. If you keep pressing ▲/▼, you can move to the other page from the current page.
- 3 Press ◀/▶ to select the desired setting.**
Each time you press the button, the Control Lock function alternates between "ON" and "OFF."
To cancel the Control Lock function, select "OFF."
- 4 Press MENU/EXIT (or MENU on the Monitor) once to exit from the menu operations.**

Note:

- Even when the Control Lock function is in use, the following operations are possible:
 - Operation to cancel the Control Lock function
 - All operations from the remote control

Other Convenient Functions (Continued)

Setting the Remote-Controllable Input

When connecting the external control unit to the REMOTE MAKE terminal, you need to set the desired input to use, which you can select from the connected external control unit.

- 1 On the remote control:**
Press **VOLUME** – while holding **MENU/EXIT** to display the Setup Menu.

On the Monitor:
Press **◀** while holding **MENU** to display the Setup Menu.

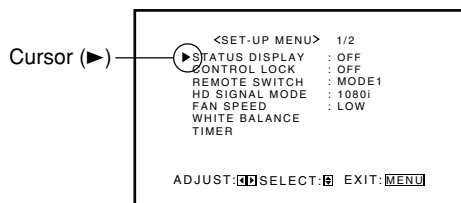

- 2 Press ▲/▼ to move the cursor (▶) to "REMOTE SWITCH."**

- The Setup Menu consists of two pages. If you keep pressing ▲/▼, you can move to the other page from the current page.

- 3 Press ◀/▶ to select the desired setting.**

Each time you press the button, the Remote Switch Mode changes as follows:

- MODE1: Input alternates between "VIDEO A" and "VIDEO B" when controlled from the external control unit.
- MODE2: Input alternates between "VIDEO A" and "COMPONENT/RGB B" when controlled from the external control unit.
- MODE3: Input alternates between "VIDEO A" and "RGB A" when controlled from the external control unit.
- MODE4: Input alternates between "VIDEO B" and "COMPONENT/RGB B" when controlled from the external control unit.
- MODE5: Input alternates between "VIDEO B" and "RGB A" when controlled from the external control unit.
- MODE6: Input alternates between "COMPONENT/RGB B" and "RGB A" when controlled from the external control unit.

- 4 Press MENU/EXIT (or MENU on the Monitor) once to exit from the menu operations.**

Setting the High-Definition Signal Types

You can select one of the High-Definition (HD) signal types through the COMPONENT/RGB B terminals — 1080i or 1035i. Normally set it to "1080i."

- Without setting "COMPO./RGB B" correctly, you cannot show any picture though you select the COMPONENT input (see page 20).

- 1 On the remote control:**
Press **VOLUME** – while holding **MENU/EXIT** to display the Setup Menu.

On the Monitor:
Press **◀** while holding **MENU** to display the Setup Menu.

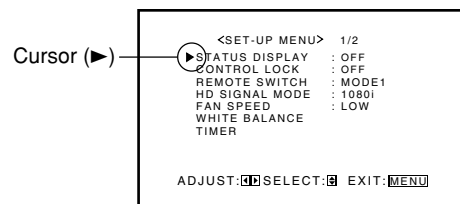

- 2 Press ▲/▼ to move the cursor (▶) to "HD SIGNAL MODE."**

- The Setup Menu consists of two pages. If you keep pressing ▲/▼, you can move to the other page from the current page.

- 3 Press ◀/▶ to select the desired setting.**

Each time you press the button, the HD signal type alternates between "1080i" and "1035i."

- You can select either "1080i" and "1035i" according to the HD signal you input — whichever gives you proportionally shaped pictures.

- 4 Press MENU/EXIT (or MENU on the Monitor) once to exit from the menu operations.**

Setting the Speed of the Internal Cooling Fan

Set the speed of the internal cooling fan to "HIGH" when installing the Monitor vertically, so that the internal heat of the Monitor is released more effectively.

Note:

- When installing this Monitor vertically, it is also required to attach the external cooling fan unit. (See page 13.)

- On the remote control:**
Press **VOLUME** – while holding **MENU/EXIT** to display the Setup Menu.

On the Monitor:

Press **◀** while holding **MENU** to display the Setup Menu.

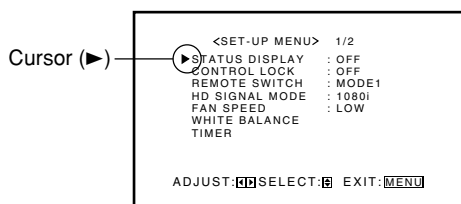

- Press **▲/▼** to move the cursor (▶) to "FAN SPEED."

- The Setup Menu consists of two pages. If you keep pressing **▲/▼**, you can move to the other page from the current page.

- Press **◀/▶** to select the desired setting.

Each time you press the button, the speed of the internal cooling fan changes as follows:

- LOW: Initial setting. Normally select this.
HIGH: Select this when installing the Monitor vertically.

- Press **MENU/EXIT** (or **MENU** on the Monitor) once to exit from the menu operations.

Adjusting the White Balance

G GAIN, B GAIN and R GAIN can be finely adjusted separately for "HIGH" and "LOW" settings of the color temperature.

- On the remote control:**
Press **VOLUME** – while holding **MENU/EXIT** to display the Setup Menu.

On the Monitor:

Press **◀** while holding **MENU** to display the Setup Menu.

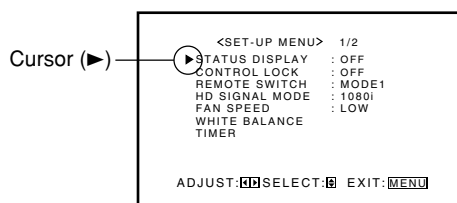

- Press **▲/▼** to move the cursor (▶) to "WHITE BALANCE."

- The Setup Menu consists of two pages. If you keep pressing **▲/▼**, you can move to the other page from the current page.

- Press **▶** to display the White Balance Adjustment Menu.

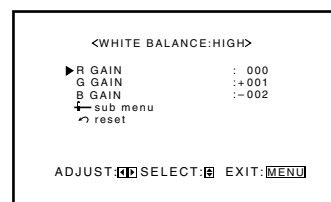

- Press **▲/▼** to move the cursor (▶) to the item you want to adjust.

- Press **◀/▶** to adjust the selected item.

- Repeat steps 4 and 5 to adjust the other items.

- Press **MENU/EXIT** (or **MENU** on the Monitor) twice to exit from the menu operations.

Notes:

- Adjustable range will vary among the Monitors.
- "MAX" may appear soon after you begin adjustment. This is normal but not a malfunction.

(To be continued on the next page)

Other Convenient Functions (Continued)

To make an adjustment while viewing the adjustment bars

After step 3 on page 25, proceed as follows:

- 1 Press ▲/▼ to move the cursor (▶) to "sub menu."
- 2 Press ▶ to display the Sub Menu.

The Sub Menu for R GAIN appears on the screen.

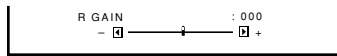

- 3 Press ▲/▼ to select the Sub Menu you want to adjust.
- Each time you press the button, the Sub Menu changes as follows:

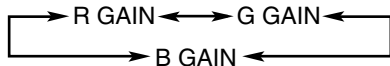

- 4 Press ◀/▶ to adjust the selected item.
- 5 Repeat steps 3 and 4 to adjust the other items.
- 6 Press MENU/EXIT (or MENU on the Monitor) three times to exit from the menu operations.

To reset the adjustments

After step 3 on page 25, proceed as follows:

- 1 Press ▲/▼ to move the cursor (▶) to "reset."
- 2 Press ▶.

The confirmation screen appears.

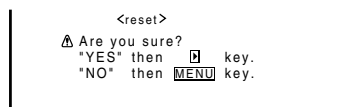

- 3 Press ▶ again to reset the adjustments.

To cancel the reset, press MENU/EXIT (or MENU on the Monitor).

Setting the Clock and the Power On/Off Timer

You can turn the Monitor on and off automatically with the Power On/Off timer.

- Since you cannot use the timer functions without setting the clock, set the clock at first.

• Setting the Clock

You can also adjust the clock with the following procedure.

- 1 **On the remote control:**
Press VOLUME – while holding MENU/EXIT to display the Setup Menu.
- On the Monitor:**
Press ◀ while holding MENU to display the Setup Menu.

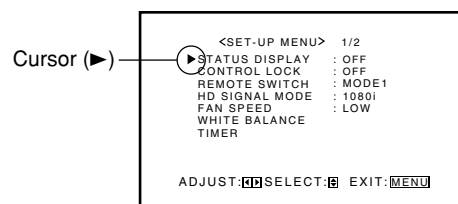

- 2 Press ▲/▼ to move the cursor (▶) to "TIMER," then press ▶ to display the Timer Menu.

- The Setup Menu consists of two pages. If you keep pressing ▲/▼, you can move to the other page from the current page.

Before the clock setting

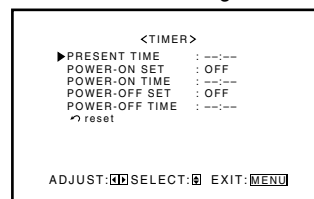

After the clock setting

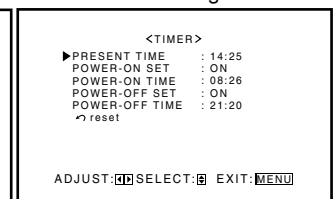

- 3 Press ▲/▼ to move the cursor (▶) to "PRESENT TIME," then press ▶.
- 4 Press ▲/▼ to move the cursor (▶) to "HOURS," then press ◀/▶ repeatedly to adjust the hour (24 hour clock).
- 5 Press ▲/▼ to move the cursor (▶) to "MINUTES," then press ◀/▶ repeatedly to adjust the minute.
- 6 Press MENU/EXIT (or MENU on the Monitor) three times to exit from the menu operations.

• Using the Power On/Off Timer

Select the item you want to set in step 3 in "Setting the Clock" (page 26) and follow the instructions below.

POWER-ON SET

You can activate/deactivate the Power-On Timer.

Press ◀/▶ to select "ON" or "OFF."

ON: The Monitor automatically turns on at the time set in "POWER-ON TIME."

OFF: The Power-On Timer is deactivated.

POWER-ON TIME

You can adjust the time to turn on the Monitor.

Set the hour and minute following steps 4 to 6 in "Setting the Clock" (page 26).

POWER-OFF SET

You can activate/deactivate the Power-Off Timer.

Press ◀/▶ to select "ON" or "OFF."

ON: The Monitor automatically turns off at the time set in "POWER-OFF TIME."

OFF: The Power-Off Timer is deactivated.

POWER-OFF TIME

You can adjust the time to turn off the Monitor.

Set the hour and minute following steps 4 to 6 in "Setting the Clock" (page 26).

To reset the timer setting

After step 2 on page 26, proceed as follows:

1 Press ▲/▼ to move the cursor (▶) to "reset."

2 Press ▶.

The confirmation screen appears.

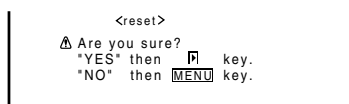

3 Press ▶ again to reset the setting.

To cancel the reset, press MENU/EXIT (or MENU on the Monitor).

About the Timer Battery

The timer clock works on the battery embedded in the Monitor.

If the battery becomes weak or has already run out, a message appears on the TIMER, COLOR-REVERSE, and REFRESH menus.

When the battery becomes weak (BATTERY LOW)

"BATTERY LOW" appears on the screen.

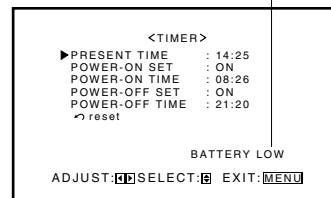

When the battery has run out (BATTERY EMPTY)

"BATTERY EMPTY" appears on the screen.

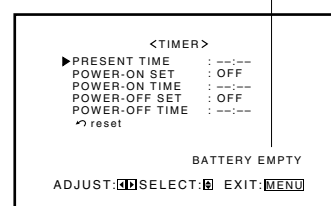

The clock is reset and "PRESENT TIME" is shown as "-- : --."

- You cannot replace the battery yourself. Please consult your dealer to replace it.
- Set the clock and the timer functions (Power On/Off Timer, Color-Reverse On/Off Timer, and Refresh On/Off Timer) again after replacing the battery.
- You can use functions other than the timer functions without replacing the battery.

Other Convenient Functions (Continued)

Using the Pixel Shift Function

This function periodically shift the position (pixels) of the displayed picture on the screen so that you can avoid the screen from being burned in.

- 1 On the remote control:**
Press **VOLUME** – while holding **MENU/EXIT** to display the Setup Menu.

On the Monitor:
Press **◀** while holding **MENU** to display the Setup Menu.

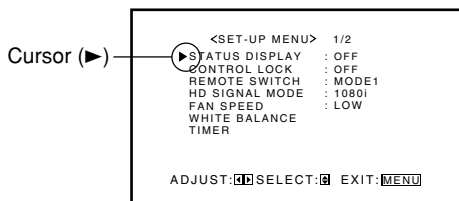

- 2 Press ▲/▼ to move the cursor (▶) to "PIXEL SHIFT" (on the second page).**
 - The Setup Menu consists of two pages. If you keep pressing ▲/▼, you can move to the other page from the current page.

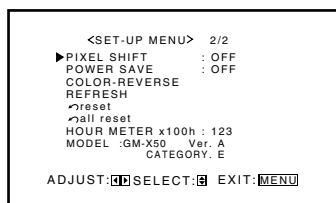

- 3 Press ◀/▶ to select the desired setting.**
Each time you press the button, the Pixel Shift function alternates between "ON" and "OFF."
To cancel the Pixel Shift function, select "OFF."
- 4 Press MENU/EXIT (or MENU on the Monitor) once to exit from the menu operations.**

Using the Power Save Function

You can use this function to reduce the electrical consumption and to extend the lifetime of the Monitor's screen.

- The brightness of the screen will be reduced.

- 1 On the remote control:**
Press **VOLUME** – while holding **MENU/EXIT** to display the Setup Menu.

On the Monitor:
Press **◀** while holding **MENU** to display the Setup Menu.

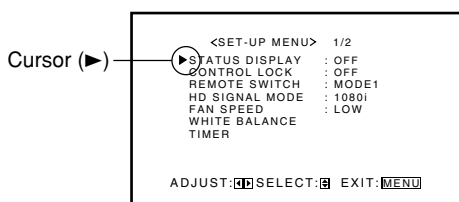

- 2 Press ▲/▼ to move the cursor (▶) to "POWER SAVE" (on the second page).**
 - The Setup Menu consists of two pages. If you keep pressing ▲/▼, you can move to the other page from the current page.

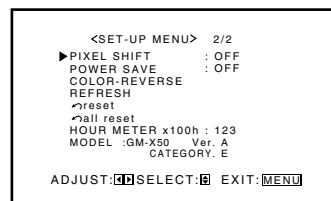

- 3 Press ◀/▶ to select the desired setting.**
SAVE1: The screen gets dim.
SAVE2: The screen gets dimmer.
OFF: The Power Save function is deactivate.
To cancel the Power Save function, select "OFF."
- 4 Press MENU/EXIT (or MENU on the Monitor) once to exit from the menu operations.**

Reducing the Afterimage Effect

If the same image (pattern) is continuously displayed on the screen for a long time, the area on the screen corresponding to the image may vary in brightness, leaving an afterimage on the screen.

You can reduce the afterimage by reversing the color of the image on the screen.

You can activate/deactivate the function with the Color-Reverse On/Off Timer.

- Display the image which has been caused the afterimage on the screen before starting the following procedure.

- 1 On the remote control:**
Press **VOLUME** – while holding **MENU/EXIT** to display the Setup Menu.
On the Monitor:
Press **◀** while holding **MENU** to display the Setup Menu.

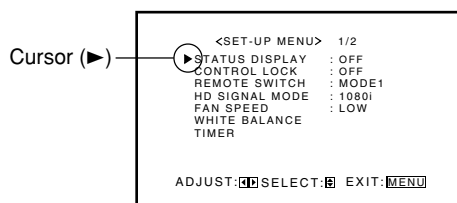

2 Press ▲/▼ to move the cursor (▶) to "COLOR-REVERSE" (on the second page), then press ▶.

- The Setup Menu consists of two pages. If you keep pressing ▲/▼, you can move to the other page from the current page.

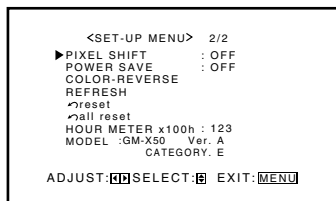

3 Press ▲/▼ to select the item you want to set and set the item as follows.

COLOR-REVERSE

You can activate/deactivate the function manually.

Press ◀/▶ to select the desired setting.

- ON:** The function is activated immediately after exiting the menu operations.
- OFF:** The function is deactivated.
- TIMER:** Select this when you use the Color-Reverse On/Off Timer.

Note:

- Set the clock (see page 26) and select "TIMER," before using the Color-Reverse On/Off Timer.

START SET

You can activate/deactivate the Color-Reverse On Timer.

Press ◀/▶ to select "ON" or "OFF."

- ON:** The function is automatically activated at the time set in "START TIME."
- OFF:** The Color-Reverse On Timer is deactivated.

START TIME

You can adjust the time to activate the function.

- Set the hour and minute following steps 4 to 6 in "Setting the Clock" (page 26).

END SET

You can activate/deactivate the Color-Reverse Off Timer.

- Press ◀/▶ to select "ON" or "OFF."
 - ON:** The function is automatically deactivated at the time set in "END TIME."
 - OFF:** The Color-Reverse Off Timer is deactivated.

END TIME

You can adjust the time to deactivate the function.

- Set the hour and minute following steps 4 to 6 in "Setting the Clock" (page 26).

4 Press MENU/EXIT (or MENU on the Monitor) repeatedly to exit from the menu operations.

To reset the Color-Reverse setting

After step 2 on the left column, proceed as follows:

- Press ▲/▼ to move the cursor (▶) to "reset."
- Press ▶.

The confirmation screen appears.



- Press ▶ again to reset the setting.

To cancel the reset, press MENU/EXIT (or MENU on the Monitor).

Note:

- The Color-Reverse function requires considerable time to reduce the afterimage. Deactivate the function temporarily at intervals of 30 minutes-1 hour and check the screen if the afterimage still remains or not. Set the function to off if the afterimage has been reduced.

Refreshing the Screen

After the power is turned off, a whitish image may be left on the screen. In that case, leave the monitor in a white back state for a while, and the image will disappear.

You can activate/deactivate the function with the Refresh On/Off Timer.

- On the remote control:**
Press VOLUME – while holding MENU/EXIT to display the Setup Menu.

- On the Monitor:**
Press ◀ while holding MENU to display the Setup Menu.

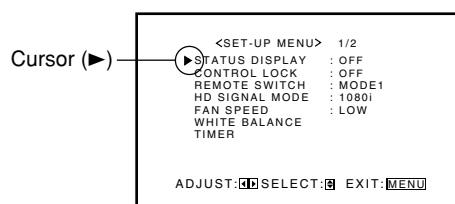

- Press ▲/▼ to move the cursor (▶) to "REFRESH" (on the second page) then press ▶.

- The Setup Menu consists of two pages. If you keep pressing ▲/▼, you can move to the other page from the current page.

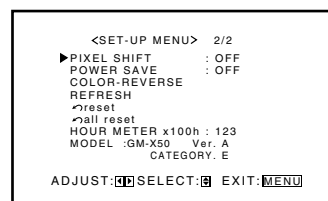

(To be continued on the next page)

Other Convenient Functions (Continued)

3 Press ▲/▼ to select the item you want to set and set the item as follows.

REFRESH

You can activate/deactivate the function manually.

- Press ◀/▶ to select the desired setting.

ON: The function is activated immediately after exiting the menu operations.

OFF: The function is deactivated.

TIMER: Select this when you use the Refresh On/Off Timer.

Note:

- Set the clock (see page 26) and select "TIMER," before using the Refresh On/Off Timer.

START SET

You can activate/deactivate the Refresh On Timer.

- Press ◀/▶ to select "ON" or "OFF."

ON: The function is automatically activated at the time set in "START TIME."

OFF: The Refresh On Timer is deactivated.

START TIME

You can adjust the time to activate the function.

- Set the hour and minute following steps 4 to 6 in "Setting the Clock" (page 26).

END SET

You can activate/deactivate the Refresh Off Timer.

- Press ◀/▶ to select "ON" or "OFF."

ON: The function is automatically deactivated at the time set in "END TIME."

OFF: The Refresh Off Timer is deactivated.

END TIME

You can adjust the time to deactivate the function.

- Set the hour and minute following steps 4 to 6 on "Setting the Clock" (page 26).

4 Press MENU/EXIT (or MENU on the Monitor) repeatedly to exit from the menu operations.

To reset the Refresh function setting

After step 2 above, proceed as follows:

- 1 Press ▲/▼ to move the cursor (▶) to "reset."

- 2 Press ▶.

The confirmation screen appears.

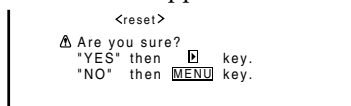

- 3 Press ▶ again to reset the setting.

To cancel the reset, press MENU/EXIT (or MENU on the Monitor).

Note:

- The Refresh function requires considerable time to reduce the afterimage. Deactivate the function temporarily at intervals of 30 minutes-1 hour and check the screen if the afterimage still remains or not. Set the function to off if the afterimage has been reduced.

Notes on the Color-Reverse/Refresh Timer

- Once you set the Color-Reverse/Refresh timer, the timer function is still activated even if you turn off the power. If you turn on the power after the "START TIME" you set, Color-Reverse/Refresh function is activated. To cancel the function, select "OFF" in the menu (see pages 29 and 30).
- The Color-Reverse timer is deactivated when you turn on or off the Color-Reverse function manually. The Refresh timer works in the same way as mentioned above. Select "TIMER" in the menu to control the functions automatically (see pages 29 and 30).

Resetting All the Setup Menu Settings

You can reset all the following Setup Menu settings at a time, except the use time (HOUR METER).

- 1 **On the remote control:**
Press VOLUME – while holding MENU/EXIT to display the Setup Menu.
On the Monitor:
Press ◀ while holding MENU to display the Setup Menu.

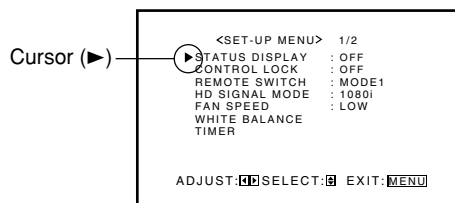

- 2 Press ▲/▼ to move the cursor (▶) to "reset" (on the second page).

- The Setup Menu consists of two pages. If you keep pressing ▲/▼, you can move to the other page from the current page.

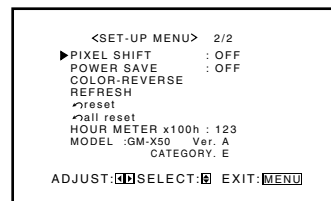

3 Press ►.

The confirmation screen appears.

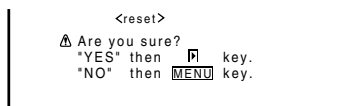

To cancel the reset, press MENU/EXIT (or MENU on the Monitor).

4 Press ► again to reset all the Setup Menu settings.

Resetting All the Menu Settings

You can reset all the Menu settings and adjustments at a time, except the use time (HOUR METER).

1 On the remote control:

Press VOLUME – while holding MENU/EXIT to display the Setup Menu.

On the Monitor:

Press ◀ while holding MENU to display the Setup Menu.

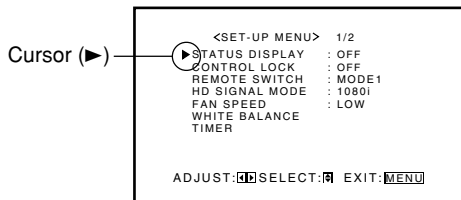

2 Press ▲/▼ to move the cursor (►) to "all reset" (on the second page).

- The Setup Menu consists of two pages. If you keep pressing ▲/▼, you can move to the other page from the current page.

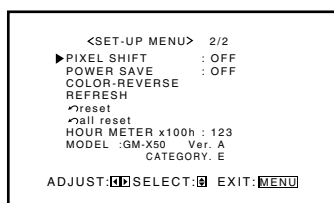

3 Press ►.

The confirmation screen appears.

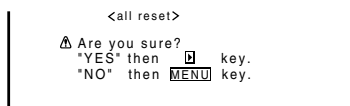

To cancel the reset, press MENU/EXIT (or MENU on the Monitor).

4 Press ► again to reset all the Menu settings and adjustments.

The power is turned off, then turned on again automatically.

Confirming the Use Time and Model Information

You can confirm the hours of use and the model information on the Setup Menu.

This may be necessary when you ask for any service.

1 On the remote control:

Press VOLUME – while holding MENU/EXIT to display the Setup Menu.

On the Monitor:

Press ◀ while holding MENU to display the Setup Menu.

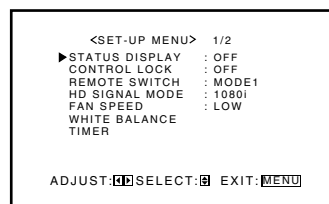

2 Keep pressing ▲/▼ until the second page of the Setup Menu appears.

- The Setup Menu consists of two pages. If you keep pressing ▲/▼, you can move to the other page from the current page.

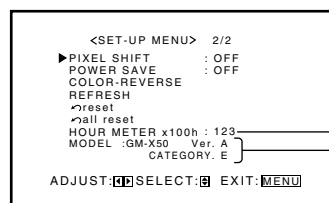

3 Confirm the hour of use and model information.

- The displayed value for the hours of use is divided by 100. To calculate the actual hours of use, multiply the displayed value by 100.

4 Press MENU/EXIT (or MENU on the Monitor) once to exit from the menu operations.

Notes:

- The value for the hours of use is added by one hour unit. If you use the monitor within one hour, it will not be added to the hours of use.
- The period when the monitor is on standby (the power lamp glows orange) will not be added to the hours of use.

Menu Classifications

Main Menu

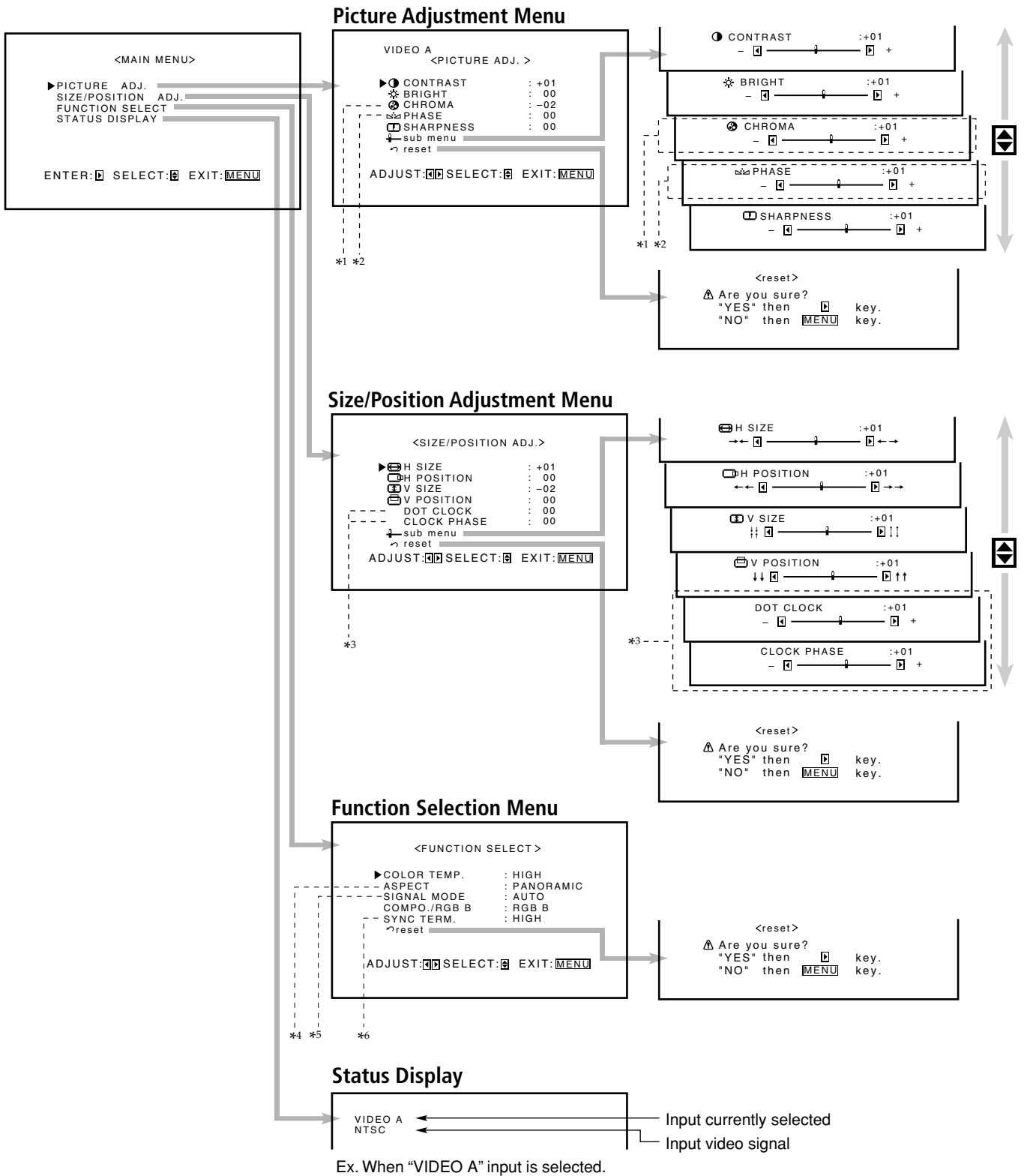

PICTURE ADJ. (Picture adjustment): See page 16.

CONTRAST	Adjusts the contrast of the picture.
BRIGHT	Adjusts the brightness of the picture.
CHROMA* ¹	Adjusts the color density of the picture.
PHASE* ²	Adjusts the color phase.
SHARPNESS	Adjusts the outlines of the picture.
sub menu	Displays the fine adjustment bar.
reset	Resets the Picture Adjustment Menu settings to defaults.

SIZE/POSITION ADJ. : See page 17.

H SIZE	Adjusts the horizontal screen size.
H POSITION	Adjusts the horizontal screen position.
V SIZE	Adjusts the vertical screen size.
V POSITION	Adjusts the vertical screen position.
DOT CLOCK* ³	Adjusts to eliminate stripes or flickering. Use with "CLOCK PHASE." Normally, no adjustment is needed.
CLOCK PHASE* ³	Adjusts to eliminate stripes or flickering. Use with "DOT CLOCK." Normally, no adjustment is needed.
sub menu	Displays the fine adjustment bar.
reset	Resets Size/position Adjustment Menu settings to defaults.

FUNCTION SELECT: See pages 19 to 21.

COLOR TEMP.	Adjusts the color temperature. Use when the picture is reddish or bluish.
ASPECT* ⁴	Selects the horizontal to vertical ratio of the screen.
SIGNAL MODE* ⁵	<ul style="list-style-type: none"> • Selects a color system (NTSC, PAL, SECAM, N4.43 (NTSC 4.43), PAL60) when VIDEO A or VIDEO B input is selected. Normally, set to "AUTO." • Selects a scan system—480i, 576i, 480p, 576p, 720/60p, 720/50p, 1080/60i (1035i), 1080/50i—when COMPONENT input is selected. Normally, set to "AUTO."
COMPO./RGB B	Selects the usage of the COMPONENT/RGB B terminals either as the COMPONENT input terminal or as the RGB B input terminal.
SYNC TERM.* ⁶	Adjusts the resistance of RGB B input terminals.
reset	Resets the Function Selection Menu settings to defaults.

STATUS DISPLAY: See page 22.

Shows the input mode and signal type on the screen.

*¹ Adjustable when viewing the NTSC, PAL, or SECAM signal, or component signal.

*² Adjustable when viewing the NTSC signal or component signal.

*³ Adjustable when RGB A or RGB B input is selected.

*⁴ Not adjustable when viewing the following component signals—720/60p, 720/50p, 1080/60i (1035/60i), and 1080/50i. (In such a case, "ASPECT" does not appear on the display.)

*⁵ Adjustable when VIDEO A, VIDEO B, or COMPONENT input is selected.

*⁶ Adjustable when RGB B input is selected.

Menu Classifications (Continued)

Setup Menu

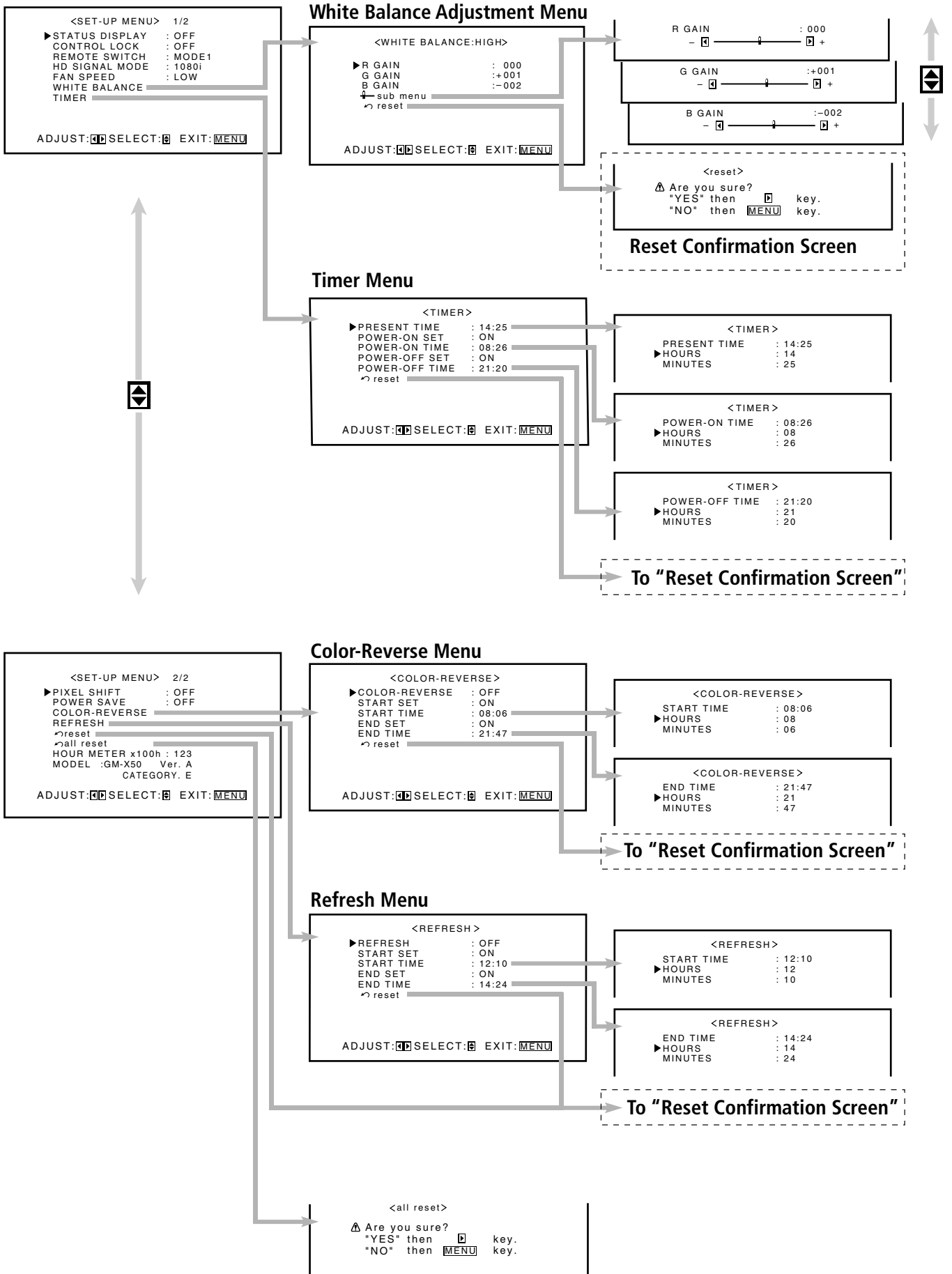

STATUS DISPLAY: See page 23.

Sets if you want the input terminal and the type of signal to be indicated on the screen just after inputs are switched.

CONTROL LOCK: See page 23.

Sets the Monitor so that it cannot be operated with the buttons on itself.

REMOTE SWITCH: See page 24.

Set the selectable input terminals when controlling the Monitor with the external control unit.

HD SIGNAL MODE: See page 24.

Select the High-Definition (HD) signal type.

FAN SPEED: See page 25.

Sets the speed of the internal cooling fan.

WHITE BALANCE: See page 25.

Adjusts R GAIN, G GAIN and B GAIN finely each for "HIGH" and "LOW" settings of the color temperature.

TIMER: See pages 26 and 27.

Sets the clock and the Power On/Off Timer.

PIXEL SHIFT: See page 28.

Sets a screen saver.

POWER SAVE: See page 28.

Sets the power save function.

COLOR-REVERSE: See page 28.

Use to reduce the afterimage on the screen of the still picture by reversing the color.

REFRESH: See page 29.

Use to reduce the whitish image remaining on the screen after turning off the power.

reset: See page 30.

Resets the Setup Menu settings to defaults.

all reset: See page 31.

Resets the all menu settings and adjustments to defaults.

HOUR METER x 100h: See page 31.

Use to confirm the hours of use.

MODEL: See page 31.

Use to confirm the model information of the Monitor.

Troubleshooting

Solutions to common problems related to the Monitor are described here. If none of the solutions presented here solves the problem, unplug the Monitor and consult an authorized dealer or service center.

Symptom	Probable cause	Corrective action	Page
Power is not supplied.	• Is the power cord disconnected?	• Insert the power cord (plug) firmly.	12
	• Is the POWER switch turned on?	• Turn on the POWER switch.	14
Power is suddenly turned on or off.	• Is the Power On/Off Timer activated?	• Set the timer to "OFF" on the menu.	26
Video image does not appear, or audio sound does not occur.	• Is the correct input selected?	• Select the correct input by pressing INPUT SELECT (VIDEO A, VIDEO B, COMPO./ (RGB B) or RGB A) on the remote control (or INPUT on the Monitor).	14
	• Are the devices connected correctly?	• Connect the devices correctly.	11, 12
	• Are signals being supplied from the connected devices?	• Set the devices correctly.	—
	• Is "COMPO./RGB B" set correctly if using the COMPONENT/RGB B terminals?	• Set it correctly.	20
	• Are input signals (scanning frequency, etc.) appropriate?	• Check if the signal is appropriate (scanning frequency, etc.), and input the appropriate signal.	10
	• Is brightness adjusted correctly?	• Adjust brightness on the menu.	16
	• Is volume set at minimum?	• Adjust volume.	14
	• Are the diagnostic lamps turned on?	• Refer to "Self-diagnostic Indication," and take an appropriate action.	37
The picture becomes blurred.	• Is the signal RGB input?	• Adjust DOT CLOCK and CLOCK PHASE using the menu.	17
	• Is the RGB B connecting cord long?	• Set the SYNC TERM. "LOW."	21
Color is abnormally dark or bright.	• Is brightness adjusted correctly?	• Adjust BRIGHT (brightness) using the menu.	16
	• Is picture quality (color density, etc.) adjusted correctly?	• Adjust picture using the menu.	16
	• "TEMP. OVER" lights (or flashes) at the right bottom of the screen.	• Refer to "Self-diagnostic Indication," and take an appropriate action.	37
Color is poor or unstable.	• Is the correct broadcast system (color system) selected?	• Set SIGNAL MODE (color system) to "AUTO."	20
	• Are signals (scanning frequency, etc.) to connected devices appropriate?	• Check if the signal is appropriate (scanning frequency, etc.), and input the appropriate signal.	10
Color is suddenly reversed or whitened.	• Is the Color-Reverse/Refresh timer activated?	• Set "COLOR-REVERSE" / "REFRESH" to "OFF" on the menu.	29, 30
The picture is cut or shifted toward one side.	• Is the size or position of the screen adjusted properly?	• Adjust H SIZE, V SIZE, H POSITION or V POSITION using the menu.	17
The remote control does not work.	• Are the batteries correctly set?	• Insert batteries correctly, observing the polarities (⊕ and ⊖).	8
	• Are the batteries exhausted?	• Replace with new batteries.	8
	• Is there any object blocking the path between the remote control and remote sensor?	• Remove any blocking object.	—
	• Is the Monitor too far away from you?	• Move toward the Monitor, then operate the remote control.	—
The buttons on the Monitor do not work.	• Is the Control Lock function in use?	• Set the Control Lock function to "OFF" using the menu.	23

Self-diagnostic Indication

When something abnormal occurs with the Monitor, this function informs you of the condition of the Monitor with self-diagnostic lamps, allowing for smooth service work.

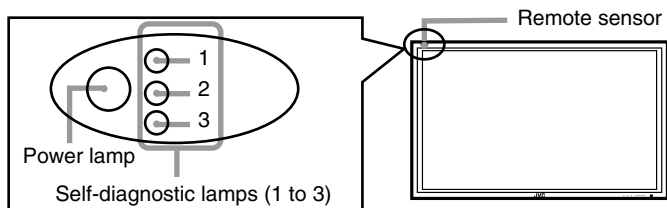

❑ If the screen monitor turns off and self-diagnostic lamps light or flash

If the self-diagnostic lamps light or flash in red, check the following before consulting the dealer where you purchased the Monitor.

- **If self-diagnostic lamp 1 (upper) flashes, lamp 2 (middle) lights, and lamp 3 (lower) flashes**

This may be caused by the dusty intakes on the rear. If this happens, switch off the main power by POWER switch (set to "○ (off)"), unplug the AC power cord, then clean the intakes by referring to the instruction on page 2.

- After cleaning, switch on the Monitor's main power again. If self-diagnostic lamps do not go off, consult your dealer immediately.

❑ If the screen monitor dims a little and "TEMP. OVER" lights (or flashes)

If "TEMP. OVER" lights or flashes at the right bottom of the screen, check the following before consulting the dealer where you purchased the Monitor.

"TEMP. OVER" appears to warn you of the internal heat buildup, which is usually caused by accumulated dust around the intakes or by improper installation. If the cause of the internal heat buildup is eliminated, this indication disappears and the screen recovers the brightness.

- **If "TEMP. OVER" flashes in yellow**

This may be caused by the dusty intakes on the rear. If this happens, switch off the main power by POWER switch (set to "○ (off)"), unplug the AC power cord, then clean the intakes by referring to the instruction on page 2.

- After cleaning, switch on the Monitor's main power again. If "TEMP. OVER" still flashes, this trouble may be caused by improper installation or improper location of the Monitor. In this case, consult your dealer immediately to solve this improper installation and to improve the circumstances around the Monitor.

- **If "TEMP. OVER" lights in red**

"TEMP. OVER" will be shown for about two minutes, the Monitor will shut off automatically, then the Self-diagonal lamps light in red. If this happens, switch off the main power by POWER switch (set to "○ (off)"), unplug the AC power cord, then consult your dealer immediately.

If the trouble still persists, follow the procedure below:

1 Check which lamps are lighting or flashing.

On the Self-diagnostic Report Sheet (below), check the box next to "Lights" or "Flashes" of the corresponding lamp or lamps.

- Only one lamp may light or flash, or all three lamps may do so.

2 Switch off the POWER switch on the back of the Monitor.

3 Unplug the power cord.

4 Call your dealer and tell which lamps are lighting or flashing. (Copy and fax the Self-diagnostic Report Sheet below.)

Note:

If you switch on the main power immediately after switching it off (or after recovering from a brief power interruption), the self-diagnostic lamps may light (or flash), and no image may appear on the screen. In this case, switch off the main power again, wait for about 10 seconds, then switch it on again. If no self-diagnostic lamps light or flash, you can operate and use the Monitor as usual.

Self-diagnostic Report Sheet

Store name where you purchased the Monitor

To _____

Model Name:

Plasma Display Monitor
GM-X50S

The self-diagnostic lamps light or flash as listed on the following table. Please give me immediate advice or service if necessary.

Self-diagnostic lamps			
NO.	Lamp position	Conditions	
1	Upper	<input type="checkbox"/> Lights	<input type="checkbox"/> Flashes
2	Middle	<input type="checkbox"/> Lights	<input type="checkbox"/> Flashes
3	Lower	<input type="checkbox"/> Lights	<input type="checkbox"/> Flashes
TEMP. OVER		<input type="checkbox"/> Lights	<input type="checkbox"/> Flashes

Your Name:	
Telephone No.:	
Address:	

Specifications

	Model name	GM-X50S		
General	Frame color	Silver		
	Screen size	Type 50 wide format		
	Aspect ratio	16:9 (Wide format)		
	Number of pixels displayed	1366 (H) x 768 (V)		
	Number of colors displayed	16.77 million (256 colors for each of RGB)		
	Effective screen size (W x H, Diagonally)	110.7 cm x 62.2 cm, 127 cm		
	Weight	50 kg		
	External dimensions (W x H x D)	123.2 cm x 74.3 cm x 10.3 cm * Excluding protruding parts		
	Power requirements	AC 220 – 240 V, 50 Hz/60 Hz		
	Rated input current	2.2 A		
	Compatible systems			
	VIDEO A, VIDEO B input	NTSC, NTSC 4.43, PAL, PAL 60, SECAM		
	COMPONENT input	480i, 576i, 480p, 576p, 720/60p, 720/50p, 1080/60i (1035/60i), 1080/50i		
Audio power output	SPEAKER OUT: 6 Ω to 8 Ω 3 W + 3 W (TYP at impedance 6 Ω)			
Operating conditions	Temperature: 0 °C to 40 °C Relative humidity: 20 % to 80 % (non-condensation) (Slightly variable depending on ambient conditions for installation.)			
Input/output terminals	VIDEO A			
	Video input	BNC terminal x 1, 1 V(p-p), 75 Ω		
	Video output	BNC terminal x 1, 1 V(p-p), 75 Ω		
	Audio input	Pin jack terminal x 2 (L/R) 500 mV(rms), high impedance		
	VIDEO B			
	Y/C input	Y/C terminal x 1 Y: 1 V(p-p), 75 Ω C: 0.286 V(p-p), 75 Ω (for NTSC) C: 0.3 V(p-p), 75 Ω (for PAL/SECAM)		
	Video input	Pin jack terminal x 1, 1 V(p-p), 75 Ω		
	Audio input	Pin jack terminal x 2 (L/R) 500 mV(rms), high impedance		
	COMPONENT/RGB B *			
	COMPONENT input	BNC terminal x 3 Y: 1 V(p-p), 75 Ω Pb/B-Y: 0.7 V(p-p), 75 Ω Pr/R-Y: 0.7 V(p-p), 75 Ω		
	RGB input	BNC terminal x 5 <u>Analog RGB:</u> R: 0.7 V(p-p), 75 Ω G: 0.7 V(p-p), 75 Ω B: 0.7 V(p-p), 75 Ω G on sync: 1 V(p-p), 75 Ω (negative sync) <u>Horizontal sync/Composite sync (HD/Cs):</u> HD: 0.3 V(p-p) to 5 V(p-p), 1 kΩ (positive/negative polarity) / 75 Ω (positive/negative polarity) Cs: 0.3 V(p-p) to 5 V(p-p), 1 kΩ (positive/negative polarity) / 75 Ω (positive/negative polarity) <u>Vertical sync (VD):</u> VD: 1 V(p-p) to 5 V(p-p), 1 kΩ (positive/negative polarity) / 75 Ω (positive/negative polarity)		
	Audio input	Pin jack terminal x 2 (L/R) 500 mV(rms), high impedance		

Input/output terminals	<div style="border: 1px solid black; display: inline-block; padding: 2px;">RGB A</div> RGB input	D-sub 3-row 15-pin terminal x 1, Video signal: 0.7 V(p-p), 75 Ω G on sync: 1 V(p-p), 75 Ω (negative sync) <u>Horizontal sync/Composite sync (HD/Cs):</u> HD: 0.3 V(p-p) to 5 V(p-p), 470 Ω (positive/negative polarity) Cs: 0.3 V(p-p) to 5 V(p-p), 470 Ω (positive/negative polarity) <u>Vertical sync (VD):</u> VD: 1 V(p-p) to 5 V(p-p), 470 Ω (positive/negative polarity)
	Audio input	Stereo mini jack terminal x 1 500 mV(rms), high impedance
	REMOTE terminals	RS-232C: D-sub 9-pin terminal x 1 MAKE: Mini DIN 4 pin WIRED: Stereo mini jack terminal x 1
	OPTION terminal	Used exclusively for JVC's optional parts
	AUDIO OUT terminals	Pin jack terminal x 2 (L/R) Output impedance 600 Ω
	SPEAKER OUT (L/R) terminals	Impedance 6 Ω to 8 Ω

* To use the COMPONENT/RGB B terminals either as the COMPONENT input terminal or as the RGB B input terminal, you need to set "COMPO./RGB B" correctly (see page 20).

- For easy understanding, pictures and illustrations are shown by being emphasized, omitted or composed, and may be more or less different from actual products.
- Design and specifications are subject to change without notice.
- IBM and IBM PC are registered trademarks of International Business Machines Corporation. Macintosh is registered trademarks of Apple Computer, Inc.
All other product names mentioned herein are used for identification purposes only, and may be the trademarks or registered trademarks of their respective companies.

Options (not supplied)

Stand Unit	TS-CL01SG, TS-CL02SG
Wall Mounting Unit	TS-C420P2W, TS-C420P6W, TS-C420P8W, TS-C420P9W
Ceiling Suspension Unit	TS-C420P3W
Cooling Fan Unit	TS-C01FANG
Speaker Unit	TS-C500SPG

- Consult your dealer to see if other options are available.

Notice on transportation

This Monitor is precision equipment and needs dedicated packing material for transportation. Never use any packing material supplied from other than JVC or JVC-authorized dealers.

Specifications (Continued)

Pin assignment (Specifications for terminals)

- Y/C terminal

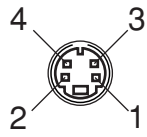

Pin number	Signal name
1	GND (Y)
2	GND (C)
3	Y
4	C

- RS-232C terminal

This is a female type connector.

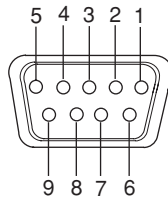

Pin number	Signal name	Pin number	Signal name
1	DCD	6	DSR
2	RD	7	RTS
3	TD	8	CTS
4	DTR	9	RI
5	GND		

- MAKE terminal

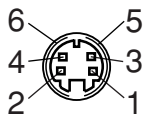

Pin number	Signal name
1	GND
2	GND
3	SW2
4	SW1
5	SW DET
6	GND

- RGB Input Terminal

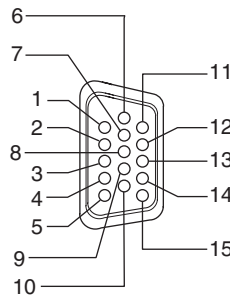

Pin number	Signal name	Pin number	Signal name
1	Red	9	N/C
2	Green	10	GND
3	Blue	11	GND
4	N/C	12	N/C
5	GND	13	HD/Cs
6	GND	14	VD
7	GND	15	N/C
8	GND	External	GND

Dimensions

Top view

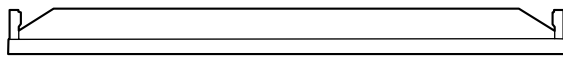

Front view

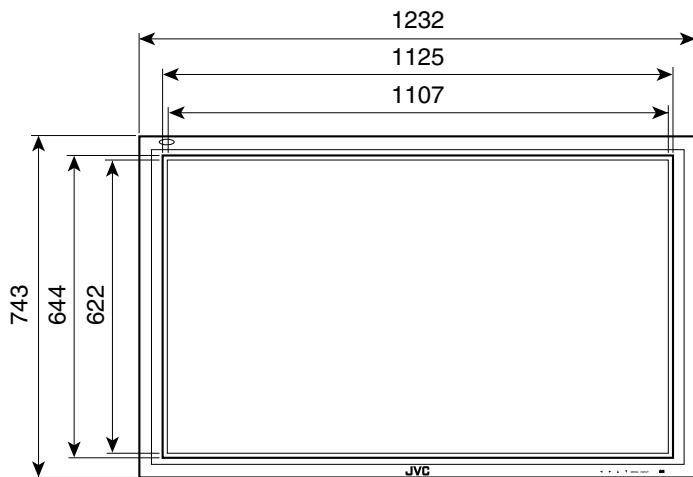

Side view

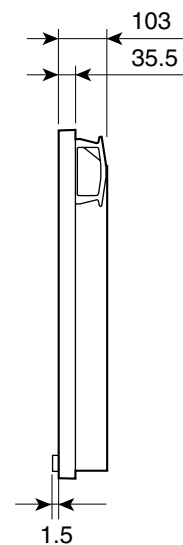

Unit: mm

JVC



Free Manuals Download Website

<http://myh66.com>

<http://usermanuals.us>

<http://www.somanuals.com>

<http://www.4manuals.cc>

<http://www.manual-lib.com>

<http://www.404manual.com>

<http://www.luxmanual.com>

<http://aubethermostatmanual.com>

Golf course search by state

<http://golfingnear.com>

Email search by domain

<http://emailbydomain.com>

Auto manuals search

<http://auto.somanuals.com>

TV manuals search

<http://tv.somanuals.com>