

JVC

HD-ILA TV

HD-Z70RF7

HD-Z61RF7

HD-Z56RF7

INSTRUCTIONS

HD-ILATM
Powered by **D-ILA**

DynaPiX **HD**
Powered by **D.L.S.T.**

HDMITM
HIGH-DEFINITION MULTIMEDIA INTERFACE

MaxxBass[®]



HD-Z70RF7

Expanding the world of beautiful images

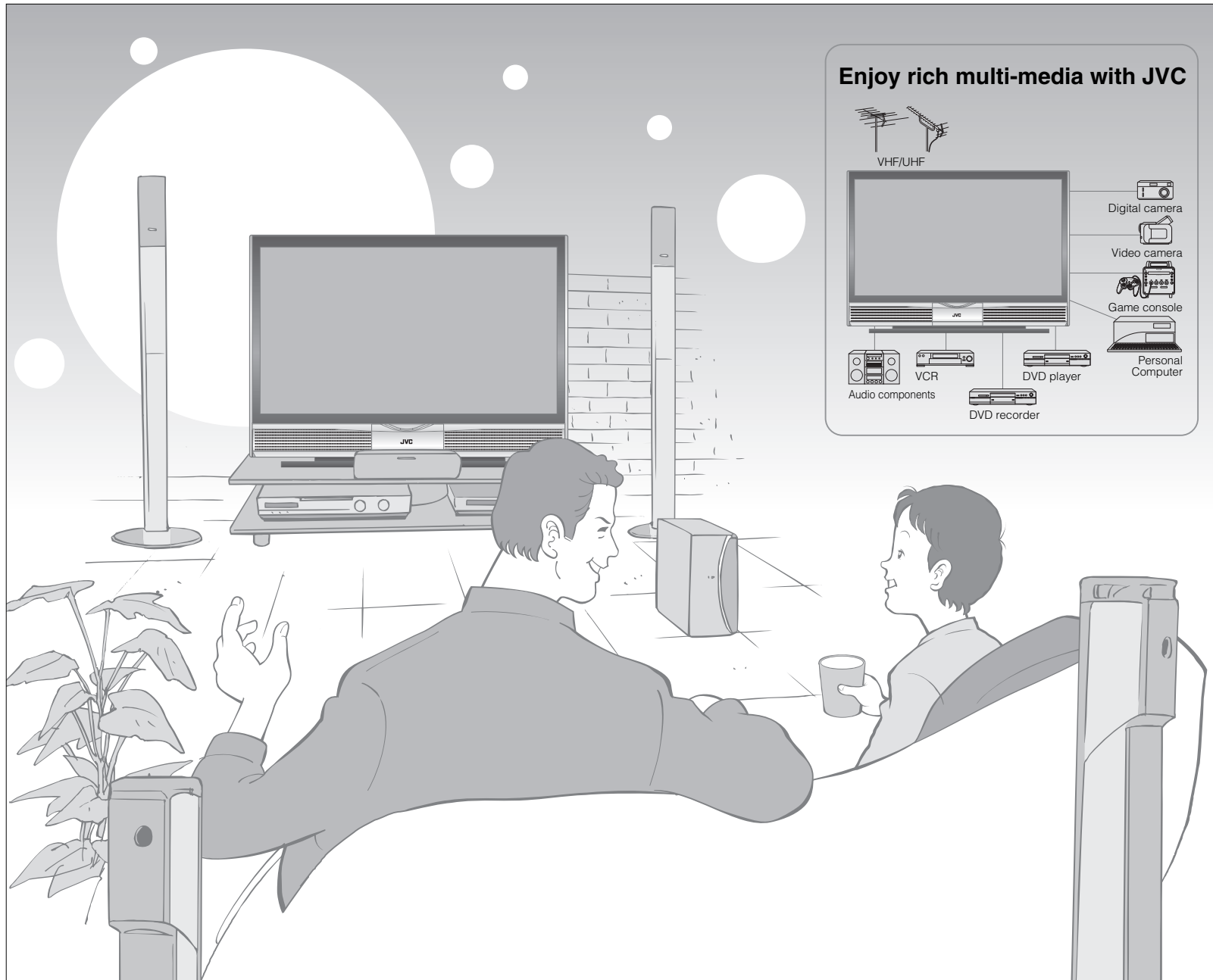

Contents

First things first!

- Warning 2
- Precautions 3
- Replacing the lamp 4

Getting started

- Names of all the parts 6
- Basic connections 7
- Initial settings 8
- Editing channels 9
 - Registering channels
- Connecting external devices 10

Let's try it out

- Enjoying your new TV! 11
 - TV / Teletext / Video / etc.
- Watching TV 12
- Viewing teletext 13
- Watching videos / DVDs 14

Try the advanced features

- Useful functions 15
 - Register your favourite channels
 - View and search in multi-picture mode
 - Sleep timer / Channel Guard
- Operate JVC recorders and other devices 17

Just the way you like it

- Customising your TV 18
- Advanced picture adjustment 19
 - Reduce noise / Watch a more natural picture
 - Set the aspect ratio, etc.

When you have trouble

- Troubleshooting 20
- Technical information 22
- CH/CC List 22
- Specifications 23

IMPORTANT!

PREPARE

USE

SETTINGS

TROUBLE?

Warning

Please follow all the guidelines below

Never insert objects into the cabinet openings!

- It may cause a fatal electric shock. Take care when children are near.

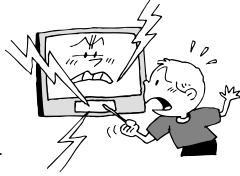

Never place anything on the TV!

- Placing liquids, open flames, cloths, paper, etc. on the TV may cause a fire.



Never expose to rain or moisture!

- To prevent fire or electric shock, never allow liquids to enter the unit.



Do not allow the TV to fall!

- Do not rest your elbows on, or allow children to hang from the TV. There is a risk that the TV will fall and cause injuries.

Never cut or damage the power cord!

- If the AC plug is not the right shape, or the power cord is not long enough, use an appropriate plug adapter or extension cable. (Consult your retailer.)

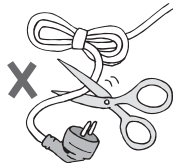

Follow this manual regarding setup!

- Connect only to a 110-240V, 50/60Hz AC outlet.

Never try to repair the TV yourself!

- ➔ If the problem cannot be solved in "Troubleshooting" (P. 20), unplug the power cord and contact your retailer.

If the TV is damaged or behaving strangely, stop using it at once!

- ➔ Unplug the power cord and contact your retailer.

Hold the TV so as not to scratch the screen!

- Do not touch the screen when carrying the TV.

Do not hold by the screen frame when moving the TV!

- This could cause the screen frame to detach, causing the TV to fall. Hold the TV as illustrated on the right.

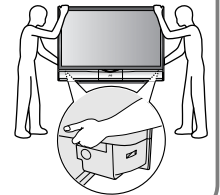

Unplug the power cord when going out!

- The power buttons on the remote control and the TV unit cannot completely turn off the TV. (Make appropriate arrangements for bedridden people.)
- Make sure that the cooling process (P. 3) has completed before unplugging the power cord.

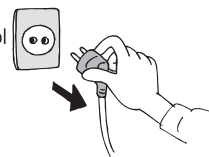

Make enough room for inserting and removing the power plug!

Place the TV as near as possible to the AC outlet

- The main power supply for this TV is controlled by inserting or removing the power plug.

Ensure ample room to avoid overheating

- ➔ "Installation requirements" (P. 7)

Never dismantle the rear panel!

- It may cause an electric shock.

Never block the ventilation holes!

- It may cause overheating or a fire.

Handle screen with care!

- Use a soft, dry cloth when cleaning.

Never listen with headphones at high volume!

- It may damage your hearing.

- For more details on installation, usage and safety ➔ Consult your retailer

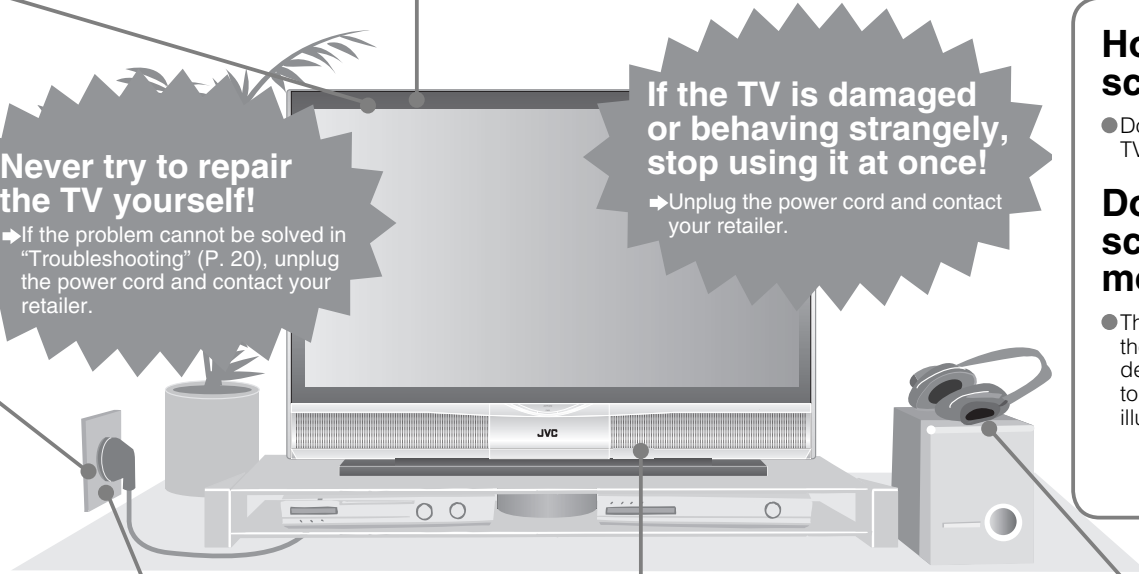

Precautions

Please follow all the guidelines below

This TV uses a lamp to project the picture on the screen. Misoperations may shorten the lamp life or cause malfunction of the lamp. Before operating the TV, read all the instructions below.

This TV has a fan to cool the lamp

- When the lamp is hotter, the fan works harder to cool the lamp. In such a case, the noise of the fan becomes louder but it is not malfunction.

Do not place the TV too closely to wallpaper

- The warm air from the air ducts may change the colour of the wallpaper.

Keep children or pets away from the air ducts

- Long exposure to the warm air from the ducts may cause a minor burn.

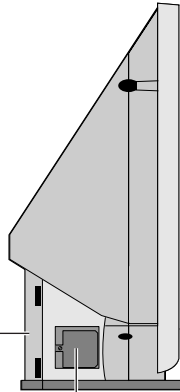

The lamp is a consumable item

- When the lamp has blown, replace the lamp; otherwise, the picture cannot be displayed. For details ► "Replacing the lamp" (P. 4, 5)

Follow the instructions on "Replacing the lamp" when replacing the lamp (P. 4)

- Handle the lamp carefully and correctly; otherwise, it may cause a burn or an electric shock. In addition, it may shorten lamp life or cause malfunction of the TV.

Never open the lamp cover except when replacing the lamp

■ Exposing the lamp is dangerous because...

- The lamp becomes extremely hot while in use, it may cause a burn.
- Touching metallic portion of the lamp may cause electric shock.
- Ultraviolet rays are emitted from the lamp.

Never replace the lamp immediately after use

- Since the lamp becomes extremely hot while in use, it may cause a burn.

Never touch the lamp glass

- Dirt or oil from the finger may cause the lamp to break.

When the power is turned on, the warming up commences

- Immediately after the TV is turned on, the picture is displayed only dimly. It takes about one minute for the lamp to warm up. Once the lamp has warmed up, you can enjoy the pictures at their normal brightness.
- During this warming-up period, the LAMP indicator blinks every 2 seconds.

While the LAMP indicator is blinking, the TV cannot be turned off

When the power is turned off, the cooling down is performed

- When the TV is turned off, the picture on the screen disappears gradually. Once the screen is dark, cooling down is performed for about 1 minute.
- During this cooling-down period, the LAMP indicator blinks every 2 seconds.
- Do not unplug the TV while the lamp is cooling down. This may cause the internal circuits and the lamp to overheat and shorten the lamp life.

While the LAMP indicator is blinking, the TV cannot be turned on

- You can turn on the TV within 15 seconds after turning off.

Condensation on the lamp and screen

- When the heater is turned on or the TV is moved from a cold place to a warm place, droplets of water may form on the lamp and screen. This is called condensation. If the TV is used while this condensation is still present, the picture may seem distorted, and the inside of the screen may become dirty. In this case, wait until the condensation has gone before using the TV.

Do not turn the power on and off repeatedly in a short period

- It subjects the TV and the lamp to stress and may lead to malfunctions and shorten the lamp life.

Do not keep the TV on for more than 24 hours consecutively

- The lamp life may be shortened.

Do not project a still picture for a long time

- Because of the ILA characteristics, still picture may stick on the screen. (The picture will disappear over time.)

■ For more details on installation, usage and safety ► Consult your retailer

Replacing the lamp

Before replacing the lamp, read all the instructions.

The TV uses a lamp to project the picture onto the screen. When the lamp has blown or when the picture becomes dark, replace the lamp. Before replacing the lamp, read all the instructions carefully.

■ If you feel unsure about replacing the lamp yourself → Consult your retailer

Preparation

Prepare the Replacement Lamp Kit

- For purchasing the Replacement Lamp Kit, consult your retailer.

⚠ Use only the specified Replacement Lamp Kit!

This lamp is for use with JVC model televisions. Using the lamp with a different television or other product could cause a malfunction and/or damage to the television or lamp.

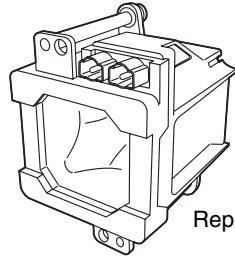

Replacement Lamp Kit:
TS-CL110C

- High-pressure mercury lamp

When the lamp is near to its end...

- The following message appears on the screen.

Lamp needs to be replaced.
Refer to instructions book for replacement instructions.

After replacing the Lamp, please reset timer in the TV menu.

Press OK, if you do not want to see this message again.

- To make the message disappear



After the usage time of the lamp has reached to 6500 hours, this message appears every time you turn on the TV.

■ Possible causes of shortened lamp life

- Turning on/off the TV repeatedly in a short amount of time
- Keeping the TV turned on for more than 24 hours consecutively

1 Turn the TV off

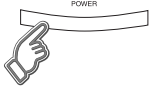

▶

Wait until the LAMP indicator stops blinking

- LAMP indicator and Power lamp are referred as "LAMP LED" and "POWER LED" on the Instructions of Replacement Lamp Kit TS-CL110C.

▶

Unplug the TV

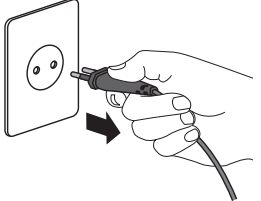

2 Wait for at least 1 hour until the lamp has fully cooled

3 Remove the lamp unit

⚠ **Never replace the lamp before it has fully cooled!**

The lamp becomes extremely hot while in use, which may cause a burn. After turning off the TV, wait for at least 1 hour.

⚠ **Never attempt to replace the lamp with the TV plugged in!**

Attempting to replace the lamp with the TV plugged in could lead to a severe electrical shock.

1 Remove the lamp cover

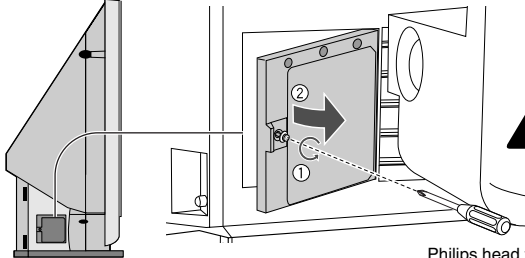

Philips head type screw driver (cross-head type)

⚠ **If you feel any warmth near the lamp, DO NOT TOUCH IT!**

2 Remove the lamp unit

Loosen

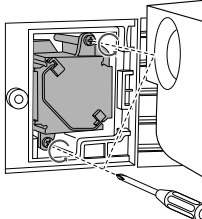

▶

Remove

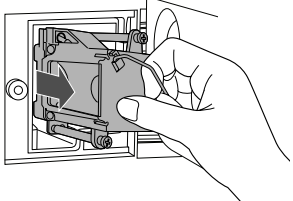

Do not drop the lamp!

● HD-Z70RF7 is used for explanation on the illustrations on this Instructions.

4 Install the NEW lamp unit

1 Unpack

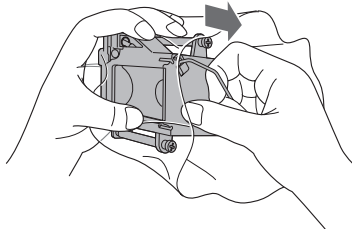

**Do not drop the lamp!
Do not shock the glass surface of the lamp!**

It may shatter the lamp causing injuries.

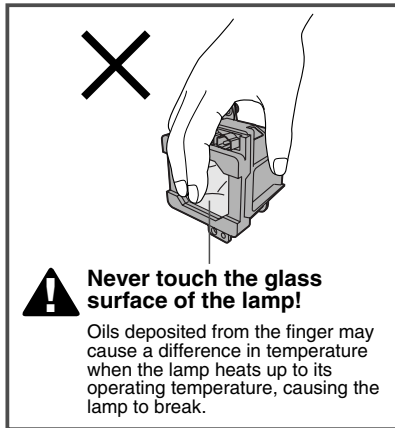

Re-tighten

2 Insert

- Make sure the lamp sits securely and flat in the housing area.

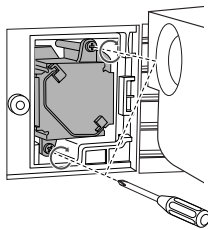
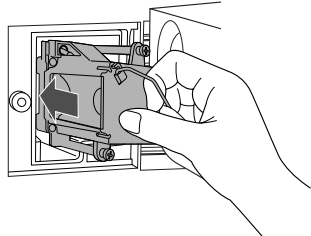

3 Reinstall the lamp cover

- Tighten the screw.

5 Plug in the TV

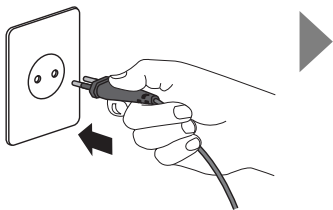

Turn the TV on

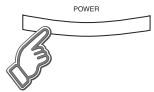

- If the lamp unit is not installed securely (e.g. flat in the lamp housing area), the TV won't turn on. In this case, reinstall the lamp unit.

6 Reset the lamp timer



1 Display the menu bar



2 Select "Set Up"

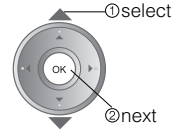
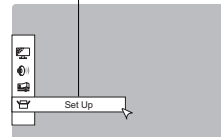

3

Select "Lamp Timer Reset"

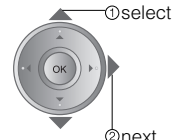
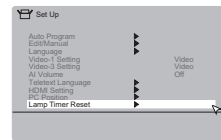

4

Finish



7 Finally, the lamp has been replaced!

! Never dispose of the lamp with normal trash!

The lamp contains a small amount of mercury. For disposal or recycling information, please contact your local authorities or consult your retailer.

Dispose of it in the same way as disposing of fluorescent lamps.

■ If the power lamp and LAMP indicator blink rapidly after turning on the TV → "Lamp" (P. 21)

Names of all the parts

Front panel

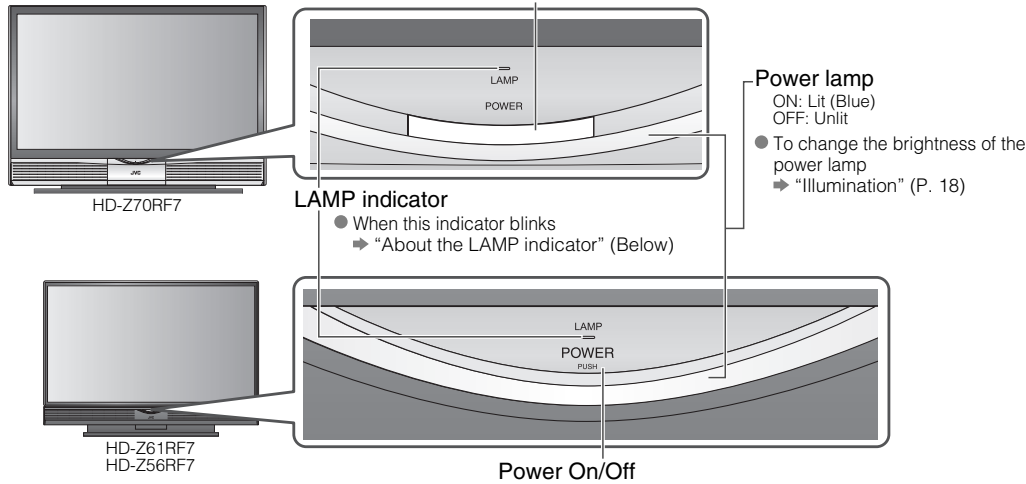

Left side panel

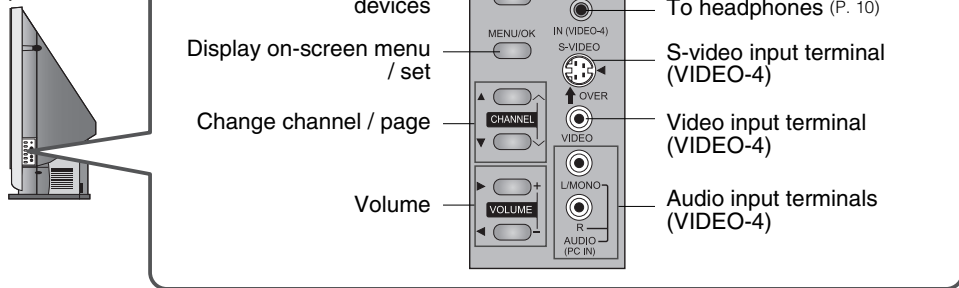

● Connecting terminals on the back of the TV → "Connecting external devices" (P. 10)

About the LAMP indicator

The LAMP indicator blinks as follows.

- When turning on the TV, the LAMP indicator blinks for about 1 minute every 2 seconds.
 - ➔ The lamp is warming up. During this period, the TV cannot be turned off.
- After turning off the TV, the LAMP indicator blinks for about 1 minute every 2 seconds.
 - ➔ Cooling is performed. During the cooling period, the TV cannot be turned on.
- If the LAMP indicator blinks rapidly
 - ➔ "Lamp" (P. 21)

Check accessories

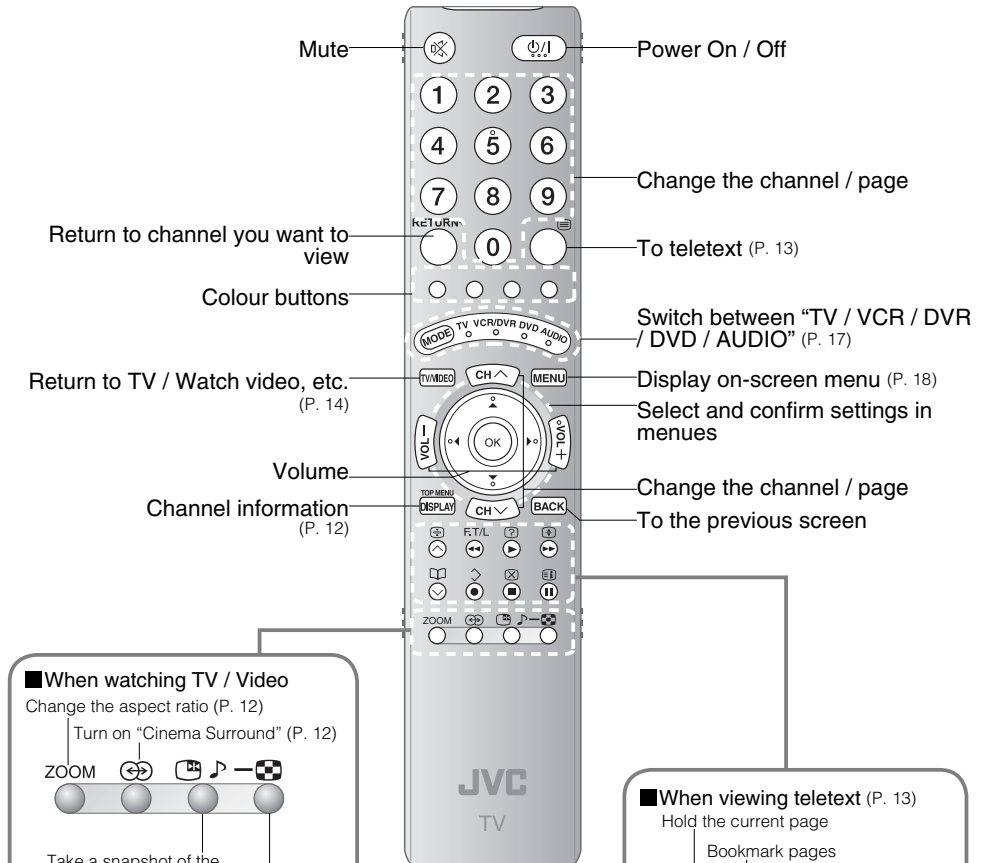
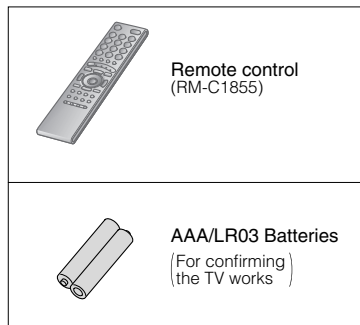

When viewing teletext (P. 13)

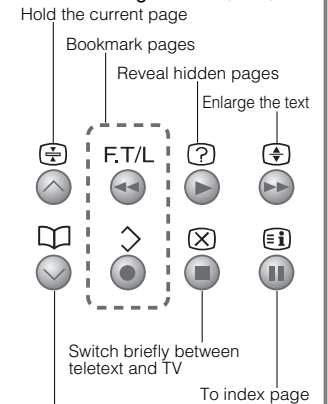

- When watching TV (P. 16)
- When operating a JVC VCR or DVD (P. 17)

When watching TV / Video

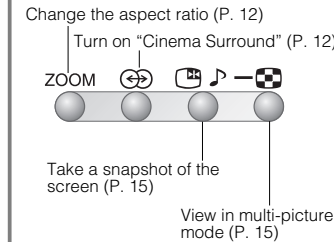

Insert the batteries

Use two "AAA/LR03" dry cell batteries. Insert the batteries from the ⊖ end, making sure the ⊕ and ⊖ polarities are correct.

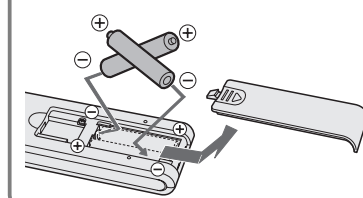

Basic connections

Please read the user manuals of each device carefully before setup.
It is necessary to connect an aerial to watch TV.

■ **Connect with other devices** → “Connecting external devices” (P. 10)

Connect the aerial

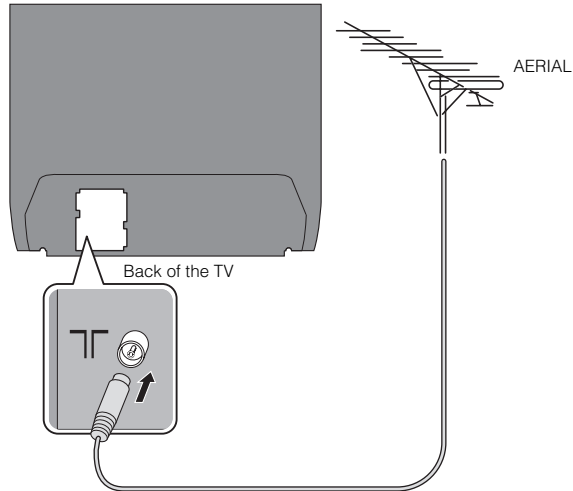

- After all the connections have been made, insert the plug into an AC outlet.

Care when setting

■ Power requirements

- Connect the power cord only to a 110-240V, 50/60Hz AC outlet.

■ Installation requirements

- To avoid overheating, ensure the unit has ample room.

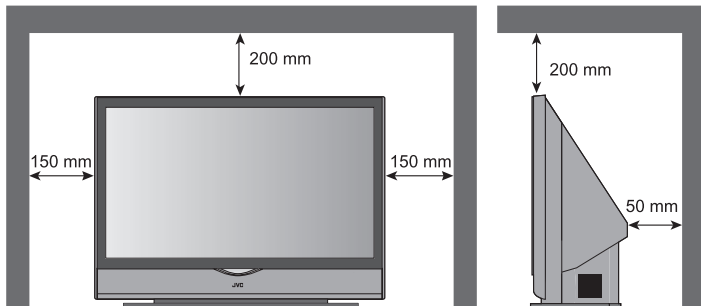

Do not place the TV too close to wallpaper

- The warm air from the air ducts may change the colour of the wallpaper.

Keep children or pets away from the air ducts

- Long exposure to the warm air from the ducts may cause a minor burn.

Connect a VCR / DVD recorder

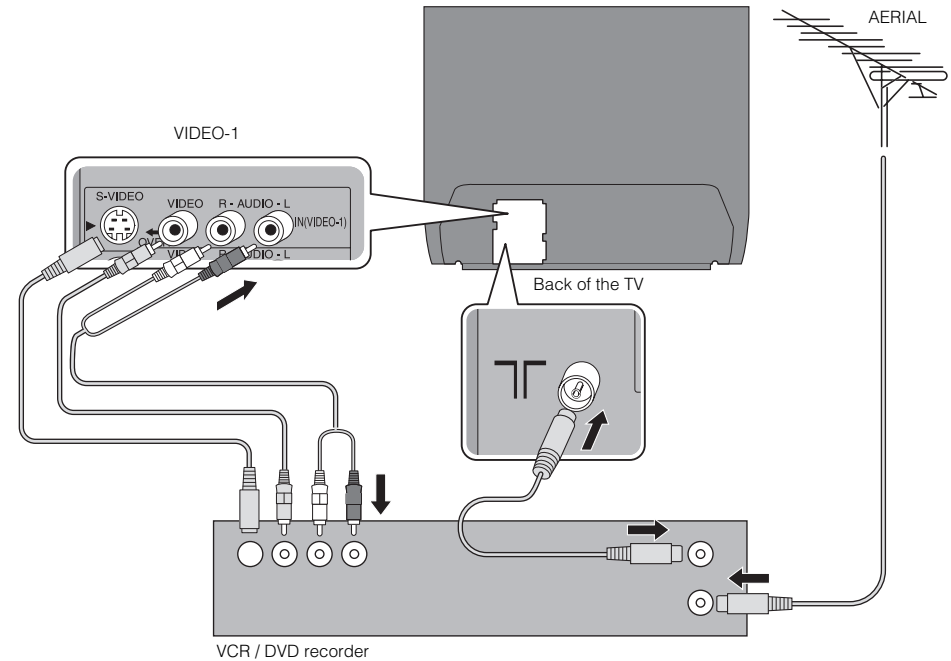

- After all the connections have been made, insert the plug into an AC outlet.
- If both composite and S-VIDEO cable are connected, S-VIDEO will be enable.

IMPORTANT!

PREPARE

USE

SETTINGS

TROUBLE?

Initial settings

Set the menu language, installation location and automatically register the TV channels. These channels can be edited later in "Editing channels" (P. 9).

- After turning on the TV, it takes about 1 minute to project the picture to its full brightness.
- After turning off the TV, it takes about 5 seconds to make the screen dark. After that, cooling is performed for about 1 minute.
- ➔ "About the LAMP indicator" (P. 6)

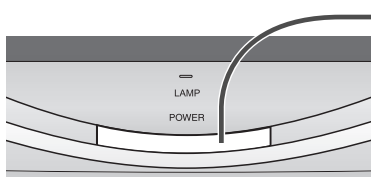

HD-Z70RF7

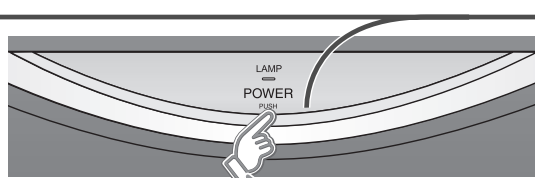

HD-Z61RF7
HD-Z56RF7

When you press the Power button of the HD-Z61RF7 or HD-Z56RF7, recommend that press below of the button.

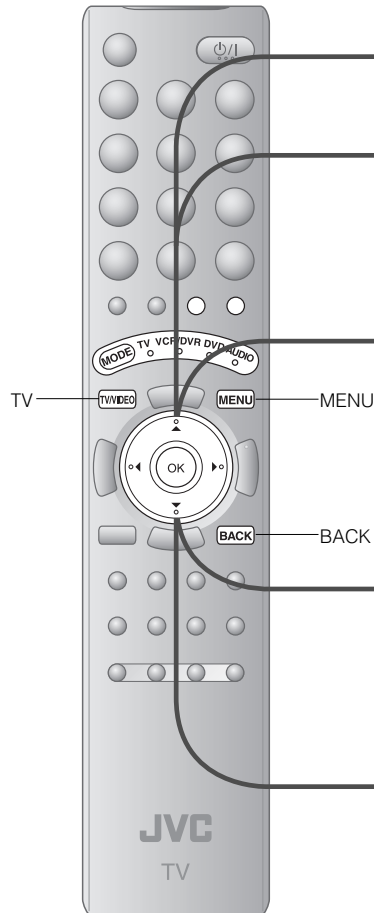

1

Begin



- Shown only when powering on for the first time.
- The power button on the remote control can also be used.

2

Select a language

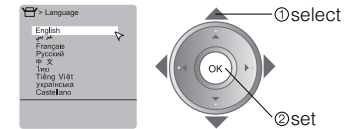

3

Select the teletext language group



4

Automatically register channels

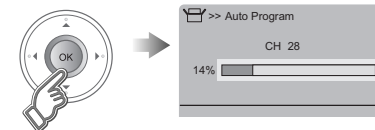

5

Check what was registered

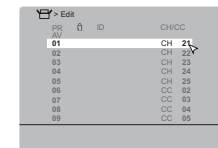

■ Edit channels

➔ 4 in "Editing channels" (P. 9)

6

Confirm



■ The remote control doesn't work

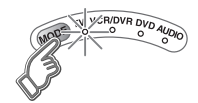

- Confirm the mode is set to "TV".

- For the teletext language group
 - ➔ "Language group for teletext" (P. 22)
- If the characters are unreadable
 - ➔ "Language group for teletext" (P. 22)

■ To the previous screen ➔ **BACK**

■ Exit ➔ **MENU**



■ If the "JVC" logo does not appear or if you wish to make changes later
➔ "Language", "Teletext Language" and "Auto Program" (P. 18)

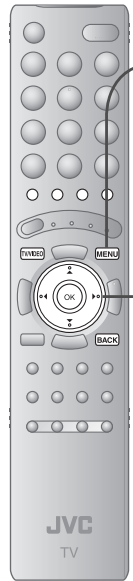

Editing channels

Edit the channels registered with "Auto Program" in "Initial settings" (P. 8).

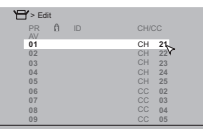

When coming from "Initial settings" (P. 8), skip to ④.

- 1 Display the menu bar**

- 2 Select "Set Up"**

- 3 Select "Edit / Manual"**

- 4 Select a row**

- 5 Edit**
- 6 Finish**

 To the previous screen
 Exit

Move a channel's position
MOVE

Edit a channel name
ID

Insert a channel
INSERT

Delete a channel
DELETE

Register a new channel
MANUAL

①Begin **②Select a destination** **③Finish**

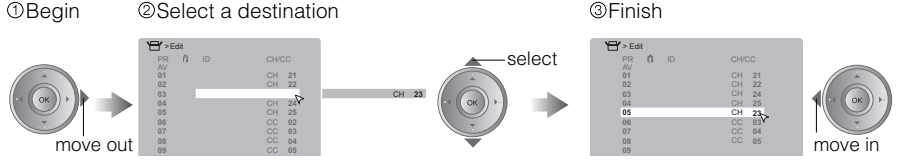

①Begin **②Enter a channel name**

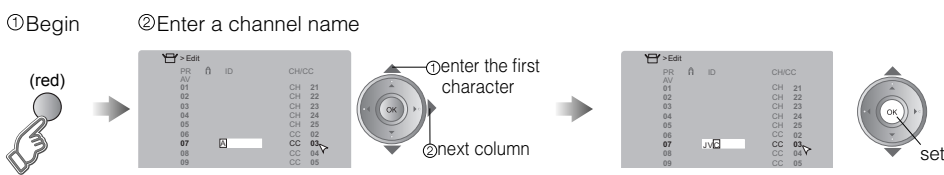

①Begin **②Select a CH / CC** **③Enter a number**

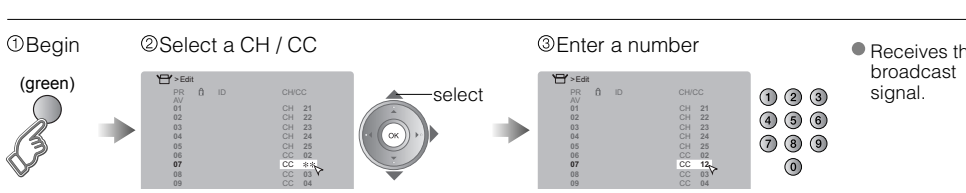

● "CH/CC List" → (P. 22)

①Delete

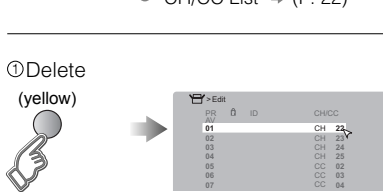

①Begin **②Beginning channel search** **③Set**

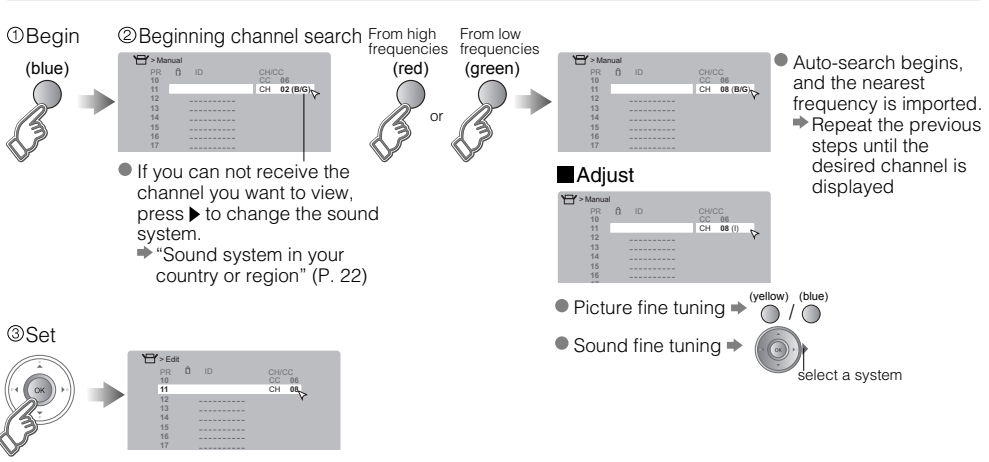

● Auto-search begins, and the nearest frequency is imported.
 ● Repeat the previous steps until the desired channel is displayed

● Picture fine tuning → (yellow) / (blue)
 ● Sound fine tuning → (yellow) / (blue) select a system

IMPORTANT!
 PREPARE
 USE
 SETTINGS
 TROUBLE?

Connecting external devices

VCR / DVD / other devices

You can connect many devices to the rear panel of the TV.
Please read the user manuals of each device before setup. (Connecting cables are not supplied with this TV.)

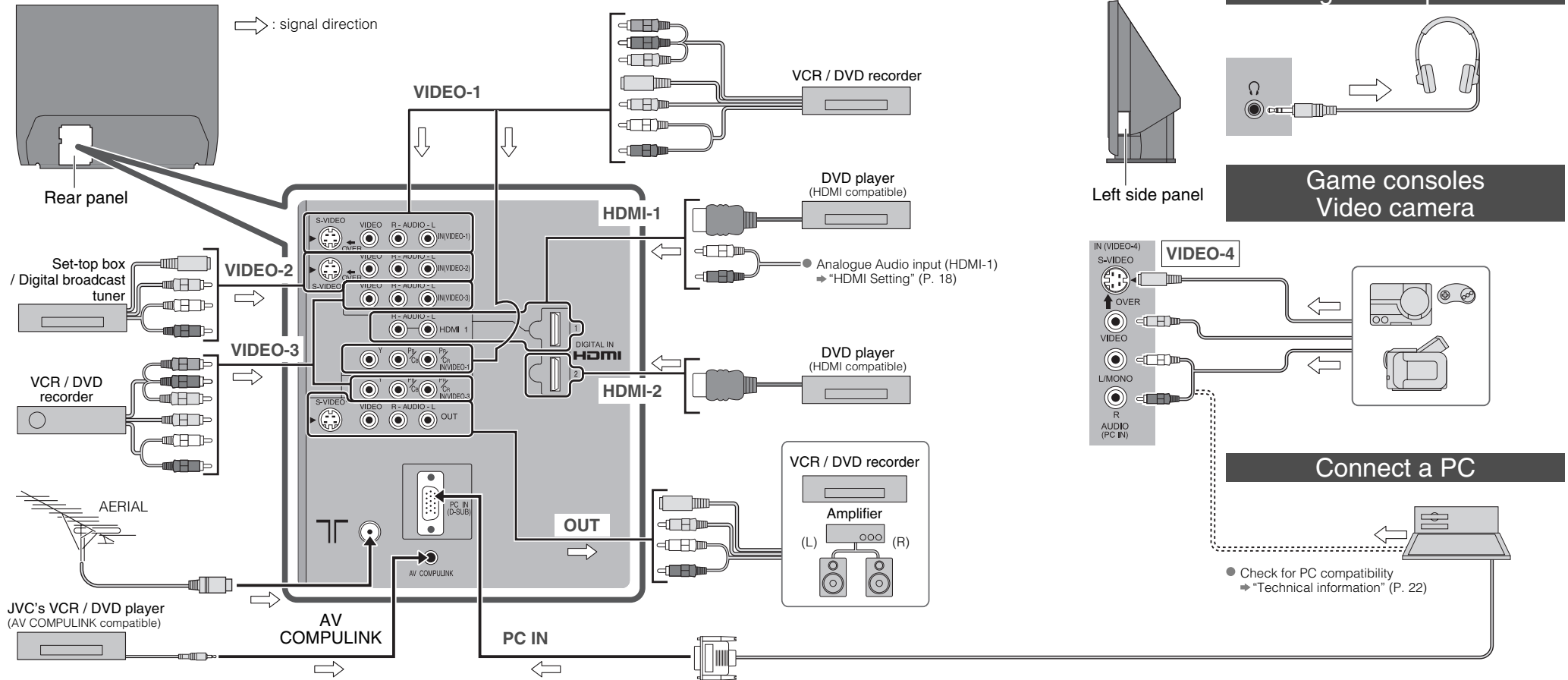

AV COMPULINK

This feature makes playing video tapes or DVDs totally automatic. Simply insert a pre-recorded media into your JVC brand VCR or DVD player and the device will automatically turn on and begin playback. At the same time, using the AV Compulink, the VCR or DVD player sends a signal to the television telling it to turn on and switch to the proper video input.

- Refer to your DVD or VCR's instruction book for detailed connection information.

VIDEO-1 Watching videos

Output ↑	Input ↓
	<ul style="list-style-type: none"> Component signal / S-VIDEO / Composite signal / Sound L / R

- Use Component signal → "Switch between video and component signal" (P. 14)
- Use S-VIDEO → "Using S-VIDEO" (P. 14)

VIDEO-2 Watching videos

Output ↑	Input ↓
	<ul style="list-style-type: none"> S-VIDEO / Composite signal / Sound L / R

- Use S-VIDEO → "Using S-VIDEO" (P. 14)

VIDEO-3 Watching videos

Output ↑	Input ↓
	<ul style="list-style-type: none"> Component signal / Composite signal / Sound L / R

- Use Component signal → "Switch between video and component signal" (P. 14)

VIDEO-4 Watching videos

Output ↑	Input ↓
	<ul style="list-style-type: none"> S-VIDEO / Composite signal / Sound L / R

- Use S-VIDEO → "Using S-VIDEO" (P. 14)

Connect DVI devices to "HDMI-1"

→ (P. 22)

HDMI-1 Connecting HDMI devices

Output ↑	Input ↓
	<ul style="list-style-type: none"> HDMI signal / Sound L / R (HDMI-1 only)

- "HDMI Setting" → (P. 18)
- HDMI-2 input does not support analogue sound.

OUT

Video and sound signal of a TV channel you are viewing s from this terminal

Output ↑	Input ↓
<ul style="list-style-type: none"> S-VIDEO / Composite signal / Sound L / R 	

- "Using OUT terminal" → (P. 14)

Enjoying your new TV!

Watching TV

PAGE
12

- View channel information
- Change the aspect ratio
- Enjoy "Cinema Surround"
- Register your favourite channels

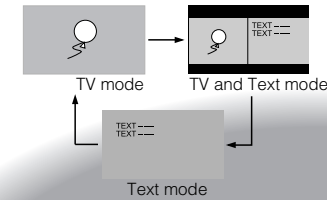
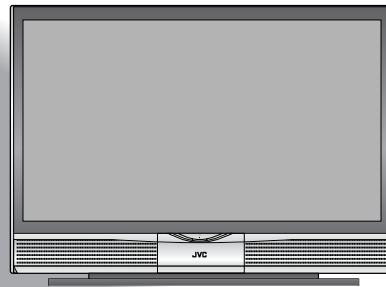
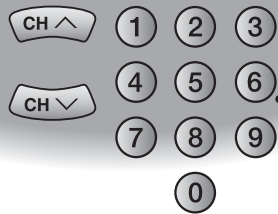

Viewing teletext

PAGE
13

- Enlarge the text
- To the index page
- Hold the current page
- Switch briefly between teletext and TV
- Bookmark your favourite pages
- Reveal hidden pages

MENU

Personal preferences

PAGE
18

- Adjust the picture
- Adjust the sound
- Advanced settings
(sleep-timer / channel guard, etc.)
- Basic settings
(channel settings, etc.)

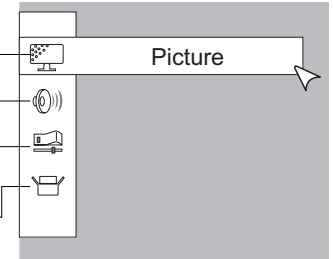

Watching videos / DVDs

PAGE
14

- Watch high quality video (S-VIDEO)
- Switch between video and component signal
- PC position adjustments

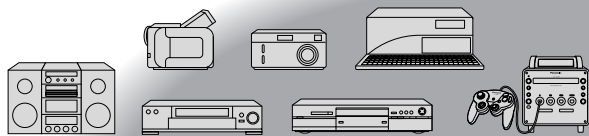

TV/VIDEO

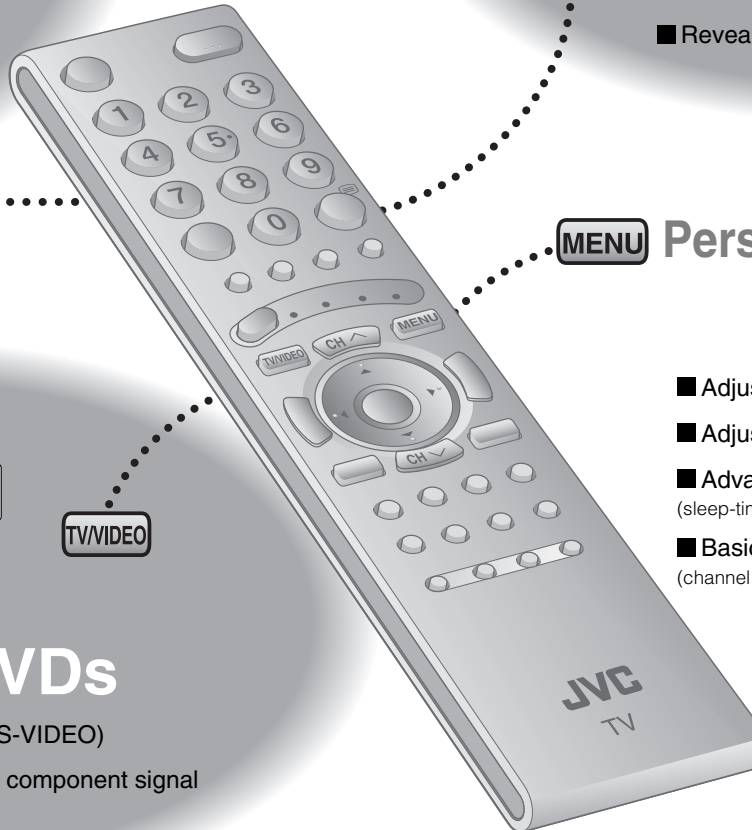

IMPORTANT!
PREPARE
USE
SETTINGS
TROUBLE?

Watching TV

1 Set to "TV"
 Mute

2 Power on
 The blue power lamp on the TV lights
 Press again to turn the screen off and put the TV into standby mode.

3 Select a channel
 E.g. 1 : 0 → 1
 15 : 1 → 5

Move up or down a channel
 CH ^ up
 CH v down

Switch between stereo / mono / bilingual broadcasting
 → "Stereo / I - II" (P. 18)

Note
 To completely turn off the TV, unplug the AC plug after the LAMP indicator stops blinking.

Volume

- After turning on the TV, it takes about 1 minute to project the picture to its normal brightness.
- After turning off the TV, it takes about 5 seconds to make the screen dark. After that, cooling down is performed for about 1 minute.
- ➔ "About the LAMP indicator" (P. 6)

<p>Channel information</p> <p>DISPLAY</p>	<p>PR List</p> <ul style="list-style-type: none"> ● Channels registered in "Initial settings" will appear here. <p>Channel information</p> <p>(No indication)</p> <p>select</p> <p>view</p>
<p>Change the aspect ratio</p> <p>ZOOM</p>	<p>ZOOM</p> <p>select</p> <p>set</p> <p>16 : 9 Zoom</p> <p>Move the picture with ▲ or ▼ while this bar is displayed</p> <ul style="list-style-type: none"> ● When set to "Auto", the aspect ratio will turn to the ratio obtained from the information the TV received. Without receiving aspect information, it will be set to "4:3 Auto Aspect" (P. 19) ● Not available for 1080i (1125i) / 720p (750p) signals. ● In PC mode, "Regular" and "Full" can be selected.
<p>Enjoy ambient sound</p> <p>CINEMA SURROUND</p>	<p>Cinema Surround High</p> <p>High : For stereo sound Low : For stereo sound (when the sound distorts in "High" mode) Mono : For mono sound (emulates a stereo-like sound) Off : Turns off "Cinema Surround"</p>
<p>Emphasize bass sound</p> <p>MAXXBASS</p>	<p>High</p> <p>select</p> <p>set</p> <p>Off Low High level</p>
<p>Always return to the channel you want to view</p> <p>RETURN PLUS</p>	<p>Registered as return channel</p> <p>While the channel is displayed</p> <p>RETURN+ Hold down for 3 seconds</p> <p>Return Plus Programmed!</p> <p>Cancel</p> <p>While the channel is displayed</p> <p>RETURN+ Hold down for 3 seconds</p> <p>Return Plus Canceled!</p> <p>Recall the return channel</p>
<p>Return to the last channel you were viewing</p> <p>RETURN</p>	<p>RETURN+</p> <p>Current channel</p> <p>Last channel</p>

Basic operations using the side buttons

1 POWER Power on

2 CHANNEL Change the channel

Volume

Viewing teletext

This TV can display TV broadcasts and teletext on the same channel in two windows.

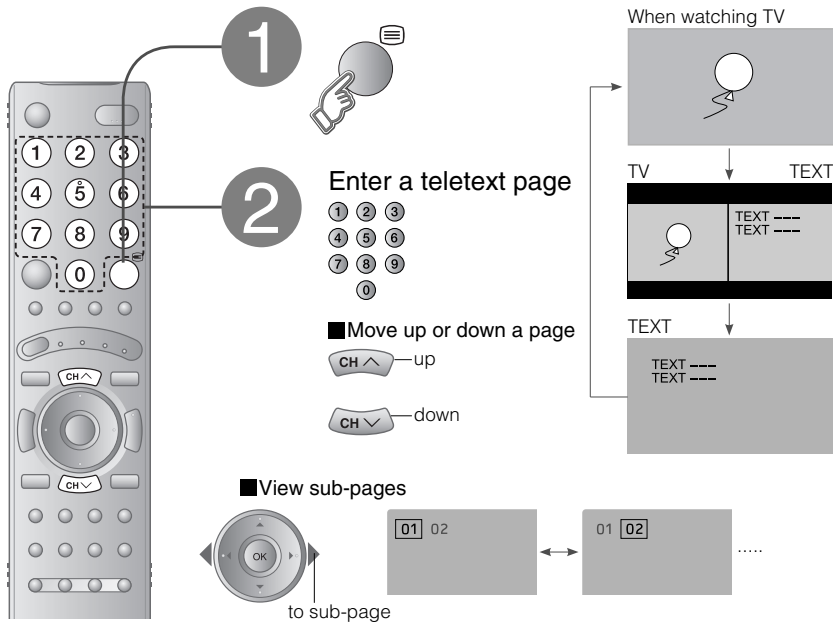

Bookmark your favourite page

LIST MODE

- 1** Display your favourites list
F.T/L
- 2** Select a coloured button to save your page to
- 3** Enter the number of the page to save
- 4** Save

■ Recall your favourite page → Press the coloured button as in step 2

(RED) (GREEN) (YELLOW) (BLUE)

???

???

(red) (green) (yellow) (blue)

???

1 2 3
4 5 6
7 8 9
0

???

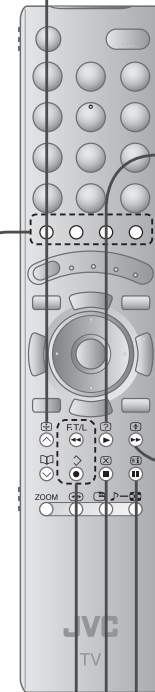

Hold the current page
HOLD

Hold the current page

Release → Press again

Reveal hidden pages
REVEAL

Display hidden information (answers to quizzes, etc)

1 + 2 =
2 x 3 =

1 + 2 = 3
2 x 3 = 6

Enlarge the text
SIZE

Double the size of the displayed text

TEXT SIZE

TEXT SIZE

TEXT SIZE

To the index page
INDEX

Returns to page "100" or a previously designated page

Switch briefly from teletext to TV
CANCEL

Leave the current page open, while you switch to watch TV

P233 TEXT TEXT

P233

Useful when running a page search.

IMPORTANT!

PREPARE

USE

SETTINGS

TROUBLE?

Watching videos / DVDs

1 Select the video source

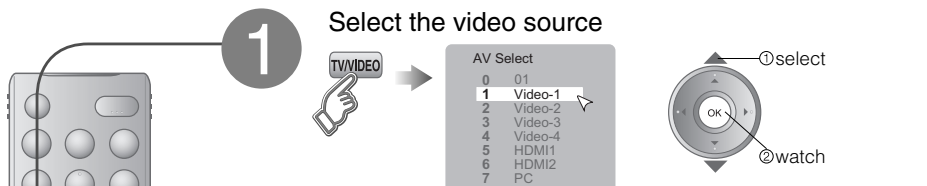

2 Operate the connected device and play a video
 ■ Operate JVC recorders and other devices (P. 17)

Select the video source using the side buttons

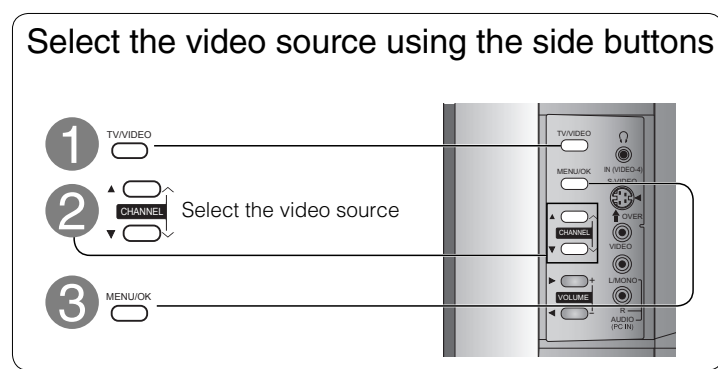

Switch between video and component signal

1 Display the menu bar

2 Select "Set Up"

3 Select "Video-1 Setting" or "Video-3 Setting"

4 Change setting

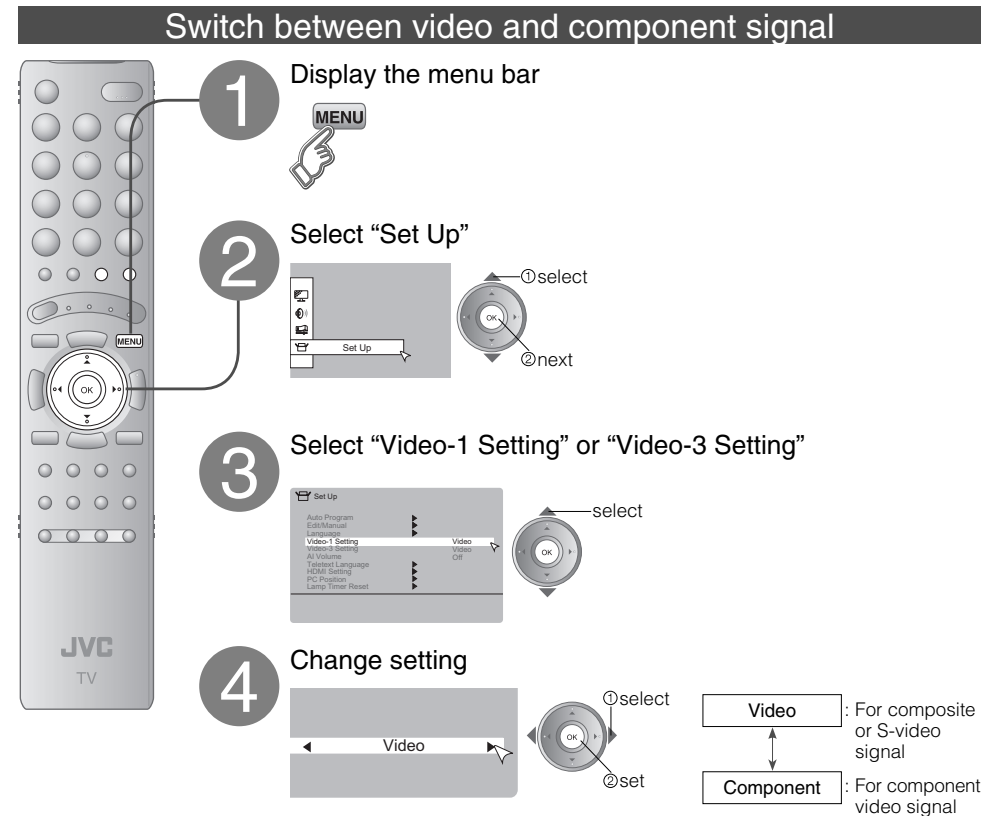

Video : For composite or S-video signal
 Component : For component video signal

PC position adjustment

1 Display the menu bar

2 Select "Set Up" → Select "PC Position"

3 Adjust PC Position

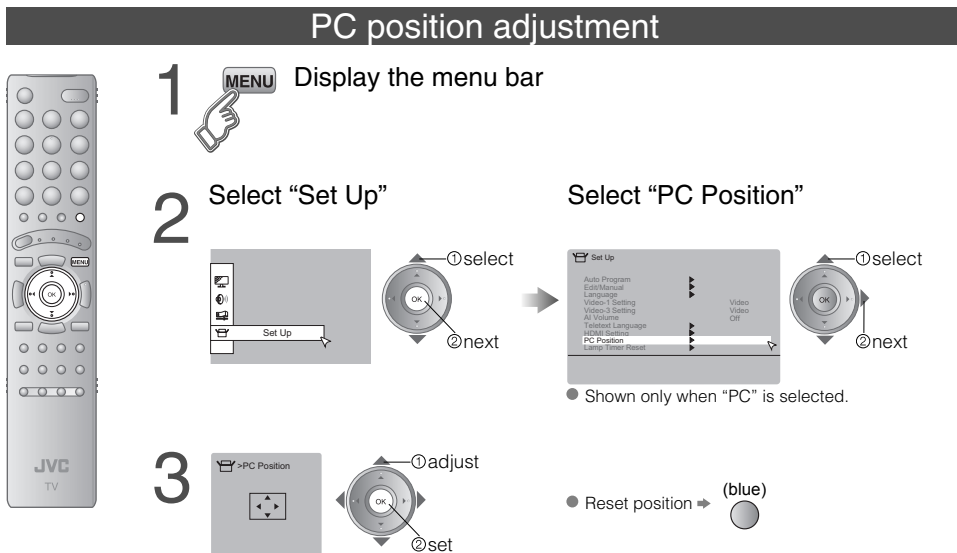

Reset position → (blue)

Using S-VIDEO

- If both composite and S-VIDEO cables are connected, S-VIDEO will be enable.

Using OUT terminal

- Component and PC signals do not come out from this terminal.
- When you are viewing video signal, no signal will come out through the S-VIDEO terminal.
- HDMI-1 and HDMI-2 inputs does not come out from this terminal.

Useful functions

Take snapshots of the screen

FREEZE

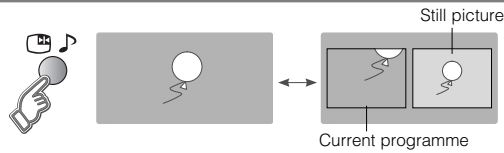

■ Cancel

- ➔ Press "MUSIC" again, or change the channel
- Not available when the Sub-picture (below) is displayed, or when in PC mode.
- You cannot save or export the snapshot.

Select the number of screens



- Selecting "1" returns to normal viewing mode
- Not available in PC mode.

■ Watch in dual-picture mode

E.g. You can watch TV and video at the same time.

(For wide aspect ratio signals)

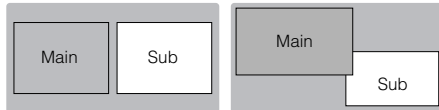

- Switch between the sound sources
➔
- Change the channel
➔ (Main)
➔ (Sub)

■ Select a channel in 12-screen mode

All registered channels are displayed as still images.

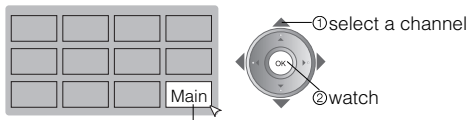

- Only the selected frame has a moving picture.
- Move up or down a page ➔
- Not available for HDMI-1 or HDMI-2 input.

Watch in multi-picture mode

MULTI-PICTURE

Set a time for the TV to turn itself off

SLEEP TIMER

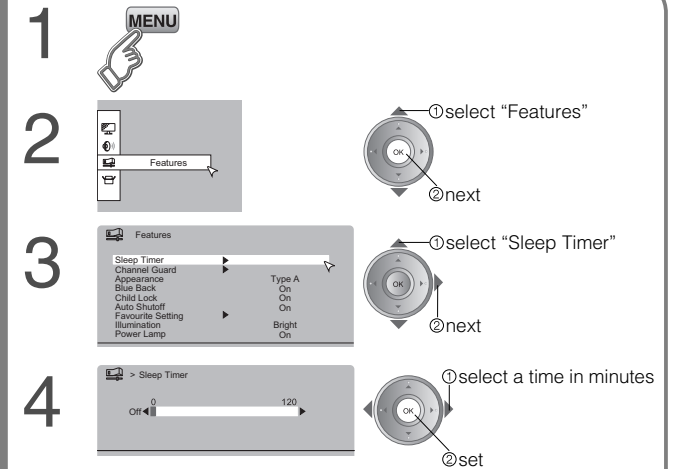

- Cancel ➔ Set the time to "0" in step 4
- Remaining time ➔ You can confirm the remaining time in step 4, after repeating this process.

● After steps 1 and 2 above

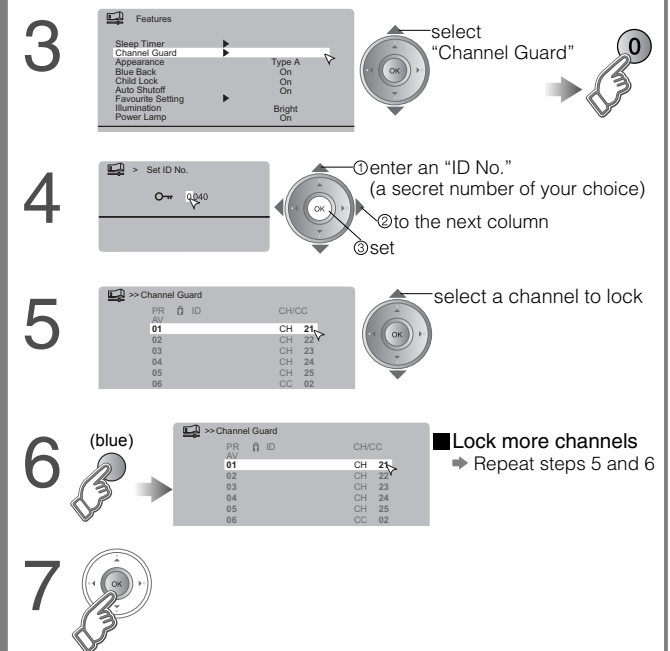

- Release a channel ➔ Press "(blue)" again in step 6
- View a locked channel ➔ Use the numerical buttons to enter the channel number. When appears, press "TOP MENU DISPLAY" and enter your "ID No.". (If you forget your "ID No." check it in step 4.)

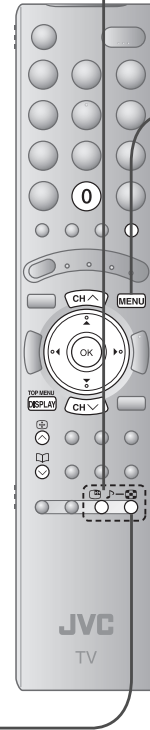

Stop children from watching specific channels

CHANNEL GUARD

IMPORTANT!

PREPARE

USE

SETTINGS

TROUBLE?

Useful functions (continued)

Register a channel to a button

FAVOURITE CHANNEL

- While the channel is displayed

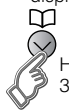



Hold down for 3 seconds

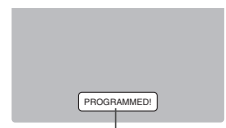

- Press the number to register it on



Disappears in a few seconds

Recall the favourite channel

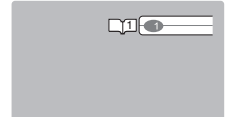
- 

- Press the number you registered



● Customizations (P. 18) to the picture of a favourite channel get saved as well.

Check your favourite channels

- Press **TOP MENU DISPLAY** and confirm that the channels you have registered have  marks beside them

Delete a favourite channel

- ➔ "MENU" ➔ " " ➔ "Features" ➔ "Favourite Setting"

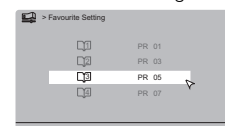
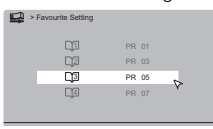

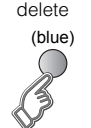
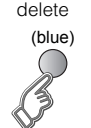
- delete (blue)

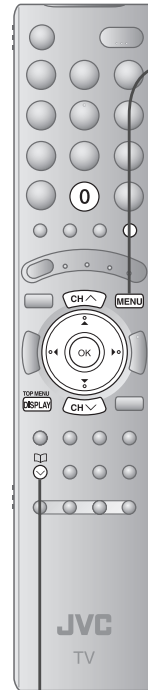





Displays a blue screen and mutes the sound when the signal is weak

BLUE BACK

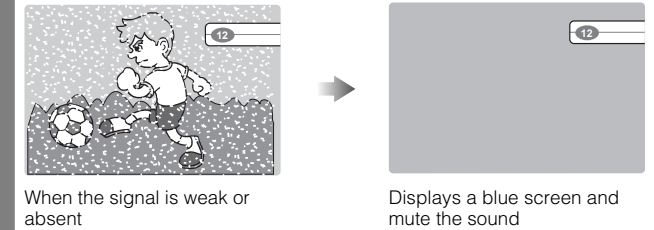
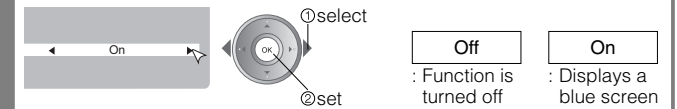
➔ "MENU" ➔ " " ➔ "Features" ➔ "Blue Back"



Set the power to turn off if no signal is received and no operation is performed

AUTO SHUTOFF

➔ "MENU" ➔ " " ➔ "Features" ➔ "Auto Shutoff"

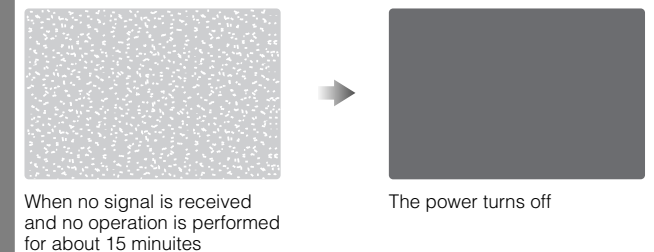
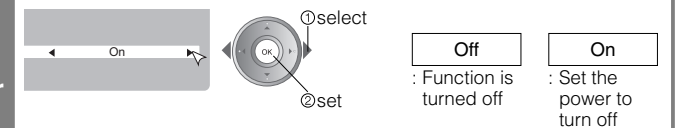

Prevent sudden increase or decrease of sound when changing channels

AI VOLUME

➔ "MENU" ➔ " " ➔ "Set Up" ➔ "AI Volume"

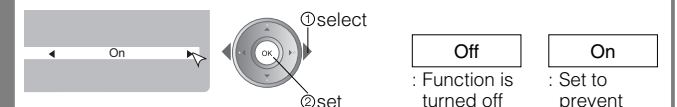

Operate JVC recorders and other devices

The included remote control can be used to operate JVC recorders and other devices.



1 Select a device

VCRs
DVD recorders
HDD recorders
Home theater system

MODE TV VCR/DVR DVD AUDIO

TV (P. 12) DVD players

TV → VCR/DVR
AUDIO ← DVD

● The indicator lights for 3 seconds each time the remote control is operated.

2 Turn on the device

Power button

3 Operate the device

● Other buttons can be used to operate the TV at any time.

Operate the VCR, DVD recorder or HDD recorder

VCR/DVR

Operate DVD / HDD recorder menus

Display top menu — DISPLAY

BACK — Back to previous menu

MENU — Display menu

Select

OK

Playback / Record etc.

F.T/L ? — Rewind / Playback / Fast-forward

Record / Stop / Pause

Select a chapter

Display the subtitle (DVD / HDD recorder mode) → TOP MENU DISPLAY

Operate DVD menus

Display top menu — DISPLAY

BACK — Back to previous menu

MENU — Display menu

Select

OK

Playback etc.

F.T/L ? — Rewind / Playback / Fast-forward

Stop / Pause

Select a chapter

Display the subtitle → TOP MENU DISPLAY

Operate AUDIO menus

Display top menu — DISPLAY

BACK — Back to previous menu

MENU — Display menu

Select

OK

Playback etc.

F.T/L ? — Rewind / Playback / Fast-forward

Stop / Pause

Select a chapter

Display the subtitle → TOP MENU DISPLAY

Mute →

Volume →

Select a surround mode →

Operate the DVD player

DVD

Operate the home theatre system

AUDIO

Try changing the remote control code if you cannot operate a recorder.

Code A or 1 (Default)



Code C or 3



- Confirm the code for your recorder by checking the manual it came with.
- Some models of JVC devices cannot be operated with this remote control.
- JVC DVD recorders and HDD recorders are set to code "C" or "3" by default.

Note

- If the battery is removed, the remote control code reverts back to code A or 1.

IMPORTANT!

PREPARE

USE

SETTINGS

TROUBLE?

Customizing your TV

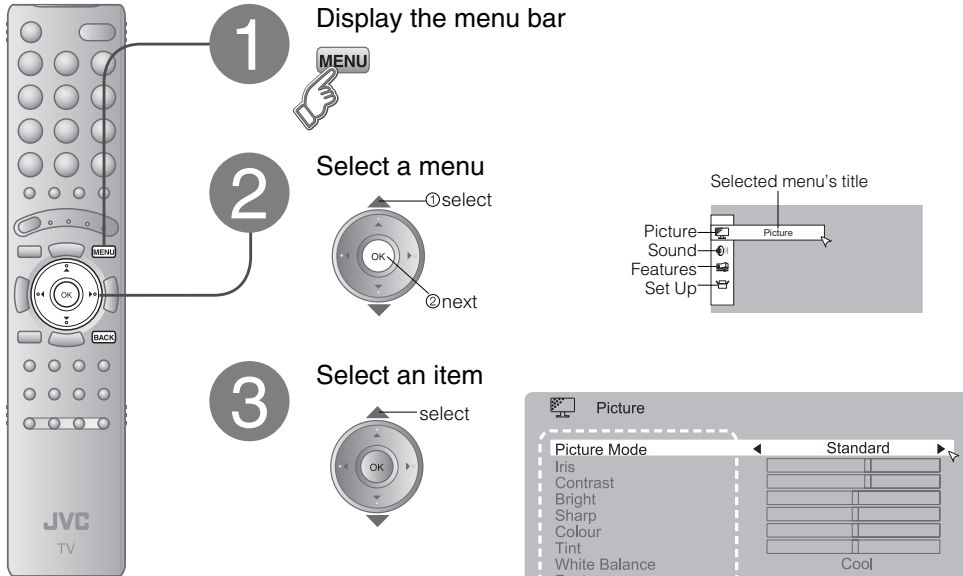

■ To the previous screen

→ **BACK**

■ Exit

→ **MENU**

● The menu disappears after one minute of inactivity.

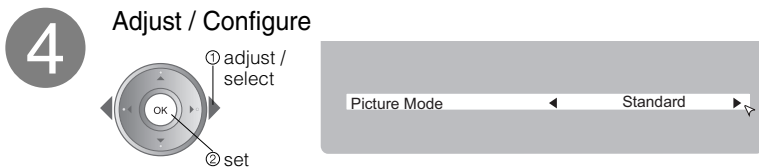

■ When adjusting with the sliding-bar

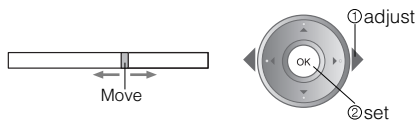

■ When selecting from presets



● Some items have a sub-menu.

Menu	Item	Adjustments / Configurations
Picture	Picture Mode	Picture mode (Bright / Standard / Soft)
	Iris	Adjust the amount of light projected on the screen (Darker ↔ Brighter)
	Contrast	Contrast (Lower ↔ Higher)
	Bright	Brightness (Darker ↔ Brighter)
	Sharp	Sharpness (Softer ↔ Sharper)
	Colour	Colour (Lighter ↔ Deeper)
	Tint	Tint for NTSC (Reddish ↔ Greenish)
	White Balance	Colour temperature (Warm / Mid / Cool)
	Features	Finer picture adjustments (P. 19)
Sound	Stereo / I · II	Mode / Language (○ : Mono / ∞ : Stereo / I : Sub1 / II : Sub2 / MONO)
	Bass	Low tones (Weaker ↔ Stronger)
	Treble	High tones (Weaker ↔ Stronger)
	Balance	Speaker balance (Left Stronger ↔ Right Stronger)
	Cinema Surround	Ambience level (High / Low / Mono / Off)
	MaxxBass *1	Emphasize the bass sound (Off / Low / High)
Features	Voice Enhancer	Sound enhancement technology (On / Off)
	Sleep Timer	Timer for turning off the TV (P. 15)
	Channel Guard	Stops children from watching specific channels (P. 15)
	Appearance	Format for displaying the channel number (TYPE A / TYPE B)
	Blue Back	Displays a blue screen and mutes the sound when the signal is weak or absent (P. 16)
	Child Lock	Disables the front control buttons of the TV (On / Off)
	Auto Shutoff	Set the power to turn off if no signal is received and no operation is performed for about 15 minutes. (P. 16)
Set Up	Favourite Setting	Clear favourite channel settings (P. 16)
	Illumination	Change the brightness of the Power lamp (P. 6) while the TV is on (Bright / Soft)
	Auto Program	Automatically registers channels (P. 8, ④)
	Edit / Manual	Change registered channels or add new ones (P. 9)
	Language	Select a language for on-screen menus (P. 8, ②)
	Video-1 Setting	For use with VCRs and other devices (P. 14)
	Video-3 Setting	For use with VCRs and other devices (P. 14)
	AI Volume	Prevent sudden increase or decrease of sound when changing channels (P. 16)
	Teletext Language	Select a language for Teletext programmes (P. 22)
	HDMI Setting	HDMI-1 : Size (1 / 2 / Auto) HDMI-2 : Size (1 / 2 / Auto) Audio (Digital / Analogue / Auto)
PC Position	PC position adjustment (P. 14)	
Lamp Timer Reset	Resets the lamp timer (P. 5)	



● Other settings · Change the aspect ratio → "ZOOM" (P. 12)
· Turn on "Cinema Surround" → "CINEMA SURROUND" (P. 12)



*1 MaxxBass is a registered trademark of Waves Audio Ltd. in the USA, Japan and other countries.

Advanced picture adjustment

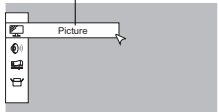
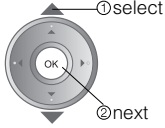
By default, the TV automatically adjusts itself for the best picture.

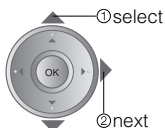
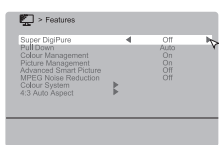
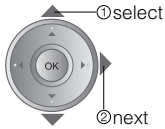

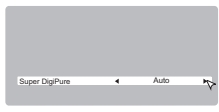
- 1 **Display the menu bar**

- 2 **Select "Picture"**

- 3 **Select "Features"**

- 4 **Select an item**





E.g. "Super DigiPure"
- 5 **Change settings**



E.g. "Super DigiPure"
- 6 **Finish**

To the previous screen
 → **BACK**

Exit
 → **MENU**

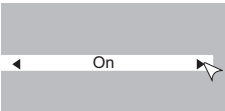
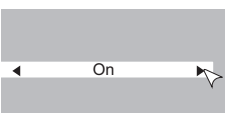
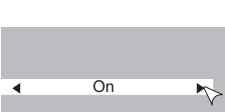
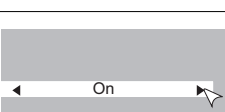
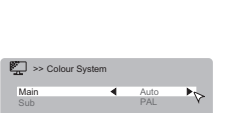
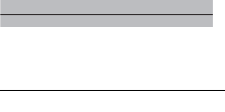
● The menu disappears after one minute of inactivity.

Super DigiPure	For smooth looking picture		<input type="button" value="Off"/> : Function is turned off <input type="button" value="Min"/> : When the picture loses sharpness <input type="button" value="Max"/> : When much noise appears <input type="button" value="Auto"/> : Automatically adjusts
Pull Down	For smoothing cinema film		<input type="button" value="Off"/> : Function is turned off <input type="button" value="On"/> : Function is always on <input type="button" value="Auto"/> : Automatically adjusts
Colour Management	For natural-looking pictures		<input type="button" value="Off"/> : Function is turned off <input type="button" value="On"/> : Maintains a natural colour balance
Picture Management	Fix bright / dark pictures		<input type="button" value="Off"/> : Function is turned off <input type="button" value="On"/> : Makes it easier to view bright / dark pictures
Advanced Smart Picture	Fix brightness of white areas		<input type="button" value="Off"/> : Function is turned off <input type="button" value="On"/> : Make it easier to view white areas ● Not available when "Picture Mode" is set to "Bright" (P. 18)
MPEG Noise Reduction	To reduce MPEG video noise		<input type="button" value="Off"/> : Function is turned off <input type="button" value="On"/> : When noise appears
Colour System	When there is no colour		① Select the screen to change settings for <input type="button" value="Main"/> : Main picture <input type="button" value="Sub"/> : Sub-picture in MULTI-PICTURE mode (P. 15) ② Select the colour system <input type="button" value="PAL"/> : PAL <input type="button" value="SECAM"/> : SECAM <input type="button" value="NTSC 3.58"/> : NTSC 3.58 <input type="button" value="NTSC 4.43"/> : NTSC 4.43 <input type="button" value="Auto"/> : Auto ● For colour system in your country or region. ➔ "Colour system in your country or region" (P. 22)
4:3 Auto Aspect	Set a default aspect ratio		Select a default aspect ratio for Auto in "Zoom" (P. 12) <input type="button" value="Panoramic"/> : Panoramic <input type="button" value="Regular"/> : Regular <input type="button" value="14:9 Zoom"/> : 14:9 Zoom <div style="display: flex; justify-content: space-around;"> <div style="border: 1px solid black; padding: 5px;">16 : 9</div> <div style="border: 1px solid black; padding: 5px;">4 : 3</div> <div style="border: 1px solid black; padding: 5px;">14 : 9</div> </div>

IMPORTANT!

PREPARE

USE

SETTINGS

TROUBLE?

Troubleshooting

Severe noise or snow



- Is the TV connected correctly to the aerial?
- Change the direction of the aerial.
- Is the aerial or its cable damaged?
- ➔ Consult your retailer

Patterns, stripes or noise



- Is the aerial receiving interference from high-voltage power lines or wireless transmitters?
- ➔ Consult your retailer
- Are connected devices too close to the TV?
- ➔ Insert the minimum distance between the aerial and the cause of interference until no interference

Ghosting

(Doubling of images)



- Are you receiving interference from signals reflected off mountains or buildings?
- ➔ Adjust the direction of your aerial, or change to a good-quality directional aerial

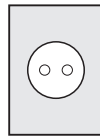
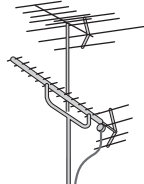
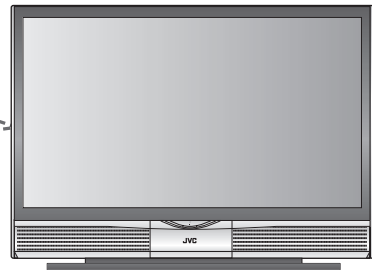

I can't turn it on!

- Is the power cord connected to the AC outlet correctly?

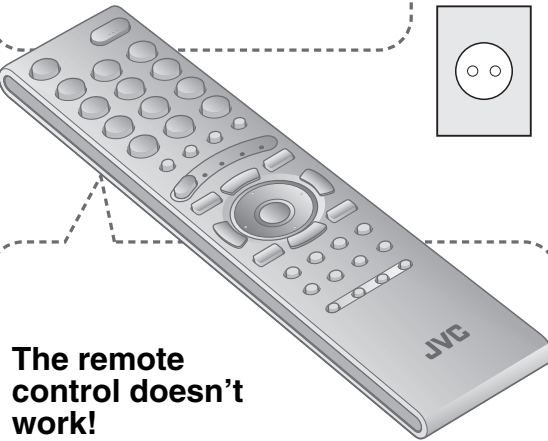

The remote control doesn't work!

- Are the batteries flat?
- Are you more than 7 metres away from the TV?
- Is the "MODE (TV, VCR/DVR, DVD, AUDIO)" set to "TV"?
- When viewing teletext, the TV menu bar does not appear.
- Depending on the stability of the signal, there may be a time lag when changing channels.

	Problem	Actions	page
Basics	Remote control stops working	● Unplug the TV, and wait about 1 hour until the lamp completely cooled. Then plug the TV in again. (Turning on the TV soon may shorten the lamp life.)	—
	Front control buttons do not work	● Switch "Child Lock" to "Off."	18
	Aspect ratio changes unintentionally	● Press "ZOOM" to return to your settings.	12
Screen	Black or white dots appear on the screen	● Although the HD-ILA element is manufactured with high-precision technology, please understand that some pixels may be lost or permanently displayed.	—
	PC screen alignment is off	● Adjust the "PC Position."	14
	The screen is dim	● Adjust the "Iris" brighter.	18
	Poor picture quality	<ul style="list-style-type: none"> ● Unnatural colour >>> Adjust "Colour" and "Bright." Check your "Colour System." If "Auto" is selected, select the specific colour system manually. ● Noise >>> Set to the following functions. Picture Mode : Standard Super DigiPure : Max ● Dull picture >>> Set to the following functions. Picture Mode : Bright Super DigiPure : Min 	18 19 — 18 19
Picture	Strange picture when using an external device	<ul style="list-style-type: none"> ● If the top of the image is distorted, check the video signal quality itself. ● If movement appears unnatural when receiving a signal from a DVD player, etc. with 625p (progressive-scanning), change the output setting of the external device to 625i (interlace-scanning). 	— —
	Blue screen appears on the screen	● Switch "Blue Back" to "Off."	16

	Problem	Actions	page
Sound	Poor sound	<ul style="list-style-type: none"> Adjust the "Bass" and "Treble." If receiving a poor signal in "Stereo / I · II", switch to "Mono." Adjust the channel reception using "Manual." 	18 18 9
	"Voice Enhancer" does not work	<ul style="list-style-type: none"> "AI Volume" makes the effect of "Voice Enhancer" weak. Switch "AI Volume" to "Off." 	18
	Wrong screen size	<ul style="list-style-type: none"> Switch "Size" in "HDMI Setting" to "1" or "2." 	18
	No picture, no sound	<ul style="list-style-type: none"> Use the cable with HDMI logo. HDMI 	—
HDMI	No sound	<ul style="list-style-type: none"> Check if the device is compliant with HDMI. Switch "Audio" in "HDMI Setting" to "Digital" or "Auto" for HDMI devices, or "Analogue" or "Auto" for DVI devices. (Not available for HDMI-2) 	— 18
	Green and distorted screen	<ul style="list-style-type: none"> Wait a little for the signal to stabilize when switching the signal format for an "HDMI" device. 	—
	Some functions do not work	<ul style="list-style-type: none"> It is not a malfunction. Some functions (dark background) in the menu do not work depending on the situation. 	—
Functions	Some inputs cannot be selected in the sub-picture	<ul style="list-style-type: none"> "VIDEO-1 (Component signal)", "VIDEO-3 (Component signal)", "HDMI-1", "HDMI-2" inputs and PC mode cannot be selected in the sub-picture. 	—
	No picture, no sound	<ul style="list-style-type: none"> Some inputs are not output from the OUT terminal. 	14

	Problem	Actions	page
Lamp	The LAMP indicator blinks rapidly	<ul style="list-style-type: none"> Keep the TV off for a while and then turn the power on again. If the TV goes into warning mode, unplug the TV after the cooling has completed and consult your retailer. (It may be a malfunction of the internal electrical circuits.) 	—
	The power lamp and LAMP indicator blink alternately	<ul style="list-style-type: none"> Keep the TV off for a while and then turn the power on again. If the TV goes into warning mode, unplug the TV after the cooling has completed and consult your retailer. (The internal temperature rises abnormally or the fan may be blocked.) 	—
	The power lamp and LAMP indicator blink rapidly simultaneously	<ul style="list-style-type: none"> If this condition occurs soon after replacing the lamp, reinstall the new lamp unit. (The lamp unit may not be inserted into the lamp housing correctly.) Repeat the lamp installation steps, taking care to observe all warnings. <ul style="list-style-type: none"> Make sure the lamp sits flat inside the housing area. Make sure the lamp cover is reinstalled. If this condition occurs except for replacing the lamp, keep the TV off for a while and then turn the power on again. If the TV goes into warning mode, unplug the TV after the cooling has completed and consult your retailer. (It may be a lamp malfunction.) 	6 —

IMPORTANT!

PREPARE

USE

SETTINGS

TROUBLE?

Technical information

Language group for teletext

Group	Languages
Group-1	Turkish, Hungarian, English, German, French, Italian, Spanish, Portuguese, Greek, Swedish, Finnish
Group-2	Polish, Serbian, Croatian, Slovenian, Czech, Slovak, Rumanian, Hungarian, German, French, Italian, Swedish, Finnish
Group-3	Russian, Bulgarian, Lettish, Lithuanian, Estonian, Ukrainian, Serbian, Croatian, Slovenian, Czech, Slovak, English, German
Group-4	Arabic, Czech, Slovak, Hungarian, English, German, French, Italian, Spanish, Portuguese, Swedish, Finnish
Group-5	Farsi, Czech, Slovak, Hungarian, English, German, French, Italian, Spanish, Portuguese, Swedish, Finnish

● If the characters are unreadable. ➔ Select different teletext language group.

Colour system in your country or region

Area	Country or Region	System
Asia, Middle East	Bahrain, Kuwait, Oman, Qatar, United Arab Emirates, Yemen, etc. Indonesia, Malaysia, Singapore, Thailand, India, etc.	PAL
	China, Vietnam, etc.	
	Hong Kong, etc.	SECAM
	Islamic Republic of Iran, Lebanon, Saudi Arabia, etc.	
	Philippines, Taiwan, Myanmar, etc.	
Europe	Russia, etc.	SECAM
	Czech Republic, Poland, etc.	PAL
	Germany, Holland, Belgium, etc.	
	UK, etc.	
Oceania	Australia, New Zealand, etc.	PAL
	Republic of South Africa, etc.	PAL
Africa	Nigeria, etc.	
	Egypt, Morocco, etc.	SECAM

Sound system in your country or region

Area	Country or Region	System
Asia, Middle East	Bahrain, Kuwait, Oman, Qatar, United Arab Emirates, Yemen, etc. Indonesia, Malaysia, Singapore, Thailand, India, etc.	B/G
	China, Vietnam, etc.	D/K
	Hong Kong, etc.	I
	Islamic Republic of Iran, Lebanon, Saudi Arabia, etc.	B/G
	Philippines, Taiwan, Myanmar, etc.	M
Europe	Russia, etc.	D/K
	Czech Republic, Poland, etc.	B/G
	Germany, Holland, Belgium, etc.	
	UK, etc.	
Oceania	Australia, New Zealand, etc.	B/G
	Republic of South Africa, etc.	I
Africa	Nigeria, etc.	B/G
	Egypt, Morocco, etc.	

Monoaural sound

Use this function when stereo sound or bilingual sound is hard to hear.

● Set "Stereo / I · II" to "Mono." ➔ (P. 18)

PC Signals that can be displayed

● If the signal doesn't appear, check that the vertical frequency on the PC is set to 60 Hz.

Resolution	640 x 480 (VGA)	1024 x 768 (XGA)
Vertical frequency (Hz)	60.0	60.0
Horizontal frequency (kHz)	31.5	48.4

Connect DVI devices

Connect a "DVI" device to "HDMI-1" using "DVI-HDMI" conversion cable. Connect analogue sound output of the DVI device to L and R terminals in IN HDMI-1.

- Set "Audio" in "HDMI Setting" to "Analogue" or "Auto" ➔ (P. 18)
- HDMI-2 input does not support analogue sound (IN HDMI-1).
- HDMI-2 input does not support DVI devices.

CH/CC List

To use the INSERT function (P. 9), find the "CH/CC" number corresponding to the TV's Channel number from this table.

- US: The US channel numbers are the channel numbers used in the United States, Philippines, etc.
- CCIR: The CCIR channel numbers are the channel numbers used in the Middle East, Southeast Asia, etc.
- OIRT: The OIRT channel numbers are the channel numbers used in Eastern Europe, Russia, Vietnam, etc.
- AUSTRALIA: The AUSTRALIA channel numbers are the channel numbers used in Australia, etc.

CH	Channel			
	US	CCIR	OIRT	AUSTRALIA
CH 02	US-02	E2	R1	AU-0
CH 03	US-03	E3		AU-1
CH 04	US-04	E4	R2	AU-2
CH 05	US-05	E5	R6	AU-6
CH 06	US-06	E6	R7	AU-7
CH 07	US-07	E7	R8	AU-8
CH 08	US-08	E8	R9	AU-9
CH 09	US-09	E9		
CH 10	US-10	E10	R10	AU-10
CH 11	US-11	E11	R11	AU-11
CH 12	US-12	E12	R12	
CH 13	US-13			
CH 14	US-14, W+29			
CH 15	US-15, W+30			
CH 16	US-16, W+31			
CH 17	US-17, W+32			
CH 18	US-18, W+33			
CH 19	US-19, W+34			
CH 20	US-20, W+35			
CH 21	US-21, W+36	E21		
CH 22	US-22, W+37	E22		
CH 23	US-23, W+38	E23		
CH 24	US-24, W+39	E24		
CH 25	US-25, W+40	E25		
CH 26	US-26, W+41	E26		
CH 27	US-27, W+42	E27		
CH 28	US-28, W+43	E28		
CH 29	US-29, W+44	E29		
CH 30	US-30, W+45	E30		
CH 31	US-31, W+46	E31		
CH 32	US-32, W+47	E32		
CH 33	US-33, W+48	E33		
CH 34	US-34, W+49	E34		
CH 35	US-35, W+50	E35		
CH 36	US-36, W+51	E36		
CH 37	US-37, W+52	E37		
CH 38	US-38, W+53	E38		
CH 39	US-39, W+54	E39		
CH 40	US-40, W+55	E40		
CH 41	US-41, W+56	E41		
CH 42	US-42, W+57	E42		
CH 43	US-43, W+58	E43		
CH 44	US-44, W+59	E44		
CH 45	US-45, W+60	E45		
CH 46	US-46, W+61	E46		
CH 47	US-47, W+62	E47		
CH 48	US-48, W+63	E48		
CH 49	US-49, W+64	E49		
CH 50	US-50, W+65	E50		
CH 51	US-51, W+66	E51		
CH 52	US-52, W+67	E52		
CH 53	US-53, W+68	E53		
CH 54	US-54, W+69	E54		
CH 55	US-55, W+70	E55		
CH 56	US-56, W+71	E56		
CH 57	US-57, W+72	E57		
CH 58	US-58, W+73	E58		
CH 59	US-59, W+74	E59		
CH 60	US-60, W+75	E60		
CH 61	US-61, W+76	E61		
CH 62	US-62, W+77	E62		
CH 63	US-63, W+78	E63		
CH 64	US-64, W+79	E64		
CH 65	US-65, W+80	E65		
CH 66	US-66, W+81	E66		
CH 67	US-67, W+82	E67		
CH 68	US-68, W+83	E68		
CH 69	US-69, W+84	E69		

CC	Channel			
	US	CCIR	OIRT	AUSTRALIA
CC 01		S-1		AU-5
CC 02		S-2		
CC 03		S-3		
CC 04		S-4		
CC 05		S-5		
CC 06		S-6		AU-5A
CC 07		S-7		
CC 08		S-8		
CC 09		S-9		
CC 10		S-10		
CC 11		S-11		
CC 12		S-12		
CC 13		S-13		
CC 14	A	S-14		
CC 15	B	S-15		
CC 16	C	S-16		
CC 17	D	S-17		
CC 18	E	S-18		
CC 19	F	S-19		
CC 20	G	S-20		
CC 21	H	S-21		
CC 22	I	S-22		
CC 23	J	S-23		
CC 24	K	S-24		
CC 25	L	S-25		
CC 26	M	S-26		
CC 27	N	S-27		
CC 28	O	S-28		
CC 29	P	S-29		
CC 30	Q	S-30		
CC 31	R	S-31		
CC 32	S	S-32		
CC 33	T	S-33		
CC 34	U	S-34		
CC 35	V	S-35		
CC 36	W	S-36		
CC 37	W+1	S-37		
CC 38	W+2	S-38		
CC 39	W+3	S-39		
CC 40	W+4	S-40		
CC 41	W+5	S-41		
CC 42	W+6			
CC 43	W+7			
CC 44	W+8			
CC 45	W+9			
CC 46	W+10			
CC 47	W+11			
CC 48	W+12			
CC 49	W+13			
CC 50	W+14			
CC 51	W+15			
CC 52	W+16			
CC 53	W+17			
CC 54	W+18			
CC 55	W+19			
CC 56	W+20			
CC 57	W+21			
CC 58	W+22			
CC 59	W+23			
CC 60	W+24			
CC 61	W+25			
CC 62	W+26			
CC 63	W+27			
CC 64	W+28			
CC 75		X		
CC 76		Y	R3	
CC 77		Z	R4	AU-3
CC 78		Z+1	R5	
CC 79		Z+2		AU-4
CC 95	A-5			
CC 96	A-4			
CC 97	A-3			
CC 98	A-2			
CC 99	A-1			

Specifications

Main unit

Model	HD-Z70RF7	HD-Z61RF7	HD-Z56RF7
Broadcasting systems	B / G / I / D / K / K1 / M (See "Technical information", P. 22)		
Colour systems	PAL, SECAM, NTSC 3.58/4.43MHz		
Channels and frequencies	VHF low channel (VL) = 46.25 to 140.25 MHz VHF high channel (VH) = 147.25 to 423.25 MHz UHF channel (U) = 431.25 to 863.25 MHz · Receives cable channels in mid band (X to Z+2, S1 to S10), super band (S11 to S20) and hyper band (S21 to S41).		
Sound-multiplex systems	NICAM (I / B / G / D / K), A2 (B / G / D / K)		
Teletext systems	FLOF (Fastext), WST (standard system)		
Power requirements	AC 110 V - 240 V, 50/60 Hz		
Audio output (Rated power output)	10 W + 10 W		
Speakers	10 cm round x 2	(8.5 x 12.5cm) oval x 2	
Power consumption [standby]	195 W [0.9 W]		
Screen size (visible area size measured diagonally)	178 cm	155 cm	142 cm
Dimensions (W x H x D: mm)	1626 x 1167 x 519	1403 x 1015.5 x 483.6	1292 x 943.5 x 449.8
Weights	72 kg	44 kg	40 kg
Accessories	(See "Check accessories", P. 6)		

Terminals / Connectors

	Terminal name	Terminal type	Signal type (IN)	Signal type (OUT)
Input terminals	VIDEO-1	RCA connectors x 6 S-VIDEO connector x 1	Composite video, S-video, Analogue component (576i (625i) / 480i (525i), Progressive : 576p (625p) / 480p (525p), HD : 1080i (1125i), 720p (750p)) Audio L / R	
	VIDEO-2	RCA connectors x 3, S-VIDEO connector x 1	Composite video, S-video, Audio L / R	
	VIDEO-3	RCA connectors x 6	Composite video, Analogue component (576i (625i) / 480i (525i), Progressive : 576p (625p) / 480p (525p), HD : 1080i (1125i), 720p (750p)) Audio L / R	
	VIDEO-4	RCA connectors x 3, S-VIDEO connector x 1	Composite video, S-video, Audio L / R	
	HDMI-1	HDMI connector x 2	HDMI (576i (625i) / 480i (525i) / 576p (625p) / 480p (525p), 1080i (1125i), 720p (750p))	
	HDMI-2			
	IN HDMI-1	RCA connectors x 2	Audio L / R	
PC IN	D-SUB (15 pins) x 1	Analogue PC signal (P. 22)		
Output terminals	OUT	RCA connectors x 3, S-VIDEO connector x 1		Composite video, S-video, Audio L / R
	Headphone	Stereo mini-jack x 1 (3.5 mm in diameter)		Headphone output

● We may change the design and specifications without notice.

Demonstration

To start the demonstration:

Press the **MENU** button to display the menu bar. Then press the yellow button.

Select DEMO 1 (Super Digipure), DEMO 2 (Maxx Bass) or DEMO 3 (Iris Meter) from the DEMO MODE menu.

Press the **▼/▲** buttons, then press the **OK** button.

To quit the demonstration:

Press the yellow button, **BACK** button, **CHANNEL** **▼/▲** buttons or any of the number buttons.

JVC

Free Manuals Download Website

<http://myh66.com>

<http://usermanuals.us>

<http://www.somanuals.com>

<http://www.4manuals.cc>

<http://www.manual-lib.com>

<http://www.404manual.com>

<http://www.luxmanual.com>

<http://aubethermostatmanual.com>

Golf course search by state

<http://golfingnear.com>

Email search by domain

<http://emailbydomain.com>

Auto manuals search

<http://auto.somanuals.com>

TV manuals search

<http://tv.somanuals.com>