

JVC

ENGLISH

D.I.S.T.
Digital Image Scaling Technology

LT-Z32SX4B
LT-Z26SX4B
LT-Z32SX4S
LT-Z26SX4S

CINEMA
SURROUND

WIDE LCD PANEL TV

INSTRUCTIONS

LCT1732-001A-H

Thank you for buying this JVC LCD flat television.

To make sure you understand how to use your new TV, please read this manual thoroughly before you begin. ("LCD" stands for Liquid Crystal Display.)

WARNING: TO PREVENT FIRE OR SHOCK HAZARD, DO NOT EXPOSE THIS APPLIANCE TO RAIN OR MOISTURE.

WARNING

- Fingers may be trapped under the TV causing injuries. Hold the TV at the bottom in the middle, and do not allow it to tilt up or down.

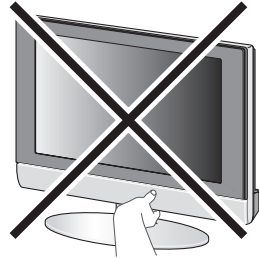

WARNING

- The TV may fall causing injuries. Hold the bottom of the stand with your hand and tilt the TV up and down.
- Do not allow children to hang from the TV, place their elbows on the TV or lean against the TV. Doing so may cause the TV to fall over and lead to injuries.

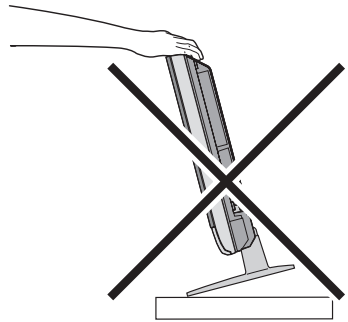

CAUTION

- The TV screen may be damaged if the TV is carried as shown in the diagram below. The TV should always be carried by two people.

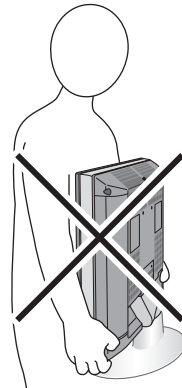

Pixel defects

LCDs use collections of fine points (“pixels”) to display images. While there is no problem with more than 99.99% of these pixels, please understand that a very small number of pixels may not light, or may light all the time.

Distance recommendations

Avoid improper installation and never position the unit where good ventilation is impossible.

When installing this TV, distance recommendations must be maintained between the set and the wall, as well as inside a tightly enclosed area or piece of furniture. Keep to the minimum distance guidelines shown for safe operation.

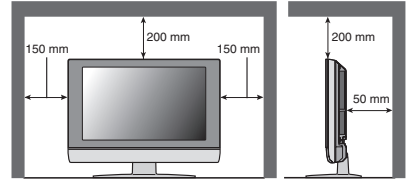

Failure to take the following precautions may cause damage to the television or remote control.

DO NOT block the TV’s ventilation openings or holes.

(If the ventilation openings or holes are blocked by a newspaper or cloth, etc., the heat may not be able to get out.)

DO NOT place anything on top of the TV.

(such as cosmetics or medicines, flower vases, potted plants, cups, etc.)

DO NOT allow objects or liquid into the cabinet openings.

(If water or liquid is allowed to enter this equipment, fire or electric shock may be caused.)

DO NOT place any naked flame sources, such as lighted candles, on the TV.

DO NOT subject the TV to direct sunlight.

The surface of the TV screen is easily damaged. Be very careful with it when handling the TV. Should the TV screen become soiled, wipe it with a soft dry cloth. Never rub it forcefully. Never use any cleaner or detergent on it.

If there is a fault, unplug the unit and call a service technician. Do not attempt to repair it yourself or remove the rear cover.

■ Cleaning the screen

The screen is coated with a special thin film to reduce reflection. If this film is damaged, uneven colours, discolouration, scratches, and other problems that cannot be repaired may occur. Pay attention to the following when handling the screen.

- Do not use glue or adhesive tape on the screen.
- Do not write on the screen.
- Do not allow the screen to come in contact with any hard objects.
- Do not allow condensation to form on the screen.
- Do not use alcohol, thinner, benzene or other solvents on the screen.
- Do not rub the screen hard.

CAUTION:

- Operate only from the power source specified (AC 110 – 240 V, 50/60 Hz) on the unit.
 - Avoid damaging the AC plug and power cord.
 - When you are not using this unit for a long period of time, it is recommended that you disconnect the power cord from the main outlet.
-

D.I.S.T. demonstration

To start the D.I.S.T. demonstration:

Press the **MENU** button to display the menu bar. Then press the yellow button.

A picture split in two (D.I.S.T. turned on and D.I.S.T. turned off) will appear on the screen.

To quit the D.I.S.T. demonstration:

Press the yellow button, **BACK** button, **CHANNEL** \vee/\wedge buttons or any of the number buttons.

CONTENTS

Setting up your TV	5	PICTURE menu	25
Installation.....	5	PICTURE MODE.....	25
Using the stand.....	5	BACK LIGHT.....	25
Removing the terminal covers	6	CONTRAST	25
Connecting the aerial and video cassette recorder (VCR).....	7	BRIGHT.....	25
Connecting the power cord to the AC outlet.....	8	SHARP.....	25
Putting the batteries into the remote control.....	8	COLOUR.....	25
Initial settings (Setup tour)	8	TINT	25
TV buttons and functions.....	10	WHITE BALANCE.....	25
Turn the TV on from standby mode	10	FEATURES	26
Choose a TV channel	10	SOUND menu	29
Adjust the volume	10	STEREO / I • II	29
Using the Menu.....	10	BASS.....	29
Remote control buttons and functions.....	11	TREBLE	29
Turn the TV on or off from standby mode ..	11	BALANCE	29
Choose a TV channel and watch images from external devices	12	CINEMA SURROUND	29
Adjust the volume	13	A.H.B. (Active Hyper Bass).....	29
Display function.....	13	BBE	30
ZOOM function.....	14	FEATURES menu.....	31
CINEMA SURROUND function.....	15	SLEEP TIMER	31
Using the “Freeze” function.....	15	CHANNEL GUARD	31
Using the “Multi-picture” function	16	APPEARANCE.....	33
RETURN PLUS function and Return function.....	17	BLUE BACK.....	33
Favourite channel function.....	18	CHILD LOCK.....	33
Operating a JVC brand DVD player.....	19	AUTO SHUTOFF	33
Teletext function	20	FAVOURITE SETTING	33
Basic operation	20	SET UP menu	34
Using the List Mode	20	AUTO PROGRAM.....	34
Hold.....	21	EDIT/MANUAL	34
Sub-page	21	LANGUAGE	38
Reveal.....	21	VIDEO-1 SETTING/VIDEO-3 SETTING	38
Size.....	21	AI VOLUME.....	38
Index	22	TELETEXT LANGUAGE	39
Cancel.....	22	Displaying a computer screen.....	40
Using the TV’s menu.....	23	Connecting to the computer	40
Basic operation	23	Watching images from a computer	40
		Table of signals for each type of computer.....	40
		Additional preparation	41
		Connecting external equipment	41
		CH/CC numbers	44
		Troubleshooting	45
		Specifications	47

Setting up your TV

- When you install the TV on the wall, only use a JVC wall mounting unit (optional) which is designed for this TV.
- Make sure that the TV is installed on the wall by a skilled installer.

Installation

Cautions for installation

- Install the TV in a corner on a wall or on the floor so as to keep cords out of the way.
- The TV will generate a slight amount of heat during operation. Ensure that sufficient space is available around the TV to allow satisfactory cooling. See “Distance recommendations” on page 2.

Using the stand

This TV comes with a table top stand already attached.

This stand can be used to adjust the direction of the TV screen 5° up, 10° down, and 20° to the left or right.

■ Tilt the TV up and down:

While holding the bottom of the stand with one hand, use your other hand to hold the middle of the top of the TV and slowly tilt the TV up and down.

- As a safety measure, the stand is constructed so that it requires a certain amount of force to tilt the TV.

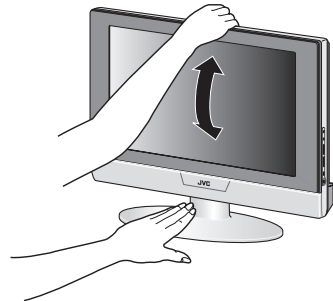

■ Rotate the TV to the left and right:

While holding the bottom of the stand with one hand, use your other hand to hold the edge of the panel and slowly adjust the direction of the TV screen.

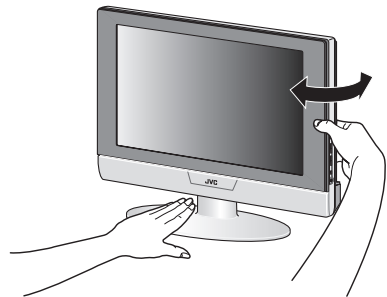

■ Cable holder

A cable holder which is used to keep the connection cables tidy is attached to the back of the stand. Gently squeeze the left and right of the cable holder and pull it to remove it from the stand. After putting the cables in the cable holder, attach it to the back of the stand again.

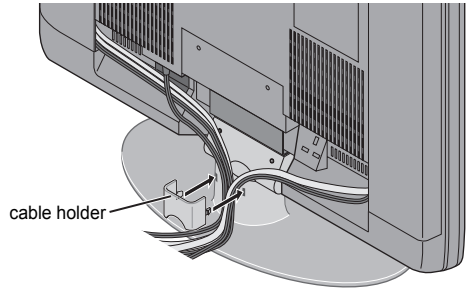

Removing the terminal covers

There are connection terminals behind the covers on the left and right of the rear of the TV. Remove these two covers before connecting an antenna or VCR.

Remove the covers by removing the hooks. When replacing the covers, place the side of the covers against the TV and insert the hooks.

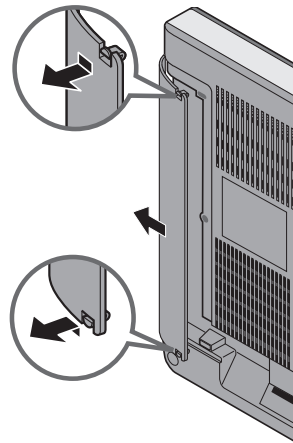

- Leave the covers off if they do not fit properly. Do not force to replace the covers. Doing so may cause damage to the connection cables and the covers.

Connecting the aerial and video cassette recorder (VCR)

Caution

- Turn off all the equipment including the TV before connecting anything.
- Aerial cable is not supplied. Use a good quality 75-ohm coaxial cable.
- Read the manual that came with the VCR before connecting.

If not connecting a VCR (follow ①):
Connect an aerial cable to the aerial socket on this TV.

If connecting a VCR:

1 Connect the aerial cable to the aerial input socket on the VCR, and connect the VCR and TV with another aerial cable

2 Connect the VCR's VIDEO OUT (video output) terminal and the TV's VIDEO terminal with a video cable

To connect a VCR to the TV with an S-VIDEO cable:

Connect the VCR's S-VIDEO OUT (S-VIDEO output) terminal and TV's S VIDEO terminal with an S-VIDEO cable (A), instead of connecting with a video cable.

Note that the connection with a video cable will be ignored in case you connect a VCR to the TV with both video cable and S-VIDEO cable.

3 Connect the VCR's VIDEO OUT (audio L/R output) terminals and the TV's AUDIO terminals with an audio cable

- To connect additional external devices, please see "Connecting external equipment" on page 41.

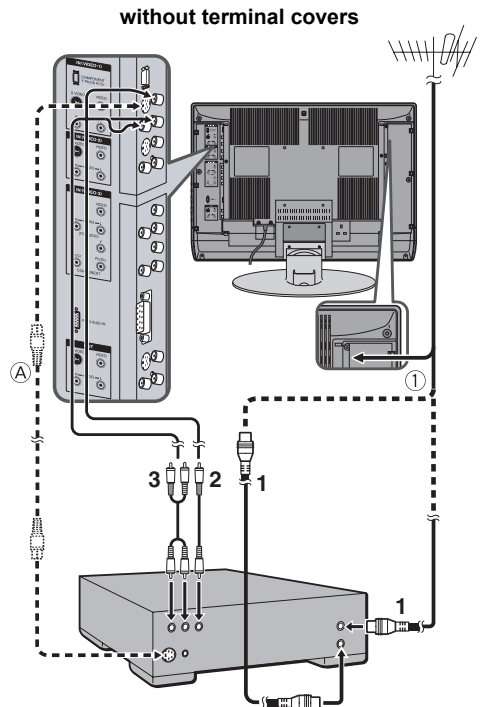

Connecting the power cord to the AC outlet

Insert the AC plug on the power cord from the TV into AC outlet.

Caution

- Operate only from the power source specified (AC 110 – 240 V, 50/60 Hz) on the unit.
- Remove the AC plug from the outlet to completely disconnect the TV from the power supply.

Putting the batteries into the remote control

Use two AA/R6 dry cell batteries. Insert the batteries from the ⊖ end, making sure the ⊕ and ⊖ polarities are correct.

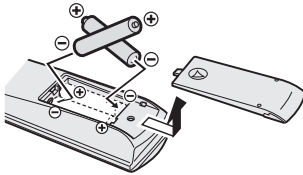

- Follow the warnings printed on the batteries.
- Battery life is about six months to one year, depending on how much you use the remote control.
- The batteries we supply are only for setting up and testing your TV, please replace them as soon as you need to.
- If the remote control does not work properly, replace the batteries.

Initial settings (Setup tour)

When the TV is first turned on, it goes into the initial settings mode, and you will see the JVC logo. Follow the instructions on the screen display to make the initial settings.

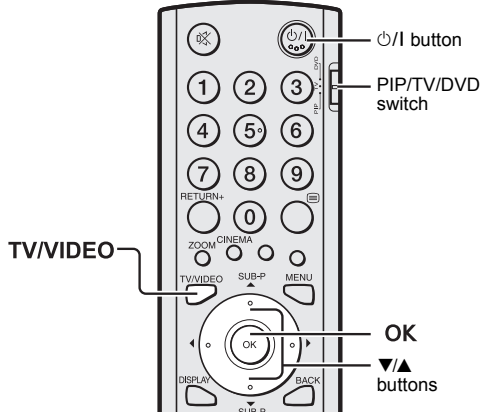

1 Make sure to set the PIP/TV/DVD switch on the remote control to the TV position

- You cannot turn the TV on when the PIP/TV/DVD switch is set to the DVD position.

2 Press the ⏻/⏹ button on the remote control

The TV turns on from standby mode and the JVC logo is displayed.

- Check that the AC plug on the power cord from the TV is connected to AC outlet.

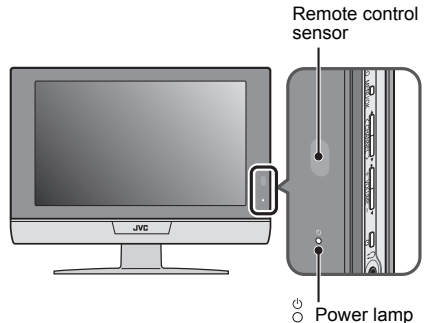

- If the JVC logo does not appear this is because your TV has already been turned on for the first time: use the “LANGUAGE”, “TELETEXT LANGUAGE” and “AUTO PROGRAM” functions to make the initial settings. For details, see “SET UP menu” on page 34.

3 Press the OK button

The LANGUAGE menu appears.

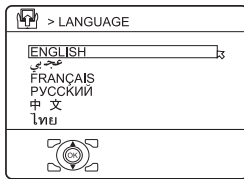

D0002(E)-EN

4 Press the ▼/▲ buttons to choose ENGLISH. Then press the OK button

The TELETEXT LANGUAGE menu appears. Set the teletext language group that corresponds to the language of the teletext programme that you want to watch. For details, see “TELETEXT LANGUAGE” on page 39.

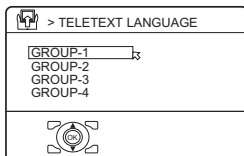

D1003-EN

- ### 5 Press the ▼/▲ buttons to choose a group. Then press the OK button
- The AUTO PROGRAM function starts. The TV channels you receive are automatically stored in the programme numbers (PR) list.

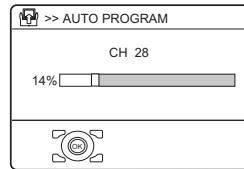

D0004-EN

- To stop the AUTO PROGRAM function, press the OK button.

- ### 6 After the TV channels have been registered in the programme numbers (PR), the EDIT menu appears

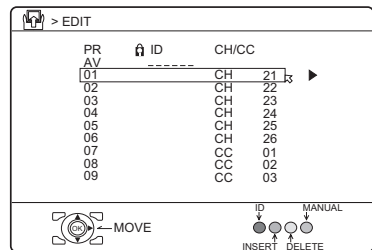

D0038-EN

- You can proceed to edit the programme numbers (PR) list using the EDIT/MANUAL function. For details, see “EDIT/MANUAL” on page 34.
- If a TV channel you want to view is not stored in the programme numbers (PR) list, you can register it using the MANUAL function. For details, see “EDIT/MANUAL” on page 34.
- The AUTO PROGRAM function does not store a TV channel to the programme number PR 0 (AV).
- If you do not need to use the EDIT/MANUAL function, press the OK button to close the EDIT menu.

Now, setting up is complete. Please enjoy your new JVC TV!

TV buttons and functions

ENGLISH

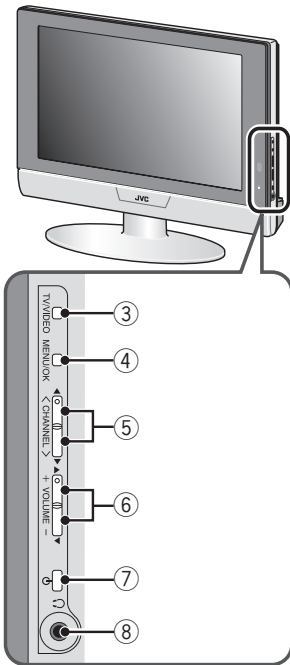
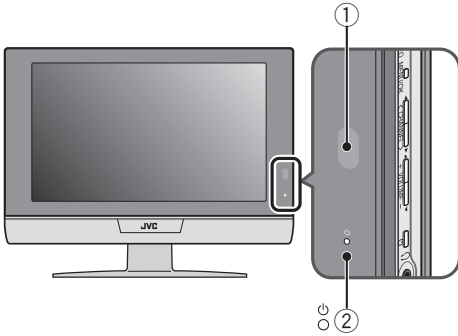

Refer to the pages in parentheses for details.

- ① Remote control sensor
- ② Power lamp (page 8)
- ③ TV/VIDEO button
- ④ MENU/OK button (page 23)
- ⑤ CHANNEL ∇/\blacktriangle buttons
 $\blacktriangledown/\blacktriangle$ (page 23)
- ⑥ VOLUME $-/+$ buttons
 $\blacktriangleleft/\blacktriangleright$ (page 23)
- ⑦ ⏻ (Stand by) button
- ⑧ Headphone jack (mini jack) (page 41)

Turn the TV on from standby mode

Press the ⏻ button or the CHANNEL ∇/\blacktriangle buttons to turn the TV on from standby mode.

When the TV is turned on, the power lamp lights blue.

To turn the TV off:

Press the ⏻ button again.
The power lamp goes off.

Caution

- The ⏻ button on the TV does not fully isolate the TV from the AC supply. If you are not going to use the TV for a long period, be sure to disconnect the AC plug from the AC socket.

Choose a TV channel

Press the CHANNEL ∇/\blacktriangle buttons to choose a programme number (PR) or a VIDEO terminal

Press the TV/VIDEO button to choose a VIDEO terminal.

Adjust the volume

Press the VOLUME $-/+$ buttons

The volume level indicator appears.

Using the Menu

Use the MENU/OK button

Refer to “Using the TV’s menu” (see page 23) for details of using the menu.

Remote control buttons and functions

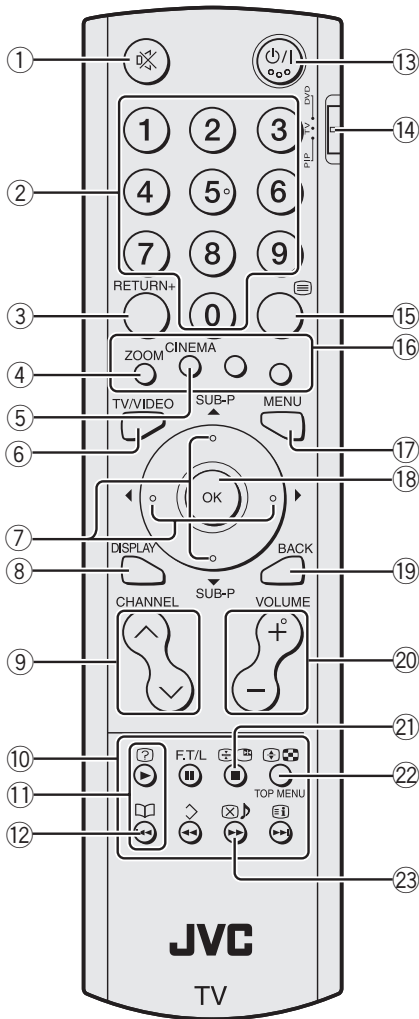

- ① Muting button
- ② Number buttons
- ③ **RETURN+** button
- ④ **ZOOM** button
- ⑤ **CINEMA** button
- ⑥ **TV/VIDEO** button
- ⑦ ◀/▶/▼/▲ buttons
- ⑧ **DISPLAY** button
- ⑨ **CHANNEL** V/∧ buttons
- ⑩ VCR/DVD/Teletext control buttons
- ⑪ V/∧ buttons
- ⑫ (Favourite) button
- ⑬ ⏻ (Standby) button
- ⑭ PIP/TV/DVD switch
- ⑮ (Text) button
- ⑯ Colour buttons
- ⑰ **MENU** button
- ⑱ **OK** button
- ⑲ **BACK** button
- ⑳ **VOLUME** -/+ buttons
- ㉑ (Freeze) button
- ㉒ (Multi) button
- ㉓ (Select) button

Turn the TV on or off from standby mode

Press the ⏻ (standby) button to turn the TV on or off

When the TV is turned on, the power lamp lights blue.

- The power can be turned on by pressing the **TV/VIDEO** button, **CHANNEL** V/∧ buttons or Number buttons.

To turn the TV on or off, set the PIP/TV/DVD switch on the remote control to the TV position and press the ⏻ button. If the PIP/TV/DVD switch on the remote control is set to the DVD position, the TV will not be turned on or off even if the ⏻ button is pressed.

Choose a TV channel and watch images from external devices

■ Use the number buttons: Enter the programme number (PR) of the channel using the number buttons.

Example:

- PR 6 → press **6**
- PR 12 → press **1** and **2**

■ Use the CHANNEL \vee/\wedge buttons: Press the CHANNEL \vee/\wedge buttons to choose the programme number (PR) you want or a VIDEO terminal.

■ Use the TV/VIDEO button: Press the TV/VIDEO button to choose a VIDEO terminal.

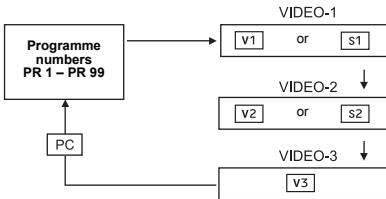

- The leading character is changed from V to S (eg V1 is changed to S1) when VIDEO-1 or VIDEO-2 is connected to the S terminal.
- If you do not have a clear picture or no colour appears, follow the operation procedure "COLOUR SYSTEM" on page 27.
- If you cannot hear the normal sound even if the picture of the TV channel appears normally. Follow the description "EDIT/MANUAL" on page 34 to use the MANUAL function to change the SYSTEM setting.

- Since this TV is designed to make full use of the resolution of the original video source, the motion may appear unnatural when the video source is input with progressive-scanning component signals.
- If this happens, change the output setting of the connected device to interlace-scanning component signal output. See the instructions that came with the device for more information.
- The PC sound is the same as the VIDEO-3 sound.

To return to a TV channel:

Press the TV/VIDEO button, the CHANNEL \vee/\wedge buttons or the number buttons.

To use the programme number PR 0 (AV):

When the TV and VCR are connected only by the aerial cable, choosing the programme number PR 0 (AV) allows you to view images from the VCR. Set the VCR RF channel to the programme number PR 0 (AV) manually. For details, see "EDIT/MANUAL" on page 34.

Adjust the volume

Press the **VOLUME** $-/+$ buttons to adjust the volume.

The volume level indicator appears and the volume changes as you press the **VOLUME** $-/+$ buttons.

■ **Muting the sound**
Press the \otimes (muting) button to turn off the sound.

Pressing the \otimes (muting) button again restores the previous volume level.

Display function

You can see the channel number of the programme you are watching or the PR LIST.

From the PR LIST, you can choose a channel or VIDEO terminal.

Press the **DISPLAY** button to display the information you want to see.

Pressing the **DISPLAY** button changes the display as follows:

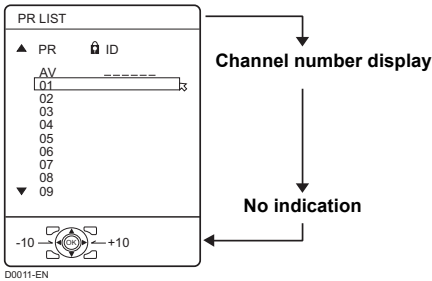

Channel number display:

The channel number and channel name (when the channel name is registered) of the programme you are watching or the VIDEO terminal number is displayed.

PR LIST:

The programme number (PR) and VIDEO terminal list is displayed.

Pressing the **OK** button after choosing the programme number (PR) or VIDEO terminal with the $\blacktriangleleft/\blacktriangleright/\blacktriangledown/\blacktriangleup$ buttons will display the chosen programme or VIDEO terminal.

- For programme numbers (PR) for which the CHANNEL GUARD function is set, the \otimes (CHANNEL GUARD) mark is displayed. For details see “CHANNEL GUARD” on page 31.
- The VIDEO terminals are registered after the programme number PR 99.
- For programme numbers (PR) which is registered as a favourite channel, the 📖 (favourite) mark is displayed. For details see “Favourite channel function” on page 18.

ZOOM function

You can change the screen size according to the picture aspect ratio. Choose the optimum one from the following ZOOM modes.

- The ZOOM mode is fixed at FULL when you are using the TV as a PC screen.

AUTO:

When a WSS (Wide Screen Signalling) signal, which shows the aspect ratio of the picture, is included in the broadcast signal or the signal from an external device, the TV automatically changes the ZOOM mode to 16:9 ZOOM mode or FULL mode according to the WSS signal.

If a WSS signal is not included, the picture is displayed according to the ZOOM mode set with the 4:3 AUTO ASPECT function.

- For details of the 4:3 AUTO ASPECT function, see “4:3 AUTO ASPECT” on page 28.
- When the AUTO (WSS) mode does not function correctly due to poor WSS signal quality or when you want to change the ZOOM mode, press the **ZOOM** button and change to another ZOOM mode.

REGULAR:

Use to view a normal picture (4:3 aspect ratio) as this is its original shape.



PANORAMIC:

This stretches the left and right sides of a normal picture (4:3 aspect ratio) to fill the screen, without making the picture appear unnatural.

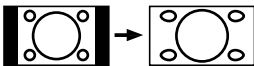

- The top and bottom of the picture are slightly cut off.

14:9 ZOOM:

This zooms up the wide picture (14:9 aspect ratio) to the upper and lower limits of the screen.



16:9 ZOOM:

This zooms up the wide picture (16:9 aspect ratio) to the full screen.

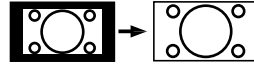

16:9 ZOOM SUBTITLE:

This zooms up the wide picture (16:9 aspect ratio) with subtitles to the full screen.

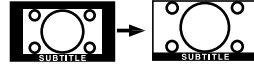

FULL:

This uniformly stretches the left and right sides of a normal picture (4:3 aspect ratio) to fill the wide TV screen.

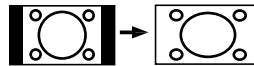

- For 16:9 aspect ratio pictures that have been squeezed into a normal picture (4:3 aspect ratio), use the FULL mode to restore the picture to its original shape.

■ Choose the ZOOM mode

1 Press the ZOOM button to display the ZOOM menu

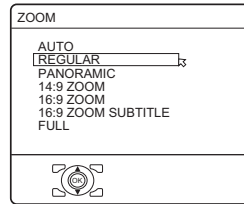

D0009-EN

2 Press the ▼/▲ buttons to choose a ZOOM mode. Then press the OK button

The picture expands and the chosen ZOOM mode is displayed in about 5 seconds.

- The ZOOM mode may be automatically changed by the control signal from an external device. When you want to return to the previous ZOOM mode, choose the ZOOM mode again.

■ Adjusting the visible area of the picture

If subtitles or the top (or bottom) of the picture are cut off, you can adjust the visible area of the picture manually.

1 Press the **ZOOM** button

The ZOOM menu appears.

2 Press the **OK** button to display the ZOOM mode indicator

The indicator appears.



3 While it is displayed, press the **▼/▲** buttons to change the position of the picture

- You cannot adjust the visible area in REGULAR or FULL mode.

The visible area adjustment is saved even after the TV channel is changed.

However, it is cancelled if the following operations are performed.

- The power is turned off/on
- The ZOOM mode is changed
- The (Multi) button, (Freeze) button, or (Text) button is pressed
- The TV is switched between TV mode and VIDEO mode

CINEMA SURROUND function

You can enjoy sounds with a wider ambience.

- This function does not work for the sound from headphones.

Press the **CINEMA** button to select one of CINEMA SURROUND modes

HIGH/LOW:

When you listen to stereo sound, please select HIGH or LOW mode.

You can enjoy sound similar to the experience at the theatre.

When you combine the functions of A.H.B. and BBE, you can enjoy more powerful sound.

- When you set the CINEMA SURROUND function to HIGH mode, there may be slight volume distortion. If that occurs, please switch to LOW mode. The effect of CINEMA SURROUND functions will be less noticeable, but the volume distortion will be corrected.

MONO:

Select the MONO mode, when you listen to the mono sound.

You can enjoy the sound for a wider audience similar to stereo sound.

OFF:

The CINEMA SURROUND function switches off.

- You can choose the CINEMA SURROUND mode with the “SOUND menu” (see page 29).

Using the “Freeze” function

You can view the current programme as a still picture.

1 Set the PIP/TV/DVD switch to the PIP position

When using the “Freeze” function, set the PIP/TV/DVD switch to the PIP position.

2 Press the button

The still picture of the current picture will appear.

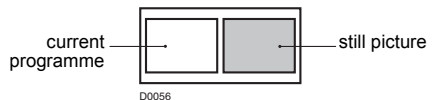

To cancel the “Freeze” function:

Press the  button, the **CHANNEL** \vee/\wedge buttons or the number buttons.

- The “Freeze” function does not work while a sub-picture is displayed.
- The still picture cannot be output from the TV.
- The “Freeze” function does not work for picture of PC signal.

12-pictures multi:

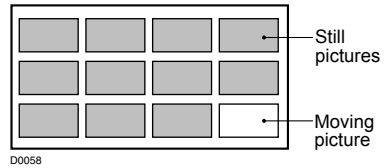

- When set to 2-pictures multi, you can view a TV picture and a picture from an external device. You cannot view a TV picture on more than one screen at the same time.
- When 12-pictures multi is set, pictures from external devices are not displayed.
- When set to 2-pictures multi, the main-picture can be changed by pressing the **CHANNEL** \vee/\wedge buttons. The sub-picture screen can be changed by pressing the $\blacktriangledown/\blacktriangle$ buttons. When set to 12-pictures multi and there are more than 12 pictures, the next or previous 12 screens can be displayed by pressing the **CHANNEL** \vee/\wedge buttons.
- When set to 2-pictures multi, the main-picture sound from the TV speaker can be changed to the sub-picture sound by pressing the \updownarrow button when the PIP/TV/DVD switch is set to the PIP position. (The speaker mark moves from the main-picture to the sub-picture.) The sound changes to the main-picture sound if the \updownarrow button is pressed again. When the headphones are connected, you can listen to the sound from the side at which the headphones mark is displayed. No sound comes from the TV speaker.
- The pictures from VIDEO-1 (or VIDEO-3) cannot be displayed in the sub-picture when the VIDEO-1 SETTING (or VIDEO-3 SETTING) is set to COMPONENT (see page 38).
- The “Multi-picture” function does not work for a PC signal.
- When set to 12-pictures multi, press the $\blacktriangleleft/\blacktriangleright/\blacktriangledown/\blacktriangle$ buttons to choose the screen you want to view and the press the **OK** button to display that picture on the whole screen.

ENGLISH

Using the “Multi-picture” function

1 Set the PIP/TV/DVD switch to the PIP position

When using the “Multi-picture” function, set the PIP/TV/DVD switch to the PIP position.

2 Press the  button

The “Multi-picture” menu appears.

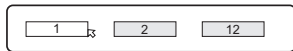

3 Press the $\blacktriangleleft/\blacktriangleright$ buttons to choose the number of screens and then press the **OK button**

 Choose to return to one screen.

D0102

 Choose to change to 2-pictures multi.

D0103

 Choose to change to 12-pictures multi.

D0104

2-pictures multi:

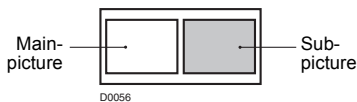

With 1125i and 750p signals, the screen is split into two as shown below.

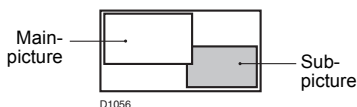

- The BLUE BACK function does not work when the “Multi-picture” function is being used.
- The ZOOM function does not work when the “Multi-picture” function is being used.

To return the “Multi-picture” to one screen:

Press the  button, press the ◀/▶ buttons to choose one screen, and then press the **OK** button.

- Pressing the **TV/VIDEO** button will also return the display to one screen.

RETURN PLUS function and Return function

The **RETURN+** button has two functions; the RETURN PLUS function and the Return function. If a channel has been registered as the “Return Channel”, the RETURN PLUS function operates. If there is no setting for the “Return Channel”, the Return function operates.

■ RETURN PLUS

By registering a channel you frequently view as the “Return Channel”, you can select that channel at any time simply by pressing the **RETURN+** button.

To register a TV channel as the “Return Channel”:

Choose the Programme number to which the channel you want to register has been set, and press the **RETURN+** button and hold for more than 3 seconds continuously. “RETURN PLUS PROGRAMMED!” is displayed and the registration is completed.

To cancel a TV channel registered as the “Return Channel”:

While viewing any TV channel, press the **RETURN+** button and hold for more than 3 seconds continuously. “RETURN PLUS CANCELED!” is displayed and the registration is cancelled.

- When you turn off the TV, the registration for the “Return Channel” is cancelled.

- If you want to view the “Return Channel” and another TV channel alternately, first choose a channel other than the “Return Channel”. And then press the **RETURN+** button to change the channel to the “Return Channel”. In this way, you can view two channels alternately by pressing the **RETURN+** button.

■ Return function

The TV temporarily memorises the TV channel that was chosen right before the current TV channel as the “Last Channel”. By pressing the **RETURN+** button, you can alternately view the current TV channel and the “Last Channel”.

If you want to view two channels alternately by using the Return function, first choose one TV channel and then choose the other TV channel with the number buttons. If you choose the TV channel without using the number buttons, there are cases where a channel other than the one you first chose is registered as the “Last Channel”.

Favourite channel function

You can register your favourite TV channels (PR 1 – PR 99) in the number buttons 1 to 4. After registering, the channel can be called by pressing the  (favourite) button and a number button 1 to 4.

■ Favourite channel registration

1 In the normal screen, choose a TV channel (PR 1 – PR 99) that you want to register

For details, refer to “Choose a TV channel and watch images from external devices” on page 12.

2 Press and hold the (favourite) button for three seconds or more

Then “SET 1-4?” appears on the screen.

3 Press one of the number buttons 1 to 4

The current channel is registered in the pressed number button.

After “PROGRAMMED!” appears on the screen, the favourite channel icon appears at the top-right of the screen.

- If the channel you are trying to register is already registered in one of the other number buttons 1 to 4, “NOT AVAILABLE” appears on the screen.
- Channels locked with the CHANNEL GUARD function cannot be registered.
- If AUTO PROGRAM is performed, the registered favourite channels are reset.

- When you want to delete a favourite channel, delete the set channel and set contents with FAVOURITE SETTING (see page 33) in the FEATURES menu.
-

■ Calling the favourite channel

1 In the normal screen, press the (favourite) button

Then “FAVOURITE1-4?” appears.

2 Press one of the number buttons 1 to 4

The called favourite channel appears on the screen.

- If a number button in which no channel is registered is pressed, “NO MEMORY” appears on the screen.

■ Setting the picture effect

When a favourite channel has been chosen with the  (favourite) button and number buttons 1 to 4, picture effect settings can be memorised for each favourite channel by setting the picture effects in the PICTURE menu (see page 25).

The following items in the PICTURE menu (see page 25) are memorised.

PICTURE MODE
BACK LIGHT
CONTRAST
BRIGHT
SHARP
COLOUR
TINT
WHITE BALANCE
DIGITAL VNR
COLOUR SYSTEM





The last setting made for each item is memorised.

Operating a JVC brand DVD player

These buttons will operate a JVC brand DVD player. Pressing a button that looks the same as the device's original remote control button has the same effect as the original remote control.

1 Set the PIP/TV/DVD switch to the DVD position

When you are operating the DVD player, set the switch to the DVD position.

- You can turn the DVD player on or off with the  (standby) button.
- You can also press the **MENU** or **TOP MENU** button and display the DVD disc menu screen, and then operate by pressing the     buttons.

2 Press the DVD control button to control your DVD player

- If your DVD player is not made by JVC, these buttons will not work.
- Even if your device is made by JVC, some of these buttons may not work, depending on the device you are using.

You cannot turn the TV on or off when the PIP/TV/DVD switch is set to the DVD position.

When you turn the TV on or off, set the PIP/TV/DVD switch to the TV position.

Teletext function

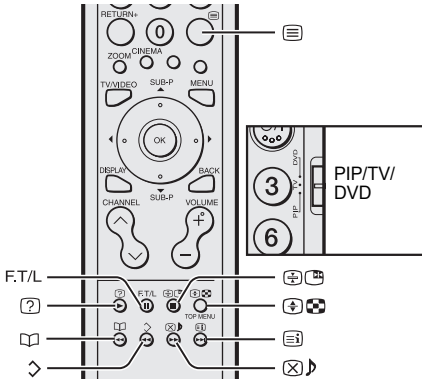

4 Choose a teletext page by pressing the CHANNEL ∇/\wedge buttons, number buttons or colour buttons

To return to the TV mode:

Press the **TV/VIDEO** button, **BACK** button, or (Text) button.

- If you have trouble receiving teletext broadcasts, consult your local dealer or the teletext station.
- The ZOOM function will not work in the TV and text mode or Text mode.
- You cannot operate menus when viewing a teletext programme.
- If characters on a teletext programme do not appear properly, change the TELETEXT LANGUAGE setting. For details, see “TELETEXT LANGUAGE” on page 39.

Basic operation

1 Choose a TV channel with a teletext broadcast

2 Set the PIP/TV/DVD switch to the TV position



3 Press (Text) button to display the teletext

Pressing (Text) button changes the mode as follows:

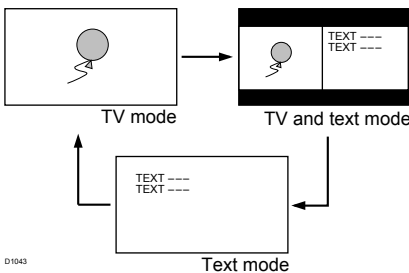

D1043

Using the List Mode

You can store the numbers of your favourite teletext pages in memory and call them up quickly using the colour buttons.

■ **To store the page numbers:**

1 Press F.T/L button to go into the List mode

The page numbers you have stored are displayed at the bottom of the screen.

- 2 Press a colour button to choose a position. Then press the number buttons to enter the page number**

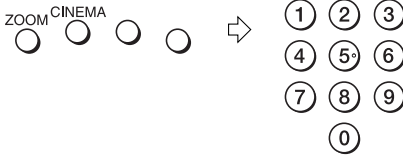

- 3 Press and hold down the \triangleright (Store) button**

The four page numbers blink white to show that they are stored in memory.

■ **To call up a stored page:**

- 1 Press the F.T/L button to enter the List mode**

- 2 Press a colour button having a stored page**



To exit the List mode:

Press the F.T/L button again.

Hold

You can hold a teletext page on the screen for as long as you want, even while several other teletext pages are being received.

- Press the H (Hold) button**

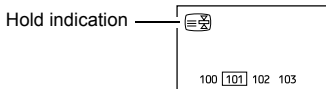

To cancel the Hold function:

Press H (Hold) button again.

Sub-page

Some teletext pages include sub-pages that are automatically displayed.

- 1 Choose a teletext page that includes sub-pages**

Sub-page numbers that can be viewed are automatically displayed at the top of the screen.

- 2 Press the $\blacktriangleleft/\blacktriangleright$ buttons to choose a sub-page number**

Reveal

Some teletext pages include hidden text (such as answers to a quiz). You can display the hidden text.

- Each time you press the R (Reveal) button, text is hidden or revealed**

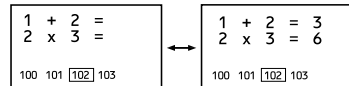

Size

You can double the height of the teletext display.

- Press the S (Size) button**

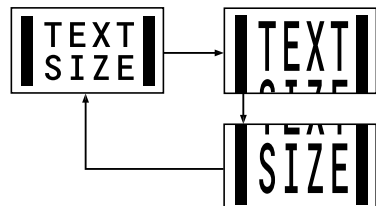

Index

You can return to the index page instantly.

Press the (Index) button

Returns to page 100 or a previously specified page.

Cancel

You can search for a teletext page while watching TV.

1 Press the number button to enter a page number, or press a colour button

The TV searches for a teletext page.

2 Press (Cancel) button

The TV programme appears. When the TV finds the teletext page, its page number appears in the upper left of the screen.

3 Press (Cancel) button to return to a teletext page when the page number is on the screen

- The TV mode cannot be resumed by pressing the  (Cancel) button. To return to the TV mode press **TV/VIDEO** or **BACK** button.

Using the TV's menu

This TV has a number of functions you can operate using menus. To use all your TV's functions, you need to understand the basic menu operating techniques fully.

Buttons used to operate the menus

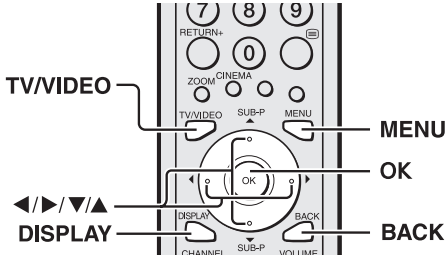

Basic operation

- 1 Press the **MENU** button to display the menu bar



- 2 Press the </> buttons to choose the menu you want to use and then press the **OK** button



- 3 Press the </> buttons to choose the item to be set, press the </> buttons to set the item, and then press the **OK** button

If there are sub-menus, use the </>/</> buttons to operate them.

- Press the **BACK** button to return to the previous menu.
- Press the **TV/VIDEO** or **MENU** button to exit from the menu.
- Some menu items may not be operated or set depending on the TV status or other menu item settings. Menu items that cannot be operated or set are displayed in grey in the menu and cannot be chosen.

Types of menu



PICTURE menu
Choose to set the screen settings.



SOUND menu
Choose to set the sound settings.



FEATURES menu
Choose to set the sleep timer and child lock settings.



SET UP menu
Choose to edit the channels or set the display language settings.

- The menu will disappear after about one minute if no operation is performed.

The menu guide area can be made to appear and disappear for some menus. While the menu is displayed, press the **DISPLAY** button to change between the guide area being displayed and not displayed.

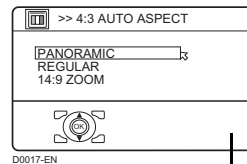

Guide area

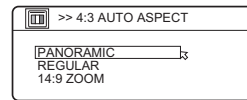

- The guide area for some menus will still be displayed even if the **DISPLAY** button is pressed. This is not a fault.

Operation with the buttons on the TV

You can also operate the menus using the buttons on the front panel of the TV.

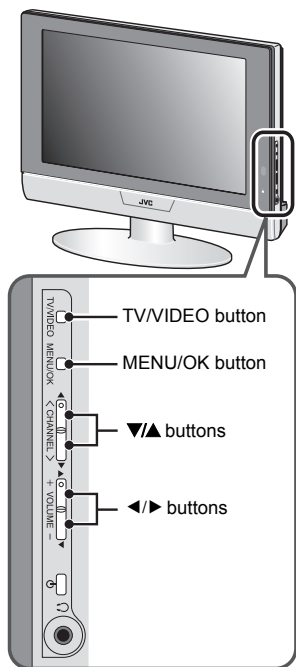

PICTURE menu

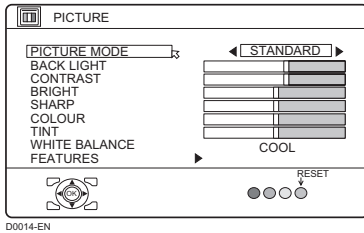

- While the PICTURE menu is displayed, pressing the blue button will set the BACK LIGHT, CONTRAST, BRIGHT, SHARP, COLOUR, TINT settings to their default settings.
- When watching the picture from VIDEO-1 to VIDEO-3 or the PC, picture effect settings can be memorised for each external input by setting the picture effects in the PICTURE menu. The following items in the PICTURE menu are memorised.

PICTURE MODE
BACK LIGHT
CONTRAST
BRIGHT
SHARP
COLOUR
TINT
WHITE BALANCE
DIGITAL VNR
COLOUR SYSTEM

The last setting made for each item is memorised.

PICTURE MODE

You can choose one of three PICTURE MODEs to adjust the picture settings automatically.

BRIGHT:

Heightens contrast and sharpness.

STANDARD:

Standardises picture adjustment.

SOFT:

Softens contrast and sharpness.

BACK LIGHT

You can adjust the back light.

- ◀ : darker
- ▶ : brighter

CONTRAST

You can adjust the picture contrast.

- ◀ : lower
- ▶ : higher

BRIGHT

You can adjust the picture brightness.

- ◀ : darker
- ▶ : brighter

SHARP

You can adjust the picture sharpness.

- ◀ : softer
- ▶ : sharper

COLOUR

You can adjust the picture colour.

- ◀ : lighter
- ▶ : deeper

TINT

You can adjust the picture tint.

- ◀ : reddish
- ▶ : greenish
- You can change the TINT setting (picture hue) when the colour system is NTSC 3.58, or NTSC 4.43.

WHITE BALANCE

You can select one of three WHITE BALANCE modes (three tones of white) to adjust the white balance of the picture. Since white is the colour which is used as a reference for all the other colours, changing the WHITE BALANCE mode affects the appearance of all the other colours on the screen.

COOL:

A bluish white. Using this mode when watching bright pictures allows you to enjoy a more vivid and bright picture.

MID:

The normal white colour.

WARM:

A reddish white. Using this mode when watching films allows you to enjoy colours that are characteristic of films.

FEATURES

Choose FEATURES and press the **OK** or ► button to display the sub-menu.

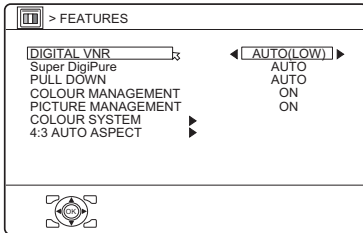

D1015-EN

■ **DIGITAL VNR**

The DIGITAL VNR function cuts down the amount of ‘noise’ (‘snow’ or interference) in the original picture.

You can choose from the three DIGITAL VNR function settings of AUTO, MIN and MAX.

AUTO(LOW)/AUTO(HIGH):

The TV will automatically adjust the level of the DIGITAL VNR effect to match the amount of noise in the picture, giving you the best possible picture.

- If you set the DIGITAL VNR effect too high it can make the picture less sharp. It is recommended you use the AUTO(LOW) setting if you can. If you set the DIGITAL VNR function to AUTO(LOW) but still notice some noise, change the setting from AUTO(LOW) to AUTO(HIGH).

MIN:

The level of the DIGITAL VNR effect is set to the minimum. If you set the DIGITAL VNR function to AUTO(LOW) but feel that the sharpness of the original picture has not been reproduced fully, change the setting from AUTO(LOW) to MIN.

- The MIN setting is not suitable for low-quality pictures which contain a lot of noise.

MAX:

The level of the DIGITAL VNR effect is set to the maximum. If you set the DIGITAL VNR function to AUTO(HIGH) but still notice some noise, change the setting from AUTO(HIGH) to MAX.

- The MAX setting is not suitable for high-quality pictures which contain very little noise.

■ **Super DigiPure**

The Super DigiPure function uses the latest in digital technology to give you a natural-looking picture. The Super DigiPure function includes the following two functions.

DigiPure function:

This function helps to create a natural-looking picture by eliminating unnecessary edges from high-contrast and crisp images. For images with low-contrast, edges are added to produce a sharper, more detailed picture.

You can choose from the three DigiPure function settings of AUTO, MIN and MAX.

- If you set the DigiPure effect too high on a low-quality picture that contains a lot of noise, this may actually make the noise worse. We recommend you use the AUTO setting if you can.

Picture motion compensation function:

This function displays fast-moving pictures (for example, the players or ball in a football game) more smoothly and naturally on the screen.

- The effect level of the picture motion compensation function cannot be changed. The effect level is the same no matter which of the AUTO, MIN or MAX settings is used.

AUTO:

The TV will automatically adjust the level of the DigiPure effect to match the amount of noise in the picture, giving the best possible picture.

MIN:

The level of DigiPure effect is set to the minimum. When you set the Super DigiPure function to AUTO and notice some noise, change the setting from AUTO to MIN.

- The MIN setting is not suitable for high-quality pictures which contain very little noise.

MAX:

The level of DigiPure effect is set to the maximum. If you set the Super DigiPure function to AUTO but feel that the original picture quality has not been reproduced fully, change the setting from AUTO to MAX.

- The MAX setting is not suitable for low-quality pictures which contain a lot of noise.

OFF:

The Super DigiPure function is turned off.

■ **PULL DOWN**

The PULL DOWN function displays a cinema film picture more smoothly and naturally on the screen.

AUTO:

The television automatically recognises the type of signal and turns the function on and off.

ON:

This function is turned on.

OFF:

This function is turned off.

■ **COLOUR MANAGEMENT**

This TV supports the COLOUR MANAGEMENT function to ensure dull colours are compensated to produce natural hues.

The COLOUR MANAGEMENT function is on by default.

ON:

COLOUR MANAGEMENT function is turned on.

OFF:

COLOUR MANAGEMENT function is turned off.

- Set this function to ON under normal conditions.

■ **PICTURE MANAGEMENT**

The PICTURE MANAGEMENT function makes it easier to see the dark areas when a picture has many dark areas, and makes it easier to see the bright areas when a picture has many bright areas.

Normally use with this function on.

ON:

PICTURE MANAGEMENT function is turned on.

OFF:

PICTURE MANAGEMENT function is turned off.

■ **COLOUR SYSTEM**

The colour system is chosen automatically. However, if the picture is not clear or no colour appears, choose the colour system manually.

1 Choose COLOUR SYSTEM. Then press the OK or ► button

The sub-menu of the COLOUR SYSTEM function appears.

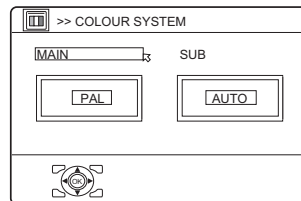

D0016-EN

2 Press the ◀/▶ buttons to choose MAIN or SUB

MAIN:

You can change the colour system of the main-picture.

SUB:

You can change the colour system of the sub-picture.

- Choose MAIN when a sub-picture is not displayed.

3 Press the ▼/▲ buttons to choose the appropriate colour system. Then press the OK button

PAL:

PAL system

SECAM:

SECAM system

NTSC 3.58:

NTSC 3.58 MHz system

NTSC 4.43:

NTSC 4.43 MHz system

AUTO:

This function detects a colour system from the input signal.

- The AUTO function may not function properly if you have poor signal quality. If the picture is abnormal in the AUTO function, choose another colour system manually.
- COLOUR SYSTEM cannot be chosen when you are watching the PC picture.

For colour system in your country or region, refer to the table below:

Area	Country or Region	System
Asia, Middle East	Bahrain, Kuwait, Oman, Qatar, United Arab Emirates, Yemen, etc.	PAL
	China, Vietnam, etc.	PAL
	Hong Kong, etc.	PAL
	Islamic Republic of Iran, Lebanon, Saudi Arabia, etc.	SECAM
	Philippines, Taiwan, Myanmar, etc.	NTSC
Europe	Russia, etc.	SECAM
	Czech Republic, Poland, etc.	PAL
	Germany, Holland, Belgium, etc.	PAL
	UK, etc.	PAL
Oceania	Australia, New Zealand, etc.	PAL
Africa	Republic of South Africa, etc.	PAL
	Nigeria, etc.	PAL
	Egypt, Morocco, etc.	SECAM

■ 4:3 AUTO ASPECT

You can choose one of three ZOOM modes, REGULAR, PANORAMIC or 14:9 ZOOM, as the ZOOM mode for the normal picture (4:3 aspect ratio).

1 Choose 4:3 AUTO ASPECT then press the OK button

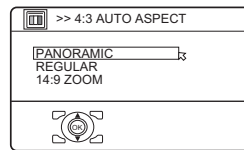

D0017-EN

2 Press the ▼/▲ buttons to choose a ZOOM mode

SOUND menu

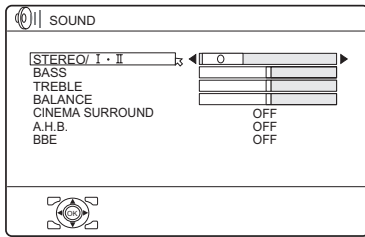

D0019-EN

- When the headphones are connected, only “STEREO / I • II” can be used.

STEREO / I • II

When you are viewing a bilingual broadcast programme, you can choose the sound from Bilingual I (Sub I) or Bilingual II (Sub II). If you have poor reception on a stereo broadcast, you can change from stereo to mono sound so that you can hear the broadcast more clearly and easily.

∞ : Stereo sound

○ : mono sound

I : Bilingual I (sub I)

II : Bilingual II (sub II)

- The sound mode you can choose differs depending on the TV programme.
- This function does not work in the VIDEO modes.

BASS

You can adjust the low tone of the sound.

- ◀ : weaker
- ▶ : strong

TREBLE

You can adjust the high tone of the sound.

- ◀ : weaker
- ▶ : strong

BALANCE

You can adjust the volume balance between the left and right speaker.

- ◀ : turn the left speaker's volume level up.
- ▶ : turn the right speaker's volume level up.

CINEMA SURROUND

You can enjoy Surround sound with a “live” effect by using the CINEMA SURROUND function.

- You can choose a CINEMA SURROUND mode from HIGH, LOW, MONO and OFF modes. For details, see “CINEMA SURROUND function” on page 15.
- You can also operate the CINEMA SURROUND function with the **CINEMA** button. For details, see “CINEMA SURROUND function” on page 15.

A.H.B. (Active Hyper Bass)

Used when you want to emphasise the bass sound.

ON:

This function is turned on.

OFF:

This function is turned off.

BBE

BBE function restores clarity and presence for better speech intelligibility and musical realism.

ON:

This function is turned on.

OFF:

This function is turned off.

- Manufactured under license from BBE Sound, Inc. Licensed by BBE Sound, Inc. under USP4638258, 5510752 and 5736897. BBE and BBE symbol are registered trademarks of BBE Sound, Inc.
-

FEATURES menu

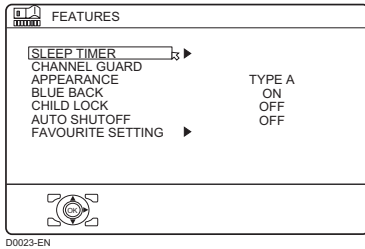

SLEEP TIMER

You can set the TV to automatically turn off after a set period of time.

1 Choose SLEEP TIMER. Then press the OK or ► button

A Sub-menu of the SLEEP TIMER function appears.

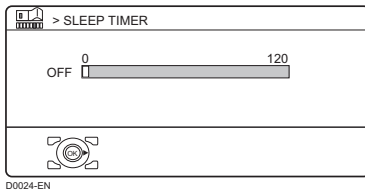

2 Press the ◀/▶ buttons to set the period of time. Then press the OK button

You can set the period of time for up to 120 minutes (2 hours) in 10 minute steps.

- One minute before the SLEEP TIMER function turns off the TV, “GOOD NIGHT!” appears.
- The SLEEP TIMER function cannot be used to turn off the TV’s main power.
- When the SLEEP TIMER function is on, you can display the sub-menu of the SLEEP TIMER function again to confirm or change the remaining period of time of the SLEEP TIMER function. Press the OK button to leave the menu after confirming or changing the remaining time.

To cancel the SLEEP TIMER function:

Press the ◀ button to set the period of time to “OFF”.

CHANNEL GUARD

When there is a TV channel you do not want your children to watch, you can use the CHANNEL GUARD function to lock out the TV channel. Even when a child chooses a programme number (PR) for a locked TV channel the screen will change to blue and display  (CHANNEL GUARD) so the TV channel cannot be viewed. Unless you enter a pre-set ID number by a special operation, the lock cannot be released and the child cannot view the TV channel.

■ To set the CHANNEL GUARD function

1 Choose CHANNEL GUARD, then press the 0 button

“SET ID NO.” (ID number setting screen) appears.

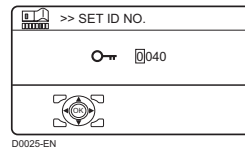

2 Set the ID number to your liking

1 Press the ▼/▲ buttons to choose a number.

2 Press the ◀/▶ buttons to move the cursor.

3 Press the OK button

The Sub-menu of CHANNEL GUARD appears.

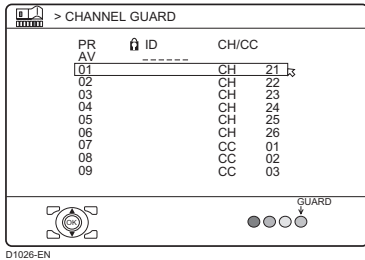

4 Press the ▼/▲ buttons to choose a TV channel

Every time you press the ▼/▲ buttons, the Programme number (PR) changes, and the picture of the TV channel registered in the Programme number (PR) is displayed on the screen.

5 Press the blue button and set the CHANNEL GUARD function. Then press the OK button

🔒 (CHANNEL GUARD) appears and the TV channel is locked.

To reset the CHANNEL GUARD function:

Press the blue button again. 🔒 (CHANNEL GUARD) disappears.

To disable easy resetting of the CHANNEL GUARD function, the menu disappears if you choose the CHANNEL GUARD function and press the **OK** button.

■ To view a locked TV channel

1 Choose a programme number (PR) of a locked TV channel with the number buttons or PR LIST

The screen changes to blue and the 🔒 (CHANNEL GUARD) appears. You cannot view the TV channel.



2 Press the DISPLAY button to display "ID NO." (ID No. input screen)

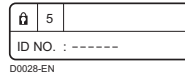

3 Press the number buttons to enter the ID number

The lock is temporarily released so you can view the TV channel.

If you have forgotten the ID number:

Perform step 1 of "To set the CHANNEL GUARD function". After confirming the ID number, press the **TV/VIDEO** button to exit the menu.

- Even if you reset the lock temporarily, it does not mean that the CHANNEL GUARD function set for the TV channel is cancelled. The next time anyone tries to view the TV channel, it will be locked again.
- When you want to cancel the CHANNEL GUARD function, you must perform the operation "To set the CHANNEL GUARD function" again.
- To stop it being easy to choose the programme number (PR) of a locked TV channel, the programme number (PR) has been set so that it cannot be chosen with the ▼/▲ buttons or the buttons of the TV.
- To stop it being easy to reset the lock, "ID NO." (ID No. input screen) is set so that it cannot appear unless you press the **DISPLAY** button.

APPEARANCE

Press the ◀/▶ button and choose the format in which the channel number is displayed from the four types: TYPE A, TYPE B, TYPE C, and TYPE D.

- Set to TYPE D when shipped from factory. TYPE D sets all screens to semitransparent. The menu screens are not semitransparent when set to a type other than TYPE D.

BLUE BACK

You can set the TV to automatically change to a blue screen and mute the sound if the signal is weak or absent, or when there is no input from an external device.

ON:

This function is turned on.

OFF:

This function is turned off.

CHILD LOCK

You can disable the front control buttons of the TV. When this function is set to ON, the TV can be operated only by using the remote control.

Use this function to prevent children from operating the TV at their own discretion (without parent consent).

ON:

This function is turned on.

OFF:

This function is turned off. When you disconnect the AC plug, the CHILD LOCK will be cancelled.

AUTO SHUTOFF

You can set the power to turn off if no signal is received and no operation is performed for about 15 minutes or longer after the end of a broadcast.

ON:

This function is turned on.

OFF:

This function is turned off.

- The AUTO SHUTOFF function does not turn off the TV's main power.
- The AUTO SHUTOFF function does not work for the VIDEO mode or a picture from a PC signal.

FAVOURITE SETTING

Chose when deleting the favourite channels registered in the buttons 1 to 4.

1 Choose FAVOURITE SETTING, then press the OK or ▶ button

The FAVOURITE SETTING menu appears.

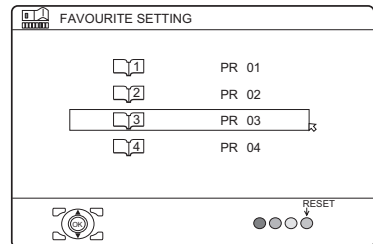

2 Press the ▼/▲ buttons and chose the favourite channel that you want to delete

3 Press the blue button

The chosen favourite channel and set contents are deleted.

- For details of the favourite channels, see “Favourite channel function” on page 18.

SET UP menu

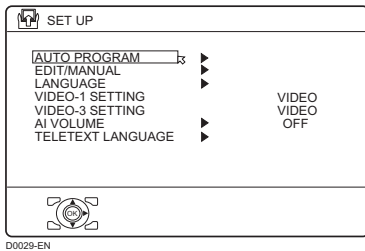

D0029-EN

AUTO PROGRAM

You can again perform the AUTO PROGRAM function TV channel automatic registration which was performed in the “Initial settings (Setup tour)” (page 8).

1 Choose AUTO PROGRAM, then press the OK or ► button

The AUTO PROGRAM function starts. The TV channels you receive are automatically stored in the programme numbers list.

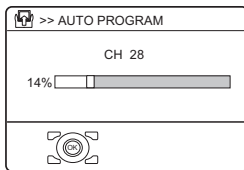

D0004-EN

- To stop the AUTO PROGRAM function, press the **OK** button.

2 After the TV channels have been stored in the programme number list, the EDIT menu appears

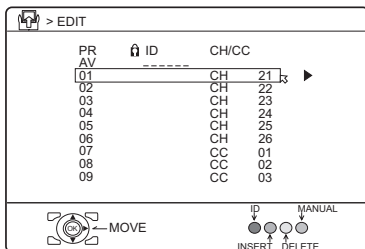

D0039-EN

- You can proceed to edit the programme numbers list using the EDIT/MANUAL function. For details, see “EDIT/MANUAL” on page 34.
- If a TV channel you want to view is not stored in the programme numbers list, you can register it using the MANUAL function. For details, see “EDIT/MANUAL” on page 34.
- The AUTO PROGRAM function does not store a TV channel to the programme number PR 0 (AV).
- If you do not need to use the EDIT/MANUAL function, press the **OK** button to exit the EDIT menu.
- Starting the AUTO PROGRAM deletes the registered favourite channel.

EDIT/MANUAL

The EDIT/MANUAL functions are divided into two types:

- editing the current programme numbers (PR) (EDIT functions); and
- manually storing a TV channel you want to view on a particular programme number (PR) (MANUAL function).

Here are the details about these functions:

MOVE:

This function changes the programme number (PR) of a TV channel.

ID:

This function registers a channel name (ID) to a TV channel.

INSERT:

This function adds a new TV channel in the current programme numbers (PR) list by using the CH/CC number.

- You cannot use the INSERT function if you do not know the channel number of a TV channel. Use the MANUAL function to register a TV channel in the programme number (PR).

DELETE:

This function deletes a TV channel you do not want to list.

MANUAL:

This function manually stores a new TV channel in a programme number (PR).

Caution

- Using the MOVE, DELETE or INSERT functions rewrites the current programme numbers (PR) list. Therefore, the programme numbers (PR) of some of the TV channels will change.
- Using the MANUAL function for a TV channel for which the CHANNEL GUARD function has been set cancels the CHANNEL GUARD function for that channel.
- When a TV channel has already been registered in PR 99, using the INSERT function deletes that TV channel.

Basic operation

1 Choose EDIT/MANUAL, then press the OK or ► button

The EDIT menu appears.

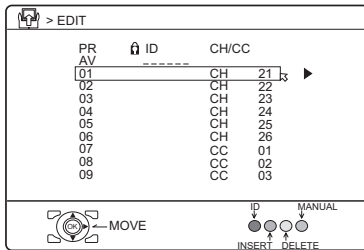

D0038-EN

2 Follow the description for the function you want to use

3 Press the OK button to complete the settings

- For programme number PR 0, “AV” appears in the programme numbers (PR) list.
- A VIDEO terminal number does not appear in the programme numbers (PR) list.
- The CH/CC number is a number unique to the TV and corresponds to the channel number of a TV channel. For the relationship between a channel number and a CH/CC number, see “CH/CC numbers” on page 44.

MOVE

1 Press the ▼/▲ buttons to choose a TV channel

2 Press the ► button to start the MOVE function

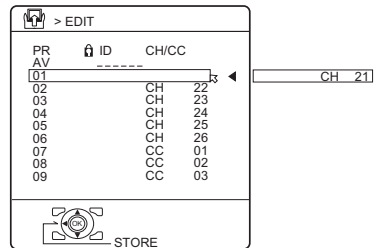

D0030-EN

3 Press the ▼/▲ buttons to choose a new programme number (PR)

To cancel the MOVE function: Press the **BACK** button.

4 Press the ◀ button to change the programme number (PR) of a TV channel to a new programme number (PR)

■ DELETE

- 1 Press the ▼/▲ buttons to choose a TV channel
- 2 Press the yellow button to delete the TV channel
The TV channel is deleted from the programme numbers (PR) list.

■ ID

- 1 Press the ▼/▲ buttons to choose a TV channel
- 2 Press the red button to start the ID function
- 3 Enter a channel name (ID). Press the ▼/▲ buttons to choose a character. Press the ◀/▶ buttons to move the cursor

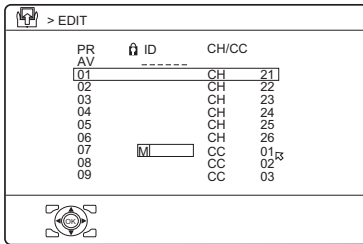

To cancel the ID function:
Press the **BACK** button.

- 4 Press the **OK** button to give a channel name to a TV channel

Before performing INSERT operation

- A CH/CC number unique to this TV and corresponding to the Channel number of a TV channel is required. Find the corresponding CH/CC number from a table “CH/CC numbers” on page 44 based on the Channel number of the TV channel.

■ INSERT

- 1 Press the ▼/▲ buttons to choose a programme number (PR) for which you will register a new TV channel
- 2 Press the green button and start the INSERT function

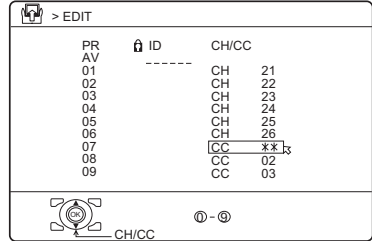

- 3 Press the ▼/▲ buttons to choose “CC” or “CH” according to the CH/CC number of the TV channel

To cancel the INSERT function:
Press the **BACK** button.

- 4 Press the number buttons to enter the remaining CH/CC number

The TV shifts to registration mode. When the registration is completed, the picture of the TV channel appears on the screen.

- The CH/CC number is a number given to each broadcast frequency that carries a TV channel. If the TV cannot detect the TV channel corresponding to the broadcast frequency indicated by the CH/CC number, a “no-signal” picture appears.

■ MANUAL

1 Press the ▼/▲ buttons to choose a programme number (PR) for a new TV channel

2 Press the blue button to activate the MANUAL function

At the right side following the CH/CC number, the SYSTEM (sound system) of the TV channel appears.

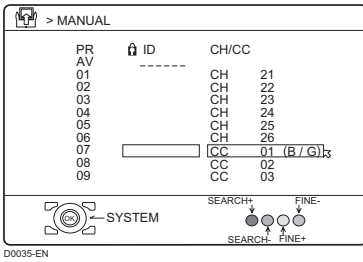

To cancel the MANUAL function:
Press the **BACK** button.

3 Press the ► button to choose the SYSTEM (sound system) for a TV channel you want to register

- For the sound systems in each country or region, refer to the table below:

Area	Country or Region	System
Asia, Middle East	Bahrain, Kuwait, Oman, Qatar, United Arab Emirates, Yemen, etc.	B/G
	Indonesia, Malaysia, Singapore, Thailand, India, etc.	
	China, Vietnam, etc.	D/K
	Hong Kong, etc.	I
	Islamic Republic of Iran, Lebanon, Saudi Arabia, etc.	B/G
Europe	Philippines, Taiwan, Myanmar, etc.	M
	Russia, etc.	D/K
	Czech Republic, Poland, etc.	D/K
	Germany, Holland, Belgium, etc.	B/G
Oceania	UK, etc.	I
	Australia, New Zealand, etc.	B/G
Africa	Republic of South Africa, etc.	I
	Nigeria, etc.	B/G
	Egypt, Morocco, etc.	B/G

4 Press the green or red button to search for a TV channel

Scanning stops when the TV finds a TV channel. Then the TV channel is displayed.

5 Press the green or red button repeatedly until the TV channel you want appears

If the TV channel reception is poor:

Press the blue or yellow button to fine-tune the TV channel.

If you cannot hear the normal sound even when the picture of the TV channel appears normally:

The SYSTEM setting is wrong. Press the ► button and choose a SYSTEM that has normal sound.

6 Press the OK button and register the TV channel to a Programme number (PR)

The normal EDIT menu is resumed.

D0035-EN

LANGUAGE

The LANGUAGE setting which was performed in the “Initial settings (Setup tour)” (page 8) can be changed.

1 Choose LANGUAGE, then press the OK or ► button

A sub-menu of the LANGUAGE function appears.

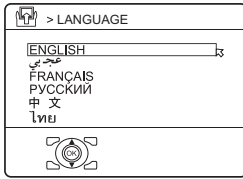

2 Press the ▼/▲ buttons to choose a language. Then press the OK button

VIDEO-1 SETTING/VIDEO-3 SETTING

Set the VIDEO-1 SETTING or VIDEO-3 SETTING correctly according to the video signal input from the external device connected to the VIDEO-1 or VIDEO-3 terminal. If this setting is incorrect, images will not be displayed.

VIDEO:

If a normal video signal (composite video signal) is input.

COMPONENT:

If a Component video signal (Y, Cb/Pb, Cr/Pr signals) is input.

- For detailed connecting methods, see “Additional preparation” on page 41. This Television is compatible with the 1125i, 625p or 525p video signal only when the component video signal is input.
- When the input signal is 1125i, 625p or 525p, each signal type is displayed at the upper right side on the TV screen by setting the input to VIDEO-1 or VIDEO-3.

AI VOLUME

You can prevent the sudden increase or decrease of sound that occurs when changing the channel to another channel.

ON:

This function is turned on.

OFF:

This function is turned off.

- The AI VOLUME function may not operate as expected if the sound input level from a broadcast station is extremely low.
- This function does not work in the VIDEO mode.

TELETEXT LANGUAGE

There are four types of teletext language groups. Set the teletext language group that corresponds to the language of the teletext programme that you want to watch.

1 Choose TELETEXT LANGUAGE, then press the **OK** or **▶** button

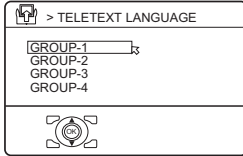

D1003-EN

2 Press the **▼/▲** buttons to choose a group

Group	Languages
GROUP-1	Turkish, Hungarian, English, German, French, Italian, Spanish, Portuguese, Greek, Swedish, Finnish
GROUP-2	Polish, Serbian, Croatian, Slovenian, Czech, Slovak, Rumanian, Hungarian, German, French, Italian, Swedish, Finnish
GROUP-3	Russian, Bulgarian, Lettish, Lithuanian, Estonian, Ukrainian, Serbian, Croatian, Slovenian, Czech, Slovak, English, German
GROUP-4	Arabic, Czech, Slovak, Hungarian, English, German, French, Italian, Spanish, Portuguese, Swedish, Finnish

3 Press the **OK** button to complete the setting

The menu disappears.

- Languages that are not included in the teletext language group that you select, the sub-titles of the teletext programme will not be displayed properly.

Displaying a computer screen

This TV can be used as a computer screen.

Connecting to the computer

Use a D-SUB cable to connect the TV's PC IN terminal to the computer's analogue RGB output terminal.

If you want to listen to the sound from the computer, use an audio cable to connect the VIDEO-3 AUDIO L/R sound input terminal to the computer's sound output terminal.

When the sound from the computer is mono, connect to the VIDEO-3 AUDIO L terminal.

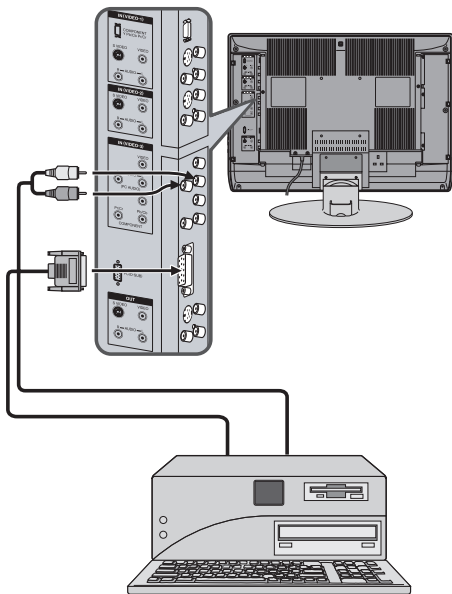

- Refer to the computer manual for a detailed explanation of the connections at the computer side.
- Ensure that the connectors are facing the correct way when connecting.
- After connecting the D-SUB cable, tighten the two screws to fix the connector in place.

Watching images from a computer

After starting the computer, press the TV/VIDEO or CHANNEL ∇/\wedge buttons to choose "PC"

You can listen to the sound when the sound from the computer is connected to the VIDEO-3 AUDIO L/R sound input terminal.

- When the sound from the computer is connected to VIDEO-3, by choosing external input VIDEO-3 the sound from the computer can be listened to, but the images from the computer cannot be seen.

Table of signals for each type of computer

Resolution	Vertical frequency (Hz)	Horizontal frequency (kHz)
640 × 480 (VGA)	60.0	31.5
1024 × 768 (XGA)	60.0	42.0

* Only the above formats are supported.

* Even with the above formats and at 60 Hz, some problems may be experienced depending on the quality of the synchronous signal. (Depending on the quality, some pictures may not be displayed properly.)

* Apple Macintosh* computers are not supported.

When a picture is not displayed

Check the computer's refresh rate and set it to 60 Hz. Refer to the computer's instruction manual.

Computers which cannot have their refresh rate set to 60 Hz cannot be used with this unit.

* Apple Macintosh is a registered trademark of Apple Computer, Inc.

Additional preparation

Connecting external equipment

Connect the equipment to the TV, making the correct rear panel and front panel connections.

Before connecting anything:

- Read the manuals that came with the equipment.
Depending on the equipment, the connection method may be different from the diagram. Also, the equipment settings may need to change depending on the connection method.
- Turn off all the equipment including the TV.
- The “Specifications” on page 47 give the details of the VIDEO terminals. If you are connecting equipment not listed in the following connection diagram, see the table to choose the best VIDEO terminal.
- Connecting cables are not supplied.
- If the VCR’s audio output is in mono, connect the VCR’s AUDIO OUT (audio output) terminal and the TV’s VIDEO-3 AUDIO L terminal with an audio cable.
- Use the supplied cable to connect the component device to the VIDEO-1 COMPONENT Y Pb/Cb Pr/Cr terminal.

■ Connecting the PC

For details, see “Connecting to the computer” on page 40.

- ① VCR (composite signal)
- ② VCR (S-VIDEO signal; Y/C)
- ③ VCR for recording (composite signal)
- ④ DVD player (composite signal)
- ⑤ DVD player (S-VIDEO signal; Y/C)
- ⑥ TV game (composite signal)
- ⑦ TV game (S-VIDEO signal; Y/C)
- ⑧ Headphones
- ⑨ Camcorder (composite signal/S-VIDEO signal; Y/C)
- ⑩ DVD player (component video signals; Y, Pb/Cb, Pr/Cr)
- ⑪ Video cable
- ⑫ Audio cable
- ⑬ S-VIDEO cable
- ⑭ Component cable

■ Connecting headphones

Connect the headphones with a stereo mini-jack (3.5 mm diameter) to the headphone jack.

- No sound comes from the TV speakers when the headphones are connected.

■ TV output from the OUT terminal

The video/sound signal of a TV channel you are viewing is always output from the OUT terminal.

- No signal will output through the S VIDEO terminal when you are not viewing images coming from the S VIDEO input. In this case, use the VIDEO terminal instead of the S VIDEO terminal.
- Changing over a programme number (PR) also changes over the TV output from the OUT terminal.
- When using the VIDEO-1 COMPONENT Y Pb/Cb Pr/Cr terminal input, VIDEO-3 COMPONENT input or PC IN input, the sound signal is output from the OUT terminal but the picture signal is not output.
- Teletext programmes cannot be output.

■ Connecting speakers/amplifier

While referring to the audio equipment connection diagram, connect the audio equipment you want to the TV.

You can use external front speakers to listen to the TV sound instead of the TV speakers.

Before connecting anything:

- Read the manuals provided with the amplifier and speakers.
- Turn the TV and amplifier off.
- To prevent magnetism from the speakers adversely affecting the TV screen, use magnetic-shielded speakers for the front speakers.
- Note that connecting cables are not supplied.

without terminal covers

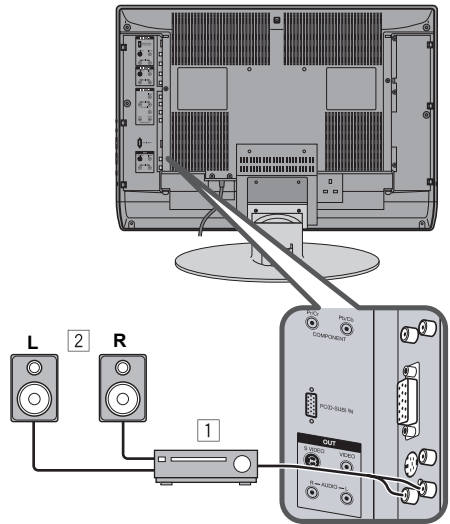

- 1 Amplifier
- 2 External speakers (Magnetic-shielded type)

- The output from the OUT terminal is not interrupted by headphone connection to the TV. You cannot cut the sound from the front speaker even if you connect a headphone to the TV.
- Adjust the volume of the external speakers with the amplifier.

CH/CC numbers

When you want to use the INSERT function on page 36, find the CH/CC number corresponding to the Channel number of the TV channel from this table.

US: The US channel numbers are the channel numbers used in the United States, Philippines, etc.

CCIR: The CCIR channel numbers are the channel numbers used in the Middle East, Southeast Asia, etc.

OIRT: The OIRT channel numbers are the channel numbers used in Eastern Europe, Russia, Vietnam, etc.

AUSTRALIA: The AUSTRALIA channel numbers are the channel numbers used in Australia, etc.

CH	Channel			
	US	CCIR	OIRT	AUSTRALIA
CH02	US-2	E2	R1	AU-0
CH03	US-3	E3		AU-1
CH04	US-4	E4	R2	AU-2
CH05	US-5	E5	R6	AU-6
CH06	US-6	E6	R7	AU-7
CH07	US-7	E7	R8	AU-8
CH08	US-8	E8	R9	AU-9
CH09	US-9	E9		
CH10	US-10	E10	R10	AU-10
CH11	US-11	E11	R11	AU-11
CH12	US-12	E12	R12	
CH13	US-13			
CH14	US-14, W+29			
CH15	US-15, W+30			
CH16	US-16, W+31			
CH17	US-17, W+32			
CH18	US-18, W+33			
CH19	US-19, W+34			
CH20	US-20, W+35			
CH21	US-21, W+36	E21		
CH22	US-22, W+37	E22		
CH23	US-23, W+38	E23		
CH24	US-24, W+39	E24		
CH25	US-25, W+40	E25		
CH26	US-26, W+41	E26		
CH27	US-27, W+42	E27		
CH28	US-28, W+43	E28		
CH29	US-29, W+44	E29		
CH30	US-30, W+45	E30		
CH31	US-31, W+46	E31		
CH32	US-32, W+47	E32		
CH33	US-33, W+48	E33		
CH34	US-34, W+49	E34		
CH35	US-35, W+50	E35		
CH36	US-36, W+51	E36		
CH37	US-37, W+52	E37		
CH38	US-38, W+53	E38		
CH39	US-39, W+54	E39		
CH40	US-40, W+55	E40		
CH41	US-41, W+56	E41		
CH42	US-42, W+57	E42		
CH43	US-43, W+58	E43		
CH44	US-44, W+59	E44		
CH45	US-45, W+60	E45		
CH46	US-46, W+61	E46		
CH47	US-47, W+62	E47		
CH48	US-48, W+63	E48		
CH49	US-49, W+64	E49		
CH50	US-50, W+65	E50		
CH51	US-51, W+66	E51		
CH52	US-52, W+67	E52		
CH53	US-53, W+68	E53		
CH54	US-54, W+69	E54		
CH55	US-55, W+70	E55		
CH56	US-56, W+71	E56		
CH57	US-57, W+72	E57		
CH58	US-58, W+73	E58		
CH59	US-59, W+74	E59		
CH60	US-60, W+75	E60		
CH61	US-61, W+76	E61		
CH62	US-62, W+77	E62		
CH63	US-63, W+78	E63		
CH64	US-64, W+79	E64		
CH65	US-65, W+80	E65		
CH66	US-66, W+81	E66		
CH67	US-67, W+82	E67		
CH68	US-68, W+83	E68		
CH69	US-69, W+84	E69		

CC	Channel			
	US	CCIR	OIRT	AUSTRALIA
CC01		S-1		
CC02		S-2		AU-5
CC03		S-3		
CC04		S-4		
CC05		S-5		
CC06		S-6		AU-5A
CC07		S-7		
CC08		S-8		
CC09		S-9		
CC10		S-10		
CC11		S-11		
CC12		S-12		
CC13		S-13		
CC14	A	S-14		
CC15	B	S-15		
CC16	C	S-16		
CC17	D	S-17		
CC18	E	S-18		
CC19	F	S-19		
CC20	G	S-20		
CC21	H	S-21		
CC22	I	S-22		
CC23	J	S-23		
CC24	K	S-24		
CC25	L	S-25		
CC26	M	S-26		
CC27	N	S-27		
CC28	O	S-28		
CC29	P	S-29		
CC30	Q	S-30		
CC31	R	S-31		
CC32	S	S-32		
CC33	T	S-33		
CC34	U	S-34		
CC35	V	S-35		
CC36	W	S-36		
CC37	W+1	S-37		
CC38	W+2	S-38		
CC39	W+3	S-39		
CC40	W+4	S-40		
CC41	W+5	S-41		
CC42	W+6			
CC43	W+7			
CC44	W+8			
CC45	W+9			
CC46	W+10			
CC47	W+11			
CC48	W+12			
CC49	W+13			
CC50	W+14			
CC51	W+15			
CC52	W+16			
CC53	W+17			
CC54	W+18			
CC55	W+19			
CC56	W+20			
CC57	W+21			
CC58	W+22			
CC59	W+23			
CC60	W+24			
CC61	W+25			
CC62	W+26			
CC63	W+27			
CC64	W+28			
CC75	X			
CC76	Y		R3	
CC77	Z		R4	AU-3
CC78	Z+1		R5	
CC79	Z+2			AU-4
CC95	A-5			
CC96	A-4			
CC97	A-3			
CC98	A-2			
CC99	A-1			

Troubleshooting

If a problem arises while you are using the TV, please read this troubleshooting guide carefully before you ask to have the TV repaired. You may be able to fix it easily by yourself. For example, if the mains plug is disconnected from the mains outlet, or the TV aerial has problems, you may think there is a problem with the TV itself.

Important:

- This troubleshooting guide only covers problems whose causes are not easy to decide. If you have a question when you are operating a function, read the page(s) for that function carefully, not this troubleshooting guide.
- If you follow the advice in this troubleshooting guide without any success, unplug the mains plug and ask for your TV to be repaired. Do not attempt to repair the TV by yourself or to remove the rear cover of the TV.

■ If you cannot turn on the TV

- Is the mains plug connected to the mains outlet?
- Make sure you set the PIP/TV/DVD switch to the TV position. You cannot turn the TV on when the PIP/TV/DVD switch is set to the DVD position.

■ If you cannot turn off the TV

- Make sure you set the PIP/TV/DVD switch to the TV position. You cannot turn the TV off when the PIP/TV/DVD switch is set to the DVD position.

■ No picture or no sound

- Have you chosen a TV channel with very poor reception? If so, the BLUE BACK function will be activated: the entire screen becomes blue, and the sound is muted. If you still want to view the TV channel, follow the description “BLUE BACK” on page 33 to change the BLUE BACK function setting to OFF.
- If the SYSTEM setting for a TV channel is incorrect, it may prevent the sound from being issued. Follow the description “EDIT/MANUAL” on page 34 to use the MANUAL function to try to change the SYSTEM setting.

■ Poor picture

- If noise (snow) totally blocks out the picture, there may be a problem with the aerial or aerial cable. Check the following to try to solve the problem:

- Have the TV and aerial been connected properly?
- Has the aerial cable been damaged?
- Is the aerial pointing in the right direction?
- Is the aerial itself faulty?
- If the TV or aerial suffers interference from other equipment, stripes or noise may appear in the picture. Move any equipment such as an amplifier, personal computer, or a hair drier, that can cause interference away from your TV. Or try moving the TV. If the aerial suffers interference from a radio tower or high-voltage wire, please contact your local dealer.
- If the TV suffers interference from signals reflecting from mountains or buildings, double-pictures (ghosting) will occur. Try to change the aerial’s direction or replace it with one with better directionality.
- Are your COLOUR SYSTEM settings correct? Follow the description “COLOUR SYSTEM” on page 27 to try to solve the trouble.
- Have the COLOUR and BRIGHT settings been adjusted properly? Follow the description “BRIGHT” and “COLOUR” on page 25 to try to adjust them properly.
- Videotaping teletext is not recommended because it may not record correctly.

- When viewing images from commercially available video software products, or videos from videotapes which have been recorded improperly, the top of the image may be distorted. This is due to the condition of the video signal. There is nothing wrong with the TV.
- Since this TV is designed to make full use of the resolution of the original video source, the motion may appear unnatural when the video source is input with progressive-scanning component signals. If this occurs, change the output setting of the connected device to interlace-scanning component signal output. See the instructions that came with the device for more information.

■ Poor sound

- Have you adjusted BASS or TREBLE properly? If not, follow the description “BASS” or “TREBLE” on page 29.
- When TV channel reception is poor, it can be hard to hear stereo or bilingual sound. In this case, follow the description “STEREO / I • II” on page 29 to hear the sound more easily by changing it to a mono sound.

■ If the TV does not respond to the remote control

- Have the batteries of the remote control worn out? Follow the description “Putting the batteries into the remote control” on page 8 and replace them with new batteries.
- Have you attempted to use the remote control from the sides or rear of the TV or from more than seven metres away from the TV? Use the remote control in front of your TV or from less than seven metres away.
- When you are viewing a teletext programme, you cannot operate the menus. Press the **TV/VIDEO** button to return to the ordinary TV programme, and then try operating the menus.
- If the TV suddenly stops responding, disconnect the power cord of the TV from the AC outlet. Connect them to the AC outlet again to turn on the TV. If the TV returns to a normal state, it is not a failure.

■ Other issues

- If the CHILD LOCK function set to ON, you cannot operate the TV with the front control buttons of the TV. Set the CHILD LOCK function to OFF.
- When the SLEEP TIMER function or AUTO SHUTOFF function operates, the TV is automatically turned off. If the TV suddenly turns off, try to press the \odot /I (standby) button to turn on the TV once again. If the TV goes back to normal, there is no problem.
- When the TV is receiving a wide-screen signal (WSS) or a signal from an external device affecting the screen size, the ZOOM mode automatically changes. When you want to resume the previous ZOOM mode, press the **ZOOM** button again.
- It takes a short period of time from the time an operation such as changing channels is performed until an image is displayed. This is not a fault. This is the time needed for the image to stabilise before it can be displayed.
- The TV may make a crackling sound due to a sudden change in temperature. The picture or sound may be normal. If you hear crackling sounds frequently while you are viewing the TV, there may be other causes. As a precaution, ask your service technician to inspect it.
- The top of the TV and the screen may become hot during use but this has no affect on the performance of the TV. Make sure that the ventilation holes are not blocked.
- When the picture is unstable, the screen may become white for a moment. This happens when the signal which drives the liquid crystal is missing. This is not a fault.
- When a still image has been displayed for a long period, a faint residual image may remain on the screen for a short time after the power has been turned off or when another image is displayed. This is not a fault and the image will eventually disappear.

Specifications

Model	LT-Z32SX4B/LT-Z32SX4S
Broadcasting systems	B, G, I, D, K, K1, M
Colour systems	PAL, SECAM, NTSC 3.58/4.43 MHz
Channels and frequencies	VHF low channel (VL) = 46.25 to 168.25 MHz VHF high channel (VH) = 175.25 to 463.25 MHz UHF channel (U) = 471.25 to 863.25 MHz • Receives cable channels in mid band (X to Z+2, S1 to S10), super band (S11 to S20) and hyper band (S21 to S41).
Sound-multiplex systems	NICAM (B/G, I, D/K) system, A2 (B/G, D/K) system
Languages displayed by teletext	Please see the table in the description "TELETEXT LANGUAGE" on page 39.
Teletext systems	FLOF (Fasttext), TOP, WST (World Standard System)
Power requirements	110 - 240 V AC, 50/60 Hz
Power consumption	161 W (Standby: 2.8 W)
Screen size	Viewable area 80 cm (measured diagonally)
Audio output	Rated Power output: 10 W + 10 W
Speakers	6.6 cm round × 4
VIDEO-1 terminal (COMPONENT)	RCA connector × 3, S VIDEO connector × 1, Component connector × 1 • Video input, S VIDEO (Y/C) input, Component video (Y, Cb/Pb, Cr/Pr) input and Audio L/R inputs are available. • 625p, 525p and 1125i signals are available.
VIDEO-2 terminal	RCA connector × 3, S VIDEO connector × 1 • Video input, S VIDEO (Y/C) input and Audio L/R inputs are available.
VIDEO-3 terminal (COMPONENT)	RCA connector × 3 • Video input, Component video (Y, Cb/Pb, Cr/Pr) input and Audio L/R inputs are available. • 625p, 525p and 1125i signals are available.
OUT terminal	RCA connectors × 3, S VIDEO connector × 1 • Video output, S VIDEO (Y/C) output and Audio L/R outputs are available. • Output level 0.5 Vrms.
PC IN terminal	Analogue RGB D-SUB (15 pin) × 1 • PC signal is available. Refer to page 40 for details of the signals which can be input.
Headphone jack	Stereo mini-jack (3.5 mm in diameter)
Dimensions (W × H × D)	834 mm × 632 mm × 300 mm 834 mm × 568 mm × 108 mm (without stand)
Weight	20.6 kg 17.3 kg (without stand)
Accessories	Remote control unit × 1 (RM-C1830) AA/R6 dry cell battery × 2 Component video cable × 1

We may change the design and specifications without notice.

Pictures displayed on the screen using this TV's ZOOM functions should not be shown for any commercial or demonstration purpose in public places (cafes, hotels, etc.) without the consent of the owners of copyright of the original picture sources, as this would be an infringement of copyright.

Specifications

Model	LT-Z26SX4B/LT-Z26SX4S
Broadcasting systems	B, G, I, D, K, K1, M
Colour systems	PAL, SECAM, NTSC 3.58/4.43 MHz
Channels and frequencies	VHF low channel (VL) = 46.25 to 168.25 MHz VHF high channel (VH) = 175.25 to 463.25 MHz UHF channel (U) = 471.25 to 863.25 MHz • Receives cable channels in mid band (X to Z+2, S1 to S10), super band (S11 to S20) and hyper band (S21 to S41).
Sound-multiplex systems	NICAM (B/G, I, D/K) system, A2 (B/G, D/K) system
Languages displayed by teletext	Please see the table in the description "TELETEXT LANGUAGE" on page 39.
Teletext systems	FLOF (Fastext), TOP, WST (World Standard System)
Power requirements	110 - 240 V AC, 50/60 Hz
Power consumption	125 W (Standby: 2.8 W)
Screen size	Viewable area 64.8 cm (measured diagonally)
Audio output	Rated Power output: 10 W + 10 W
Speakers	6.6 cm round × 4
VIDEO-1 terminal (COMPONENT)	RCA connector × 3, S VIDEO connector × 1, Component connector × 1 • Video input, S VIDEO (Y/C) input, Component video (Y, Cb/Pb, Cr/Pr) input and Audio L/R inputs are available. • 625p, 525p and 1125i signals are available.
VIDEO-2 terminal	RCA connector × 3, S VIDEO connector × 1 • Video input, S VIDEO (Y/C) input and Audio L/R inputs are available.
VIDEO-3 terminal (COMPONENT)	RCA connector × 3 • Video input, Component video (Y, Cb/Pb, Cr/Pr) input and Audio L/R inputs are available. • 625p, 525p and 1125i signals are available.
OUT terminal	RCA connectors × 3, S VIDEO connector × 1 • Video output, S VIDEO (Y/C) output and Audio L/R outputs are available. • Output level 0.5 Vrms.
PC IN terminal	Analogue RGB D-SUB (15 pin) × 1 • PC signal is available. Refer to page 40 for details of the signals which can be input.
Headphone jack	Stereo mini-jack (3.5 mm in diameter)
Dimensions (W × H × D)	703 mm × 555 mm × 300 mm 703 mm × 491 mm × 107 mm (without stand)
Weight	16.1 kg 12.8 kg (without stand)
Accessories	Remote control unit × 1 (RM-C1830) AA/R6 dry cell battery × 2 Component video cable × 1

We may change the design and specifications without notice.

Pictures displayed on the screen using this TV's ZOOM functions should not be shown for any commercial or demonstration purpose in public places (cafes, hotels, etc.) without the consent of the owners of copyright of the original picture sources, as this would be an infringement of copyright.

JVC



JVC

Free Manuals Download Website

<http://myh66.com>

<http://usermanuals.us>

<http://www.somanuals.com>

<http://www.4manuals.cc>

<http://www.manual-lib.com>

<http://www.404manual.com>

<http://www.luxmanual.com>

<http://aubethermostatmanual.com>

Golf course search by state

<http://golfingnear.com>

Email search by domain

<http://emailbydomain.com>

Auto manuals search

<http://auto.somanuals.com>

TV manuals search

<http://tv.somanuals.com>