



LCD Television Users Guide

1080p HDTV

LT-32P300 32" class (31.5" Diagonal)

LT-42P300 42" class (42" Diagonal)

LT-42PM30 42" class (42" Diagonal)

LT-46P300 46" class (45.9" Diagonal)



As an "ENERGY STAR®" partner, JVC has determined that this product or product model meets the "ENERGY STAR®" guidelines for energy efficiency.

Please read the important notice for energy efficiency on page 7.

Important Note:

In the spaces below, enter the model and serial number of your television (located at the rear of the television cabinet). Staple your sales receipt or invoice to the inside cover of this guide. Keep this user's guide in a convenient place for future reference. Keep the carton and original packaging for future use.

Serial Number: _____

Model Number: _____

LCT2518-002C-A
0709TMH-II-IM

Warnings

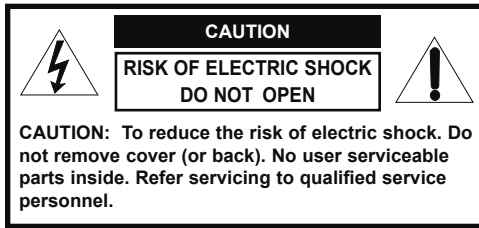

The lightning flash with arrowhead symbol, within an equilateral triangle is intended to alert the user to the presence of uninsulated "dangerous voltage" within the product's enclosure that may be of sufficient magnitude to constitute a risk of electric shock to persons.



The exclamation point within an equilateral triangle is intended to alert the user to the presence of important operating and maintenance (servicing) instructions in the literature accompanying the appliance.

WARNING: TO PREVENT FIRE OR SHOCK HAZARDS, DO NOT EXPOSE THIS APPARATUS TO RAIN OR MOISTURE.

CAUTION: TO INSURE PERSONAL SAFETY, OBSERVE THE FOLLOWING RULES REGARDING THE USE OF THIS UNIT.

1. Operate only from the power source specified on the unit.
2. Avoid damaging the AC plug and power cord.
3. Avoid improper installation and never position the unit where good ventilation is unattainable.
4. Do not allow objects or liquid into the cabinet openings.
5. In the event of trouble, unplug the unit and call a service technician. Do not attempt to repair it yourself or remove the rear cover.

Changes or modifications not approved by JVC could void the warranty.

- * When you don't use this TV set for a long period of time, be sure to disconnect both the power plug from the AC outlet and antenna for your safety.
- * To prevent electric shock do not use this polarized plug with an extension cord, receptacle or other outlet unless the blades can be fully inserted to prevent blade exposure.

IMPORTANT RECYCLING INFORMATION

This product has a fluorescent lamp that contains mercury. Disposal of these materials may be regulated in your community due to environmental considerations. For disposal or recycling information, please contact your local authorities or for USA, the Electronic Industries Alliance: <http://www.eiae.org>

Do not attempt to service the product yourself

Caution

To prevent electrical shock, do not open the cabinet.

There are no user serviceable parts inside.

Please refer to qualified service personnel for repairs.

Important Safety Instructions

- 1) Read these instructions.
 - 2) Keep these instructions.
 - 3) Heed all warnings.
 - 4) Follow all instructions.
 - 5) Do not use this apparatus near water.
 - 6) Clean only with dry cloth.
 - 7) Do not block any ventilation openings. Install in accordance with the manufacturer's instructions.
 - 8) Do not install near any heat sources such as radiators, heat registers, stoves, or other apparatus (including amplifiers) that produce heat.
 - 9) Do not defeat the safety purpose of the polarized or grounding-type plug. A polarized plug has two blades with one wider than the other. A grounding type plug has two blades and a third grounding prong. The wide blade or the third prong are provided for your safety. If the provided plug does not fit into your outlet, consult an electrician for replacement of the obsolete outlet.
 - 10) Protect the power cord from being walked on or pinched particularly at plugs, convenience receptacles, and the point where they exit from the apparatus.
 - 11) Only use attachments/accessories specified by the manufacturer.
 - 12) Use only with a cart, stand, tripod, bracket, or table specified by the manufacturer, or sold with the apparatus. When a cart is used, use caution when moving the cart/apparatus combination to avoid injury from tip-over.
- 
- 13) Unplug this apparatus during lightning storms or when unused for long periods of time.
 - 14) Refer all servicing to qualified service personnel. Servicing is required when the apparatus has been damaged in any way, such as power-supply cord or plug is damaged, liquid has been spilled or objects have fallen into the apparatus, the apparatus has been exposed to rain or moisture, does not operate normally, or has been dropped.
 - 15) Apparatus shall not be exposed to dripping or splashing and no objects filled with liquids, such as vases, shall be placed on the apparatus.
 - 16) Place the television on a stable, flat surface. Failure to do so can result in the television falling, causing injury.
 - 17) Do not allow young children to play around or on the television. Do not hang from the TV. Failure to do so can result in the television falling, causing injury.
 - 18) Do not allow young children to play with the plastic bag that came with the television when you unpacked it. Failure to do so can result in suffocation, causing injury.
 - 19) Avoid improper installation and never position the unit where good ventilation is impossible. When installing this TV, distance recommendations must be maintained between the set and the wall, as well as inside a tightly enclosed area or piece of furniture. Keep to the minimum distance guidelines shown for safe operation.

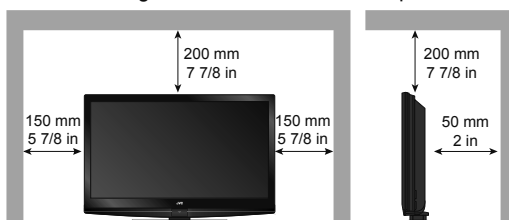

Important Safety Instructions

20) Cautions for installation

- Do not tilt the TV towards the left or right, or towards the back.
- Install the TV in a corner on the floor so as to keep cords out of the way.
- The TV will generate a slight amount of heat during operation. Ensure that sufficient space is available around the TV to allow satisfactory cooling.
- Have two people remove the TV from the box with the screen facing away from you. It's possible your clothing, (such as a belt buckle or button) may scratch the front of the TV. Do the same when moving the TV to another location.



21) When attaching to a wall, use the optional JVC wall mounting unit.

For LT-32P300: JVC-XUF-2637 LCD FLAT WALL MOUNT

For LT-42P300 / LT-42PM30: JVC-XUF-2637 LCD FLAT WALL MOUNT

For LT-46P300: JVCPCM-MS2 TILT/FLAT WALL MOUNT

Caution

- Consult qualified installers.
 - See the included manual on mounting procedures.
 - JVC is not responsible for damages or injuries due to improper mounting.
 - Use with other wall mounting unit is capable of resulting in instability or causing possible injury.
- 22) Make enough room for inserting and removing the power plug. Place the TV as close to the outlet as possible. The main power supply for this TV is controlled by inserting or removing the power plug.
- 23) Batteries shall not be exposed to excessive heat such as sunshine, fire or the like.
- 24) When this TV is connected to the wall outlet, it is always on standby even when all the LED lamps are not lit. To shut down the TV, unplug the TV from the wall outlet.

FCC Notice:

Caution: Changes or modifications not expressly approved by party responsible for compliance could void the user's authority to operate the equipment.

Note: This equipment has been tested and found to comply with the limits for a Class B digital device, pursuant to Part 15 of the FCC Rules. These limits are designed to provide reasonable protection against harmful interference in a residential installation. This equipment generates, uses and can radiate radio frequency energy and, if not installed and used in accordance with the instructions, may cause harmful interference to radio communications. However, there is no guarantee that interference will not occur in a particular installation. If this equipment does cause harmful interference to radio or television reception, which can be determined by turning the equipment off and on, the user is encouraged to try to correct the interference by one or more of the following measures:

- Reorient or relocate the receiving antenna.
- Increase the separation between the equipment and receiver.
- Connect the equipment into an outlet on a circuit different from that to which the receiver is connected.
- Consult the dealer or an experienced radio/TV technician for help.

Table of Contents

Warnings	2
Important Safety Instructions	3

Getting Started

Key Features	6
Logos & Licenses	7
Package Contents	8

Basics

TV Basic Controls	13
Remote Control	18
Initial Setup	22

Advanced

Customizing your TV	24
Picture	26
Video Status	26
Color Temp	27
Color Management	27
Dynamic Gamma	27
Smart Picture	27
Digital VNR	27
MPEG NR	27
Natural Cinema	27
Video Reset	27
Display	28
Video Input Label	28
Photo Viewer	28
Aspect	30
TV	31
Closed Caption	31
C.C. Type	31
C.C. Setting	31
Tuner Mode	32
Auto Scan	32
Add Channel	32
Edit Channel	33
V-Chip	33
Password	34
MPPAA	35
Can. Eng.	36
Can. Fre.	36

TVPG	37
Guide	37

PC	38
Auto Adjustment	38
Phase Adjustment	38
PC H-Position	38
PC V-Position	38
Reset	38

Sound	39
MTS	39
Digital Audio (ML)	39
Surround	39
Sound Status	39
Audio Reset	39

Power	40
Power Indicator	40
Illumination	40

Setting	41
Plug-In Menu	41
Time Zone	41
D.S.T.	41
Language	41
Noise Mute	41
Front Panel Lock	41
Transparency	41
Auto Shut Off	41
Control with HDMI	42
System Info	42
Auto Demo	42
Optical Out	43
PC Smart Input	43
Sync Mode	43

Enjoy Movies/Music from your iPod	44
Programming Your Remote	51

Etc.

Programming Codes	53
Connecting Your Devices	58
Troubleshooting	64
Specifications	66
Warranty	67

Key Features

Your JVC TV is equipped with many features. Here is some key features highlighted in detail.

- 1 Simple playback of video and music on TV. You can charge your iPod. You can watch a program while listening to the iPod (source of program must be from TV's Internal Tuner). You can view photos from the iPod while listening to the iPod.

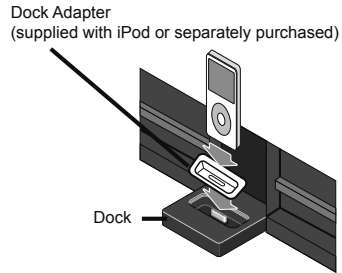

- 2 Stunning picture quality via 1920x1080 Full HD panel. Dynamic Gamma and Color Management give further fine tuned picture reproduction. Smart Picture adjusts the best possible picture quality automatically scene by scene based on the incoming signal from any source!



- 3 JVC exclusive oblique cone speakers provide excellent TV sound quality. OmniSurround sound provides you 4 different settings based on the program you are watching. The equalizer will fine tune your listening preferences.



- 4 Full connectivity with 3 HDMI, 2 Component, 1 S-video and others. The variety of connections are explained in pages 58 to 63.

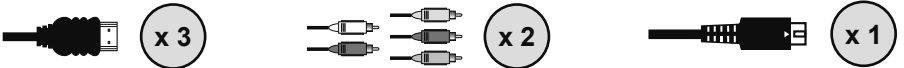

- 5 Aspect mode will show every pixel you are getting in High Definition. The Full Native mode will show 100% of 1080p. Full – with slight overscan. Panorama, Cinema will fill the screen with various aspect settings.



Full or Widescreen Mode

Logos & Licenses



As an "ENERGY STAR®" partner, JVC has determined that this product or product model meets the "ENERGY STAR®" guidelines for energy efficiency.

This JVC Television is factory set to "Home" mode, which is optimized for normal home viewing. This setting reduces power consumption to help the environment and to comply with ENERGY STAR® qualification.

Enabling certain features and functionality in this TV (e.g., Video Status) may increase its energy consumption, possibly beyond the limits required for ENERGY STAR® qualification.



iPod is a trademark of Apple Inc., registered in the U.S. and other countries.



Manufactured under license from Dolby Laboratories. "Dolby", and the double-D symbol are trademarks of Dolby Laboratories.



HDMI, the HDMI Logo and High-Definition Multimedia Interface are trademarks or registered trademarks of HDMI Licensing LLC.

Notice:

- The open source software is embedded in this product. For more information, please go to: http://software.jvc.com/opensource/Inx/DP/08_AtscQam_T/download.html

Package Contents

Television x 1



Remote Control x 1



AA Batteries x 2



Bottom Cover x 1



Screw x 1



Insert the batteries

Use two "AA" batteries (included).

Place the "-" end in the unit first, making sure the "+" and "-" markings are correct. Place the "-" end in the unit first.

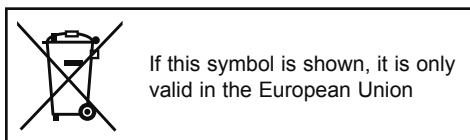
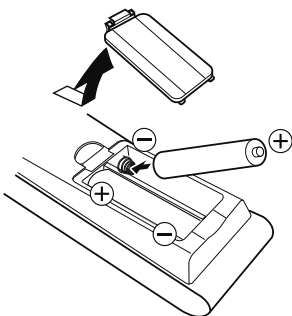

Caring for the frame and stand

Your TV has a glossy frame and stand which have protection sheets attached to them. Peel them off before use, but only after the TV has been properly placed. Take care with handling the glossy frame and stand because these surfaces are delicate.

Normally, light dusting with a soft, non-scratching duster will keep your TV clean. If you wish to wipe down the television, first unplug it. Then wipe gently with a soft cloth, slightly moistened with water. You can add a few drops of mild liquid detergent to the water to help remove spots of oily dirt.

- DO NOT allow liquid to enter the TV through the ventilation slots.
- DO NOT use strong or abrasive cleaners on the TV.
- DO NOT spray liquids or cleaners directly on the TV's surface.
- DO NOT rub or scrub the TV harshly. Wipe the set gently with a soft cloth.

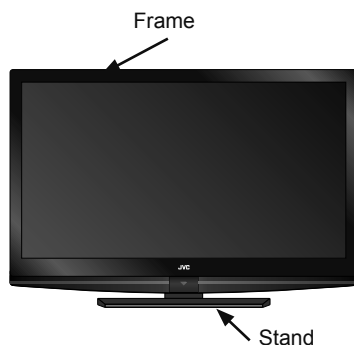

Caring for the Screen

The screen is treated with an electrostatic-proof coating. When it gets dirty, wipe it gently with a soft cloth. If the screen is very dirty, wipe it down with a cloth dipped in a diluted kitchen cleaner and thoroughly wrung-out. Then wipe immediately after with a clean, dry cloth.

- DO NOT apply alcohol, organic solvents (like acetone), acidic or alkaline cleansers to the screen. These will remove the coating layer and cause discolorations.
- DO NOT push or hit the screen. This could cause scratches on the screen surface and image distortions.

Package Contents

Avoiding Temporary Burn-in

Displaying fixed images for extended periods of time can leave a subtle but temporary burn-in image on your screen. To avoid this, mix your viewing pattern.

Examples include, but are not limited to the following:

- Stock-market report bars
- Shopping channel logos and pricing displays
- Video game patterns or scoreboards
- Bright station logos
- Internet web sites or other computer-style images
- DVD discs, video tapes, laser discs
- Broadcast, cable, satellite channels or digital television tuners/converters

For example...

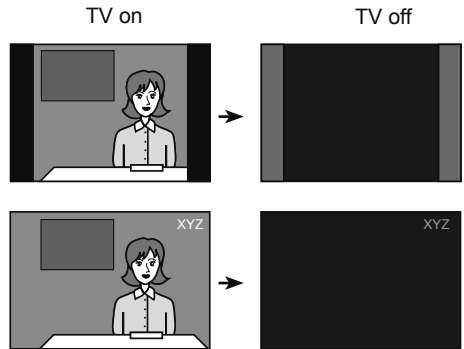

Disconnecting the back panel screw

The LT-46P300 has one screw on the back panel hole for safety use. Please remove the screw when you are attaching a wall mounting unit and placing the TV onto a wall.

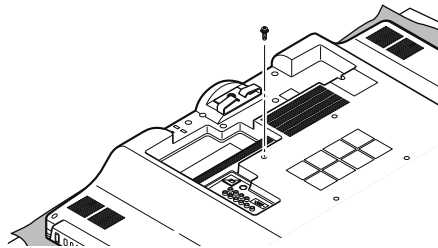

Install your TV

To prevent the TV from falling, thread the belt through the hole on the back of the stand and secure it to the TV rack.

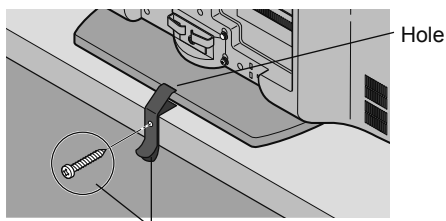

Belt and screw (not included)

Tidying the cables

A cable holder which keeps your connection cables tidy is attached to the back of the stand.

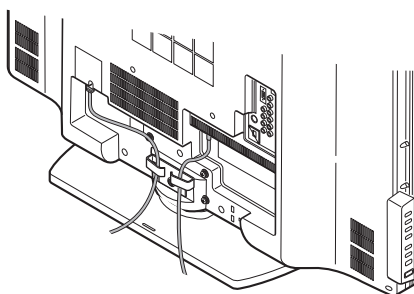

Connect the stand

The LT-32P300 TV stand is not attached to the TV when you purchased it. Please follow the steps below on how to connect the stand to the TV.

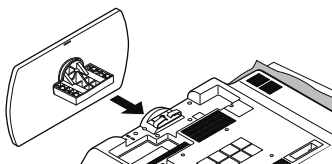

1) Insert the TV stand onto the TV.

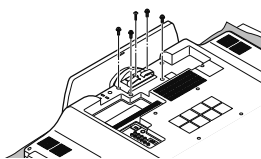

2) Tighten the 5 screws to the back of the TV.

Package Contents

Disconnecting the stand

If you disconnect the stand, attach the bottom cover and the screw (supplied) into the hole.

- 1) Place the TV face down on a soft cloth on a table.
- 2) Remove the screws from the back of the TV.

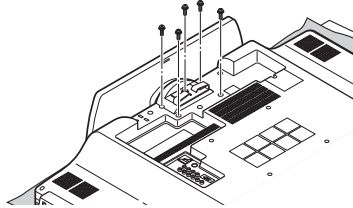

- 3) Pull out the stand from the TV.

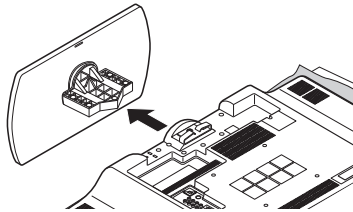

- 4) Cover the hole with the supplied bottom cover and tighten the screw.

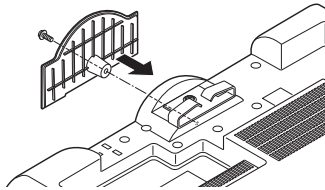

Notes:

- To re-install the stand, reverse the procedure from **4)** to **1)**.
- If you find it difficult to remove the screws from inset screw wells, use a magnetized screwdriver.

TV Basic Controls

Front Panel

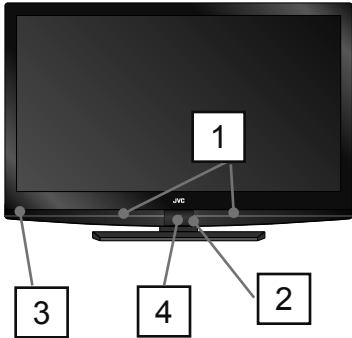

1 Diffuser Illumination

2 Dock

Notes:

- Do not use unreasonable force to the Dock.
- When not using the Dock, close the cover.
- Do not touch the connector pins of the Dock or the iPod terminal pins.
- Do not put different devices on the Dock. It may cause a connection failure.

3 Remote Control Sensor

4 Power Lamp

Side Panel

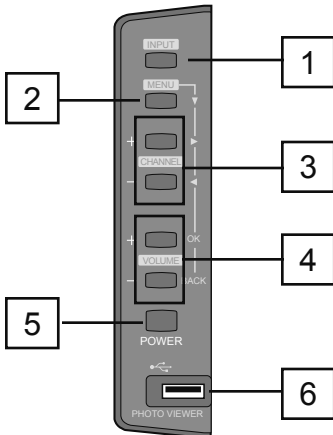

1 **Input**
Change the input

2 **MENU**
Used to access the TV's onscreen menus.

3 **+CHANNEL-**
Move sequentially through the channels.

4 **+VOLUME-**
Raises or lowers the volume.

5 **POWER**
Turn the TV on or off.

6 **Photo Viewer Connector**

Note:

- Do not use Photo Viewer connector to connect the iPod

TV Basic Controls

Rear Panel

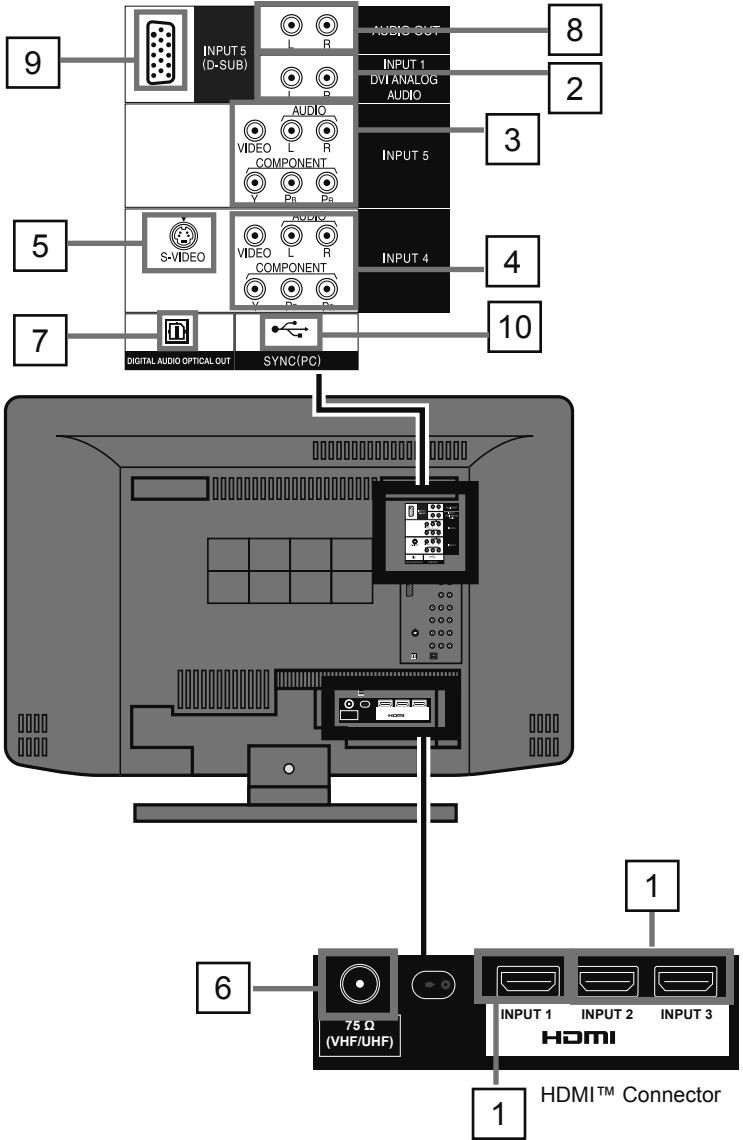

* This is used when you are using DVI analog audio

Before you connect your television to another device, please refer to the proper diagrams for your specific TV and remote. These will help assist you in understanding how to connect your television to another device, as well as use the remote to set up your television. Some of the connection terminals are color coded for easy connection with the proper cables.

To find the best possible connection that your device can use, see pages 16 - 17.

For more detailed information about connecting external devices, see pages 58 - 63.

- 1 HDMI (INPUT 1, 2, or 3)
- 2 DVI ANALOG AUDIO
- 3 4 Composite / Component (INPUT 4 or 5)
- 5 S-Video

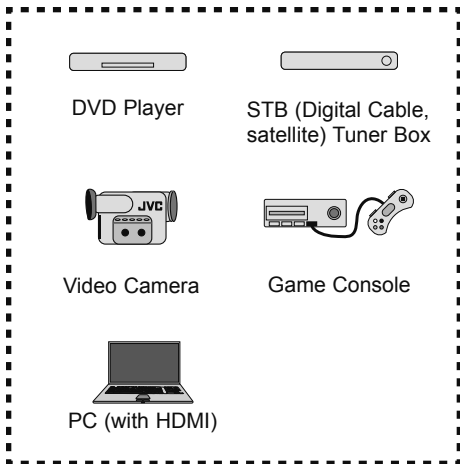

- 6 Antenna / Cable

- 7 DIGITAL AUDIO OPTICAL OUT

- 8 AUDIO OUT

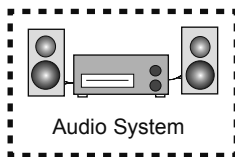

- 9 D-SUB

- 10 USB type B (for PC)
See page 50.

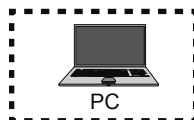







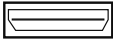

TV Basic Controls

Video

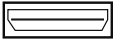
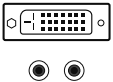
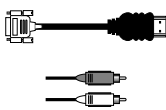
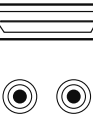
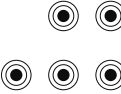
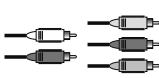
Best

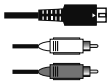
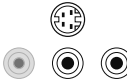

Good







Video Connection	Connection Cable	TV Connection	
 HDMI	 HDMI Cable	 INPUT 1, 2 or 3	
 DVI + Audio	 DVI – HDMI Cable, Audio Cable	 Input 1 + DVI ANALOG AUDIO	
 Component Video + Audio	 Component Video + Audio	 INPUT 4 or 5	
 S-Video + Audio	 S-Video Cable, Audio Cable	 INPUT 4 + AUDIO Input	
 Composite Video + Audio	 Composite Video + Audio	 INPUT 4 or 5	

Audio

Best



Good







Audio Connection	Connection Cable	TV Connection	
 OPTICAL INPUT	 OPTICAL AUDIO Cable	 DIGITAL AUDIO OPTICAL OUT	
 AUDIO INPUT (L / R)	 Audio Cable	 AUDIO OUT (L / R)	









Compatible Signal	Notes
Input <ul style="list-style-type: none"> • HDMI (Digital) <ul style="list-style-type: none"> SD: 480i, 480p HD : 720p, 1080i, 1080p/24Hz, 1080p/30Hz, 1080p/60Hz • Audio L/R 	HDMI™ (v.1.3, HDMI™ CEC Support) Please use a High Speed HDMI™ Cable. High Speed HDMI™ Cable are tested to carry an HD signal up to 1080p and higher. See pages 62, 63.
Input <ul style="list-style-type: none"> • DVI (Digital) <ul style="list-style-type: none"> SD: 480i, 480p HD : 720p, 1080i, 1080p/24Hz, 1080p/30Hz, 1080p/60Hz • Audio L/R (Analog) 	See page 61, 63.
Input <ul style="list-style-type: none"> • Component (Analog) <ul style="list-style-type: none"> SD: 480i, 480p HD: 720p, 1080i • Audio L/R (Analog) 	See page 59.
Input <ul style="list-style-type: none"> • S-Video (Analog) • Audio L/R (Analog) 	See pages 59, 61.
Input <ul style="list-style-type: none"> • Composite (Analog) • Audio L/R (Analog) 	See page 59.

Compatible Signal	Notes
Output <ul style="list-style-type: none"> • Audio L/R (Digital) (PCM or Dolby Digital) 	See page 60.
Output <ul style="list-style-type: none"> • Audio L/R (Analog) (Fixed) 	See page 60.

Remote Control





The following pages gives you a brief description of each button's function. This remote can also control up to four other devices. See pages 51 - 52.

	<p>Allows you to set the TV to turn on and set the TV to turn off automatically after a set amount of time and channel of your choice. On Timer / Input / Sleep Timer</p> <div data-bbox="488 358 818 542" style="border: 1px solid black; background-color: black; color: white; padding: 5px;"> <p style="text-align: center;">Timer</p> <hr/> <p>On Timer ◀ 0 h 0 m ▶</p> <p>Input 0 - 0</p> <p>Sleep Timer 0 min</p> </div> <p>Notes:</p> <ul style="list-style-type: none"> • If you set the interval of On Timer by pressing the ◀ ▶ buttons, select channel at Input and press OK. • After you set On Timer and turn off the TV, power lamp lights. • You can check the remaining time of On Timer by displaying this menu again. • You can set the interval of Sleep Timer by pressing the ◀ ▶ buttons. • 60 seconds before the TV turns off, a message will appear and it will count the remaining time. • See page 50, "On Timer using iPod".
	<p>Turns the TV on or off.</p>
	<p>Switch between "TV / STB / VCR / DVD / AUDIO" devices. See page 51.</p>
	<p>Switch between devices connected to Video-1, 2, 3, 4 and 5. For V4 (Video-4) and V5 (Video-5) you must select the signal input type first (ie. composite, S-Video, or component). To do so, you need to press the V4 or V5 button until the correct type is highlighted. Select "Composite 1" for composite video signal input, "S-Video" for S-video signal input, or "Component 1" for component video signal input. Select "Composite 2" for composite video signal input or "Component 2" for component video signal input. Select PC for PC signal input.</p>
	<p>Change channels. Input remote codes. See page 51.</p>
	<p>Lets you decide the input channel and select it. After pressing the remote 0 - 9 buttons, press TUNE.</p>

	<p>Has three functions.</p> <p>Return – Returns to the channel viewed just before the channel currently onscreen.</p> <p>Return+ – Lets you program a specific channel to return to while scanning through the channels using the - CH + button as you memorize the channel.</p> <p>TV – Returns to the TV mode as you are watching a video, DVD, etc.</p> <p>Note:</p> <ul style="list-style-type: none"> • Press TUNE and RETURN+ TV buttons. This will memorize the current channel to return to while you scan through the other channels. To cancel, press TUNE and RETURN+ TV buttons again.
	<p>Move sequentially through the channels.</p>
	<p>Raise or lower the volume.</p>
	<p>Control your iPod connected to the TV. See page 46.</p>
	<p>Turns the TV volume to 0. Press again to restore the volume.</p>
	<p>Used to access the TV's onscreen menus. See page 24.</p>
	<p>Used to navigate through the TV's onscreen menus.</p>
	<p>Go back to a previous onscreen menu or to correct a mistake.</p>

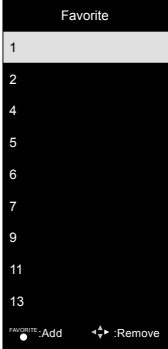

Remote Control

	<p>Allows you to save channels you like so you can view them easily. First you must register the channels you like.</p>  <p>Notes:</p> <ul style="list-style-type: none"> • Go to the channel you want to register and press the FAVORITE. A list will appear. Press the FAVORITE button again to register your channel. • To view your favorite channels, press FAVORITE. Move ▲▼ to select your channel and press OK. • To erase your favorite channels, press FAVORITE. Move ▲▼ to select your channel and press ◀▶. • Both analog and digital channels can be registered. • The channels you registered will appear in numerical order at the top of the list.
	<p>Allows you to adjust the way the image appears on your TV based on the format that is being received.</p> <p>Full / Regular / Slim / Panorama / Cinema / Full Native</p> <p>See page 30.</p>
	<p>You can choose several types of sound modes.</p> <p>Speech / Jazz / Classic / Rock / User</p> <p>See page 39.</p>
	<p>Allows you to choose different picture settings according to personal preferences. You can access this feature for each input (TV, V1, V2, V3, V4, V5).</p> <p>Standard / Dynamic / Theater / Game</p> <p>See page 26.</p>
	<p>You can view program information for Digital Channels.</p> <p>Note:</p> <ul style="list-style-type: none"> • The GUIDE will not show the correct time and date depending on the Time Zone and D.S.T. settings. See page 41.

<p>SUB CH TV/VCR</p>	<p>Digital broadcast sometimes offers sub channels. By using the SUB CH button, you can select a sub channel easily.</p> <p>For example, to move to sub channel 123-45:</p> <ol style="list-style-type: none"> 1) Press 1, 2 and 3 in order 2) Press the SUB CH button 3) Press 4 and 5 in order 4) Press the TUNE button
<p>ML/MTS SUB T.</p>	<p>Allows you to listen to a program in Stereo, Mono sound or another language (Sap) if available. First you must set the MODE to TV on your remote.</p> <p>Notes:</p> <ul style="list-style-type: none"> • When you are receiving a digital broadcast, if there are other languages, you can change the language by pressing the ML/MTS button. • Keep the TV in stereo mode to get the best sound quality. The sound will work in stereo mode even if a certain broadcast is in mono sound only. • Choose the mono setting to reduce excessive noise on a certain channel or broadcast. • MTS is unavailable if your television's Input source is (V1, V2, V3, V4, V5). • ML/MTS will not work when you are using HDMI.
<p>DISPLAY ▲</p>	<p>View current channel information.</p>

* See page 52 for buttons that control your external devices.

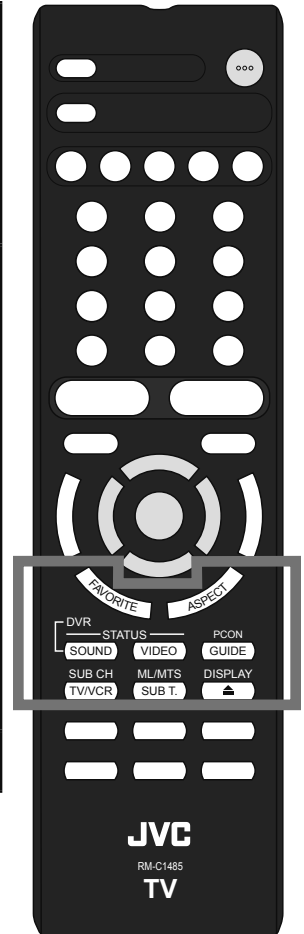

Initial Setup

When you turn on your TV for the first time, the Initial Setup menu appears automatically. These menus will help you setup your TV with basic information for **Language**, **Time** and **Tuner Setup**. You can also set this setting in the **Plug In Menu**. See page 41.

1) Turn on the TV

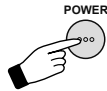

2) Set the language

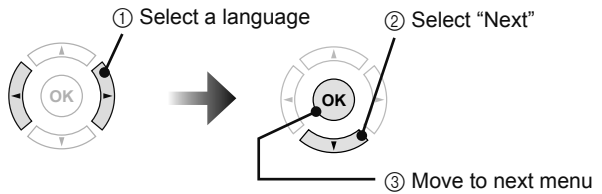
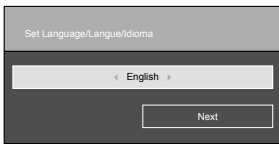

3) Set the mode

Select **Home** for use at home.
Retail is used in the TV store.

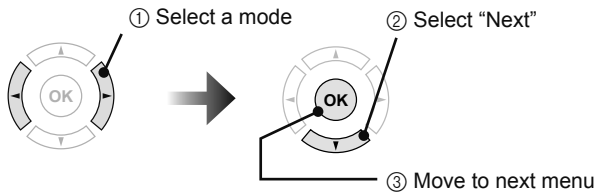
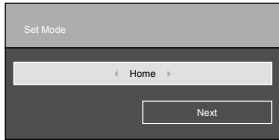

4) Set time attribute

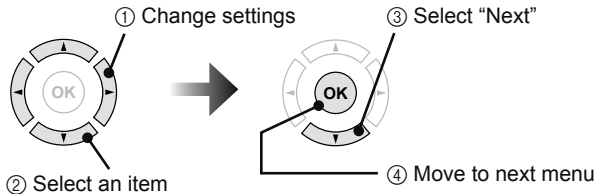
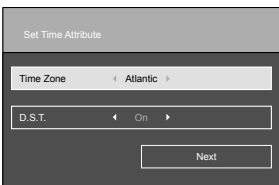

Time Zone	Choose the time zone you live in.
D.S.T.	Changes the clock automatically for daylight saving time. On / Off

5) Set TV attribute

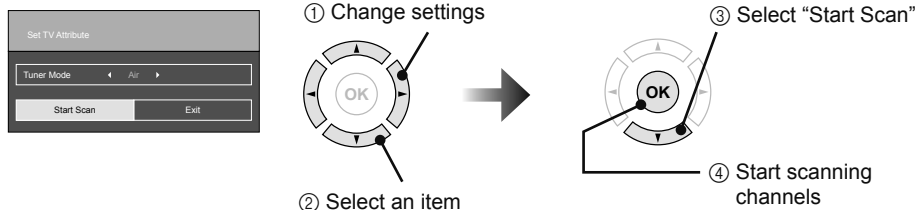

Tuner Mode	Choose Air (antenna) or Cable
------------	-------------------------------

Notes:

- If you use a set top box (satellite or cable box), press **Exit** to skip this step.
- If you want to turn off the Auto Demo, press the **MENU** button.

“Thank you! Setup is now complete”

Cable Users: After your auto tuner setup is complete, you may, (depending on the type of hookup), have only 1 channel, usually 2, 3 or 4 in the auto tuner memory. This is normal.

We have an important note for customers who subscribe to basic cable services (do not have a separate cable box) and plan to use their JVC TV remote control to select channels.

Once you run the Auto Tuner Setup (which detects and programs all the channels your TV is receiving through the RF input), every channel number available from your cable company will appear in your television's Channel Summary and they will all be marked as available for scanning. Even though every channel is detected and appears as available, you will only be able to view those that you specifically subscribe to from your cable company. This will likely mean there are blank channels between those channels you wish to scan or “surf”.

We apologize for any inconvenience this may cause but it is important to note that this is not a malfunction of your television. If you want to sequentially scan those channels you subscribe to without blank ones in between, you can contact your cable company for their cable box and remote, or manually deselect them using the edit / skip feature on page 33.

Customizing Your TV

You can customize your TV by operating the menus on the TV screen. The TV screen displays the Menu Bar, Menu Item and available items are highlighted.



Explanation of function displays

Using the menus

1) Display the menu bar



2) Display the desired menu

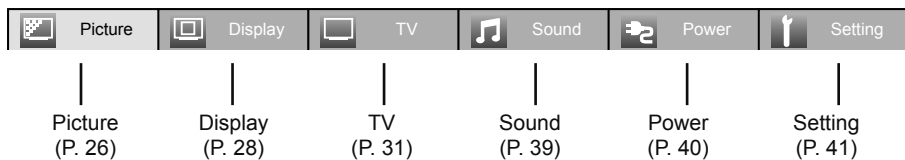

① Press ◀▶ to select a menu

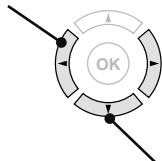

② Press ▼ to select a menu item

3) Change or adjust the setting

Video Status	◀ Standard ▶
Tint	◀ 0 - 50 - 100 ▶
Color	◀ 0 - 25 - 100 ▶
Contrast	◀ 0 - 50 - 100 ▶
Bright	◀ 0 - 43 - 100 ▶
Detail	◀ 0 - 94 - 100 ▶
Backlight	◀ 0 - 50 - 100 ▶
Color Temp	◀ Cool ▶
Color Management	◀ Off ▶
Dynamic Gamma	◀ On ▶
Smart Picture	◀ On ▶
Digital VNR	◀ High ▶
MPEG NR	◀ On ▶
Natural Cinema	◀ On ▶
Video Reset	

① Press ▲▼ to select a menu item

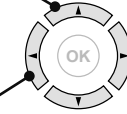

② Press ◀▶ to change the setting

■ To enter an item's sub menu

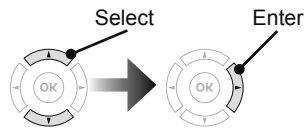

(Example: Photo Viewer)

■ To the previous screen



4) Close the menu



Note:

- Depending on the situation (analog channels, digital channels, video signal format, external inputs, etc.), some items will be displayed in gray and can not be selected.

Customizing your TV



Video Status

Choose different display settings according to personal preferences. You can use this feature with TV, V1, V2, V3, V4 and V5.

Standard

Resets the picture display to the factory settings.

Dynamic

Gives a vivid picture with better contrast when viewing in a brightly lit room.

Theater

Gives a rich, film-like look to video when viewing in a dimly lit room.

Game

Used for when you are playing video games connected to your TV.

Notes:

- Each mode is memorized for each analog TV / composite / S-Video, digital TV, HDMI, component signal input.
- Each video status can be chosen along with your favorite picture settings (**Tint**, **Color**, **Contrast**, **Bright**, **Detail** and **Backlight**).

■ Allows you to change and adjust the way the picture appears on your television.

Tint

Allows you to adjust the levels of red and green on your TV.

Color

Allows you to make all the colors on your TV appear more vivid or subtle.

Contrast

Allows you to adjust the level of black and white on your TV giving you a darker or brighter picture overall.

Bright

Allows you to adjust the overall brightness of the TV.

Detail

Allows you to adjust the level of fine detail on your TV.

Backlight

Allows you to adjust the brightness of the internal lamp which effects the overall brightness of the TV.

Color Temp

Allows you to adjust colors to look as accurate as possible. **Cool / Natural / Warm**

Color Management

Allows you to compensate for dull colors to ensure dull colors are reproduced with natural hues.
On / Off

Dynamic Gamma

Allows you see more detail in very dark or bright areas so these areas don't appear "muddied". Normally, this feature should be left **On** for optimum picture quality. **On / Off**

Smart Picture

Allows the TV to adjust the brightness level automatically to a level suitable for what you are watching. **On / Off**

Digital VNR

This function can be selected to change the effect of **Digital VNR** (Video Noise Reduction).

High – Adjusts the effect maximally

Low – Adjusts the effect minimally

Off – Function is turned off.

MPEG NR

This function effects the block noise removal and mosquito NR (Noise Reduction) simultaneously.

Note:

- When you are receiving digital channels, block noise removal will have no effect.

Natural Cinema

Allows you to compensate for image blurring when the original video you are watching was shot at 24 frames/sec, and is broadcast at 30 frames/sec. This conversion process is known as "TELECINE". **On / Off**

Notes:

- When you are receiving a 480p, 720p or 1080p signal, **Natural Cinema** cannot be selected.
- **Natural Cinema** is only applied for NTSC, SD 480i and HD 1080i signals.

Video Reset

Resets all picture adjustments at once to the default settings, except for **Natural Cinema**.

Customizing your TV

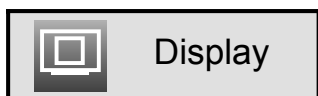

Video Input Label

Allows you to label all the devices you have connected to the TV that use the VIDEO-1, 2, 3, 4 and 5 inputs.

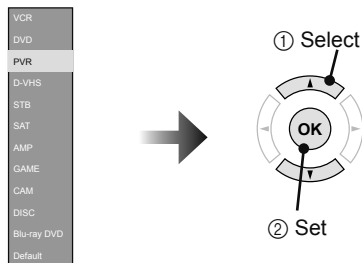
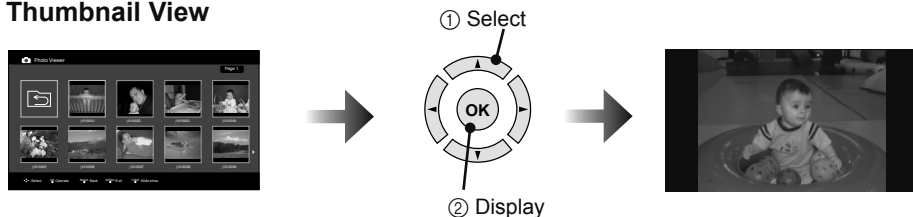

Photo Viewer

Photo Viewer allows you to enjoy your digital pictures stored on your USB Mass Storage Class devices. You can view them on the TV in high quality if USB Mass Storage device is connected to the Photo Viewer terminal on the TV.

Thumbnail View



When you select **Thumbnail view** and press **OK**, a folder or file list will be displayed. Select your folder by using the ◀▶ or ▲▼ buttons. Choose a picture and press the **OK** button. It will now be shown on the screen. To move to the next picture, press the ▶ button. To move to the previous picture, press the ◀ button.

* If there is more than 10 images, those images will be shown in the next page. To go to the next page, select the last image on the page and press the ▶ or ▼ buttons. To go back to the previous page, press the ◀ or ▲ buttons.

Slide Show

– In **Thumbnail View** screen, you can view slide show by pressing the **TUNE** button.

Photo Viewer with iPod

– In **Thumbnail View** screen, you can listen to music content stored on your iPod. Start your iPod to play music, and put it on the TV's Dock. You cannot operate iPod with TV remote.



Display help screen



90° Rotation



(in Slide Show)
Play/Pause



Move to the upper left



Move to the right



Move up



Move to the lower left



Move to the upper right



Move down



Move to the left



Move to the lower right



Reset

* Move functions only work when pictures are zoomed in.



Enlarge



Reduce

Interval

Choose Slide Show Interval of 5, 10 or 20 seconds by pressing the ◀ ▶ buttons.

Notes:

- Gently pull out your USB device from the Photo Viewer terminal after finishing the **Photo Viewer** menu.
- Use the supplied USB cable that came with your device. Do not use HUB or USB extension cable.
- **Photo Viewer** cannot be guaranteed to work with all USB Mass Storage Devices. It may take some time to display or it may not display correctly.
- Please refer to the Customer Support website at www.jvc.com/support for information and notes regarding your devices you wish to connect.
- Supported file formats are “.jpg” or “.JPG”.
- All your stored data should be backed up first as a precaution before connecting to the TV.
- Depending on your stored file size, it can take extra time to display “Photo Viewer” page.
- Depending on your stored file type, some data may not be able to be displayed in the thumbnail screen.
- You may only view HDD photos when using HDD equipped Everio Cameras.



Display Continued...

Customizing your TV

Aspect

Allows you to adjust the way the image appears on your TV based on the format that is being received.

Full - When watching a 4:3 aspect picture, it is stretched to fit the dimensions of the TV. When watching a 16:9 aspect picture, it displays 95% of the ratio.

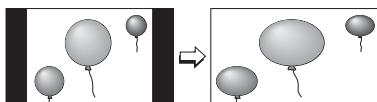

Panorama - When watching a 4:3 aspect picture it is stretched to fit the dimensions of the 16:9 aspect screen.

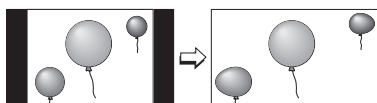

Full Native - This ratio displays 100% of the ratio. Normally, all aspects except for **Full Native** display about 95%.

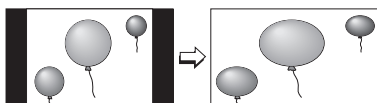

Regular - When watching a 4:3 aspect picture without modifying the original picture to fit the dimensions of your 16:9 screen. Black bars will appear along the picture's sides. The picture will be centered within the boundaries of the 16:9 screen.

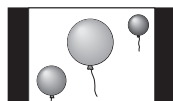

Cinema - This ratio "zooms in" on the center part of a 4:3 aspect picture, blowing it up proportionally to fill the 16:9 screen.

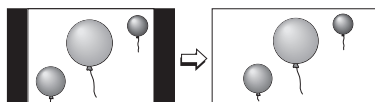

Slim - This aspect mode shrinks the screen of a 16:9 broadcast to 4:3. There are some programming that is already stretched by mistake at broadcasting companies, so this mode corrects it. Black side bars will appear.

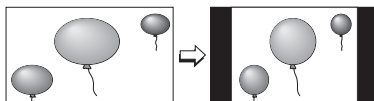

Notes:

- Depending on the signal format, some aspect modes are unavailable.
- If you change the aspect mode after the television changed it to **Full** automatically, the television will change to the aspect mode you choose. It also turns to **Full** automatically when the TV receives an HD (1080p, 1080i or 720p) signal.
- In iPod mode, selections of **Aspect** menu changes to **Full / Regular / 16:9 Mini / 4:3 Mini**.



Closed Caption

Allows you to select the mode of the closed caption. First you must set the **MODE** to either **TV**, **STB** or **VCR** on your remote. **On / Smart / Off**

Note:

- **Smart** caption will appear when you press the **MUTING** button only on channels where the broadcast contains closed captioning.

C.C. Type

Allows you to select the type of the closed caption. **Basic** is for analog channel's caption, and **Advanced** is for digital channel's caption. **Auto / Basic / Advanced**

C.C. Setting

You can choose between caption or text in mode to decide how closed captioning will appear.

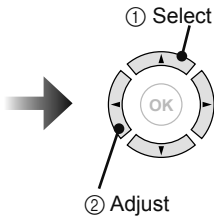
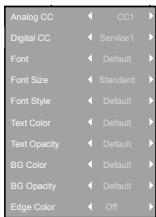

Analog CC

Choose the CC feature that you like for analog closed captioning.

Digital CC

Choose the CC feature that you like for digital closed captioning.

Font

Choose the font that you like for closed captioning.

Font Size

Choose how big the text appears in closed captioning.

Font Style

Choose the style of the font in closed captioning.

Text Color

Choose the color of the text in closed captioning.

Text Opacity

Choose how translucent the text appears in closed captioning.

Customizing your TV

BG Color

Choose the background box color for the Closed Captioning text.

BG Opacity

Choose how translucent the background box color for the Closed Captioning text.

Edge Color

Choose the color of the border of the background box color for the Closed Captioning text.

Note:

- The **Font**, **Font Size**, **Font Style**, **Text Color**, **Text Opacity**, **BG Color**, **BG Opacity** and **BG Color** settings will not apply to closed caption of analog channels. In addition, some of these settings for closed caption for digital channels may or may not be available, depending on the closed captioning data being broadcast.

Tuner Mode

If you skipped this step in the initial setup or your setup has changed, you can redo your setup in this menu. **Air / Cable**

Autoscan

Allows you to scan through all available channels your TV can receive, and memorizes them.

Note:

- The Autoscan is finished when the message “**Scanning has completed**” appears on the screen.

Add Channel

Allows you to add analog channels. Regarding digital channels, the only channels that will appear are the ones that are being broadcast.

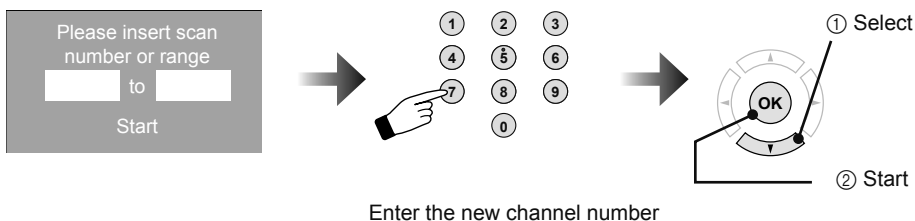

Edit Channel

Allows you to skip channels when using the + CH - button. "✓" means don't skip, " " means to skip. You can still access those skipped channels manually using the number buttons on the remote.

Main Channel List	
✓	3-2 CH-2
✓	3-3 CH-3
✓	5-0
✓	6-0
✓	6-0
✓	11-0
✓	14-0
✓	22-1 CH-1
✓	36-0
✓	63-0

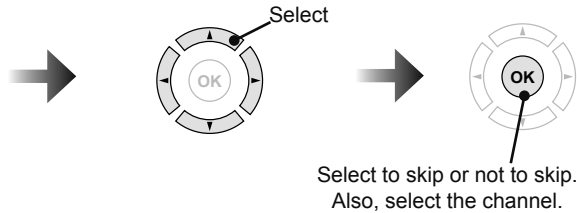

V-Chip

Allows you to block channels or content that you deem inappropriate for children.

Notes:

- **V-CHIP** will not work with video signals from VCRs, DVD players, Blu-ray or camcorders connected to the TV.
- **(For Canadian viewers only)** V-CHIP is designed specifically for the US and may not work properly in Canada.

– When entering the password –

When you try and access the **V-Chip** menu, "Please input password" will appear. Press the "0" button four times on your remote to access the **V-Chip** menu for the first time.

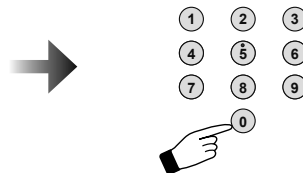
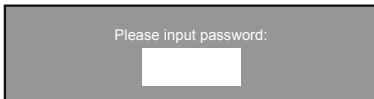

Customizing your TV

– When you lock or unlock channels –

You can lock or unlock ratings as shown below.

Password	NR	
MPAA	G	
	PG	
Can. Eng.	PG13	
Can Fre.	R	
	NC-17	
TVPG	X	

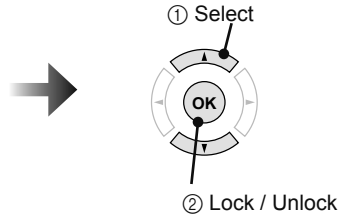

Note:

- If you lock a rating, any rating that is higher is automatically blocked.

Password

New Password	_____
Confirm Password	_____
OK	Clear

You can change the four digit password using the number buttons on your remote.

* If you forget your password, unplug the TV from the wall and then plug it back in. Your password will reset to "0000"

1) Set a new password

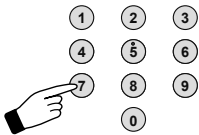

Enter the four digit number

2) Confirm and set

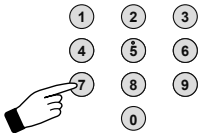







Next



Set

Enter the four digit number

MPAA

NR	
G	
PG	
PG13	
R	
NC-17	
X	

This setting is based on the US Motion Picture Association of America (MPAA) ratings system.

NR – Not Rated.

Any type of programming that does not contain a rating.

G – General Audience.

Suitable for all ages.

PG – Parental Guidance Suggested.

Suitable for all ages with parental guidance.

PG 13 – Parents Strongly Cautioned.

Intended for viewers 13 years or older.

R – Restricted.

Not recommended for viewers 17 years without parental guidance.

NC-17 – No One Under 17.

Not intended for viewers 17 years or younger.

X – No One Under 18.

Not intended for viewers 18 years or younger.

Viewing Guidelines:

At the beginning of a program, the program will display its rating and the content it contains **(Except for unrated programming)**.

A program can contain any or all of the following:

V/FV – VIOLENCE/FANTASY VIOLENCE

S – SEXUAL Content

L – Strong LANGUAGE

D – Suggestive DIALOG



TV Continued...

Customizing your TV

Can. Eng.

E	
C	
C8+	
G	
PG	
14+	
18+	

This setting is based on the Canada ratings system.

E – Exempt.

Any type of programming that does not contain a rating.

C – Intended for children.

Suitable for all ages.

C8+ – Intended for children over 8 years old.

Suitable for all ages over 8 years.

G – General Audience.

May contain material not suited for younger viewers.

PG – Parental Guidance.

May contain material not suited for younger viewers. Parents may consider some content not appropriate for children 8 - 13 years old.

14+ – 14 Years or Older.

Parents strongly urged to use their discretion in allowing viewing by persons under 14.

18+ – Adult.

Intended for viewers 18 years or older.

Can. Fre.

E	
G	
8 Ans+	
13 Ans+	
16 Ans+	
18 Ans+	

For instructions on **Can. Fre.**, please see page 36 in the French user's guide.

TVPG

	ALL	FV	V	S	L	D
TV-Y						
TV-Y7						
TV-G						
TV-PG						
TV-14						
TV-MA						

This setting is based on the US ratings system.

TV Y – Appropriate for all children.

Intended for all children 2 - 6 years old.

TV Y7 – Appropriate for older children.

Intended for children 7 years or older.

TV G – General Audience.

Suitable for all ages.

TV PG – Parental Guidance Suggested.

Suitable for all ages with parental guidance.

TV 14 – Parents Strongly Cautioned.

Intended for viewers 14 years or older.

TV MA – Mature Audiences Only.

Intended for viewers 18 years or older.

Viewing Guidelines:

In addition to the above ratings, you can also block or allow more specific content **(Except for unrated programming)**.

A program can contain any or all of the following:

V/FV – VIOLENCE/FANTASY VIOLENCE

S – SEXUAL Content

L – Strong LANGUAGE

D – Suggestive DIALOG

Guide

You can view program information. **(Digital channels only)**

Note:

- If the programming information is not being broadcast, the guide function has no effect or may display incorrect information.

Customizing your TV



Notes:

- This menu will replace the **TV** menu when you connect a PC to your TV terminal. See page 63.
- There are some menus that PC mode can not use. (In **Picture** and **Sound** menu)
- As for **Aspect** in the **Display** menu, only **Regular** and **Full** are available.

Auto Adjustment _____

Adjust the screen position automatically.

Note:

- Sometimes Auto Adjustment will not operate properly. Either adjust with the following functions or change the signal.

Phase Adjustment _____

Adjust it when noise shows up across the screen. Also, use it when letters become blurry.

PC H-Position _____

Allows you to adjust the screen position horizontally.

PC V-Position _____

Allows you to adjust the screen position vertically.

Reset _____

Resets all PC mode adjustments at once to the default setting.



MTS

Allows you to listen to a program in stereo, mono sound or another language (SAP).
(Depending if available in the program) First you must set the **MODE** to **TV** on your remote.

Notes:

- When you are receiving a digital broadcast, if there are other languages, you can change the language by pressing the **ML/MTS** button.
- Keep the TV in stereo mode to get the best sound quality. The sound will work in stereo mode even if a certain broadcast is in mono sound only.
- Choose the mono setting to reduce excessive noise on a certain channel or broadcast.
- MTS unavailable if your television's input source is **(V1, V2, V3, V4, V5)**.
- ML/MTS will not work when you are using the HDMI.

Digital Audio (ML)

You can change the language if there are other languages available. **(Digital channels only)**

Surround

You can select the surround mode you like. **Off / Movie / Music / News / Mono**

Sound Status

You can choose several types of sound modes. **User / Speech / Jazz / Classic / Rock**

Note:

- If you select **User**, you can customize the various sound frequencies.
100Hz / 330Hz / 1KHz / 3.3KHz / 10KHz

Audio Reset

Resets all sound adjustments at once to the default settings.

Customizing your TV



Power Indicator

Allows you adjust the brightness of the blue power indicator light.

High – Light is brightly lit

Low – Light is dimly lit

Off – Light is off

Illumination

Allows you adjust the brightness of the Diffuser Illumination. See page 13.

High – Light is brightly lit

Low – Light is dimly lit

Off – Light is off



Setting

Plug In Menu

When you turn on your TV for the first time, the Initial Setup menu appears. If you skip it, or your setup has changed, you can set it up in this menu anytime.

Time Zone

Choose the time zone you live in and the clock sets automatically.

Atlantic / Eastern / Central / Mountain / Pacific / Alaska / Hawaii

D.S.T.

Adjust your TV's clock for Daylight Savings. **On / Off**

Language

Allows you to change the TV's onscreen menu languages to English, French or Spanish.

Noise Mute

Displays a blank gray screen over channels that are too weak to be received clearly.

On / Off

Front Panel Lock

This allows you to lock the buttons on the side of the TV. **On / Off**

Transparency

Change the transparency of the menu screens. **1 / 2 / 3 / 4**

Auto Shut Off

This function automatically shuts off your TV when there is no signal from the channel while the TV is on for 10 minutes. **On / Off**



Setting Continued...

Customizing your TV

Control with HDMI

If you use a HDMI CEC compatible device, set this setting to “**On**”.

HDMI CEC (Consumer Electronics Control) allows the TV to connect and control multiple HDMI CEC enabled devices with a single remote. CEC (Consumer Electronics Control) is an optional protocol used in HDMI.

- HDMI CEC on this TV is compliant with “High-Definition Multimedia Interface Specification”.
- The TV does not support HDMI CEC functions that are not listed below.
- The TV does not guarantee to support use of all HDMI CEC enabled devices.
- Devices that are not enabled to HDMI CEC cannot be controlled with this TV.

– Control the TV using the HDMI CEC enabled device –

- Turn the TV on and switch to the video source of the operating device.
- Switch to the video source of the operating device.
- Turn the TV off with the HDMI CEC enabled device you are viewing.
- For operating instructions of the device, refer to the device’s manual.

– Control the HDMI CEC enabled device using the TV –

- Turn off the operating device by turning off the TV.
- Some device may not support this function. For more details refer to the device’s manual.

– Send status of the TV to the HDMI CEC enabled device –

- When switching the TV’s external input or channel.
- When switching the TV’s menu language.
- Information regarding behavior of the device when status is received, refer to the external device’s manual.

If HDMI CEC does not work correctly:

- When HDMI CEC enabled device is connected to INPUT 1, INPUT 2 or INPUT 3 with an HDMI cable, you may not be able to control TV’s external input. To solve the problem set this setting to “**Off**”.

System Info

You can confirm the TV’s software version.

Auto Demo

Auto Demo explains this TV’s features to you.

Notes:

- The **Auto Demo** mode will start automatically when you set **Retail** in Initial Setup.
- If you press any button on the television or remote, with the exception of **POWER** or **MENU**, the **Auto Demo** mode will stop for 30 seconds. After 30 seconds have passed with no operation, the **Auto Demo** mode will start again.
- If you want to turn off the **Auto Demo**, press the **MENU** button.

Optical Out

You can select the optical digital sound output as PCM or DOLBY DIGITAL when your TV is connected to an amplifier that has a DOLBY DIGITAL decoder. If you select DOLBY DIGITAL, you can enjoy listening to 5.1ch sound when watching digital broadcasts. This only applies to digital channels.

Notes:

- Optical Out can be used for both digital and analog channels.
- If your amplifier does not have DOLBY DIGITAL decoder, select PCM. If you don't select PCM, it cannot output the sound from the speakers.
- For connecting an amplifier using the optical output, see page 60.

PC Smart Input

When PC is turned on it will power on TV and put it in PC mode. Any other function is not logical. Also it is called **PC Smart Input** in TV menu so it suggest flow from PC to TV.

D-Sub / HDMI / Off

Notes:

- When you use **PC Smart Input** function with HDMI cable, connect your PC with HDMI terminal (INPUT 1).
- You cannot use **PC Smart Input** when **Control with HDMI** is "On".

Sync Mode

Lets iTunes synchronize your iPod when USB is connected with computer. When you start **Sync Mode**, within the TV's **Setting** menu, the menu displays "Start" and after finished, "Exit" is displayed.

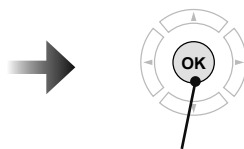

Press **OK** to start or exit **Sync Mode**.







Notes:

- You need USB type A - type B cable connector, see page 50.
- Do not detach your iPod when you start **Sync Mode**.
- When you exit the **Sync Mode**, make sure your iPod and PC communication has finished.

Enjoy Movies/Music From Your iPod

Compatible iPod Types

* If your iPod is not listed in this chart, it is incompatible with this television.

iPod						
4G	photo/color	5G	classic	touch (1G)	touch (1G) (FW:2.0+) touch 2G	
						
20GB 40GB	20GB 30GB 40GB 60GB	30GB 60GB 80GB	80GB 120GB 160GB	8GB 16GB 32GB	8GB 16GB 32GB	

TV Control Mode

Music Play	✓	✓	✓	✓	✓	✓	
Video Play			✓	✓		✓	
Setting	✓ (3)	✓ (3)	✓ (3)	✓ (3)	✓ (3)	✓ (3)	





Pod Control Mode

Music Play	✓ (1)	✓ (1)	✓ (1)	✓ (1)	✓ (1, 2)	✓ (1, 2)	
Video Play			✓	✓	✓ (2)	✓ (2)	
Photo Slide Show		✓	✓	✓	✓ (4)	✓ (4)	
Setting	✓	✓	✓	✓	✓ (2)	✓ (2)	

Sync Mode

	✓	✓	✓	✓	✓	✓	
--	---	---	---	---	---	---	--

- Some setups will require the selection by using the iPod. (Especially those that require wheel control).
- Not available except for Music/Video play, Photo Slide Show (Pod Control Mode).
 - (1) – The registration of “On-The-Go” can be done by using the iPod.
 - (2) – Due to the nature if iPod touch, lock/unlock, Main Menu and the selection of music/video has to be done using the iPod touch.
 - (3) – “Shuffle”, “Repeat” and “Audiobook” can be available in TV Control Mode.
 - (4) – To control iPod touch Photoviewer, it can be done only by using the iPod touch.

	iPod nano				iPod mini
	1G	2G	3G	4G	
					
	1GB 2GB 4GB	2GB 4GB 8GB	4GB 8GB	8GB 16GB	4GB 6GB
	✓	✓	✓	✓	✓
			✓	✓	
	✓ (3)	✓ (3)	✓ (3)	✓ (3)	✓ (3)
	✓ (1)	✓ (1)	✓ (1)	✓ (1)	✓ (1)
			✓	✓	
			✓	✓	
	✓	✓	✓	✓	✓
	✓	✓	✓	✓	✓

Enjoy Movies/Music From Your iPod

By inserting your iPod into the Dock, you can display movies or music on your TV from your iPod. Also, while inserted you can recharge your iPod.

Ready to play

- 1) Insert your iPod into the Dock on the front of the TV.

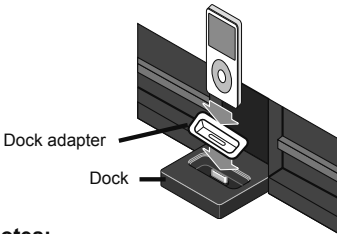

* When you put your iPod on the Dock, please use the Dock adapter (supplied with iPod or separately purchased).

* To detach the dock adaptor from the Dock, push the slot then pull up to remove the dock adaptor. If you have difficulty detaching the Dock adaptor, gently use a flat head screwdriver to remove.

Notes:

- It is recommended that music, pictures and movies on the iPod be saved on your PC or other hard drive for backup.
- Please be sure to connect/disconnect the iPod properly from the Dock and use the iPod without any accessory/case.
- Please do not jiggle the iPod in the Dock to avoid connection failure or damage to the connector.

- 2) Press the **iPod** button on your remote, then the JVC logo will appear on the screen of the iPod.



Notes:

- You cannot operate the iPod while the Apple logo appears on the screen of the iPod.
- If your iPod doesn't work correctly, gently pull out and try again.

- 3) TV screen will change to the iPod start screen.

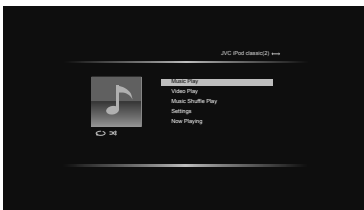

- 4) To exit the menu, press the **iPod** button. The TV will return to the program you were watching.
- 5) When you detach your iPod, while gently holding the base, pull the iPod gently straight upwards.

Notes:

- If the iPod does not play correctly, please update your iPod software to the latest version. For details about updating your iPod, check on the Apple web site, <http://www.apple.com>.
- Sound distortion may occur when playing back audio sources with high recording levels. When distortion occurs, it is recommended to turn off the equalizer of the iPod. For information on operating the iPod, see the iPod instruction manual.
- JVC is not responsible for any loss of or damage to iPod that might result from the use of this product.

TV Control Mode

You can operate the iPod by using the TV's remote control and onscreen menus.



- Music Play
- Video Play
- Music Shuffle Play
- Settings
- Now Playing (when playing music)



Select



Skip to the next/last page



Set



Back to previous menu

Note:

- When **Music Play** is selected, you can then search by the categories supported on your iPod, such as **Playlist, Albums, Songs, Podcast** etc.
- When you search tracks from **Artist, Albums**, etc., some tracks may not be displayed on the list. In this case, select a track from **Songs** or input tag information using iTunes.

Icons of Music Play screen

Your iPod name

Blinks when communicating with the iPod

Shuffle

- Songs
- Albums

Repeat

- One
- All

Music

Artist

Album

Genre

Rewind

Forward

Pause/Stop

Play

* Language Support:
English, French and Spanish

Enjoy Movies/Music From Your iPod

Music Play / Video Play

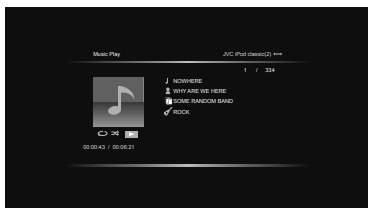

Skip to the next/last song



Back to previous menu



TV's onscreen menu
("Picture" and "Sound")



Volume



Adjust Video status
(Video Play)



Change the aspect ratio
(Video Play)

iTV (in Music Play mode)

iTV allows you to watch TV and at the same time, listen to the music content on your iPod. When you are listening to music in **Music Play** mode, press the **iTV** button.



Adjust Video status



Adjust Aspect Ratio



Select a channel.
(See page 18, 21)



Adjust sound status



Adjust sound status



Choose Timer



Back to TV



Display title (Video Play)



You can view the last program you were watching while listening to your iPod (iTV Mode). Press **iTV** button when playing music.



Mute

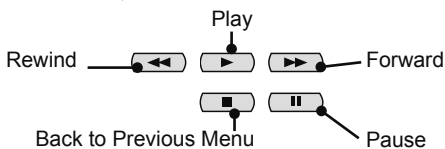

Rewind

Play

Forward

Back to Previous Menu

Pause



Change channel



Select input



Change between iPod's sound and TV's sound



Back to Music Play screen



Display information

Note:

- Basic operations are the same as the operations when playing in **Music Play** mode.

Music Shuffle Play

This function selects songs randomly.

Note:

- Basic operations are the same as the operations when playing in **Music Play** mode.

Settings

You can adjust the settings below by pressing the ▲ ▼ and **OK** buttons.

Shuffle / Repeat / Audiobook

Pod Control Mode

You can operate the iPod using the TV's remote control and the onscreen of the iPod. Press the **PCON** button to switch between Pod Control Mode and TV Control Mode.

- 1) Press the **PCON** button on the remote control. JVC logo will disappear and the normal screen of your iPod will appear.
- 2) Operate with TV remote control.

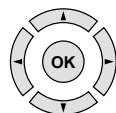
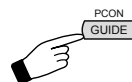

* Operation varies from iPod type and/or mode.

SOUND Adjust sound status



Back to previous menu

VIDEO Adjust Video status



TV's onscreen menu
("Picture" and "Sound")



Adjust Aspect Ratio

TIMER Choose Timer



Volume

iPod Back to TV



Mute



* Operation varies from iPod type and/or mode



Exit message



Note:

- TV will display a blank black screen when operating the iPod in Pod Control Mode.

Enjoy Movies/Music From Your iPod

Recharge iPod

While your iPod is connected to the Dock, you have the ability to recharge your iPod. The time it takes depends on how low your batteries are.

Note:

- If you insert the iPod into the Dock when the TV is off, a click sound may occur. This is normal.

On Timer using iPod

You can set the timer to listen to your iPod music content. After you set **On Timer** and select iPod at **Input** in Timer menu. See page 18. Insert your iPod into the Dock.

Notes:

- If you want to set the timer to listen to your favorite music content, play the music content operating your iPod and press pause. And put it on the TV Dock. On Timer will start to play the selected music.
- You cannot play Video content using On Timer function.

PC sync.

You can synchronize your iPod and PC using this TV. Please use USB type A - type B cable (not supplied) when you connect with SYNC (PC) connector.

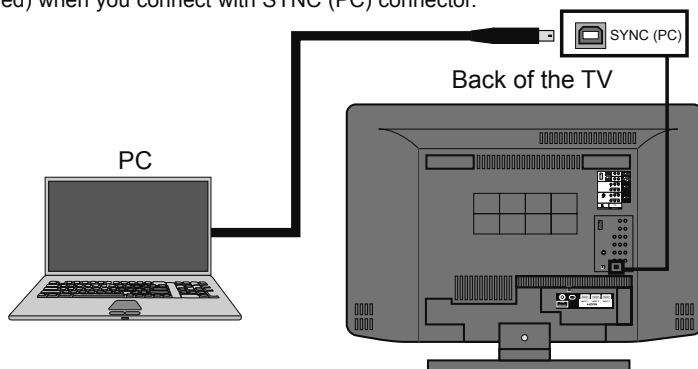

Notes:

- Make sure you inserted your iPod into the Dock and both PC and TV's power is on.
- Depending on your PC and USB cable, **Sync Mode** (page 43) may not operate correctly. Also, it is not recommended to use a hub between the PC and TV connection.
- For details about syncing with iTunes, refer to your iPod's manual.
- You can display iTunes screen on TV. See page 63.
- For updating iPod firmware, connect directly with your iPod and PC.

Error messages

"iPod not found"	This appears when you press the iPod button without inserting an iPod.
"Communication failed. Check Connection"	Insert your iPod again. This is a connection error.
"File not found"	This appears when your iPod has no files to play.

Programming Your Remote

You can program your remote control to operate your external devices, using the instructions and codes on pages 51 - 57.

How to set the codes

- 1) Manually turn on the device.
- 2) Change the remote control mode according to the device by pressing the **MODE** button. Refer to the following list for which mode to use.

Device	Applied for these devices
TV	JVC brand only
STB	Cable Set Top Boxes, Cable/PVR Combinations, Satellite Set Top Box DBS/PVR Combination
VCR	VCR, DBS/PVR Combination, PVR, DVD/PVR Combination
DVD	DVD Player, DVD Recorder, Home Theater in a Box, Receiver
AUDIO	Amplifier, Home Theater in a Box, Receiver

- 3) Find the remote control code for your device. See pages 53 - 57.
- 4) Set the remote code.

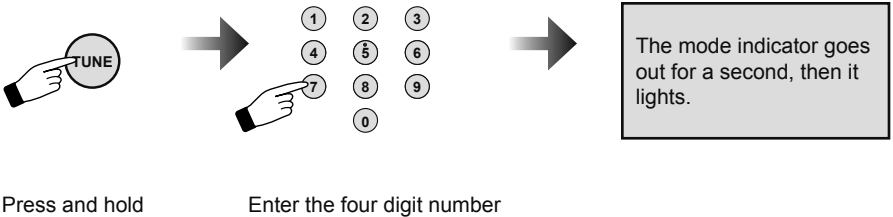

- 5) Point the remote at the device and press power. If your device did not turn off or respond, try another code.

Notes:

- If your device doesn't respond to any of the codes listed or is not listed, see page 52.
- Some codes may have only limited functions. Try other codes that may have more functions.

Programming Your Remote

Search Code Function

This function searches for codes one by one if none of the codes listed for your device has worked.

- 1) Manually turn on the device.
- 2) Change the remote control mode according to the device. Press **MODE** to select the correct mode.
- 3) Activate the search code function. Press and hold **POWER** and **RETURN+TV** until the mode indicator blinks.
- 4) Point the remote at the device and press **POWER**. If no response, try the next code by pressing **▶** and **POWER** until the device turns off.
- 5) Press **RETURN+TV** to register and set the code. Then the **MODE** indicator light goes out.

Notes:

- If your remote still doesn't work with the "Search Code Function", use the remote that came with your device. Your TV remote can not be guaranteed to work with all devices, modes or operations.

Remote Control Functions

POWER



Turns the selected device off

– CH +

Channel Up / Down

SUB T.

Displays Subtitles

– VOL +

Volume Up / Down



Open / Close

MODE TV STB VCR DVD AUDIO

Changes the remote control mode

V1 V2 V3 V4 V5

Audio Input Selection

Operates menus

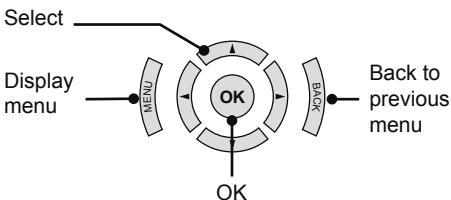

Playback / Record, etc.

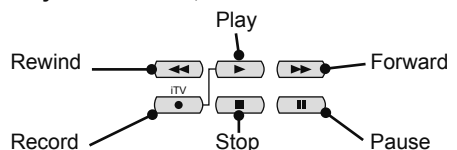

Programming Codes

STB mode					
Cable Set Top Box		Satellite Set Top Box		Satellite Set Top Box	
ABC	0003, 0008	AlphaStar	0772	Samsung	1377, 1276, 1108,
Americast	0899	Chaparal	0216		1109, 1442, 1609
Bell South	0899	Coolsat	1806	SKY	0856
Digeo	1187	Crossdigital	1109	Sony	0639, 1639, 1640
Director	0476	DirecTV	1377, 0392, 0566,	Star Choice	0869
General Instrument	0476, 0810, 0276,		0639, 1639, 1142,	Tivo	1142, 1442
	0003		0247, 0749, 1749,	Toshiba	0749, 1749, 0790,
GoldStar	0144		0724, 0819, 1856,		1285
Hamiln	0009, 0273		1076, 1108, 0099,	UltimateTV	1392, 1640
Jerrold	0476, 0810, 0276,	1109, 1414, 1442,	Ultrasat	1806	
	0003	1609, 1392, 1640	Uniden	0724, 0722	
Memorex	0000	Dish Network System	1505, 1005, 0775,	US Digital	1535
Motorola	1376, 0476, 0810,		1170, 1775	USDTV	1535
	0276, 1187	Dishpro	1505, 1005, 0775,	Voom	0869
Pace	1877, 0237, 0008		1775	Zenith	0856, 1856
Panasonic	0000, 0008, 0107	Echostar	1505, 1005, 0775,	DBS/PVR Combination	
Paragon	0000		1170, 1775		
Philips	1305, 0317, 0025	Expressvu	0775, 1775	DirecTV	1377, 0392, 0639,
Pioneer	1877, 0877, 0144,	GE	0566		1142, 1076, 0099,
	0533	General Instrument	0869		1392, 1442, 1640
Pulsar	0000	GOI	0775, 1775	Dish Network System	1505, 0775
Quasar	0000	Hisense	1535	Dishpro	1505, 0775
Regal	0279, 0273	Hitachi	0819	Echostar	1505, 0775, 1170
Runco	0000	HTS	0775, 1775	Expressvu	0775
Samsung	0000, 0144	Hughes Network Systems	1142, 0749, 1749,	Hughes Network Systems	1142, 1442
Scientific Atlanta	1877, 0877, 0477,		1442	JVC	1170
	0008	Humax	1790	Motorola	0869
Sony	1006	iLo	1535	Philips	1142, 0099, 1442
Starcom	0003	JVC	0775, 1170, 1775	Proscan	0392
Supercable	0276	LG	1414	RCA	1392
Torx	0003	Magnavox	0724, 0722	Samsung	1442
Toshiba	0000	Memorex	0724	Sony	0639, 1640
Zenith	0000, 0525, 0899	Mitsubishi	0749	Star Choice	0869
		Motorola	0869		
Cable/PVR Combination		Next Level	0869		
		Panasonic	0247, 0701		
Americast	0899	Pansat	1807		
Digeo	1187	Paysat	0724		
General Instrument	0810	Philips	1142, 0749, 1749,		
Jerrold	0810		0724, 1076, 0722,		
Motorola	1376, 0810, 1187		0099, 1442		
Pace	1877, 0237	Proscan	0392, 0566		
Pioneer	1877, 0877	Proton	1535		
Scientific Atlanta	1877, 0877	RadioShack	0869		
Sony	1006	RCA	0566, 0855, 0143,		
Supercable	0276		1392		
Zenith	0899				

Etc.

Programming Codes

VCR mode					
VCR		VCR		VCR	
ABS	1972	Fisher	0047, 0104, 0046	Marta	0037
Admiral	0048, 0209	Fuji	0035, 0033	Matsushita	0035, 0162, 0227,
Adventura	0000	Funai	0000, 0593, 1593		1162
Aiko	0278	Garrard	0000	Media Center PC	1972
Aiwa	0037, 0000, 0307, 0479	Gateway	1972	MEI	0035
		GE	0060, 0035, 0240, 0202, 0760, 0761, 0807, 1035, 1060	Memorex	0035, 0162, 0037, 0048, 0039, 0047, 0240, 0000, 0104, 0209, 0046, 0307, 0479, 1037, 1048, 1162, 1237, 1262
Akai	0041, 0061, 0106	Go Video	0432, 0526		
Alienware	1972	GoldStar	0037, 0209, 0038,		
America Action	0278		0225, 1237		
American High	0035				
Asha	0240	Gradiente	0000	MGA	0240, 0043, 0061
Audiovox	0037, 0278	Harley Davidson	0000	MGN Technology	0240
Beaumarck	0240	Harman/Kardon	0081, 0038	Microsoft	1972
Bell & Howell	0104	Harwood	0072	Mind	1972
Broksonic	0184, 0121, 0209, 0002, 0479, 1479	Headquarter	0046	Minolta	0042, 0105
Calix	0037	Hewlett Packard	1972	Mitsubishi	0081, 0067, 0043, 0041, 0061, 0173, 0807
Canon	0035	HI-Q	0047		
Capehart	0020	Hitachi	0037, 0240, 0000, 0042, 0041, 0105, 1037	Motorola	0035, 0048
Carver	0081			MTC	0240, 0000
CCE	0072, 0278	Howard Computers	1972	Multitech	0000, 0072
Citizen	0037, 0278, 1278	HP	1972	NEC	0035, 0037, 0048, 0104, 0067, 0041, 0038, 0008
Colt	0072	Hughes Network Systems	0042, 0739		
Craig	0037, 0047, 0240, 0072, 0271	Humax	0739		
Curtis Mathes	0060, 0035, 0162, 0041, 0760, 1035	Hush	1972	Nikko	0037
		IBUYPOWER	1972	Niveus Media	1972
Cyberbex	0240	Jensen	0041	Noblex	0240
CyberPower	1972	JVC	0045, 0067, 0041, 0008, 0366, 1707, 1945, 1774, 1775, 1776, 1777	Northgate	1972
Daewoo	0045, 0104, 0278, 0020, 0046, 0561, 1278	KEC	0037, 0278	Olympus	0035
		Kenwood	0067, 0041, 0038	Optimus	1062, 0162, 0037, 0048, 0104, 0432, 0593, 1048, 1162, 1262
Daytron	0020	KLH	0072	Orion	0184, 0121, 0209, 0002, 0208, 0479, 1479
Dell	1972	Kodak	0035, 0037		
Denon	0042	LG	0037, 0045, 0042, 0209, 0038, 1037	Panasonic	1062, 0035, 0162, 0225, 0227, 0616, 1035, 1162, 1262
DirecTV	0739	Linksys	1972		
Durabrand	0039, 0038	Lloyd's	0000, 0208		
Dynatech	0000	Logik	0240, 0072	Penney	0035, 0037, 0240, 0042, 0038, 1035, 1237
Electrohome	0037	LXI	0037		
Electroponic	0037	Magnasonic	0593, 1278		
Emerex	0032	Magnavox	0035, 0039, 0081, 0000, 0149, 0563, 0593, 1593, 1781	Pentax	0042, 0105
Emerson	0035, 0037, 0184, 0240, 0045, 0000, 0121, 0043, 0209, 0002, 0278, 1593, 1479, 1278, 0593, 0561, 0479, 0208, 0061	Magnin	0240	Philco	0035, 0000, 0038
		Marantz	0035, 0081		

VCR mode

VCR		VCR		PVR	
Philips	0035, 0081, 0000, 0563, 0593, 0618, 0739, 1081, 1181, 1266	Symphonic	0000, 0593, 1593	Howard Computers	1972
		Systemax	1972	HP	1972
		Tagar Systems	1972	Hughes Network Systems	0739
		Tatung	0081, 0045, 0000,	Humax	0739
Pilot	0037		0067, 0041, 0008,	Hush	1972
Pioneer	0081, 0042, 0067		0366	iBUYPOWER	1972
Polk Audio	0081	Teac	0000, 0041	JVC	1945
Portland	0020	Technics	0035, 0162	Linksys	1972
Presidian	1593	Teknika	0035, 0037, 0000	Media Center PC	1972
Profitronic	0240	Thomas	0000	Microsoft	1972
Proscan	0060, 0202, 0760, 0761, 1060	Tivo	0618, 0636, 0739, 1996	Mind	1972
				Niveus Media	1972
Protec	0072	TMK	0240, 0208	Northgate	1972
Pulsar	0039	Toshiba	0081, 0045, 0042, 0067, 0043, 0041, 0008, 0057, 0366, 0845, 1008, 1145, 1972, 1996	Panasonic	0616, 1777
Quarter	0046			Philips	0618, 0739
Quartz	0046			RCA	0880
Quasar	0035, 0162, 1035, 1162			ReplayTV	0614, 0616
				Samsung	0739
RadioShack	0000, 1037			Totevision	0037, 0240
Radix	0037	Touch	1972	Sony	0636, 1972
Randex	0037	Unitech	0240	Stack 9	1972
RCA	0060, 0035, 0240, 0000, 0042, 0149, 0105, 0106, 0202, 0760, 0761, 0807, 0880, 1035, 1060	Vector	0045	Systemax	1972
		Vector Research	0038	Tagar Systems	1972
		Video Concepts	0045, 0061	Tivo	0618, 0636, 0739
		Videomagic	0037	Toshiba	1008, 1972, 1996
		Videosonic	0240	Touch	1972
Realistic	0035, 0037, 0048, 0047, 0000, 0104, 0046	Viewsonic	1972	Viewsonic	1972
		Villain	0000	Voodoo	1972
		Voodoo	1972	ZT Group	1972
ReplayTV	0614, 0616	Wards	0060, 0035, 0048, 0047, 0081, 0240, 0000, 0042, 0072, 0149, 0760	DVD/PVR Combination	
Ricavision	1972	White Westinghouse	0209, 0072		
Runco	0039	XR-1000	0035, 0000, 0072	Emerson	0000
Samsung	0240, 0045, 0432, 0739, 0760, 1014	Yamaha	0041, 0038		
		Zenith	0039, 0033, 0000, 0209, 0034, 0479, 1139, 1479		
Sanky	0048, 0039				
Sansui	0000, 0067, 0209, 0041, 0271, 0479, 1479	ZT Group	1972		
		DBS/PVR Combination			
Sanyo	0047, 0240, 0104, 0046	EchoStar	1945		
		Hughes Network Systems	0739		
		JVC	1945		
Scott	0184, 0045, 0121, 0043	Philips	0739		
		Samsung	0739		
Sears	0035, 0037, 0047, 0000, 0042, 0104, 0046, 0057, 0105, 1237	PVR			
Sharp	0048, 0209, 0807, 0848, 1048	ABS	1972		
Shintom	0104, 0072	Alienware	1972		
Shogun	0240	CyberPower	1972		
Singer	0045, 0072	Dell	1972		
Sonic Blue	0614, 0616	DirecTV	0739		
Sony	0035, 0032, 0033, 0000, 0034, 0636, 0639, 0640, 1032, 1232, 1972	Dish Network System	1945		
		EchoStar	1945		
Stack 9	1972	Gateway	1972		
STS	0042	Hewlett Packard	1972		
Sylvania	0035, 0081, 0000, 0043, 0593, 1593, 1781				

Programming Codes

DVD mode					
DVD		DVD		DVD Recorder	
Accurian	1416	Magnavox	0503, 0539, 0646,	Accurian	1416
Advent	1016		0675, 0821, 1268	Apex Digital	1056
Aiwa	0641	Marantz	0539	Aspire Digital	1168
Akai	0695, 0770, 0899	Memorex	0695, 0831, 1270	CyberHome	1129
Alco	0790	Microsoft	0522, 1708	Denon	0490
Allegro	0869	Mintek	0839, 0717	Funai	0675, 1334
Apex Digital	0672, 0717, 0755,	Mitsubishi	1521, 0521	Gateway	1158
	0830, 1056, 1061		NAD	0741	Go Video
Arrgo	1023	NEC	0785		1730
Aspire Digital	1168	Nesa	0717	iLo	1348
Audiovox	0790	NexxTech	1402	JVC	1164
Blaupunkt	0717	Norcent	1003, 1107	LG	0741
Blue Parade	0571	Onkyo	0503, 0627	LiteOn	1158, 1416, 1440
Broksonic	0695	Orltron	0651	Magnavox	0646, 0675
Cinea	0831	Panasonic	0490, 0703, 1362,	Panasonic	0490
Cine Vision	0876, 0833, 0869		1462, 1490, 1762	Philips	0646, 1158
Citizen	1277	Philips	0503, 0539, 0646,	Pioneer	0631
Coby	0778, 1107		0675, 0854, 1158,	RCA	0522
Craig	0831		1260, 1267, 1354	Samsung	0490, 1470
Curtis Mathes	1087		Pioneer	0525, 0571, 0631	Sensory Science
CyberHome	0816, 0874, 1023,	Polaroid	1061	Sharp	0630, 0675
	1024, 1117, 1129	Polk Audio	0539	Sony	1033, 1431
Daewoo	0784, 0705, 0770,	Portland	0770	Sylvania	0675
	0833, 0869, 1169,	Presidian	0675	Zenith	0741
	1172	Prima	1016		
	Denon	0490, 0634	Proscan	0522	
Disney	0675, 1270	Pro Vision	0778	Home Theater in Box	
Durabrand	1127	Qwestar	0651	Aiwa	0641
DVD2000	0521	RCA	0522, 0571, 0717,	Audiovox	0790
Emerson	0591, 0675, 0821,		0790, 0822, 1022,	1132	JVC
	1268	Rio	0869	KLH	0790
Enterprise	0591	Rotel	0623	Koss	0651
ESA	0821, 1268	Sampo	0752	Orltron	0651
Fisher	0670	Samsung	0490, 0573, 0744,	Polk Audio	0539
Funai	0675, 1268, 1334		0820, 0899, 1044,	1075, 1470	RCA
Gateway	1158	Sansui	0695	Rio	0869
GE	0522, 0815, 0717	Sanyo	0670, 0695, 0873	Sonic Blue	0869
Go Video	0744, 0715, 0741,	Sensory Science	1158	Teac	0790
	0783, 0833, 0869,	Sharp	0630, 0675, 0752,	Venturer	0790
	1044, 1075, 1099,		1256		
	1158, 1304, 1730	Sharper Image	1117		
GoldStar	0741	Sherwood	0770		
Greenhill	0717	Shinsonic	0533, 0839		
Harman/Kardon	0582, 0702	Sonic Blue	0869, 1099		
Hitachi	0573, 0664, 1247	Sony	0533, 1533, 0864,		
Hiteker	0672		1033, 1431, 1536		
Humax	1500, 1588	Superscan	0821		
iLo	1348	Sylvania	0675, 0821, 1268		
Initial	0717	Symphonic	0675, 0821		
Insignia	1268	Teac	0717, 0790		
Integra	0627	Technics	0490, 0703		
JBL	0702	Theta Digital	0571		
Jensen	1016	Tivo	1503		
JVC	0558, 0623, 0867,	Toshiba	0503, 0695, 1045,		
	1164, 1602, 1770,		1154, 1503, 1515,		
	1771, 1772, 1773		1588		
Kawasaki	0790	Urban Concepts	0503		
Kenwood	0490, 0534	US Logic	0839		
KLH	0717, 0790, 1149	Venturer	0790		
Koss	0651	Xbox	0522, 1708		
Lasonic	0798	Yamaha	0490, 0539, 0545		
Lennox	1127	Zenith	0503, 0591, 0741,		
LG	0591, 0741, 0869		0869		
LiteOn	1058, 1158, 1416,				
	1440				

Connecting Your Devices

Notes:

- The following connection diagrams are examples on connecting some of the most common devices to your TV. Please refer to your device's instruction manual on other connection methods or for devices not shown here in this instruction book.
- When you are finished connecting your devices, turn on your TV and devices.

Connect an Antenna or Basic Cable



Notes:

- If you are able to receive ATSC (Digital terrestrial) signal, High Definition (HD) broadcasting can be watched.
- All digital broadcasting is not necessary High Definition. Check by pressing the **DISPLAY** button.
- Digital broadcasting is not available in all areas.

Connect a Cable Box

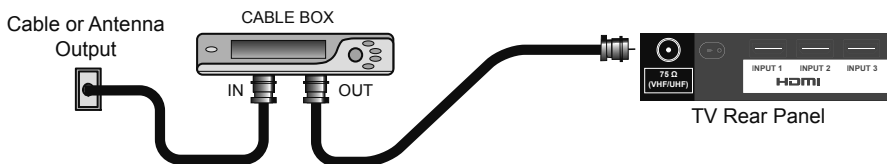

Note:

- To view channels on your cable box, make sure your TV's channel is set to 2, 3 or 4 (depending on the area you live in).

Connect a VCR / DVD Player using Component Video

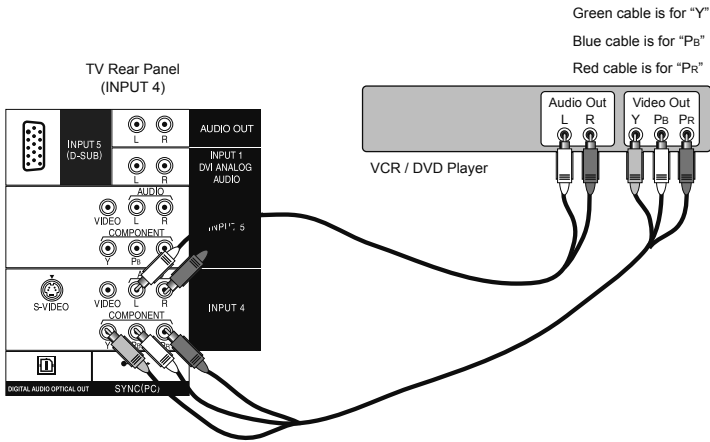

Notes:

- Green, blue and red are the most common colors for Component Cables. Some models may vary in color.
- To watch your VCR / DVD player, make sure your TV is displaying INPUT 4 or INPUT 5 by pressing the **V4** or **V5** button on your remote control.

Connect a VCR / DVD Player using Composite Video

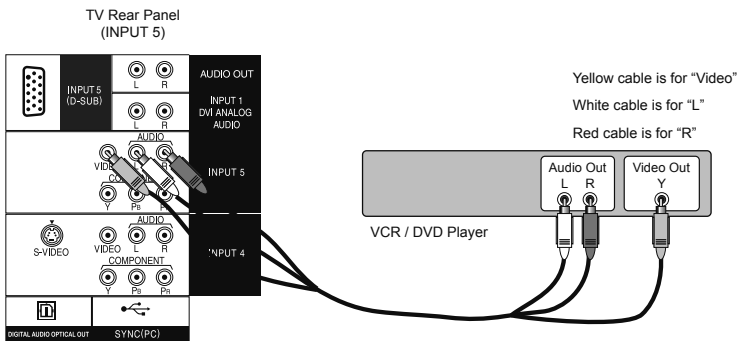

Notes:

- Yellow, white and red are the most common colors for Composite Cables. Some models may vary in color.
- To watch your VCR / DVD player, make sure your TV is displaying INPUT 4 or INPUT 5 by pressing the **V4** or **V5** button on your remote control.
- If your device has S-Video Output, you can use that instead of using Composite Cables. Connect INPUT 4 (S-VIDEO) and S-video Output with an S-Video Cable.

Connecting Your Devices

Connect an Amplifier or Home Theater System

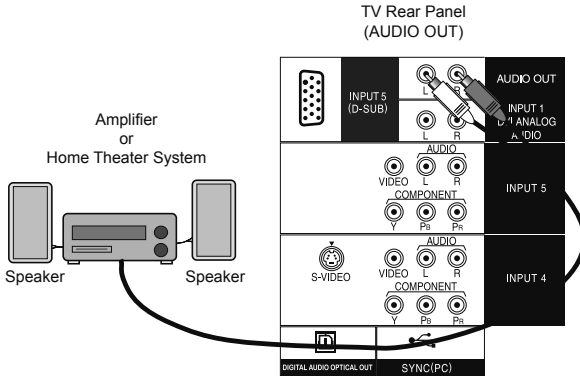

Notes:

- Refer to your amplifier's or Home Theater System's manual for more information.
- If you have a device connected to INPUT 1, INPUT 2 or INPUT 3, you will not be able to hear any audio from the AUDIO OUT on the back of the TV otherwise.

Connect an Amplifier using the DIGITAL AUDIO OPTICAL OUT

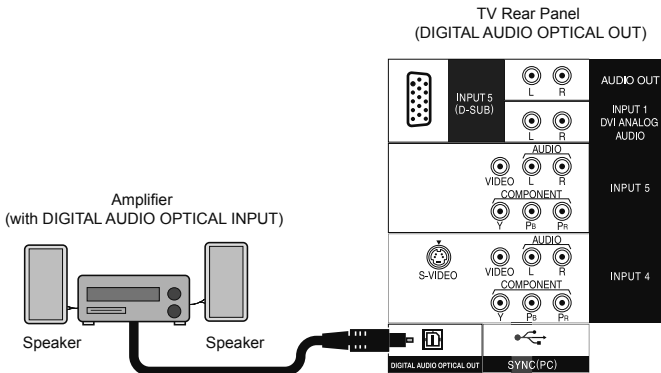

Notes:

- Refer to your amplifier's manual for more information.
- This terminal can only output digital audio (PCM or DOLBY DIGITAL).
- In order to use the optical output connection, select PCM or DOLBY DIGITAL. See page 43.
- You can not output sound from your DIGITAL AUDIO OPTICAL OUT connection if the audio source is from your HDMI device.

Connect a Digital Source Device

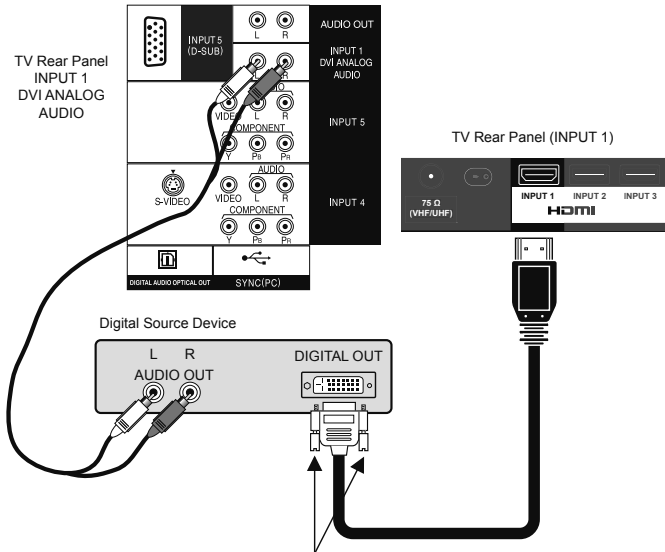

After the connections have been made, tighten the screw to secure the cables.

Notes:

- To watch your digital source device, make sure your TV is displaying INPUT 1 by pressing the **V1** button on your remote control.
- This TV can accept 480i, 480p, 720p, 1080i and 1080p signals via HDMI.
- The INPUT 1 DVI ANALOG AUDIO input can only be used with INPUT 1.

Connect a Camcorder

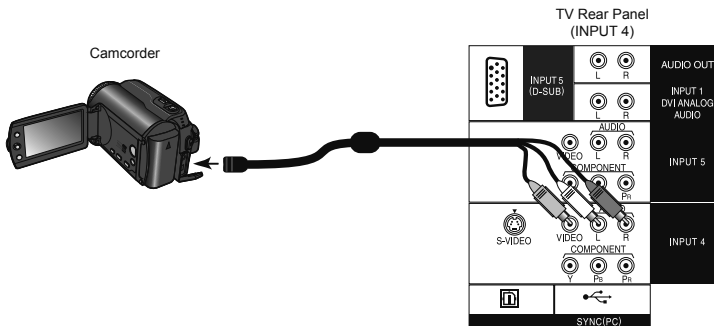

Notes:

- To watch video from your camcorder, make sure your TV is displaying INPUT 4 or INPUT 5 by pressing the **V4** or **V5** button on your remote control.
- If your device has S-Video Output, you can use that instead of using Composite Cables. Connect INPUT 4 (S-VIDEO) and S-video Output with an S-Video Cable.

Connecting Your Devices

Connect a Blu-ray or HDMI Device

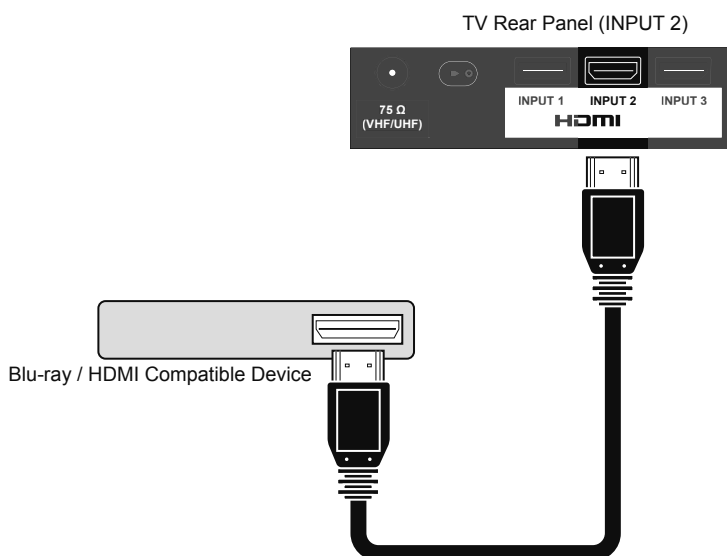

Notes:

- To watch your Blu-ray or HDMI device, make sure your TV is displaying INPUT 1, INPUT 2 or INPUT 3 by pressing the **V1**, **V2** or **V3** button on your remote control.
- Some decoders may not respond depending on the equipment that is connected to the HDMI.
- This TV can accept 480i, 480p, 720p, 1080i and 1080p signals via HDMI.
- This JVC television can accept a variety of HD signals, including 720p, 1080i, 1080p/24Hz, 1080p/30Hz and 1080p/60Hz. Please note that in some cases, a Blu-ray may only offer the choice of 1080/60i or 1080/24p. In this case, it is necessary to choose the 1080/60i output. Please refer to your Blu-ray manual for complete details on choosing the correct output.
- Some HDMI Output Devices may fail to detect this TV as a 1080p device. If this occurs, manually select 1080p on the HDMI Output Device.

Connect a Computer

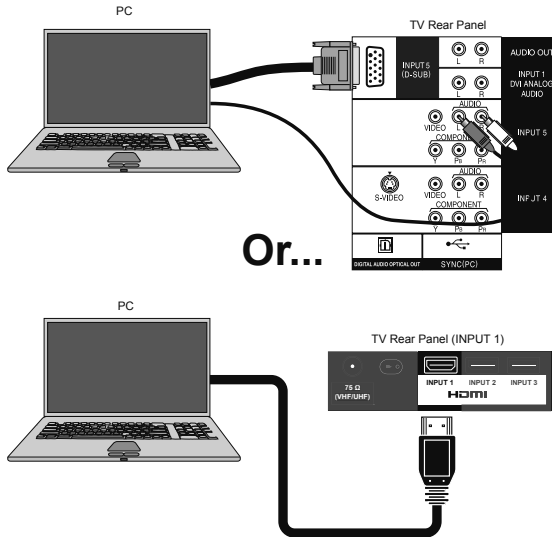

Notes:

- Make sure your TV is displaying INPUT 1, INPUT 2, INPUT 3 or INPUT 5 by pressing the **V1**, **V2**, **V3** or **V5** button on your remote control.
- To use **PC Smart Input** function, see page 43.
- When you connect a PC using HDMI-DVI cable, connect an audio cable to INPUT 1 DVI ANALOG AUDIO on the TV.
- Use a D-SUB cable with ferrite cores and no longer than 3 meters to avoid electromagnetic disturbances.
- Refer to your computer's manual for more information.

Format	Resolution	V. Frequency (Hz)	H. Frequency (kHz)
VGA	640 x 480	60	31.5
SVGA	800 x 600	60	37.9
XGA	1024 x 768	60	48.4

D-SUB

Format	Resolution	V. Frequency (Hz)	H. Frequency (kHz)
VGA	640 x 480	60	31.5
SVGA	800 x 600	60	37.9
XGA	1024 x 768	60	48.4
FHD	1920 x 1080	60	67.4

HDMI

Notes:

- Depending on signal quality, some pictures may not be displayed correctly.
- Computers that cannot set the refresh rate to 60 Hz, cannot be used with this TV.
- If you are inputting a PC signal that is invalid, **"No signal or Signal can not be displayed"** will appear on the TV screen. It appears when the input is PC and it is a single screen.
- When you connect a PC using an HDMI cable, the TV image may not be displayed correctly.

Troubleshooting

Refer to the table below to check the condition. If you think that there is a problem, contact the JVC Service Center where you purchased the television.

There is no power

- See if the power cord became unplugged.
 - Check for a blown fuse or circuit breaker or a power outage.
-

There is no picture or sound

- The antenna could be disconnected.
 - The tuner could be set improperly. See page 58.
 - The TV station may be having difficulties. Check to see if other stations are working.
 - Use the HDMI cable with HDMI logo.
 - If you have a device connected to INPUT-1, INPUT-2 or INPUT-3, you will not be able to hear any audio from the AUDIO OUT on the back of the TV.
 - You cannot output audio using the DIGITAL AUDIO OPTICAL OUT when you have digital sound from an HDMI device connected to the INPUT-1, INPUT-2 or INPUT-3 connection on the back of the TV.
 - This TV can accept 480i (Composite / S / HDMI / Component), 480p, 720p, 1080i and 1080p signals. Please check your settings.
-

Remote control is not operating properly or at all

- Check to see that the batteries are still working and properly installed.
 - Make sure the remote has a clear sight path to the TV.
 - You may be too far from the TV. You must be within 23 feet (7 meters).
-

The power turns off by itself

- Make sure the set did not become unplugged.
 - Perhaps the **Auto Shut Off** is set. See page 41.
 - Check to see if the **Sleep Timer** was set. See page 18.
-

It does not operate correctly

- This television is operated by a microprocessor. It is possible that external noise or interference is causing the problem. If the television does not function correctly, remove the electrical plug from the wall outlet and wait a while before inserting it into the wall outlet again and operating the television.
-

The color quality is poor

- **Tint** and **Color** may be improperly adjusted. See page 26.
 - The **Video Status** mode may be turned to the wrong setting. See page 26.
-

There are lines across the picture

- There could be interference from another electrical appliance, such as a computer, another TV or VCR. Move any such appliances further away from the TV.
-

The picture is spotted

- There could be interference from a high-wattage appliance, like a hairdryer or vacuum, operating nearby. Move the antenna away from the appliance or change to a coaxial cable connection which is less prone to interference.
-

There are double pictures (ghosts)

- A building or passing airplane can reflect the original signal and produce a second, slightly delayed one. Adjust your antenna position.

Picture is snowy (image noise)

- Your antenna may be damaged, disconnected or turned. Check the antenna connection. If the antenna is damaged, replace it.

Screen is 80% black

- The Closed Caption Text mode is on. Turn it off in the **Closed Caption** menu, page 31.

Stereo or bilingual programs can't be heard

- Make sure the **MTS** settings are correct. See page 39.

Static electricity

- It is normal to feel static electricity if you brush or touch the screen.

You hear occasional crackling sounds

- It is normal for the TV to make crackling sounds when first turned on or off. Unless the sound or picture become abnormal, this is fine.

The picture is slightly cut off when you use 1080p format only

- Change the picture format setting on your external device to 1080i or other resolution.

The screen disappears except for the menu screen

- This occurs when you select a digital channel that you input source is from the HDMI connection. Press the **MENU** button.

My HDMI device doesn't work or doesn't work properly

- Please use a High Speed HDMI™ Cable. High Speed HDMI™ Cable are tested to carry an HD signal up to 1080p and higher.

No signal or signal can not be displayed

- This OSD appears when the digital channel that you have selected is too weak to receive or no signal is being detected for that channel.
- It appears when that channel is not receiving a signal and you have the **Noise Mute** function **Off** and you have a single screen. It moves automatically every two seconds to prevent the screen from burn-in.
- Even if "**No signal or signal can not be displayed**" appears on the screen, your timer functions and auto shut off functions that you set, are still active.

The following are not malfunctions.

- The television may make a creaking sound if the temperature of the room or the temperature of the inside of the television changes. If there is no problem with the screen or sound, then there is no need to worry.
- The picture may be temporarily disturbed and noise may be seen on the screen if the power is turned on immediately after it has been turned off. This is not a malfunction.

Specifications

Model	LT-32P300	LT-42P300 LT-42PM30	LT-46P300
Type	LCD Flat Television		
Reception Format	NTSC, BTSC System (Multi-Channel Sound) ATSC Terrestrial, Digital Cable		
Reception Range	VHF 2 to 13, UHF 14 to 69 at ATSC, CATV 135 Sub, Mid, Super, Hyper and Ultra bands at Digital Cable		
	VHF 2 to 13, UHF 14 to 69 CATV 135 Sub, Mid, Super, Hyper and Ultra bands (191 channel frequency synthesizer system) at Analog • Reception of channel A-5 ("95" of the TV set's on-screen cable channel numbers) is not recommended for your TV set.		
Power Source	AC 120V, 60 Hz		
Power Consumption	155W	215W	215W
Screen Size	32 inch / 80.03 cm measured diagonally, 16:9 ratio	42 inch / 106.73 cm measured diagonally, 16:9 ratio	45.9 inch / 116.80 cm measured diagonally, 16:9 ratio
Audio Output	10W + 10W		
Speakers	4 x 16cm Oblique x 2		
iPod Output Power	5 V, 500 mA		
Antenna Terminal (VHF/UHF, ATSC/DIGITAL CABLE IN)	75 ohms (VHF/UHF)(F-type connector)		
Input 4, 5 Terminal	480i S (Input 4) Y: 1 Vp-p positive, 75 ohms (negative sync provided) C: 0.286 Vp-p (burst signal), 75 ohms Video: 1 Vp-p, 75 ohms Audio: 500 mVrms (-4dBs) high impedance		
Input 4, 5 Terminal (Component Terminal)	1080i / 720p / 480p / 480i Y: 1 Vp-p positive, 75 ohms (negative sync provided) Pa/Pb: 0.7 Vp-p 75 ohms		
Input 1, 2, 3 Terminal (HDMI Input Terminal)	Video: 1080p / 1080i / 720p / 480p / 480i Audio: 2ch PCM, 32 / 44.1 / 48 KHz 16 / 20 / 24 bit		
PC Input Jacks	Analog RGB D-SUB (15 pin) x 1		
Audio Output Jacks (FIX)	FIX : 500mVrms (-4dBs), Low Impedance		
Optical Output Digital Audio	Digital Out (optical) x 1		
Dimensions (inch/mm) W X H X D	31 1/4 x 23 1/2 x 9 1/8 (with stand) 792 x 595.7 x 230 (with stand)	39 7/8 x 28 7/8 x 11 5/8 (with stand) 1013.6 x 733.5 x 296 (with stand)	44 3/8 x 31 1/2 x 11 5/8 (with stand) 1127 x 799.7 x 296 (with stand)
	31 1/4 x 21 1/2 x 4 3/8 (without stand) 792 x 544.6 x 109.6 (without stand)	39 7/8 x 26 5/8 x 4 1/2 (without stand) 1013.6 x 677.3 x 114.8 (without stand)	44 3/8 x 29 1/4 x 4 1/2 (without stand) 1127 x 743.2 x 114.8 (without stand)
Weight (lbs / kg)	29.0 / 13.2 (with stand)	49.5 / 22.5 (with stand)	55.9 / 25.4 (with stand)
	27.1 / 12.3 (without stand)	46.0 / 20.9 (without stand)	52.4 / 23.8 (without stand)

Specifications subject to change without notice.



LIMITED WARRANTY

1-1 USA ONLY

ONLY FOR PRODUCT PURCHASED IN U.S.A.

JVC Americas Corp. (JVC) warrants this product and all parts thereof, except as set forth below ONLY TO THE ORIGINAL RETAIL PURCHASER to be FREE FROM DEFECTIVE MATERIALS AND WORKMANSHIP from the date of original purchase for the period shown below. ("The Warranty Period")

PARTS	1 YR	LABOR	1 YR
-------	-------------	-------	-------------

THIS LIMITED WARRANTY IS VALID ONLY IN THE FIFTY (50) UNITED STATES, THE DISTRICT OF COLUMBIA AND IN THE COMMONWEALTH OF PUERTO RICO.

WHAT WE WILL DO:

If this product is found to be defective within the warranty period, JVC will repair or replace defective parts with new or rebuilt equivalents at no charge to the original owner. Such repair and replacement services shall be rendered by JVC during normal business hours at JVC authorized service centers. Parts used for replacement are warranted only for the remainder of the Warranty Period. All products may be brought to a JVC authorized service center on a carry-in basis. Color televisions with a screen size of 37" class or greater qualify for in-home service. In such cases, a technician will come to your home and either repair the TV there or remove and return it if it cannot be repaired in your home.

WHAT YOU MUST DO FOR WARRANTY SERVICE:

Please do not return your product to the retailer
Instead, return your product to the JVC authorized service center nearest you. If shipping the product to the service center, please be sure to package it carefully, preferably in the original packaging, and include a brief description of the problem(s). Please call 1-800-252-5722 to locate the nearest JVC authorized service center. Service locations can also be obtained from our website <http://www.jvc.com>. If your product qualifies for in-home service, the service representative will require clear access to the product.

If you have any questions concerning your JVC Product, please contact our Customer Care Center at 800-252-5722

WHAT IS NOT COVERED:

This limited warranty provided by JVC does not cover:

1. Products which have been subject to abuse, accident, alteration, modification, tampering, negligence, misuse, faulty installation, lack of reasonable care, or if repaired or serviced by anyone other than a service facility authorized by JVC to render such service, or if affixed to any attachment not provided with the products, or if the model or serial number has been altered, tampered with, defaced or removed;
2. Initial installation, installation and removal from cabinets or mounting systems.
3. Operational adjustments covered in the Owner's Manual, normal maintenance, video and audio head cleaning;
4. Damage that occurs in shipment, due to act of God, and cosmetic damage;
5. Signal reception problems and failures due to line power surge;
6. User Removal Memory Devices/Video Pick-up Tubes/CCD Image Sensors are covered for 90 days from the date of purchase;
7. Accessories;
8. Batteries (except that Rechargeable Batteries are covered for 90 days from the date of purchase);
9. Products used for commercial purposes, including, but not limited to rental.
10. Loss of data resultant from malfunction of hard drive or other data storage device;

There are no express warranties except as listed above.

THE DURATION OF ANY IMPLIED WARRANTIES, INCLUDING THE IMPLIED WARRANTY OF MERCHANTABILITY, IS LIMITED TO THE DURATION OF THE EXPRESS WARRANTY HEREIN.

JVC SHALL NOT BE LIABLE FOR ANY LOSS OF USE OF THE PRODUCT, INCONVENIENCE, OR ANY OTHER DAMAGES, WHETHER DIRECT, INCIDENTAL OR CONSEQUENTIAL (INCLUDING, WITHOUT LIMITATION, DAMAGE TO TAPES, RECORDS OR DISCS) RESULTING FROM THE USE OF THIS PRODUCT, OR ARISING OUT OF ANY BREACH OF THIS WARRANTY. ALL EXPRESS AND IMPLIED WARRANTIES, INCLUDING THE WARRANTIES OF MERCHANTABILITY AND FITNESS FOR PARTICULAR PURPOSE, ARE LIMITED TO THE WARRANTY PERIOD SET FORTH ABOVE.

Some states do not allow the exclusion of incidental or consequential damages or limitations on how long an implied warranty lasts, so these limitations or exclusions may not apply to you. This warranty gives you specific legal rights and you may also have other rights which vary from state to state.

JVC AMERICAS CORP.

1700 Valley Road, Wayne, New Jersey 07470
<http://www.jvc.com>

REFURBISHED PRODUCTS CARRY A SEPARATE WARRANTY, THIS WARRANTY DOES NOT APPLY. FOR DETAIL OF REFURBISHED PRODUCT WARRANTY, PLEASE REFER TO THE REFURBISHED PRODUCT WARRANTY INFORMATION PACKAGED WITH EACH REFURBISHED PRODUCT.

For customer use:

Enter below the Model No. and Serial No. which is located either on the rear, bottom or side of the cabinet. Retain this information for future reference.

Model No. :	Serial No. :
Purchase date :	Name of dealer :

TO OUR VALUED CUSTOMER _____

THANK YOU FOR PURCHASING THIS JVC PRODUCT.
WE WANT TO HELP YOU ACHIEVE A PERFECT EXPERIENCE.

**NEED HELP ON HOW TO HOOK UP?
NEED ASSISTANCE ON HOW TO OPERATE?
NEED TO LOCATE A JVC SERVICE CENTER?
LIKE TO PURCHASE ACCESSORIES?**

JVC[®] IS HERE TO HELP!

U.S.A.

TOLL FREE: 1 (800) 252-5722
<http://www.jvc.com>

Canada

TOLL FREE: 1 (800) 964-2650
<http://www.jvc.ca>

Remember to retain your Bill of Sales for Warranty Service.

JVC U.S.A.
Division of JVC Americas Corp.
1700 Valley Road
Wayne, New Jersey, 07470

JVC[®]

JVC CANADA, INC.
21 Finchdene Square
Scarborough, Ontario
Canada, M1X 1A7

Free Manuals Download Website

<http://myh66.com>

<http://usermanuals.us>

<http://www.somanuals.com>

<http://www.4manuals.cc>

<http://www.manual-lib.com>

<http://www.404manual.com>

<http://www.luxmanual.com>

<http://aubethermostatmanual.com>

Golf course search by state

<http://golfingnear.com>

Email search by domain

<http://emailbydomain.com>

Auto manuals search

<http://auto.somanuals.com>

TV manuals search

<http://tv.somanuals.com>