

JVC®

LCD Flat Television Users Guide

For Models:
LT-37X688
LT-42X688
LT-42X788
LT-47X788
LT-37XM48
LT-42XM48



Illustration of LT-37X688 and RM-C1450

Important Note:

In the spaces below, enter the model and serial number of your television (located at the rear of the television cabinet). Staple your sales receipt or invoice to the inside cover of this guide. Keep this user's guide in a convenient place for future reference. Keep the carton and original packaging for future use.

Model Number: _____

Serial Number: _____

LCT2275-001B-A
0607TNH-II-IM

Important Safety Precautions



CAUTION
RISK OF ELECTRIC SHOCK
DO NOT OPEN



CAUTION: To reduce the risk of electric shock. Do not remove cover (or back). No user serviceable parts inside. Refer servicing to qualified service personnel.

 The lightning flash with arrowhead symbol, within an equilateral triangle is intended to alert the user to the presence of uninsulated "dangerous voltage" within the product's enclosure that may be of sufficient magnitude to constitute a risk of electric shock to persons.

 The exclamation point within an equilateral triangle is intended to alert the user to the presence of important operating and maintenance (servicing) instructions in the literature accompanying the appliance.

WARNING: TO PREVENT FIRE OR SHOCK HAZARDS, DO NOT EXPOSE THIS APPARATUS TO RAIN OR MOISTURE.

CAUTION: TO INSURE PERSONAL SAFETY, OBSERVE THE FOLLOWING RULES REGARDING THE USE OF THIS UNIT.

1. Operate only from the power source specified on the unit.
2. Avoid damaging the AC plug and power cord.
3. Avoid Improper installation and never position the unit where good ventilation is unattainable.
4. Do not allow objects or liquid into the cabinet openings.
5. In the event of trouble, unplug the unit and call a service technician. Do not attempt to repair it yourself or remove the rear cover.

Changes or modifications not approved by JVC could void the warranty.

- * When you don't use this TV set for a long period of time, be sure to disconnect both the power plug from the AC outlet and antenna for your safety.
- * To prevent electric shock do not use this polarized plug with an extension cord, receptacle or other outlet unless the blades can be fully inserted to prevent blade exposure.



- As an "ENERGY STAR®" partner, JVC has determined that this product or product model meets the "ENERGY STAR®" guidelines for energy efficiency.

IMPORTANT RECYCLING INFORMATION

This product has a fluorescent lamp that contains mercury. Disposal of these materials may be regulated in your community due to environmental considerations. For disposal or recycling information, please contact your local authorities or for USA, the Electronic Industries Alliance: <http://www.eiae.org>

IMPORTANT SAFETY INSTRUCTIONS

- 1) Read these instructions.
- 2) Keep these instructions.
- 3) Heed all warnings.
- 4) Follow all instructions.
- 5) Do not use this apparatus near water.
- 6) Clean only with dry cloth.
- 7) Do not block any ventilation openings. Install in accordance with the manufacturer's instructions.
- 8) Do not install near any heat sources such as radiators, heat registers, stoves, or other apparatus (including amplifiers) that produce heat.
- 9) Do not defeat the safety purpose of the polarized or grounding-type plug. A polarized plug has two blades with one wider than the other. A grounding type plug has two blades and a third grounding prong. The wide blade or the third prong are provided for your safety. If the provided plug does not fit into your outlet, consult an electrician for replacement of the obsolete outlet.
- 10) Protect the power cord from being walked on or pinched particularly at plugs, convenience receptacles, and the point where they exit from the apparatus.
- 11) Only use attachments/accessories specified by the manufacturer.
- 12) Use only with a cart, stand, tripod, bracket, or table specified by the manufacturer, or sold with the apparatus. When a cart is used, use caution when moving the cart/apparatus combination to avoid injury from tip-over.



- 13) Unplug this apparatus during lightning storms or when unused for long periods of time.
- 14) Refer all servicing to qualified service personnel. Servicing is required when the apparatus has been damaged in any way, such as power-supply cord or plug is damaged, liquid has been spilled or objects have fallen into the apparatus, the apparatus has been exposed to rain or moisture, does not operate normally, or has been dropped.
- 15) Apparatus shall not be exposed to dripping or splashing and no objects filled with liquids, such as vases, shall be placed on the apparatus.
- 16) Avoid improper installation and never position the unit where good ventilation is impossible. When installing this TV, distance recommendations must be maintained between the set and the wall, as well as inside a tightly enclosed area or piece of furniture. Keep to the minimum distance guidelines shown for safe operation.

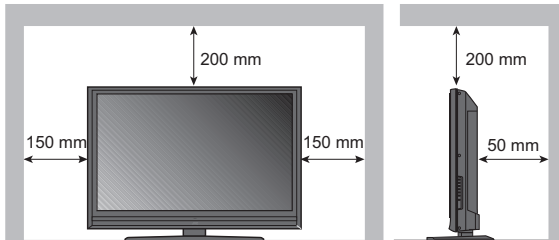

17) Cautions for installation

- Do not tilt the TV towards the left or right, or towards the back.
 - Install the TV in a corner on the floor so as to keep cords out of the way.
 - The TV will generate a slight amount of heat during operation. Ensure that sufficient space is available around the TV to allow satisfactory cooling.
- 18) Make enough room for inserting and removing the power plug. Place the TV as close to the outlet as possible. The main power supply for this TV is controlled by inserting or removing the power plug.
 - 19) Batteries shall not be exposed to excessive heat such as sunshine, fire or the like.
 - 20) When this TV is connected to the wall outlet, it is always on standby even when all the LED lamps are not lit. To shut down the TV, unplug the TV from the wall outlet.

Warnings

We have an important note for customers who subscribe to basic cable services (do not have a separate cable box) and plan to use their JVC TV remote control to select channels.

Once you run the Auto Tuner Setup (which detects and programs all the channels your TV is receiving through the RF input), every channel number available from your cable company will appear in your television's Channel Summary and they will all be marked as available for scanning. Even though every channel is detected and appears as available, you will only be able to view those that you specifically subscribe to from your cable company. This will likely mean there are blank channels between those channels you wish to scan or "surf".

We apologize for any inconvenience this may cause but it is important to note that this is not a malfunction of your television. If you want to sequentially scan those channels you subscribe to without blank ones in between, you can contact your cable company for their cable box and remote.

Avoiding Ghost Images

Displaying fixed images for extended periods of time can leave a subtle but temporary ghost image on your screen. To avoid this, mix your viewing pattern.

Examples include, but are not limited to the following:

- Stock-market report bars
- Shopping channel logos and pricing displays
- Video game patterns or scoreboards
- Bright station logos
- Internet web sites or other computer-style images
- DVD discs, video tapes, laser discs
- Broadcast, cable, satellite channels or digital television tuners/converters

For example...

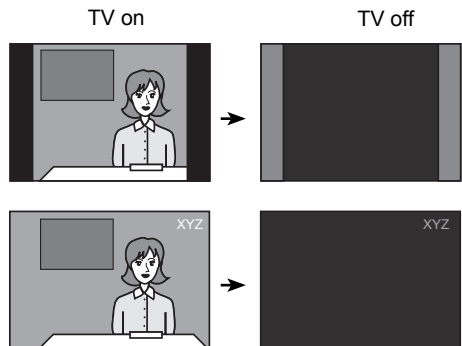

Warnings

Caring for the Cabinet

Normally, light dusting with a soft, non-scratching duster will keep your TV clean.

If you wish to wipe down the television, first unplug it. Then wipe gently with a soft cloth, slightly moistened with water. You can add a few drops of mild liquid detergent to the water to help remove spots of oily dirt.

- DO NOT allow liquid to enter the TV through the ventilation slots.
- DO NOT use strong or abrasive cleaners on the TV.
- DO NOT spray liquids or cleaners directly on the TV's surface.
- DO NOT rub or scrub the TV harshly. Wipe the set gently with a soft cloth.

Caring for the Screen

The screen is treated with an electrostatic-proof coating. When it gets dirty, wipe it gently with a soft cloth. If the screen is very dirty, wipe it down with a cloth dipped in a diluted kitchen cleaner and thoroughly wrung-out. Then wipe immediately after with a clean, dry cloth.

Do not apply alcohol, organic solvents (like acetone), acidic or alkaline cleansers to the screen. These will remove the coating layer and cause discolorations.

Do not push or hit the screen. This could cause scratches on the screen surface and image distortions.

Tidying the cables

A cable holder which keeps your connection cables tidy is attached to the back of the stand.

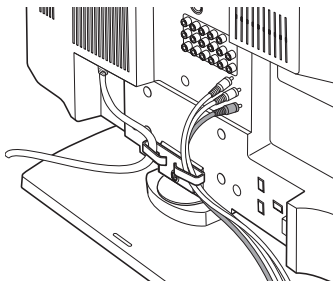

Note:

- This illustration is for models LT-37X688, LT-42X688, LT-37XM48 and LT-42XM48. The rear panel for models LT-42X788 and LT-47X788 are slightly different in shape.

Warnings

Disconnecting the stand

If you disconnect the stand, attach the bottom cover and the screw (supplied) into the hole.

This illustration is for models LT-37X688, LT-42X688, LT-37XM48 and LT-42XM48. You can disconnect the stand for models LT-42X788 and LT-47X788 using the same method.

- 1) Place the TV face down on a soft cloth on a table.
- 2) Remove the four screws from the back of the TV.

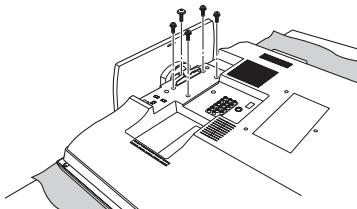

- 3) Pull out the stand from the TV.

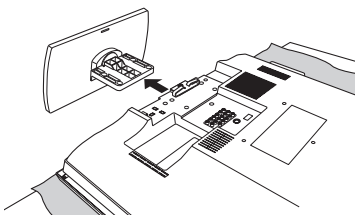

- 4) Cover the hole with a bottom cover and tighten the screw.

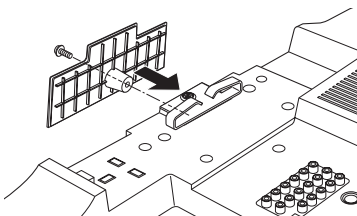

Note:

- To re-install the stand, reverse the procedure from 4) to 1).

Table of Contents

Important Safety Precautions . . .	2	Sound Adjust	51
Warnings	5	Sound Settings	51
Quick Setup	9	Turn On Volume	51
Unpacking your TV	9	Volume Limit	52
TV Models	10	Reset	52
TV Remote Control	11	Clock/Timers	53
Getting Started	12	Set Clock	53
The Remote Control	12	On/Off Timer	54
Connecting Your Devices	13	Photo Viewer	55
Interactive Plug-in Menu	22	Auto Demo	57
Onscreen Menus	25	Button Functions	58
Using the Guide	25	Power	58
Onscreen Menu System	26	Number Buttons	58
Initial Setup	29	Tune	58
Noise Muting	29	Sub Channel	58
Language	29	Input	59
Front Panel Lock	29	Channel +/-	59
V-Chip	30	Volume +/-	59
Set Lock Code	36	Return+/TV	59
Closed Caption	37	Sound	60
Auto Shut Off	39	Muting	60
Software Version	39	Video Status	60
Power Indicator	39	Sleep Timer	61
Optical Out	40	Display	61
Quick Start-up	40	Aspect	62
Tuner Setup	41	Menu	63
Auto Tuner Setup	41	OK	63
Channel Summary	42	Back	63
Find Channel	44	ML/MTS	64
Digital Antenna Level	44	C.C.	64
Tuner Diagnostic	44	Favorite	65
External Input	45	Guide	65
HDMI Size	45	Mode	66
Video-1 Audio	45	External device control buttons	66
Video Input Label	46	Remote Programming	67
Picture Adjust	47	OSD Information	73
Picture Settings	47	Weak Signal	73
Color Temperature	47	Audio/Data Only Channel	73
Color Management	48	Troubleshooting	74
Dynamic Gamma	48	Specifications	76
Smart Picture	48	Warranty	78
Digital VNR	49	Authorized Service Center	79
MPEG NR	49		
Natural Cinema	49		
Position Adjustment	50		
Reset	50		

Unpacking your TV

Thank you for your purchase of a JVC LCD Flat Television. Before you begin setting up your new television, please check to make sure you have all of the following items. In addition to this guide, your television box should include:

Television x 1



Remote Control x 1



AA Batteries x 2



Note: Your television and/or remote control may differ from the examples illustrated here.

Cover x 1

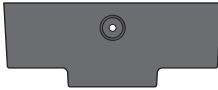

Screw x 1



We recommend that before you start using your new television, you read this entire User's Guide so you can learn about your new television's many great features. If you're anxious to start using your television right away, a quick setup guide follows on the next few pages.

Quick Setup

TV Models

Before you connect your television to another device, please refer to the proper diagrams for your specific TV and remote. These will help assist you in understanding how to connect your television to another device, as well as use the remote to set up your television.

Rear Panel Diagram

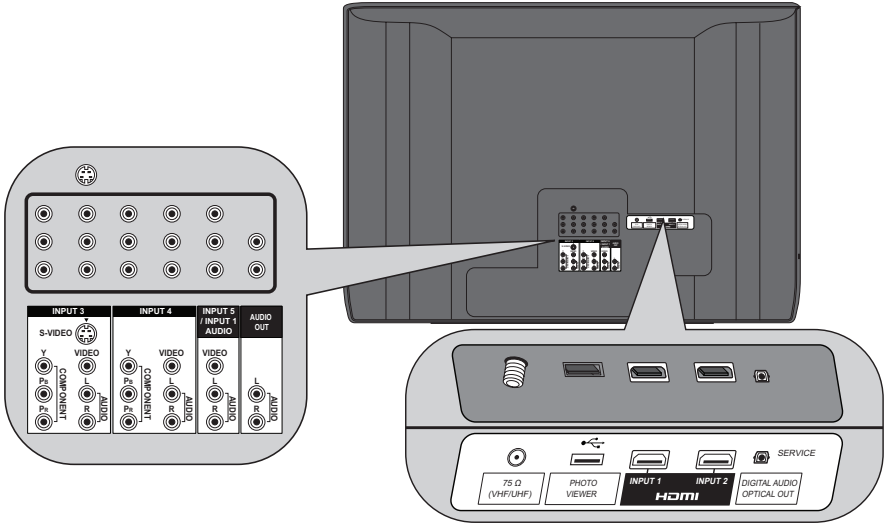

Side Panel Diagram

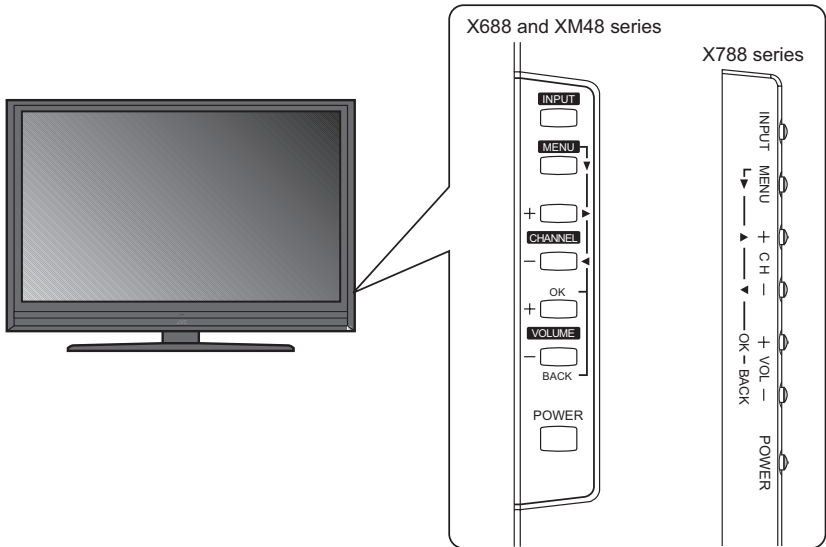

Remote Control



RM-C1450

Notes:

- For information on remote control buttons, see pages 58 - 66.
- SUB CHANNEL and GUIDE buttons are for digital channels. If your TV is connected to an ATSC antenna or Digital Cable, you can use these buttons.
- This remote control is capable of operating many external device brands. See page 67 - 72 for how to program the remote control.

Quick Setup

Getting Started

These quick setup pages will provide you, in three easy steps, with the basic information you need to begin using your new television right away. If you have questions, or for more detailed information on any of these steps, please consult other sections of this manual.

Step 1 – The Remote Control

Before you can operate your remote control, you first need to install the batteries (included).

Raise the latch on the remote's back cover to remove. Insert two batteries, carefully noting the "+" and "-" markings. Place the "-" end in the unit first. Snap the cover back into place.

When you change the batteries, try to complete the task within three minutes. If you take longer than three minutes, the remote control codes (ex. VCR, DVD) may have to be reset. See pages 67 - 72.

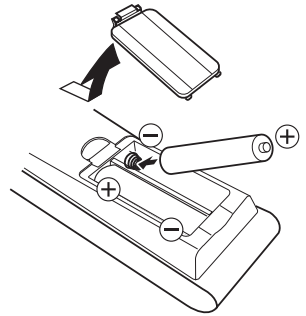

Basic Operation

Turn the television on and off by pressing the **POWER** button at the top right corner of the remote. If this is the first time you are turning on the TV, the interactive plug-in menu appears.

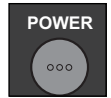

- At first, to watch your TV, select the TV mode by pressing the **MODE** button on the remote control before you turn the TV power on.
- See page 58 to 66 for details regarding the remote control buttons.

Using Menu Buttons

To use the menu functions, press the **MENU** button. Next, select a menu using the four arrow keys. The four arrow keys are used only for menu selections.

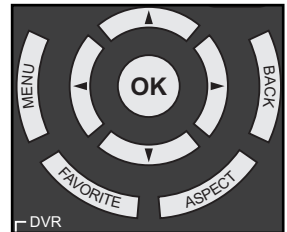

Step 2 - Connecting your devices

To make these connections, you will use plugs like the ones illustrated below.

Coaxial Cables



Used to connect an external antenna or cable TV system to your TV.

S-Video Cable



Used to make video connections with S-Video VCRs, Camcorders and DVD players.

Component Cables Composite Cables Audio Cables



Used to connect audio/video devices like VCRs, DVD players, stereo amplifiers, game consoles, etc.

Notes:

- The following connection diagrams are examples.
- After you are finished connecting your devices, plug the power cord into the nearest power outlet and turn on the TV.
- If you follow these diagrams and the television does not work properly, contact your local cable operator.
- To connect a DVD player, see VCR Connection.
- If you have a satellite television system, refer to the satellite TV manual.

No VCR Connection

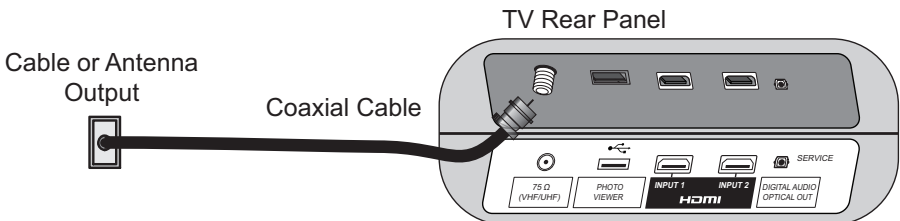

Quick Setup

VCR • DVD Connection

Notes:

- Green, blue and red are the most common colors for DVD cables. Some models may vary colors. Please consult the user's manual for your DVD player for more information.
- Be careful not to confuse the red DVD cable with the red audio cable. It is best to complete one set of connections (DVD or audio output) before starting the other to avoid accidentally switching the cables.
- You may also connect the DVD player to Input 1.

Diagram #1

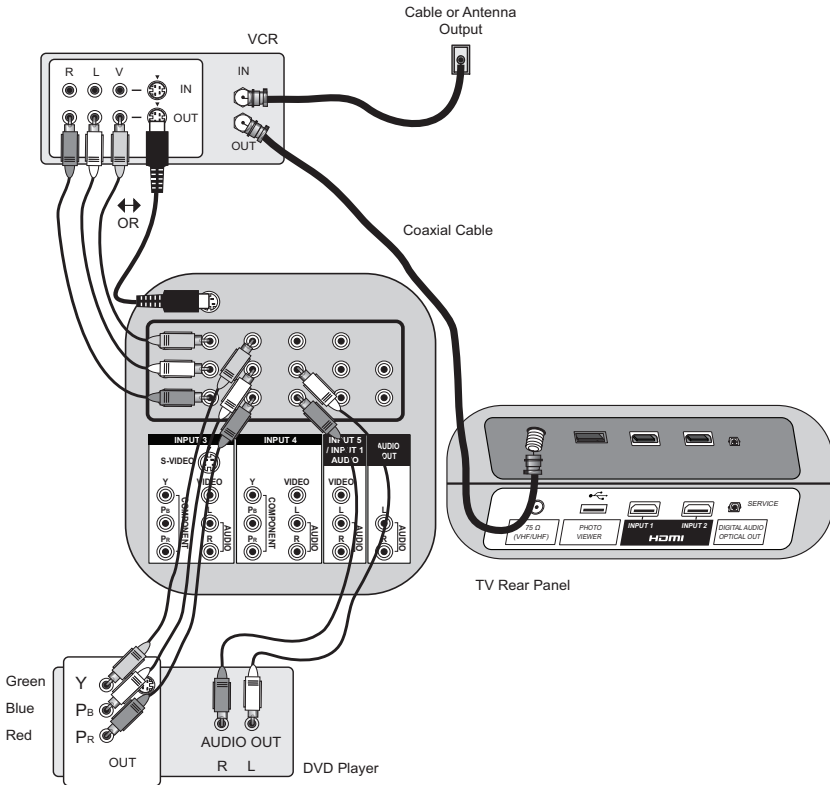

Note:

- If this connection setup does not work for you, try the connection setup on page 15.

Diagram #2

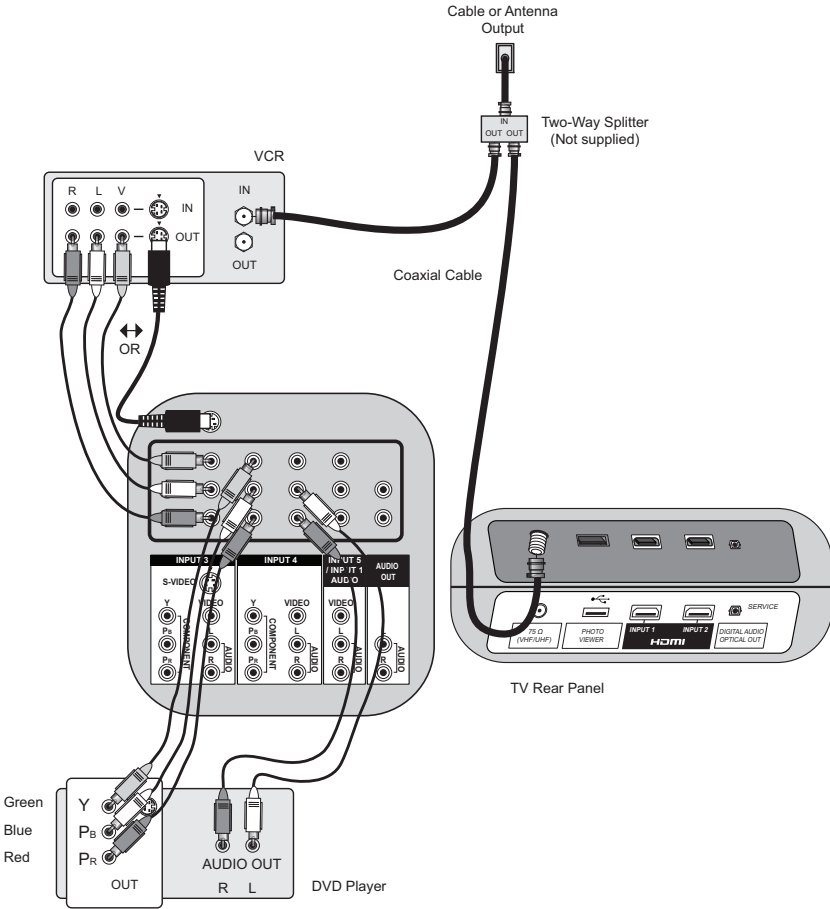

Quick Setup

Connecting to a Camcorder

You can connect a camcorder to your television by using the input jacks located on the back of the TV.

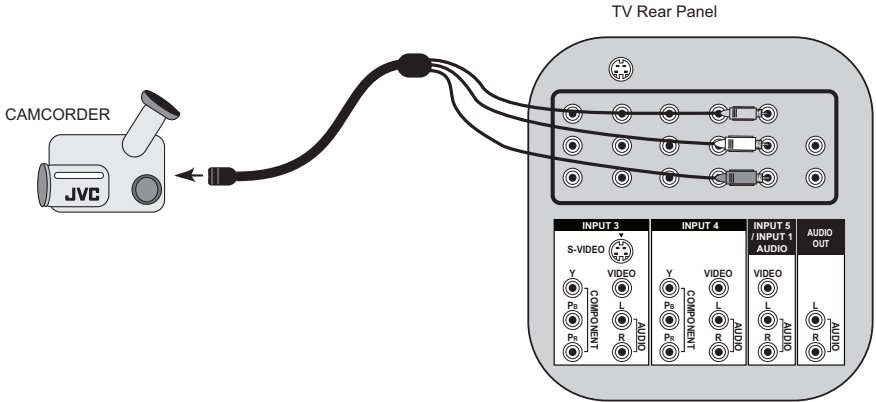

- 1) Connect a yellow composite cable from the camcorder VIDEO OUT to the VIDEO IN on the back of the TV.
- 2) Connect a white cable from the camcorder LEFT AUDIO OUT to the LEFT AUDIO IN on the back of the TV.
- 3) Connect a red cable from the camcorder RIGHT AUDIO OUT to the RIGHT AUDIO IN on the back of the TV.

Connecting to an External Amplifier

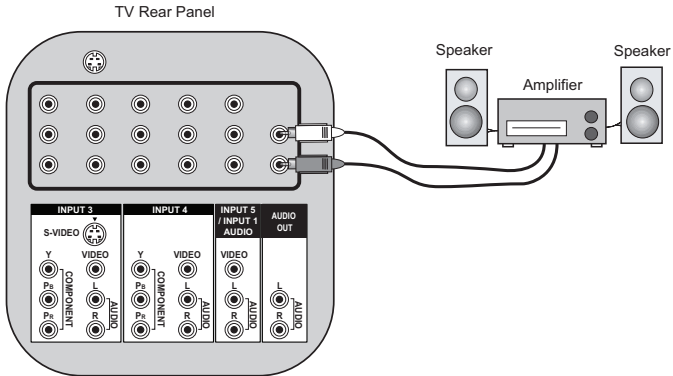

- 1) Connect a white cable from the LEFT AUDIO OUTPUT on the back of the TV to the LEFT AUDIO INPUT on the amplifier.
- 2) Connect a red cable from the RIGHT AUDIO OUTPUT on the back of the TV to the RIGHT AUDIO INPUT on the amplifier.

Notes:

- Refer to your amplifier's manual for more information.
- You can use AUDIO OUTPUT for your home theater system.
- If you have a device connected to INPUT-1 or INPUT-2, you will not be able to hear any audio from the AUDIO OUT on the back of the TV.

Quick Setup

Connecting to a Digital TV Receiver

By connecting a Digital TV Receiver, high definition pictures can be displayed on your TV in their digital form.

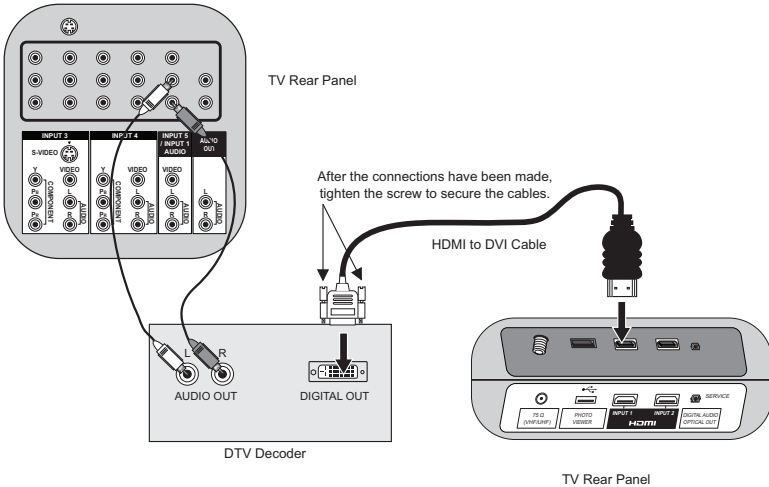

- 1) Connect the HDMI to DVI Cable from the DIGITAL OUT on the back of your DTV decoder to the HDMI INPUT-1 on the back of the TV.
 - 2) Connect a red cable from the DTV decoder RIGHT AUDIO OUT to the RIGHT AUDIO INPUT HDMI AUDIO IN "R" on the back of the TV.
 - 3) Connect a white cable from the DTV decoder LEFT AUDIO OUT to the LEFT AUDIO INPUT HDMI AUDIO IN "L" on the back of the TV.
- Personal computer compatibility cannot be guaranteed.
 - Use an HDMI to DVI cable (commercially available) in order to digitally connect the television with a DTV decoder.

Notes:

- If 480p signals (640x480 or 720x480) are displayed on the screen, the horizontal balance may be slightly shifted. Access the "HDMI Size" in the External Input menu to adjust it. (Refer to page 45.)
- When you do the above connection, set "Video-1 Audio" in the External Input menu to "Analog". See "Video-1 Audio", page 45.
- The Analog Audio input can only be used with the HDMI INPUT-1.
- When setting the "Video-1 Audio - Analog/Digital" menu setting on the TV, please note that this setting only effects the HDMI INPUT-1 jack and that if you use a DVI to HDMI adapter this connection must be made to the HDMI INPUT-1 along with analog audio cables.

Connecting to an HDMI Compatible Device

By connecting an HDMI compatible device, high definition pictures can be displayed on your TV in their digital form. Some HDMI devices can include DVD players, D-VHS or any HDMI compatible device.

HDMI (High Definition Multimedia Interface) is the first industry supported, uncompressed, all digital audio/video interface. HDMI provides an interface between any audio/video source, such as a set-top box, DVD player, A/V receiver or an audio and/or video monitor, such as a digital television (DTV).

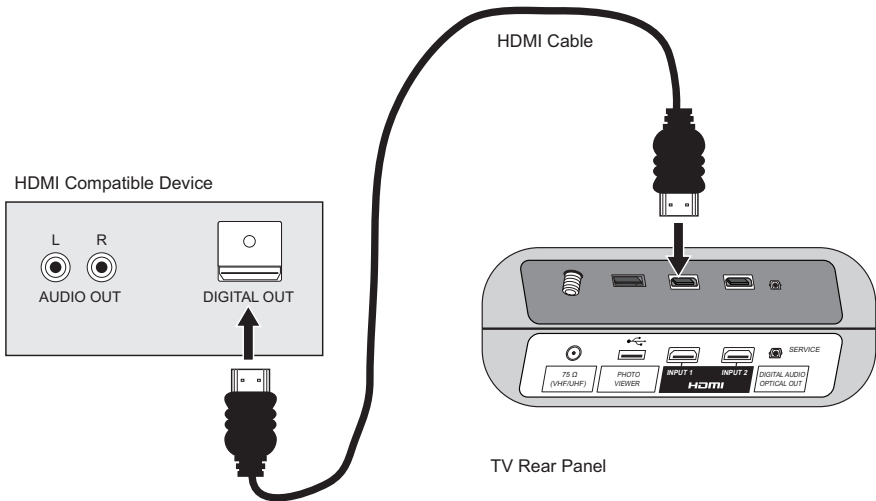

- 1) Connect the HDMI Cable from the DIGITAL OUT on the back of your DTV or HDMI device to the HDMI INPUT-1 on the back of the TV.

Notes:

- When you do the above connection, set "Video-1 Audio" in the External Input menu to Digital. See "Video-1 Audio", page 45.
- Some decoders may not respond depending on the equipment that is connected to the HDMI.
- If the HDMI output device signal is changed (for example, 480i/60Hz is changed to 480p/60Hz), the screen may turn green and there may be some distortion for a short time until the signal becomes stable.
- This TV can accept 480i, 480p, 720p, 1080i and 1080p signals via HDMI.

Quick Setup

Connecting to an amplifier using your optical output

You can connect an amplifier that has an optical digital input terminal by using an optical digital cable from the optical output. The signal that is output can be PCM or DOLBY DIGITAL.

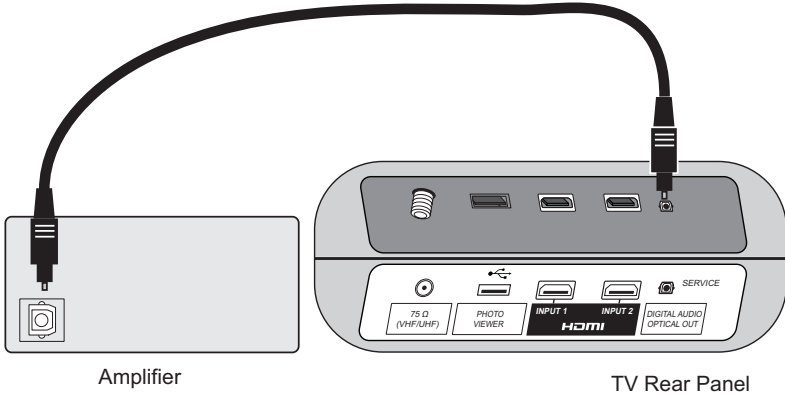

- 1) Connect the optical cable from underneath the television to the back of the amplifier.

Notes:

- This terminal can only output digital audio.
- In order to use the optical output connection, select PCM or DOLBY DIGITAL on Optical Out in the Initial Setup Menu. See page 40.
- Refer to your owners manual on using your amplifier.
- You cannot output sound from your Optical Output connection if the audio source is from your HDMI device.

Connecting to an AV Receiver using your television's V3 Smart Input

By connecting your AV Receiver to your television's V3 Smart Input, you can watch picture sources from many different devices, without having to change or use the other input connections on your TV. This allows you to free up the other input connections so you can connect more devices to your television.

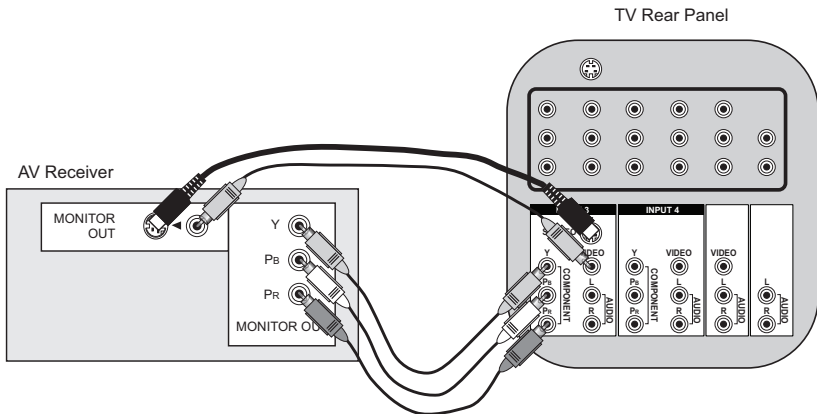

- 1) Connect an S-Video Cable from the AV Receiver's MONITOR OUT, to the S-Video INPUT-3 on the back of the TV.
- 2) Connect a Yellow Composite Cable from the AV Receiver's MONITOR OUT, into the VIDEO INPUT-3 on the back of the TV.
- 3) Connect a Green Component Cable from the AV Receiver's Y MONITOR OUT, into the Y VIDEO INPUT-3 on the back of the TV.
- 4) Connect a Blue Component Cable from the AV Receiver's P_B MONITOR OUT, into the P_B VIDEO INPUT-3 on the back of the TV.
- 5) Connect a Red Component Cable from the AV Receiver's P_R MONITOR OUT, into the P_R VIDEO INPUT-3 on the back of the TV.

Notes:

- Please refer to your AV Receiver instruction manual for more information on connecting your speakers and other devices like a DVD player.
- Use your AV Receiver's remote to switch to the different devices you have connected.
- Some AV Receivers may not respond when the V3 Smart Input function is turned on.
- If you have video connections for each input device connected to your AV Receiver, you should not connect them using both S-Video and Composite connection at the same time when you are using V3 Input as the V3 Smart Input. In this case we recommend using the S-Video connection.

Quick Setup

Step 3 – The Interactive Plug-in Menu

When you turn your television on for the first time the interactive plug-in menu will appear. The plug-in menu helps you to get your TV ready to use by letting you set your preferences for:

- The language in which you want the onscreen menus to appear.
- Setting the TV's clock to the correct time so your timer functions will work properly. You can choose "Auto" or "Manual" for setting the clock.
- The auto tuner setup of which channels you wish to receive.

We recommend you complete the interactive plug-in items before you start using your television. After the first time you turn on your TV, you can access the Interactive Plug-In Menu from the main menu. See page 28.

Note:

- If you press the MENU button while setting up the interactive plug-in menu, it will skip over it.

Language

After the "JVC Interactive Plug-in Menu" has been displayed, the TV automatically switches to the "Language" settings. You can choose to view your onscreen menus in three languages: English, French or Spanish.

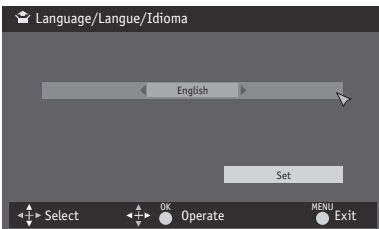

To choose a language:
(English, Français or Español.)



To "Set"



Press the Ok button

Once you press Ok, you will move to the "Set Clock" Plug-in Menu automatically.

(Continued...)

Auto Clock Set

You may set your clock using the time data sent via broadcasting.

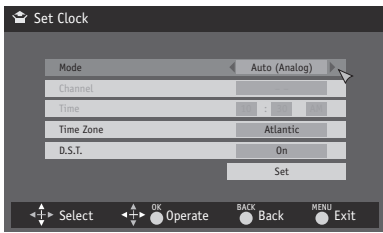

- ◀▶ To choose "Auto (Analog)" or "Auto (Digital)"
- ▼ To "Channel" when you selected "Auto (Digital)"
- ◀▶ To select a receiving digital channel
- ▼ To "Time Zone"
- ◀▶ To select your time zone: (Atlantic, Eastern, Central, Mountain, Pacific, Alaska or Hawaii)
- ▼ To move to "D.S.T." (Daylight Savings Time)
- ◀▶ To turn "On or Off"
- ▼ To "set"
- ▼ Press the OK button
- Once you press OK, you will move to the "Auto Tuner Setup" Plug-in Menu automatically.

Notes:

- "Channel" can be selected only when Mode is "Auto (Digital)". However, only when you are using "Auto (Digital)" for the first time, you cannot select "Channel".
- D.S.T. can be used when it is set to "On" in the "Set Clock" menu.
- Only when the Mode is set to "Auto", the Daylight Saving Time feature automatically adjusts your TV's clock for Daylight Saving.
- The real time and D.S.T. may not be set correctly depending on the broadcasting signal and receiving conditions. In this case, set your clock manually.
- You will have to reset the clock after a power interruption. You must set the clock before operating any timer functions.

Manual Clock Set

To set your clock manually, choose "Manual". If you choose "Auto", see auto clock set above.

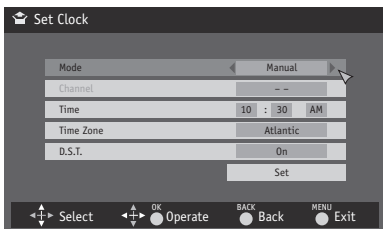

- ◀▶ To choose "Manual"
- ▼ To "Time"
- ◀▶ To set the hour
- ▼ To minute
- ◀▶ To set the minute
- ▼ To "Time Zone"
- ◀▶ To select your time zone: (Atlantic, Eastern, Central, Mountain, Pacific, Alaska or Hawaii)
- ▼ To move to "D.S.T." (Daylight Savings Time)
- ◀▶ To turn "On or Off"
- ▼ To "Set"
- ▼ Press the OK button
- Once you press OK, you will move to the "Auto Tuner Setup" Plug-in Menu automatically.

Note:

- You will have to reset the clock after a power interruption. You must set the clock before operating any timer functions.

(Continued...)

Quick Setup

Auto Tuner Setup

In auto tuner setup, the TV automatically scans through all available channels, memorizing the active ones and skipping over blank ones or channels with weak signals. This means when you scan (using the CHANNEL +/- buttons) you will receive only clear, active channels.

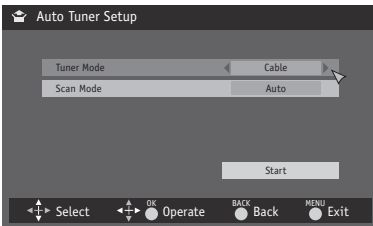

To choose "Cable" or "Air" (or "Skip" when you skip "Auto Tuner Setup")



To Scan Mode



To choose Auto, STD, HRC or IRC



To "Start"



Press the Ok button

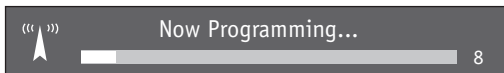

When the setup is finished, "Thank you ! Setup is now complete." is displayed. Your quick setup is now complete. You can now begin watching your television, or you can continue on in this guide for more information on programming your remote control, or using the JVC onscreen menu system to customize your television viewing experience.

Notes:

- You can choose Scan Mode only when Tuner Mode is Cable.
- If you want to cancel the Auto Tuner Setup, press the MENU button.
- Noise muting will not work during Auto Tuner Setup.
- If you choose "Skip", it finished without doing the Auto Tuner Setup.

Cable Users: After your auto tuner setup is complete, you may, (depending on the type of hookup), have only 1 channel, usually 3 or 4 in the auto tuner memory. This is normal.

Onscreen Menus

Using the Guide

Certain symbols are used throughout this guide to help you learn about the features of your new television. The ones you will see most frequently are:

- ▲▼ Up and Down arrows mean:
 - Move vertically in a main menu screen
 - Move through a submenu screen
 - Move to the next letter, number, or other choice in a submenu
- ◀▶ Left and right arrows mean:
 - Select a highlighted menu item
 - Select an item in a submenu
 - Select numbers in certain menu options



The "press button" icon means you should press the button named on your remote control. (Button names appear in SMALL CAPITAL LETTERS.)



The "helping arrow" icon points to the highlighted or selected item in a menu.

To bring up the onscreen menu, press the MENU button on the remote control. The following (left) main menu will appear. The item that appears in orange is the one currently selected. If you use the MENU button on the TV's side panel instead of the remote, Front Menu screen showing "Video Status", "Aspect", "Auto Tuner Setup" and "Menu" will appear (following right screen).

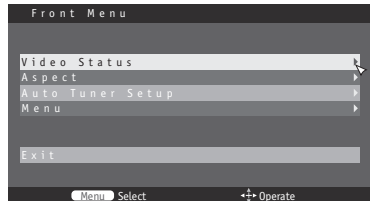
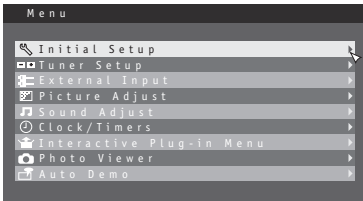

Note:

- Menus shown in this book are illustrations, not exact replications of the television's onscreen displays.

Onscreen Menus

The Onscreen Menu System

Your television comes with JVC's onscreen menu system. The onscreen menus let you make adjustments to your television's operation simply and quickly. All menus are navigated from the Main Menu at first. Detailed explanations on using each menu follow later in this guide. For information about the Interactive Plug-in Menu, see pages 22 - 24.

1. To open the onscreen menu system, press the MENU button on the remote control. The main menu will appear.

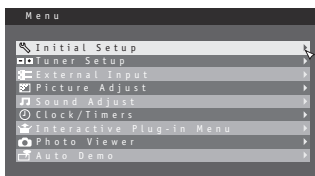

2. To select a menu from the main menu, use the ▲▼ arrows and enter by using the ◀▶ arrows or Ok button.

The selected feature and option on a menu screen are highlighted in a different color. To move to a different feature, use the ▲▼ arrows to move up and down the list.

3. There are two methods to select an option in a menu, after selecting a menu using the ▲▼ arrows.

- 1) Use the ◀▶ arrows to select an option from the highlighted feature. (In this guide, we discuss this method).
- 2) Press the Ok button. The right onscreen will appear. Use the ▲▼ arrows to select an option from the box and press the Ok button.

- To go back to the previous screen, press the BACK button.

4. Pressing MENU on the remote control will close the onscreen menu system and return you to normal television viewing.

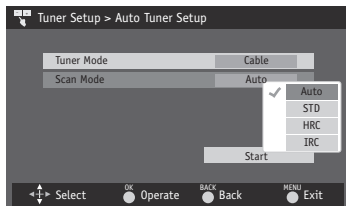

Each menu and its features will be discussed in the following pages of this guide.

Notes:

- If you do not press any buttons for a few seconds, the onscreen menu will automatically shut off.
- Button names in this guide are shown in SMALL CAPITAL LETTERS.
- Some menu items may not appear in menu screens when certain aspect ratios or inputs are selected.

Onscreen Menus

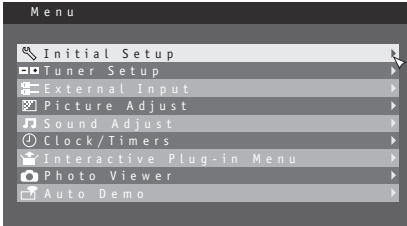

Press the MENU button

The left main menu will appear



To select a menu from the main menu

To enter

The following menu you selected will appear



Press the BACK button to return to the previous menu screen

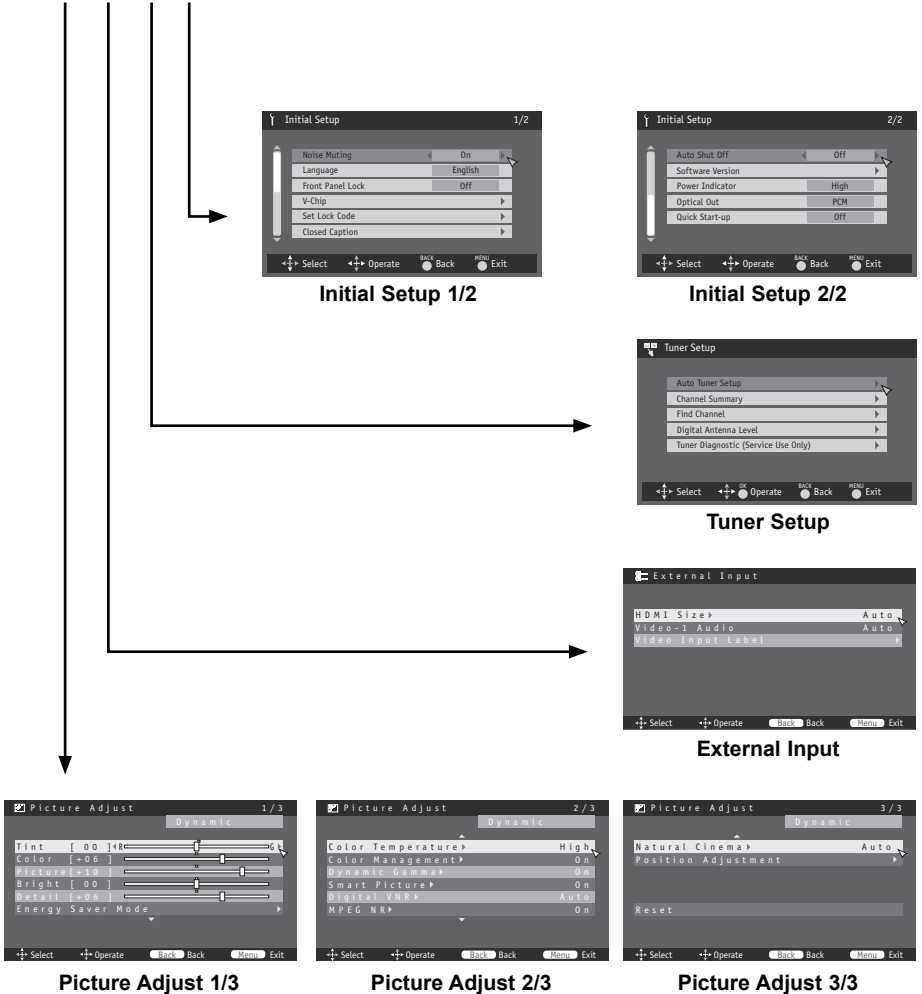

Note:

- The HDMI Size menu can only be displayed when a 480p picture signal is input to the HDMI terminal and the picture is being displayed on the screen.

Onscreen Menus

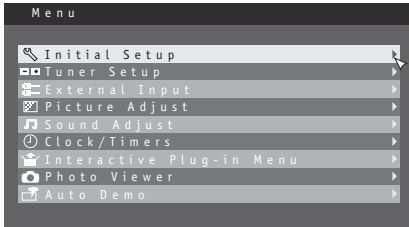

Press the MENU button

The left main menu will appear



To select a menu from the main menu



To enter

The following menu you selected will appear



Press the BACK button to return to the previous menu screen

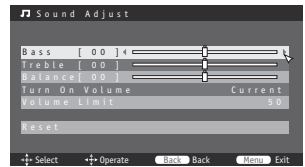
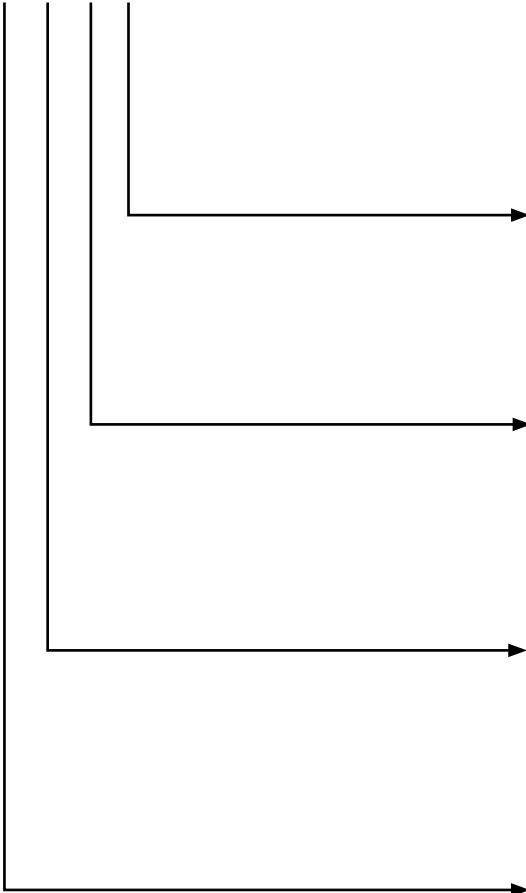

Sound Adjust

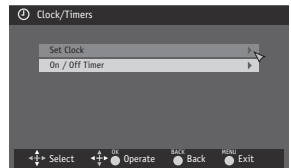

Clock/Timers

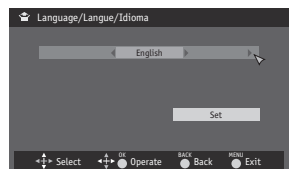

Interactive Plug-in Menu

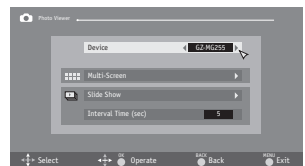

Photo Viewer

Note:

- For Auto Demo, see page 57.

Initial Setup

Noise Muting

This feature inserts a blank black screen over channels which are not broadcasting or are too weak to be received clearly.



Press the MENU button



To "Initial Setup"



To enter



To "Noise Muting"



To turn "On" or "Off"



Press the MENU button when finished

Note:

- Noise muting will not work when you operate channel summary.

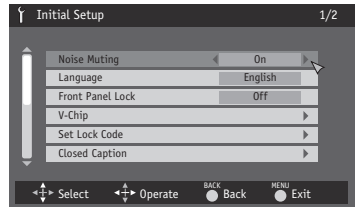

Language

The language function is described on page 22 as the interactive plug-in menu. If you need to choose the language again, follow the steps below.



Press the MENU button



To "Initial Setup"



To enter



To "Language"



To choose a language: English, Français or Español



Press the MENU button when finished

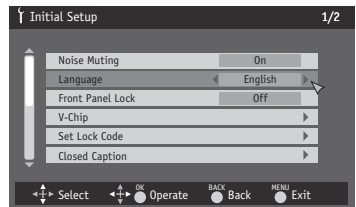

Front Panel Lock

This allows you to lock the keys on the side of the TV, so that a child may not accidentally change your viewing preferences.



Press the MENU button



To "Initial Setup"



To enter



To "Front Panel Lock"



To turn "On" or "Off"



Press the MENU button when finished

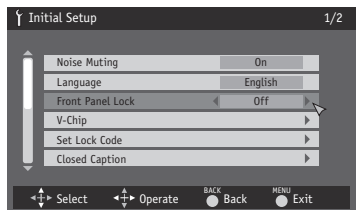

You can turn off this feature in the following ways:

- Unplug the power cord, and plug it back in. Do this if your batteries die, or you lose your remote control.
- Use the remote control.
- Press the MENU button on the side of the TV for more than 3 seconds. In this case, the OSD for "Front Panel Lock" will appear.

Note:

- To turn On/Off the TV, press the POWER button on the side of the TV for more than 3 seconds. This feature will remain On.

Initial Setup

V-Chip

Your TV is equipped with V-Chip technology which enables you to block channels or content that you feel to be inappropriate for children, based on US and Canada rating guidelines. V-Chip has no effect on video signals from a DVD discs, VCR tapes or Camcorder connection.

Note: Some programs, and movies are broadcast without a ratings signal. Even if you set up V-Chip ratings limits, these programs will not be blocked. See page 35 for information on how to block unrated programs.

Note (for Canadian viewers): The V-Chip function is based on specifications designed for the United States and therefore may not work properly in Canada.

You can customize the V-Chip settings of your television to match your personal tastes. The V-Chip menu below is the starting point for your V-Chip settings.

You can use US V-Chip settings (for programming broadcast from the United States), Canadian V-Chip settings (for programming broadcast from Canada), and movie ratings. You may use any or all of the settings (US V-Chip, Canada V-Chip, Movie ratings). Descriptions for setting each of the three V-Chip formats appear in the next six pages along with descriptions of the rating categories.

To access the rating categories:



Press the MENU button



To "Initial Setup"



To enter



To "V-Chip"



To operate (Password input screen will appear)



Enter the password by using the 10 keypad

The V-Chip main screen will appear when the password is correct.



To turn V-Chip "On" or "Off" (V-Chip must be turned "On" for rating settings to operate)



To move to V-Chip menu (see following pages for descriptions of each item)

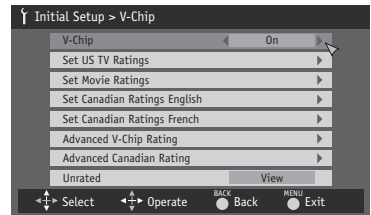

Notes:

- If you input the wrong password, go back to the Initial Setup Menu.
- To set the password, see "Set Lock Code", page 36.
- "Advanced V-Chip Rating" and "Advanced Canadian Rating" menus may be displayed sometimes between "Set Canadian Ratings French" and "Unrated". It depends on the broadcasting if they will be displayed or not.

US V-Chip Ratings

U.S. PARENTAL RATING SYSTEMS

Programs with the following ratings are appropriate for children.

TV Y is Appropriate for All Children

Programs are created for very young viewers and should be suitable for all ages, including children ages 2 - 6.

TV Y7 is for Older Children

Most parents would find such programs suitable for children 7 and above. These programs may contain some mild fantasy violence or comedic violence, which children should be able to discern from reality.

Programs with the following ratings are designed for the entire audience.

TV G stands for General Audience

Most parents would find these programs suitable for all age groups. They contain little or no violence, no strong language, and little or no sexual dialog or situations.

TV PG Parental Guidance Suggested

Programs may contain some, but not much, strong language, limited violence, and some suggestive sexual dialog or situations. It is recommended that parents watch these programs first, or with their children.

TV 14 Parents Strongly Cautioned

Programs contain some material that may be unsuitable for children under the age of 14 including possible intense violence, sexual situations, strong coarse language, or intensely suggestive dialog. Parents are cautioned against unattended viewing by children under 14.

TV MA Mature Audiences Only

These programs are specifically for adults and may be unsuitable for anyone under 17 years of age. TV MA programs may have extensive V, S, L, or D.

Viewing Guidelines

In addition to the ratings categories explained above, information on specific kinds of content are also supplied with the V-Chip rating. These types of content may also be blocked. The content types are:

- **V/FV** is for VIOLENCE/FANTASY VIOLENCE
- **S** stands for SEXUAL CONTENT
- **L** stands for strong LANGUAGE
- **D** stands for suggestive DIALOG

Initial Setup

Setting US V-Chip Ratings



Press the MENU button



To "Initial Setup"



To enter



To "V-Chip"



To operate (Password input screen will appear)



Enter the password by using the 10 keypad

The V-Chip main screen will appear



To turn V-Chip "On" or "Off"



To move to "Set US TV Ratings"



To enter

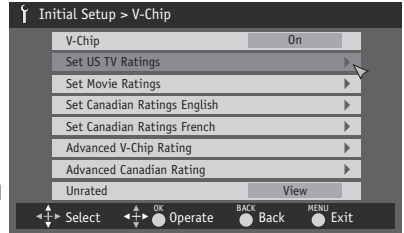

Directions to set US V-Chip Ratings

Line up the cursor in the column (TV PG, TV G, etc.) with the content row (V/FV, S, etc.) and press the ▲▼ or ◀▶ to move the cursor to the correct location. Press Ok to turn the locking feature on or off. An item is locked if the  icon appears instead of a "—".

For example. To block viewing of all TV 14 shows, move the cursor to the top row of that column and add a lock icon. Once you've put a lock on the top row, everything in that column is automatically locked.



To the TV 14 Column



Press the Ok button to lock



Press the MENU button when finished

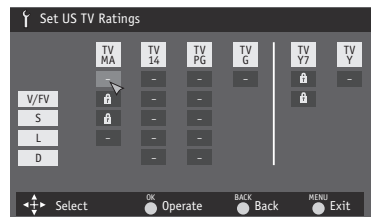

Movies Ratings

❑ NR – Not Rated

This is a film which has no rating. In many cases these films were imported from countries which do not use the MPAA ratings system. Other NR films may be from amateur producers who didn't intend to have their film widely released.

NR (Not Rated) Programming may contain all types of programming including children's programming, foreign programs, or adult material.

❑ G – General Audience

In the opinion of the review board, these films contain nothing in the way of sexual content, violence, or language that would be unsuitable for audiences of any age.

❑ PG – Parental Guidance

Parental Guidance means the movie may contain some contents such as mild violence, some brief nudity, and strong language. The contents are not deemed intense.

❑ PG-13 – Parents Strongly Cautioned

Parents with children under 13 are cautioned that the content of movies with this rating may include more explicit sexual, language, and violence content than movies rated PG.

❑ R – Restricted

These films contain material that is explicit in nature and is not recommended for unsupervised children under the age of 17.

❑ NC-17 – No One Under 17

These movies contain content which most parents would feel is too adult for their children to view. Content can consist of strong language, nudity, violence, and suggestive or explicit subject matter.

❑ X – No One under 18

Inappropriate material for anyone under 18.

Directions to set Movie (MPAA) Ratings



Press the MENU button



To "Initial Setup"



To enter



To "V-Chip"



To operate (Password input screen will appear)



Enter the password by using the 10 keypad

The V-Chip main screen will appear



To turn V-Chip "On" or "Off"



To "Set Movie Ratings"



To enter movies menu

For example:

To block viewing of X and NC-17 rated from shows:



To the X Column



Press the Ok button to lock



To the NC-17 Column



Press the Ok button to lock



Press the MENU button to finish

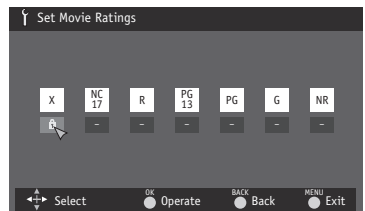

Initial Setup

Canadian V-Chip Ratings

❑ E – Exempt

Exempt programming includes: news, sports, documentaries and other information programming, talk shows, music videos, and variety programming.

❑ C – Programming Intended for Children

Violence Guidelines: There will be no realistic scenes of violence. Depictions of aggressive behavior will be infrequent and limited to portrayals that are clearly imaginary, comedic or unrealistic in nature.

❑ C8+ – Programming Intended for Children 8 and Over

Violence Guidelines: Any realistic depictions of violence will be infrequent, discreet, of low intensity and will show the consequences of the acts. There will be no offensive language, nudity or sexual content.

❑ G – General Audience

Programming will contain little violence and will be sensitive to themes which could affect younger children.

❑ PG – Parental Guidance

Programming intended for a general audience, but which may not be suitable for younger children. Parents may consider some content not appropriate for children aged 8-13.

❑ 14+ – 14 Years and Older

Parents are strongly cautioned to exercise discretion in permitting viewing by pre-teens and early teens. Programming may contain mature themes and scenes of intense violence.

❑ 18+ – Adult

Material intended for mature audiences only.

Directions to set Canadian V-Chip Ratings



Press the MENU button



To "Initial Setup"



To enter



To "V-Chip"



To operate (Password input screen will appear)



Enter the password by using the 10 keypad

The V-Chip main screen will appear



To turn V-Chip "On" or "Off"



To "Set Canadian Ratings English"



To enter ratings menu

For example:

To block viewing of programming rated 18+ and 14+:



To the 18+ Column



Press the Ok button to lock



To the 14+ Column



Press the Ok button to lock



Press the MENU button to finish

Note:

- For instructions on "Set Canadian Ratings French", please see page 34 in the French user's guide.

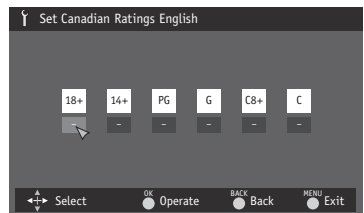

Unrated Programs

Unrated programming refers to any programming which does not contain a rating signal. Programming on television stations which do not broadcast rating signals will be placed in the "Unrated Programming" category.

Examples of Unrated programs:

- Emergency Bulletins
- News
- Public Service Announcements
- Sports
- Some Commercials
- Locally Originated Programming
- Political Programs
- Religious Programs
- Weather

Note:

- TV programs or movies that do not have rating signals will be blocked if the unrated category is set to "Block".

Directions to Block Unrated Programs

You can block programs that are not rated.



Press the MENU button



To "Initial Setup"



To enter



To "V-Chip"



To operate (Password input screen will appear)



Enter the password by using the 10 keypad

The V-Chip main screen will appear



To turn V-Chip "On" or "Off"



To "Unrated"



To select "View" or "Block"



Press MENU when done

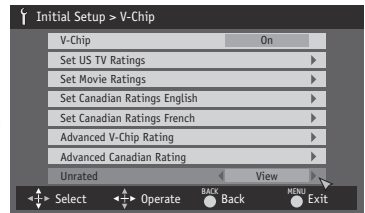

Initial Setup

Set Lock Code

Channel guard and V-Chip settings are protected by a four-digit lock code. Your TV comes pre-set with a lock code of "0000". You may change the code to any four-digit number you wish. To change the lock code, follow the steps below.



Press the MENU button



To "Initial Setup"



To enter



To "Set Lock Code"



To operate (Password input screen will appear)



Enter the password by using the 10 keypad

The Set Lock Code screen will appear



To set the password, use the 10 keypad



Press the Ok button to finish (your lock code is now set)

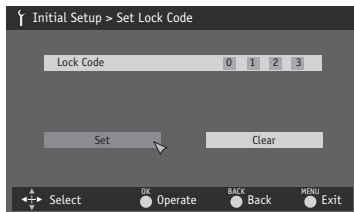

When a viewer attempts to watch a blocked channel, this message appears:

The channel will remain blocked until the correct lock code is entered (see above for information on setting your lock code).

This programming exceeds
your rating limits.
Please enter lock code
by 10 key pad to unlock it.

No. - - - -

Notes:

- After a power interruption you must reset the lock code.
- Write your lock code number down and keep it hidden from potential viewers.

Channel Guard Message

When a viewer attempts to watch a guarded channel, the following message appears:

To watch a channel that you have locked, enter the Lock Code using the 10 key pad. If the wrong code is entered, the message "Invalid Lock Code !" will appear on the screen.

The channel cannot be accessed until the correct code is entered.

This channel is locked
by channel guard.
Please enter lock code
by 10 key pad to unlock it.

No. - - - -

Notes:

- Once a channel has been unlocked, it will remain unlocked until the television is turned off.
- See also "Set Lock Code".

Closed Caption

Many broadcasts now include an onscreen display of dialog called closed captions. Some broadcasts may also include displays of additional information in text form. Your television can access and display this information using the closed caption feature. To activate the closed caption feature, follow the steps below.

Auto Setting



Press the MENU button



To "Initial Setup"



To enter



To "Closed Caption"



To enter



To "Type"



To select Auto, Advanced or Basic

Auto: Shows closed caption a priority for digital channels over analog channels. It is set automatically.

Advanced: Shows only the digital closed caption.

Basic: Shows only the analog closed caption.



To "Analog Service"



To select a caption (CC1 to CC4) or text channel (Text1 to Text4)



To "Digital Service"



To select 1, 2, 3, 4, 5 or 6



To "Appearance"



To enter



To select "Auto" ("Manual", see page 38)



Press the MENU button when finished

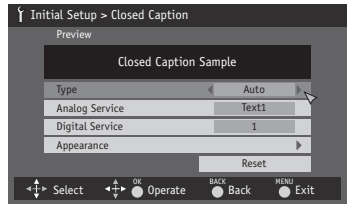

Notes:

- If you want to reset your settings to the default settings, select "Reset" and press the Ok button.
- If you select "Advanced" for Type, you cannot select "Analog Service".
- If you select "Basic" for Type, you cannot select "Digital Service" and "Appearance".
- "Type", "Digital Service" and "Appearance" are for digital broadcasting. It has no effect for analog broadcasting.

Initial Setup

Manual Setting

- ◀▶ To select "Manual" for Appearance Mode
- ▲▼ To "Font Size", "Font Style", "Text/Edge Opacity", "Background Opacity", "Text Color", "Edge Color" or "Background Color"
- ◀▶ To select the setting you like

Font Size: Auto, Standard, Large or Small

Font Style: Auto, SerifMono, Serif, SanSerifMono, SanSerif, Casual, Cursive or Small Capital

Text/Edge Opacity, Background Opacity: Auto, Transparent, Translucent, Solid or Flashing

Text Color, Edge Color, Background Color: Auto, White, Black, Red, Green, Blue, Yellow, Magenta, or Cyan



Press the MENU button when finished

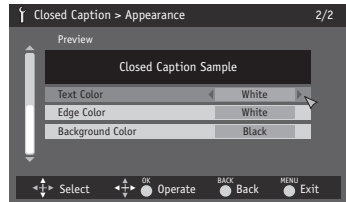
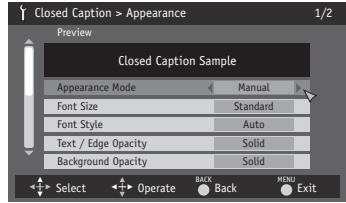

All fonts are licensed from Monotype Imaging Inc.

Notes:

- Closed caption subtitles are usually found on closed caption channel CC1. Some programs may include additional text information which is usually found on text channel Text1. The other channels are available for future use.
- Closed captioning may not work correctly if the signal being received is weak or if you are playing a video tape.
- Most broadcasts containing closed captioning will display a notice at the start of the program.
- To select the mode, press the C.C. button. See page 64.

Initial Setup

Auto Shut Off

This function automatically shuts off your TV when there is no signal from the channel and no operation if the TV is on for 10 minutes.



Press the MENU button



To "Initial Setup"



To enter



To "Auto Shut Off"



To turn "On" or "Off"



Press the MENU button when finished

- If the channel that you have on does not receive a signal for more than one minute, the blinking text "No Program or Weak Signal Auto shut off in 9 min." appears on the screen, and starts the countdown. If no signal is being received within 10 minutes, the TV shuts itself off.

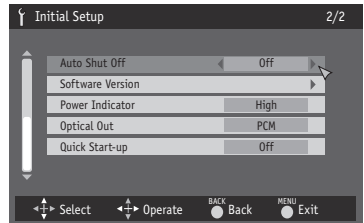

Software Version

You can confirm the Software Version.



Press the MENU button



To "Initial Setup"



To enter



To "Software Version"



To enter



Press the Ok button to close



Press the MENU button when finished

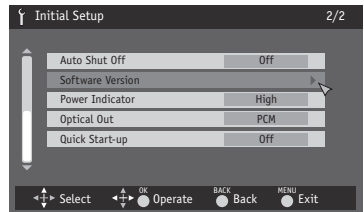

Power Indicator

Power indicator allows you to adjust the brightness of the power indicator.



Press the MENU button



To "Initial Setup"



To enter



To "Power Indicator"



To turn "High", "Low" or "Off"



Press the MENU button when finished

Notes :



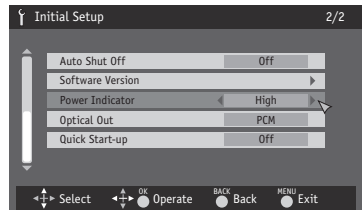



- When Off is selected :
The LED disappears if you have a TV signal.
The LED is lit as "Low" when there is no TV signal.
- When the On Timer turns On, the LED is lit as "Low" when you turn the power off.
- If you set a timer on the TV, the power indicator will light even if the TV is on stand by.



Initial Setup

Optical Out

You can select the optical digital sound output, either PCM or DOLBY DIGITAL when your TV is connected to an amplifier that has DOLBY DIGITAL decoder. If you select DOLBY DIGITAL, you can enjoy listening in 5.1ch sound when watching digital broadcasts. This only effects digital channels.

-  Press the MENU button
-  To "Initial Setup"
-  To enter
-  To "Optical Out"
-  To select "PCM" or "DOLBY DIGITAL"
-  Press the MENU button when finished

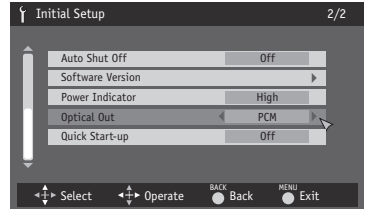

Notes:







- If your amplifier does not have DOLBY DIGITAL decoder, select PCM. If you don't select PCM, it cannot output the sound from the speakers.
- For connecting an amplifier using the optical output, see page 20.
- You cannot output sound from your Optical Output connection if the audio source is from your HDMI device.



Manufactured under license from Dolby Laboratories. "Dolby", and the double-D symbol are trademarks of Dolby Laboratories.

Quick Start-up

Quick Start-up allows you to lessen the time for the TV to turn on and ready for viewing.

-  Press the MENU button
-  To "Initial Setup"
-  To enter
-  To "Quick Start-up"
-  To turn "On" or "Off"
-  Press the MENU button when finished

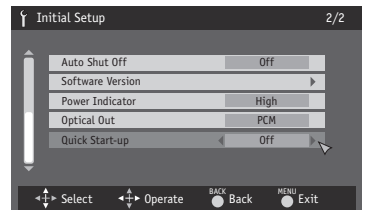

Note:

- Standby power consumption is higher when you have this feature turned on.

Tuner Setup

Auto Tuner Setup

The auto tuner setup function is described on page 24 as the interactive plug-in menu. If you need to run the auto tuner setup again, follow the steps below.



Press the MENU button



To "Tuner Setup"



To enter



To "Auto Tuner Setup"



To enter



To choose "Cable" or "Air"



To "Scan Mode"



To choose "Auto", "STD", "HRC" or "IRC"



To "Start"



Press the Ok button (Programming will take several minutes)

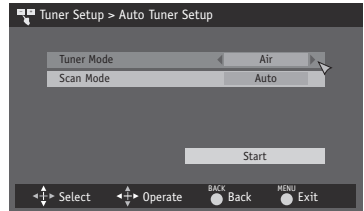

The auto tuner is finished when the message **"Programming Over !"** appears onscreen.

Notes:

- When the Tuner Mode is set to "Cable", it is possible to select "Scan Mode"
- If no channels were found using Auto Tuner Setup, check your antenna cable and the settings for Tuner Mode/Scan Mode.
- You can also access the "Front Menu" screen by using the MENU button on the side of the TV instead of the remote control. Choose "Auto Tuner Setup" by pressing MENU ▼ on the side panel and enter by using the CHANNEL +/- (◀▶) buttons.

Tuner Setup

Channel Summary

Channel summary allows you to customize the line-up of channels received by your TV. You can add or delete channels from the line-up or prevent any unauthorized viewers from watching any or all channels.



Press the MENU button



To "Tuner Setup"



To enter



To "Channel Summary"



To enter

A channel having the Scan mark "√" can be selected by using CH+/- (channel +/-) button. You can delete channels from the scan by removing the "√".



To the "Scan" column



Press the Ok button to include or delete from scan



Press the MENU button when finished

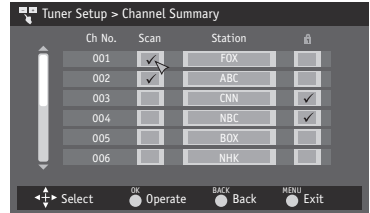

Note:

- The number of a digital channel may change, depending on the time of some broadcastings. If this channel existed and now has disappeared, the lock channel or scanned channel mark by the channel summary for that channel will be cancelled.

How to set the channel station.



Press the MENU button



To "Tuner Setup"



To enter



To "Channel Summary"



To enter



To "Station"



Press the Ok button to enter



To select the character you want



To move to the next space

...continue to follow these directions for all seven spaces



To "Set"



Press the Ok button

Your characters are now set





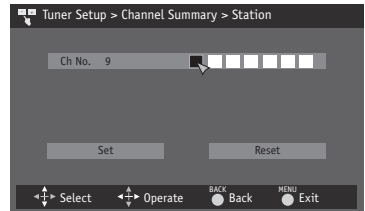







Press the MENU button when finished



Channel Summary (Continued)













If you want to reset the characters you set:

-  Press the MENU button
-  To "Tuner Setup"
-  To enter
-  To "Channel Summary"
-  To enter
-  To "Station"
-  Press the Ok button to enter
-  To select "Reset"
-  Press the Ok button to finish
- Your characters are now reset*
-  Press the MENU button when finished

Notes:

- You can use characters for: Alphabet, numbers, marks and spaces.
- It is possible to set the maximum of 500 channel labels.
- If you try to set more than the 500 maximum, the message "Memory Overflow" will appear.

You can block access to a channel by activating the channel lock.

-  Press the MENU button
-  To "Tuner Setup"
-  To enter
-  To "Channel Summary"
-  To enter
-   To the Lock Column ()
-  Press the Ok button (Password input screen will appear)
-  Enter the password by using the 10 keypad
-  Press the Ok button to lock or unlock that channel
-  Press the MENU button when finished

Tuner Setup

Find Channel

Add a digital channel that does not exist in the channel map.



Press the MENU button



To "Tuner Setup"



To enter



To "Find Channel"



To enter



Add a channel using 0 to 9



Press the Ok button to finish

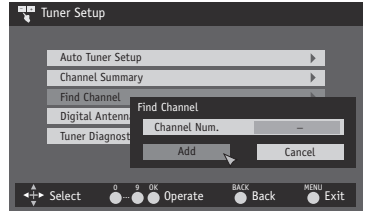

Digital Antenna Level

Confirms the present antenna level.



Press the MENU button



To "Tuner Setup"



To enter



To "Digital Antenna Level"



To enter

Note:

- If you are watching an analog channel, antenna level will not appear.

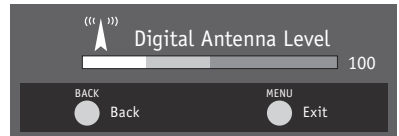

Tuner Diagnostic (Service Use Only)

Tuner Diagnostic menu is for service use only. It is used to diagnose your TV if there is a problem.



Press the MENU button



To "Tuner Setup"



To enter



To "Tuner Diagnostic (Service Use Only)"



To enter

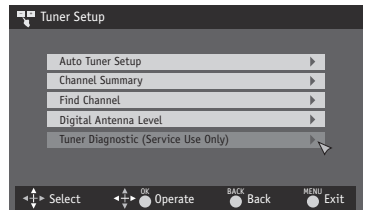

Note:

- If you are watching an analog channel, Tuner Diagnostic will not appear.

External Input

HDMI Size

The HDMI Size option can only be selected in the External Input menu when an HDMI 480p picture signal is being input to the HDMI terminal. This option adjusts the position when an HDMI or DVI 480p picture signal is being displayed on the screen. There are two types of HDMI 480p picture signals: 640x480 and 720x480. If the displayed picture is slightly shifted, the position can be adjusted by selecting Auto, Size1 or Size2.



Press the MENU button



To "External Input"



To enter



To "HDMI Size"



To enter



To select "Auto", "Size1" or "Size2"



Press the MENU button to finish

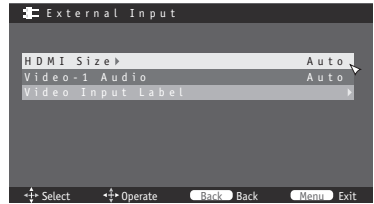

Notes:

- The HDMI Size menu can only be selected when an HDMI or DVI 480p picture signal is input to the HDMI terminal and the picture is being displayed on the screen.
- You can select "Auto" only when the signal is 480p for HDMI. When you select "Auto", the television will select "Size1" or "Size2" automatically.

Video-1 Audio

This feature is used if you have a DVI or HDMI compatible component connected to your TV.



Press the MENU button



To "External Input"



To enter



To "Video-1 Audio"



To select "Analog", "Digital" or "Auto"



Press the MENU button when finished



Notes:

- If your DVI or HDMI component is capable of digital audio and video, choose "Digital". If your DVI or HDMI component is capable of analog audio and digital video, choose "Analog".
- Refer to your DVI or HDMI component's instruction manual for more information.
- When you select "Auto", the television will select "Analog" or "Digital" automatically, depending on the audio input from the HDMI.

External Input

Video Input Label

This function is used to label video input connections for the onscreen displays.



Press the MENU button



To "External Input"



To enter



To "Video Input Label"



To enter



To select the desired video input



To select the desired preset input label (see chart below)



Press the MENU button when finished

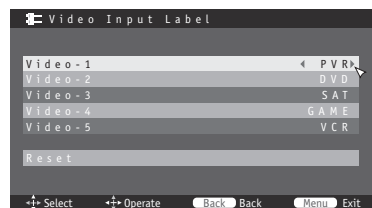

Preset Labels	Select when...
VCR	You have a VCR connected to the video input
DVD	You have a DVD connected to the video input
PVR	You have a Personal Video recorder connected to the video input
D-VHS	You have a Digital VCR connected to the video input
STB	You have a Set-top Box connected to the video input
SAT	You have a Satellite Receiver connected to the video input
AMP	You have an Amplifier connected to the video input
GAME	You have a Video Game connected to the video input
CAM	You have a Video Camera connected to the video input
DISC	You have a Video Disc player connected to the video input

Note:

- To reset to the default setting, ▲▼ to select "Reset", then press the OK button.

Picture Adjust

Picture Settings

These settings allow you to change and adjust the way the picture appears on your television.

Tint

Tint allows you to adjust the levels of red and green in your TV picture.

Color

The color function lets you make all the colors in the TV picture appear either more vivid or subtle.

Picture

Picture allows you to adjust the levels of black and white on the TV screen, giving you a darker or brighter picture overall.

Bright

You can adjust the overall brightness of the TV picture with the Bright control.

Detail

The Detail feature adjusts the level of fine detail displayed in the picture.

Energy Saver Mode

The energy saver mode adjusts the level of back light brightness on the TV screen.

Adjust the Picture Settings



Press the MENU button



To "Picture Adjust"



To enter



To "Tint", "Color", "Picture", "Bright", "Detail" or "Energy Saver Mode"



To enter



To adjust the setting



To move to the next setting



Press the MENU button when finished

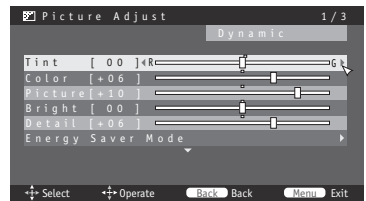

Color Temperature

You can decide how strong or dull the colors appear on the TV screen.



Press the MENU button



To "Picture Adjust"



To enter



To "Color Temperature"



To enter



To set "Low" or "High"



Press the MENU button when finished



Note:

- If you are receiving a 1080i or 720p digital channel in its original format, you can adjust the Picture Settings and Color Temperature independently from all the other channels.

Picture Adjust

Color Management

This TV supports the Color Management function to ensure dull colors are compensated to produce natural hues.



Press the MENU button



To "Picture Adjust"



To enter



To "Color Management"



To enter



To set "On" or "Off"



Press the MENU button when finished

Dynamic Gamma

JVC's Dynamic Gamma Circuitry (DGC) makes it easier to see dark areas when a picture has many dark areas, and makes it easier to see the bright areas when a picture has many bright areas. DGC is turned on, DGC analyzes and adjusts the total level of picture brightness balance, especially in dark areas where the level of grayscale is often lost, turning completely to black DGC automatically enhances the detail in these dark areas providing a more dynamic image with finer detail, so the optimum picture settings are automatically set for each picture. Normally use with DGC on.



Press the MENU button



To "Picture Adjust"



To enter



To "Dynamic Gamma"



To enter



To set "On" or "Off"



Press the MENU button when finished

Smart Picture

Smart Picture detects the APL (Average Picture Level) and adjusts the contrast suitable for what you are watching.



Press the MENU button



To "Picture Adjust"



To enter



To "Smart Picture"



To enter



To set "On" or "Off"



Press the MENU button when finished



Note:

- When you have "Dynamic" selected in the "Video Status", Smart Picture is not selected.

Picture Adjust

Digital VNR

This function can be selected to change the effect of Digital VNR.



Press the MENU button



- To "Picture Adjust"
- To enter
- To "Digital VNR"
- To enter
- To select the effect you like.

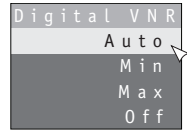

Auto: adjusts the effect of VNR automatically.

Min: adjusts the effect of VNR to minimum.

Max: adjusts the effect of VNR to maximum.

Off: turns the effect of VNR off.



Press the MENU button when finished

MPEG NR

This function blocks noise removal and mosquito NR simultaneously.



Press the MENU button



- To "Picture Adjust"
- To enter
- To "MPEG NR"
- To enter
- To select "On" or "Off"



Press the MENU button when finished

Natural Cinema

Natural cinema corrects the problem of blurred edges which may occur when viewing a program originally shot on film (such as motion pictures) or animation. If you notice blurring at the edges of these programs, choose "Natural Cinema" and set it to "Auto". Natural Cinema helps correct conversion errors that occur when film, which is shot at 24 frames-per-second, is broadcast at the television rate of 30 frames-per-second.



Press the MENU button



- To "Picture Adjust"
- To enter
- To "Natural Cinema"
- To enter
- To select the mode "Auto" or "Off"



Press the MENU button when finished

Note:

- Natural Cinema is only applied for SD 480i and HD 1080i signals.

Picture Adjust

Position Adjustment

Position adjustment allows you to adjust the position of the picture.



Press the MENU button



To "Picture Adjust"



To enter



To "Position Adjustment"



To enter



To adjust the position



Press the MENU button to finish

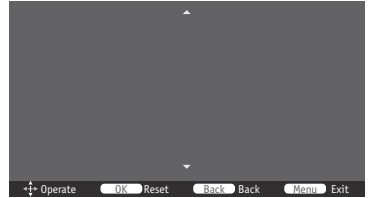

Notes:

- To reset the adjustment to the center, press the Ok button.
- When the arrow disappears, while you are adjusting the position, the position is at it's maximum limit.
- If you select Regular, Slim, Full or Full Native size with aspect, position adjustment option is not selectable.
- When you change the screen size, perform the position adjustment again.
- Position adjustment allows you to adjust the screen position horizontally when the aspect is set Panorama Zoom or Cinema Zoom for 1080i and 720p signals.
- When you are receiving a 1080p signal, Position Adjustment can not be selected.

Reset

Reset resets all picture adjustments at once to the default settings.



Press the MENU button



To "Picture Adjust"



To enter



To "Reset"



Press the Ok button

The onscreen menu disappears for a moment, and then the settings are reset to the default setting for all the picture adjustments except for Natural Cinema and Position Adjustment.



Press the MENU button when finished

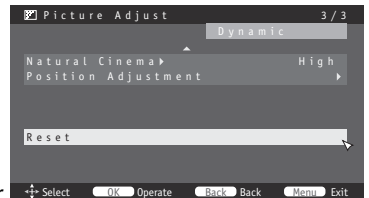

Sound Adjust

Sound Settings

These settings allow you to change and adjust the sound on your television.

Bass – You can increase or decrease the level of low-frequency sound in the TV's audio with the bass adjustment.

Treble – Use treble to adjust the level of high-frequency sound in your TV's audio.

Balance – Adjust the level of sound between the TV's left and right speakers with the balance setting.

Adjust the Sound Settings



Press the MENU button



To "Sound Adjust"



To enter



To "Bass", "Treble" or "Balance"



To adjust the setting



To move to the next setting



Press the MENU button when finished

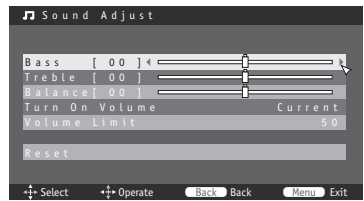

Note:

- You can reset all sound adjustments you set at once as the default setting when you select reset. See page 52.

Turn On Volume

Turn On Volume allows you to set the volume level when you turn the TV on.



Press the MENU button



To "Sound Adjust"



To enter



To "Turn On Volume"



To set the volume level

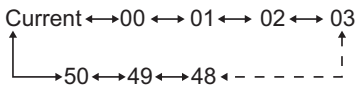

Press the MENU button to finish

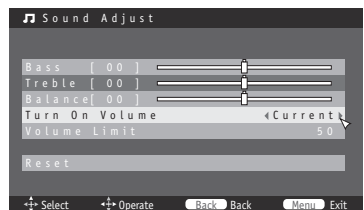

Sound Adjust

Volume Limit

Volume Limit allows you to set the maximum volume level.



Press the MENU button



To "Sound Adjust"



To enter



To "Volume Limit"



To set the maximum volume level

00 ↔ 01 ↔ 02 ← - - - - - → 48 ↔ 49 ↔ 50



Press the MENU button to finish

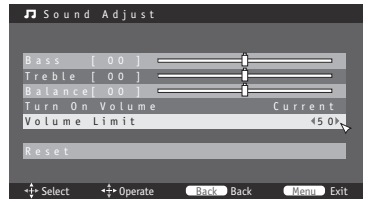

Reset

Reset resets all sound adjustments at once to the default settings.



Press the MENU button



To "Sound Adjust"



To enter



To "Reset"



Press the OK button

The onscreen menu disappears for a moment, and then the settings are reset to the default setting for all the sound adjustments.



Press the MENU button when finished

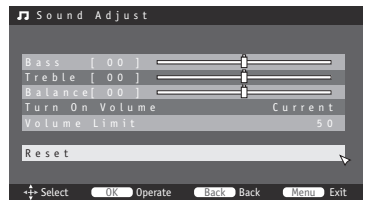

Set Clock

The set clock function is described on page 23 as the Interactive Plug-in Menu. You can choose to set the clock automatically, or manually. If you need to set the clock again, follow the steps below.



Press the MENU button



To "Clock/Timers"



To enter



To "Set Clock"



To enter

When you set the clock automatically, choose "Auto (Digital)" or "Auto (Analog)" by pressing the ◀ or ▶ arrows.



To "Channel" when you selected "Auto (Digital)"



To select a receiving digital channel



To "Time Zone"



To select your time zone



To "D.S.T." (daylight savings time)



To turn D.S.T. "On" or "Off"



To "Start Clock"



Press the Ok button



Press the MENU button when finished

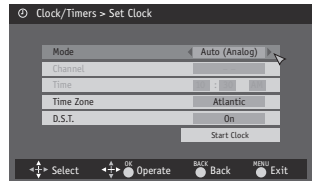

When you set the clock manually, choose "Manual" by pressing the ◀ or ▶ arrows.



To move to the hour



To set the hour



To move to minutes



To set the minutes



To "Time Zone"



To select your time zone:



To "D.S.T." (daylight savings time)



To turn D.S.T. "On" or "Off"



To "Start Clock"



Press the Ok button



"Thank you !" will be displayed.



Press the MENU button when finished



Notes:

- "Channel" can be selected only when Mode is "Auto (Digital)".
- D.S.T. can be used only for US and Canada when it is set to "On" in the "Set Clock" menu.
- Only when the Mode is set to Auto, the Daylight Saving Time feature automatically adjusts your TV's clock for Daylight Saving.
- The real time and D.S.T. may not be set correctly depending on the broadcasting signal and receiving conditions. In this case, set your clock manually.
- You will have to reset the clock after a power interruption. You must set the clock before operating any timer functions.

Clock/Timers

On/Off Timer

The on/off timer lets you program your television to turn itself on or off. You can use it as an alarm to wake up, to help you remember important programs, or as a decoy when you're not home.



Press the MENU button



To "Clock/Timers"



To enter



To "On/Off Timer"



To enter (begins with "Mode")



To choose "Once", "Everyday" or "No"



To "On Time"



To set the hour (AM/PM) you want the TV to turn on



To move to minutes



To set the minutes



To accept "On Time" and move to "Off Time" (the time the TV will turn off). Set the "Off Time" the same way as "On Time"



To accept "Off Time" and move to "Channel"



To select channel



To "On Volume"



To set the volume level



To "Set"



Press the Ok button



Press the MENU button to exit the menu

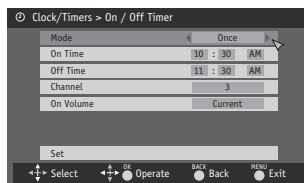

Notes:

- The on/off time cannot be set to locked channels in the channel summary menu.
- In order for the on/off timer to work, the clock must be set.
- After a power interruption, the timer settings must be reset.
- If your clock is not set, "Please set clock first !" will appear on the screen. Please see Manual Set Clock on page 53 to set the clock.

Photo Viewer

Photo Viewer allows you to enjoy your digital pictures stored on your USB Mass Storage Class devices. You are able to view them on this TV as high quality images.

How to start the Photo Viewer

- 1) Turn the power off on the device containing your photos.
- 2) Switch to "PHOTO" mode if your device has a mode switch (VIDEO/PHOTO).
- 3) Turn on your device containing your photos and switch to play mode to view the photos.
- 4) Connect your device to the Photo Viewer Terminal on this TV by using a USB cable.

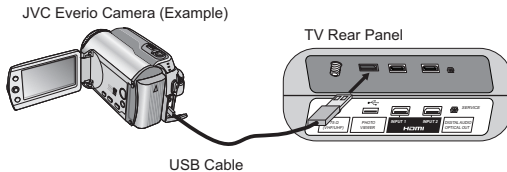

- 5) The TV screen will display a "hourglass" icon and then display the Photo Viewer Screen.
For "Multi Screen" and "Slide Show", see page 56 and 57.

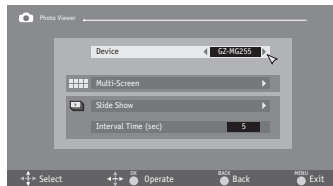

- 6) Select a camcorder's device from "Device" by using the ◀▶ buttons.

How to finish the Photo Viewer



Press the MENU button when finished



Press the POWER button on remote control to turn the power off
Disconnect the USB cable

Notes:

- Use the supplied USB cable that came with your device. Do not use HUB or USB extension cable.
- Photo Viewer cannot be guaranteed to work with all USB Mass Storage Devices. In this case, the message, "There is no photo to be displayed" will appear when you start the "How to start the Photo Viewer". It may take some time to display or it may not display correctly.
- When your device that you are connecting to the TV is composed of two or more Mass Storage devices, you can select from two Mass Storage devices. Selected Mass Storage device depends on the model.
- Please refer to the Customer Support website at www.jvc.com/support for information and notes regarding your devices you wish to connect.
- Compatible file format is "Exif version 2.1, based on DCF version 1.0".
- Supported file formats are ".jpg" or ".JPG".
- Maximum number of files that can be displayed is 9999.
- Photos with less than 120 x 120 pixels and more than 16383 x 16383 pixels cannot be displayed.
- All your stored data should be backed up first as a precaution before connecting to the TV.
- Depending on your stored file size, it can take extra time to display "Photo Viewer" page.
- It may take extra time to display the photo full screen, depending on the file size.
- "Device" can only be selected when you have two or more devices connected to the TV.

Photo Viewer

Multi Screen

Multi Screen allows you to display JPEG images that are in your digital still camera or external USB Mass Storage Class memory as "thumbnails".

- ▲▼ To "Multi Screen"
- ◀▶ To enter

The thumbnail appears

- ◀▶▲▼ To select an image



Press Ok if you want to display a single image



Press the DISPLAY Button

The following image appears. You can look at the pictures by using your remote control buttons.

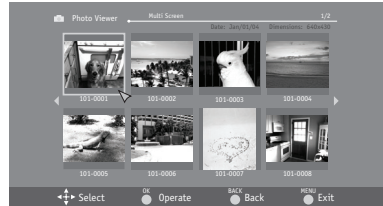

- ▲ button: Zooms in the image

When the image is zoomed in, you can move the image in all directions using the 10-key pad on your remote. To reset the position, press the 5 button.

- ▼ button: Zooms out the image
- ◀ button: To previous image
- ▶ button: To next image

VOL+: Rotates the image 90° clockwise

VOL-: Rotates the image 90° counterclockwise

DISPLAY: Displays information. With each press of the DISPLAY button, you can display the picture's information.

BACK: Returns to the thumbnail screen

MENU: Exit

Notes:

- When Multi Screen has more than one screen, if you press the page number using the 10-key pad on your remote, you will skip to that specific page.
- Although the image has been rotated, this change is not saved to the USB memory.

Photo Viewer

Slide Show

Slide Show allows you to display the images in order.



To "Slide Show"



To enter

The Slide Show starts



Press the BACK button to stop the Slide Show

Notes:

- To pause the Slide Show, press the OK button. To unpause, press the OK button again.
- When you set the Interval Time (seconds), the image will change automatically to the next image. By default, it is 5 seconds.
- Slide Show may take extra time more than setting the Interval Time, depending on the file size.
- If the USB cable is disconnected or your USB device is turned off while the Photo Viewer is working, your device may not be recognized. In this case, turn Quick Start-up Off, turn the TV off and turn the TV back on.

Interval Time

You can set the time to change to the next image for the Slide Show. When you set the time using the ◀▶ button, the image change to the next image automatically. When you have set it to "Manual", you can change the image to the next image by using the ◀▶ buttons.

Note:

- It may take some extra time to move to the next image depending on the size of your JPEG images.

Auto Demo

Auto Demo

Auto Demo explains this TV's features to you. This Auto Demo mode is set to be On by default until you turn it Off.

Notes:

- Please complete the Interactive Plug-in Menu first. The Auto Demo mode will start automatically when the Interactive Plug-in Menu is completed.
- If you press any button on the television or remote, with the exception of POWER or MENU, the Auto Demo mode will stop for 30 seconds. After 30 seconds have passed with no operation, the Auto Demo mode will start again.

Button Functions

Power

Turns the TV on or off.



Press the POWER button

Number Buttons - 10Key Pad

Use the number buttons on the remote control to move directly to a specific channel. For example, to move to channel 12:



1 (ONE)



2 (TWO)

Tune

Lets you decide the input channel and select it. After you press the number buttons on the remote, press the TUNE button. For example, to move to channel 12:



1 (ONE)



2 (TWO)



Press the TUNE button

Sub Channel

The main channel sometimes has minor channels (Sub Channels). By using the SUB CH button, you can select a sub channel easily.

To watch sub channels



Press the MODE button to select TV

For example, to move to sub channel 123-45:



Press 1, 2 and 3 in order



Press the SUB CH button



Press 4 and 5 in order



Press the TUNE button

Button Functions

Input

Selects the signal input source for the television: VIDEO-1, 2, 3, 4 or 5 for video devices like VCRs, DVD players, or camcorders.



Press the V1, V2, V3, V4 or V5 button

Notes:

- When you return to TV mode, press the RETURN+/TV button or direct 10 key pad or CHANNEL +/- button.
- You can also access by pressing the INPUT button on the side of the TV instead of the remote.

Channel +/-

Use these buttons to move up or down all the available channels your TV is able to receive. To move rapidly through the channels using JVC's **Hyperscan** feature, press and hold CH+ or CH-.

Volume +/-

Use these buttons to raise or lower the TV's volume level. The maximum is the level you set in Volume Limit. See page 52.

Return +/TV

The Return+/TV button has three functions:

Return - Returns to the channel viewed just before the channel currently onscreen.

Return+ - Lets you program a specific channel to return to while scanning through the channels using the CH+ and CH- buttons.

TV - Returns to the TV mode.



Press the RETURN+/TV and hold for three seconds

Return Channel (123-456)
Programmed !

The channel currently active has been programmed as your return+ channel. Now scan through the channels using the CHANNEL+/- buttons.



Press the RETURN+/TV

You will return to your programmed channel.

- To cancel your return+ channel, press and hold the RETURN+/TV button for three seconds. The message "Return Channel Cancelled !" will appear.

Button Functions

Sound

By pressing the SOUND button, you can change the A.H.S. (Advanced Hyper Surround) and Smart Sound on or off.

A.H.S. - Adds a more spacious surround sound. Music gives basic effect and movie for more effect.

Smart Sound - Decreases high sound levels, giving a regulated sound level.



Press the SOUND button



To select "A.H.S." or "Smart Sound"



To choose the setting



Press the MENU when finished

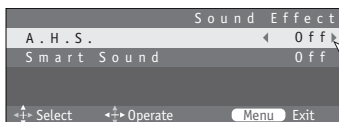

Note:

- Smart Sound may become an unnatural effect, depending on the signal source.

Muting

The MUTING button instantly turns the volume down completely when you press it. Press MUTING and the volume level will instantly go to zero. To restore the volume to its previous level, press MUTING again.

Video Status

The Video Status button gives you a choice of four TV picture display settings, including a display of your own preferences.

Standard - Resets the picture display to the factory settings.

Dynamic - Gives a vivid picture with better contrast when viewing in a brightly lit room.

Theater - Gives a rich, film-like look to video when viewing in a dimly lit room.

Game - Used for when you are playing video games connected to your TV.



Press the VIDEO STATUS button

By every press of the VIDEO STATUS button, you change the mode.

Notes:

- You can also change the mode by pressing the ▲▼ buttons.
- Each mode is memorized for each input connected to the TV.
- You can also access the "Front Menu" screen by using the MENU button on the side of the TV instead of the remote control. Choose "Video Status" by pressing MENU ▼ on the side panel and enter by using the CHANNEL +/- (◀▶) buttons. Next, select a mode by pressing the MENU ▼ button.

Button Functions

Sleep Timer

The Sleep Timer can turn the TV off for you after you fall asleep. Program it to work for a total time of up to 180 minutes. When you press the SLEEP button once, the rest of the time will be displayed.



Press the MODE button to select TV



Press the SLEEP button twice

By every press of the SLEEP button, you select the time for the timer to shut off

This message will appear 60 seconds before the automatic shutoff occurs:

Good Night !
Push [SLEEP TIMER] button
to extend.

Sleep Timer
0 min.
15 min.
30 min.
45 min.
60 min.
90 min.
120 min.
180 min.

You then have 60 seconds to press the SLEEP button to delay the shut off.

Note:

- You can also select the timer by pressing the ▲▼ buttons.

Display

The display screen shows the current information as follows.



Press the MODE button to select TV





Press the DISPLAY button



- **Detailed Mode** - Shows the channel, channel name, signal, rating information, current time, digital antenna level and scramble information, as well as the current time below.



- **Clock Mode** - Shows the current time. 
- **Simple Mode** - Shows the current channel and channel name or AV input. 
- **Off** - Turns the display off.

Notes:

- You may also turn off the display at any step by pressing MENU.
- If the clock is not set, "Clock not set" will be displayed.
- A signal being shown in Detailed Mode, will only show the kind of input and video signal you are receiving. However, the actual signal type you see will be different.

Button Functions

Aspect

This feature will help you adjust the picture you are watching to give you the best possible picture quality.

Aspect Ratios

Panorama - With this ratio a normal 4:3 aspect picture is stretched to fit the dimensions of the 16:9 aspect screen.

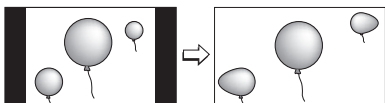

Cinema - This ratio "zooms in" on the center part of a 4:3 aspect picture, blowing it up to fill the 16:9 screen.



Full - This is the ratio to use when watching 16:9 High-Definition broadcasts.

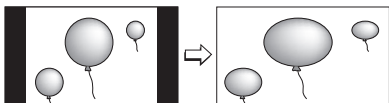

Panorama Zoom - This ratio stretches the High-Definition 16:9 aspect image to eliminate the black side bars.

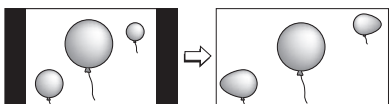

Cinema Zoom - This ratio stretches the High-Definition 16:9 aspect image to eliminate the black surrounding bars.



Regular - The regular ratio is used when you want to watch a 4:3 broadcast or recorded program without modifying the original picture to fit the dimensions of your 16:9 screen. The 4:3 picture will fill the screen from top to bottom, while black bars will appear to fill up the remaining space along the picture's sides. The 4:3 picture will be centered within the boundaries of the 16:9 screen.

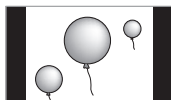

Slim - This aspect mode shrinks the screen of 16:9 to 4:3. There are some programming that is already stretched by mistake at broadcasting companies, so this mode corrects it. Black side bars will appear.

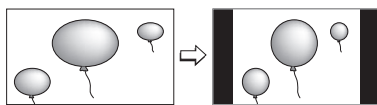

Full Native - This ratio displays 100% of the ratio. Normally, all aspects except for Full Native display about 95%.

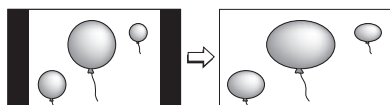

Button Functions

Aspect Ratios (Continued)



Press the ASPECT button

- By pressing the ASPECT button, you can change the size.

When you change the aspect ratios, it is different from their broadcast or recorded program.

ATSC (480i, 480p)
NTSC (480i, 480p)
SD (480i, 480p)

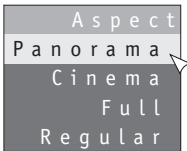

ATSC (720p)
HD (720p)

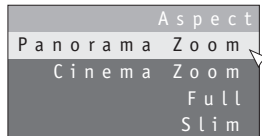

ATSC (1080i)
HD (1080i)

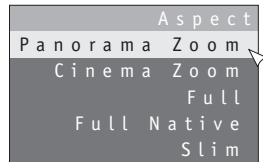

Notes:

- You can also choose the size by pressing the ▲▼ buttons.
- When you change the aspect ratio or signal, reset the picture position to center.
- You can also access the "Front Menu" screen by using the MENU button on the side of the TV instead of the remote control. Choose "Aspect" by pressing MENU ▼ on the side panel and enter by using the CHANNEL +/- (◀▶) buttons. Next, select an aspect ratio by pressing the MENU ▼ button.
- If the television receives a 16:9 signal from your HDMI device, the aspect mode will turn to "Full" automatically. If the television receives a 4:3 signal from your HDMI device when you are in "Full" aspect mode, it will return to "Regular" aspect mode. If you change the aspect mode after the television changed it to "Full" automatically, the television will change to the aspect mode you chose. It also turns to "Full" automatically when the TV receives an HD (1080i or 720p) signal.
- When you are receiving a 1080p signal in "Full Native" mode, you are unable to change the aspect mode.

Menu

The Menu button allows you to access JVC's onscreen menu system. Press MENU to activate the onscreen menu system. When a menu is displayed, press the MENU button to exit the menu system.

- See individual topics like "Sound Adjust" for specific information on using menus.

OK

This button confirms your selection when you are in one of the onscreen menus.

Back

This button allows you to go back in the menu to change a selection or correct a mistake.

Button Functions

ML/MTS

ML/MTS technology allows several audio signals to be broadcast in analog at once, giving you a choice in what you wish to hear with a TV program. In addition to mono or stereo sound, an MTS broadcast may also include a second audio program (SAP). When you are receiving a digital broadcast, it is possible to choose a language that you wish to receive.

When receiving analog broadcast



Press the **MODE** button to select TV



Press the **ML/MTS** button

By every press of the ML/MTs button, you change the mode

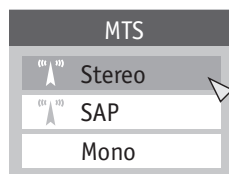

Notes:

- Keep the TV in stereo mode to get the best sound quality. The sound will work in stereo mode even if a certain broadcast is in mono sound only.
- Choose the mono setting to reduce excessive noise on a certain channel or broadcast.
- Selecting SAP will allow you to hear an alternative soundtrack, if one is available.
- MTS unavailable if your television's Input source is in Video-1, 2, 3, 4 or 5 mode, as described on page 59.
- You can also change the mode by pressing the **▲▼** buttons.

When receiving digital broadcast



Press the **MODE** button to select TV



Press the **ML/MTS** button

By every press of the ML/MTs button, you change the language



- ML/MTS will not work when you are using the HDMI.

C.C. (Closed Caption)

Use the C.C. (Closed Caption) button to select the mode of closed caption.



Press the **MODE** button to select TV



Press the **C.C.** button

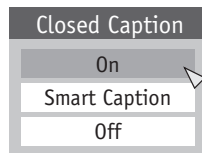

Notes:

- Smart Caption will appear when you press the Muting button only on channels where the broadcast contains closed captioning.
- When you select "On", it will be the mode selected in the Closed Caption Menu.
- See page 37 when you set the caption/text mode.
- You can also change the mode by pressing the **▲▼** buttons.

Button Functions

Favorite

The Favorite button allows you to select your favorite channels easily. First, you must register the channels that you like. See how to register below.



Press the FAVORITE button
The favorite channel list will appear.



To select the channel you want to watch



Press the Ok button
It will change to the channel you have selected.

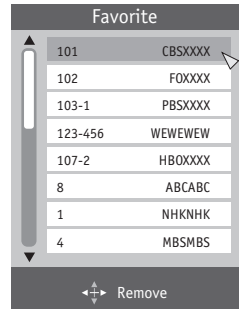

Register the favorite channel



Press the channel number you want to register
The channel program will change.



Press the FAVORITE button for three seconds
The channel will be registered in the favorite channel list.

Notes:

- The maximum number of channels you can register is 24.
- If you have registered the maximum number of channels, and try to register more channels, the oldest channel you registered will be deleted.

Delete the favorite channel



Press the FAVORITE button
The favorite channel list will appear.



To select the channel you want to delete
To enter
The screen to the right will appear.



To "Yes"



Press the Ok button
The channel was deleted.



Press the FAVORITE button when finished

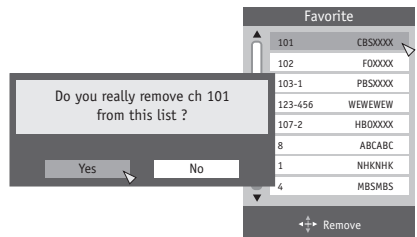

Guide

You can view the program information from the GUIDE.

Notes:

- The GUIDE function will work when you are receiving digital program only.
- The GUIDE will not show the correct time and date if you have not performed the set clock function on your television. See page 53.
- When the program information is not being broadcasted, it will not show the correct information.

Button Functions

Mode

Your remote control can be used to operate some basic functions of your external devices. To use your device, select the proper mode.

MODE	Device
TV	TV
STB	STB/DVR (Cable Satellite)
VCR	VCR/DVR
DVD	DVD Player (DVD Recorder)
AUDIO	Amplifier/Home Theater in Box



Press the **MODE** button

By every press of the Mode button, you can select the mode.



- The mode LED indicator on the remote control lights for 3 seconds each time the remote control is operated.

External device control buttons

You can use this remote control to operate the basic functions of your external devices. See page 67 on how to program the remote control to operate your other devices.

Note:

- The remote is preset to control JVC-brand devices.

Remote Programming

Remote programming

You can program your remote control to operate your external devices, using the instructions and codes on pages 68 - 72. The following external devices can be operated using your remote control.

Device	Mode	Applied for these functions	Page
Cable Set Top Box Cable/PVR Combination Satellite Set Top Box DBS/PVR Combination	STB	Power on/off, Channel up/down, Volume up/down, Number 0 - 9, Tune, Return+/TV, Muting, Favorite Channel, Menu on/off, Arrow buttons, OK/Enter, Back, DVR (JVC Only)*, Guide (EPG), Sub Channel, Closed Caption, Display (Recall), Rewind (◀), Playback (▶), Forward (➡), Record (●), Stop (■), Pause (⏸).	68
VCR, DBS/PVR Combination PVR, DVD/PVR Combination	VCR	Power on/off, Channel up/down, Menu on/off, Arrow buttons, OK/Enter, Back, Guide (EPG), TV/VCR, Closed Caption, Eject (▲), Rewind (◀), Playback (▶), Forward (➡), Record (●), Stop (■), Pause (⏸).	69, 70
DVD Player, DVD Recorder Home Theater in Box	DVD	Power on/off, Channel up/down, Menu on/off, Arrow buttons, OK/Enter, Back, Guide (EPG), TV/DVD (TV/VCR button), Sub Title (Sub T.), Open/Close (▲), Rewind (◀), Playback (▶), Forward (➡), Record (●), Stop (■), Still (⏹).	71
Amplifier, Home Theater in Box, Receiver	AUDIO	Power on/off, Audio Input Selection (V1 button), Volume up/down, Muting, DVD operation buttons: Menu on/off, Arrow buttons, OK/Enter, Back, Sub Title (Sub T.), Open/Close (▲), Rewind (◀), Playback (▶), Forward (➡), Stop (■), Still (⏹).	72

* DVR button only applies to JVC DVR (Dish Satellite STB).

Notes:

- To record to your VCR or DVD, hold the record (●) button on the remote control and press play (▶).
- If the code you programmed doesn't work, try the next one. If no codes work, refer to "Search Code Function" on page 67. If your remote does not work after using the "Search Code Function", use the remote that came with your device. Your TV remote can not be guaranteed to work with all models, brands or operations.
- When the television remote control does not operate, for a model that allows you to switch the remote control code on the device side, you can try switching the setting to default or something else on the device side.

How to set the codes

- 1) Find your device and device's brand from the code list. See page 68 - 72.
- 2) Select the mode of your device by pressing the MODE button. Then confirm the mode LED on the remote control.
- 3) Press and hold the TUNE button, then enter the first four digit code number listed using the number buttons. When the code is set, the mode LED goes out for a second, then it lights.
- 4) After confirming the proper mode LED, release the TUNE button, and confirm the operation of your device.
- 5) If your device does not respond, try and enter the next code.

Search Code Function

- 1) Select a mode of your device by pressing the MODE button.
- 2) Press the POWER and RETURN+/TV buttons. Hold for at least 3 seconds and release. Then confirm the mode LED blinks.
- 3) Press any button* on the remote, and see if the selected device responds. *Use the applied buttons except for ◀ ▶ cursors, Return+/TV and Rec (●) on the above chart.
- 4) If there was a response, press RETURN+/TV. The codes are now set. Then confirm the mode LED goes out.
- 5) If there was no response, try to select the previous code or the next code by using ◀ or ▶ . If you repeat a total of 65 times for the STB (90 times for the VCR, 120 times for the DVD and 132 times for the AUDIO) without a response, use the remote control that came with your equipment. Press RETURN+/TV to exit. Then confirm the mode LED goes out.

Remote Programming

Programming Codes

STB mode			
Cable Set Top Box	Satellite Set Top Box	Satellite Set Top Box	
ABC 0003, 0008	AlphaStar 0772	Samsung 1377, 1276, 1108, 1109, 1442, 1609	
Americast 0899	Chaparral 0216	SKY 0856	
Bell South 0899	Coolsat 1806	Sony 0639, 1639, 1640	
Digeo 1187	Crossdigital 1109	Star Choice 0869	
Director 0476	DirecTV 1377, 0392, 0566, 0639, 1639, 1142, 0247, 0749, 1749, 0724, 0819, 1856, 1076, 1108, 0099, 1109, 1414, 1442, 1609, 1392, 1640	Tivo 1142, 1442	
General Instrument 0476, 0810, 0276, 0003		Toshiba 0749, 1749, 0790, 1285	
GoldStar 0144		UltimateTV 1392, 1640	
Hamlin 0009, 0273		Ultrasat 1806	
Jerrold 0476, 0810, 0276, 0003		Uniden 0724, 0722	
Memorex 0000	Dish Network System 1505, 1005, 0775, 1170, 1775	US Digital 1535	
Motorola 1376, 0476, 0810, 0276, 1187	Dishpro 1505, 1005, 0775, 1775	USDTV 1535	
Pace 1877, 0237, 0008		Voom 0869	
Panasonic 0000, 0008, 0107	Echostar 1505, 1005, 0775, 1170, 1775	Zenith 0856, 1856	
Paragon 0000	Expressvu 0775, 1775	DBS/PVR Combination	
Philips 1305, 0317, 0025	GE 0566	DirecTV 1377, 0392, 0639, 1142, 1076, 0099, 1392, 1442, 1640	
Pioneer 1877, 0877, 0144, 0533	General Instrument 0869		
Pulsar 0000	GOI 0775, 1775	Dish Network System 1505, 0775	
Quasar 0000	Hisense 1535	Dishpro 1505, 0775	
Regal 0279, 0273	Hitachi 0819	Echostar 1505, 0775, 1170	
Runco 0000	HTS 0775, 1775	Expressvu 0775	
Samsung 0000, 0144	Hughes Network Systems 1142, 0749, 1749, 1442	Hughes Network Systems 1142, 1442	
Scientific Atlanta 1877, 0877, 0477, 0008		Humax 1790	JVC 1170
Sony 1006	iLo 1535	Motorola 0869	
Starcom 0003	JVC 0775, 1170, 1775	Philips 1142, 0099, 1442	
Supercable 0276	LG 1414	Proscan 0392	
Torx 0003	Magnavox 0724, 0722	RCA 1392	
Toshiba 0000	Memorex 0724	Samsung 1442	
Zenith 0000, 0525, 0899	Mitsubishi 0749	Sony 0639, 1640	
Cable/PVR Combination	Motorola 0869	Star Choice 0869	
	Next Level 0869		
	Panasonic 0247, 0701		
	Pansat 1807		
	Paysat 0724		
	Philips 1142, 0749, 1749, 0724, 1076, 0722, 0099, 1442		
	Proscan 0392, 0566		
	Proton 1535		
	RadioShack 0869		
	RCA 0566, 0855, 0143, 1392		

Remote Programming

VCR mode

VCR		VCR		VCR	
ABS	1972	Fisher	0047, 0104, 0046	Marta	0037
Admiral	0048, 0209	Fuji	0035, 0033	Matsushita	0035, 0162, 0227, 1162
Adventura	0000	Funai	0000, 0593, 1593		
Aiko	0278	Garrard	0000	Media Center PC	1972
Aiwa	0037, 0000, 0307, 0479	Gateway	1972	MEI	0035
Akai	0041, 0061, 0106	GE	0060, 0035, 0240, 0202, 0760, 0761, 0807, 1035, 1060	Memorex	0035, 0162, 0037, 0048, 0039, 0047, 0240, 0000, 0104, 0209, 0046, 0307, 0479, 1037, 1048, 1162, 1237, 1262
Alienware	1972				
America Action	0278	Go Video	0432, 0526		
American High	0035	GoldStar	0037, 0209, 0038, 0225, 1237		
Asha	0240				
Audiovox	0037, 0278	Gradiente	0000	MGA	0240, 0043, 0061
Beaumarck	0240	Harley Davidson	0000	MGN Technology	0240
Bell & Howell	0104	Harman/Kardon	0081, 0038	Microsoft	1972
Broksonic	0184, 0121, 0209, 0002, 0479, 1479	Harwood	0072	Mind	1972
		Headquarter	0046	Minolta	0042, 0105
Calix	0037	Hewlett Packard	1972	Mitsubishi	0081, 0067, 0043, 0041, 0061, 0173, 0807
Canon	0035	Hi-Q	0047		
Capehart	0020	Hitachi	0037, 0240, 0000, 0042, 0041, 0105, 1037	Motorola	0035, 0048
Carver	0081			MTC	0240, 0000
CCE	0072, 0278			Multitech	0000, 0072
Citizen	0037, 0278, 1278	Howard Computers	1972	NEC	0035, 0037, 0048, 0104, 0067, 0041, 0038, 0008
Colt	0072	HP	1972		
Craig	0037, 0047, 0240, 0072, 0271	Hughes Network Systems	0042, 0739		
		Humax	0739		
Curtis Mathes	0060, 0035, 0162, 0041, 0760, 1035	Hush	1972	Nikko	0037
		iBUYPOWER	1972	Niveus Media	1972
Cybernex	0240	Jensen	0041	Noblex	0240
CyberPower	1972	JVC	0045, 0067, 0041, 0008, 0366, 1707, 1945, 1774, 1775, 1776, 1777	Northgate	1972
Daewoo	0045, 0104, 0278, 0020, 0046, 0561, 1278	KEC	0037, 0278	Olympus	0035
Daytron	0020	Kenwood	0067, 0041, 0038	Optimus	1062, 0162, 0037, 0048, 0104, 0432, 0593, 1048, 1162, 1262
Dell	1972	KLH	0072	Orion	0184, 0121, 0209, 0002, 0208, 0479, 1479
Denon	0042	Kodak	0035, 0037		
DirecTV	0739	LG	0037, 0045, 0042, 0209, 0038, 1037	Panasonic	1062, 0035, 0162, 0225, 0227, 0616, 1035, 1162, 1262
Durabrand	0039, 0038	Linksys	1972		
Dynatech	0000	Lloyd's	0000, 0208	Penney	0035, 0037, 0240, 0042, 0038, 1035, 1237
Electrohome	0037	Logik	0240, 0072		
Electroponic	0037	LXI	0037		
Emerex	0032	Magnasonic	0593, 1278	Pentax	0042, 0105
Emerson	0035, 0037, 0184, 0240, 0045, 0000, 0121, 0043, 0209, 0002, 0278, 1593, 1479, 1278, 0593, 0561, 0479, 0208, 0061	Magnavox	0035, 0039, 0081, 0000, 0149, 0563, 0593, 1593, 1781	Philco	0035, 0000, 0038
		Magnin	0240		
		Marantz	0035, 0081		

Remote Programming

VCR mode				
VCR		VCR		PVR
Philips	0035, 0081, 0000, 0563, 0593, 0618, 0739, 1081, 1181, 1266	Symphonic	0000, 0593, 1593	Howard Computers 1972
		Systemax	1972	HP 1972
		Tagar Systems	1972	Hughes Network Systems 0739
		Tatung	0081, 0045, 0000, 0067, 0041, 0008, 0366	Humax 0739 Hush 1972 IBUYPOWER 1972
Pilot	0037	Teac	0000, 0041	JVC 1945
Pioneer	0081, 0042, 0067	Technics	0035, 0162	Linksys 1972
Polk Audio	0081	Teknika	0035, 0037, 0000	Media Center PC 1972
Portland	0020	Thomas	0000	Microsoft 1972
Presidian	1593	Tivo	0618, 0636, 0739, 1996	Mind 1972 Niveus Media 1972
Profftronic	0240	TMK	0240, 0208	Northgate 1972
Proscan	0060, 0202, 0760, 0761, 1060	Toshiba	0081, 0045, 0042, 0067, 0043, 0041, 0008, 0057, 0366, 0845, 1008, 1145, 1972, 1996	Panasonic 0616, 1777 Philips 0618, 0739 RCA 0880 ReplayTV 0614, 0616 Samsung 0739
Protec	0072	Totevision	0037, 0240	Sonic Blue 0614, 0616
Pulsar	0039	Touch	1972	Sony 0636, 1972
Quarter	0046	Unitech	0240	Stack 9 1972
Quartz	0046	Vector	0045	Systemax 1972
Quasar	0035, 0162, 1035, 1162	Vector Research	0038	Tagar Systems 1972
RadioShack	0000, 1037	Video Concepts	0045, 0061	Tivo 0618, 0636, 0739
Radix	0037	Videomagic	0037	Toshiba 1008, 1972, 1996
Randex	0037	Videosonic	0240	Touch 1972
RCA	0060, 0035, 0240, 0000, 0042, 0149, 0105, 0106, 0202, 0760, 0761, 0807, 0880, 1035, 1060	Viewsonic	1972	Viewsonic 1972
Realistic	0035, 0037, 0048, 0047, 0000, 0104, 0046	Villain	0000	Voodoo 1972
		Voodoo	1972	ZT Group 1972
		Wards	0060, 0035, 0048, 0047, 0081, 0240, 0000, 0042, 0072, 0149, 0760	DVD/PVR Combination
		White Westinghouse	0209, 0072	
XR-1000	0035, 0000, 0072			
Yamaha	0041, 0038			
ReplayTV	0614, 0616	Zenith	0039, 0033, 0000, 0209, 0034, 0479, 1139, 1479	Emerson 0000
Ricavision	1972	ZT Group	1972	
Runco	0039	DBS/PVR Combination		
Samsung	0240, 0045, 0432, 0739, 0760, 1014	Echostar	1945	
Sanky	0048, 0039	Hughes Network Systems	0739	
Sansui	0000, 0067, 0209, 0041, 0271, 0479, 1479	JVC	1945	
		Philips	0739	
Sanyo	0047, 0240, 0104, 0046	Samsung	0739	
Scott	0184, 0045, 0121, 0043	PVR		
Sears	0035, 0037, 0047, 0000, 0042, 0104, 0046, 0057, 0105, 1237	ABS	1972	
Sharp	0048, 0209, 0807, 0848, 1048	Alienware	1972	
		CyberPower	1972	
Shintom	0104, 0072	Dell	1972	
Shogun	0240	DirecTV	0739	
Singer	0045, 0072	Dish Network System	1945	
Sonic Blue	0614, 0616	Echostar	1945	
Sony	0035, 0032, 0033, 0000, 0034, 0636, 0639, 0640, 1032, 1232, 1972	Gateway	1972	
		Hewlett Packard	1972	
		Stack 9	1972	
		STS	0042	
Sylvania	0035, 0081, 0000, 0043, 0593, 1593, 1781			

Remote Programming

DVD mode

DVD		DVD		DVD Recorder	
Accurian	1416	Magnavox	0503, 0539, 0646,	Accurian	1416
Advent	1016		0675, 0821, 1268	Apex Digital	1056
Aiwa	0641	Marantz	0539	Aspire Digital	1168
Akai	0695, 0770, 0899	Memorex	0695, 0831, 1270	CyberHome	1129
Alco	0790	Microsoft	0522, 1708	Denon	0490
Allegro	0869	Mintek	0839, 0717	Funai	0675, 1334
Apex Digital	0672, 0717, 0755, 0830, 1056, 1061	Mitsubishi	1521, 0521	Gateway	1158
		NAD	0741	Go Video	0741, 1158, 1304, 1730
Argo	1023	NEC	0785		
Aspire Digital	1168	Nesa	0717	iLo	1348
Audiovox	0790	NexxTech	1402	JVC	1164
Blaupunkt	0717	Norcent	1003, 1107	LG	0741
Blue Parade	0571	Onkyo	0503, 0627	LiteOn	1158, 1416, 1440
Broksonic	0695	Oritron	0651	Magnavox	0646, 0675
Cinea	0831	Panasonic	0490, 0703, 1362, 1462, 1490, 1762	Panasonic	0490
Cine Vision	0876, 0833, 0869			Philips	0646, 1158
Citizen	1277	Philips	0503, 0539, 0646,	Pioneer	0631
Coby	0778, 1107		0675, 0854, 1158,	RCA	0522
Craig	0831		1260, 1267, 1354	Samsung	0490, 1470
Curtis Mathes	1087	Pioneer	0525, 0571, 0631	Sensory Science	1158
CyberHome	0816, 0874, 1023, 1024, 1117, 1129	Polaroid	1061	Sharp	0630, 0675
		Polk Audio	0539	Sony	1033, 1431
Daewoo	0784, 0705, 0770, 0833, 0869, 1169, 1172	Portland	0770	Sylvania	0675
		Presidian	0675	Zenith	0741
		Prima	1016		
Denon	0490, 0634	Proscan	0522	Home Theater in Box	
Disney	0675, 1270	Pro Vision	0778	Aiwa	0641
Durabrand	1127	Qwestar	0651	Audiovox	0790
DVD2000	0521	RCA	0522, 0571, 0717, 0790, 0822, 1022, 1132	JVC	1770, 1771, 1772, 1773
Emerson	0591, 0675, 0821, 1268			KLH	0790
Enterprise	0591	Rio	0869	Koss	0651
ESA	0821, 1268	Rotel	0623	Oritron	0651
Fisher	0670	Sampo	0752	Polk Audio	0539
Funai	0675, 1268, 1334	Samsung	0490, 0573, 0744, 0820, 0899, 1044, 1075, 1470	RCA	0790
Gateway	1158			Rio	0869
GE	0522, 0815, 0717	Sansui	0695	Sonic Blue	0869
Go Video	0744, 0715, 0741, 0783, 0833, 0869, 1044, 1075, 1099, 1158, 1304, 1730	Sanyo	0670, 0695, 0873	Teac	0790
		Sensory Science	1158	Venturer	0790
		Sharp	0630, 0675, 0752, 1256		
GoldStar	0741				
Greenhill	0717	Sharper Image	1117		
Harman/Kardon	0582, 0702	Sherwood	0770		
Hitachi	0573, 0664, 1247	Shinsonic	0533, 0839		
Hiteker	0672	Sonic Blue	0869, 1099		
Humax	1500, 1588	Sony	0533, 1533, 0864, 1033, 1431, 1536		
iLo	1348				
Initial	0717	Superscan	0821		
Insignia	1268	Sylvania	0675, 0821, 1268		
Integra	0627	Symphonic	0675, 0821		
JBL	0702	Teac	0717, 0790		
Jensen	1016	Technics	0490, 0703		
JVC	0558, 0623, 0867, 1164, 1602, 1770, 1771, 1772, 1773	Theta Digital	0571		
		Tivo	1503		
Kawasaki	0790	Toshiba	0503, 0695, 1045, 1154, 1503, 1515, 1588		
Kenwood	0490, 0534				
KLH	0717, 0790, 1149	Urban Concepts	0503		
Koss	0651	US Logic	0839		
Lasonic	0798	Venturer	0790		
Lenoxx	1127	Xbox	0522, 1708		
LG	0591, 0741, 0869	Yamaha	0490, 0539, 0545		
LiteOn	1058, 1158, 1416, 1440	Zenith	0503, 0591, 0741, 0869		

Remote Programming

Audio mode

Amplifier		Receiver		Home Theater in Box	
Amstrad	0078	Koss	1366, 1497	Aiwa	1388, 1641
Bose	0674	Lasonic	1798	Amphion Media Works	1563, 1615
Curtis Mathes	0300	Lennox	1437	AMW	1563, 1615
Durabrand	1561	LG	1293, 1869	Anam	1609
GE	0078	Liquid Video	1497	Apex Digital	1257, 1430
Harman/Kardon	0892	Magnavox	1189, 1269, 0531,	Audiovox	1390
JVC	0331		1514	Bose	1229, 1933
Left Coast	0892	Marantz	1189, 1269, 0891,	Cambridge Soundworks	1370
Lennox	1561		1289	Classic	1352
Linn	0269, 0282, 0829	Mitsubishi	1393	Coby	1389
Marantz	0892, 0269	NexxTech	1751	Criterion	1420
NEC	0264	Norcent	1389, 1751	Daewoo	1250
Optimus	0300, 0823	Nova	1389	Denon	2832
Philips	0892, 0269	Orkyo	0135, 0842, 1298,	Durabrand	1561
Pioneer	0013, 0300, 0823		1320, 1531	Gateway	1517
Polk Audio	0892, 0269	Optimus	1023, 0531, 1074	Go Video	1532
RCA	0300, 0823	Oritron	1366, 1497	Initial	1426
Shure	0264	Panasonic	1308, 1518, 0367,	Insignia	1751
Sony	0689, 0815, 1126		1288, 1316, 1548,	Integra	1298
Soundesign	0078		1633, 1763, 1764	JBL	1306
Victor	0331	Philips	1189, 1269, 0891,	JVC	1374, 1495, 1676,
Wards	0078, 0013		1266, 1289, 1673		1871
Yamaha	0354, 0133	Pioneer	1023, 0014, 0150,	KLH	1390, 1412
			0531, 0630, 1123,	Koss	1366, 1497
			1384, 1823	Lasonic	1798
			1508	Lennox	1561
		Polaroid	1289, 1414	LG	1293, 1869
ADC	0531	Polk Audio	1289, 1414	LG	1293, 1869
Aiwa	1405, 0121, 1243,	Proscan	1254	Liquid Video	1497
	1388, 1641	RCA	1023, 1609, 1254,	Magnavox	1514
Akai	1512		0531, 1074, 1123,	NexxTech	1751
Alco	1390		1390, 1511	Norcent	1389, 1751
Amphion Media Works	1563, 1615	Regent	1437	Nova	1389
AMW	1563, 1615	Rio	1869	Onkyo	1298, 1531
Anam	1609, 1074	Saba	0531, 1519	Oritron	1366, 1497
Apex Digital	1257, 1430	Samsung	1295, 1500	Panasonic	1288, 1316, 1548,
Audiotronic	1189	Sansui	1764		1633, 1763, 1764
Audiovox	1390	Sanyo	1251, 1469	Philips	1266, 1673
Bose	1229, 0639, 1841,	Sharp	0771, 1286	Pioneer	1384
	1933	Sharper Image	1556	Polaroid	1508
Brix	1602	Sherwood	1517, 1653	Polk Audio	1289
Cambridge Soundworks	1370	Shinasonic	1426	RCA	1609, 1390, 1511
Capetronic	0531	Sirius	1602	Regent	1437
Carver	1189	Sonic Blue	1532, 1869	Rio	1869
Classic	1352	Sony	1058, 1441, 1258,	Saba	1519
Coby	1389		1759, 1622, 0474,	Samsung	1295, 1500
Criterion	1420		1406, 1558, 1658,	Sanyo	1469
Daewoo	1250		1758, 1858, 1958	Sharper Image	1556
Delphi	1414	Stereophonics	1023	Sherwood	1517
Denon	1360, 0771, 1142,	Sunfire	1313	Shinasonic	1426
	1660, 2832	Teac	0463, 1074, 1390,	Sonic Blue	1532, 1869
Garrard	0463		1528	Sony	0689, 1622, 1558,
Gateway	1517	Technics	1308, 1518, 1384		1658, 1758, 1858,
Go Video	1532	Thorens	1189		1958
Harman/Kardon	0110, 0891, 1304,	Toshiba	1788	Teac	1390, 1528
	1306	Venturer	1390	Toshiba	1788
Initial	1426	Wards	0014	Venturer	1390
Insignia	1751	XM	1406, 1414	Yamaha	1331, 1375
Integra	0135, 1298, 1320	Yamaha	0176, 1176, 1276,	Zenith	1293
JBL	0110, 1306		1331, 1375, 1476		
JVC	0531, 1374, 1495,	Zenith	0857, 1293		
	1560, 1676, 1871,				
	1894				
Kenwood	1313, 1570, 1569				
KLH	1390, 1412				

OSD Information

Weak Signal

This OSD appears when the digital channel that you have selected is too weak to receive or no signal is being detected for that channel. It also appears when Noise Muting is On and no signal is being received from an external source.

No Program or Weak Signal

Audio / Data Only Channel

This OSD appears when the selected channel is not broadcasting any picture or sound, or is only broadcasting data information.

Audio / Data Only Channel

Troubleshooting

Refer to the table below to check the condition. If you think that there is a problem, contact the JVC Service Center where you purchased the television.

PROBLEMS	CHECK
There is no power	<ul style="list-style-type: none"> • See if the power cord became unplugged. • Check for a blown fuse or circuit breaker or a power outage.
There is no picture or sound	<ul style="list-style-type: none"> • The antenna could be disconnected. • The input mode could be set improperly. See page 59. • The tuner (Auto Tuner Setup) could be set improperly. See page 41. • The TV station may be having difficulties. Check to see if other stations are working. • Use the HDMI cable with HDMI logo HDMI . See page 19. • If you have a device connected to INPUT-1 or INPUT-2, you will not be able to hear any audio from the AUDIO OUT on the back of the TV. • You cannot output audio using the OPTICAL OUTPUT when you have digital sound from an HDMI device connected to the INPUT-1 or INPUT-2 connection on the back of the TV. (See page 18). • This TV can accept 480i (Composite / S / HDMI / Component), 480p, 720p and 1080i signals. Please check your settings.
Remote control is not operating properly or at all	<ul style="list-style-type: none"> • Check to see that the batteries are still working and properly installed. • Make sure the remote has a clear sight path to the TV. • You may be too far from the TV. You must be within 23 feet (7 meters).
You cannot select a certain channel	<ul style="list-style-type: none"> • Make sure the channels have been programmed. See "Channel Summary", page 42. • Check to see if the channel is locked. See "Channel Summary - Lock" page 43.
The power turns off by itself	<ul style="list-style-type: none"> • Make sure the set did not become unplugged. • Perhaps the On/Off Timer is set. See page 54. • Check to see if the Sleep Timer was set. See page 61.
It does not operate correctly	<ul style="list-style-type: none"> • This television is operated by a microprocessor. It is possible that external noise or interference is causing the problem. If the television does not function correctly, remove the electrical plug from the wall outlet and wait a while before inserting it into the wall outlet again and operating the television.
The clock is wrong	<ul style="list-style-type: none"> • The power was interrupted and the clock was not reset. See page 53.
The color quality is poor	<ul style="list-style-type: none"> • Tint and Color may be improperly adjusted. See page 47. • The Video Status mode may be turned to the wrong setting. See page 60.
There are lines across the picture	<ul style="list-style-type: none"> • There could be interference from another electrical appliance, such as a computer, another TV or VCR. Move any such appliances further away from the TV.
The picture is spotted	<ul style="list-style-type: none"> • There could be interference from a high-wattage appliance, like a hairdryer or vacuum, operating nearby. Move the antenna away from the appliance or change to a coaxial cable connection which is less prone to interference.
There are double pictures (ghosts)	<ul style="list-style-type: none"> • A building or passing airplane can reflect the original signal and produce a second, slightly delayed one. Adjust your antenna position.
Picture is snowy (image noise)	<ul style="list-style-type: none"> • Your antenna may be damaged, disconnected or turned. Check the antenna connection. If the antenna is damaged, replace it.
Screen is 80% black	<ul style="list-style-type: none"> • The Closed Caption Text mode is on. Turn it off in the Closed Caption Menu, page 37.
Stereo or bilingual programs can't be heard	<ul style="list-style-type: none"> • Make sure the MTS settings are correct. See page 64.

Troubleshooting

PROBLEMS	CHECK
Static electricity	• It is normal to feel static electricity if you brush or touch the screen.
You hear occasional crackling sounds	• It is normal for the TV to make crackling sounds when first turned on or off. Unless the sound or picture become abnormal, this is fine.
It does not operate correctly	• Press the CHANNEL- and VOLUME- buttons on the side panel of the TV simultaneously for a few seconds. The Digital Tuner will be reset. If this does not reset it correctly, unplug the power cord and plug it back in.
The picture is slightly cut off when you use 1080p format only	• Change the picture format setting on your external device to 1080i or other resolution.
The screen disappears except for the menu screen	• This occurs when you select a digital menu when your input source is from the HDMI connection. Press the menu button.

The following are not malfunctions.

- The television may make a creaking sound if the temperature of the room or the temperature of the inside of the television changes. If there is no problem with the screen or sound, then there is no need to worry.
- Although the picture may be temporarily disturbed and noise may be seen on the screen if the power is turned on immediately after it has been turned off, this is not a malfunction.

Specifications

Model	LT-37X688 LT-37XM48	LT-42X688 LT-42XM48
Type	LCD Flat Television	
Reception Format	NTSC, BTSC System (Multi-Channel Sound) ATSC Terrestrial, Digital Cable	
Reception Range	VHF 2 to 13, UHF 14 to 69 at ATSC, CATV 135 Sub, Mid, Super, Hyper and Ultra bands at Digital Cable	
	VHF 2 to 13, UHF 14 to 69 CATV 135 Sub, Mid, Super, Hyper and Ultra bands (191 channel frequency synthesizer system) at Analog • Reception of channel A-5 ("95" of the TV set's on-screen cable channel numbers) is not recommended for your TV set.	
Power Source	AC 120V, 60 Hz	
Power Consumption	210W	250W
Screen Size	37 inch / 94 cm measured diagonally, 16:9 ratio	42 inch / 106.7 cm measured diagonally, 16:9 ratio
Audio Output	10W + 10W	
Speakers	4 x 16cm Twin Oblique Cone x 2	
Antenna Terminal (VHF/UHF, ATSC/DIGITAL CABLE IN)	75 ohms (VHF/UHF)(F-type connector)	
Input 3, 4, 5 Terminal	480i S (Input 3) Y: 1 Vp-p positive, 75 ohms (negative sync provided) C: 0.286 Vp-p (burst signal), 75 ohms Video: 1 Vp-p, 75 ohms Audio: 500 mVrms (-4dBs) high impedance	
Input 3, 4 Terminal (Component Terminal)	1080i / 720p / 480p / 480i Y: 1 Vp-p positive, 75 ohms (negative sync provided) Pb/Pr: 0.7 Vp-p 75 ohms	
Input 1, 2 Terminal (HDMI Input Terminal)	Video: 1080p / 1080i / 720p / 480p / 480i Audio: 2ch PCM, 32 / 44.1 / 48 KHz 16 / 20 / 24 bit • Personal computer compatibility cannot be guaranteed.	
Audio Output Jacks (FIX)	FIX : 500mVrms (-4dBs), Low Impedance	
Optical Output Digital Audio	Digital Out (optical) x 1	
Dimensions (inch/cm) W X H X D	36 1/4 x 25 3/4 x 9 1/8 (with stand) 91.9 x 65.2 x 23 (with stand)	40 5/8 x 28 3/8 x 11 3/4 (with stand) 103 x 72 x 29.6 (with stand)
	36 1/4 x 23 7/8 x 4 3/8 (without stand) 91.9 x 60.4 x 10.8 (without stand)	40 5/8 x 26 1/2 x 4 3/8 (without stand) 103 x 67.2 x 10.8 (without stand)
Weight (lbs / kg)	42.9 / 19.5 (with stand)	57.2 / 26 (with stand)
	40.3 / 18.3 (without stand)	53 / 24.1 (without stand)
Accessories	Refer to "unpacking your TV", page 9	

Specifications subject to change without notice.

- The open source software is embedded in this product. For more information, please go to: http://software.jvc.com/opensource/lnx/DP/07_AtscQam/download.html
- This product uses the software of the Independent JPEG Group.

Specifications

Model	LT-42X788	LT-47X788
Type	LCD Flat Television	
Reception Format	NTSC, BTSC System (Multi-Channel Sound) ATSC Terrestrial, Digital Cable	
Reception Range	VHF 2 to 13, UHF 14 to 69 at ATSC, CATV 135 Sub, Mid, Super, Hyper and Ultra bands at Digital Cable	
	VHF 2 to 13, UHF 14 to 69 CATV 135 Sub, Mid, Super, Hyper and Ultra bands (191 channel frequency synthesizer system) at Analog • Reception of channel A-5 ("95" of the TV set's on-screen cable channel numbers) is not recommended for your TV set.	
Power Source	AC 120V, 60 Hz	
Power Consumption	250W	275W
Screen Size	42 inch / 106.7 cm measured diagonally, 16:9 ratio	47 inch / 119.3 cm measured diagonally, 16:9 ratio
Audio Output	10W + 10W	
Speakers	4,5 x 16 cm Twin Oblique Cone x 2	
Antenna Terminal (VHF/UHF, ATSC/DIGITAL CABLE IN)	75 ohms (VHF/UHF)(F-type connector)	
Input 3, 4, 5 Terminal	480i S (Input 3) Y: 1 Vp-p positive, 75 ohms (negative sync provided) C: 0.286 Vp-p (burst signal), 75 ohms Video: 1 Vp-p, 75 ohms Audio: 500 mVrms (-4dBs) high impedance	
Input 3, 4 Terminal (Component Terminal)	1080i / 720p / 480p / 480i Y: 1 Vp-p positive, 75 ohms (negative sync provided) Pb/Pr: 0.7 Vp-p 75 ohms	
Input 1, 2 Terminal (HDMI Input Terminal)	Video: 1080p / 1080i / 720p / 480p / 480i Audio: 2ch PCM, 32 / 44.1 / 48 KHz 16 / 20 / 24 bit • Personal computer compatibility cannot be guaranteed.	
Audio Output Jacks (FIX)	FIX : 500mVrms (-4dBs), Low Impedance	
Optical Output Digital Audio	Digital Out (optical) x 1	
Dimensions (inch/cm) W X H X D	39 3/4 x 28 1/8 x 11 3/4 (with stand) 100.7 x 71.2 x 29.6 (with stand)	44 1/8 x 30 5/8 x 11 3/4 (with stand) 112 x 77.7 x 29.6 (with stand)
	39 3/4 x 26 x 5 1/8 (without stand) 100.7 x 66 x 13 (without stand)	44 1/8 x 28 5/8 x 5 1/8 (without stand) 112 x 72.6 x 13 (without stand)
Weight (lbs / kg)	61.6 / 28 (with stand)	69.3 / 31.5 (with stand)
	58.1 / 26.4 (without stand)	65.8 / 29.9 (without stand)
Accessories	Refer to "unpacking your TV", page 9	

Specifications subject to change without notice.

- The open source software is embedded in this product. For more information, please go to: http://software.jvc.com/opensource/lnx/DP/07_AtscQam/download.html
- This product uses the software of the Independent JPEG Group.



LIMITED WARRANTY

COLOR TV 1-1

For Canadian model televisions, see separate sheets for Canadian Warranty information.

JVC COMPANY OF AMERICA (JVC) warrants this product and all parts thereof, except as set forth below ONLY TO THE ORIGINAL RETAIL PURCHASER to be FREE FROM DEFECTIVE MATERIALS AND WORKMANSHIP from the date of original purchase for the period shown below. ("The Warranty Period")
FOR DIRECT-VIEW COLOR TELEVISION, PICTURE TUBE is covered for Two(2)years.

Parts	1 YEAR	Labor	1 YEAR
-------	---------------	-------	---------------

THIS LIMITED WARRANTY IS VALID ONLY IN THE FIFTY (50) UNITED STATES, THE DISTRICT OF COLUMBIA AND IN THE COMMONWEALTH OF PUERTO RICO.

WHAT WE WILL DO:

If this product is found to be defective within the warranty period, JVC will repair or replace defective parts with new or rebuilt equivalents at no charge to the original owner. Such repair and replacement services shall be rendered by JVC during normal business hours at JVC authorized service centers. Parts used for replacement are warranted only for the remainder of the Warranty Period. All products may be brought to a JVC authorized service center on a carry-in basis. Color televisions with a screen size of 27" or greater qualify for in-home service. In such cases, a technician will come to your home and either repair the TV there or remove and return it if it cannot be repaired in your home.

WHAT YOU MUST DO FOR WARRANTY SERVICE:

Please do not return your product to the retailer
Instead, return your product to the JVC authorized service center nearest you. If shipping the product to the service center, please be sure to package it carefully, preferably in the original packaging, and include a brief description of the problem(s). Please call 1-800-252-5722 to locate the nearest JVC authorized service center. Service locations can also be obtained from our website <http://www.jvc.com>. If your product qualifies for in-home service, the service representative will require clear access to the product.

If you have any questions concerning your JVC Product, please contact our Customer Care Center at 800-252-5722

WHAT IS NOT COVERED:

This limited warranty provided by JVC does not cover:

1. Products which have been subject to abuse, accident, alteration, modification, tampering, negligence, misuse, faulty installation, lack of reasonable care, or if repaired or serviced by anyone other than a service facility authorized by JVC to render such service, or if affixed to any attachment not provided with the products, or if the model or serial number has been altered, tampered with, defaced or removed;
2. Initial installation, installation and removal from cabinets or mounting systems.
3. Operational adjustments covered in the Owner's Manual, normal maintenance, video and audio head cleaning;
4. Damage that occurs in shipment, due to act of God, and cosmetic damage;
5. Signal reception problems and failures due to line power surge;
6. Video Pick-up Tubes/CCD Image Sensors are covered for 90 days from the date of purchase;
7. Accessories;
8. Batteries (except that Rechargeable Batteries are covered for 90 days from the date of purchase);
9. Products used for commercial purposes, including, but not limited to rental.

There are no express warranties except as listed above.

THE DURATION OF ANY IMPLIED WARRANTIES, INCLUDING THE IMPLIED WARRANTY OF MERCHANTABILITY, IS LIMITED TO THE DURATION OF THE EXPRESS WARRANTY HEREIN.

JVC SHALL NOT BE LIABLE FOR ANY LOSS OF USE OF THE PRODUCT, INCONVENIENCE, OR ANY OTHER DAMAGES, WHETHER DIRECT, INCIDENTAL OR CONSEQUENTIAL (INCLUDING, WITHOUT LIMITATION, DAMAGE TO TAPES, RECORDS OR DISCS) RESULTING FROM THE USE OF THIS PRODUCT, OR ARISING OUT OF ANY BREACH OF THIS WARRANTY. ALL EXPRESS AND IMPLIED WARRANTIES, INCLUDING THE WARRANTIES OF MERCHANTABILITY AND FITNESS FOR PARTICULAR PURPOSE, ARE LIMITED TO THE WARRANTY PERIOD SET FORTH ABOVE.

Some states do not allow the exclusion of incidental or consequential damages or limitations on how long an implied warranty lasts, so these limitations or exclusions may not apply to you. This warranty gives you specific legal rights and you may also have other rights which vary from state to state.

JVC COMPANY OF AMERICA
DIVISION OF JVC AMERICAS CORP. <http://www.jvc.com>
1700 Valley Road
Wayne, NJ 07470

REFURBISHED PRODUCTS CARRY A SEPARATE WARRANTY, THIS WARRANTY DOES NOT APPLY. FOR DETAIL OF REFURBISHED PRODUCT WARRANTY, PLEASE REFER TO THE REFURBISHED PRODUCT WARRANTY INFORMATION PACKAGED WITH EACH REFURBISHED PRODUCT.

For customer use:

Enter below the Model No. and Serial No. which is located either on the rear, bottom or side of the cabinet. Retain this information for future reference.

Model No. :	Serial No. :
Purchase date :	Name of dealer :

TO OUR VALUED CUSTOMER ———

THANK YOU FOR PURCHASING THIS JVC PRODUCT.
WE WANT TO HELP YOU ACHIEVE A PERFECT EXPERIENCE.

**NEED HELP ON HOW TO HOOK UP?
NEED ASSISTANCE ON HOW TO OPERATE?
NEED TO LOCATE A JVC SERVICE CENTER?
LIKE TO PURCHASE ACCESSORIES?**

JVC[®] IS HERE TO HELP!
TOLL FREE: 1(800)252-5722
<http://www.jvc.com>

Remember to retain your Bill of Sale for Warranty Service.

————— **Do not attempt to service the product yourself** —————

Caution

To prevent electrical shock, do not open the cabinet.
There are no user serviceable parts inside.
Please refer to qualified service personnel for repairs.

JVC COMPANY OF AMERICA
Division of JVC Americas Corp.
1700 Valley Road
Wayne, New Jersey, 07470



JVC CANADA, INC.
21 Finchdene Square
Scarborough, Ontario
Canada, M1X 1A7



Thank you very much for purchasing our television, model **LT-47XC58**.

Note:

While the TV model you purchased, **LT-47XC58** does not appear in the instruction book, the instructions for this model are exactly the same as model **LT-47X788**.

Free Manuals Download Website

<http://myh66.com>

<http://usermanuals.us>

<http://www.somanuals.com>

<http://www.4manuals.cc>

<http://www.manual-lib.com>

<http://www.404manual.com>

<http://www.luxmanual.com>

<http://aubethermostatmanual.com>

Golf course search by state

<http://golfingnear.com>

Email search by domain

<http://emailbydomain.com>

Auto manuals search

<http://auto.somanuals.com>

TV manuals search

<http://tv.somanuals.com>