

JVC

BLACK Sapphire

User Manual

SP50M-C

SP55M-C



Regulatory Statement

Welcome to the JVC family of customers. We hope that you will have many years of enjoyment from your new JVC Smart E-LED HDTV. To get the most out of your JVC Smart E-LED HDTV, read these instructions before making any adjustments, and retain them for future reference.

For assistance, call the JVC Customer Support and Service Center at 1-855-868-1928 or visit our website at <http://go.jvc.com/HDTVSupport/>.

Serial Number:

Model Number:

We recommend that you register your JVC Smart E-LED HDTV either at our website at <http://go.jvc.com/HDTVSupport/> or fill out and mail the Product Registration Card on the back of the Quick Start Guide.

Retain your purchase receipt and write down the model and serial number located at the back of your HDTV for easy reference when obtaining service support.



This product qualifies for ENERGY STAR in the "factory default" setting and this is the setting in which power savings will be achieved. Changing the factory default picture setting or enabling other features will increase power consumption that could exceed the limits necessary to qualify for Energy Star rating.

Regulatory Statement



HDMI, the HDMI Logo, and High-Definition Multimedia Interface are trademarks or registered trademarks of HDMI Licensing LLC in the United States and other countries.



Manufactured under license from Dolby Laboratories.
Dolby and the double-D symbol are trademarks of Dolby Laboratories.

THE TRADEMARKS SHOWN HEREIN ARE THE PROPERTY OF THEIR RESPECTIVE OWNERS;
IMAGES USED ARE FOR ILLUSTRATION PURPOSES ONLY. JVC, THE JVC LOGO, AND OTHER JVC TRADEMARKS ARE THE INTELLECTUAL PROPERTY OF JVC KENWOOD CORPORATION.
PRODUCT SPECIFICATIONS ARE SUBJECT TO CHANGE WITHOUT NOTICE.
COPYRIGHT 2012 AmTRAN Video Corporation. ALL RIGHTS RESERVED

Regulatory Statement



The lightning flash with arrowhead symbol, within an equilateral triangle, is intended to alert the user to the presence of uninsulated dangerous voltage with the product's enclosure that may be of sufficient magnitude to constitute a risk of electric shock.



The exclamation point within an equilateral triangle is intended to alert the user to the presence of important operating and maintenance (servicing) instructions in the literature accompanying the appliance.

Regulatory Statement

- WARNING:** TO PREVENT FIRE OR SHOCK HAZARD, DO NOT EXPOSE THIS APPLIANCE TO RAIN OR MOISTURE. TO PREVENT THE SPREAD OF FIRE, KEEP CANDLES OR OPEN FLAMES AWAY FROM THIS PRODUCT AT ALL TIMES.
- CAUTION:** TO PREVENT ELECTRIC SHOCK, DO NOT USE THIS POLARIZED PLUG WITH AN EXTENSION CORD, RECEPTACLE, OR OTHER OUTLET UNLESS THE BLADES CAN BE FULLY INSERTED TO PREVENT BLADE EXPOSURE.

- WARNING:** This device complies with Part 15 of the FCC Rules. Operation is subject to the following two conditions: (1) this device may not cause harmful interference, and (2) this device must accept any interference received, including interference that may cause undesired operation. Note: This equipment has been tested and found to comply with the limits for a Class B digital device, pursuant to Part 15 of the FCC Rules. These limits are designed to provide reasonable protection against harmful interference in a residential installation. This equipment generates, uses, and can radiate radio frequency energy and, if not installed and used in accordance with the instructions, may cause harmful interference to radio communications.
- However, there is no guarantee that interference will not occur in a particular installation. If this equipment does cause harmful interference to radio or television reception, which can be determined by turning the equipment off and on, the user is encouraged to try to correct the interference by one or more of the following measures:
- Reorient or relocate the receiving antenna.
 - Increase the separation between the equipment and receiver.

Regulatory Statement

- Connect the equipment into an outlet on a circuit different from that to which the receiver is connected
- Consult the dealer or an experienced radio/TV technician for help.

CAUTION:

Changes or modifications not expressly approved by the party responsible for compliance with the FCC Rules could void the user's authority to operate this equipment.

Responsible Party: AmTRAN Video Corporation

Address: 9 Goddard, Irvine, CA 92618, USA

Telephone No; 949-336 6633

Required Marking Location

The rating sheet and the safety caution are on the rear of the unit.

Important Safety Information

- 1) Read these instructions.
- 2) Heed all warnings.
- 3) Follow all instructions.
- 4) Do not use this device near water.
- 5) Clean only with dry cloth.
- 6) Do not block any ventilation openings. Install in accordance with manufacturer's instructions.
- 7) Do not install near any heat sources such as radiators, heat registers, stoves, or other heat-generation devices.
- 8) Do not defeat the safety purpose of the polarized or grounding-type plug. A polarized plug has two blades with one wider than the other. A grounding-type plug has two blades and a third grounding prong. The wide blade or the third prong is provided for your safety. If the provided plug does not fit into your outlet, consult an electrician for replacement of the obsolete outlet.
- 9) Protect the power cord from being walked on or pinched, particularly at plugs, convenience receptacles, and the point where they exit from the device.
- 10) Only use attachments/accessories specified by the manufacturer.
- 11) Use only with the cart, stand, tripod, bracket, or table specified by the manufacturer, or sold with the apparatus. When a cart is used, use caution when moving the cart/apparatus combination to avoid injury from tip-over.
- 12) Unplug this apparatus during lightning storms or when unused for long periods of time.
- 13) Refer all servicing to qualified service personnel. Servicing is required when the apparatus has been damaged in any way, such as power supply cord or plug is damaged, liquid has been spilled or objects have fallen into the apparatus, the apparatus has been exposed to rain or moisture, does not operate normally, or has been dropped.
- 14) Apparatus should not be exposed to dripping or splashing, and objects filled with liquids, such as vases, should not be placed on the apparatus.
- 15) An outside antenna system should not be located in the vicinity of overhead power lines or other electric light or power circuits, or where it can fall into such power lines or circuits. When installing an outside antenna system, extreme care should be taken to keep from touching such power lines or circuits, as contact with them might be fatal.
- 16) Do not overload wall outlets and extension cords, as this can result in a risk of fire or electric shock.
- 17) Do not push objects through any openings in this unit as they may touch dangerous voltage points or short out parts that could result in fire or electric shock. Never spill or spray any type of liquid into the unit.

Important Safety Information

- 18) If an outside antenna or cable system is connected to the unit, be sure the antenna or cable system is grounded to provide some protection against voltage surges and built-up static charges, Section 810 of the National Electrical Code, ANSI/NFPA 70, provides information with respect to proper grounding of the mast and supporting structure, grounding of the lead-in wire to an antenna discharge unit, size of grounding conductors, location of antenna discharge unit, connection to grounding electrodes, and requirements for the grounding electrode.
- 19) When replacement parts are required, be sure the service technician uses replacement parts specified by the manufacturer or those that have the same characteristics as the original part. Unauthorized substitutions may result in fire, electric shock, or other hazards.
- 20) Upon completion of any service or repairs to this unit, ask the service technician to perform safety checks to determine that the unit is in proper operating condition.
- 21) When you connect the product to other equipment, turn off the power and unplug all of the equipment from the wall outlet. Failure to do so may cause an electric shock and serious personal injury. Read the owner's manual of the other equipment carefully and follow the instructions when making any connections.
- 22) Sudden high volume sound may cause hearing or speaker damage. When you use headphones (if the unit is equipped with a headphone jack), keep the volume at a moderate level. If you use headphones continuously with high volume sound, it may cause speaker overheating and fire.
- 23) Do not allow the product to output distorted sound for an extended period of time. It may cause speaker overheating and fire.
- 24) This reminder is provided to call the cable TV system installer's attention to Article 820-40 of the NEC that provides guidelines for proper grounding and, in particular, specifies that the cable ground shall be connected to the grounding system of the building, as close to the point of cable entry as practical.
- 25) The socket outlet must be installed near the unit and easily accessible.

Important Safety Information

CHILD SAFETY:

It Makes A Difference How and Where You Use The TV

Congratulations on your purchase! As you enjoy your new product, please keep these safety tips in mind.

THE ISSUE:

The home theater entertainment experience is a growing trend and larger TVs are popular purchases. However, TVs are not always supported on the proper stands or installed according to the manufacturer's recommendations. TVs that are inappropriately situated on dressers, bookcases, shelves, desks, speakers, chests, or carts may fall over and cause injury.

THIS MANUFACTURER CARES!

The consumer electronics industry is committed to making home entertainment enjoyable and safe.

TUNE INTO SAFETY

One size does NOT fit all. Follow the manufacturer's recommendations for the safe installation and use of your TV.

Carefully read and understand all enclosed instructions for proper use of this product.

Don't allow children to climb on or play with furniture and television sets.

Don't place TVs on furniture that can easily be used as steps, such as a chest of drawers.

Remember that children can become excited while watching a program, especially on a "larger than life" TV. Care should be taken to place or install the display where it cannot be pushed, pulled over, or knocked down.

Care should be taken to route all cords and cables connected to the TV so that they cannot be pulled or grabbed by curious children.

Important Safety Information

CONDENSATION

Moisture will form in the operating section of the unit if the unit is brought from cool surroundings into a warm room or if the temperature of the room rises suddenly. When this happens, unit's performance will be impaired. To prevent this, let the unit stand in its new surroundings for about an hour before switching it on, or make sure that the room temperature rises gradually. Condensation may also form during the summer if the unit is exposed to the breeze from an air conditioner. In such cases, change the location of the unit.

HOW TO HANDLE THE LCD PANEL

- Do not press hard or jolt the LCD panel. It may cause the LCD panel glass to break and injury may occur.

- If the LCD panel is broken, make absolutely sure that you do not touch the liquid in the panel. This may cause skin inflammation.
- If the liquid gets in your mouth, immediately gargle and consult with your doctor. Also, if the liquid gets in your eyes or touches your skin, consult with your doctor after rinsing for at least 15 minutes or longer in clean water.

Possible Adverse Effects on LCD Panel:

If a fixed (non-moving) pattern remains on the LCD panel for long periods of time, the image can become permanently engrained in the LCD panel and cause subtle but permanent ghost images. This type of damage is NOT COVERED BY YOUR WARRANTY. Never leave your TV on for long periods of time while it is displaying the following formats or images:

Important Safety Information

- Fixed images, such as stock tickers, video game patterns, TV station logos, and web sites.
- Special formats that do not use the entire screen. For example: viewing letterbox style (16:9) media on a normal (4:3) display (black bars at top and bottom of screen); or viewing normal style (4:3) media on a widescreen (16:9) display (black bars on left and right sides of screen).

The following symptoms are not signs of malfunction but technical limitations

- LCD panels are manufactured using an extremely high level of precision technology; however, sometimes parts of the screen may be missing picture elements or have luminous spots. This is not a sign of malfunction.

- Do not install the TV near electronic equipment that produces electromagnetic waves. Some equipment placed too near this unit may cause interference.
- Effect on infrared devices – There may be interference while using infrared devices such as infrared cordless headphones.

Television Antenna Connection Protection

External Television Antenna Grounding

If an outside antenna/satellite dish or cable system is to be connected to the TV, make sure that the antenna or cable system is electrically grounded to provide some protection against voltage surges and static charges.

Article 810 of the National Electrical Code, ANSI/NFPA 70, provides information with regard to proper grounding of the mast and

Important Safety Information

supporting structure, grounding of the lead-in wire to an antenna discharge unit, size of the grounding conductors, location of antenna discharge unit, connection to grounding electrodes, and requirements of the ground electrode.

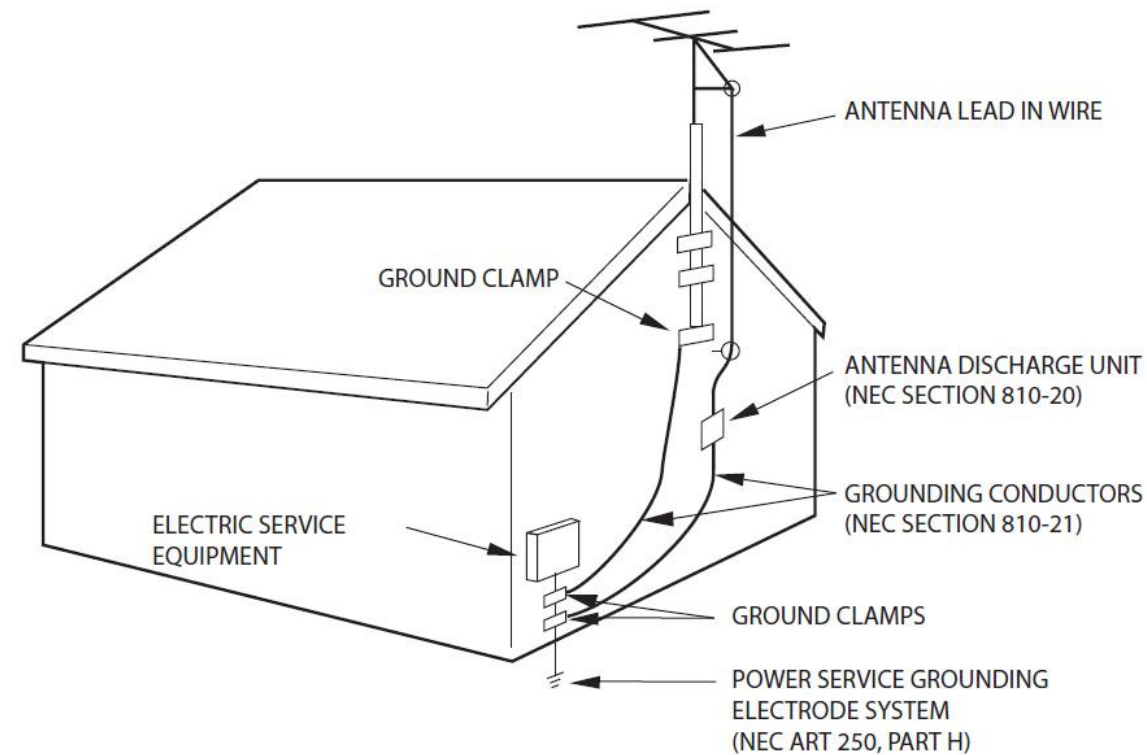

Lightning Protection

For added protection of the TV during a lightning storm or when it is left unattended or unused for long periods of time, unplug the TV from the wall outlet and disconnect the antenna or cable system.

Power Lines

Do not located the antenna near overhead light or power circuits, or where it could fall into such power lines or circuits.

Important Safety Information

DTV Transition Advisory

As of June 12, 2009, all U.S. television stations have switched to digital broadcasting. As a result, owners of analog television sets must connect a digital-to-analog converter box to the television set or subscribe to cable or satellite TV to receive over-the-air TV. Analog-only TVs continue to work as before to receive low power, Class A or translator television stations and with cable and satellite TV services, gaming consoles, VCRs, DVD players, and similar products.

For more information about the DTV transition, visit www.dtv.gov.

FCC Consumer Center

Email: dtcinfo@fcc.gov

Phone: 1-888-CALLFCC (1-888-225-5322)

Fax: 1-866-418-0232; or writing to:

Federal Communications Commission

Consumer and Governmental Affairs Bureau

Consumer Inquiries and Complaints Division

445 12th Street, SW

Washington, DC 20554

Setting Up The TV

Package Contents

Your JVC Black Sapphire HDTV is shipped with the items shown below:



Attaching the Stand

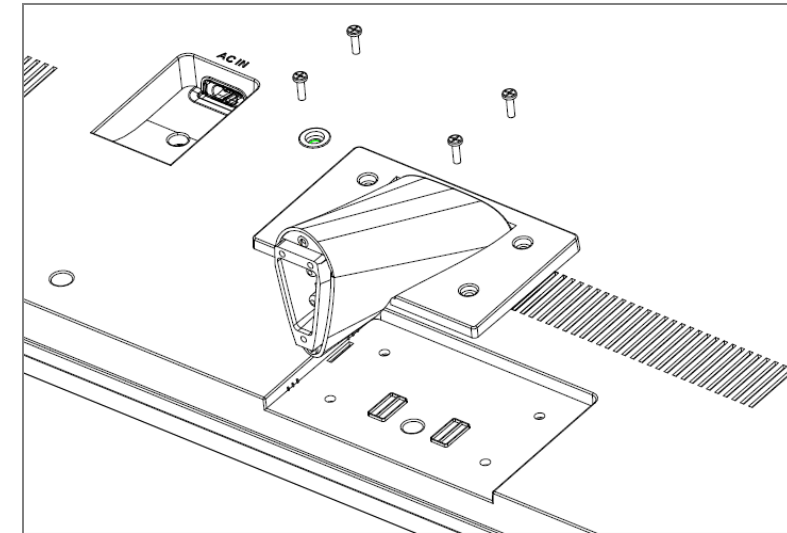

Place TV on a flat surface and the protective bag. Screen face down.

Attach TV stand to rear of television with the provided four (4) **pan head** screws.

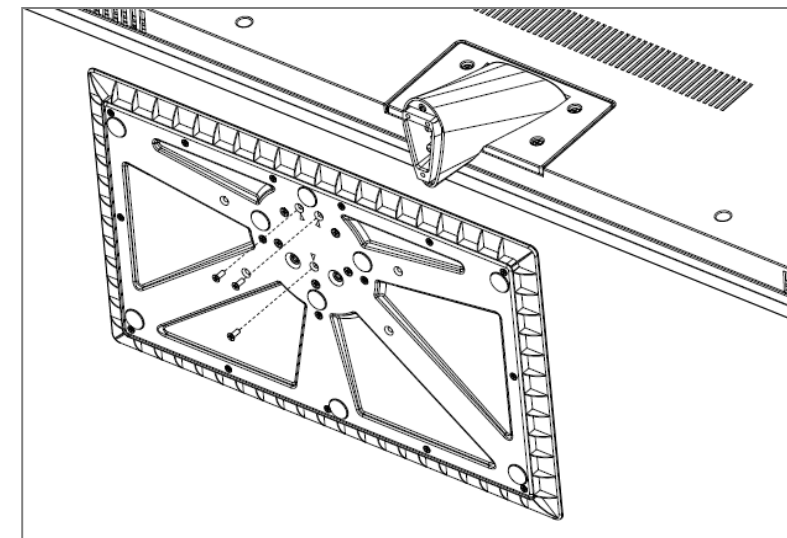

Mount the base to the stand with the provided three (3) **flat head** screws

Carefully lift TV up

Setting Up The TV

Kensington Lock

Theft Deterrent Kensington Lock

Your JVC TV contains a Kensington Lock-compatible slot/hole that helps securely affix the TV to other physical objects. The appearance and locking method differs depending on the manufacturer. Refer to the manual provided with the Kensington Lock for installation information.

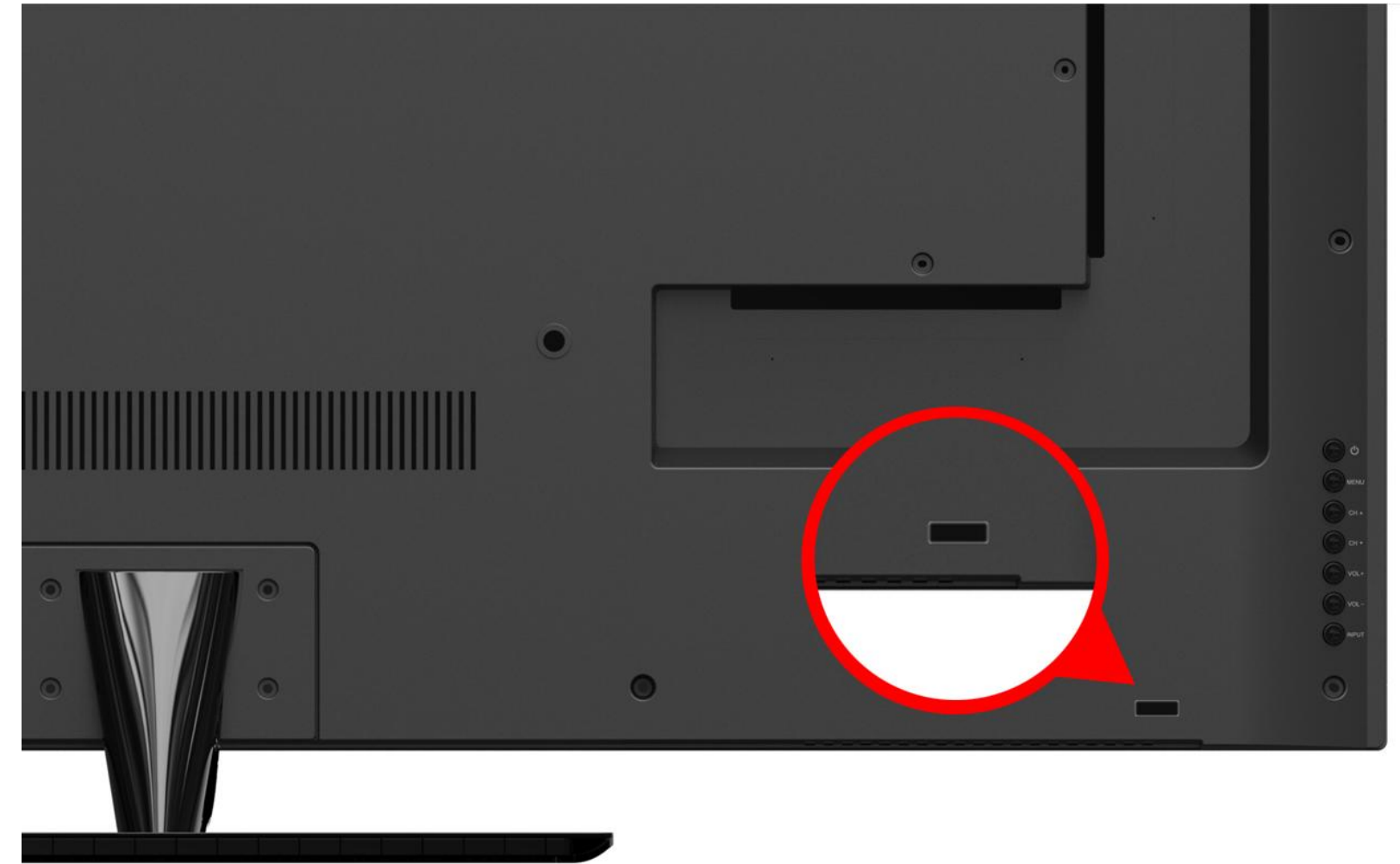

Setting Up The TV

Removing the Stand

When television needs to be transported, remove TV Stand and pack TV back in its shipping box. To remove TV Stand, remove 4 pan head screws securing stand to rear of television.

Wall Mounting



For product protection and safety reasons, JVC strongly recommends contacting a professional installer or technician for assistance with the installation of the wall mount and with the setup of your TV. JVC will not be held responsible for any damage to the product or injury to yourself and others should you decide to install the wall mount and TV without the assistance of a professional installer or technician.

Installing Wall Mount

A wall mount kit (not included with TV) allows you to mount the TV onto a wall. For the proper and safe installation of a wall mount, follow the detailed instructions included in the wall mount kit.

Refer to the specification section for the right wall mount size



Do not install your TV to the wall mount while the TV is turned on. It can result in personal injury due to electric shock.
A minimum of two people should be used when moving TV, and when installing TV onto a wall mount.

Setting Up The TV

- 1 Turn off your TV and disconnect all cables.
- 2 Carefully place the TV face down on a flat, clean, and padded surface. If available, put TV cover or protective sheet onto the TV before laying the TV down on flat surface.
- 3 Using a cross-tip screwdriver, remove four screws securing TV stand to rear of TV. Remove TV stand.
- 4 Follow instructions in wall mount kit and install wall mount. Install TV onto wall mount in accordance with wall mount kit instructions.

NOTE: Wall mount screw hole pattern on rear of this model is VESA 400 x 400mm, with M8 screws

Setting Up The TV

Install Batteries Into Remote Control



To open the battery compartment, press down on top end of cover and then slide cover down.

Insert two AAA batteries into battery compartment. Observe correct polarity.

Insert cover and slide up into place.

Battery Precautions:

Be sure to follow the correct polarity. Incorrect installation may cause battery leakage or damage to the remote control.

Always replace batteries in pairs; never combine a used battery with a new one.

Do not use different battery types together (e.g. Alkaline and Carbon-zinc).

If remote control will not be used for an extended period of time, remove batteries to prevent battery leakage.

Parts and Functions - TV

Side View

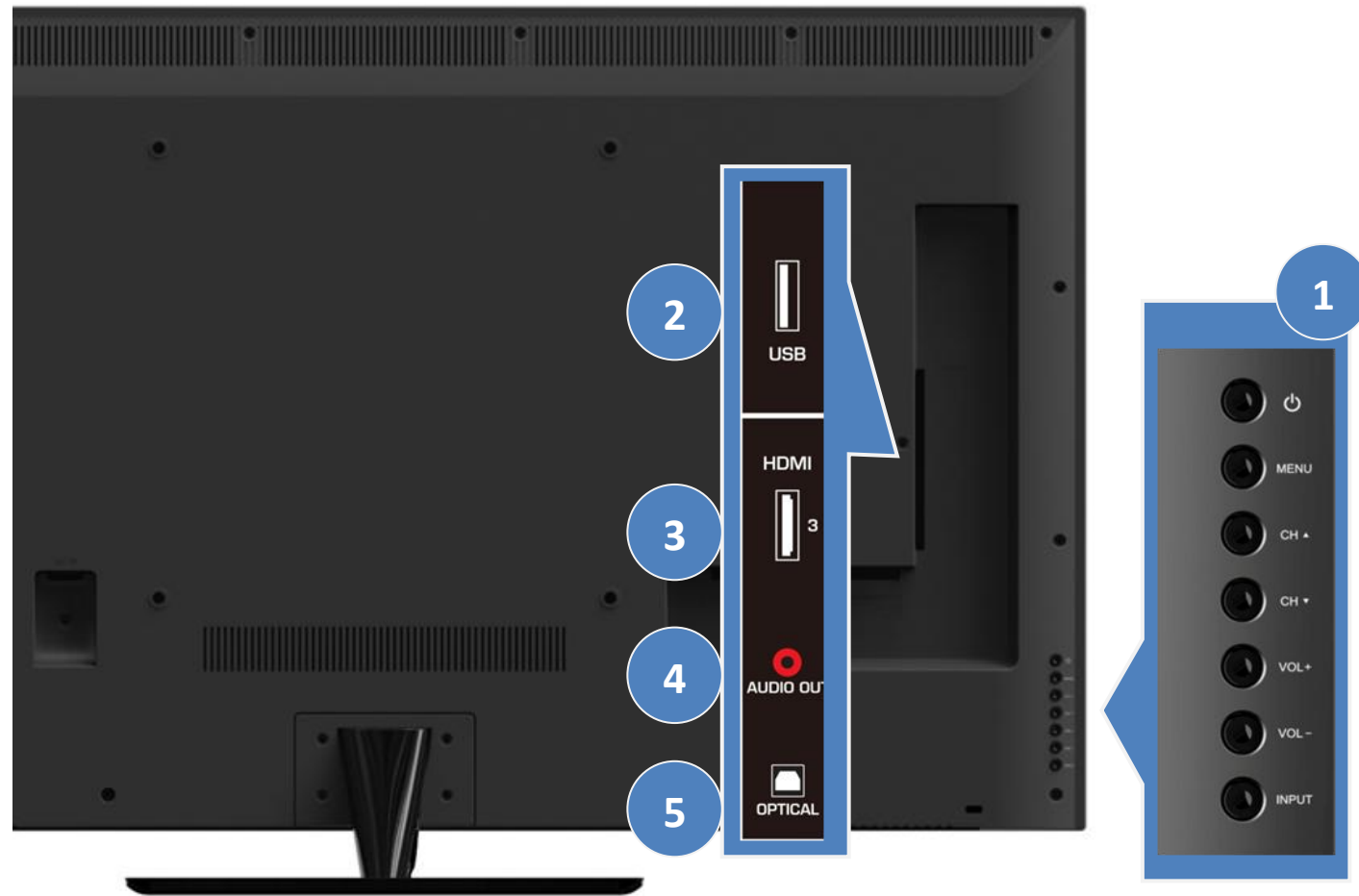

1	Power Button
	MENU Button
	CH ▲ Button
	CH ▼ Button
	VOL+ Button
	VOL- Button
	INPUT Button
2	USB Port
3	HDMI -3 Port
4	Audio Out (headphone)
5	Optical Audio Out

Parts and Functions - TV

Rear View

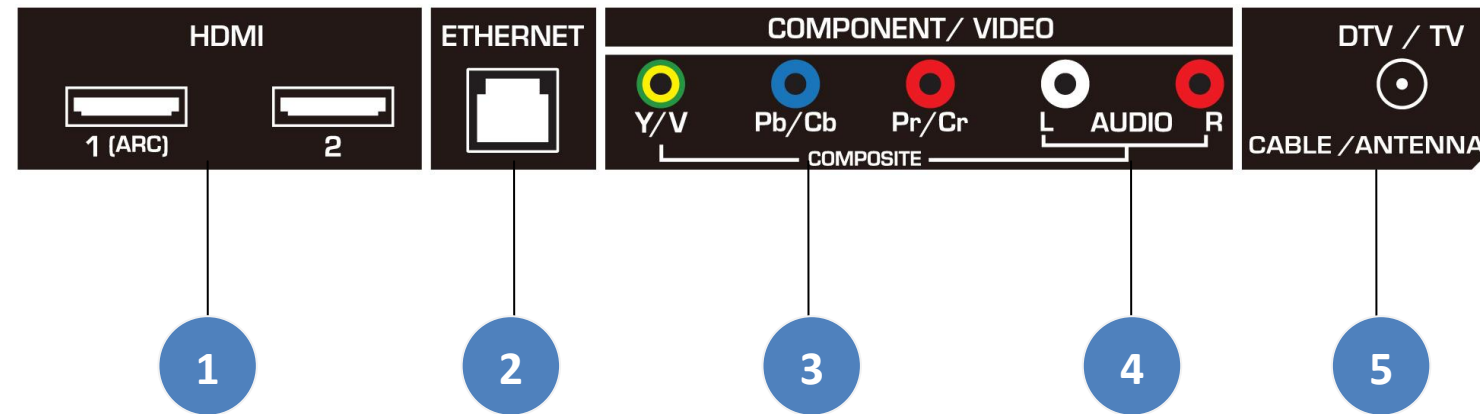

1	HDMI-1 (ARC) and HDMI-2 ports
2	Ethernet port
3	Component / Video Input Jack
4	Component / Video / Music Port Audio Input Jack
5	TV Antenna / Cable Input Jack

Parts and Functions - Remote

Remote Control

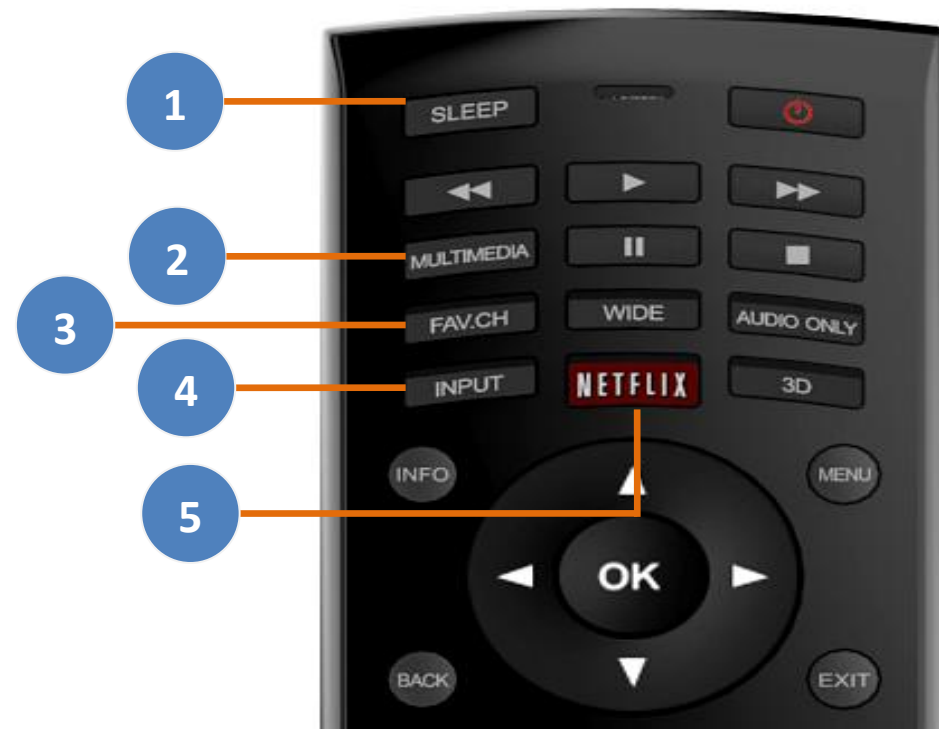

1

SLEEP button: When pressed, displays **Sleep Timer** menu on TV screen.

2

MULTIMEDIA button: When pressed, displays contents in the USB drive connected to TV

3

FAV.CH button: When pressed, displays your favorite channels list.

4

INPUT button: When pressed, displays **Input Source** menu on TV screen.

5

NETFLIX button: When pressed, launches NETFLIX application.

Parts and Functions - Remote



6

INFO button: When pressed, displays Info bar at top of TV screen.

7

OK button: Launches a menu, selects a menu option, and selects on-screen keypad characters.

8

BACK button: Returns User to previous TV screen.

9

ICE (Internet Connected Experience) Apps button: When pressed, displays I.C.E. application icons on TV screen.

10

VOL (Volume) button: Increases (**VOL**) and decreases (**VOL**) TV volume.

11

MUTE button: When pressed, sets TV audio on or off.

Parts and Functions - Remote



12

LAST button: When pressed, switches back to last channel

13

-- (dash) button: Serves as dash or decimal point for broadcast channels

14

Number keypad (0-9): When input source is TV, changes channel. Can be used when entering numeric values in application log in fields.

15

CH (Channel) button: When input source is TV, increases and decreases channel number.

16

Multipurpose buttons

17

EXIT button: Used for exiting a menu, application, or mode.

Parts and Functions - Remote

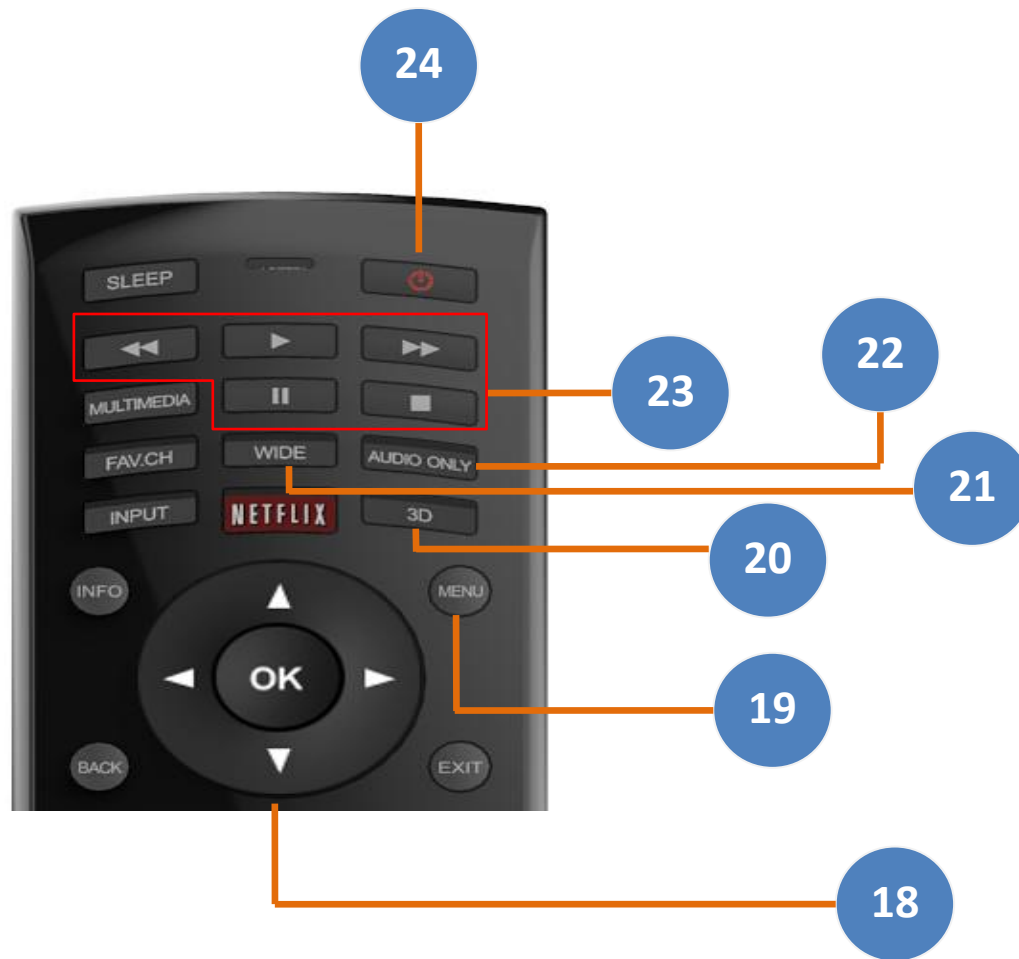

18	Direction buttons: Navigate the menu, select options, or adjust settings value.
19	MENU button: When pressed, displays TV SETTING menu.
20	3D button: While viewing 3D contents, press it for 3D/2D control options Note: 3D functionality is applicable to 3D TV models only.
21	WIDE button: When pressed, displays Screen Mode selections on TV screen.
22	AUDIO ONLY button: When pressed, turns off TV screen but continues to play audio from input source.
23	Playback buttons: Used for Video in USB flash and HDMI CEC functions.
24	Power button: When pressed, turns TV on or off.

Parts and Functions - Remote



25

Direction buttons: Navigate the menu, select options, or adjust settings value.

26

OK button: Launches a menu, selects a menu option, and selects on-screen keypad characters.

27

QWERTY Keypad: Enter log in information such as your Username and Password or fill in I.C.E. App fields.

Making A/V Connections



Connect to DTV / Cable / Antenna

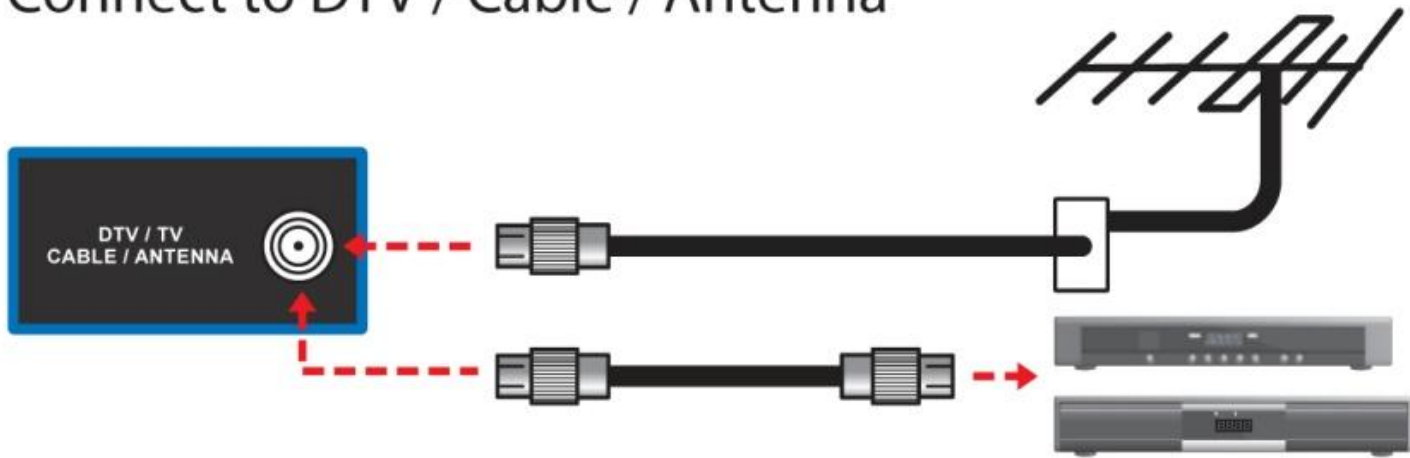

Connect to USB

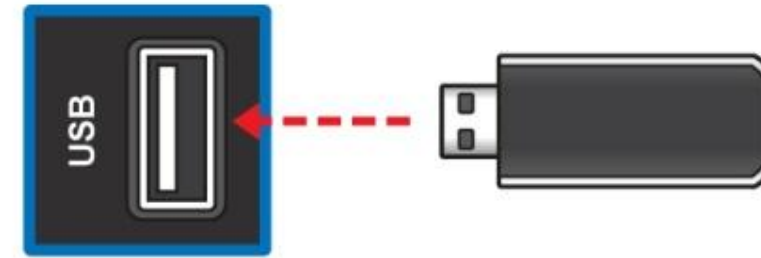

Connect to External Speakers/Amplifiers

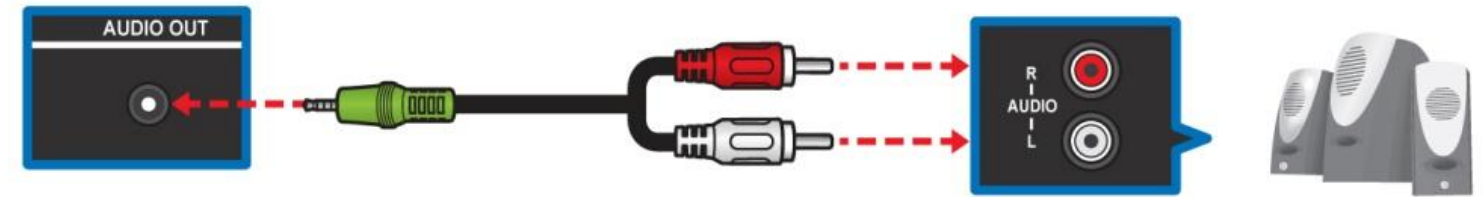

Digital connection

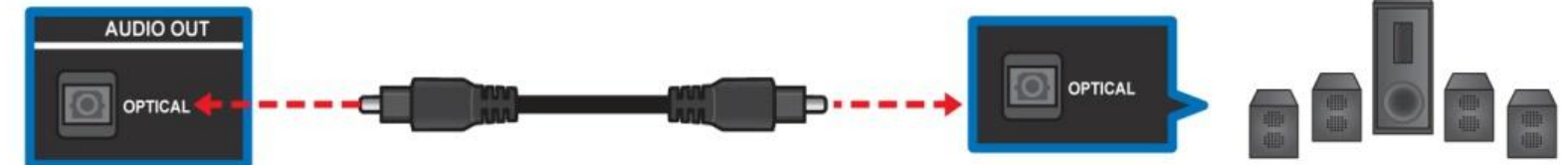

Making A/V Connections

Connect to HD Devices (Bluray Player, Cable or Satellite, Game Console)

HDMI



Component

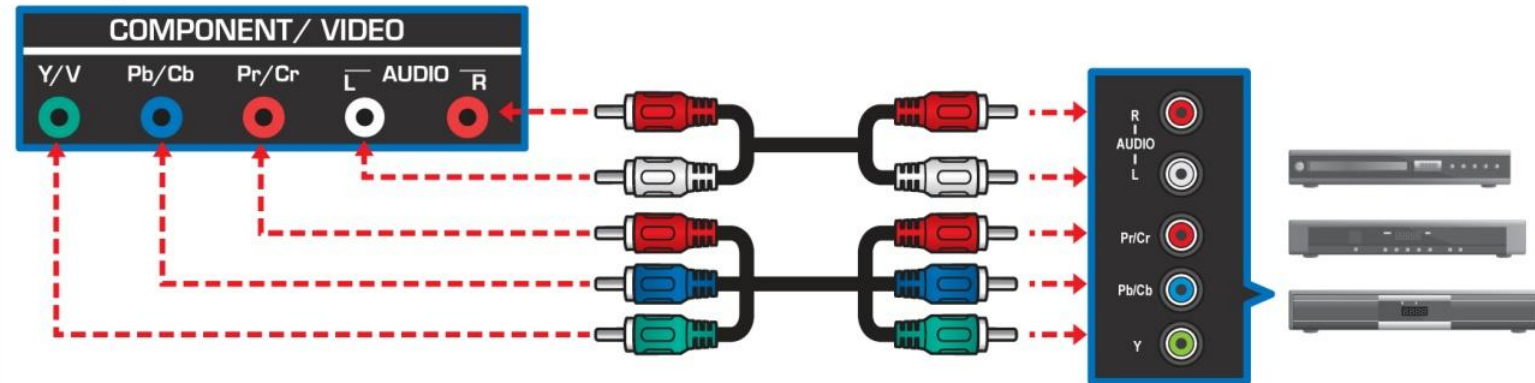

Composite

*Please Note, the Composite video input is shared with the component.

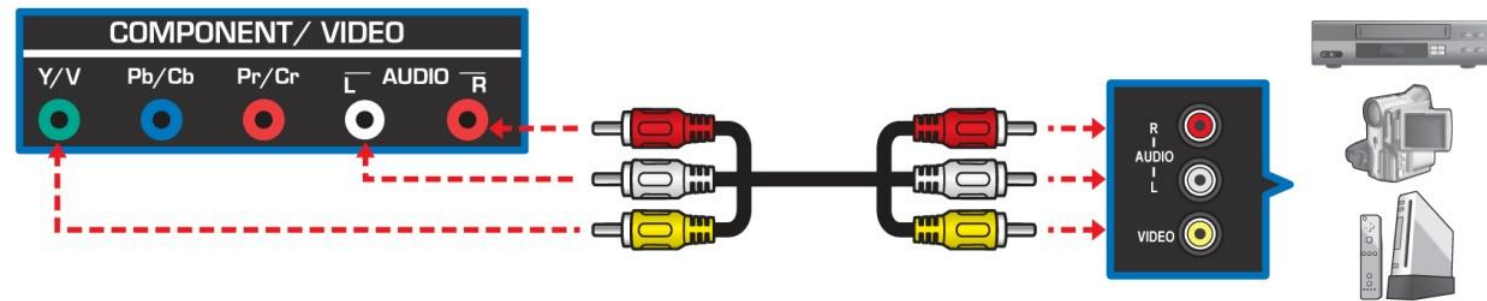

Connect to External Music Players

Music Port

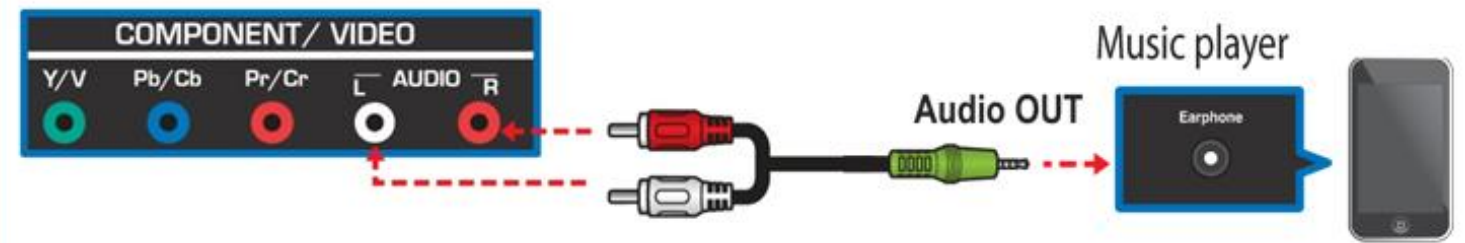

Connecting To The Internet

The TV comes equipped with several pre-loaded Internet applications via a built-in functionality called I.C.E.[™], or Internet Connected Experience. To access the pre-loaded I.C.E.[™] applications, the TV must be connected to the home network. This can be accomplished in two ways:

- Hard-Wired Ethernet Connection
- Wireless Connection

Making a Hard-Wired Ethernet Connection

To connect your TV to your home network:

1. Connect one end of a CAT 5 Ethernet cable to your home network's Ethernet drop box.
2. Connect other end of cable to the Ethernet connector jack at rear of TV.
3. Follow the instructions on the Network portion of the One Time Setup Wizard in the Basic Operations section.

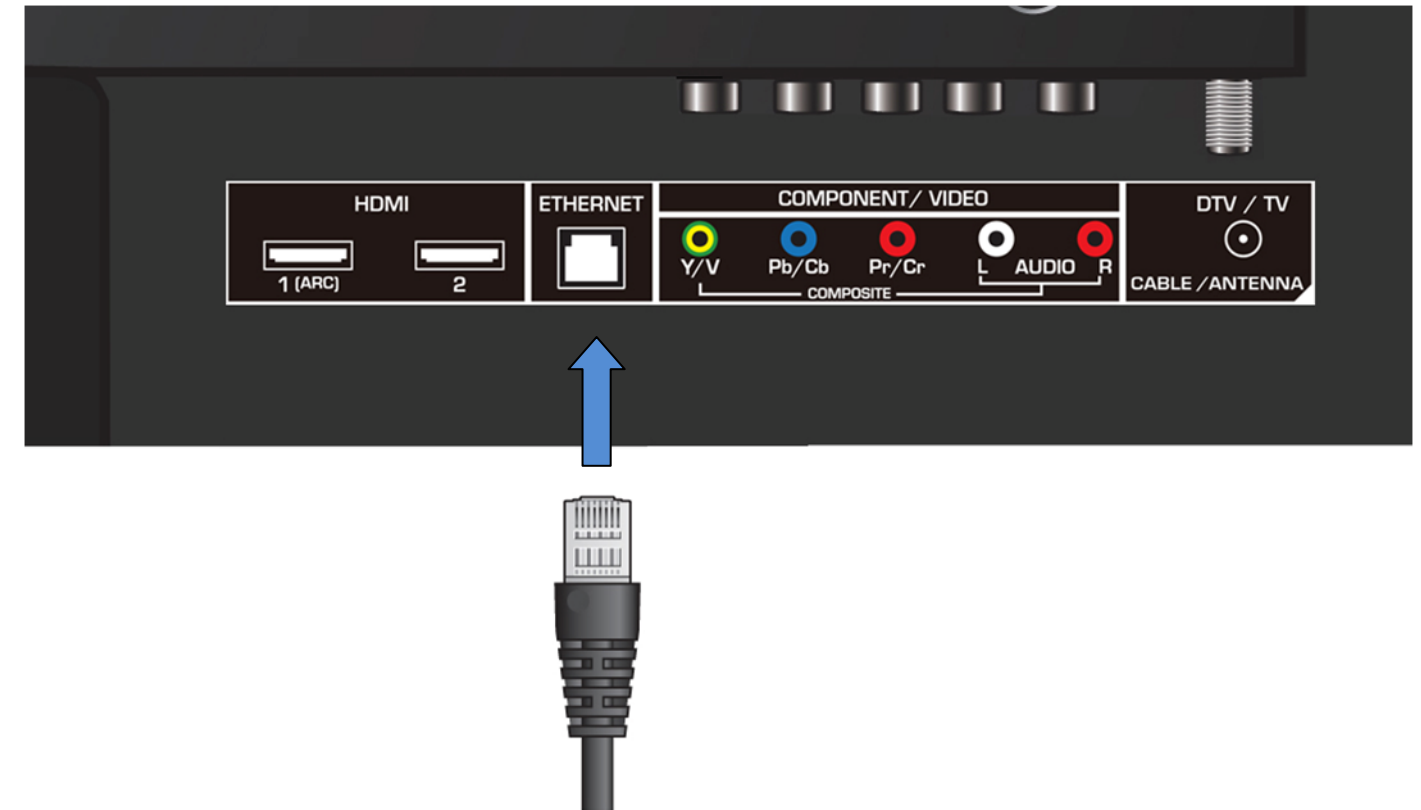

Connecting To The Internet

Wireless Connection

To connect your TV to your home network via a wireless connection, follow the instructions on the Network portion of the One Time Setup Wizard in the Basic Operations section, or on remote, press **MENU** -> choose **NETWORK**, then choose a wireless network and enter security key

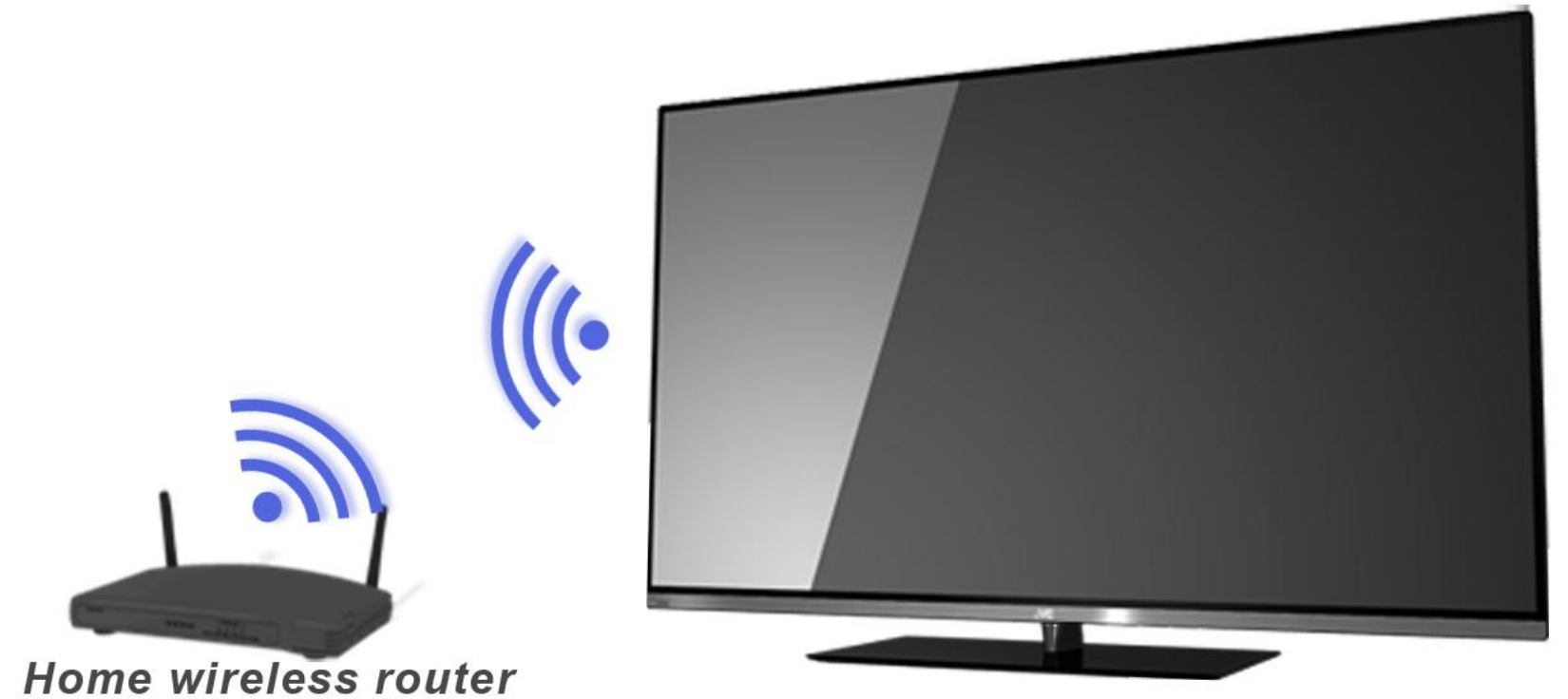

One Time Setup Wizard

Setup Wizard

When the TV is turned on for the first time, a one-time setup wizard is displayed to assist you in setting up your TV.

Note: You could run Setup Wizard anytime by press **MENU** button, choose **SETUP** and then **Setup Wizard**

General Settings

Make sure batteries is inserted to remote and follows on-screen instruction to select, **Language**, **TV Mode**, **Time Zone** and **Daylight Saving** selections



Network Settings

When you see **Network Setting** screen, plug in Ethernet cable for wired connection or make sure wireless router is turned on, then choose **YES** to begin

Network Setting

Before the network setup, Please plug in Ethernet cable to TV, or make sure wireless router is on. Would you like to setup the network now?

For **Wired connection**, the TV will automatically detect the connection and you will see below screen

Network Setting

Wired network setting.

Network Status : Connected

One Time Setup Wizard

For **Wireless Connection**, the TV will show a list of available networks, use remote to choose your home network, press **OK** and key in security password by using remote QWERTY keypad

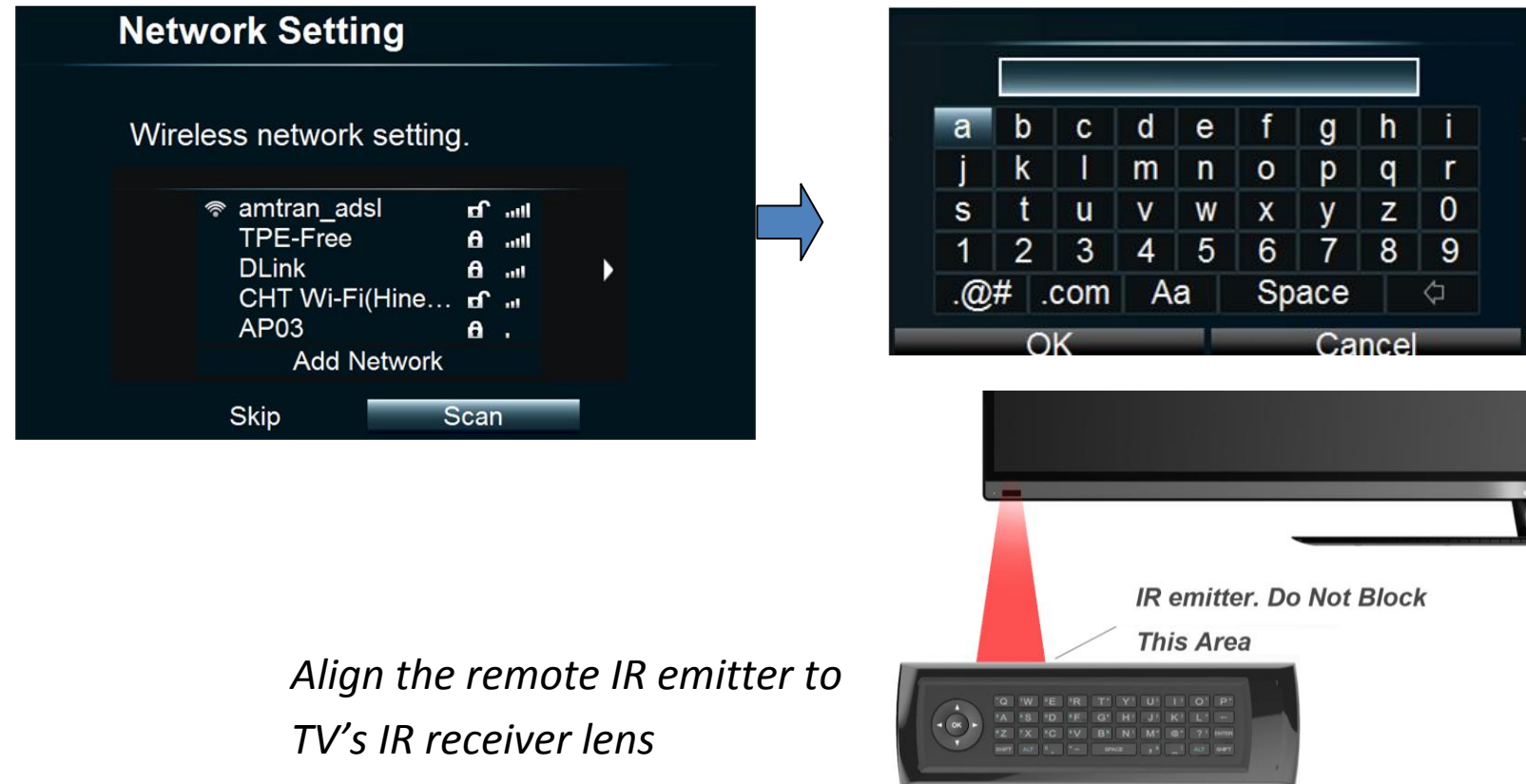

Align the remote IR emitter to TV's IR receiver lens

Auto Channels Scan

Ensure Antenna or Cable TV input cable is connected to **DTV / TV** jack, choose **Start Scan** to begin.

Note: Channels scanning may take a few minutes

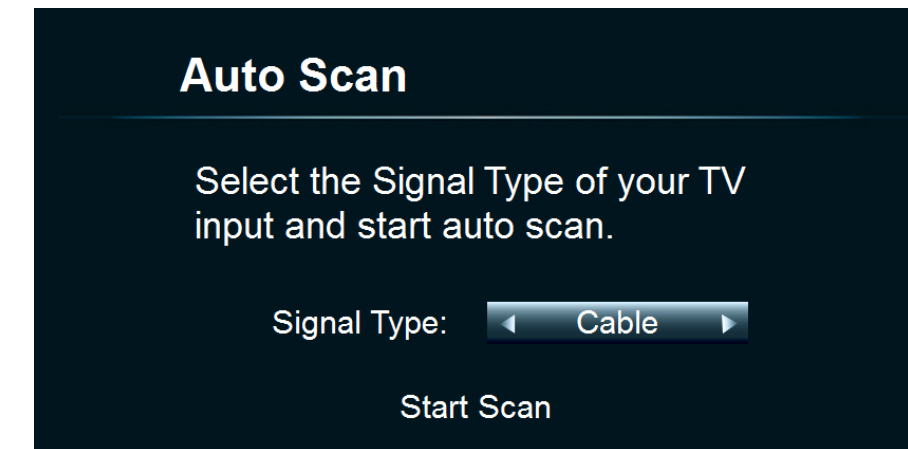

On **Finish** screen, press **OK** button to save and exit the **Setup Wizard**

I.C.E™ Apps & Multimedia

ICE Apps and Multimedia Operations

The TV equipped with I.C.E™ (Internet Connected Experience) platform which provides connectivity to popular internet content streaming services.

Note: To access any of the pre-loaded ICE applications, make sure the TV is connected to the Internet.

On the remote, press the **ICE Apps** button to display the ICE applications screen.

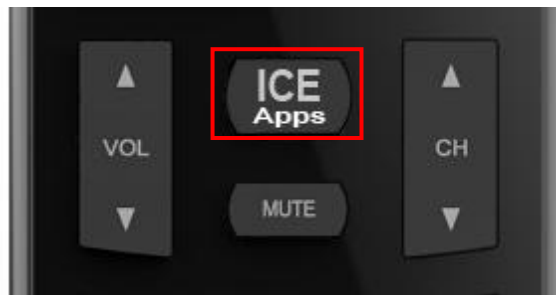

Use the left and right direction buttons to bring the desired app icon to the middle of the screen, and then press the **OK** button to select the application. Follow the instruction on screen to setup* each application.



To exit an application, press the **Exit** button on remote.

New ICE Apps Update:

With internet connection setup, the TV will periodically look for new ICE Apps, as well as other TV software update, available in server. The TV will automatically download newest ICE apps and software update.

NOTE:

- ICE apps are software provided by the content provider. You may need to sign up or use an existing account to use the selected ICE apps.
- Some apps are free, but some may charge monthly fee or pay-per-view fee. Read through the service terms for each app. Contact the content provider for any question regarding their service.
- All Apps are subject to change without notice

I.C.E™ Apps & Multimedia

USB Multimedia control



To playback multimedia content in USB flash memory, plug in your USB flash memory to the TV USB port, press **MULTIMEDIA** button on remote, or press **ICE App** button and choose multimedia icon

Note:

- The TV is capable of photos, music and video playback. However, due to the wide variety of multimedia file formats. Some formats may not be supported.
- It is recommended to use USB flash memory ONLY. USB external hard disk drive (HDD) is not supported due to its higher power consumption

TV Operation – TV Channels

Changing the Channel

On the remote control, use the number keys to select a channel.

NOTE: When a channel is selected with the number keys, there will be a short delay before the TV changes the channel. To change the channel immediately, press OK after selecting a channel.

Browsing Channels

To increase or decrease the channel:

- 1 On the remote control, press button
- 2 At rear of TV, press the **CHANNEL UP** or **CHANNEL DOWN** buttons

Selecting Analog Channels

1~9 Press 1~9 as needed. For example: to select channel 2, press 2, then press OK.

10~99 Press the 2 digits in order. For example: to select channel 15, press 1, 5, and then press OK.

100~135 Press the 3 digits in order. For example: to select channel 130, press 1, 3, 0, and then press OK.

Selecting Digital Channels

Press the first two or three digits, press the – button, and then press the remaining digit(s). For example: to select channel 15-1, press 1, 5, -, 1, and then press OK.

TV Operation – TV Channels

Selecting by Channel List

All channels with network signal are listed on the Channel List screen. You can select channels from this screen.

- 1 Press OK to display Channel List screen.
- 2 Press up or down direction buttons to select a channel number, and then press OK.
- 3 Press Exit to close Channel List screen.

Mute

Press the **Mute** button to turn off the sound. To turn on the sound, press the **Mute** button again.

Setting the Sleep Timer

Use the Sleep timer to automatically turn off the TV after a preset amount of time has elapsed.

- 1 Press Sleep button to display Sleep Timer screen.
- 2 Press Sleep button repeatedly, or use up and down direction buttons to select desired sleep time, and then press OK.

To cancel sleep mode, select Timer Off on Sleep Timer screen, and then press OK.

TV Operation – Aspect Ratio

Set Aspect Ratio

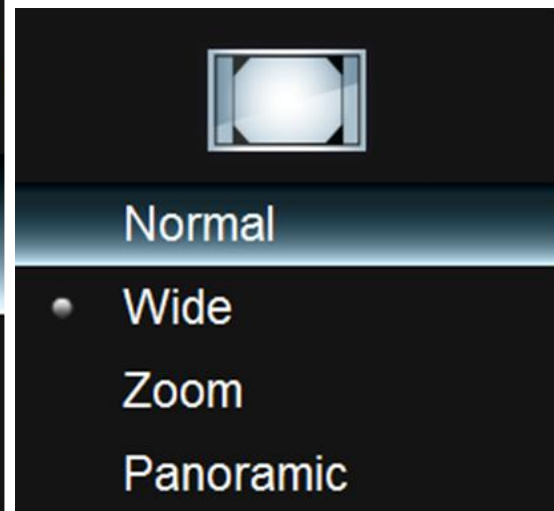
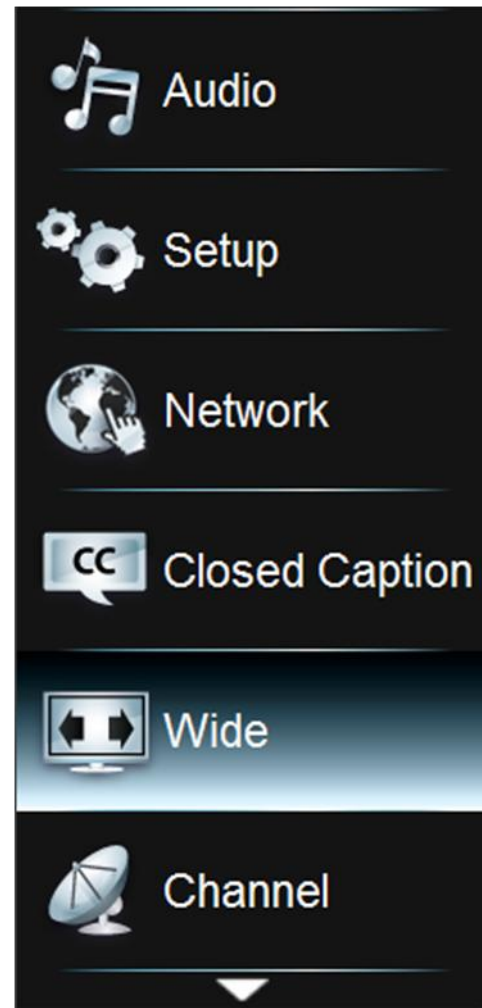

Display aspect allows users to adjust viewing aspect ratio. To access

- Press **Wide** button to display Screen Mode display, or
- Press **MENU**, then choose **Wide**

Normal

When watching a 4:3 content, the TV displays a standard picture with black side bars.

When viewing a 16:9 content, it displays a full picture.

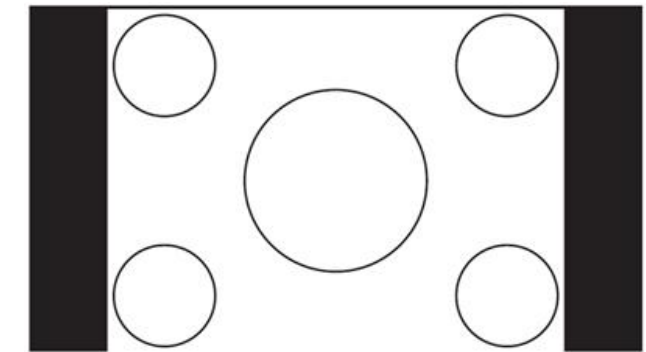

Wide

Applying to 4:3 content, the picture is stretched horizontally to fill the width of the screen.

Applying to 16:9 content, the image is slightly overscanned.

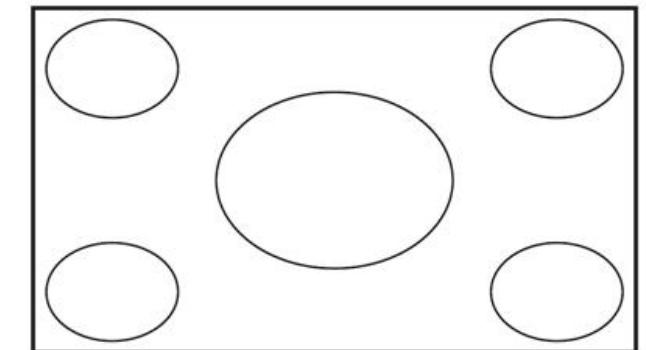

TV Operation – Aspect Ratio

Zoom

The entire picture is uniformly enlarged to retain its original proportion. However, some parts of the picture may be hidden.

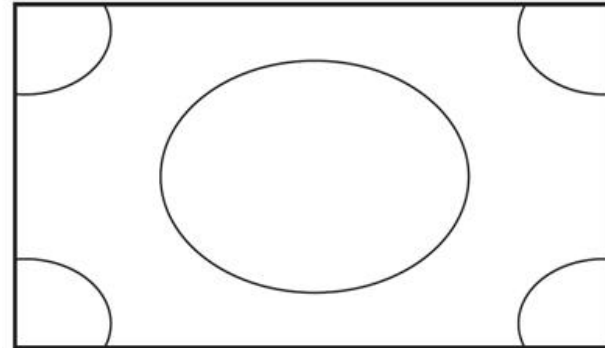

Stretch

The picture is stretched horizontally on the left and right sides. Only available in 16:9 content.

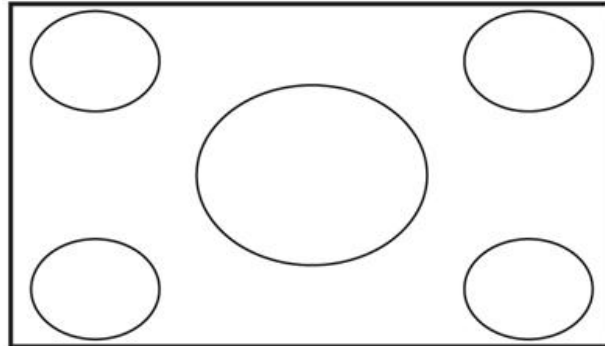

Panoramic

The picture is stretched horizontally on the left and right sides to fill the width of the screen. The center of the picture is not stretched.

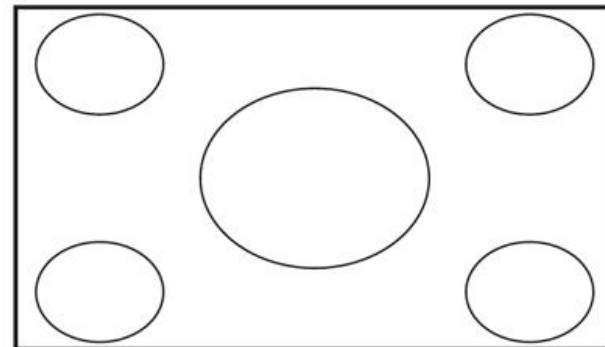

Notes:

- Panoramic mode is only available on 4:3 contents.
- Stretch is only available in 16:9 contents.

TV Operation – Input Sources

Selecting the Input Source

The TV provides various ways to select the input source:

At rear of TV

Press **INPUT** button repeatedly to scroll through the input source options. The highlighted input source is selected after a few seconds.

Using the Remote Control

Press **INPUT** button on remote repeatedly to scroll through input source options, and then press OK button to select desired input source.

Connecting Music

The TV supports music playback from portable music players such as iPods and various MP3 players.

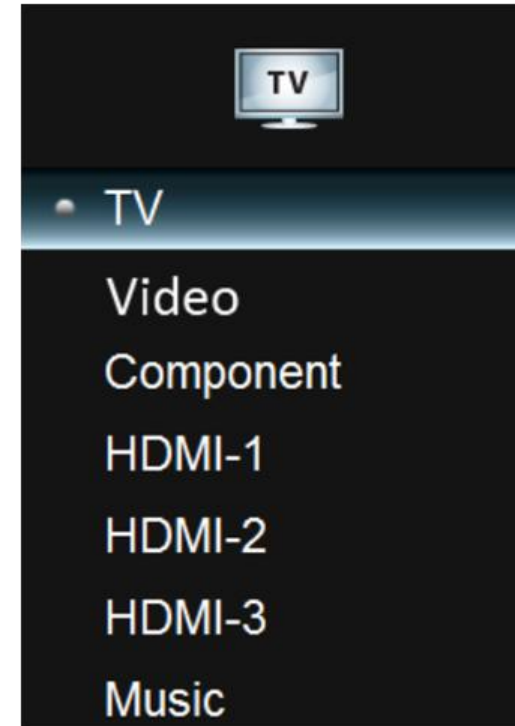

Connect one end of an audio cable to TV Component Audio In jacks and the other end to the music player's Audio Out or headphone jack

Press **INPUT** button and select **MUSIC**

Audio Only Mode

While playing music, you can set the TV to Audio Only mode to turn off the TV display and save power.

- 1 Press **AUDIO ONLY** button on remote to activate this function. The TV screen will be turned off.
- 2 You could exit Audio Only mode by pressing any button.

Advanced TV Settings – Video Menu

Accessing TV Menu

	Remote Control	TV Panel
Display the menu	Press MENU button	Press MENU button
Select a TV Setting	Press up or down to select a TV Setting. Press OK to confirm your TV Setting selection.	Press CH+ or CH- buttons to select a TV Setting. Press INPUT button to confirm your TV Setting selection.
Select and Adjust a TV Setting Option	Press up or down to select a TV Setting Option. Press left or right to adjust the setting. Press OK to apply the adjustment.	Press CH+ or CH- buttons to select a TV Setting Option. Press VOL+ or VOL- buttons to adjust the setting. Press INPUT button to apply the adjustment.
Exit the Menu	Press EXIT button.	Press MENU button.

Picture Menu

Adjust picture options such as brightness, contrast, and advanced picture settings.

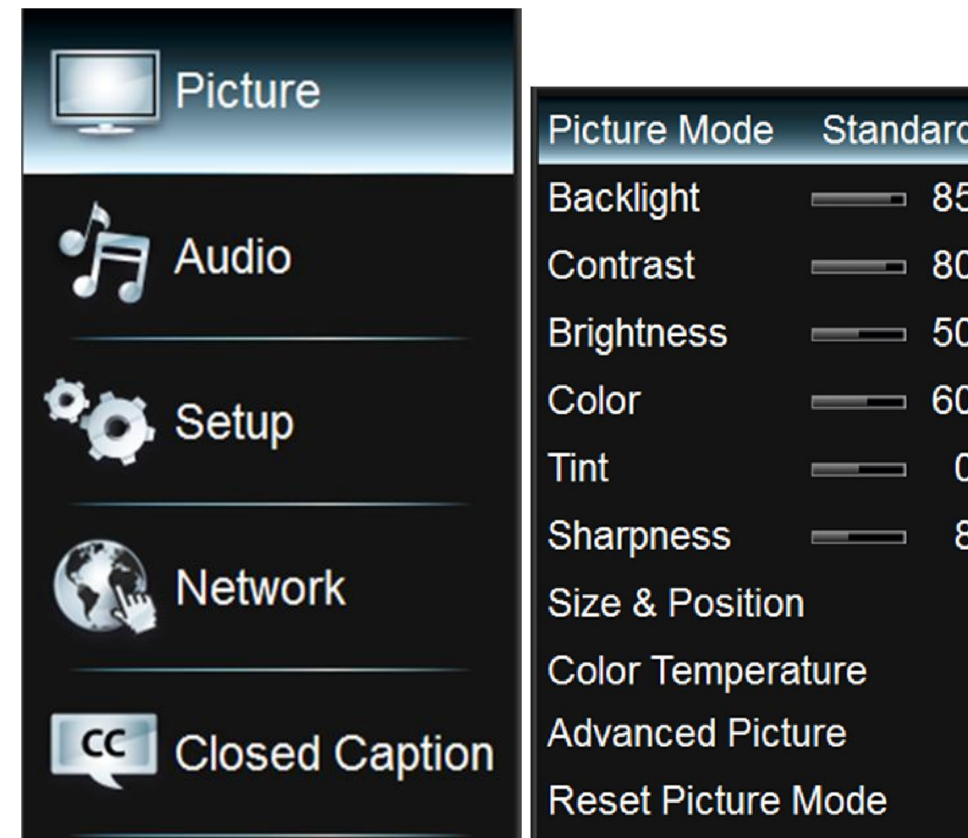

Advanced TV Settings – Video Menu

Picture Mode Selections

Select the picture mode.

Standard	For standard picture settings
Movie	For motion pictures such as movies
Game	For fast and dynamic pictures suitable with playing games.
Vivid	For bright and vivid picture setting.
Sport	Suggested settings for sporting events.
Custom	For custom picture settings.

Backlight: Adjust the backlight that affects the overall brilliance of the picture (0~100).

Contrast: Adjust the white level in the picture. Low contrast makes pictures look dark. High contrast makes pictures washed out (0~100).

Brightness: Adjust the brightness setting (0~100).

Color: Adjust the amount of color level in the picture (0~100).

Tint: Adjust the picture hue (-50~50).

Sharpness: Adjust the sharpness of the edges of elements in the picture.

Size & Position

Horiz. Position / Vertical Position	Adjust the horizontal / vertical position of the picture.
Horizontal Size / Vertical Size	Adjust the horizontal / vertical size of the picture.

Color Temperature

Color Temperature	Apply a preset color temperature setting (Custom / Cool / Natural / Warm)
Red / Green / Blue Gain	Adjust the red / green / blue gain settings according to your preference.

Advanced TV Settings – Video Menu

Red / Green / Blue Offset

Adjust the red / green / blue offset settings according to your preference.

Reset Picture Mode: Reset the picture mode settings to factory defaults.

CrystalColor™	Off
Dynamic Contrast	Off
Local Dimming	Off
Noise Reduction	Off
Digital NR	Off
Film Mode	Off

Advanced Settings

Crystal Color	Crystal Color™ produces more vivid and crisp color pictures (Off / Normal / Rich).
Dynamic Contrast	Dynamic contrast automatically enhances the image for greater picture details (Off / Low / Medium / High).
Local Dimming	Local area backlight dimming based on video contents (Off / On)
Noise Reduction	Reduce the noise level (Off / Low / Medium / High).
Digital NR	Reduce noise level of digital signals (Off / Low / Medium / High).
Film Mode	Produce smoother motion pictures when viewing movies from video players connected via HDMI (Off / Auto).

Advanced TV Settings – Audio Menu

Audio Menu

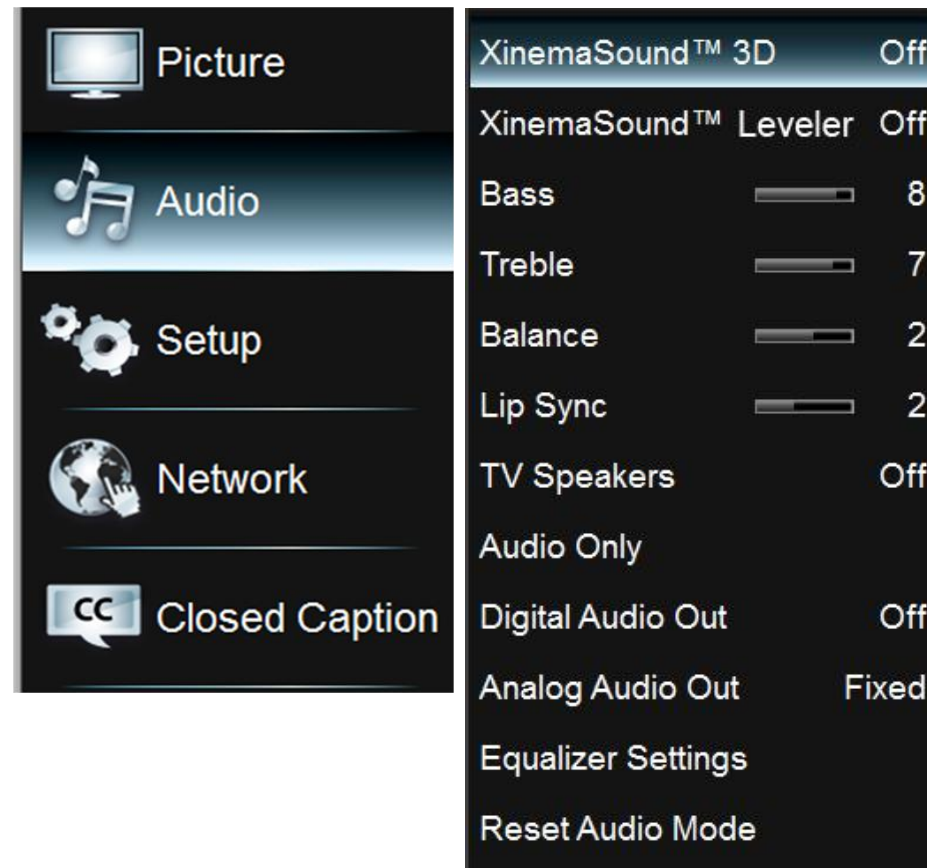

XinemaSound™ 3D:

Expansive and immersive, multi-dimensional surround sound experience.

*When XinemaSound™ 3D is on, **Bass, Treble and Equalizer Settings** functions will not be available for adjustment*

XinemaSound™ Leveler:

Delivers smooth, steady volume levels from the quietest sound to the loudest volume with exceptional audio clarity.

Bass & Treble: Adjust the bass level to your preference (-12~12).

Balance: Adjust the audio level of the L/R channels of the speakers to your preference (-10~10).

Lip Sync: Adjust to match the movements and the lips of the person talking on the screen (0~5).

TV Speakers: Turn the internal speakers on or off.

Digital Audio Out: Select the type of digital audio output (Off / Dolby Digital / PCM).

Analog Audio Out: Select the type of analog audio output (Fixed / Variable)

Equalizer Settings: Adjust the equalizer settings (120Hz / 500Hz / 1.5KHz / 5KHz / 10KHz)

Reset Audio Mode: Reset the audio mode settings to default settings.

Advanced TV Settings – Setup Menu

Setup Menu

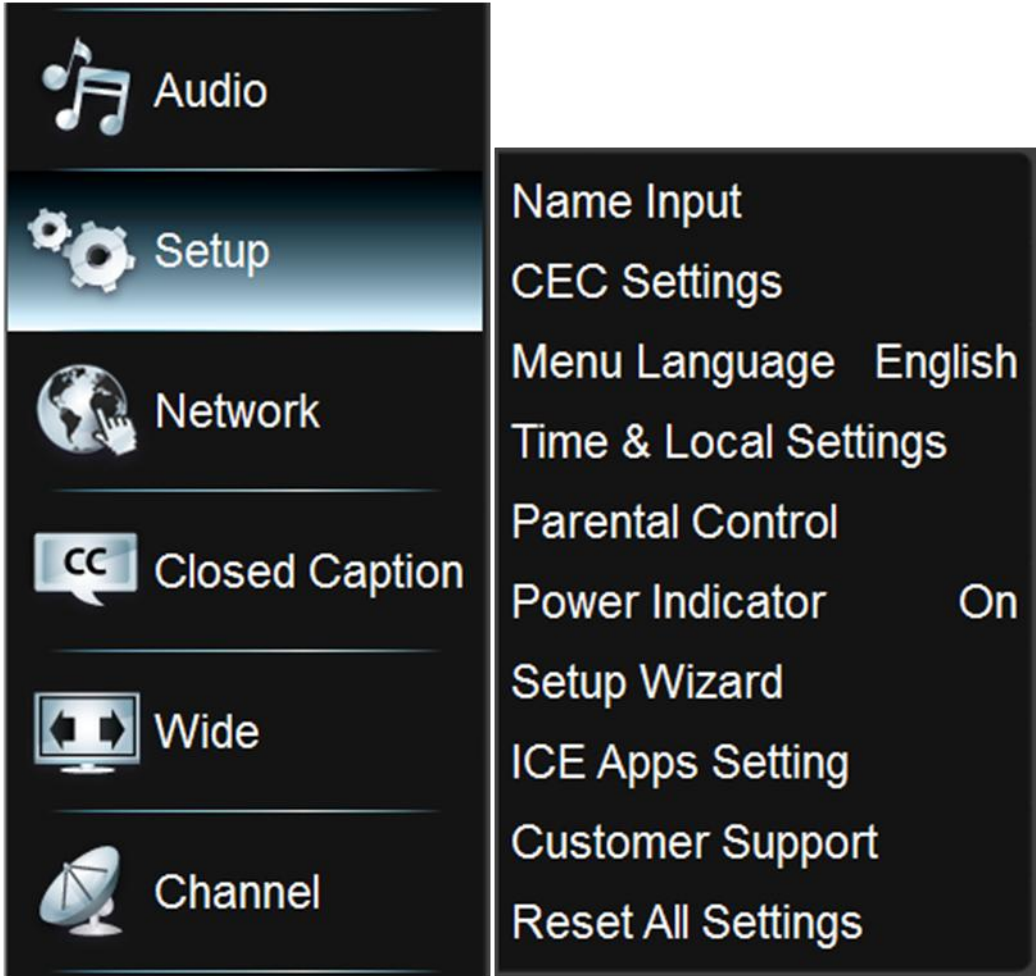

CEC Settings: CEC allows you to control devices using your TV remote control when the CEC devices are connected via HDMI.

CEC Function	Enable or disable the CEC function.
System Audio Control	Enable or disable system audio control (ARC, Audio Return Channel on HDMI-1).
Device Discovery	Select to view CEC devices

Menu Language: Select the on-screen menu language.

Time Settings

Time Zone	Select a location to apply the time zone.
Daylight Savings	Enable or disable daylight savings time.

Power Indicator: Turn On or Off the TV power indicator LED

Advanced TV Settings – Setup Menu

Name Input

The Name Input feature allows you to add a label name on an input source.

1. Press **MENU**, select **Setup** and Press **OK** on **Input Source** to select which input from the list that you want to name
2. Then, press **OK** on **Input Labels** to select from a list, or choose **CUSTOM** on the list, then press **OK** on the box below Custom to type in a desired name

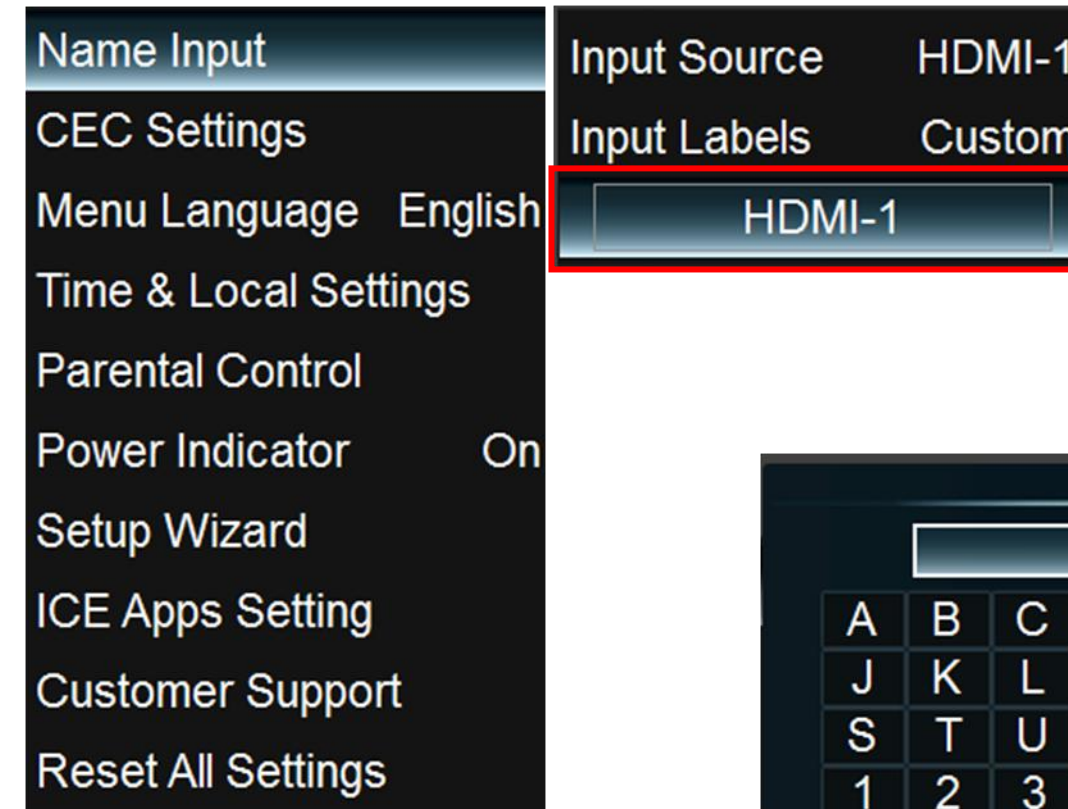

Advanced TV Settings – Setup Menu

Parental Control

The Parental Control feature allows you to control and restrict children from viewing or hearing violent scenes by Channel Lock, TV Rating, or Movie Rating.

Access Parental Control Menu by

1. Switch **Input** to **TV**
2. Press **MENU**, Select **Setup**, Choose **Parental Control**
3. Enter password (Default password is “0 0 0 0”), and select the blocking options

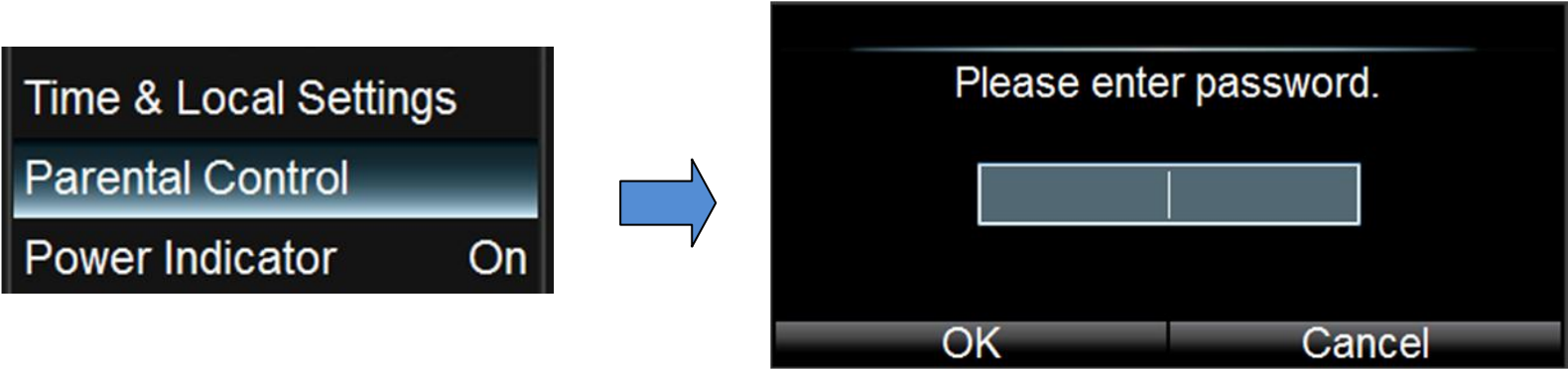

Parental control options:

Enable Rating: To turn **On** or **Off** the Parental Control

Channel Lock: To block by TV Channel

USA-TV: To block by TV rating

USA-Movie: To block by MPAA rating

CAN-English: To Block by Canadian English Channel rating

CAN-French: To Block by Canadian French Channel rating

Block Unrated Shows: On to block all programs without rating

Select desired rating, press **OK** to block (🔒) or unblock the channel or rating

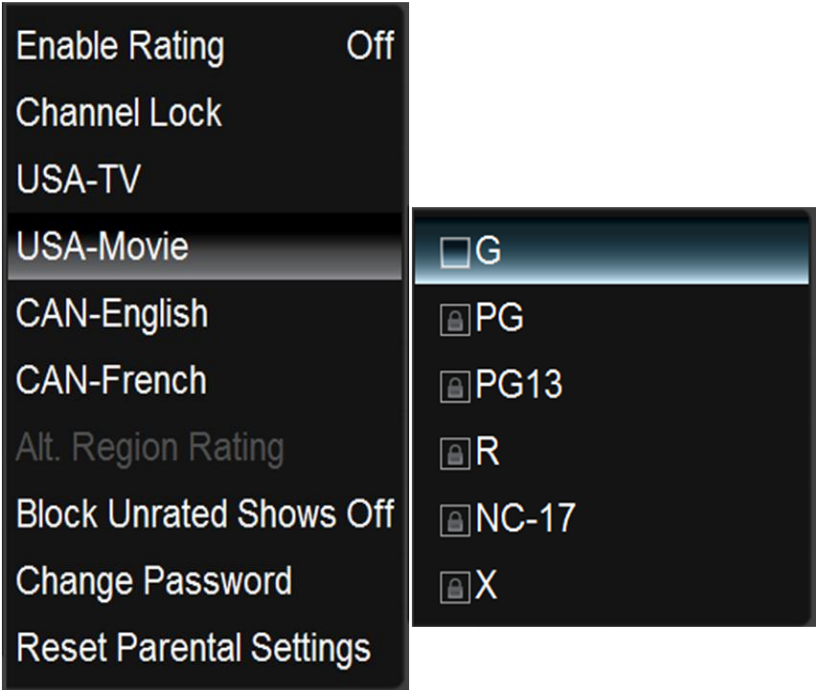

Advanced TV Settings –Setup Menu

Power Indicator: to turn **ON** or **OFF** the power indicator LED at the TV lower left hand corner when the TV is on

Setup Wizard: to run the step by step **Setup Wizard**

ICE Apps Setting: to deactivate **Netflix** and **VUDU** ICE apps

Customer Support: choose to view **TV System Information, User Manual,** and **JVC Customer Service** contact information

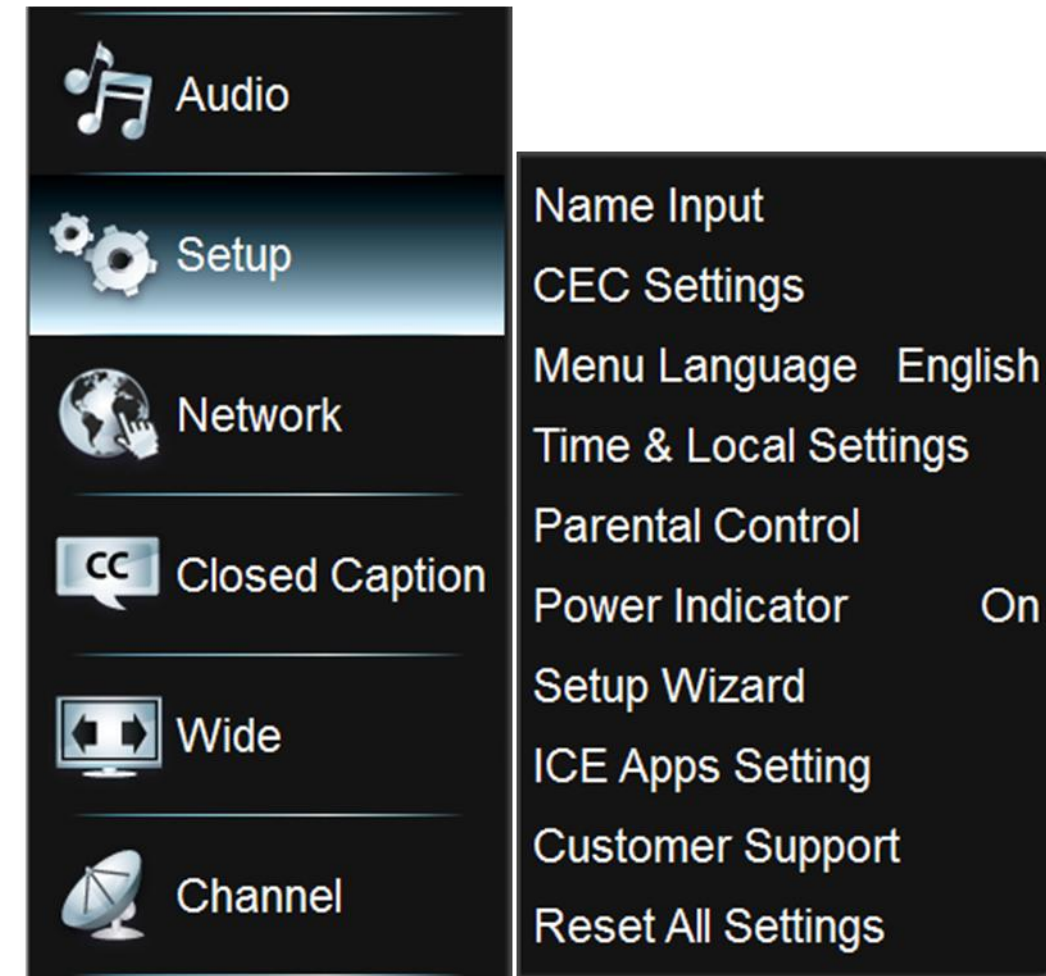

Advanced TV Settings – Network Configuration

Network Menu



To access Network Menu, Press **Menu** and then Choose **Network**

Wireless Network List

If wired network (via Ethernet cable) is not available to the TV, the TV will automatically scan and show all available wireless networks in the area.

 *icon Indicates current connected wireless network.*

To connect a different network, choose the desired network and press **OK**, then enter **Network Security Key**

Add Network:

To manually enter hidden network's SSID

Advanced TV Settings – Network Configuration

Manual Setup

Choose to manually setup Static IP information

Note: Manual Setup is only for advanced users and network where the network client devices need specific setting to access the network.

Test Connection

Choose to test and view connection status

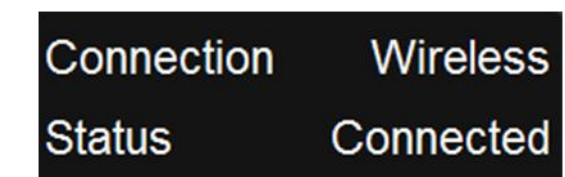
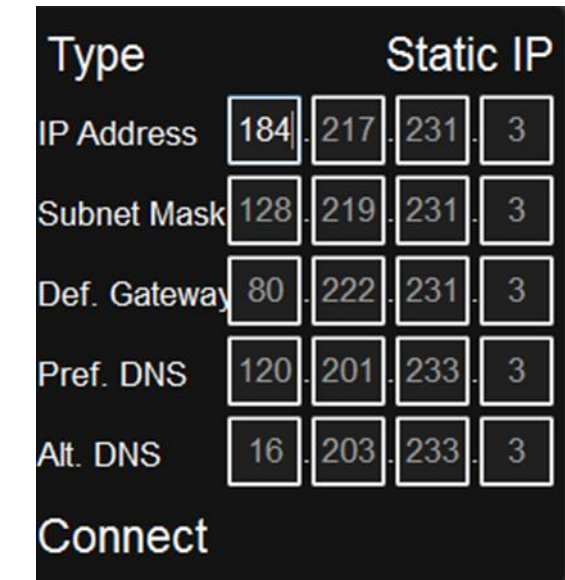
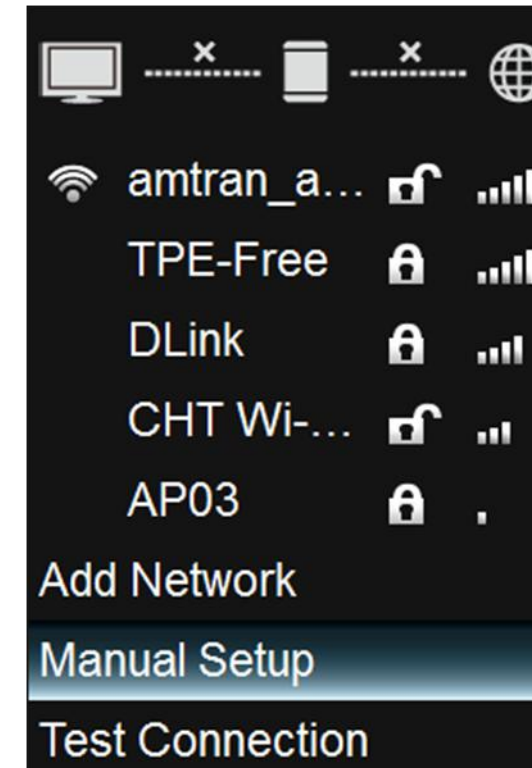

Advanced TV Settings – Closed Caption

Closed Caption Menu

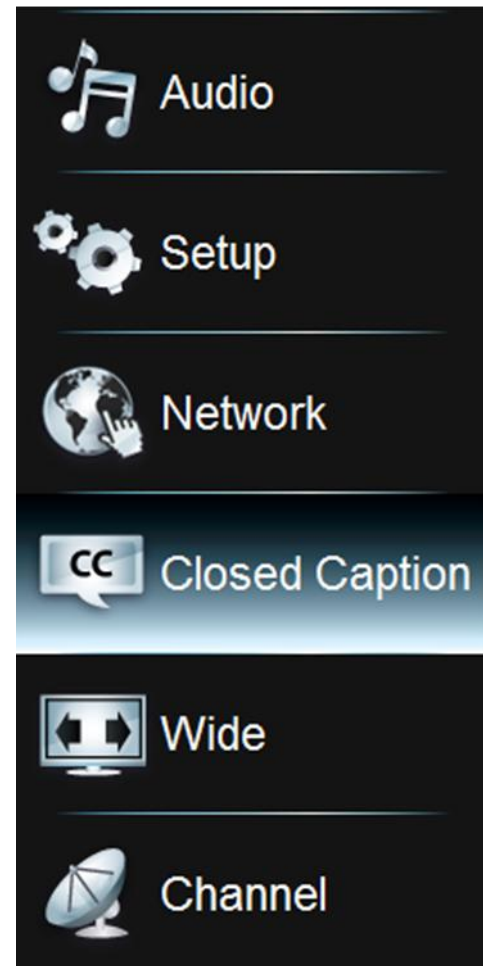

Analog Closed Caption CC1
Digital Closed Caption CC2
Digial CC Option

The Closed Caption Menu allow users to turn **ON** or **OFF** the programs closed caption. To access, press **MENU**, then choose **Closed Caption**

Note: Availability of Closed Caption service is dependent on video contents.

Analog Closed Caption:

Select desired closed caption service for analog video contents, including analog NTSC broadcast and video via Composite inputs

Digital Closed Caption:

Select desired closed caption service for digital video contents, including digital ATSC broadcast and video via HDMI inputs

Digital CC Option:

To select closed caption display options including font size, text color, background color/opacity.

Advanced TV Settings – Channel Management

Channel Setting Menu

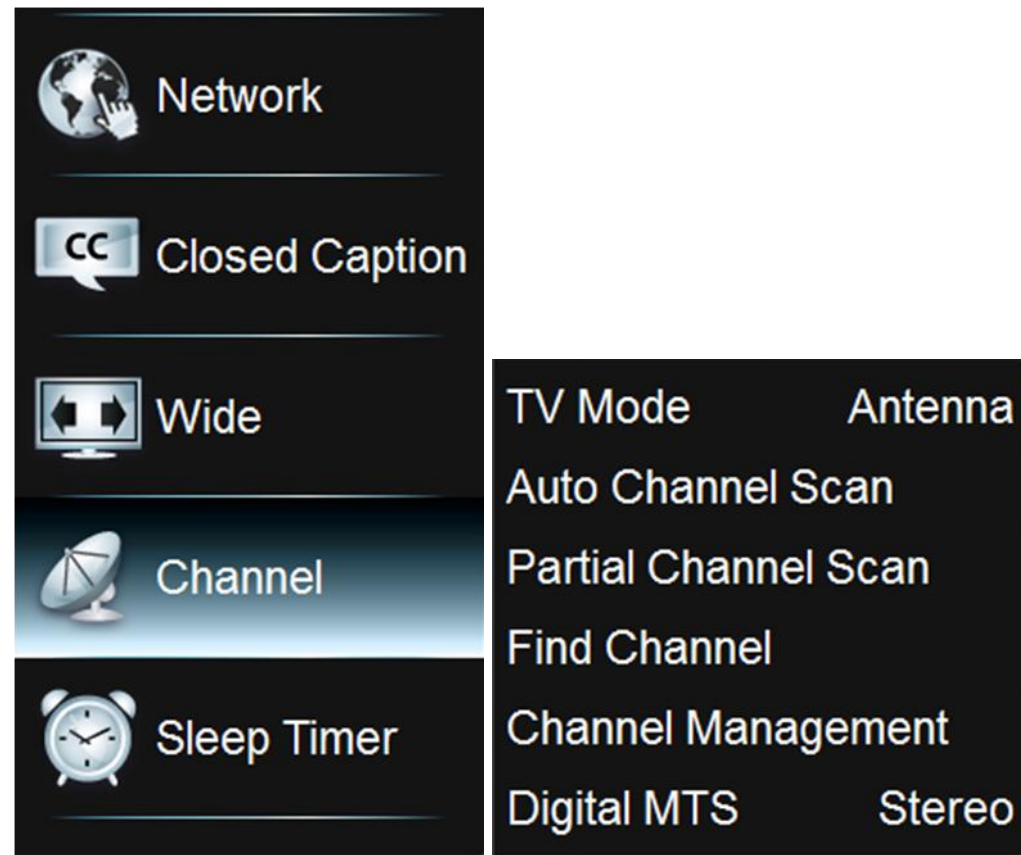

Channel Setting allows you to manage the channels available to TV via antenna jack. To access, press **MENU**, then choose **Chanel**

TV Mode – Select between **TV** (broadcast) or **Cable**

Auto Channel Scan – Select to scan all analog and digital channels

Partial Channel Scan – Select to scan a user specific channels range

Find Channel – Select to find a specific channel and add to the channel list

Channel Management – Select to mark channels as favorite channel () which can be accessed by **FAV.CH** button on remote) or remove () channels from channel list by press **OK**

Digital MTS – Select available MTS (Multichannel Television Sound) audio channel from a MTS encoded TV program

Advanced TV Settings – Sleep Timer

Sleep Timer Setting

Select a sleep timer option where the TV automatically turns off after the selected preset time (Off / 30 minutes / 60 minutes / 90 minutes / 120 minutes / 180 minutes).

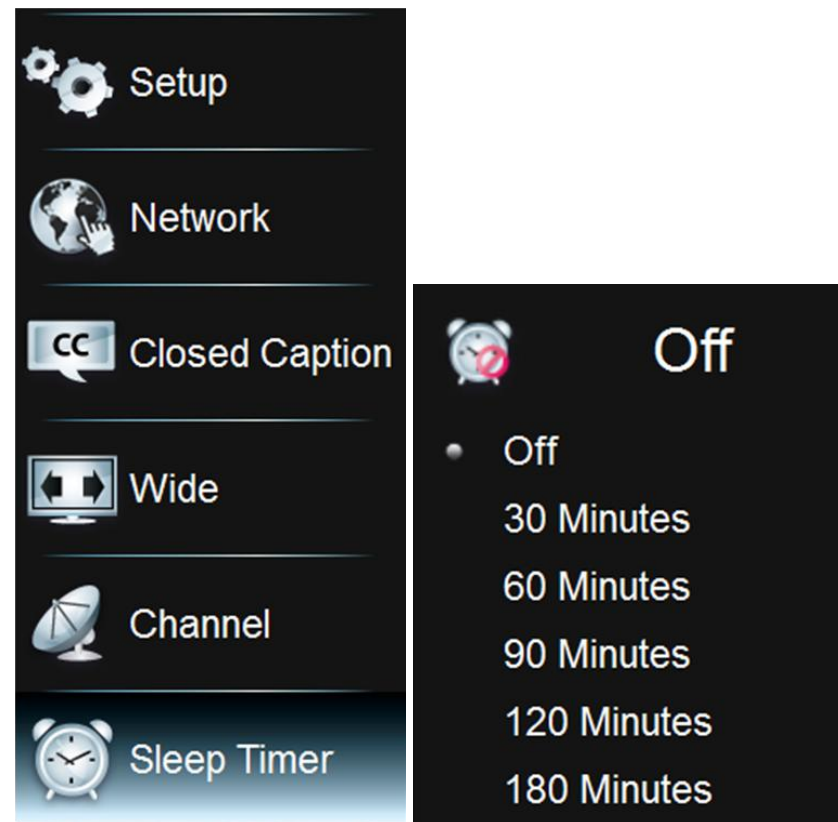

Troubleshooting

If your TV fails to work properly, check the following guidelines for possible causes and solutions. Consult with your local dealer or service outlet if problems persist.

Problem	Solution
No Power	<ul style="list-style-type: none">● Make sure the power cord is plugged in.● The power is off; press Power button to turn on the TV.● Try another outlet.● Unplug the unit for an hour, and then plug it back in.
Poor or No Sound	<ul style="list-style-type: none">● Press the VOL Up button on the remote control or the VOL+ button on the TV.● Press MUTE button on the remote control to ensure mute is not on.● The channel or cable TV broadcast is experiencing problems. Tune to another channel.● Check the TV audio settings.● Check for possible sources of interference.
Poor or No Picture	<ul style="list-style-type: none">● The channel or cable TV is experiencing problems. Tune to another channel.● Make sure that channels are set into memory.● Check the antenna or cable TV connections.

Troubleshooting

	<ul style="list-style-type: none">• Check for possible sources of interference.
Poor Reception on Some Channels	<ul style="list-style-type: none">• The channel or cable TV broadcast is experiencing problems. Tune to another channel.• Make sure that channels are set into memory• The network signal is weak. Adjust the antenna to receive a better reception• Check for possible sources of interference.
The Remote Control does not work	<ul style="list-style-type: none">• Batteries may be weak, dead, or inserted incorrectly.• Point the remote control directly at the IR sensor on the TV with an angle of 35 degrees.• Remove any obstacles between the remote control and the TV.• Remote control is out of range. Move closer to the TV.
TV Shuts Off	<ul style="list-style-type: none">• Sleep timer is set.• Power is interrupted.
No CATV Reception	<ul style="list-style-type: none">• Check all cable TV connections.• Set the TV Mode in Channel menu.
Closed Caption is not activated	<ul style="list-style-type: none">• The channel/program is not a closed caption broadcast. Try another channel.• Enable Closed Caption in the Menu.

Troubleshooting

No Internet Access (Hard Line)

- Check the Ethernet cable. Try unplug and plug again
- Check home router or network switches, make sure they are turned on
- On TV menu, choose **NETWORK > MANUAL SETUP**. Make sure **DHCP** is chosen in **TYPE**
- On TV menu, choose **NETWORK > TEST CONNECTION**. If Status shows **Connected**, the TV has connected properly with the router or gateway. Please consult your internet service provider for possible internet outage in your area
- Try if you can access internet with PC or other devices through the same router or network switches

Troubleshooting

No Internet Access (Wireless)

- Make sure home wireless router is turned on
- Make sure your wireless router is not set to hide wireless network SSID
- Make sure you entered your home wireless network security key correctly
- On TV menu, choose **NETWORK** and press **OK**. The TV will scan and show available wireless network
 - If you see your home network SSID, choose it and enter password
 - If you don't see your home network SSID, Try reboot the wireless router
- On TV menu, choose **NETWORK > TEST CONNECTION**. If Status shows **Connected**, the TV has connected properly with wireless router. Please consult your internet service provider for possible internet outage in your area
- Try if you can access internet with PC or other devices through the same wireless router

Specifications

Specification	50" SP50M-C	55" SP55M-C
Size Class (Diagonal)	50" (50.5 diagonal)	55" (54.6 diagonal)
Resolution/Aspect	1920 x 1080 / 16:9	
Backlit	Edge LED	
Frame Rate	120Hz CrystalMotion™	
Contrast Ratio	20M:1 (Dynamic)	
3D		
3D Capability	No	
Internet		
Internet Capability	Yes, I.C.E.™ platform	
Wireless Connectivity	Built-in, WiFi 802.11n Single Band	
Preloaded Internet Apps	ICE apps™: Netflix, Vudu, Pandora,	
TV Features		
Color Enhancement	Yes, CrystalColor™	
Built-in NTSC/ ATSC/ Clear QAM tuner	Yes	
PIP/POP	No	
Close Caption	Yes	

Audio		
Audio Technology	XinemaSound 3D™, Dolby Digital Decode	
Graphic Equalizer	Yes	
Speaker Output Power	20W (10Wx2)	30W (15Wx2)
Convenience Features		
Interactive Setup Guide	Yes	
Input Port Naming	Yes	
Audio Only Mode	Yes	
Gaming Mode	No	
HDMI-ARC	Yes, HDMI - 1	
HDMI-CEC	Yes	
USB Multimedia	Picture, Music, Video	
Remote	IR, with QWERTY Keypad	
Energy Saving Features		
Auto Power Off (DPMS)	Yes	
Energy Star	Yes	

Specifications

Input / Output		
Input	Antenna in	1
	HDMI	3
	Component	1
	Composite (RCA)	1 (shared with Component)
	Music port	1 (shared with Component Audio)
	USB	1
Output	Optical Digital Audio Out	1
	Stereo Audio Out	1
Mechanical		
Wall Mount Pattern	VESA (400x400mm), M8 screw	
Without Stand (approx.)	44.3" x 26.2" x 2", 34.87 lbs	48.9" x 28.9" x 2.2", 47.3 lbs
With Stand (approx.)	44.3" x 28.4" x 11", 40.7 lbs	48.9" x 30.9" x 10.6", 53.9 lbs
Power Consumption		
Input Voltage	120V AC	

CrystalMotion™ is a set of motion enhancement technologies including Motion-Estimation/ Motion-Compensation or Backlight Scanning or both

Supported Resolutions

Supported PC Timing (HDMI)	720 x 400 @ 70Hz
	640 x 480 @ 60, 75Hz
	800 x 600 @ 60, 75Hz
	1024 x 768 @ 60, 75Hz
	1280 x 1024 @ 75Hz
	1920 x 1080 @ 60Hz
Supported NTSC, Composite Timing	480i
Supported ATSC, Components, HDMI Video Timing	480i, 480p, 720p, 1080i, 1080 24p/60p

Limited Warranty

On Parts and Labor

This Limited Warranty covers units that are purchased as new and in the United States Only. This Product is manufactured, distributed, and warranted by AmTRAN Video Corporation (hereinafter known as "Warrantor") under brand license by JVC KENWOOD Corporation. The Warrantor provides a warranty to the original purchaser of a new Product against defects in materials and workmanship for a period of one (1) year of non-commercial usage and ninety (90) days of commercial use. If a Product covered by this warranty is determined to be defective within the warranty period, the Warrantor will either repair or replace the Product at its sole option and discretion.

To obtain warranty service, contact Technical Support:

Visit the Web Site: <http://go.jvc.com/HDTVSupport>

Or call our Customer Support and Service Center

1-855-868-1928

PRE-AUTHORIZATION MUST BE OBTAINED BEFORE SENDING ANY PRODUCT TO A DESIGNATED SERVICE CENTER. Proof of purchase in the form of a purchase receipt or copy thereof is required to show that a Product is within the warranty period.

Parts and Labor

There will be no charge for parts or labor during the warranty period. Replacement parts and Products may be new or recertified at the Warrantor's option and sole discretion. Replacement parts and Products are warranted for the remaining portion of the original warranty or for ninety (90) days from warranty service or replacement, whichever is longer.

Types of Service

Defective Products must be sent to the designated service center to obtain warranty service. The Warrantor is not responsible for the transportation costs to the service center, but will cover the costs for return shipping to the customer.

PRE-AUTHORIZATION IS REQUIRED BEFORE SENDING ANY PRODUCT TO A DESIGNATED SERVICE CENTER FOR WARRANTY SERVICE.

Product returned to designated service centers must either utilize the original carton box and shipping material or packaging that affords an equal degree of protection. Technical Support will provide instructions for packing and shipping the Product to the designated service center.

Limitations and Exclusions

The Warrantor's one-year limited warranty only covers defects in materials and workmanship. This warranty does not cover product issues caused by any other reason including, but not limited to, cosmetic damage, normal wear and tear, improper operation, improper voltage supply or power surges, signal issues, damages from shipping, acts of God, any type of customer misuse, modifications or adjustments, as well as installation and setup issues or any repairs attempted by anyone other than by a authorized service center. Products with unreadable or removed serial numbers, or requiring routine maintenance are not covered. This one-year limited warranty does not cover Products that are sold "As-Is", "Open Box", "FACTORY RECERTIFIED", or by a non-authorized reseller.

THERE ARE NO EXPRESS WARRANTIES OTHER THAN THOSE LISTED OR DESCRIBED ABOVE. ANY IMPLIED WARRANTIES, INCLUDING ANY IMPLIED WARRANTY OF MERCHANTABILITY AND FITNESS FOR A PARTICULAR PURPOSE, SHALL BE LIMITED IN DURATION TO THE PERIOD OF TIME SET FORTH ABOVE. THE WARRANTOR'S TOTAL LIABILITY FOR ANY AND ALL LOSSES AND DAMAGES RESULTING FROM ANY CAUSE WHATSOEVER

Limited Warranty

INCLUDING WARRANTOR'S NEGLIGENCE, ALLEGED DAMAGE, OR DEFECTIVE GOODS, WHETHER SUCH DEFECTS ARE DISCOVERABLE OR LATENT, SHALL IN NO EVENT EXCEED THE PURCHASE PRICE OF THE PRODUCT. THE WARRANTOR SHALL NOT BE RESPONSIBLE FOR LOSS OF USE, LOSS OF INFORMATION OR DATA, COMMERCIAL LOSS, LOST REVENUE OR LOST PROFITS, OR OTHER INCIDENTAL OR CONSEQUENTIAL DAMAGES. SOME STATES DO NOT ALLOW LIMITATIONS ON HOW LONG AN IMPLIED WARRANTY LASTS OR THE EXCLUSION OF INCIDENTAL OR CONSEQUENTIAL DAMAGES, SO THE ABOVE LIMITATIONS OR EXCLUSIONS MAY NOT APPLY TO YOU. THIS WARRANTY GIVES YOU SPECIFIC LEGAL RIGHTS, AND YOU MAY ALSO HAVE OTHER RIGHTS, WHICH VARY FROM STATE TO STATE. THIS WARRANTY IS SUBJECT TO CHANGE WITHOUT NOTICE.

CHECK TV.JVC.COM FOR THE MOST CURRENT VERSION.

PERSONAL DATA

If your Product is capable of storing personal data and other information, all contents and information will be deleted in the course of some in-home, and all ship-in, warranty service. If this occurs, your Product will be restored to you configured as originally purchased. You will be responsible for restoring all applicable data and passwords. Recovery and reinstallation of User data is not covered under this Limited Warranty. In order to protect your personal information, we recommend that you always clear all personal information from the Product before it is serviced, regardless of the servicer.

Important Open Source Software Notice

Your JVC device contains free software which is based on the license granted under the GNU General Public License and Lesser General Public License (hereinafter "GPL/LPGL") that are subject to the GPL2.0/LGPL2.1 You may use, modify, or distribute only if you agree to all of the terms and conditions of the GPL/LGPL.

Please note that any software component developed or created independently by AmTRAN Video Corporation shall not be subject to "GPL/LGPL" requirement for provision of the source code. Users are urged to read the details for the relevant license carefully before using the software component covered by "GPL/LGPL."

You can obtain a copy of the GPL/LGPL license from <http://www.gnu.org/licenses/gpl> and <http://www.gnu.org/licenses/lgpl>.

For details of any open source software on your JVC device, please visit the following web site:

<http://go.jvc.com/HDTVSupport>.

Please note that we are unable to answer any inquiry relating to the contents, etc of the source code.

Permission is hereby granted, free of charge, to any person obtaining a copy of any such software and associated documentation files (the "Open Source Software"), to deal in the Open Source Software without restriction including without limitation the rights to use, copy, modify, merge, publish, distribute, sublicense, and/or sell copies of the Open Source Software, and to permit persons to whom the Open Source Software is furnished to do so, subject to the following conditions:

THE SOFTWARE IS PROVIDED "AS IS", WITHOUT WARRANTY OF ANY KIND, EXPRESS OR IMPLIED, INCLUDING BUT NOT LIMITED TO THE WARRANTIES OF MERCHANTABILITY, FITNESS FOR A PARTICULAR PURPOSE AND NON-INFRINGEMENT, IN NO EVENT SHALL THE AUTHORS OR COPYRIGHT HOLDERS BE LIABLE FOR ANY CLAIM, DAMAGES OR OTHER LIABILITY, WHETHER IN AN ACTION OF CONTRACT, TORT OR OTHERWISE, ARISING FROM, OUT OF OR IN CONNECTION WITH THE SOFTWARE OR THE USE OR OTHER DEALINGS IN THE SOFTWARE.

Free Manuals Download Website

<http://myh66.com>

<http://usermanuals.us>

<http://www.somanuals.com>

<http://www.4manuals.cc>

<http://www.manual-lib.com>

<http://www.404manual.com>

<http://www.luxmanual.com>

<http://aubethermostatmanual.com>

Golf course search by state

<http://golfingnear.com>

Email search by domain

<http://emailbydomain.com>

Auto manuals search

<http://auto.somanuals.com>

TV manuals search

<http://tv.somanuals.com>