

JVC

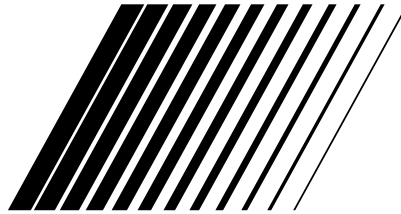

NETWORK MEDIA SYSTEM

TH-BD50

Consist of XV-THBD50, SP-THBD50F, SP-THBD50C and SP-THBD50W



INSTRUCTIONS

LVT2099-029A
[UJ]

Warnings, cautions and others

CAUTION

To reduce the risk of electrical shocks, fire, etc.:

1. Do not remove screws, covers or cabinet.
2. Do not expose this appliance to rain or moisture.

CAUTION

The  button in any position does not disconnect the mains line.

Disconnect the mains plug to shut the power off completely (the STANDBY lamp goes off).

The MAINS plug or an appliance coupler is used as the disconnect device, the disconnect device shall remain readily operable.

- When the system is on standby, the STANDBY lamp lights red.
- When the system is turned on, the STANDBY lamp goes off.

The power can be remote controlled.

CAUTION

- Do not block the ventilation openings or holes. (If the ventilation openings or holes are blocked by a newspaper or cloth, etc., the heat may not be able to get out.)
- Do not place any naked flame sources, such as lighted candles, on the apparatus.
- When discarding batteries, environmental problems must be considered and local rules or laws governing the disposal of these batteries must be followed strictly.
- Do not expose this apparatus to rain, moisture, dripping or splashing and that no objects filled with liquids, such as vases, shall be placed on the apparatus.

IMPORTANT FOR LASER PRODUCTS

1. CLASS 1 LASER PRODUCT
2. CAUTION: Do not open the top cover or cabinet. There are no user serviceable parts inside the unit; leave all servicing to qualified service personnel.
3. CAUTION: CLASS 3B VISIBLE AND INVISIBLE LASER RADIATION WHEN OPEN AVOID EXPOSURE TO THE BEAM.
4. REPRODUCTION OF LABEL: CAUTION LABEL, PLACED INSIDE THE UNIT.

CAUTION	CLASS 3B VISIBLE AND INVISIBLE LASER RADIATION WHEN OPEN. AVOID EXPOSURE TO THE BEAM.
ADVARSEL	KLASSE 3B SYNLIG OG USYNLIG LASERSTRÅLING VED ÅBNING. UNDGÅ UDSAETTELSE FOR STRÅLING.
ADVARSEL	KLASSE 3B SYNLIG OG USYNLIG LASERSTRÅLING NÅR DEKSEL ÅPENS. UNNGÅ EKSPONERING FOR STRÅLEN.
VARNING	KLASSE 3B SYNLIG OCH OSYNLIG LASERSTRÅLNING NÅR DENNA DEL ÄR ÖPPNAD. STRÅLEN ÄR FARLIG.
VARO	AVATTAESSA OLET ALTTIINA LUOKAN 3B NÄKYVÄÄ JA NÄKYMÄTÖNTÄ LASERSÄTEILYLLE VARO ALTISTUMISTA SÄTEELLE.
VORSICHT	SICHTBARE UND UNSICHTBARE LASERSTRAHLUNG KLASSE 3B. WENN ABDECKUNG GEÖFFNET. NICHT DEM STRAHL AUSSETZEN.

CAUTION — Proper Ventilation

To avoid risk of electric shock and fire and to protect from damage, locate the apparatus as follows:

Top/Front/Back/Sides: No obstructions should be placed in the areas shown by the dimensions below.

Bottom: Place on the level surface. Maintain adequate air path for ventilation by placing on a stand with a height of 10 cm or more.

In addition, maintain the best possible air circulation.

CAUTION

- Battery shall not be exposed to excessive heat such as sunshine, fire or the like.

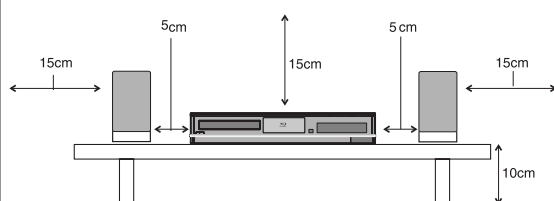
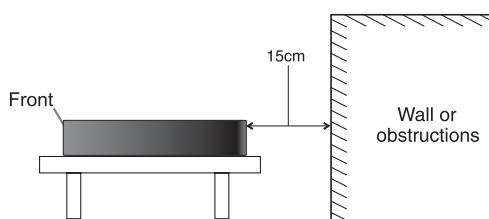
Front view of the main unit and speakers**Side view of the main unit**



[European Union only]

Notes on Copyrights

- Because AACS (Advanced Access Content System) is approved as content protection system for BD format, similar to use of CSS (Content Scramble System) for DVD format, certain restrictions are imposed on playback, analogue signal output, etc., of AACS protected contents. The operation of this product and restrictions on this product may vary depending on your time of purchase as those restrictions may be adopted and/or changed by AACS after the production of this product.
Furthermore, BD-ROM Mark and BD+ are additionally used as content protection systems for BD format, which imposes certain restrictions including playback restrictions for BD-ROM Mark and/or BD+ protected contents. To obtain additional information on AACS, BD-ROM Mark, BD+, or this product, please contact an authorized Customer Service Centre.
- Many BD-ROM/DVD discs are encoded with copy protection. Because of this, you should only connect your player directly to your TV, not to a VCR. Connecting to a VCR results in a distorted picture from copy-protected discs.
- This product incorporates copyright protection technology that is protected by U.S. patents and other intellectual property rights. Use of this copyright protection technology must be authorized by Macrovision, and is intended for home and other limited viewing uses only unless otherwise authorized by Macrovision. Reverse engineering or disassembly is prohibited.
- Under the U.S. Copyright laws and Copyright laws of other countries, unauthorized recording, use, display, distribution, or revision of television programs, videotapes, BD-ROM discs, DVDs, CDs and other materials may subject you to civil and/or criminal liability.

Licenses

Java and all Java-based trademarks and logos are trademarks or registered trademarks of Sun Microsystems, Inc. in the United States and other countries.

Manufactured under license from Dolby Laboratories. Dolby, Pro Logic, and the double-D symbol are trademarks of Dolby Laboratories.

Manufactured under license under U.S. Patent #'s: 5,451,942; 5,956,674; 5,974,380; 5,978,762; 6,226,616; 6,487,535; 7,392,195; 7,272,567; 7,333,929; 7,212,872 & other U.S. and worldwide patents issued & pending. DTS is a registered trademark and the DTS logos, Symbol, DTS-HD and DTS-HD Master Audio I Essential are trademarks of DTS, Inc. © 1996-2008 DTS, Inc. All Rights Reserved.

HDMI, the HDMI logo and High-Definition Multimedia Interface are trademarks or registered trademarks of HDMI licensing LLC.

“BD-LIVE” logo is a trademark of Blu-ray Disc Association.

“DVD Logo” is a trademark of DVD Format/Logo Licensing Corporation.

“x.v.Color” is a trademark of Sony Corporation.

“Blu-ray Disc” is a trademark.

“BONUSVIEW” is trademark of Blu-ray Disc Association.

This product is licensed under the AVC patent portfolio license and VC-1 patent portfolio license for the personal and non-commercial use of a consumer to (i) encode video in compliance with the AVC Standard and VC-1 Standard (“AVC/VC-1 Video”) and/or (ii) decode AVC/VC-1 Video that was encoded by a consumer engaged in a personal and non-commercial activity and/or was obtained from a video provider licensed to provide AVC/VC-1 Video. No license is granted or shall be implied for any other use. Additional information may be obtained from MPEG LA, LLC. See <http://www.mpegla.com>.

“AVCHD” and the “AVCHD” logo are trademarks of Panasonic Corporation and Sony Corporation.

DivX is a registered trademark of DivX, Inc., and is used under license.

Covered by one or more of following U.S. Patents: 7,295,673; 7,460,688; 7,519,574; 7,515,710.

“DivX Certified to play DivX video up to HD 1080p, including premium content.”

Contents

Introduction7-14

About the ∅ Symbol Display	7
Symbols Used in this Manual	7
Notes on Discs	7
Moisture Condensation	7
Handling the Unit	7
Playable Discs	8
Regional Code	8
BD-ROM Disc Features	9
Compatibility Notes	10
Certain System Requirements	10
Important Notice for TV color system	10
Notice for language setting	10
Front Panel	11
Rear Panel	12
Remote Control	13
Remote Control Operation	13
Attaching the speakers to the player	14
Positioning the System	14

Installation and Setup15-29

Connections to Your TV	15
HDMI connection	16
Internet connection	17
Resolution Setting	18-19
Setting the sound mode	20
Adjust the speaker level settings	20
Using the late night function	20
Using the sleep timer	20
Using a USB Flash Drive	21
Using the Home Menu	21
Initial Settings	22-26
- General Operation	22
- [DISPLAY] Menu	22
- [LANGUAGE] Menu	23
- [AUDIO] Menu	23
- [LOCK] Menu (Parental Control)	24
- [NETWORK] Menu	25
- [OTHERS] Menu	26
Listening to music from your portable audio player	27
Listening to the sound from your component	27
Using HDMI IN jacks	28
Using DIGITAL AUDIO IN jacks	28

Antenna Connection	29
--------------------	----

Operations30-40

General playback features	30-31
Additional features	32
- If a disc menu screen is displayed	32
- Last Scene Memory	32
- Marker Search	32
- Hearing a different audio	33
- Using the search menu	33
- Using Color (R, G, Y, B) Buttons	33
- Screen Saver	33
- Changing content list view	33
Displaying Disc Information On-Screen	34
Enjoying BD-LIVE™ or BONUS VIEW™ in BD-Video	34-35
Playing a movie	36
Notice for displaying the DivX subtitle	36
Listening to music	37
Presetting the Radio Stations	38
Listening to the radio	38
Viewing a photo	39
Options during viewing a photo file in full screen	40

Reference41-47

Controlling a TV with the Supplied Remote Control	41
Language Codes	42
Area Codes	42
Troubleshooting	43-44
Specifications	45-46
Open source software notice	47

Introduction

To ensure proper use of this product, please read this owner's manual carefully and retain for future reference.

This manual provides information on the operation and maintenance of your player. Should the unit require service, contact an authorized service location.

About the Symbol Display

"" may appear on your TV display during operation and indicates that the function explained in this owner's manual is not available on that specific media.

Symbols Used in this Manual

Note:

Indicates special notes and operating features.

Tip:

Indicates tips and hints for making the task easier.

A section whose title has one of the following symbols are applicable only to the disc represented by the symbol.

ALL All discs listed below

BD BD-ROM disc

DVD DVD-Video, DVD-R/RW, +R/+RW in Video mode or VR mode and finalized

AVCHD DVD-R/RW, +R/+RW in AVCHD format

DivX DivX files

ACD Audio CDs

MP3 MP3 files

WMA WMA files

PHOTO Photo files

Notes on Discs

Handling Discs

Do not touch the playback side of the disc. Hold the disc by the edges so that fingerprints do not get on the surface. Never stick paper or tape on the disc.

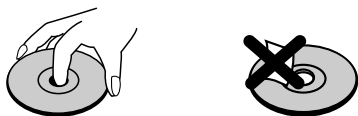

Storing Discs

After playing, store the disc in its case. Do not expose the disc to direct sunlight or sources of heat and never leave it in a parked car exposed to direct sunlight.

Cleaning Discs

Fingerprints and dust on the disc can cause poor picture quality and sound distortion. Before playing, clean the disc with a clean cloth. Wipe the disc from the centre out.

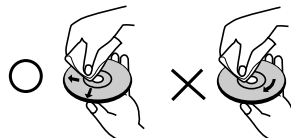

Do not use strong solvents such as alcohol, benzene, thinner, commercially available cleaners, or anti-static spray intended for older vinyl records.

Moisture Condensation

Never operate this product immediately after moving it from a cold location to a warm location. Leave it for two or three hours without operating it. If you use this product in such a situation, it may damage discs and internal parts.

Handling the Unit

When shipping the unit

Please save the original shipping carton and packing materials. If you need to ship the unit, for maximum protection, re-pack the unit as it was originally packed at the factory.

Keeping the exterior surfaces clean

- Do not use volatile liquids such as insecticide spray near the unit.
- Wiping with strong pressure may damage the surface.
- Do not leave rubber or plastic products in contact with the unit for a long period of time.

Cleaning the unit

To clean the player, use a soft, dry cloth. If the surfaces are extremely dirty, use a soft cloth lightly moistened with a mild detergent solution. Do not use strong solvents such as alcohol, benzene, or thinner, as these might damage the surface of the unit.

Maintaining the Unit

The unit is a high-tech, precision device. If the optical pick-up lens and disc drive parts are dirty or worn, the picture quality could be diminished.

For details, please contact your nearest authorized service centre.

Playable Discs



Blu-ray Disc

- Discs such as movies that can be purchased or rented.
- BD-R/RE discs that contain audio titles, DivX, MP3, WMA, or Photo files.



DVD-VIDEO

- Discs such as movies that can be purchased or rented.



DVD-R

- Video mode and finalized only
- Supports the dual layer disc also
- AVCHD format
- DVD-R discs that contain audio titles, DivX, MP3, WMA, or Photo files.



DVD-RW

- VR mode, Video mode and finalized only
- AVCHD format
- DVD-RW discs that contain audio titles, DivX, MP3, WMA, or Photo files.



DVD+R

- Finalized disc only
- Supports the dual layer disc also
- AVCHD format
- DVD+R discs that contain audio titles, DivX, MP3, WMA, or Photo files.



DVD+RW

- Video mode and finalized only
- AVCHD format
- DVD+RW discs that contain audio titles, DivX, MP3, WMA, or Photo files.



Audio CD

- Audio CDs or CD-Rs/CD-RWs in audio CD format that can be purchased



CD-R/CD-RW

- CD-R/CD-RW discs that contain audio titles, DivX, MP3, WMA, or Photo files.

AVCHD (Advanced Video Codec High Definition)

- This player can playback AVCHD format discs. These discs are normally recorded and used in camcorders.
- The AVCHD format is a high definition digital video camera format.
- The MPEG-4 AVC/H.264 format is capable of compressing images at higher efficiency than that of the conventional image compressing format.
- Some AVCHD discs use the “x.v.Color” format.
- This player can playback AVCHD discs using “x.v.Color” format.

- Some AVCHD format discs may not play, depending on the recording condition.
- AVCHD format discs need to be finalized.
- “x.v.Color” offers a wider color range than normal DVD camcorder discs.

Regional Code

This unit has a regional code printed on the rear of the unit. This unit can play only BD-ROM or DVD discs labelled same as the rear of the unit or “ALL”.

Notes:

- Depending on the conditions of the recording equipment or the CD-R/RW (or DVD-R/RW, +R/+RW) disc itself, some CD-R/RW (or DVD-R/RW, +R/+RW) discs cannot be played on the unit.
- Do not attach any seal or label to either side (the labelled side or the recorded side) of a disc.
- Do not use irregularly shaped CDs (e.g., heart-shaped or octagonal). Doing so may result in malfunctions.
- Depending on the recording software & the finalization, some recorded discs (CD-R/RW or DVD-R/RW, +R/+RW) may not be playable.
- DVD-R/RW, +R/+RW and CD-R/RW discs recorded using a personal computer or a DVD or CD Recorder may not play if the disc is damaged or dirty, or if there is dirt or condensation on the player's lens.
- If you record a disc using a personal computer, even if it is recorded in a compatible format, there are cases in which it may not play because of the settings of the application software used to create the disc. (Check with the software publisher for more detailed information.)
- This player requires discs and recordings to meet certain technical standards in order to achieve optimal playback quality. Pre-recorded DVDs are automatically set to these standards. There are many different types of recordable disc formats (including CD-R containing MP3 or WMA files) and these require certain pre-existing conditions to ensure compatible playback.
- Customers should note that permission is required in order to download MP3 / WMA files and music from the Internet. Our company has no right to grant such permission. Permission should always be sought from the copyright owner.
- This player supports 8 cm disc except Blu-ray Disc.

BD-ROM Disc Features

BD-ROM Discs can store 25 GB (single layer) or 50 GB (dual layer) on a single sided disc - about 5 to 10 times the capacity of a DVD.

BD-ROM Discs also support the highest quality HD video available in the industry (up to 1920 x 1080) - Large capacity means no compromise on video quality. Furthermore, a BD-ROM disc has the same familiar size and look as DVD.

- The following BD-ROM disc features are disc dependent and will vary.
- Appearance and navigation of features will also vary from disc to disc.
- Not all discs will have the features described below.
- BD-ROM, Hybrid disc have both BD-ROM and DVD (or CD) layers on one side. On such discs, BD-ROM layer will be only played back in this player.

Video highlights

The BD-ROM format for movie distribution supports three highly advanced video codecs, including MPEG-2, MPEG4 AVC (H.264), and SMPTE VC1. HD video resolutions are also available:

- 1920 x 1080 HD
- 1280 x 720 HD

For High-Definition Playback

To view high-definition contents from BD-ROM discs, an HDTV is required. Some discs may require HDMI OUT for viewing of high-definition contents. Ability to view high-definition contents in BD-ROM discs may be limited depending on the resolution of your TV.

Graphic planes

Two individual, full HD resolution (1920x1080) graphic planes (layers) are available, on top of the HD video layer. One plane is assigned to video-related, frame accurate graphics (like subtitles), and the other plane is assigned to interactive graphic elements, such as buttons or menus.

For both planes, various wipes, fades and scroll effects may be available.



Graphic Plane

HD Video

Menu sounds

When you highlight or select a menu option, sounds can be heard such as button clicks or a voice-over explaining the highlighted menu choice.

Multi-page/PopUp Menu

With DVD-Video, playback is interrupted each time a new menu screen is accessed. Due to BD-ROM disc's ability to preload data from the disc without interrupting playback, a menu can consist of several pages.

You can browse through the menu pages or select different menu paths, while the audio and video remain playing in the background.

Interactivity

Certain BD-ROM Discs may contain animated menus and/or trivia games.

User Browsable Slideshows

With BD-ROM Discs, you can browse through various still pictures while the audio remains playing.

Subtitles

Depending on what is contained on the BD-ROM disc, you may be able to select different font styles, sizes and colors for some subtitles. Subtitles may also be animated, scrolled or faded in and out.

BD-J Interactive Capability

The BD-ROM format supports Java for interactive functions. "BD-J" offers content providers almost unlimited functionality when creating interactive BD-ROM titles.

BD-ROM Disc Compatibility

This player supports BD-ROM Profile 2.

- Discs supporting BD-Live (BD-ROM version 2 Profile 2) that allows interactive functions to be used when this unit is connected to the Internet in addition to the BONUSVIEW function.
- Discs supporting BONUSVIEW (BD-ROM version 2 Profile 1 version 1.1/Final Standard Profile) that allows Virtual packages or Picture-in-Picture functions to be used.
- See "Enjoying BD-LIVE™ or BONUS VIEW™ in BD-Video" on page 34 for details.

Compatibility Notes

- Because BD-ROM are a new format, certain disc, digital connection and other compatibility issues are possible. If you experience compatibility problems, please contact an authorized Customer Service Centre.
- Viewing high-definition content and up-converting standard DVD content may require an HDMI-capable input or HDCP-capable DVI input on your display device.
- Some BD-ROM and DVD discs may restrict the use of some operation commands or features.
- You can use a USB device that is used to store some disc related information, including downloaded on-line content. The disc you are using will control how long this information is retained.
- Some BD-ROM discs may not be played correctly unless a USB device is inserted.

Certain System Requirements

For high definition video playback:

- High definition display that has COMPONENT or HDMI.
- BD-ROM disc with high definition content.
- HDMI or HDCP capable DVI input on your display device is required for some content (as specified by disc authors).
- For up-conversion of standard definition DVD, an HDMI or HDCP capable DVI input on your display device is required for copy protected content.

Notice for language setting

At first, set [DISC MENU]/ [DISPLAY MENU] to your using language. Refer to page 23.

Front Panel

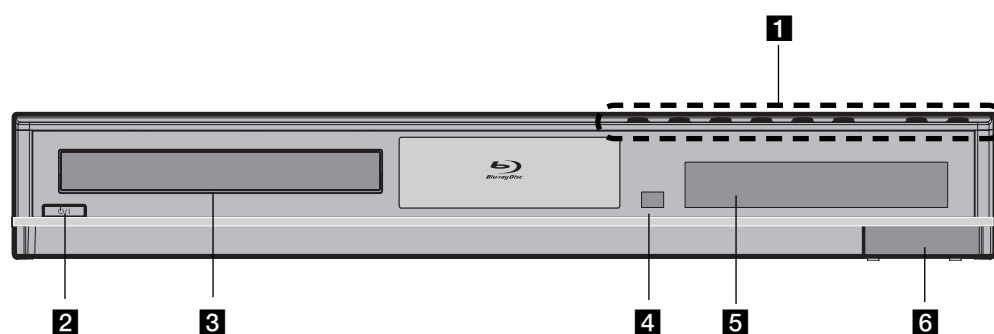

1 Operation buttons

▲ (OPEN/CLOSE)

Opens or closes the disc tray.

▶ / II (PLAY / PAUSE)

Starts playback.

Pause playback temporarily, press again to exit pause mode.

■ (STOP)

Stops playback.

When a menu is displayed, this button works as "ENTER".

◀◀ / ▶▶ (SKIP)

Go to next or previous file/track/chapter.

Searches backward or forward if you press and hold it.

SOURCE

Changes the source.

VOLUME +/-

Adjusts speaker volume.

2 ⏻/⏼ (STANDBY) Button

Switches the unit ON or OFF.

3 Disc Tray

Insert a disc here.

4 Remote Sensor

Point the Remote Control here.

5 Display Window

Shows the current status of the player.

6 USB Port

Connect a USB Flash Drive.

Rear Panel

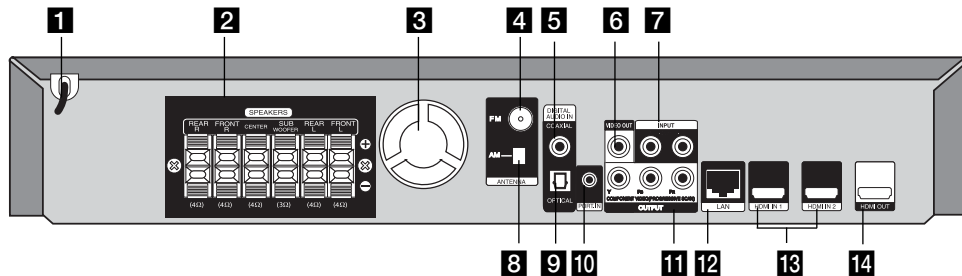

1 AC Power Cord

Plug into the power source.

2 SPEAKER Connectors

Connect the speakers.

3 Cooling Fan

4 FM Antenna connector

Connect the FM antenna.

5 DIGITAL AUDIO IN (COAXIAL)

Connect to digital (coaxial) audio equipment.

6 VIDEO OUT

Connect to a TV with video inputs.

7 AUX (L/R) INPUT

Connect to an external source with 2 channel audio outputs.

8 AM Antenna connector

Connect the AM antenna.

9 DIGITAL AUDIO IN (OPTICAL)

Connect to digital (optical) audio equipment.

10 PORT. IN

Connect to a portable player with audio outputs.

11 COMPONENT VIDEO (Y PB PR) OUTPUT (PROGRESSIVE SCAN)

Connect to a TV with Y Pb Pr inputs.

12 LAN port

Connect a network with an always-on broadband connection.

13 HDMI IN (Type A) 1/2

Connect to an external source with HDMI outputs.

14 HDMI OUT (Type A)

Connect to TV with HDMI inputs. (Interface for digital audio and video)

Remote Control

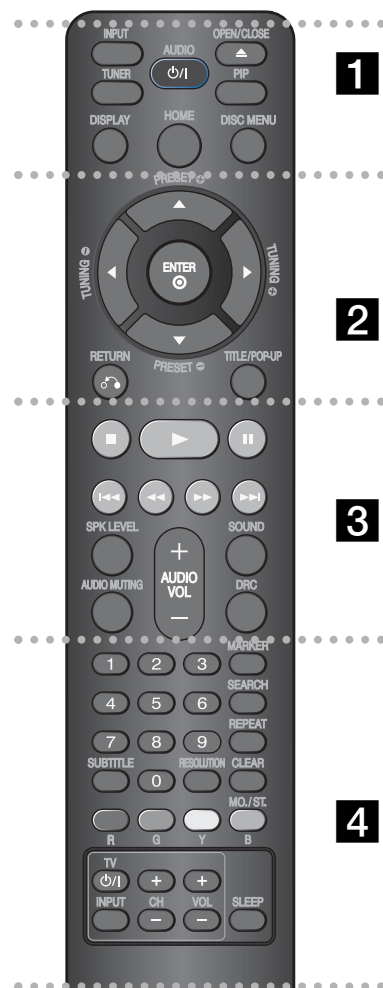

- • • • • **1** • • • • •
- INPUT:** Changes the input source. (FM, AM, AUX, PORTABLE, OPTICAL, COAXIAL, HDMI IN 1, HDMI IN 2)
- TUNER:** Selects the system's tuner directly.
- (**⏻/⏻**): Switches the player ON or OFF.
- OPEN/CLOSE (⏮):** Opens and closes

es the disc tray. When you open or close the disc tray. INPUT switches to the disc. Then the unit starts playback the disc or displays the Home Menu.

PIP*: Switches on/off Secondary Video (Picture-in-picture) (BD-ROM only).

▲ Depending on a disc type or the pre-recorded contents of the BD-ROM disc, different functions may be executed than other media or there are no responses when pressing some buttons (depending on media used).

DISPLAY: Displays or exits On-Screen Display.

HOME: Displays or exits the [Home Menu].

DISC MENU: Accesses menu on a disc.

• • • • • **2** • • • • •

Direction buttons: Selects an option in the menu.

PRESET (▲/▼): Selects programme of Radio.

ENTER: Acknowledges menu selection.

RETURN (↶): Exits the menu or resumes playback. The resume play function may work depending on the BD-ROM disc.

TITLE/POP-UP: Displays the DVD title menu or BD-ROM's popup menu, if available.

• • • • • **3** • • • • •

■: Stops playback. If you press this button again, the "RESUME" function (record of the stopped point) will be clear.

▶: Starts playback.

⏸: Pauses playback.

⏮/⏭: Go to next or previous chapter / track / file.

⏮/⏭: Searches backward or forward.

SPK LEVEL: Sets the sound level of desired speaker.

SOUND: Selects a sound mode.

AUDIO MUTING: Press **AUDIO MUTING** to mute your unit. You can mute your unit in order, for example, to answer the telephone.

AUDIO VOL (+/-): Adjusts speaker volume.

DRC: Sets the late night function.

• • • • • **4** • • • • •

0-9 numerical buttons: Select numbered options in a menu.

SUBTITLE: Selects a subtitle language.

RESOLUTION: Sets the output resolution for HDMI and COMPONENT VIDEO OUT jacks.

MARKER: Marks any point during playback.

SEARCH: Displays or exits the search menu.

REPEAT: Repeat a desired section.

CLEAR: Removes a mark on the search menu or a number when setting the password.

Colored (R, G, Y, B) buttons: Use to navigate BD-ROM menus. They are also used for [MOVIE], [PHOTO], [MUSIC] menu.

- B button: Selects MONO or STEREO in FM mode.

TV Control Buttons: See page 41.

SLEEP: Sets a certain period of time after which the unit will switch to standby.

Remote Control Operation

Point the Remote Control at the remote sensor and press the buttons.

Caution

- Do not put the batteries in the place where young children can reach.

Remote Control Battery Installation

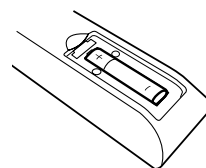

Remove the battery cover on the rear of the Remote Control, and insert a R03 (size AAA) battery with + and - matched correctly.

Attaching the speakers to the player

1 You will have received six speaker cables.

Each one is color-coded by a band near each end and connects one of the six speakers to the player.

2 Connect the wires to the player.

Match each wire's colored band to the same colored connection terminal on the rear of the player. To connect the cable to the player, press each plastic finger pad to open the connection terminal. Insert the wire and release the finger pad.

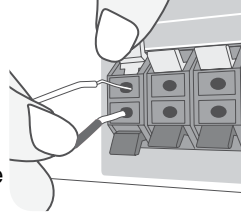

Connect the black end of each wire to the terminals marked -(minus) and the other end to the terminals marked + (plus).

3 Connect the wires to the speakers.

Connect the other end of each wire to the correct speaker according to the color coding:

Grey	Rear	Behind you and to your right
Blue	Rear	Behind you and to your left.
Green	Center	Above or below screen, directly in front of you.
Orange	Sub Woofer	This can be placed in any front position.
Red	Front	In front of you, to the right of the screen.
White	Front	In front of you, to the left of the screen.

Be careful of the following

Be careful to make sure children not to put their hands or any objects into the *speaker duct.

*Speaker duct: A hole for plentiful bass sound on speaker cabinet(enclosure).

Positioning the System

The following illustration shows an example of positioning the system. Note that the illustrations in these instructions differ from the actual unit for explanation purposes.

For the best possible surround sound, all the speakers other than the subwoofer should be placed at the same distance from the listening position (A).

- Ⓐ Front left speaker (L)/ Ⓑ Front right speaker (R): Place the front speakers to the sides of the monitor or screen and as flush with the screen surface as possible.
- Ⓒ Center speaker: Place the center speaker above or below the monitor or screen.
- Ⓓ Surround left speaker (L)/ Ⓔ Surround right speaker (R): Place these speakers behind your listening position, facing slightly inwards.
- Ⓕ Subwoofer: The position of the subwoofer is not so critical, because low bass sounds are not highly directional. But it is better to place the subwoofer near the front speakers. Turn it slightly toward the center of the room to reduce the wall reflections.

Ⓖ Unit

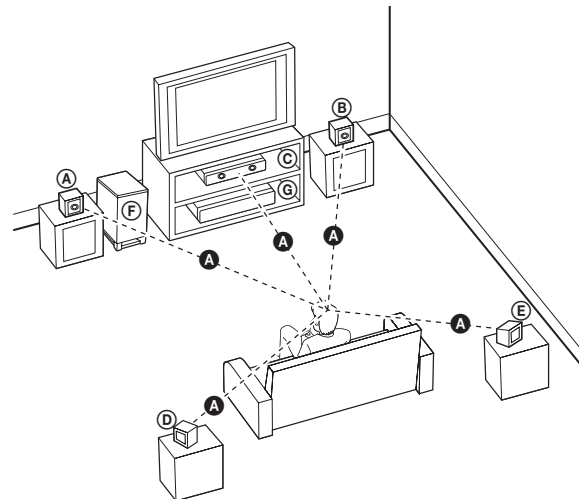

Installation and Setup

Connections to Your TV

Make one of the following connections, depending on the capabilities of your existing equipment.

Tips:

- Depending on your TV and other equipment you wish to connect, there are various ways you could connect the player. Use only one of the connections described below.
- Please refer to the manuals of your TV or other devices as necessary to make the best connections.

Caution

- Make sure the player is connected directly to the TV. Tune the TV to the correct video input channel.
- Do not connect your player via your VCR. The image could be distorted by the copy protection system.

Component Video Connection

Connect the COMPONENT VIDEO OUT jacks on the player to the corresponding input jacks on the TV using Y Pb Pr cables (**C**). You can hear the sound through the system's speakers.

Tip:

When you use COMPONENT VIDEO OUT connection, you can change the resolution for the output. (Refer to "Resolution setting" on page 18.)

Video Connection

Connect the VIDEO OUT jack on the player to the video in jack on the TV using a video cable (**V**). You can hear the sound through the system's speakers.

Rear of the player

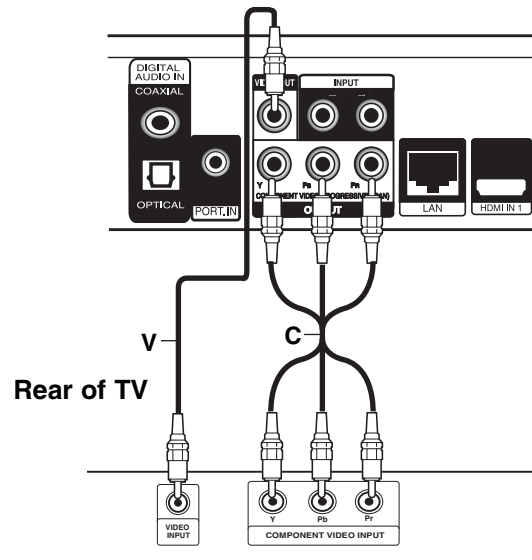

HDMI connection

If you have a HDMI TV or monitor, you can connect it to this player using a HDMI cable.

1. Connect the HDMI jack on the player to the HDMI jack on a HDMI compatible TV or monitor (**H**).
2. Set the TV's source to HDMI (refer to TV's Owner's manual).

Notes:

- You must select a HDMI audio output that your TV accepts using [HDMI Audio] options on the [Setup] menu (see page 23).
- If a connected HDMI device does not accept the audio output of the unit, the HDMI device's audio sound may be distorted or may not output.

Tips:

- You can fully enjoy digital audio and video signals together with this HDMI connection.
- When you use HDMI connection, you can change the resolution for the HDMI output. (Refer to "Resolution Setting" on page 18.)
- Select the type of video output from the HDMI OUT jack using [HDMI Color Setting] option on the [Setup] menu. (Refer to "HDMI color Setting" on page 22.)

Cautions

- Changing the resolution when the connection has already been established may result in malfunctions. To solve the problem, turn off the player and then turn it on again.
- When the HDMI connection with HDCP is not verified, TV screen is changed to black screen. In this case, check the the HDMI connection, or disconnect the HDMI cable.
- If there is noise or lines on the screen, please check the HDMI cable (length is generally limited to 4.5 m) and use a High Speed HDMI cable (Version 1.3).

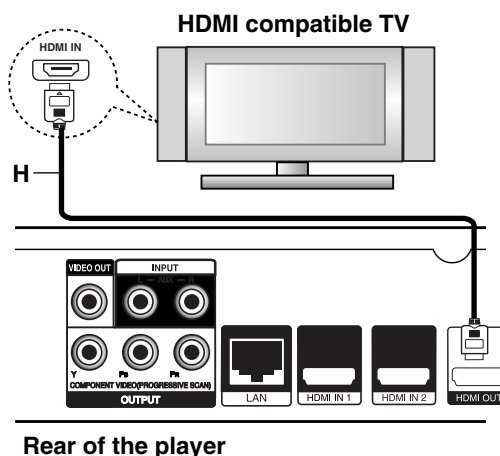

Additional Information for HDMI

- When you connect a HDMI or DVI compatible device make sure of the following:
 - Try switching off the HDMI/DVI device and this player. Next, switch on the HDMI/DVI device and leave it for around 30 seconds, then switch on this player.
 - The connected device's video input is set correctly for this unit.
 - The connected device is compatible with 720x480p, 1280x720p, 1920x1080i or 1920x1080p video input.
- Not all HDCP-compatible HDMI or DVI devices will work with this player.
 - The picture will not be displayed properly with non-HDCP device.
 - This player does not playback and TV screen is changed to black or green screen or the snow noise may occur on the screen.

Internet connection

This player can be connected to a local area network (LAN) via the LAN port on the rear panel. After making the physical connection the player needs to be set up for network communication. This is done from the [Setup] menu — see “[NETWORK] Menu” on page 25 for detailed instructions.

Connect the player's LAN port to the corresponding port on your Modem or Router using a LAN cable. Use a commercially available straight LAN cable (Category 5/CAT5 or better with RJ45 connector).

By connecting the unit to broadband Internet, you can use a disc that offers BD-Live function (see page 34).

Cautions:

- When plugging or unplugging the LAN cable, hold the plug portion of the cable. When unplugging, do not pull on the LAN cable but unplug while pressing down on the lock.
- Do not connect a modular phone cable to the LAN port.
- Since there are various connection configurations, please follow the specifications of your telecommunication carrier or internet service provider.

Rear of the player

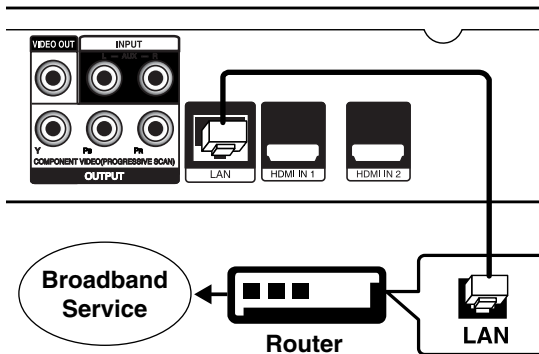

Notes:

- Depending on the internet service provider (ISP), the number of devices that can receive internet service may be limited by the applicable terms of service. For details, contact your ISP.
- Our company is not responsible for any malfunction of the player and/or the internet connection feature due to communication errors/malfunctions associated with your broadband internet connection, or other connected equipment.
- Our company is not responsible for any trouble in your internet connection.

- The features of BD-ROM discs made available through the Internet Connection feature are not created or provided by our company, and our company is not responsible for their functionality or continued availability. Some disc related material available by the Internet Connection may not be compatible with this player. If you have questions about such content, please contact the producer of the disc.
- Some internet contents may require a higher bandwidth connection.
- Even if the player is properly connected and configured, some internet contents may not operate properly because of internet congestion, the quality or bandwidth of your internet service, or problems at the provider of the content.
- Some internet connection operations may not be possible due to certain restrictions set by the Internet service provider (ISP) supplying your broadband Internet connection.
- Any fees charged by an ISP including, without limitation, connection charges are your responsibility.
- A 10 Base-T or 100 Base-TX LAN port is required for connection to this player. If your internet service does not allow for such a connection, you will not be able to connect the player.
- You must use a Router to use xDSL service.
- A DSL modem is required to use DSL service and a cable modem is required to use cable modem service. Depending on the access method of and subscriber agreement with your ISP, you may not be able to use the internet connection feature contained in this player or you may be limited to the number of devices you can connect at the same time. (If your ISP limits subscription to one device, this player may not be allowed to connect when a PC is already connected.)
- The use of a “Router” may not be allowed or its usage may be limited depending on the policies and restrictions of your ISP. For details, contact your ISP directly.
- Your ISP may protect this player from being connected to network when confirming MAC ADDRESS. In that case, contact your ISP to request to initialize MAC ADDRESS.

Resolution Setting

The player provides several output resolutions for HDMI OUT and COMPONENT VIDEO OUT jacks. You can change the resolution using [Setup] menu or pressing the RESOLUTION button in Home menu or Setup Menu.

Note:

Since several factors affect the resolution of video output, see "Available resolution according to resolution setting"

Auto – If the HDMI OUT jack is connected for TVs providing display information (EDID), automatically selects the resolution best suited to the connected TV. If the COMPONENT VIDEO OUT is only connected, this changes the resolution to 1080i as default resolution.

1080p – Outputs 1080 lines of progressive video.

1080i – Outputs 1080 lines of interlaced video.

720p – Outputs 720 lines of progressive video.

480p – Outputs 480 lines progressive video.

480i – Outputs 480 lines of interlaced video.

How to change the resolution using RESOLUTION button

Press RESOLUTION repeatedly in [Home Menu] and [Setup] Menu to change the resolution. The display window will show you the current resolution.



RESOLUTION button

How to change the resolution using Setup menu

1. Press HOME and the Home Menu appears.
2. Select [Setup] and press ENTER. The Setup menu appears.
3. Use ▲ / ▼ to select [DISPLAY] option then press ► to move to the second level.
4. Use ▲ / ▼ to select the [Resolution] option then press ► to move to the third level.



5. Use ▲ / ▼ to select the desired resolution then press ENTER to confirm your selection.

Note:

If the video signal from the HDMI OUT jack is not output from the TV screen when [Resolution] is set to [Auto], change the video output resolution by pressing RESOLUTION button.

Available resolution according to the resolution setting

• When the non-copy protected media is playing back

Video Output Resolution	HDMI OUT	COMPONENT VIDEO OUT	
		HDMI connected	HDMI disconnected
480i	480p	480i	
480p	480p	480p	
720p	720p	720p	
1080i	1080i	1080i	
1080p / 24Hz	1080p / 24Hz	480i	1080i
1080p / 60 Hz	1080p / 60Hz	480i	1080i

• When the copy protected media is playing back

Video Output Resolution	HDMI OUT	COMPONENT VIDEO OUT	
		HDMI connected	HDMI disconnected
480i	480p	480i	
480p	480p	480p	
720p	720p	480i	480p
1080i	1080i	480i	480p
1080p / 24Hz	1080p / 24Hz	480i	480p
1080p / 60Hz	1080p / 60Hz	480i	480p

Notes:

- Depending on your display, some of the resolution settings may result in the picture disappearing or an abnormal picture appearing. In this case, press HOME key then RESOLUTION repeatedly until the picture re-appear.
- This player supports simultaneous output of all video out jacks. The resolution of the HDMI output may not be the same as the resolution output on the component video output.

HDMI OUT connection

- For the 480i resolution setting, real output resolution of HDMI OUT will change to 480p.
- If you select a resolution manually and then connect the HDMI jack to TV and your TV does not accept it, the resolution setting is set to [Auto].
- If you select a resolution that your TV does not accept, the warning message will appear. After resolution change, if you cannot see the screen, please wait 20 seconds and the resolution will automatically revert back to the previous resolution.
- The 1080p video output frame rate may be automatically set to either 24Hz or 60Hz depending both on the capability and preference of the connected TV and based on the native video frame rate of the content on the BD-ROM disc. (Refer to “1080p Display Mode” on page 22.)

COMPONENT VIDEO OUT connection

- For the 720p, 1080i, 1080p resolution setting with protected media, real output resolution of COMPONENT VIDEO OUT will be outputted at 480p resolution.
- Even if the resolution is set to 1080p, non-copy protected BDs and DVDs playback are outputted at 1080i resolution.
- BD or DVD video stream could prevent up-scaling on analogue output.

VIDEO OUT connection

- The resolution of the VIDEO OUT jack is always outputted at 480i resolution.

Setting the sound mode

You can select a suitable sound mode. Press SOUND repeatedly until the desired mode appears on the front panel display or the TV screen. The setting the sound mode is not available when [HDMI Audio] is set to [On] (see page 23).

[Bypass] mode: Software with multichannel surround audio signals is played according to the way it was recorded.

[Bass Boost] mode: Reinforce the bass sound effect from front left and right speaker and subwoofer.

[PL II Movie] mode: Performs Pro Logic II movie mode decoding to the input signal and produces five full-bandwidth output channels from 2 channel sources. This setting is ideal for watching videos of overdubbed or old movies. This mode is available only to 2 channel sources.

[PL II Music] mode: Performs Pro Logic II music mode decoding to the input signal and produces five full-bandwidth output channels from 2 channel sources. This setting is ideal for normal stereo sources such as CD. This mode is available only to 2 channel sources.

[News] mode: This mode makes voice sound clear, improving the quality of voice sound. This mode outputs sound from the front left and right speakers, center speaker, and subwoofer.

[Drama] mode: You can enjoy more dynamic sound with improved center channel while watching a television drama. This mode outputs sound from the front left and right speakers, center speaker, and subwoofer.

[Sports] mode: This mode produces dynamic sound expansion for the sports program.

[Game] mode: You can enjoy more virtual sound while playing video games.

[Concert] mode: Creates the sound of concert hall.

[Music EXP] mode: When listening to MP3 files or other compressed music, you can enhance the sound. This mode is available only to 2 channel sources.

Note:

Only [Bypass] mode is available when HDMI IN's audio is a compressed bitstream of Dolby Digital Plus, Dolby TrueHD and DTS-HD.

Adjust the speaker level settings

You can adjust the sound level of each speaker. Press SPK LEVEL repeatedly to select a desired-speaker to set.

Press AUDIO VOL. (+/-) to adjust the sound level of the selected speaker while the level setting menu is displayed on the front panel display or the TV screen. Repeat and adjust the sound level of the other speakers.

Using the late night function

You can compress the dynamic range of the sound track.

Press DRC repeatedly.

This may be useful when you want to watch movies at low volumes late at night.

[DRC OFF]: Late night function off.

[DRC ON]: Reduction in dynamic range.

Notes:

- The late night function may be less effective or have no effect depending on the source.
- During the late night mode is on, the lighting of the center of the unit is turned off and the front panel display is dimmed.

Using the sleep timer

You can set the system to turn off at a preset time, so you can fall asleep listening to music.

- Press SLEEP repeatedly to select the desired time period options (in minutes): (Dimmer on → Sleep timer value → Dimmer off)

Dimmer on: The lighting of the center of the unit is turned off and the front panel display is dimmed.

- To view the time countdown to the standby mode, press SLEEP again.

- To deactivate the sleep timer, press SLEEP until the previous status is displayed or press  to switch the unit to standby.

Using a USB Flash Drive

This unit can play the movie, music and photo files contained on the USB Flash Drive.

Insert/Remove a USB Flash Drive

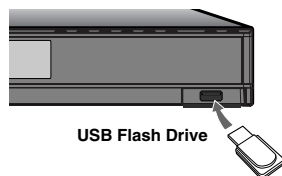

Inserting a USB Flash Drive

Insert straight-in until it fits into place.

Removing a USB Flash Drive

Withdraw the USB Flash Drive carefully.

Using the USB Flash Drive

1. Connect a USB Flash Drive.
2. Press HOME on the Remote Control.
3. Select [Music], [Photo] or [Movie] option then press ENTER.
4. When the menu that select the media is appeared. Select [USB] then press ENTER. [MOVIE], [MUSIC] or [PHOTO] menu appears. Details for the menu are on pages 36-40.

Notes:

- This player supports USB flash memory/external HDD formatted in FAT16, FAT32 and NTFS when accessing files (music, photo, movie). However, for BD-Live, only FAT16 and FAT32 formats are supported. Please use the Internal Flash Memory or USB flash memory/external HDD formatted in either FAT16 or FAT32 when using BD-Live.
- The USB Flash Drive can be used for the local storage for enjoying BD-Live discs with Internet
- Do not extract the USB Flash Drive during operation (play, etc.).
- A USB Flash Drive which requires additional programme installation when you have connected it to a computer is not supported.
- USB Flash Drive: USB Flash Drive that support USB1.1 and USB2.0.
- Movie Files (DivX), Music files (MP3/WMA) and photo files (JPEG/PNG) can be played. For details of operations on each file, refer to relevant pages.
- Regular back up is recommended to prevent data loss.
- If you use a Card Reader, USB extension cable or USB HUB, the USB Flash Drive may not be recognized.
- Some USB Flash Drives may not work with this unit.
- Digital camera and mobile phone are not supported.
- USB Port of the unit cannot be connected to PC. The unit cannot be used as a storage device.
- When take off an active device connecting to USB port, please take it off after switching off the unit.
- When connecting with a USB cable, use the USB 2.0 cable those length is less than 1 m.

Using the Home Menu

From the Home Menu screen you can access all the Media for playback and setting of the unit.

1. Press HOME and the [Home Menu] appears.

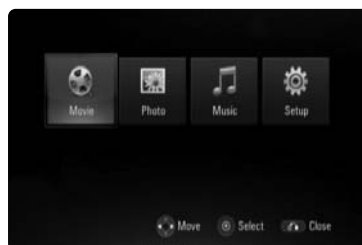

2. Use ◀▶ to select the desired option then press ENTER.

[Movie] – Start video media's playback or displays the [MOVIE] menu. (page 36)

[Photo] – Displays [PHOTO] menu. (page 39)

[Music] – Displays [MUSIC] menu. (page 37)

[Setup] – Displays [Setup] menu. (page 22)

Note:

When a disc and USB Flash Drive have the contents, it can choose those menus.

About Setup menu:

Menus	Buttons	Operations
◀▶ Move		Moves the cursor.
Select		Activates the selected item.
Close		Closes the menu.

Tip:

If you select the [Movie], [Photo] or [Music] option when a USB Flash Drive is connected and a disc is inserted simultaneously, the menu for selecting a media will appear. Select a media then press ENTER.

For example:

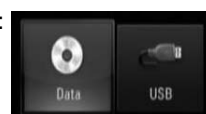

Notes:

- The unit will be in stop mode then the [Home Menu] will appear if you press HOME during playback.
- If you insert a DVD or an unplayable disc that is formatted as ISO9660 or UDF, the [Movie], [Photo] or [Music] option can be selected in the [Home Menu]. But you cannot play it.
- If the applicable file is not included, the "Empty" is appeared.

Initial Settings

By using the Setup menu, you can make various adjustments to items such as picture and sound. You can also set a language for the subtitles and the Setup menu, among other things. For details on each Setup menu item, see pages 22 to 26.

To display and exit the Menu:

Press HOME and the Home Menu appears. Select [Setup] then press ENTER, and Setup menu appears.

Press RETURN or HOME to exit the Setup menu.

To go to the next level:

Press ► on the Remote Control.

To go back to the previous level:

Press ◀ on the Remote Control.

General Operation

1. Press HOME and the Home Menu appears.
2. Select [Setup] and press ENTER. The Setup menu appears.



3. Use ▲ / ▼ to select the desired option then press ► to move to the second level. The screen shows the current setting for the selected item, as well as alternate setting(s).
4. Use ▲ / ▼ to select the second desired option then press ► to move to the third level.
5. Use ▲ / ▼ to select the desired setting then press ENTER to confirm your selection. Some items require additional steps.
6. Press RETURN or HOME to exit the Setup menu.

[DISPLAY] Menu



TV Aspect Ratio

[4:3 Letter Box] – Select when a standard 4:3 TV is connected. Displays theatrical images with masking bars above and below the picture.

[4:3 Pan Scan] – Select when a standard 4:3 TV is connected. Displays pictures cropped to fill your TV screen. Both sides of the picture are cut off.

[16:9 Original] – Select when a 16:9 wide TV is connected. The 4:3 picture is displayed with an original 4:3 aspect ratio, with black bars appearing at the left and right sides.

[16:9 Full] – Select when a 16:9 wide TV is connected. The 4:3 picture is adjusted horizontally (in a linear proportion) to fill the entire screen.

Notes:

- You cannot select [4:3 Letter Box] and [4:3 Pan Scan] option when the resolution is set to higher than 720p.
- This function may not work depending on the contents to play.

Resolution

Sets the output resolution of the Component and HDMI video signal. Refer to “Resolution Setting” on page 18 for details about the resolution.

1080p Display Mode

When the resolution is set to 1080p, select [24Hz] for smooth presentation of film material (1080p/24Hz) with an HDMI-equipped display compatible with 1080p/24Hz input.

Notes:

- When you select [24Hz], you may experience some picture disturbance when the video switches video and film material. In this case, select [60Hz].
- Even when [1080p Display Mode] is set to [24Hz], if your TV is not compatible with 1080p/24Hz, the actual frame frequency of the video output will be 60 Hz.

HDMI Color Setting

Select the type of output from the HDMI OUT jack. For this setting, please refer to the manuals of your display device.

[YCbCr] – Select when connecting to an HDMI display device.

[RGB] – Select when connecting to an RGB display device.

Note:

When you connect the HDMI OUT jack to DVI display device, the [HDMI Color Setting] will automatically switch to [RGB].

[LANGUAGE] Menu



Display Menu

Select a language for the [Setup] menu and on-screen display.

Disc Menu / Disc Audio / Disc Subtitle

Select the language you prefer for the audio track (disc audio), subtitles, and the disc menu.

[Original] – Refers to the original language in which the disc was recorded.

[Other] – Press ENTER to select another language. Use number buttons then ENTER to enter the corresponding 4-digit number according to the language code list on page 42.

[Off] (for Disc Subtitle) – Turn off Subtitle.

Note:

Depending upon the disc, your language setting may not work for some discs.

[AUDIO] Menu

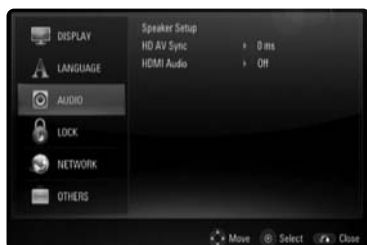

Speaker Setup

To obtain the best possible sound, use the Speaker Setup display to specify the volume of the speakers you have connected and their distance from your listening position. Use the Test to adjust the volume of the speakers to the same level.

[Speaker] – Select a speaker that you want to adjust.

[Volume] – Adjust the output level of each speaker. Be sure to set “Test” to “All” for easy adjustment.

[Distance] – Adjust the distance between each speaker and the listening position.

[Test] – The speakers will emit a test tone. All: The test tone is emitted from each speaker in sequence.

To save your settings, press ENTER and select [Yes] by pressing ◀ / ▶.

HD AV Sync

Sometimes Digital TV encounters a delay between picture and sound. If this happens you can compensate by setting a delay on the sound so that it effectively ‘waits’ for the picture to arrive: this is called HD AV Sync.

Use ▲ ▼ to scroll up and down through the delay amount, which you can set at anything between 0 and 300m sec.

The delay will vary depending on which digital TV channel you are on. If you change channel you may need to readjust the HD AV Sync.

HDMI Audio

You can set TV speaker output for the audio signal from the HDMI OUT jack.

[Off] – Audio signals are output to the system speakers only.

[On] – Audio signals are output from the TV’s speaker and the system’s front left and right speakers and subwoofer.

Note:

When [HDMI Audio] is set to [On], the sound mode is switched to [BYPASS] automatically.

[LOCK] Menu (Parental Control)

The [LOCK] settings affect only BD and DVD playback.



To access the any features in [LOCK] settings, you must enter the 4-digit security code you have created.

If you have not entered a password yet, you are prompted to do so. Enter a 4-digit password and press ENTER. Enter it again and press ENTER to verify.

Password

You can create, change or delete the password.

[New] – Enter a 4-digit password and press ENTER. Enter it again and press ENTER to create a new password.

[Change] – Enter the current password and press ENTER.

Enter a 4-digit password and press ENTER.

Enter it again and press ENTER to create a new password.

[Delete] – Enter the 4-digit password and press ENTER to delete the password.

Tip:

If you make a mistake before pressing ENTER, press CLEAR. Then input the correct password.

If you forget your password

If you forget your password, you can clear it using the following steps:

- 1 Remove any disc that might be in the player.
- 2 Highlight [Password] in the [LOCK] option.
- 3 Use Number buttons to enter “210499”. The password is cleared.

DVD Rating

Blocks playback of rated disc based on their content. (Not all discs are rated.)

[Rating 1-8] – Rating one (1) has the most restrictions and rating eight (8) is the least restrictive.

[Unlock] – If you select unlock, parental control is not active and the disc plays in full.

BD Rating

Set an age limit of BD-ROM play. Use number buttons to input an age limit for BD-ROM viewing.

[255] – All BD-ROM can be played.

[0-254] – Prohibits play of BD-ROM with corresponding ratings recorded on them.

Notes:

- The [BD rating] will be applied only for the BD disc that containing the Advanced Rating Control.

Area Code

Enter the code of the area whose standards were used to rate the DVD video disc, based on the list on page 42.

[NETWORK] Menu

The [NETWORK] settings are needed to use the BD Live and feature.

Some BD-ROM discs may enable you to access special BD-ROM sites, if you connect the player to the Internet. For example, if a BD-ROM site includes content such as links to future movie trailers, you can watch the downloaded on-line content on the player.

You do not need to connect to a PC to use this function.

Preparations:

- This feature requires an always-on broadband internet connection. (see page 17)
- A BD-ROM disc compatible with this feature is required. Not all BD-ROM discs are compatible.

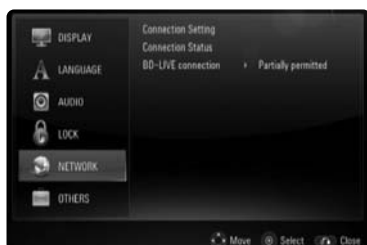

Connection Setting

If you have connected this player to a local area network (LAN), the player needs to be set up for network communication. (See “Internet connection” on pages 17)

Connection Status

If you want to check the network status on this player, select the [Connection Status] options and press ► or ENTER to check whether a connection to the network and the internet have been established.

BD-LIVE connection

You can restrict Internet access when BD-Live functions are used.

[Permitted] – Internet access is permitted for all BD-Live contents.

[Partially permitted] – Internet access is permitted only for BD-Live contents which have content owner certificates. Internet access and AAC Online functions are prohibited for all BD-Live contents without a certificate.

[Prohibited] – Internet access is prohibited for all BD-Live contents.

[OTHERS] Menu

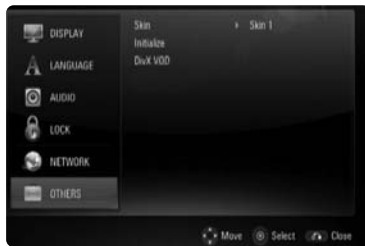

Skin

Changes the background of the initial screen.

Initialize

You can reset the player to its original factory settings, initialize the BD storage or deactivate the player.

[Factory Set] – If you need to, you can reset the player to all its factory settings. Some options cannot be reset. (Rating, Password and Area Code, etc.)

[BD Storage Clear] – Initializes the BD contents from the connected USB device.

DivX VOD

ABOUT DIVX VIDEO: DivX® is a digital video format created by DivX, Inc. This is an official DivX Certified device that plays DivX video. Visit www.divx.com for more information and software tools to convert your files into DivX videos.

ABOUT DIVX VIDEO-ON-DEMAND: This DivX® Certified device must be registered in order to play DivX Video-on-Demand (VOD) content.

To generate the registration code, locate the [DivX VOD] section in the [Setup] menu. Go to vod.divx.com with this code to complete the registration process and learn more about DivX VOD.

[DivX reg. Code] – Displays the registration code of your player.

[Deactivate] – Deactivate your player and display the deactivation code.

Note:

All the downloaded videos from DivX® VOD can only be played back on this unit.

Listening to music from your portable audio player

You can enjoy the sound of your portable audio player from the speakers of the system.

1. Connect the headphones (or line out) jack of the portable audio player into the PORT. IN on the rear panel of this unit:

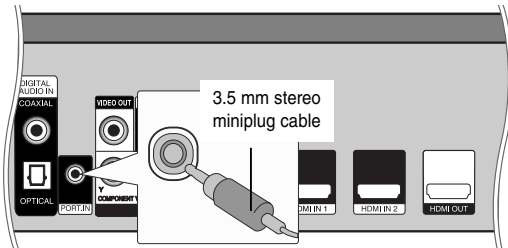

2. Press **⏻** to turn the power on.
3. Press INPUT to select [PORTABLE] option.
4. Press AUDIO VOL. (-) to turn down the volume of this unit.
5. Turn the portable audio player on and start it playing.
6. Adjust the volume of this unit and your portable audio player.

Listening to the sound from your component

You can enjoy the sound of your component with the analog audio output jacks from the speakers of the system.

1. Connect the analog audio output jacks of your component into the AUX L/R (INPUT) on the rear panel of this unit:

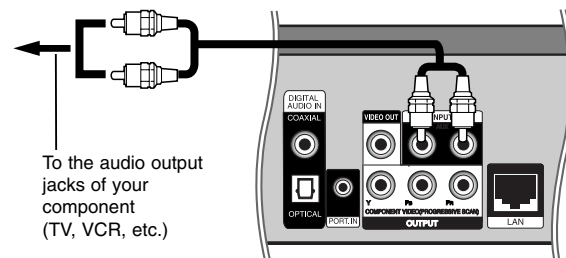

2. Press **⏻** to turn the power on.
3. Press INPUT to select [AUX] option.
4. Press AUDIO VOL. (-) to turn down the volume of this unit.
5. Turn your component on.
6. Use AUDIO VOL. (+/-) to adjust the volume.

Using HDMI IN jacks

You can enjoy the pictures and sound of your component with the HDMI OUT jack.

1. Connect the HDMI OUT jack of your component into the HDMI IN 1 or 2 jack on the rear panel of this unit.

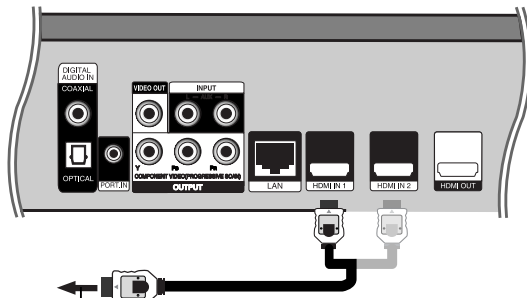

To the HDMI OUT jack of your component
(set-top box, digital satellite receiver, video game machine, etc.)

2. Press **POWER** to turn the power on.
3. Press **INPUT** to select [HDMI IN 1] or [HDMI IN 2] option.
4. Press **AUDIO VOL. (-)** to turn down the volume of this unit.
5. Turn your component on.
6. Use **AUDIO VOL. (+/-)** to adjust the volume of this unit.

Note:

- You cannot change the video resolution at the HDMI IN 1/2 mode.
Change the video resolution of the connected component.
- The setting of the sound mode is not available when Dolby Digital Plus, Dolby TrueHD and DTS-HD are played at HDMI IN 1/2 mode.
- If the video output signal is abnormal when your personal computer is connected to HDMI IN 1/2 jack, change the resolution of your personal computer to 480p, 720p, 1080i or 1080p.

Using DIGITAL AUDIO IN jacks

You can enjoy the sound of your component with the digital optical or coaxial output jack from the speakers of the system.

1. Connect the optical or coaxial output jack of your component into the OPTICAL or COAXIAL (DIGITAL AUDIO IN) jack on the rear panel of this unit.

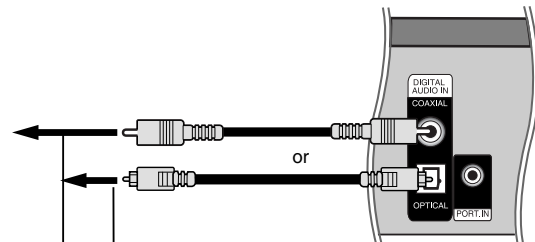

To the digital optical output jack of your component
To the digital coaxial output jack of your component

2. Press **POWER** to turn the power on.
3. Press **INPUT** to select [OPTICAL] or [COAXIAL] option.
4. Press **AUDIO VOL. (-)** to turn down the volume of this unit.
5. Turn your component on.
6. Use **AUDIO VOL. (+/-)** to adjust the volume.

Antenna Connection

Connect the supplied FM/AM antenna for listening to the radio.

- Connect the AM Loop antenna to the AM antenna connector.
- Connect the FM Wire antenna to the FM antenna connector.connector.

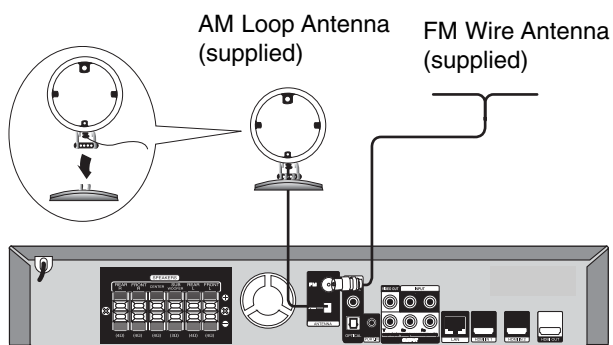

Notes:

- To prevent noise pickup, keep the AM Loop antenna away from the unit and other components.
- Be sure to fully extend the FM wire antenna.
- After connecting the FM Wire antenna, keep it as horizontal as possible.

Operations

General playback features

1. Load your chosen disc in the tray, with the playback side down.
2. Start playback using the HOME menu (see page 21).

Buttons	Operations	Discs
OPEN / CLOSE (▲)	Opens or closes the disc tray.	ALL
▶ (PLAY)	Starts the playback.	ALL
ENTER	Acknowledges the selection on the menu screen (Disc menu, Title menu, POP-UP menu, etc.).	BD DVD
■ (STOP)	Stops the playback. The button on the unit works as "ENTER".	ALL
	The unit records the stopped point, depending on the disc. "■■■" appears on the screen briefly. Press ▶ (PLAY) to resume playback (from the scene point). If you press ■ (STOP) again or unload the disc ("■" appears on the screen.), the unit will clear the stopped point. (■■■ = Resume Stop, ■ = Complete Stop)	BD DVD ACD MP3 AVCHD DivX WMA
	Notes: <ul style="list-style-type: none"> • The resume point may be cleared when a button is pressed (for example; STANDBY, OPEN/CLOSE, etc). • On BD-Video discs including BD-J, the resume play function does not work. • On BD-ROM interactive title, the unit will be in Complete Stop mode if you press ■ (STOP) once during playback. 	
⏸ (PAUSE)	During playback, press ⏸ (PAUSE) to pause playback. Tip: During Audio CD or MP3/WMA playback, press ⏸ (PAUSE) once again to resume playback. Press ⏸ (PAUSE) repeatedly to play Frame-by-Frame.	ALL DVD BD AVCHD DivX
⏮ / ⏭ (SKIP)	During playback, press ⏮ or ⏭ to go to the next chapter/track/file or to return to the beginning of the current chapter/track/file. Press ⏮ twice briefly to step back to the previous chapter/track/file.	ALL
⏪ / ⏩ (SCAN)	During playback, press SCAN (⏪ or ⏩) repeatedly to select the required scan speed. - DVD, BD, AVCHD, DivX: 5 steps, - Audio CD, MP3, WMA: 3 steps While the playback is paused, press SCAN ⏩ repeatedly to play in slow motion (4 steps, forward only).	ALL DVD BD AVCHD DivX
TITLE/POP-UP	If the current DVD or BD-ROM disc has a menu, the Title menu or Popup menu appears on the screen. Depending on the disc, the menu may not be available.	DVD BD AVCHD
DISC MENU	The menu appears on the screen. Depending on the disc, the menu may not be available.	DVD BD AVCHD

Continued →

General playback features (Continued)

Buttons	Operations	Discs
REPEAT	<p>Playing repeatedly: During playback, press REPEAT repeatedly to select a desired repeat mode. DVD, BD, AVCHD: Chapter/Title/Off Audio CD, MP3, WMA: Track/All/Off</p> <p>Note: If you press ►► once during Repeat Chapter/Track playback, the repeat playback cancels.</p> <hr/> <p>Repeating a specific portion (A-B): Selected portion will be repeated continually. Press REPEAT to select [A-] at the beginning of the portion you wish to repeat and press ENTER at the end of the portion. Your selected portion will be repeated continually. You cannot select a portion less than 3 seconds. To return to normal playback, press REPEAT repeatedly to select [OFF].</p> <p>Note: You cannot select a portion less than 3 seconds.</p>	<p>DVD BD ACD MP3 WMA AVCHD</p> <hr/> <p>DVD BD ACD</p>
SUBTITLE	<p>During playback, press SUBTITLE repeatedly to select a desired subtitle language.</p> <p>Note: Some discs allow you to change subtitle selections only via the disc menu. If this is the case, press TITLE/POP-UP or DISC MENU button and choose the appropriate subtitle from the selections on the disc menu.</p>	<p>DVD BD AVCHD DivX</p>

Notes on general features:

- When you turn on the player or replace a disc, the player returns to the initial default setting. Depending on a disc, a specific type of audio the disc has is output.
- Depending on the pre-recorded contents of the BD-ROM, some functions may not be available or may be operated differently than other media.

Additional features

If a disc menu screen is displayed

BD DVD AVCHD

The menu screen may be displayed first after loading a disc which contains a menu.

Use ◀ / ▶ / ▲ / ▼ buttons to select the title/chapter you want to view, then press ENTER to start playback.

Last Scene Memory **DVD BD**

This unit memorizes last scene from the last disc that is viewed. The last scene remains in memory even if you remove the disc from the unit or switch off the unit. If you load a disc that has the scene memorized, the scene is automatically recalled.

Notes:

- Settings are stored in memory for use any time.
- This unit does not memorize settings of a disc if you switch off the unit before commencing to play it.
- Last Scene Memory function for a previous disc is erased once a different disc is played.
- This function may not work depending on the disc.

Marker Search **BD DVD AVCHD DivX**

To enter a Marker

You can start playback from up to nine memorized points. To enter a marker, press MARKER at the desired point on the disc. The Marker icon appears on the TV screen briefly. Repeat to enter up to nine markers.

To Recall or Clear a Marked Scene

Press SEARCH and the search menu appears on the screen.

Press a number button to select a marker number that you want to recall. Playback starts from the marked scene.

OR

Press ▼ to highlight a marker number. Use ◀ / ▶ to select a marked scene that you want to recall or clear.

Press ENTER and playback starts from the marked scene. Press CLEAR and the marked scene is erased from the search menu.

Notes:

- This function may not work on some discs or titles.
- All marked points are cleared if you press STOP (■) twice (complete stop), the title is changed or if you unload the disc.

Hearing a different audio

BD DVD AVCHD DivX

During playback, press DISPLAY to display the playback menu.

Use ▲ ▼ to select the [Audio] option then use ◀ ▶ to select desired audio language or audio track.

Notes:

- Some discs allow you to change audio selections only via the disc menu. If this is the case, press TITLE/POP-UP or DISC MENU button and choose the appropriate audio from the selections on the disc menu.
- Immediately after you have switched sound, there may be a temporary discrepancy between the display and actual sound.
- On BD-ROM disc, the multi audio format (5.1CH or 7.1CH) is displayed with [MultiCH] in the on-screen display.

Using the search menu

BD DVD AVCHD DivX

During playback, press SEARCH to display the search menu.

Press ◀ ▶ to skip the playback 15 seconds forward or backward.

Tip:



You can select a point that you want to skip by pressing and holding ◀ / ▶ button.

Notes:

- This function may not work on some disc or titles.

Using Color (R, G, Y, B) Buttons **BD**

These buttons are available only during BD-J contents playback. Use the appropriate buttons as indicated by the display. Depending on the disc contents, the functions of each button may differ.

Screen Saver

The screen saver appears when you leave the player in Stop mode for about five minutes.

Changing content list view

ACD MP3 WMA DivX

On the [Movie], [Music], [Photo] menu, you can change the content list view by pressing DISPLAY repeatedly.

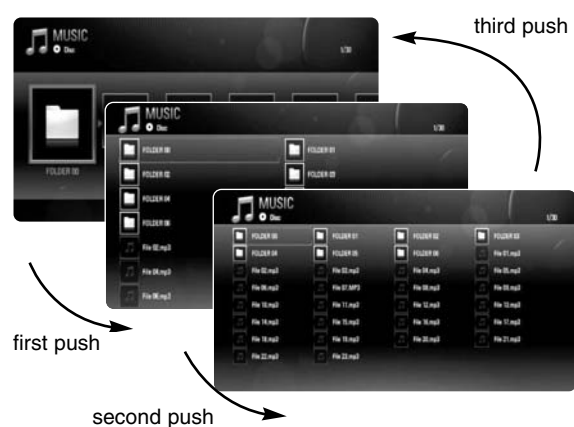

Note:

The equalizer will be disappeared when you change the music contents list view.

Displaying Disc Information On-Screen **DVD** **BD** **AVCHD** **DivX**

You can display various information about the disc loaded on-screen.

1. Press DISPLAY to show various playback information.
The items displayed differ depending on the disc type or playing status.



2. During BD-ROM or DVD playback, you can select an item by pressing ▲ / ▼ and change or select the setting by pressing ◀ / ▶.
 - Title/Track – Current title/track number/total number of titles/tracks.
 - Chapter – Current chapter number/total number of chapters.
 - Time – Elapsed playing time.
 - Audio – Selected audio language or channel.
 - Subtitle – Selected subtitle.
 - Angle – Selected angle/total number of angles.

Notes:

- If no button is pressed for a few seconds, the on-screen display disappears.
- A title number cannot be selected on some discs.
- An item may not be available on some discs or titles.
- If BD interactive title is playing back, some setting information is displayed on the screen but prohibited to be changed.

Enjoying BD-LIVE™ or BONUSVIEW™ in BD-Video **BD**

This unit allows you to enjoy functions such as picture-in-picture, secondary audio and Virtual packages, etc., with BD-Video supporting BONUSVIEW (BD-ROM version 2 Profile 1 version 1.1/ Final Standard Profile). In addition to the BONUSVIEW function, BD-Video supporting BD-Live (BD-ROM version 2 Profile 2) that has a network extension function allows you to enjoy more functions such as online games by connecting this unit to the Internet.

Enjoying BD-Live discs with Internet

This unit supports BD-Live, a new BD-Video function that allows you to use the following interactive functions when connected to the Internet. (The usable functions and the operating method may vary with each disc. For details, refer to the instructions for the disc.)

- Additional contents such as movie's trailer, subtitles and BD-J, etc. can be downloaded to the USB Flash Drive to play them.
- Special video data, etc. may be played back while they are being downloaded to a USB Flash Drive.

Preparations:

- The unit must be connected to the Internet and setup to use the BD-Live functions (see page 25).
- A USB Flash Drive is required to use this function. Connect a USB Flash Drive (see page 21).
- The free space in the USB Flash Drive must be more than 1GB.
- Please connect USB Flash Drive before playback the Disc.

Caution:

- Do not extract the connected USB Flash Drive while content is being downloaded or a Blu-ray disc is still in the disc tray. Doing so may damage the connected USB Flash Drive and BD-Live features may not operate properly with the damaged USB Flash Drive anymore.
If the connected USB Flash Drive seems damaged from such an action, you can format the connected USB Flash Drive from the PC and reuse it with this player.
- BD-Live on-line contents may not be downloaded because of insufficient space in the USB Flash Drive. In this case, please change USB Flash Drive with sufficient space or erase the data using [BD Storage Clear] option on the setup menu (See page 26 for details.)

Notes:

- Some BD-Live contents may be restrictively accessed in some territories by contents provider's own decision.

- It may take up to several minutes to load and start enjoying BD-Live contents.
- Depending on the disc, the BD-Live function may not be operated if [BD-LIVE connection] option is set to [Partially Permitted]. In this case, set [BD-LIVE connection] option to [Permitted] (See page 25.)
- The connection to the Internet may take time or the Internet may not be connected depending on the connection environment. It is required that you use a broadband connection.
- Do not remove the USB Flash Drive during operation. The USB Flash Drive may be damaged. Stop playback and turn off the menu beforehand.

Tip:

Special video data, etc. may be played back while they are being downloaded to a USB Flash Drive using one function of BD-Live. The playback may be paused depending on the communication environment.

Some functions may be disabled to prevent skipping to sections that have not been downloaded, etc.

AACS Online

When discs supporting BD-Live are played back, the player or disc IDs may be sent to the content provider via the Internet.

Services and functions to be provided differ depending on the disc.

- You can be introduced to other similar movies if you record your viewing history on the server by using these IDs.
- Game score histories can be saved.

Playing secondary video (picture-in-picture) and secondary audio

Secondary video can be played from a disc compatible with the picture-in-picture function.

For the playback method, refer to the instructions for the disc.

- To turn on/off secondary video, press PIP. Secondary video is played. Press the button to turn it ON or OFF.

Notes:

- Discs may not always be played back according to the settings on this unit, as certain playback formats are prioritized on certain discs.
- Only the primary video is played during search/slow-motion or frame-by-frame.
- This function may not work depending on the disc.

Playing a movie

The player can play movie files on the disc/USB device and video contents recorded on a DVD-RW(VR mode) discs. Before playing movie files, read "Movie file requirement"

Note:

- When the USB device is connected and a disc is inserted simultaneously, the menu for selecting a media will appear.
Select a media then press ENTER.
- You can use various playback functions. Refer to pages 30-31.
- On the [MOVIE] menu, use (G) or (Y) color button to move to the previous or next page.
- Unfinalized DVD VR format discs may not be played in this player.
- Some DVD-VR disc are made with CPRM data by DVD RECORDER. This unit cannot support these kinds of discs.
- Some DivX files may not play, depending on the DivX format or the recording format.
- Press DISC MENU to move to the list menu.
- This player can not play BDAV files.

What is CPRM?

CPRM is a copy protection system (with scramble system) only allowing the recording of 'copy once' broadcast programs. CPRM stands for Content Protection for Recordable Media.

Notice for displaying the DivX subtitle

If the subtitle does not display properly, change the language code as described below.

- 1** Press and hold SUBTITLE for 3 seconds during playback.
The language code will appear.
- 2** Press SUBTITLE repeatedly to select another language code until the subtitle is displayed properly and then press ENTER.

Movie file requirement

Movie file compatibility with this player is limited as follows:

Available resolution size: 1920 x 1080 (W x H) pixels

File extensions: ".avi", ".divx", ".mpg", ".mpeg", ".mp4", ".mkv"

Playable subtitle: SubRip (.srt / .txt), SAMI (.smi), SubStation Alpha (.ssa/.txt), MicroDVD (.sub/.txt), VobSub (.sub) SubViewer 1.0 (.sub), SubViewer 2.0 (.sub/.txt), TMPlayer (.txt), DVD Subtitle System (.txt)

Playable Codec format: "DIVX3.xx", "DIVX4.xx", "DIVX5.xx", "XVID", "DIVX6.xx" (Standard playback only), H.264/MPEG-4 AVC, DIVX-HD, MPEG1 SS, MPEG2 PS, MPEG2 TS

Playable Audio format: "Dolby Digital", "DTS", "MP3", "WMA", "AAC", "AC3"

Sampling frequency: within 32-48 kHz (WMA), within 16-48 kHz (MP3)

Bit rate: within 20-320 kbps (WMA), within 32-320 kbps (MP3)

CD-R/RW, DVD±R/RW, BD-R/RE Format: ISO 9660+JOLIET, UDF and UDF Bridge format

Maximum Files/Folder: Less than 2000

- The movie file name and subtitle are limited to 180 characters.
- Not all the WMA and AAC Audio format is compatible with this unit.
- HD movie files contained on the CD or USB 1.0/1.1 may not played properly. BD, DVD or USB 2.0 are recommended to play back HD movie files.
- This player support H.264/MPEG-4 AVC profile Main, High at Level 4.1.
For a file with higher level, the player will ask whether you want to play or not.
- This player does not support the file that are recorded with GMC*1 or Qpel*2. Those are video encoding techniques in MPEG4 standard, like DivX or XVID have.

*1 GMC – Global Motion Compensation

*2 Qpel – Quarter pixel

Listening to music

The player can play Audio CDs and MP3/WMA files. Before playing MP3/WMA files, read "MP3/WMA audio file requirement".

Note:

- When the USB device is connected and a disc is inserted simultaneously, the menu for selecting a media then press ENTER.
- You can use various playback functions. Refer to pages 30-31.

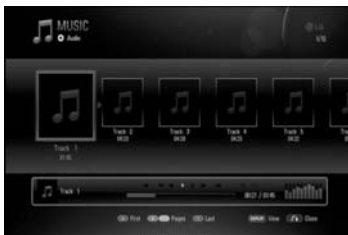

Example) Audio CD

Tips:

- To go directly to any track or file and play, enter the track/file number using the numbered buttons (0-9).
- The playback may start automatically if the Audio CD inserted.
- Use ▲/▼/◀/▶ to select a folder then press ENTER and you can view the files in the folder. If you want to move to the upper or lower directory, use ▲/▼ to move to the desired directory.
- On the [MUSIC] menu, use red or blue button to move to the first or the last file or track and green or yellow button to move to the previous or next page.
- The equalizer indicator is not coupled with the music in play back.
- If there is impossible code to express in the file name, it may be displayed as illegible.

MP3/WMA audio file requirement

File extensions: ".mp3", ".wma"

Sampling frequency: within 8-48 kHz (WMA), within 11-48 kHz (MP3)

Bit rate: within 8-320 kbps (WMA, MP3)

CD-R/RW, DVD±R/RW, BD-R/RE Format: ISO 9660+JOLIET, UDF and UDF Bridge format

Maximum Files/Folder: Less than 2000 (total number of files and folders)

Notes on MP3/WMA file

- Depending on the size and number of the MP3/WMA files, it may take several minutes to read the contents of the media.
- This unit cannot support the ID3 Tag embedded in the MP3 file.
- The total playback time indicated on the screen may not correct for VBR files.

Presetting the Radio Stations

You can preset 50 stations for FM and AM (MW). Before tuning, make sure that you have turned down the volume.

1. Press TUNER to select FM or AM (MW).
2. Press TUNING.(-/+) to choose the station.
3. Press ENTER to memorize or clear the station.

Listening to the Radio

Preset radio stations in the unit memory first see "Presetting the radio stations".

1. Press TUNER to select FM or AM (MW).
The last received station is tuned in.
2. Press PRESET (-/+) repeatedly on the remote control to select the preset station you want.
Each time you press the button, the unit tunes in one preset station at a time.
3. Adjust the volume pressing VOLUME (-/+) on the front panel or by pressing AUDIO VOL(-/+) on the remote control repeatedly.

To turn off the radio

Press  to turn the unit off.

To listen to non-preset radio stations

- Use manual or automatic tuning in the step 2.
- For manual tuning, press TUNING.(-/+) repeatedly.
- For automatic tuning, press and hold TUNING.(-/+) for about two seconds.

To select a preset radio station directly

You can use the number buttons on the remote control to select a preset radio station directly. For example, to listen to the preset station 4, press 4 on the remote control. To listen to the preset station 19, press 1 and then 9 (within 3 seconds).

For your reference

● If an FM program is noisy

To appear "STEREO", press MO./ST. Then press again this button to make "MONO" appear in the display window. There will be no stereo effect, but the reception will improve. Press the button again to restore the stereo effect.

● To improve reception

Reorient the supplied antennas.

Viewing a photo

This unit can play a photo files. Before playing photo files, read "Photo file requirement".

Note:

- When the USB device is connected and a disc is inserted simultaneously, the menu for selecting a media will appear. Select a media then press ENTER.
- You can start the slide show by pressing PLAY (▶) while photo file is selected in the [PHOTO] menu.
- On the [PHOTO] menu, use red or blue button to move to the first or the last file and green or yellow button to move to the previous or next page.
- You can change the content list view by pressing DISPLAY repeatedly.

Photo file requirement

File extensions: ".jpg", ".jpeg", ".png"

Recommended size:

Less than 4,000 x 3,000 x 24 bit/pixel

Less than 3,000 x 3,000 x 32 bit/pixel

CD-R/RW, DVD±R/RW, BD-R/RE Format:

ISO 9660+JOLIET, UDF and UDF Bridge format

Maximum Files/Disc:

Less than 2000 (total number of files and folders)

Notes on Photo file

- Progressive and lossless compression photo image files are not supported.
- Depending on the size and number of the photo files, it may take several minutes to read the contents of the media.

Options during viewing a photo file in full screen

You can use various options during viewing a picture in full screen.

Use ▲▼◀▶ to select an option and use the options as described below.

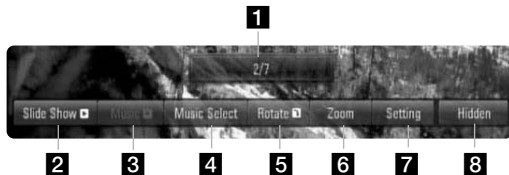

- 1** Use ◀▶ to advance to the previous or next file.
- 2** Press ENTER to start or pause the slide show.
- 3** Press ENTER to play or pause the background music. This option is available after the background music is selected using [Music Select] option.
- 4** Selects the background music.
 - 1) Press ENTER and the menu will appear.
 - 2) Use ▲▼◀▶ to select a media or folder that there are music file(s).
 - 3) Press ENTER to confirm your selection.
- 5** Press ENTER to rotate the picture clockwise. This option is not available during slide show.

- 6** Use green or yellow buttons to zoom in or out the picture. You can move through the zoomed picture using ▲▼◀▶ buttons. Press RETURN to exit the [Zoom] menu and return to the normal picture size.
- 7** Use ▲▼ to selects an option between [Effect] or [Delay]. Use ◀▶ to adjusts and press ENTER to set the selected option.

[Effects] – You can apply various effects when sliding photos.

 - OFF : Slide Show without any effect.
 - Random : Slide show effects are applied randomly.
 - Slide : Slides a photo from various direction.
 - Door : Photo will be appear like door opening.
 - Lattice : Photo will be appear from tiled pieces to full screen image

[Delay] – You can set the photo delaying time while Slide Show.
- 8** Press ENTER to exit the option menu. To appear the menu again, press ENTER.

Reference

Controlling a TV with the Supplied Remote Control

You can control the volume, input source, and power state of your JVC TV with the supplied Remote Control.

You can control your TV using the buttons below.



TV Control Buttons

By pressing	You can
TV POWER	Turn the TV on or off.
INPUT	Switch the TV's input source between the TV and other input sources.
CH +/-	Scan up or down through memorized channels.
VOL +/-	Adjust the volume of the TV.

Note

Some functions may not work correctly depending on TV.

Language Codes

Use this list to input your desired language for the following initial settings: [Disc Audio], [Disc Subtitle] and [Disc Menu].

Language	Code	Language	Code	Language	Code	Language	Code
Abkhazian	6566	Fiji	7074	Lingala	7678	Singhalese	8373
Afar	6565	Finnish	7073	Lithuanian	7684	Slovak	8375
Afrikaans	6570	French	7082	Macedonian	7775	Slovenian	8376
Albanian	8381	Frisian	7089	Malagasy	7771	Somali	8379
Ameharic	6577	Galician	7176	Malay	7783	Spanish	6983
Arabic	6582	Georgian	7565	Malayalam	7776	Sudanese	8385
Armenian	7289	German	6869	Maltese	7784	Swahili	8387
Assamese	6583	Greek	6976	Maori	7773	Swedish	8386
Aymara	6589	Greenlandic	7576	Marathi	7782	Tagalog	8476
Azerbaijani	6590	Guarani	7178	Moldavian	7779	Tajik	8471
Bashkir	6665	Gujarati	7185	Mongolian	7778	Tamil	8465
Basque	6985	Hausa	7265	Nauru	7865	Tatar	8484
Bengali; Bangla	6678	Hebrew	7387	Nepali	7869	Telugu	8469
Bhutani	6890	Hindi	7273	Norwegian	7879	Thai	8472
Bihari	6672	Hungarian	7285	Oriya	7982	Tibetan	6679
Breton	6682	Icelandic	7383	Panjabi	8065	Tigrinya	8473
Bulgarian	6671	Indonesian	7378	Pashto, Pushto	8083	Tonga	8479
Burmese	7789	Interlingua	7365	Persian	7065	Turkish	8482
Byelorussian	6669	Irish	7165	Polish	8076	Turkmen	8475
Cambodian	7577	Italian	7384	Portuguese	8084	Twi	8487
Catalan	6765	Japanese	7465	Quechua	8185	Ukrainian	8575
Chinese	9072	Javanese	7487	Rhaeto-Romance	8277	Urdu	8582
Corsican	6779	Kannada	7578	Rumanian	8279	Uzbek	8590
Croatian	7282	Kashmiri	7583	Russian	8285	Vietnamese	8673
Czech	6783	Kazakh	7575	Samoan	8377	Volapük	8679
Danish	6865	Kirghiz	7589	Sanskrit	8365	Welsh	6789
Dutch	7876	Korean	7579	Scots Gaelic	7168	Wolof	8779
English	6978	Kurdish	7585	Serbian	8382	Xhosa	8872
Esperanto	6979	Laothian	7679	Serbo-Croatian	8372	Yiddish	7473
Estonian	6984	Latin	7665	Shona	8378	Yoruba	8979
Faroese	7079	Latvian, Lettish	7686	Sindhi	8368	Zulu	9085

Area Codes

Choose an Area code from this list.

Area	Code	Area	Code	Area	Code	Area	Code
U.A.E	AE	Ethiopia	ET	Malaysia	MY	Saudi Arabia	SA
Afghanistan	AF	Fiji	FJ	Maldives	MV	Senegal	SN
Argentina	AR	Finland	FI	Mexico	MX	Singapore	SG
Australia	AU	France	FR	Monaco	MC	Slovak Republic	SK
Austria	AT	Germany	DE	Mongolia	MN	Slovenia	SI
Belgium	BE	Great Britain	GB	Morocco	MA	South Africa	ZA
Bhutan	BT	Greece	GR	Nepal	NP	South Korea	KR
Bolivia	BO	Greenland	GL	Netherlands	NL	Spain	ES
Brazil	BR	Herd and McDonald Islands	HM	Netherlands Antilles	AN	Sri Lanka	LK
Cambodia	KH	Hong Kong	HK	New Zealand	NZ	Sweden	SE
Canada	CA	Hungary	HU	Nigeria	NG	Switzerland	CH
Chile	CL	India	IN	Norway	NO	Taiwan	TW
China	CN	Indonesia	ID	Oman	OM	Thailand	TH
Colombia	CO	Israel	IL	Pakistan	PK	Turkey	TR
Congo	CG	Italy	IT	Panama	PA	Uganda	UG
Costa Rica	CR	Jamaica	JM	Paraguay	PY	Ukraine	UA
Croatia	HR	Japan	JP	Philippines	PH	United States	US
Czech Republic	CZ	Kenya	KE	Poland	PL	Uruguay	UY
Denmark	DK	Kuwait	KW	Portugal	PT	Uzbekistan	UZ
Ecuador	EC	Libya	LY	Romania	RO	Vietnam	VN
Egypt	EG	Luxembourg	LU	Russian Federation	RU	Zimbabwe	ZW

Troubleshooting

Symptom	Possible Cause	Correction
No power.	<ul style="list-style-type: none"> The power cord is disconnected. 	<ul style="list-style-type: none"> Plug the power cord into the wall outlet securely.
The power is on, but the player does not work.	<ul style="list-style-type: none"> No disc is inserted. 	<ul style="list-style-type: none"> Insert a disc. (Check the disc indicator in the display window is lit.)
No picture.	<ul style="list-style-type: none"> The TV is not set to receive DVD signal output. 	<ul style="list-style-type: none"> Select the appropriate video input mode on the TV.
	<ul style="list-style-type: none"> The video cable is not connected securely. 	<ul style="list-style-type: none"> Connect the video cable securely.
	<ul style="list-style-type: none"> The selected resolution is not capable with your TV. 	<ul style="list-style-type: none"> Select another resolution using RESOLUTION button.
No sound.	<ul style="list-style-type: none"> The equipment connected with the audio cable is not set to receive disc signal output. 	<ul style="list-style-type: none"> Select the correct input mode of the audio receiver so you can listen to the sound from the player.
	<ul style="list-style-type: none"> The power of the equipment connected with the audio cable is turned off. 	<ul style="list-style-type: none"> Turn on the equipment connected with the audio cable.
	<ul style="list-style-type: none"> The [AUDIO] options are set to the wrong position. 	<ul style="list-style-type: none"> Set the [AUDIO] options to the correct position (see page 23).
	<ul style="list-style-type: none"> The player is in reverse play, fast forward, slow motion or pause mode. 	<ul style="list-style-type: none"> Return to the normal playback.
The player does not start playback.	<ul style="list-style-type: none"> The disc is upside down. 	<ul style="list-style-type: none"> Insert the disc with the playback side down.
	<ul style="list-style-type: none"> An unplayable disc is inserted. 	<ul style="list-style-type: none"> Insert a playable disc. (Check the disc type and regional code.)
	<ul style="list-style-type: none"> The rating level is set. 	<ul style="list-style-type: none"> Change the rating level.
	<ul style="list-style-type: none"> The disc was recorded on another unit and was not finalized. 	<ul style="list-style-type: none"> Finalize the disc on that unit.
The Remote Control does not work properly.	<ul style="list-style-type: none"> The Remote Control is not pointed at the remote sensor on the player. 	<ul style="list-style-type: none"> Point the Remote Control at the remote sensor of the player.
	<ul style="list-style-type: none"> The Remote Control is too far from the player. 	<ul style="list-style-type: none"> Operate the Remote Control closer to the player.
BD-Live feature does not work.	<ul style="list-style-type: none"> External USB device is not connected. 	<ul style="list-style-type: none"> Connect a FAT16 or FAT32 formatted USB device to the USB port (see page 21).
	<ul style="list-style-type: none"> The connected USB device does not have enough space. 	<ul style="list-style-type: none"> Secure at least 1GB free space in the USB device for using BD-Live features.
	<ul style="list-style-type: none"> Internet connection is not established. 	<ul style="list-style-type: none"> Ensure that the unit is correctly connected to the local area network and can access the internet (see page 17).
	<ul style="list-style-type: none"> The [BD-LIVE connection] option in the [Setup] menu is set to [Prohibited]. 	<ul style="list-style-type: none"> Set the [BD-LIVE connection] option to [Permitted].

Troubleshooting

Symptom	Possible Cause	Correction
Radio stations cannot be tuned in.	<ul style="list-style-type: none">The signal strength of the stations is too weak (when tuning in with automatic tuning).	<ul style="list-style-type: none">Use direct tuning.

Resetting the Player

If you observe any of the following symptoms.

- When the Player is plugged in, but the power will not turn on or off.
- When the display window is not working.
- **When the Player does not operate normally.**

You can reset the Player as follows:

- Press and hold the STANDBY button for more than five seconds. This will force the Player to power off. Press the STANDBY button again to turn the Player back on.
- Unplug the power cord and then plug the power cord again after more than five seconds.

Specifications

General

Power requirements:	AC 110 - 240 V, 50/60 Hz
Power consumption	
(in operation):	130 W
(on standby):	Less than 1W
Dimensions (W x H x D):	Approx. 430 x 76 x 379 mm without foot
Net Weight (Approx.):	4.8 kg
Operating temperature:	41 °F to 95 °F (5 °C to 35 °C)
Operating humidity:	5 % to 90 %

Inputs/Outputs

VIDEO OUT:	1.0 V (p-p), 75 Ω, sync neg ative, RCA jack x 1
COMPONENT VIDEO OUT:	(Y) 1.0 V (p-p), 75 Ω, sync negative, RCA jack x 1 (Pb)/(Pr) 0.7 V (p-p), 75 Ω, RCA jack x 2
HDMI OUT (video/audio):	19 pin (HDMI standard, Type A)
HDMI IN (video/audio):	19 pin (HDMI standard, Type A)
ANALOG AUDIO IN:	2.0 Vrms (1 kHz, 0 dB), 600 Ω, RCA jack (L, R) x 1
DIGITAL IN (COAXIAL):	0.5 V (p-p), 75 Ω, RCA jack x 1
DIGITAL IN (OPTICAL):	3 V (p-p), Optical jack x 1
PORT. IN:	0.5 Vrms (3.5 ϕ stereo jack)
Bus power supply	5V --- 500 mA

Tuner

FM Tuning Range:	87.5 - 108.0 MHz
AM Tuning Range:	522 - 1,620 kHz

Amplifier

Stereo mode:	PEAK Power 155 W + 155 W (4Ω at 1 KHz) RMS Power 130 W + 130 W (4Ω at 1 KHz, THD 10%)
Surround mode:	Front PEAK Power 155 W + 155 W (4Ω at 1 KHz) RMS Power 130 W + 130 W (4Ω at 1 KHz, THD 10%) Center PEAK Power 155 W (4Ω at 1 KHz) RMS Power 130 W (4Ω at 1 KHz, THD 10%) Surround PEAK Power 155 W + 155 W (4Ω at 1 KHz) RMS Power 130 W + 130 W (4Ω at 1 KHz, THD 10%) Subwoofer PEAK Power 225 W (3Ω at 60 Hz) RMS Power 180 W (3Ω at 60 Hz, THD 10%)

Note: Design and specifications are subject to change without prior notice.

Specifications

System

Laser:	Semiconductor laser, wavelength: 405nm / 650 nm
Signal system:	Standard PAL/NTSC color TV system
Frequency response:	20 Hz to 20 kHz (48 kHz, 96 kHz, 192 kHz sampling)
Signal-to-noise ratio:	More than 100 dB (ANALOG OUT connectors only)
Harmonic distortion:	Less than 0.008%
Dynamic range:	More than 95 dB
LAN port:	Ethernet jack x 1, 10BASE-T/100BASE-TX

Speakers

Front/ Rear speaker

Type:	1 Way 1 speaker
Impedance Rated:	4Ω
Input Power:	155 W
Max. Input power:	310 W
Net Dimensions (W x H x D):	111 x 209 x 83 mm
Net Weight:	0.8 kg

Center speaker

Type:	1 Way 1 speaker
Impedance Rated:	4Ω
Input Power:	155 W
Max. Input power:	310 W
Net Dimensions (W x H x D):	301 x 118 x 83 mm
Net Weight:	0.9 kg

Passive Subwoofer

Type:	1 Way 1 speaker
Impedance Rated:	3Ω
Input Power:	225 W
Max. Input power:	450 W
Net Dimensions (W x H x D):	236 x 435 x 391 mm
Net Weight:	5.7 kg

Accessories

Speaker cable (6), Remote control (1), Battery (1), FM antenna (1), AM antenna(1), Video cable (1)

Open source software notice

This product includes

- Freetype library : copyright © 2003 The FreeType Project (www.freetype.org).
- libpng library : copyright © 2004 Glenn Randers-Pehrson
- Zlib compression library: Copyright © 1995-2002 Jean-loup Gailly and Mark Adler.
- Expat library : copyright © 2006 expat maintainers.
- OpenSSL library :
 - cryptographic software written by Eric Young (eay@cryptsoft.com).
 - software written by Tim Hudson (tjh@cryptsoft.com).
 - software developed by the OpenSSL Project for use in the OpenSSL Toolkit. (<http://www.openssl.org>)
- libcurl library : Copyright © 1996 - 2008, Daniel Stenberg, daniel@haxx.se
- boost C++ library : © Copyright Beman Dawes 1999-2003
- UPnP SDK : Copyright © 2000-2003 Intel Corporation
- Libnet : © 1998 - 2004 Mike D. Schiffman mike@infonexus.com
- Libpcap

This product includes other open source software.

- Copyright © David L. Mills 1992-2006
- Copyright © 1998-2003 Daniel Veillard.
- Copyright © 1998, 1999 Thai Open Source Software Center Ltd.
- Copyright © 1990 The Regents of the University of California.
- Copyright © 1998-2005 The OpenSSL Project.
- Copyright © 1991, 1992 Paul Kranenburg <pk@cs.few.eur.nl>
- Copyright © 1993 Branko Lankester <branko@hacktic.nl>
- Copyright © 1993 Ulrich Pegelow <pegelow@moorea.uni-muenster.de>
- Copyright © 1995, 1996 Michael Elizabeth Chastain <mec@duracef.shout.net>
- Copyright © 1993, 1994, 1995, 1996 Rick Sladkey <jrs@world.std.com>
- Copyright © 1999,2000 Wichert Akkerman <wakkerma@debian.org>

All rights reserved.

Permission is hereby granted, free of charge, to any person obtaining a copy of this software and associated documentation files (the "Software"), to deal in the Software without restriction, including without limitation the rights to use, copy, modify, merge, publish, distribute, sublicense, and/or sell copies of the Software, and to permit persons to whom the Software is furnished to do so, subject to the following conditions:

THE SOFTWARE IS PROVIDED "AS IS", WITHOUT WARRANTY OF ANY KIND, EXPRESS OR IMPLIED, INCLUDING BUT NOT LIMITED TO THE WARRANTIES OF MERCHANTABILITY, FITNESS FOR A PARTICULAR PURPOSE AND NONINFRINGEMENT. IN NO EVENT SHALL THE AUTHORS OR COPYRIGHT HOLDERS BE LIABLE FOR ANY CLAIM, DAMAGES OR OTHER LIABILITY, WHETHER IN AN ACTION OF CONTRACT, TORT OR OTHERWISE, ARISING FROM, OUT OF OR IN CONNECTION WITH THE SOFTWARE OR THE USE OR OTHER DEALINGS IN THE SOFTWARE.

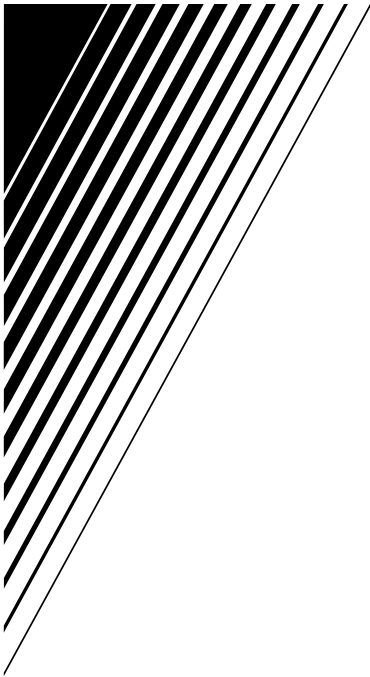

TH-BD50

JVC

EN

© 2009 Victor Company of Japan, Limited

0909SKMLGEEGL
P/N: MFL62863582



Free Manuals Download Website

<http://myh66.com>

<http://usermanuals.us>

<http://www.somanuals.com>

<http://www.4manuals.cc>

<http://www.manual-lib.com>

<http://www.404manual.com>

<http://www.luxmanual.com>

<http://aubethermostatmanual.com>

Golf course search by state

<http://golfingnear.com>

Email search by domain

<http://emailbydomain.com>

Auto manuals search

<http://auto.somanuals.com>

TV manuals search

<http://tv.somanuals.com>