

# JVC

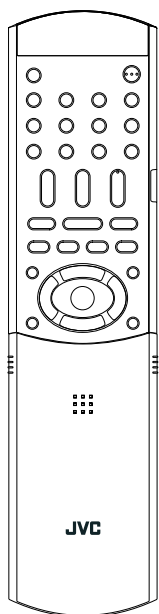

## HOME CINEMA CONTROL CENTER

# RX-ES9SL



DIGITAL  
**dts**  
SURROUND

**DD** DOLBY  
DIGITAL  
PRO LOGIC II

**R-D-S**

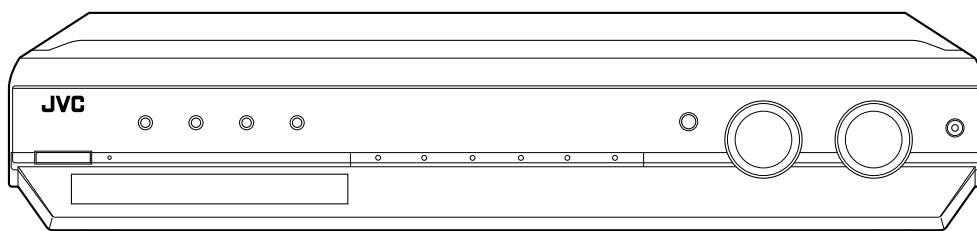

## INSTRUCTIONS

**For Customer Use:**

Enter below the Model No. and Serial No. which are located either on the rear, bottom or side of the cabinet. Retain this information for future reference.

Model No. \_\_\_\_\_

Serial No. \_\_\_\_\_

LVT1112-001A

[B]

## Warnings, Cautions, and Others

**IMPORTANT** for the U.K.

**DO NOT** cut off the mains plug from this equipment. If the plug fitted is not suitable for the power points in your home or the cable is too short to reach a power point, then obtain an appropriate safety approved extension lead or consult your dealer.

**BE SURE** to replace the fuse only with an identical approved type, as originally fitted.

If nonetheless the mains plug is cut off ensure to remove the fuse and dispose of the plug immediately, to avoid a possible shock hazard by inadvertent connection to the mains supply.

If this product is not supplied fitted with a mains plug then follow the instructions given below:

**IMPORTANT**

**DO NOT** make any connection to the terminal which is marked with the letter E or by the safety earth symbol or coloured green or green-and-yellow.

The wires in the mains lead on this product are coloured in accordance with the following code:

Blue : Neutral  
Brown : Live

As these colours may not correspond with the coloured markings identifying the terminals in your plug proceed as follows:

The wire which is coloured blue must be connected to the terminal which is marked with the letter N or coloured black.

The wire which is coloured brown must be connected to the terminal which is marked with the letter L or coloured red.

**IF IN DOUBT - CONSULT A COMPETENT ELECTRICIAN.**

**CAUTION**

To reduce the risk of electrical shocks, fire, etc.:

1. Do not remove screws, covers or cabinet.
2. Do not expose this appliance to rain or moisture.

**Caution—STANDBY/ON  $\odot$ /I button!**

Disconnect the mains plug to shut the power off completely. The STANDBY/ON  $\odot$ /I button in any position does not disconnect the mains line. The power can be remote controlled.



**CAUTION**

- Do not block the ventilation openings or holes.  
(If the ventilation openings or holes are blocked by a newspaper or cloth, etc., the heat may not be able to get out.)
- Do not place any naked flame sources, such as lighted candles, on the apparatus.
- When discarding batteries, environmental problems must be considered and local rules or laws governing the disposal of these batteries must be followed strictly.
- Do not expose this apparatus to rain, moisture, dripping or splashing and that no objects filled with liquids such as vases, shall be placed on the apparatus.

**Caution: Proper Ventilation**

To avoid risk of electric shock and fire and to protect from damage.

Locate the apparatus as follows:

- Front: No obstructions open spacing.
- Sides: No obstructions in 10 cm from the sides.
- Top: No obstructions in 10 cm from the top.
- Back: No obstructions in 15 cm from the back
- Bottom: No obstructions, place on the level surface.

In addition, maintain the best possible air circulation as illustrated.

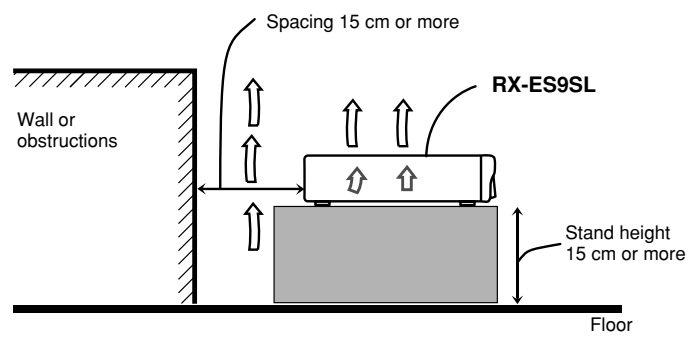

\* Do not stack RX-ES9SL and other components.



**SAFETY INSTRUCTIONS**  
**“SOME DOS AND DON'TS ON THE SAFE USE OF EQUIPMENT”**

This equipment has been designed and manufactured to meet international safety standards but, like any electrical equipment, care must be taken if you are to obtain the best results and safety is to be assured.

\*\*\*\*\*

Do read the operating instructions before you attempt to use the equipment.

Do ensure that all electrical connections (including the mains plug, extension leads and interconnections between pieces of equipment) are properly made and in accordance with the manufacturer's instructions. Switch off and withdraw the mains plug when making or changing connections.

Do consult your dealer if you are ever in doubt about the installation, operation or safety of your equipment.

Do be careful with glass panels or doors on equipment.

\*\*\*\*\*

DON'T continue to operate the equipment if you are in any doubt about it working normally, or if it is damaged in any way – switch off, withdraw the mains plug and consult your dealer.

DON'T remove any fixed cover as this may expose dangerous voltages.

DON'T leave equipment switched on when it is unattended unless it is specifically stated that it is designed for unattended operation or has a standby mode.  
 Switch off using the switch on the equipment and make sure that your family know how to do this.

Special arrangements may need to be made for infirm or handicapped people.

DON'T use equipment such as personal stereos or radios so that you are distracted from the requirements of traffic safety. It is illegal to watch television whilst driving.

DON'T listen to headphones at high volume as such use can permanently damage your hearing.

DON'T obstruct the ventilation of the equipment, for example with curtains or soft furnishings.

Overheating will cause damage and shorten the life of the equipment.

DON'T use makeshift stands and NEVER fix legs with wood screws — to ensure complete safety always fit the manufacturer's approved stand or legs with the fixings provided according to the instructions.

DON'T allow electrical equipment to be exposed to rain or moisture.

ABOVE ALL

- NEVER let anyone, especially children, push anything into holes, slots or any other opening in the case -this could result in a fatal electrical shock.;
- NEVER guess or take chances with electrical equipment of any kind — it is better to be safe than sorry!



# Table of Contents

<b>Parts identification</b> .....	<b>2</b>
<b>Getting started</b> .....	<b>4</b>
Before installation .....	4
Checking the supplied accessories .....	4
Putting batteries in the remote control .....	4
Connecting the FM and AM (MW) antennas .....	5
Connecting the speakers .....	6
Connecting video components .....	7
Connecting the power cord .....	10
<b>Basic operations</b> .....	<b>11</b>
1 Turn on the power .....	11
2 Select the source to play .....	11
3 Adjust the volume .....	12
Selecting the digital decode mode .....	12
Activating TV Direct .....	13
Turning off the sounds temporarily—Muting .....	13
Turning off the power with the Sleep Timer .....	14
Changing the display brightness .....	14
<b>Speaker settings</b> .....	<b>15</b>
Setting the speakers information automatically —Smart Surround Setup .....	15
Setting the speakers and subwoofer information quickly —Quick Setup .....	16
Setting the speakers and subwoofer information manually —Manual Setup .....	17
<b>Basic settings</b> .....	<b>19</b>
Operating procedure .....	19
Setting the digital input (DIGITAL IN) terminals—DIGITAL IN .....	19
Setting Auto Surround—AUTO SR .....	20
Setting the Auto Function mode—MODE .....	20
<b>Sound adjustments</b> .....	<b>21</b>
Operating procedure .....	21
Adjusting the tone—BASS, TREBLE .....	21
Adjusting the subwoofer output level—SUBWFR .....	21
Adjusting the front speakers output balance—BAL .....	22
Reinforcing the bass—B.BOOST .....	22
Attenuating the input signal—ATT .....	22
<b>Tuner operations</b> .....	<b>23</b>
Tuning in to stations manually .....	23
Using preset tuning .....	23
Selecting the FM reception mode .....	24
Using the RDS (Radio Data System) to receive FM stations .....	25
Searching for a program by PTY codes .....	26
Switching to broadcast program of your choice temporarily .....	27
<b>Creating realistic sound fields</b> .....	<b>28</b>
Reproducing theater ambience .....	28
Introducing the Surround/DSP modes .....	28
About relations between speaker layout and Surround/DSP modes .....	30
Using Surround modes .....	30
Using DSP modes .....	32
<b>Using the DVD MULTI playback mode</b> .....	<b>34</b>
Activating the DVD MULTI playback mode .....	34
Adjusting the speaker output level .....	34
<b>Operating other JVC products</b> .....	<b>35</b>
<b>Operating other manufacturers' equipment</b> .....	<b>36</b>
<b>Troubleshooting</b> .....	<b>38</b>
<b>Specifications</b> .....	<b>40</b>

# Parts identification

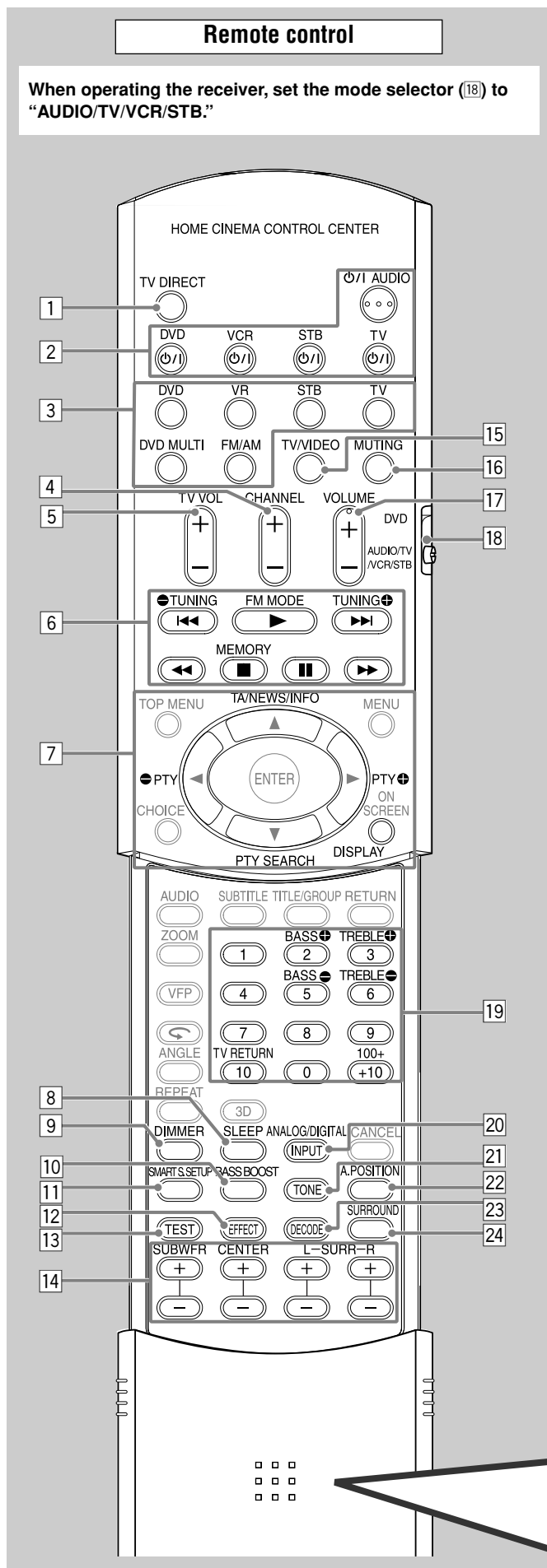

See pages in parentheses for details.

- 1 TV DIRECT button (13)
- 2 Standby/on buttons (11, 35 – 37)  
⓪/I AUDIO, DVD ⓪/I, VCR ⓪/I, STB ⓪/I, TV ⓪/I
- 3 Source selecting buttons (11)  
DVD, VR\*, STB, TV, DVD MULTI, FM/AM
- 4 CHANNEL +/- buttons (35 – 37)
- 5 TV VOL (volume) +/- buttons (35, 37)
- 6 • Operating buttons for video components (35, 37)  
◀◀, ▶▶, ▶▶▶, ◀◀◀, ■, ||, ▶▶▶  
• Operating buttons for tuner (23, 24)  
TUNING Ⓡ, TUNING Ⓢ, FM MODE, MEMORY
- 7 Operating buttons for RDS (25 – 27)  
PTY Ⓡ, PTY Ⓢ, PTY SEARCH, TA/NEWS/INFO, DISPLAY
- 8 SLEEP button (14)
- 9 DIMMER button (14)
- 10 BASS BOOST button (22)
- 11 SMART S (surround), SETUP button (15)
- 12 EFFECT button (33)
- 13 TEST button (31 – 33)
- 14 Adjusting buttons for speaker and subwoofer output levels  
(21, 31, 32, 34)  
SUBWFR (subwoofer) +/-, CENTER +/-, SURR L (left surround) +/-, SURR R (right surround) +/-
- 15 TV/VIDEO button (35, 37)
- 16 MUTING button (13)
- 17 VOLUME +/- buttons (12)
- 18 Mode selector  
DVD, AUDIO/TV/VCR/STB
- 19 • Numeric buttons for adjusting tone (21)  
BASS Ⓡ/Ⓢ, TREBLE Ⓡ/Ⓢ  
• Numeric buttons for selecting preset channels (24)
- 20 ANALOG/DIGITAL INPUT button (11, 12)
- 21 TONE button (21)
- 22 A (audio).POSITION button (22)
- 23 DECODE button (12)
- 24 SURROUND button (30, 32)

\* The term "VR (Video Recorder)" in this manual is used to refer to both video cassette recorders (VCR) and video disc recorders (VDR). "VDR" is JVC's product name for DVD recorders.

## NOTES

- You cannot use this remote control to operate the VDR. To operate the VDR, use the remote control supplied with your VDR.
- Buttons shown in half tone color are used for operating a JVC DVD player. If these buttons do not function normally, use a remote control supplied with your DVD player. See the instruction supplied with the DVD player for details.

To open the cover of the remote control, push here then slide downward.

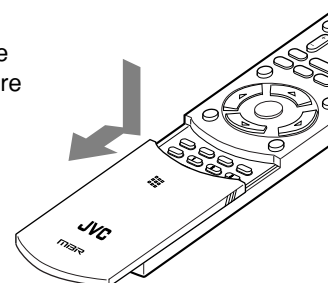

## Parts identification

See pages in parentheses for details.

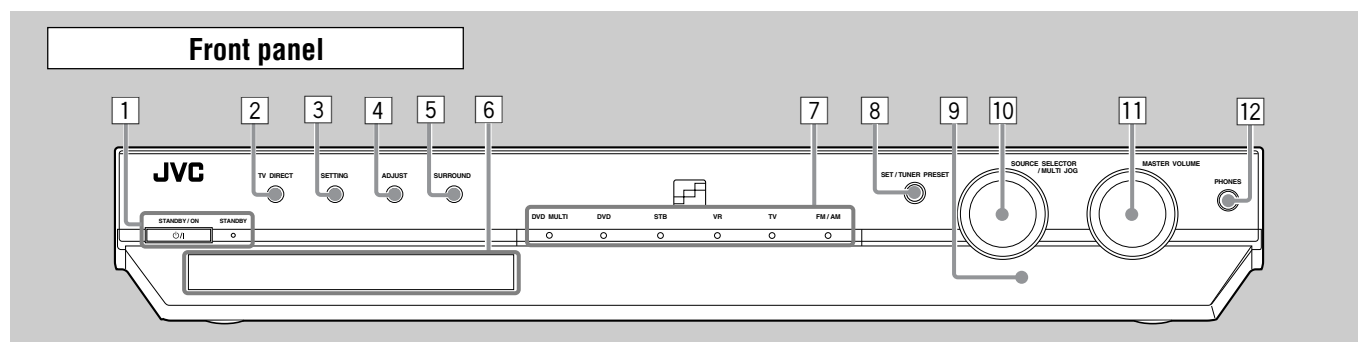

- |   |   |
|---|---|
| <ul style="list-style-type: none"> <li>1 STANDBY/ON button and STANDBY lamp (11)</li> <li>2 TV DIRECT button (13)</li> <li>3 SETTING button (16, 17, 19)</li> <li>4 ADJUST button (21, 31, 33, 34)</li> <li>5 SURROUND button (31, 33)</li> <li>6 Display window (see below)</li> <li>7 Source indicators<br/>DVD MULTI, DVD, STB, VR, TV, FM/AM</li> </ul> | <ul style="list-style-type: none"> <li>8 • SET button (16, 17, 19, 21, 31 – 34)<br/>• TUNER PRESET button (24)</li> <li>9 Remote sensor (4)</li> <li>10 SOURCE SELECTOR (11)<br/>MULTI JOG (16, 17, 19, 21, 31 – 34)</li> <li>11 MASTER VOLUME control (12)</li> <li>12 PHONES jack (12)</li> </ul> |
|---|---|

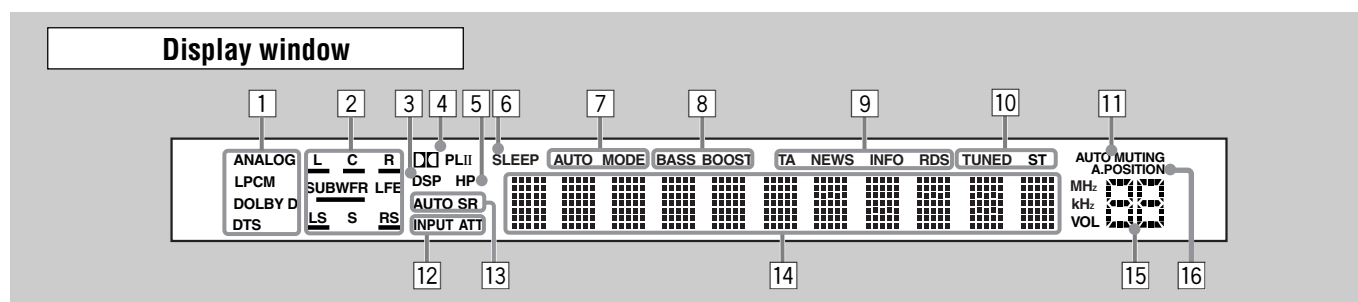

- |   |   |
|---|---|
| <ul style="list-style-type: none"> <li>1 Signal format indicators (11, 13)<br/>ANALOG, LPCM (Linear PCM), DOLBY D (Dolby Digital), DTS</li> <li>2 Signal and speaker indicators (14)</li> <li>3 DSP indicator (29, 32, 33)</li> <li>4 PLII indicator (28)</li> <li>5 HP (headphone) indicator (12)</li> <li>6 SLEEP indicator (14)</li> <li>7 AUTO MODE indicator (20)</li> <li>8 BASS BOOST indicator (22)</li> <li>9 RDS operation indicators (25, 27)<br/>TA, NEWS, INFO, RDS</li> </ul> | <ul style="list-style-type: none"> <li>10 Tuner operation indicators (23)<br/>TUNED, ST (stereo)</li> <li>11 AUTO MUTING indicator (24)</li> <li>12 INPUT ATT (attenuator) indicator (22)</li> <li>13 AUTO SR (surround) indicator (20)</li> <li>14 Main display</li> <li>15 Volume level indicator (11)</li> <li>16 A (audio).POSITION indicator (22)</li> </ul> |
|---|---|

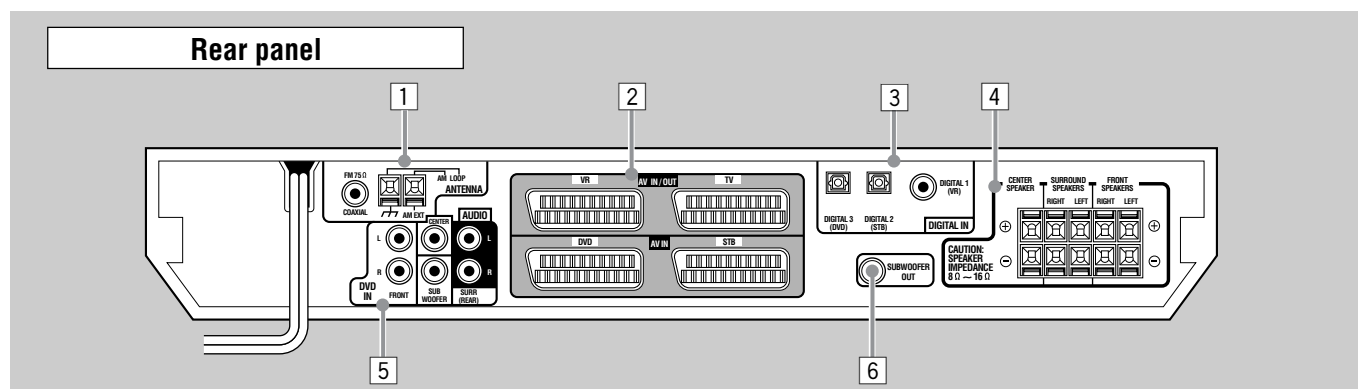

- |  |  |
|--|--|
| <ul style="list-style-type: none"> <li>1 ANTENNA terminals (5)</li> <li>2 SCART terminals (8)<br/>AV IN/OUT (VR, TV), AV IN (DVD, STB)</li> <li>3 DIGITAL IN terminals (7)<br/>DIGITAL 1 (VR), DIGITAL 2 (STB), DIGITAL 3 (DVD)</li> </ul> | <ul style="list-style-type: none"> <li>4 Speaker terminals (6)<br/>FRONT SPEAKERS, SURROUND SPEAKERS, CENTER SPEAKER</li> <li>5 DVD IN jacks (10)<br/>FRONT, CENTER, SURR (REAR), SUBWOOFER</li> <li>6 SUBWOOFER OUT jack (6)</li> </ul> |
|--|--|

# Getting started

## Before installation

### General Precautions

- DO NOT insert any metal object into the unit.
- DO NOT disassemble the unit or remove screws, covers, or cabinet.
- DO NOT expose the unit to rain or moisture.

### Locations

- Install the unit in a location that is level and protected from moisture.
- The temperature around the unit must be between  $-5^{\circ}\text{C}$  and  $35^{\circ}\text{C}$ .
- Make sure there is good ventilation around the unit. Poor ventilation could cause overheating and damage the unit.

### Handling the unit

- DO NOT touch the power cord with wet hands.
- DO NOT pull on the power cord to unplug the cord. When unplugging the cord, always grasp the plug so as not to damage the cord.
- Keep the power cord away from the connecting cords and the antenna. The power cord may cause noise or screen interference. It is recommended to use a coaxial cable for antenna connection, since it is well-shielded against interference.
- When a power failure occurs, or when you unplug the power cord, the preset settings such as preset FM or AM (MW) channels and sound adjustments may be erased in a few days.

## Checking the supplied accessories

Check to be sure you have all of the following supplied accessories. The number in parentheses indicates the quantity of each piece supplied.

- Remote control (1)
- Batteries (2)
- AM (MW) loop antenna (1)
- FM antenna (1)
- SCART cable (1)
- Digital coaxial cord (1)

If anything is missing, contact your dealer immediately.

## Putting batteries in the remote control

Before using the remote control, put two supplied batteries first.

### 1 Press and slide the battery cover on the back of the remote control.

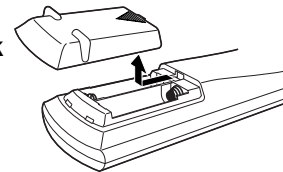

### 2 Insert batteries.

Make sure to match the polarity: (+) to (+) and (-) to (-).

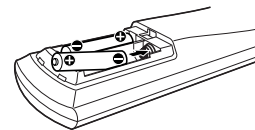

### 3 Replace the cover.

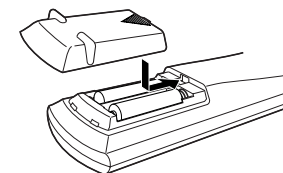

If the range or effectiveness of the remote control decreases, replace the batteries. Use two R6P(SUM-3)/AA(15F) type dry-cell batteries.

- Supplied batteries are for initial setup. Replace for continued use.

### CAUTION:

Follow these precautions to avoid leaking or cracking cells:

- Place batteries in the remote control so they match the polarity: (+) to (+) and (-) to (-).
- Use the correct type of batteries. Batteries that look similar may differ in voltage.
- Always replace both batteries at the same time.
- Do not expose batteries to heat or flame.

When using the remote control, aim the remote control directly at the remote sensor on the front panel.

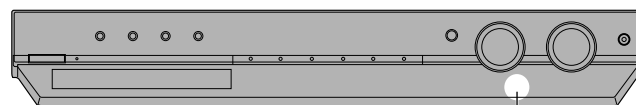

Remote sensor



## Connecting the FM and AM (MW) antennas

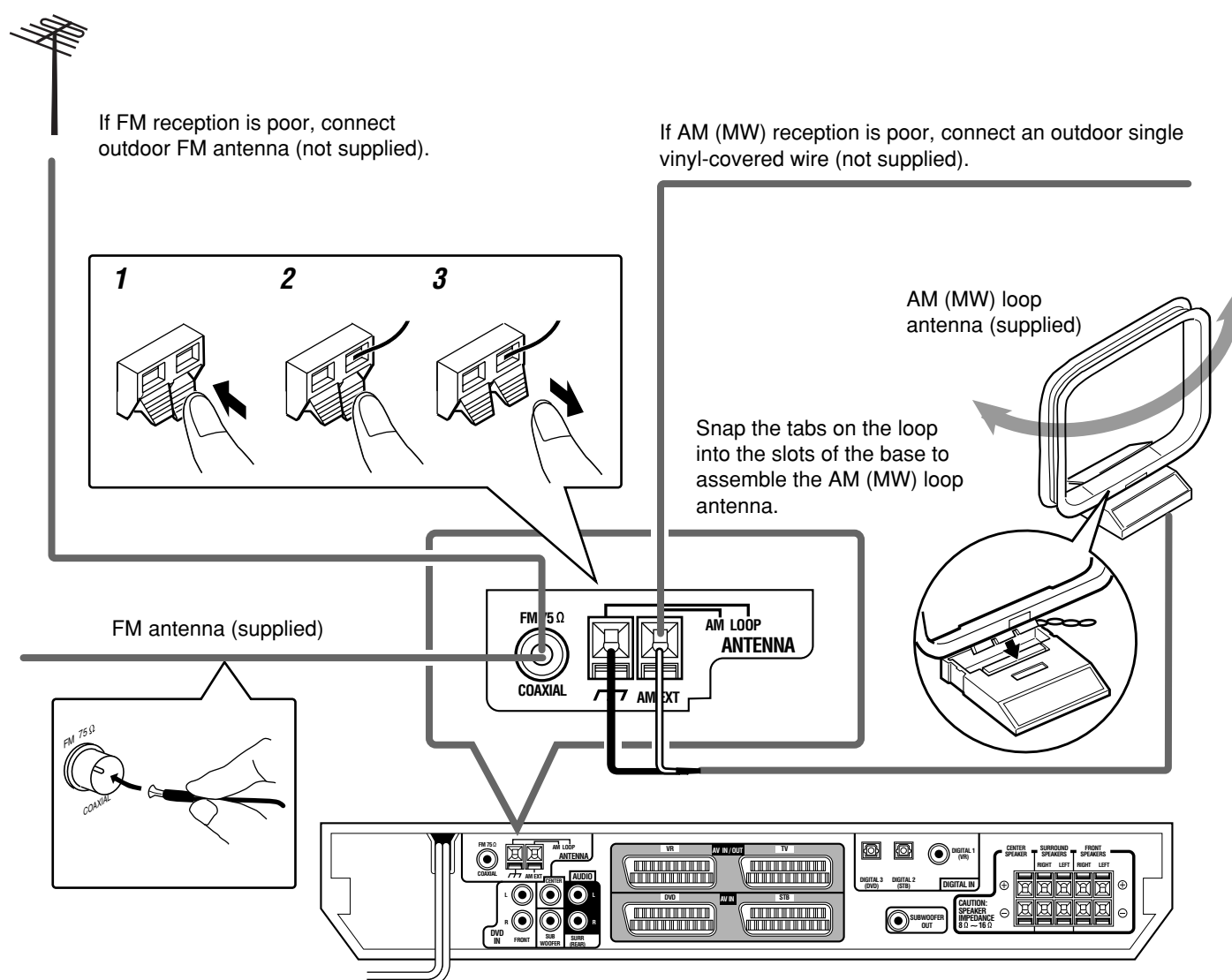

### AM (MW) antenna connection

Connect the AM (MW) loop antenna supplied to the AM LOOP terminals.

Connect the white cord to the AM EXT terminal, and the black cord to the terminal.

Turn the loop until you have the best reception.

- If the reception is poor, connect an outdoor single vinyl-covered wire (not supplied) to the AM EXT terminal. Keep the AM (MW) loop antenna connected.

### FM antenna connection

Connect the FM antenna supplied to the FM 75 Ω COAXIAL terminal as temporary measure.

Extend the supplied FM antenna horizontally.

- If the reception is poor, connect an outdoor FM antenna (not supplied). Before attaching a 75 Ω coaxial cable with a connector (IEC or DIN 45325), disconnect the supplied FM antenna.

### NOTES

- If the AM (MW) loop antenna wire is covered with vinyl, remove the vinyl while twisting it as shown on the right.
- Make sure the antenna conductors do not touch any other terminals, connecting cords and power cord. This could cause poor reception.

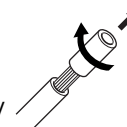

## Getting Started

### Connecting the speakers

Turn off all components before connections.

#### Speaker Layout Diagram

After connecting the front, center and surround speakers, and/or a subwoofer, set the speaker setting information properly to obtain the best possible surround effect. For details, see pages 15 to 18.

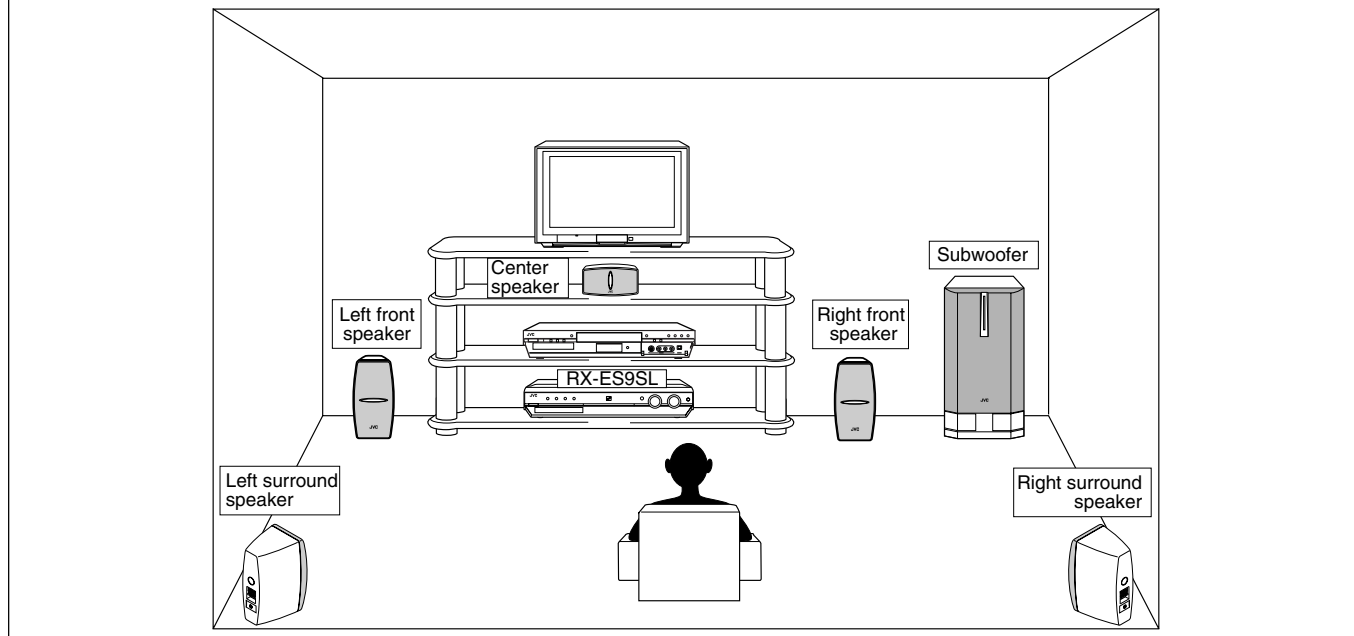

#### Connecting the front, center, and surround speakers

For each speaker, connect the (+) and (-) terminals on the rear panel to the (+) and (-) terminals marked on the speakers respectively.

- 1 Twist and remove the insulation at the end of each speaker cord (not supplied).
- 2 Press and hold the clamp of the speaker terminal (1), then insert the speaker cord (2).
- 3 Release the finger from the clamp.

#### CAUTION:

Use speakers with the SPEAKER IMPEDANCE indicated by the speaker terminals.

#### Connecting the subwoofer

By connecting a subwoofer, you can enhance the bass or reproduce the original LFE signals recorded in the digital software.

Connect the input jack of a powered subwoofer to the SUBWOOFER OUT jack on the rear panel, using a cord with RCA pin plugs (not supplied).

- Refer also to the manual supplied with your subwoofer.

#### NOTE

You can place a subwoofer wherever you like since bass sound is non-directional. Normally place it in front of you.

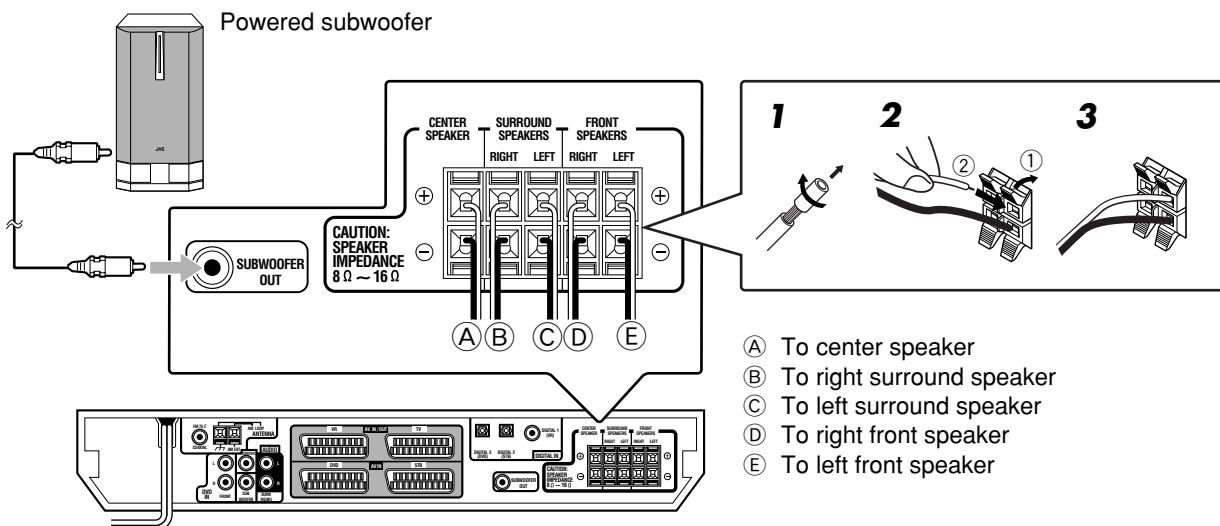



## Getting started

### Connecting video components

Turn off all components before making connections.

- Illustrations of the input/output terminals are typical examples. When you connect other components, refer also to their manuals since the terminal names actually printed on the rear vary among different components.

#### CAUTION:

If you connect a sound-enhancing device such as a graphic equalizer between the source components and this receiver, the sound output through this receiver may be distorted.

#### Digital connection

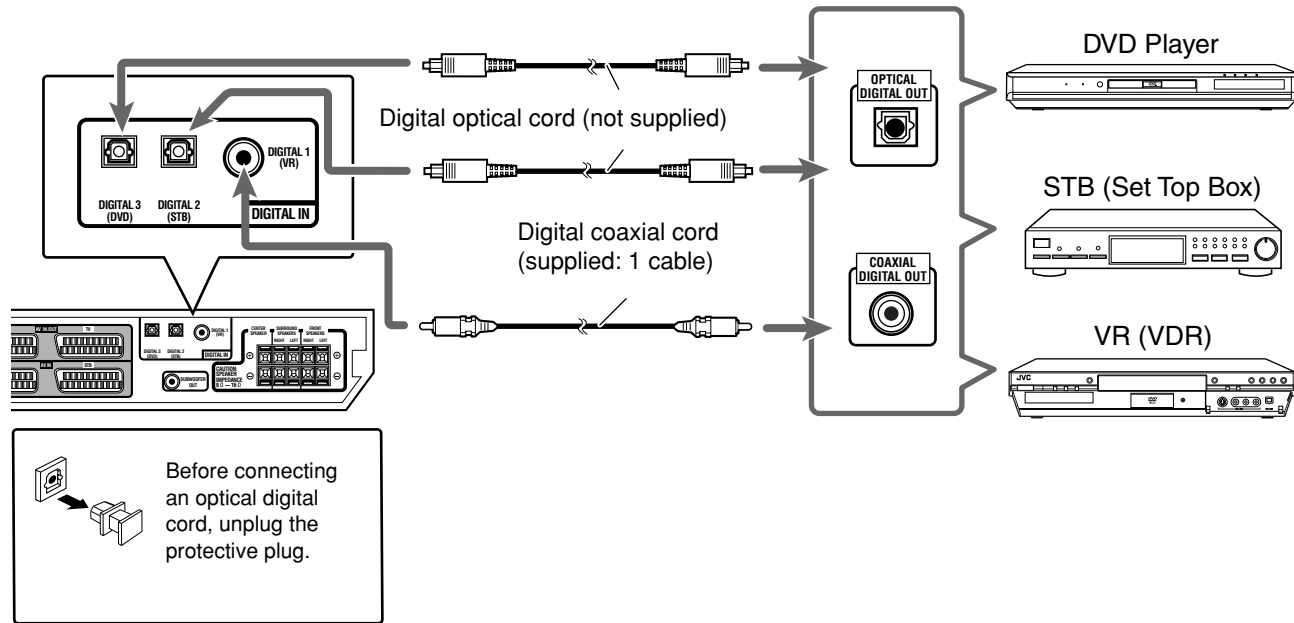

#### NOTES

- When shipped from the factory, the DIGITAL IN terminals have been set for use with the following components:
  - DIGITAL 1 (VR) (coaxial): For VR (VDR)
  - DIGITAL 2 (STB) (optical): For STB (Set Top Box)
  - DIGITAL 3 (DVD) (optical): For DVD player
 If you connect other components, change the digital input (DIGITAL IN) terminal setting correctly. See "Setting the digital input (DIGITAL IN) terminals—DIGITAL IN" on page 19.
- Select the correct digital input mode. See "Selecting the analogue or digital input mode" on page 11.

## Getting started

### SCART connection

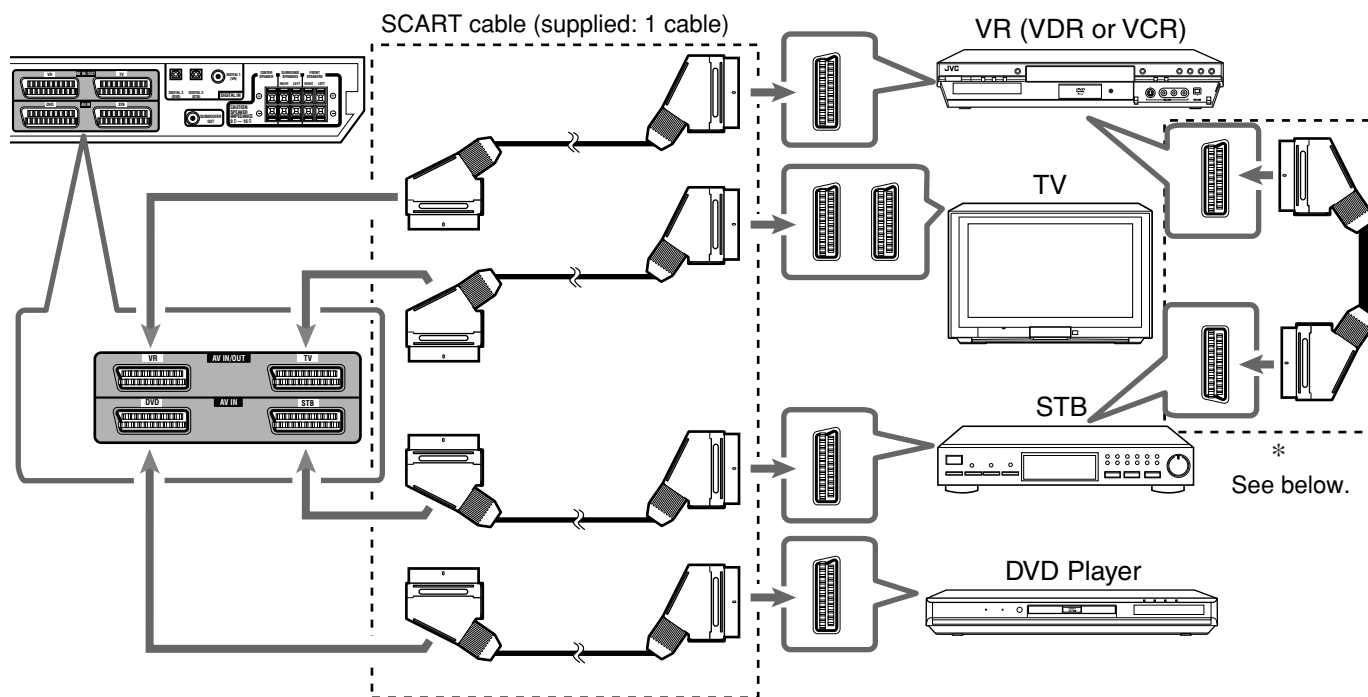

#### NOTE

You can connect either a VDR or a VCR to the VR terminal.

#### \* For an analogue decoder

To watch or record a scrambled program on your VR, connect the analogue decoder to your VR and select the scrambled channel on your VR.  
If there is not an appropriate terminal for the decoder connection on your VR, connect the decoder to your TV.  
Refer also to the manuals supplied with these components.

#### \* For recording pictures from STB

When you connect a STB and a VR directly with a SCART cable, you can record the pictures from the STB onto VR without using the STB menu screens. For details, refer also to the manuals supplied with the STB.

#### For digital sounds

To reproduce the digital sound, use both the digital connection (see page 7) and the SCART cable connection.



## Getting started

### For TV and video format

- When the TV is equipped with the multiple SCART terminals, refer to the TV manual to check the available video signals for each terminal, then connect SCART cable correctly.
- This receiver cannot convert the video signals (S-video or Composite). When the video signal of one video component is different from that of the other (for example, one is S-video, the other is Composite), you may not see the pictures appropriately. In this case, unify the video signals of all the video components into S-video or Composite, or you need to switch the video signal of TV each time you change the source.

### For T-V LINK

- You can use the T-V LINK function if you connect a T-V LINK compatible TV and VR to this receiver with a fully wired SCART cables. For details on T-V LINK, refer also to the manuals supplied with the TV and the VR.
- Connect a SCART cable to EXT-2 terminal on your JVC's T-V LINK compatible TV for the T-V LINK function.
- Some TV, VR, STB and DVD players support the data communication like T-V LINK. For complete details, refer also to the manuals supplied with these components.

SCART Terminal Specifications

			TV	VR	STB	DVD
IN	AUDIO	L/R	○	○	○	○
	VIDEO	Composite	○	○	○	○
		S-video	—	○	○	○
		RGB	—	○	○	○
OUT	AUDIO	L/R	○* <sub>1</sub>	○* <sub>1</sub>	/	
	VIDEO	Composite	○* <sub>1</sub> * <sub>2</sub>	○* <sub>1</sub> * <sub>2</sub>		
		S-video	○* <sub>2</sub>	—		
		RGB	○* <sub>2</sub>	—		
T-V LINK			○* <sub>3</sub>	○* <sub>3</sub>	○* <sub>3</sub>	○* <sub>3</sub>

\*1 The signals input from a SCART terminal cannot be output through the same SCART terminal.

\*2 The video format of the output video signals are consistent with that of the input video signals. For example, if S-video signals are input to this receiver, no signals other than S-video signals can be output from this receiver.  
Refer to the manuals supplied with the video components to check the setting of the input/output video signals.

\*3 The signals for the T-V LINK function are always going through the receiver.



## Getting started

### Analogue connection for DVD MULTI playback (see page 34)

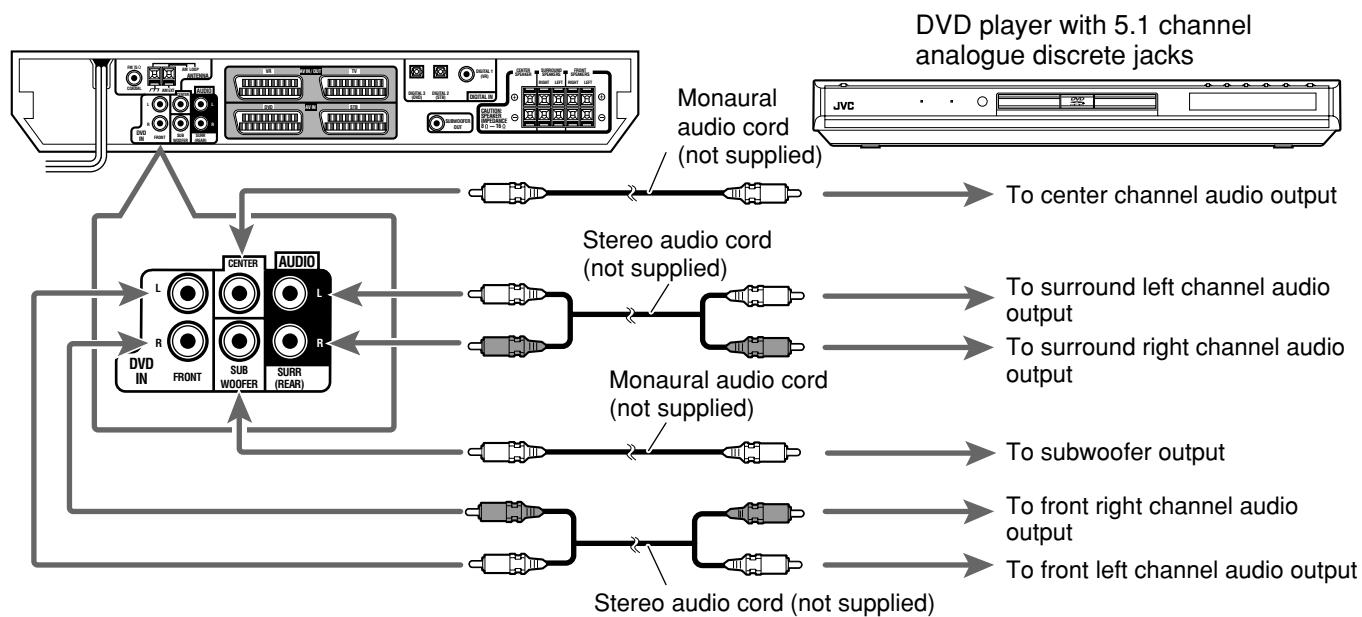

#### NOTE

When using the DVD MULTI playback, use the same DVD player connected to this receiver by a SCART cable. If you connect a different DVD player, the mixed sound from front left and right channels are reproduced.

## Connecting the power cord

Before plugging the power cord into an AC outlet, make sure that all connections have been made.

### Plug the power cord into an AC outlet.

Keep the power cord away from the connecting cables and the antenna. The power cord may cause noise or screen interference. We recommend that you use a coaxial cable to connect the antenna, since it is well-shielded against interference.

#### NOTE

The preset settings such as preset channels and sound adjustment may be erased in a few days in the following cases:

- When you unplug the power cord.
- When a power failure occurs.

#### CAUTIONS:

- Do not touch the power cord with wet hands.
- Do not alter, twist or pull the power cord when disconnecting it, or put anything heavy on it, which may cause fire, electric shock, or other accidents.

# Basic operations

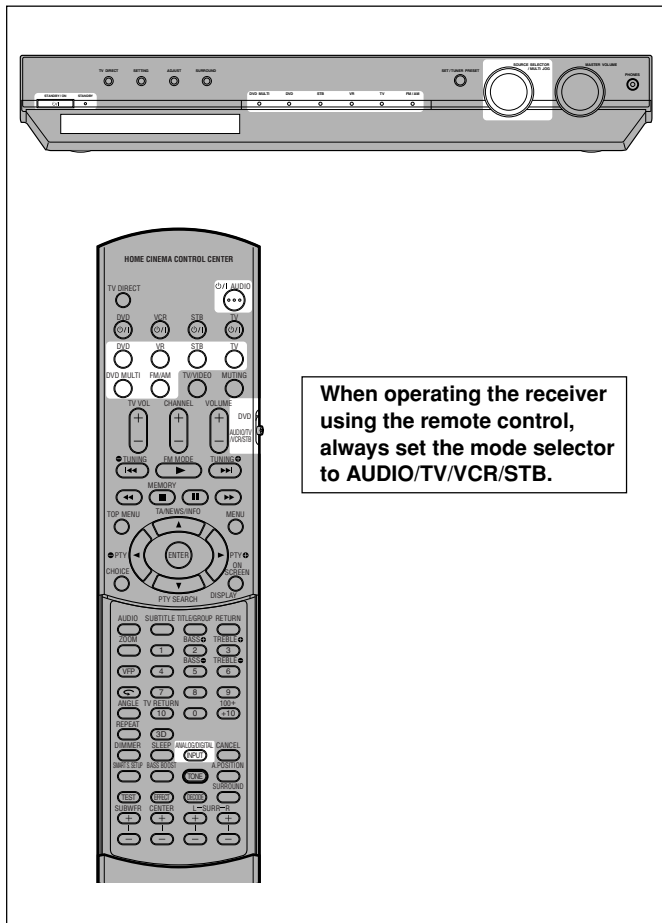

## 2 Select the source to play

### On the front panel:

Turn **SOURCE SELECTOR** until the source name you want appears on the display.

The source indicator corresponding to the selected source lights in red.

- As you turn SOURCE SELECTOR, the source changes as follows:

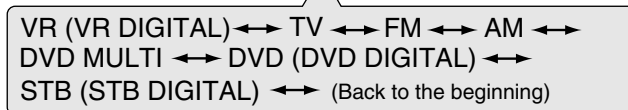
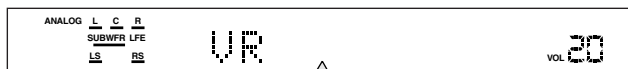

### From the remote control:

Press one of the source selecting buttons.

- Each time you press FM/AM, FM and AM (MW) changes alternately.

**DVD MULTI:** Select the DVD player using the analogue discrete output mode (5.1 channel reproduction). To enjoy the DVD MULTI playback, see page 34.

**DVD (DIGITAL)\*:** Select the DVD player.

**STB (DIGITAL)\*:** Select the STB.

**VR (DIGITAL)\*:** Select the VR.

**TV:** Select the TV tuner.

**FM:** Select an FM broadcast.

**AM:** Select an AM (MW) broadcast.

### NOTE

After pressing VR on the remote control, you can operate the VCR by using the remote control but not the VDR. See page 35 and 37 for details.

### \* Selecting the analogue or digital input mode

When you have connected the VR, STB, or DVD player using both the analogue connection and the digital connection methods (see pages 7 to 9), you need to select the correct input mode.

- You can select the digital input only for sources which you have selected digital input terminals for. (See "Setting the digital input (DIGITAL IN) terminals—DIGITAL IN" on page 19.)

### From the remote control ONLY:

Press **ANALOG/DIGITAL INPUT** to select the analogue or digital input mode.

- Each time you press the button, the input mode alternates between the analogue input ("ANALOGUE") and the digital input ("DGTL AUTO").

**DGTL AUTO:** Select for the digital input mode. The receiver automatically detects the incoming signal format, then the digital signal format indicator (DOLBY D, DTS or LPCM) for the detected signals lights up.

**ANALOGUE\*:** Select for the analogue input mode.

\* Initial setting

### NOTE

You cannot select the digital input mode when selecting "DVD MULTI" as the playing source.

## 1 Turn on the power

Press **STANDBY/ON** (or **AUDIO** on the remote control).

The STANDBY lamp goes off. The current source indicator lights in red. The name of the current source (or station frequency) appears on the display.

Current volume level is shown here.

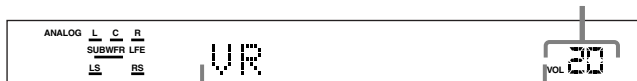

Current source name appears.

### To turn off the power (into standby)

Press **STANDBY/ON** again (or **AUDIO** on the remote control). The STANDBY lamp lights up.

### NOTE

A small amount of power is consumed in standby mode. To turn the power off completely, unplug the AC power cord.

## Basic operations

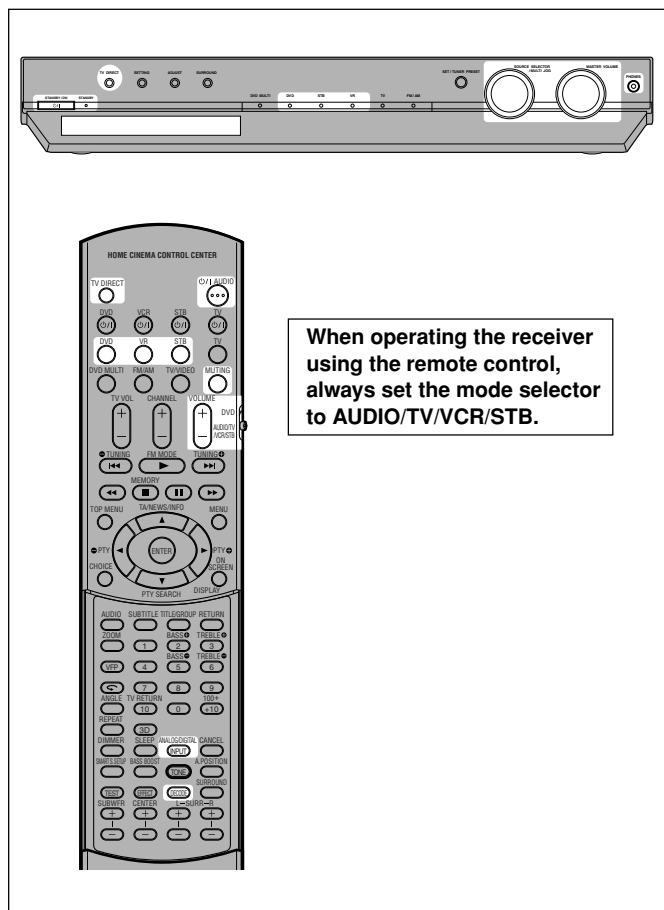

When operating the receiver using the remote control, always set the mode selector to AUDIO/TV/VCR/STB.

### HEADPHONE mode

When using the headphones, the following signal is output regardless of your speaker setting:

- For 2 channel sources, the front left and right channel signal is output directly from the left and right headphones.
  - For multi-channel sources, the front left and right, center and surround channel signal is down-mixed and then output from the headphones without missing bass element.
- You can enjoy multi-channel sound source using the headphones.

### CAUTION:

Be sure to turn down the volume:

- Before connecting or putting on headphones, as high volume can damage both the headphones and your hearing.
- Before removing headphones, as high volume may output from the speakers.

## Selecting the digital decode mode

If the following symptoms occur while playing Dolby Digital or DTS Digital Surround software with "DGTL AUTO" selected (see page 11), follow the procedure below:

- Sound does not come out at the beginning of playback.
- Noise comes out while searching for or skipping chapters or tracks.

### From the remote control ONLY:

- 1 Press **ANALOG/DIGITAL INPUT** to select "DGTL AUTO."
- 2 Press **DECODE** to select "DGTL D.D." or "DGTL DTS."

- Each time you press the button, the digital input mode changes as follows:

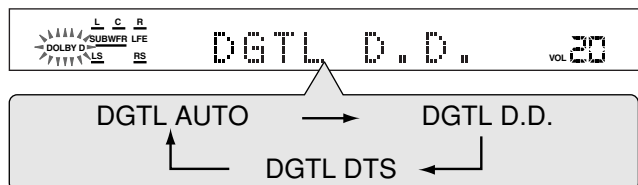

- To play back software encoded with Dolby Digital, select "DGTL D.D."
- To play back software encoded with DTS Digital Surround, select "DGTL DTS."

### NOTE

When you turn off the power or select another source, "DGTL DTS" or "DGTL D.D." is canceled and the digital input mode is automatically reset to "DGTL AUTO."

## 3 Adjust the volume

To increase the volume, turn **MASTER VOLUME** control clockwise (or press **VOLUME +** on the remote control).

To decrease the volume, turn **MASTER VOLUME** control counterclockwise (or press **VOLUME -** on the remote control).

### CAUTION:

Always set the volume to the minimum before starting any sources. If the volume is set at its high level, the sudden blast of sound energy can permanently damage your hearing and/or ruin your speakers.

### NOTE

The volume level can be adjusted within the range of "0" (minimum) to "50" (maximum).

## Listening with headphones

Connect a pair of headphones to the PHONES jack on the front panel. This cancels the Surround mode currently selected, deactivates speakers, and activates the HEADPHONE mode. The HP (headphone) indicator lights up on the display.

- Disconnecting a pair of headphone from the PHONES jack cancels the HEADPHONE mode and activates the speakers.





## Basic operations

The following are the analogue/digital signal format indicators on the display to indicate what type of signal comes into the receiver.

- ANALOG:** Lights when analogue input is selected.
- LPCM:** Lights when Linear PCM signal comes in.
- DOLBY D:**
- Lights when Dolby Digital signal comes in.
  - Flashes when "DGTL D.D." is selected for software not encoded with Dolby Digital.
- DTS:**
- Lights when DTS signal comes in.
  - Flashes when "DGTL DTS" is selected for software not encoded with DTS.

### NOTE

When "DGTL AUTO" cannot recognize the incoming signal, no digital signal format indicator lights up on the display.

**To cancel TV Direct and turn off the receiver,** press STANDBY/ON  on the front panel.

The receiver is turned off and the STANDBY lamp lights up.

**To cancel TV Direct and turn on the receiver,** press TV DIRECT on the front panel or  AUDIO on the remote control.

The receiver is turned on and the source indicator currently selected lights in red.

### NOTES

- When TV Direct is activated, you cannot enjoy any of the sound effects this receiver produces, and cannot use the speakers connected to this receiver.
- You can use the T-V LINK function between the TV and VR while TV Direct is activated. (For T-V LINK functions, refer to the manuals supplied with the TV and the VR.)
- TV Direct cannot be used for the DVD MULTI playback mode (see page 34).

## Activating TV Direct

TV Direct enables you to use this receiver as an AV selector while the receiver is not turned on.

When TV Direct is activated, the pictures and sounds go from the video components such as DVD player to the TV through this receiver. Thus, you can use the video components and the TV as if they were connected directly.

- This function takes effect for the following sources—DVD (except DVD MULTI), STB, and VR when they are connected using the SCART cables.

To activate (or deactivate) TV Direct, follow the procedure below:

### 1 Press TV DIRECT.

All the indications disappear, then the source indicator currently selected lights in green.

### 2 Turn on the video component and TV.

### 3 Select the target video component.

#### On the front panel:

Turn **SOURCE SELECTOR** until one of the source indicator—DVD, VR, or STB—lights in green.

#### From the remote control:

Press one of the source selecting buttons—DVD, VR, or STB.

The source indicator corresponding to the selected source lights in green.

## Turning off the sounds temporarily—Muting

### From the remote control ONLY:

Press **MUTING** to turn off the sound through all connected speakers.

"MUTING" appears on the display and the volume turns off (the volume level indicator goes off).



**To restore the sound,** press MUTING again.

- Pressing VOLUME +/- (or turning MASTER VOLUME control on the front panel) also restores the sound.

## Basic operations

### Turning off the power with the Sleep Timer

You can fall asleep while listening to music—Sleep Timer.

#### From the remote control ONLY:

#### Press SLEEP repeatedly.

The SLEEP indicator lights up on the display, and the shut-off time changes in 10 minutes intervals.

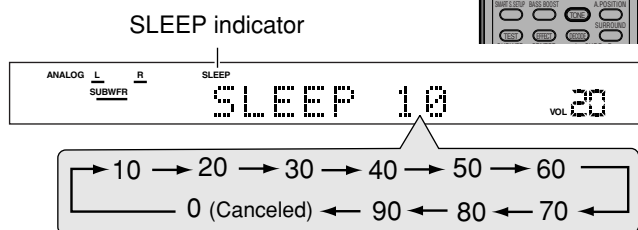

#### When the shut-off time comes:

The receiver turns off automatically.

#### To check or change the remaining time until the shut-off time:

Press SLEEP once.

The remaining time (in minutes) until the shut-off time appears.

- To change the shut-off time, press SLEEP repeatedly.

#### To cancel the Sleep Timer:

Press SLEEP repeatedly until "SLEEP 0" appears on the display. (The SLEEP indicator goes off.)

- Turning off the power also cancels the Sleep Timer.

### Changing the display brightness

You can dim the display.

#### From the remote control ONLY:

#### Press DIMMER repeatedly.

- Each time you press the button, the indication changes as follows:

- |             |  |
|-------------|--|
| DIMMER 1:   | <ul style="list-style-type: none"> <li>Dims the display slightly.</li> <li>Dims the blue indication lighting source lamps.</li> </ul>                              |
| DIMMER 2:   | <ul style="list-style-type: none"> <li>Dims the display more than DIMMER 1.</li> <li>Dims the blue indication lighting source lamps (same as DIMMER 1).</li> </ul> |
| DIMMER 3:   | Turns off the display and the blue indication lighting source lamps.   |
| DIMMER OFF: | Cancels the dim (normal display).  |

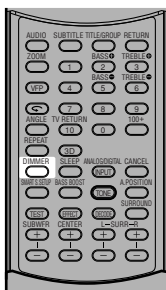

#### NOTES

- When setting speakers and basic items or adjusting sound, select "DIMMER OFF" to confirm the setting you make on the display.
- When selecting DVD or DVD MULTI as a source using the remote control, DIMMER will only function if you are using a JVC DVD player. To dim the display and indication on the receiver, select a source except DVD or DVD MULTI on the remote control, and then press DIMMER.

### Basic adjustment of auto memory

This receiver memorizes sound settings for each source:

- when you turn off the power,
- when you change the source, and
- when you change the analogue/digital input mode (see page 11).

When you change the source, the memorized settings for the newly selected source are automatically recalled.

The following can be stored for each source:

- Analogue/digital input mode (see page 11)
- Tone adjustment (see page 21)
- Subwoofer output level (see page 21)
- Subwoofer audio position (see page 22)
- Balance (see page 22)
- Bass boost (see page 22)
- Input attenuator mode (see page 22)
- Surround/DSP mode selection (see pages 28 – 33)

#### NOTE

If the source is FM or AM (MW), you can assign a different setting for each band.

### Signal and speaker indicators on the display

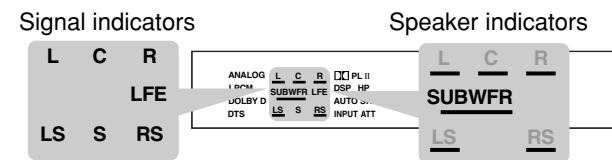

#### The following signal indicators light up —:

- L:
  - When digital input is selected: Lights up when the left channel signal comes in.
  - When analogue input is selected: Always lights up.
- R:
  - When digital input is selected: Lights up when the right channel signal comes in.
  - When analogue input is selected: Always lights up.
- C: Lights up when the center channel signal comes in.
- LS: Lights up when the left surround channel signal comes in.
- RS: Lights up when the right surround channel signal comes in.
- S: Lights up when the monaural surround channel signal comes in.
- LFE: Lights up when the LFE channel signal comes in.

#### The speaker indicators light up as follows:

- The subwoofer indicator (SUBWFR) lights up when "SUBWFR" is set to "USE" for Quick Setup (see page 16) or to "YES" for Manual Setup (see page 17).
- The other speaker indicators light up only when the corresponding speaker is set to "SML" or "LRG," and also when required for the current playback.

# Speaker settings

To obtain the best possible surround effect from Surround/DSP modes (see pages 28 to 33), you need to set up the speaker and subwoofer information after all the connections are completed. You can set the speaker information using one of the following three methods.

**Smart Surround Setup:** Set the speakers information automatically by one simple action—clapping hands. The delay time and output level for the center and surround speakers are set automatically.

**Quick Setup:** Set the speakers and subwoofer information quickly by entering the use of the subwoofer, the number of the speakers, and your room size.

**Manual Setup:** Set the speakers and subwoofer information manually.

- Before starting the speaker setting, connect and position the speakers and subwoofer (see page 6) and turn on the receiver.

## Setting the speakers information automatically—Smart Surround Setup

The distance from your listening point to the speakers is one of the important element to obtain the best possible sound effect for the Surround/DSP modes.

You need to set the delay time of the center and surround speakers relative to the front speakers so that sounds through all the speakers can reach you at the same time (see also page 18).

By using Smart Surround Setup, the speaker delay time and output level are automatically calculated by one simple action—clapping hands.

- To use Smart Surround Setup effectively, connect both the center and surround speakers.
- You can also set the crossover frequency, the low frequency effect attenuator and the dynamic range compression manually (see page 18).
- When you change your speakers, do the following steps again.

**To set the speaker information effectively using Smart Surround Setup,** unplug the power cords of all the components connected to this receiver such as a TV, DVD player, STB, VR (VDR or VCR), and subwoofer which may cause noise.

### From the remote control ONLY:

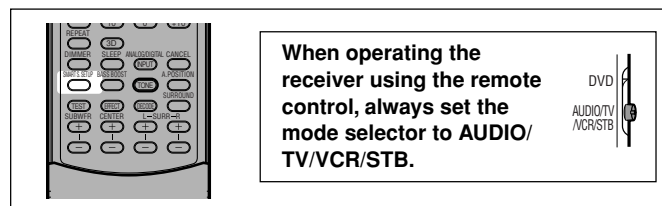

### Before you start, remember...

There is a time limit in doing the following steps. If the setting is canceled before you finish, start from step 2 again.

## 1 Take your position where you listen to the sound.

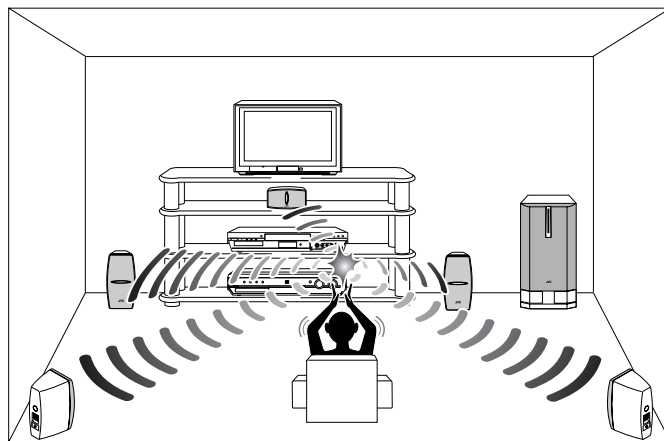

## 2 Press and hold SMART S. SETUP.

“SETTING UP” flashes on the display.



## 3 Confirm “SETTING UP” stops flashing and clap your hands over your head once while “SETTING UP” appears on the display.

The receiver starts detecting the level of the sound coming through all speakers (except the subwoofer). After detecting the sound, one of the following indications appears on the display.

**SUCCESSFUL:** Sound of your clapping is successfully detected. The receiver sets the delay time and the output level of the center and surround speakers automatically.

**SILENT:** The receiver cannot detect sound from some speakers.

**SILENT-ALL:** The receiver cannot detect any sound from all speakers.

**FAILED:** The receiver cannot detect both right and left channels for the front and/or surround speakers correctly.

- When the receiver cannot detect the sound correctly (“SILENT,” “SILENT-ALL” or “FAILED” appears on the display), “SETTING UP” appears on the display again then repeat step 3.
- The speaker delay time and output levels are set automatically when:
  - the receiver detects the sound as “SILENT” twice in succession.
  - the receiver detects the sound as “SILENT” at the third time after detecting “SILENT”, “SILENT-ALL” and/or “FAILED” twice.
- When the receiver detects the sound as “SILENT-ALL” or “FAILED” three times, “MANUAL” appears on the display. Set the speaker and subwoofer information using Quick Setup (see page 16) or Manual Setup (see page 17), and the speakers’ output levels for the center and surround speakers (see pages 31 to 33).

**To cancel Smart Surround Setup,** press SMART S. SETUP while “SETTING UP” flashes on the display.

- Any other operations cannot be done after “SETTING UP” stops flashing. Complete the Smart Surround Setup.

### NOTES

- You need to set the subwoofer information and output level manually (see pages 17 and 21).
- When you use Smart Surround Setup, the speaker delay time and output levels you have set before will be ineffective.
- Set the speakers information using Quick Setup (see page 16) or Manual Setup (see page 17), and the speakers’ output levels for the center and surround speakers (see pages 31 to 33) when:
  - you like to change the speaker setting made by Smart Surround Setup
  - Smart Surround Setup is not done correctly due to some factors such as the environment, speaker types and clapping strength.
- Smart Surround Setup will not be done correctly if your body or other object blocks the sound.
- Do not clap your hands hard because it may hurt your hands.

## Speaker settings

### Setting the speakers and subwoofer information quickly—Quick Setup

Entering the use of the subwoofer, the number of the speakers, and your room size, the center and surround speakers' delay time is automatically calculated.

- When you change your speakers, register the information about the speakers again.
- You can also set the crossover frequency, the low frequency effect attenuator and the dynamic range compression manually (see page 18).

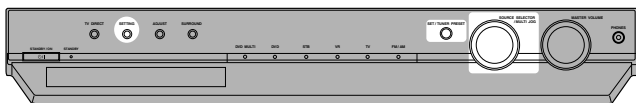

#### On the front panel ONLY:

##### Before you start, remember...

There is a time limit in doing the following steps. If the setting is canceled before you finish, start from step 1 again.

#### 1 Press SETTING.

MULTI JOG now works for the setting operation.

#### 2 Turn MULTI JOG until "QUICK SETUP" appears on the display.

- As you turn MULTI JOG, the indication changes as follows:

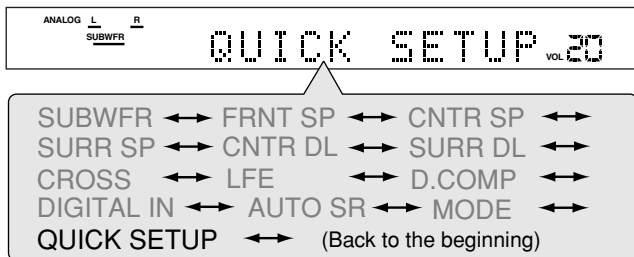

#### 3 Press SET.

"ENTER THE NUMBER OF SPEAKERS" scrolls on the display.

- Once you have selected "QUICK SETUP," previously adjusted speaker setting is cleared.

#### 4 Turn MULTI JOG to select the number of the speakers you have connected.

- As you turn MULTI JOG, the indication changes as follows:

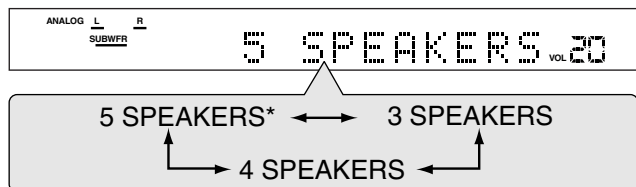

- 5 SPEAKERS\*:** Select when the front, center and surround speakers are connected.
- 4 SPEAKERS:** Select when the front and surround speakers are connected.
- 3 SPEAKERS:** Select when the front and center speakers are connected.

\* Initial setting

Each speaker size is registered appropriately according to the number of the connected speakers. For details, see the list "Speaker size according to the number of speakers" on the right.

#### 5 Press SET.

"ENTER USE OF SUBWOOFER" scrolls on the display.

#### 6 Turn MULTI JOG to select whether or not you have connected a subwoofer.

- As you turn MULTI JOG, the indication changes as follows:



\* Initial setting

#### 7 Press SET.

"ENTER ROOM SIZE" scrolls on the display.

#### 8 Turn MULTI JOG to select the room size.

- As you turn MULTI JOG, the indication changes as follows:

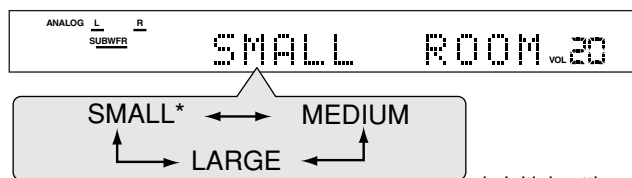

\* Initial setting

The center and surround speakers' delay time is registered appropriately according to the room size. For details, see the list "Speaker delay time according to room size" below.

#### 9 Press SET to finish the setting.

"SETUP END" appears for a while, then the indication of the previously selected source appears on the display.

#### NOTES

- The setting you have made is not registered until "SETUP END" appears on the display.
- Performing any operation other than volume and dimmer adjustment cancels Quick Setup process.
- When you want to change the speaker and subwoofer information after Quick Setup, use Manual Setup (see page 17).

#### Speaker size according to the number of speakers

Number of speakers	Subwoofer	Front	Center	Surround
3	NO	LRG (large)	SML (small)	NO
3	USE (YES)	SML (small)	SML (small)	NO
4	NO	LRG (large)	NO	SML (small)
4	USE (YES)	SML (small)	NO	SML (small)
5	NO	LRG (large)	SML (small)	SML (small)
5	USE (YES)	SML (small)	SML (small)	SML (small)

#### Speaker delay time according to room size

##### When selecting "SMALL ROOM,"

- Center speaker delay time is set to 1 msec.
- Surround speakers delay time is set to 3 msec.

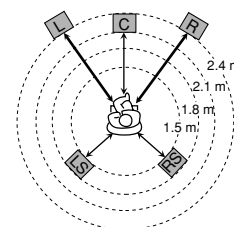



## Speaker settings

### When selecting "MEDIUM ROOM,"

- Center speaker delay time is set to 1 msec.
- Surround speakers delay time is set to 2 msec.

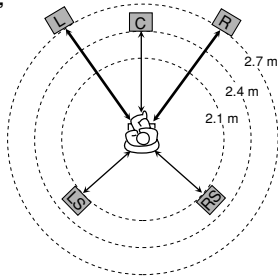

### When selecting "LARGE ROOM,"

- Center speaker delay time is set to 0 msec.
- Surround speakers delay time is set to 0 msec.

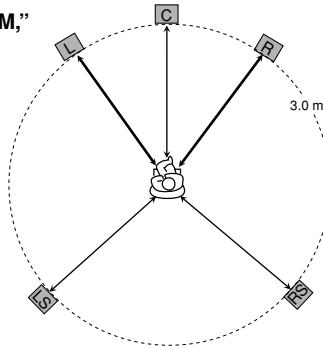

## Setting the speakers and subwoofer information manually—Manual Setup

You can set the following speakers and subwoofer information manually as you prefer. When you change your speakers, register the information again.

- Subwoofer information—SUBWFR
- Speaker size—FRNT SP, CNTR SP, SURR SP
- Speaker delay time—CNTR DL, SURR DL
- Crossover frequency—CROSS
- Low frequency effect attenuator—LFE
- Dynamic range compression—D.COMP

### Operating procedure

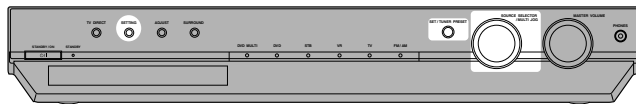

#### On the front panel ONLY:

##### Before you start, remember...

There is a time limit in doing the following steps. If the setting is canceled before you finish, start from step 1 again.

#### 1 Press SETTING.

MULTI JOG now works for the setting operation.

#### 2 Turn MULTI JOG until the setting item you want to set appears on the display, then press SET.

- As you turn MULTI JOG, the indication changes as follows:



#### 3 Turn MULTI JOG to select the appropriate setting for the item selected in step 2, then press SET.

Your setting is stored.



Ex.: When selecting "NO" for "SUBWFR."

#### 4 If you would like to set other items, repeat steps 2 and 3.

### Setting the subwoofer information

#### —SUBWFR (subwoofer)

Register whether you have connected a subwoofer or not.

**YES\*:** Select when you have connected a subwoofer. The subwoofer speaker indicator (**SUBWFR**) lights up on the display (see page 14). You can adjust the subwoofer output level (see page 21).

**NO:** Select when you have not connected or have disconnected a subwoofer.

\* Initial setting

### Setting the speakers size

#### —FRNT SP (front speakers), CNTR SP (center speaker), SURR SP (surround speakers)

Register the sizes of all the connected speakers.

**LRG (large):** Select when the cone speaker size is larger than 12 cm.

**SML (small)\*:** Select when the cone speaker size is smaller than 12 cm.

**NO:** Select when you have not connected a speaker. (Not selectable for the front speakers.)

\* Initial setting

#### NOTES

- If you have selected "SML (small)" for the front speaker size, you cannot select "LRG (large)" for the center and surround speaker sizes.
- If you have selected "NO" for the subwoofer setting (see above and page 16), you can only select "LRG (large)" for the front speaker size.

CONTINUED ON THE NEXT PAGE

17

## Speaker settings

### Setting the speaker delay time

#### — CNTR DL (center speaker delay), SURR DL (surround speakers delay)

You can set the speaker delay time easily by using Smart Surround Setup (see page 15) or Quick Setup (see page 16).

The distance from your listening point to the speakers is one of the important elements to obtain the best possible surround sound for the Surround modes.

You need to set the delay time of the center and surround speakers relative to the front speakers so that sounds through all the speakers can reach you at the same time.

- 1 msec increase (or decrease) in delay time corresponds to 30 cm increase (or decrease) in distance.

**CNTR DL\*:** Set the delay time for the center speaker within a range of 0 msec to 5 msec (in 1 msec intervals).

**SURR DL\*:** Set the delay time for the surround speakers within a range of 0 msec to 15 msec (in 1 msec intervals).

\* "0ms" is the initial setting.

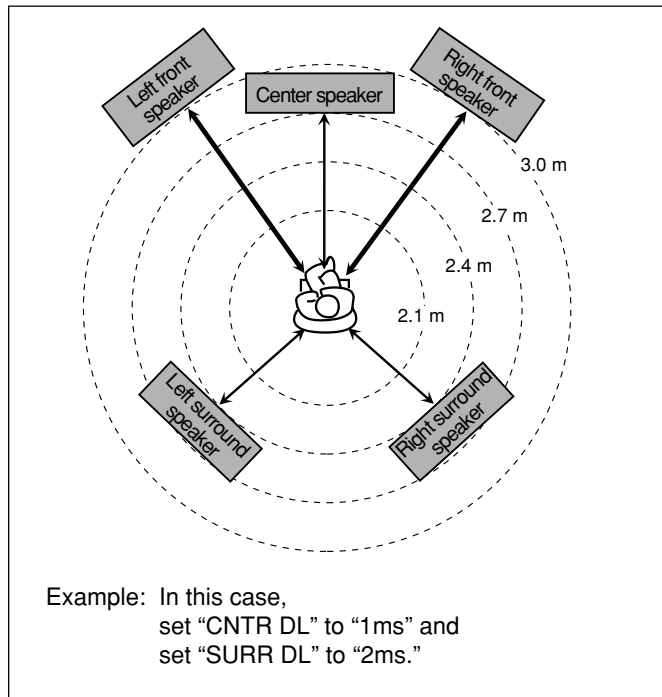

#### NOTE

If you have selected "NO" for the center and surround speakers setting (see page 17), you cannot set the speaker delay time for the center and surround speakers.

### Setting the crossover frequency—CROSS

Small speakers cannot reproduce the bass sounds efficiently. If you use a small speaker in any position, this receiver automatically reallocates the bass sound elements assigned to the small speaker to the large speakers.

To use this function properly, set this crossover frequency level according to the size of the small speaker connected.

- If you have selected "LRG (large)" for all speakers (see page 17), this function will not take effect.

**80HZ:** Select when the cone speaker unit built in the speaker is about 12 cm.

**100HZ:** Select when the cone speaker unit built in the speaker is about 10 cm.

**120HZ:** Select when the cone speaker unit built in the speaker is about 8 cm.

**150HZ\*:** Select when the cone speaker unit built in the speaker is about 6 cm.

**200HZ:** Select when the cone speaker unit built in the speaker is less than 5 cm.

\* Initial setting

#### NOTE

Crossover frequency is not valid for the HEADPHONE mode.

### Setting the low frequency effect attenuator—LFE

If the bass sound is distorted while playing back software encoded with **Dolby Digital** or **DTS**, set the LFE level to eliminate distortion.

- This function takes effect only when the LFE signals come in.

**0dB\*:** Normally select this.

**-10dB:** Select when the bass sound is distorted.

\* Initial setting

### Setting the dynamic range compression—D.COMP

You can compress the dynamic range (difference between maximum sound and minimum sound) of the reproduced sound. This is useful when listening to surround sound at night.

- This function takes effect only when playing back a source encoded with **Dolby Digital**.

**OFF:** Select when you want to enjoy surround with its full dynamic range. (No effect applied.)

**MID\*:** Select when you want to reduce the dynamic range a little.

**MAX:** Select when you want to apply the compression effect fully. (Useful at night.)

\* Initial setting

# Basic settings

## Operating procedure

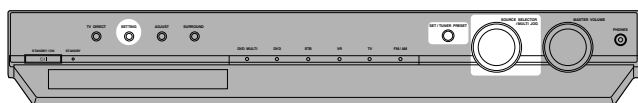

### On the front panel ONLY:

#### Before you start, remember...

There is a time limit in doing the following steps. If the setting is canceled before you finish, start from step **1** again.

#### 1 Press SETTING.

MULTI JOG now works for the setting operation.

#### 2 Turn MULTI JOG until the setting item you want to set appears on the display, then press SET.

- As you turn MULTI JOG, the indication changes as follows:

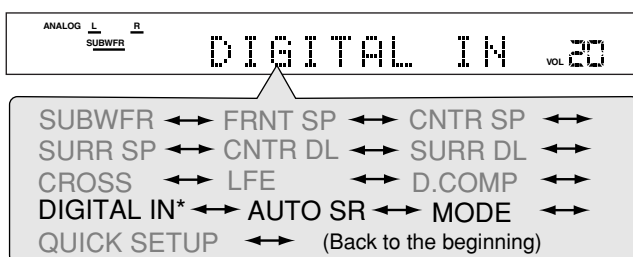

\* Setting item you can select appears on the display after "DIGITAL IN" appears for a few seconds.

#### 3 Turn MULTI JOG to select the appropriate setting for the item selected in step 2, then press SET.

Your setting is stored.



Ex.: When selecting "1VR2STB3DVD" for "DIGITAL IN."

## Setting the digital input (DIGITAL IN) terminals—DIGITAL IN

When you use the digital input terminals, register what components are connected to which terminals—DIGITAL 1/2/3 (see page 7) so that the correct source name will appear when you select the digital source.

**1VR2STB3DVD\***: Select when connecting the following components;

- DIGITAL 1: VR (VDR)
- DIGITAL 2: STB
- DIGITAL 3: DVD player

**1VR2DVD3STB**: Select when connecting the following components;

- DIGITAL 1: VR (VDR)
- DIGITAL 2: DVD player
- DIGITAL 3: STB

**1STB2VR3DVD**: Select when connecting the following components;

- DIGITAL 1: STB
- DIGITAL 2: VR (VDR)
- DIGITAL 3: DVD player

**1STB2DVD3VR**: Select when connecting the following components;

- DIGITAL 1: STB
- DIGITAL 2: DVD player
- DIGITAL 3: VR (VDR)

**1DVD2VR3STB**: Select when connecting the following components;

- DIGITAL 1: DVD player
- DIGITAL 2: VR (VDR)
- DIGITAL 3: STB

**1DVD2STB3VR**: Select when connecting the following components;

- DIGITAL 1: DVD player
- DIGITAL 2: STB
- DIGITAL 3: VR (VDR)

\* Initial setting



## Basic settings

### Setting Auto Surround—AUTO SR

You can enjoy Surround mode simply by selecting the source (with digital input selected for that source).  
Select "ON" when activating Auto Surround.

- ON:**
- If multi-channel signal comes in, an appropriate Surround mode will be turned on.
  - If Dolby Digital 2 channel or DTS 2 channel signal including surround signal comes in, "PLII MOVIE" will be selected.
  - If Dolby Digital 2 channel or DTS 2 channel signal not including surround signal comes in, "STEREO" will be selected.
  - If Linear PCM signal comes in, nothing will change.
- The AUTO SR indicator lights up on the display.

**OFF\*:** Select this to deactivate Auto Surround.

\* Initial setting

#### NOTES

- This function does not take effect in the following cases:
  - While playing an analogue source, and
  - While selecting "DGTL D.D." or "DGTL DTS" as the fixed digital input mode (see page 12).
- If Surround mode is automatically activated by Auto Surround, any other Surround mode in use will be canceled temporarily. When the multi-channel digital signal stops coming in, "PLII MOVIE" activates.
- If you press SURROUND with Auto Surround activated, Auto Surround will be canceled temporarily for the currently selected source.  
Auto Surround setting will be restored in the following cases:
  - When you turn the receiver off and on,
  - When you change the source,
  - When you change the analogue/digital input, and
  - When you reset "AUTO SR" to "ON" again.

### Setting the Auto Function mode—MODE

The video components can be operated through this receiver by activating Auto Function mode.

- This function takes effect for the following sources—DVD (except DVD MULTI), STB, and VR, when they are connected using SCART cables.

**AUTO1:** When a video component is turned on while the receiver is on, the receiver selects the video component as the source automatically.  
The AUTO MODE indicator lights up on the display.

**AUTO2:** **When a video component is turned on while the receiver is on or TV Direct activates,** the receiver selects the video component as the source automatically.  
**When a video component is turned on while the receiver is off, TV Direct activates** and the receiver selects the video component as the source automatically.  
**When a video component currently selected as the source is turned off while the receiver is on or TV Direct activates,** the receiver changes the source to the previously selected one.  
**When all video components are turned off while the receiver is on or TV Direct activates,** the receiver is turned off automatically.  
The AUTO MODE indicator lights up on the display.

**MANUAL\*:** Select the source manually.

\* Initial setting

#### NOTE

When selecting VR as the source, "AUTO1" or "AUTO2" may not work if you only turn on the VR. If this happens, you may need to start playback to activate Auto Function mode.



# Sound adjustments

When operating the receiver using the remote control, always set the mode selector to **AUDIO/TV/VCR/STB**.



## Operating procedure

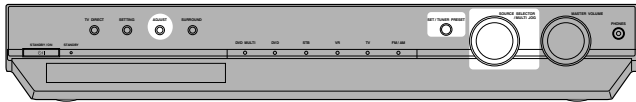

### On the front panel:

#### Before you start, remember...

There is a time limit in doing the following steps. If the setting is canceled before you finish, start from step **1** again.

#### 1 Press ADJUST.

MULTI JOG now works for the sound adjustment.

#### 2 Turn MULTI JOG until the setting item you want to set appears on the display, then press SET.

- As you turn MULTI JOG, the indication changes as follows:

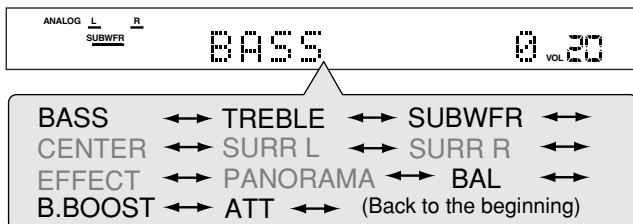

#### 3 Turn MULTI JOG to adjust the item selected in step 2, then press SET.

Your setting is stored.



Ex.: When selecting "+10 (dB)" for "BASS".

## Adjusting the tone—BASS, TREBLE

You can adjust the bass and treble sounds to your preference.

- You have to make these adjustments for each source.

**BASS\***: To adjust the bass (from -10 dB to +10 dB).

**TREBLE\***: To adjust the treble (from -10 dB to +10 dB).

\* "0" is the initial setting.

### When using the remote control:

#### 1 Press TONE.

#### 2 Press BASS $\oplus/\ominus$ or TREBLE $\oplus/\ominus$ to adjust the sound level (from -10 dB to +10 dB).

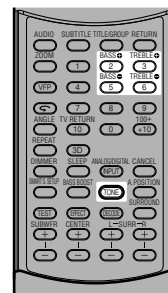

### NOTE

When you use the numeric buttons to operate your target source after tone adjustments, press the corresponding source selecting button first so that the numeric buttons work for your target source.

## Adjusting the subwoofer output level—SUBWFR

You can adjust the subwoofer output level if you have connected a subwoofer and set the subwoofer information correctly—"USE" for the Quick Setup or "YES" for the Manual Setup (see pages 16 and 17).

- You have to make this adjustment for each source.

**SUBWFR\***: To adjust the subwoofer output level (from -10 dB to +10 dB).

\* "0" is the initial setting.

### When using the remote control:

#### Press SUBWFR $\oplus/\ominus$ to adjust the subwoofer output level (from -10 dB to +10 dB).

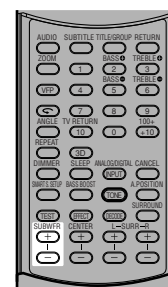

## Sound adjustments

### Setting the subwoofer audio position

When a stereo source is played back, the subwoofer sound is reinforced compared to the sound from a multi-channel source. Once you have set the subwoofer audio position, the subwoofer output level is decreased by the selected value when a stereo source is played back. The A (audio).POSITION indicator lights up when this function is activated.

- You have to make this adjustment for each source.

#### From the remote control ONLY:

Press **A.POSITION** repeatedly to select the subwoofer audio position level from “-2 (dB),” “-4 (dB),” and “-6 (dB).”

The smaller the number becomes, the more the level decreases automatically when listening in stereo.

- If no adjustment is required, select “OFF” (initial setting).



#### NOTES

- The maximum subwoofer output level is -10 dB.  
Ex:  
When setting the subwoofer output level to “-8 (dB)” and the subwoofer audio position to “-4 (dB),” the subwoofer output level when listening in stereo will be -10 dB.
- This function does not take effect when activating a Surround mode.

### Adjusting the front speakers output balance—BAL

If the sounds you hear from the front right and left speakers are unequal, you can adjust the speakers output balance.

- You have to make this adjustment for each source.
- You cannot use the remote control for this setting.

**BAL\*:** To adjust the front speakers balance.  
• “CENTER” to “L-21”: Decrease the left channel output.  
• “CENTER” to “R-21”: Decrease the right channel output.

\* “CENTER” is the initial setting.

### Reinforcing the bass—B.BOOST

You can boost the bass level—Bass Boost.

- You have to make these adjustments for each source.

**ON:** Select to boost the bass level (Bass Boost).  
The BASS BOOST indicator lights up on the display.

**OFF\*:** Select to deactivate Bass Boost.

\* Initial setting

#### NOTE

This function affects the sound coming out only through the front speakers.

#### When using the remote control:

Press **BASS BOOST**.

- Each time you press the button, Bass Boost turns on and off alternately.

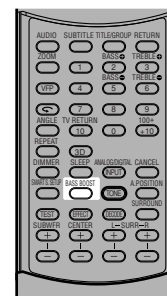

### Attenuating the input signal—ATT

When the input level of **analogue source** is too high, the sound will be distorted. If this happens, you need to attenuate the input signal level to prevent the sound distortion.

- You have to make this adjustment for each analogue source.
- You cannot use the remote control for this setting.

**ON:** Select to attenuate the input signal level.  
The INPUT ATT indicator lights up on the display.

**NORMAL\*:** Select to deactivate attenuation.

\* Initial setting

# Tuner operations

The buttons on the remote control are mainly used for tuner operations. **To use buttons on the remote control, press FM/AM before operation.**

**When operating this receiver using the remote control, always set the mode selector to AUDIO/TV/VCR/STB.**

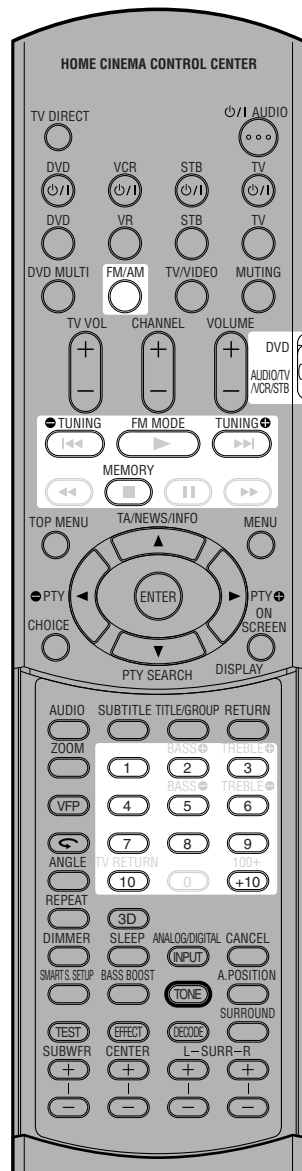

## Tuning in to stations manually

**From the remote control ONLY:**

### 1 Press FM/AM to select the band.

The last received station of the selected band is tuned in.

- Each time you press the button, the band alternates between FM and AM (MW).



You can also select "FM" or "AM" by turning SOURCE SELECTOR on the front panel.

### 2 Press repeatedly or hold TUNING + or TUNING - until you find the frequency you want.

If you select "FM" or "AM" using SOURCE SELECTOR on the front panel, press FM/AM on the remote control before this operation.

- Pressing (or holding) TUNING + increases the frequency.
- Pressing (or holding) TUNING - decreases the frequency.

#### NOTES

- When you hold and release TUNING + or TUNING -, the frequency keeps changing until a station is tuned in.
- When a station of sufficient signal strength is tuned in, the TUNED indicator lights up on the display.
- When an FM stereo program is received, the ST (Stereo) indicator also lights up.

## Using preset tuning

Once a station is assigned to a channel number, the station can be quickly tuned. You can preset up to 30 FM and 15 AM (MW) stations.

### To store the preset stations

**Before you start, remember...**

There is a time limit in doing the following steps. If the setting is canceled before you finish, start from step 2 again.

**From the remote control ONLY:**

### 1 Tune in to the station you want to preset (see "Tuning in to stations manually" above).

- If you want to store the FM reception mode for this station, select the FM reception mode you want. See "Selecting the FM reception mode" on page 24.



### 2 Press MEMORY.

The channel number position starts flashing on the display for about 5 seconds.



CONTINUED ON THE NEXT PAGE

23

## Tuner operations

### 3 Press the numeric buttons (1 – 10, +10) to select a channel number while the channel number position is flashing.

- For channel number 5, press 5.
- For channel number 15, press +10, then 5.
- For channel number 30, press +10, +10, then 10.



### 4 Press MEMORY again while the selected channel number is flashing on the display.

- The station is assigned to the selected channel number.
- The selected channel number stops flashing.



### 5 Press repeatedly or hold TUNING + or TUNING - to select another frequency you want to store.

### 6 Repeat steps 1 to 5 until you store all the stations you want.

#### To erase a stored preset station

Storing a new station on a used channel number erases the previously stored one.

#### To tune in a preset station

##### From the remote control:

#### 1 Press FM/AM to select the band.

The last received station of the selected band is tuned in and the numeric buttons now work for tuner operations.

- Each time you press the button, the band alternates between FM and AM (MW).



#### 2 Press the numeric buttons (1 – 10, +10) to select a channel number.

If you select "FM" or "AM" using SOURCE SELECTOR on the front panel, press FM/AM on the remote control before this operation.

- For channel number 5, press 5.
- For channel number 15, press +10, then 5.
- For channel number 30, press +10, +10, then 10.



#### On the front panel:

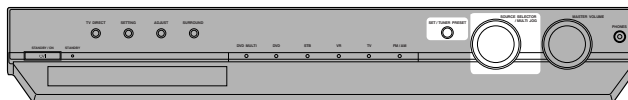

#### Before you start, remember...

There is a time limit in doing the following steps. If the setting is canceled before you finish, start from step 2 again.

#### 1 Turn SOURCE SELECTOR to select "FM" or "AM."

The last received station of the selected band is tuned in.

#### 2 Press TUNER PRESET.

"P" appears on the display and MULTI JOG now works for selecting preset channels.

#### 3 Turn MULTI JOG to select a preset channel number during "P" appears on the display.

- Turning MULTI JOG clockwise increases the preset channel numbers.
- Turning MULTI JOG counterclockwise decreases the preset channel numbers.



## Selecting the FM reception mode

When an FM stereo broadcast is hard to receive or noisy, you can change the FM reception mode while receiving an FM broadcast.

- You can store the FM reception mode for each preset station (see page 23).

#### From the remote control ONLY:

#### While listening to an FM station, press FM MODE.

If you select "FM" using SOURCE SELECTOR on the front panel, press FM/AM on the remote control before this operation.

- Each time you press the button, the FM reception mode alternates between "AUTO MUTING" and "MONO."

#### AUTO MUTING\*:

Normally select this.

When a program is broadcast in stereo, you will hear stereo sound; when in monaural, you will hear monaural sound. This mode is also useful to suppress static noise between stations. The AUTO MUTING indicator lights up on the display.

#### MONO:

Select this to improve the reception (but stereo effect will be lost).

In this mode, you will hear noise while tuning in to the stations. The AUTO MUTING indicator goes off from the display. (The ST indicator also goes off.)

\* Initial setting



## Tuner operations

Only the buttons on the remote control are used for RDS operations.

**When operating this receiver using the remote control, always set the mode selector to AUDIO/TV/VCR/STB.**

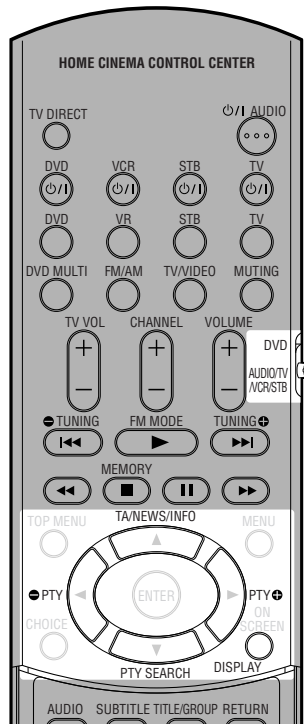

With the receiver, you can receive the following types of RDS signals:

<b>PS (Program Service):</b>	Shows commonly known station names.
<b>PTY (Program Type):</b>	Shows types of broadcast programs.
<b>RT (Radio Text):</b>	Shows text messages the station sends.
<b>Enhanced Other Networks:</b>	See page 27.

### NOTES

- RDS is not available for AM (MW) broadcasts.
- RDS may not operate correctly if the station tuned is not transmitting RDS signal properly or if the signal strength is weak.

### What information can RDS signals provide?

You can see the RDS signals the station sends on the display.

#### Press DISPLAY while listening to an FM station.

- Each time you press the button, the display changes to show you the following information:



#### PS (Program Service):

While searching, "PS" appears and then the station names will be displayed. "NO PS" appears if no signal is sent.

#### PTY (Program Type):

While searching, "PTY" appears and then the type of the broadcast program will be displayed. "NO PTY" appears if no signal is sent.

#### RT (Radio Text):

While searching, "RT" appears and then text messages the station sends will be displayed. "NO RT" appears if no signal is sent.

#### Frequency:

Station frequency (non-RDS service).

## Using the RDS (Radio Data System) to receive FM stations

RDS allows FM stations to send an additional signal along with their regular program signals. For example, the stations send their station names, as well as information about what type of program they broadcast, such as sports or music, etc.

When tuned to an FM station which provides the RDS service, the RDS indicator lights up on the display.



#### About characters shown on the display

When the display shows PS, PTY, or RT signals, the following characters are used:

- The display cannot show accented letters, "A" for instance, may stand for accented "A's" like "À, Ä, Ã, Á, Â, Æ, å, ä, ã, á, à, and â."

### NOTE

If searching finishes at once, "PS," "PTY," and "RT" will not appear on the display.

## Tuner operations

### Searching for a program by PTY codes

One of the advantages of the RDS service is that you can locate a particular kind of program from the preset channels (see pages 23 and 24) by specifying the PTY codes.

#### To search for a program using the PTY codes

**Before you start, remember...**

- The PTY Search is only applicable to preset stations.
- To stop searching any time during the process, press PTY SEARCH while searching.
- There is a time limit in doing the following steps. If the setting is canceled before you finish, start from step 1 again.

#### 1 Press PTY SEARCH while listening to an FM station.

“PTY SELECT” flashes on the display.

#### 2 Press PTY $\oplus$ or PTY $\ominus$ until the PTY code you want appears on the display while “PTY SELECT” is flashing.

- For details, see “Description of the PTY codes.”

#### 3 Press PTY SEARCH again, while the PTY code selected in the previous step is still on the display.

While searching, “SEARCH” and the selected PTY code alternate on the display.

The receiver searches 30 preset FM stations, stops when it finds the one you have selected, and tunes in that station.

#### To continue searching after the first stop

Press PTY SEARCH again while the indications on the display are flashing.

- If no program is found, “NOT FOUND” appears on the display.

### Description of the PTY codes:

<b>News:</b>	News.
<b>Affairs:</b>	Topical program expanding or enlarging upon the news—debate or analysis.
<b>Info:</b>	Programs the purpose of which is to impart advice in the widest sense.
<b>Sport:</b>	Programs concerned with any aspect of sports.
<b>Educate:</b>	Educational programs.
<b>Drama:</b>	All radio plays and serials.
<b>Culture:</b>	Programs concerning any aspect of national or regional culture, including language, theater, etc.
<b>Science:</b>	Programs about natural sciences and technology.
<b>Varied:</b>	Used for mainly speech-based programs such as quizzes, panel games and personality interviews.
<b>Pop M:</b>	Commercial music of current popular appeal.
<b>Rock M:</b>	Rock music.
<b>Easy M:</b>	Current contemporary music considered to be “easy-listening.”
<b>Light M:</b>	Instrumental music, and vocal or choral works.
<b>Classics:</b>	Performances of major orchestral works, symphonies, chamber music, etc.
<b>Other M:</b>	Music not fitting into any of the other categories.
<b>Weather:</b>	Weather reports and forecasts.
<b>Finance:</b>	Stock Market reports, commerce, trading, etc.
<b>Children:</b>	Programs targeted at a young audience.
<b>Social:</b>	Programs about sociology, history, geography, psychology and society.
<b>Religion:</b>	Religious programs.
<b>Phone In:</b>	Involving members of the public expressing their views either by phone or at a public forum.
<b>Travel:</b>	Travel information.
<b>Leisure:</b>	Programs about recreational activities.
<b>Jazz:</b>	Jazz music.
<b>Country:</b>	Songs which originate from, or continue the musical tradition of the American Southern States.
<b>Nation M:</b>	Current popular music of the nation or region in that country's language.
<b>Oldies:</b>	Music from the so-called “golden age” of popular music.
<b>Folk M:</b>	Music which has its roots in the musical culture of a particular nation.
<b>Document:</b>	Programs concerning factual matters, presented in an investigative style.
<b>TEST:</b>	Broadcasts for testing emergency broadcast equipment or unit.
<b>Alarm !:</b>	Emergency announcement.
<b>None:</b>	No program type, unidentified program, or difficult to categorize into particular types.

Classification of the PTY codes for some FM stations may be different from the above list.

### PTY codes





## Switching to broadcast program of your choice temporarily

Another convenient RDS service is called “Enhanced Other Networks.”

This allows the receiver to switch temporarily to a broadcast program of your choice (TA, NEWS, and/or INFO) from a different station except in the following cases:

- When you are listening to non-RDS Networks—all AM (MW) stations, some FM stations and other sources.
- When the receiver is in standby mode or in TV Direct mode.

### Before you start, remember...

The Enhanced Other Networks function is only applicable to preset FM stations.

### Press TA/NEWS/INFO repeatedly until the program type you want appears on the display.

- Each time you press the button, the display changes to show the following:

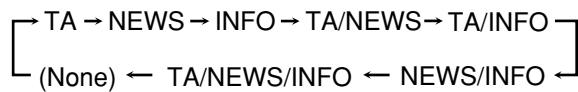

<b>TA:</b>	Traffic Announcement in your area.
<b>NEWS:</b>	News.
<b>INFO:</b>	Program the purpose of which is to impart advice in the widest sense.

### How the Enhanced Other Networks function actually works:

#### If the station currently tuned in starts broadcasting the program type you have selected

The receiver continues to receive the station, but the indicator of the received PTY code starts flashing.



When the program is over, the indicator of the received PTY code stops flashing and remains lit, but the receiver remains in Enhanced Other Networks standby mode.

#### If another FM station in the same Networks starts broadcasting the program type you have selected while you are listening to an FM station

The receiver automatically switches to the station. The indicator of the received PTY code starts flashing.



When the program is over, the receiver goes back to the station previously tuned in, but still remains in Enhanced Other Networks standby mode. The indicator of the received PTY code stops flashing and remains lit.

### To stop listening to the program selected by Enhanced Other Networks

Press TA/NEWS/INFO repeatedly again so that the program type (TA/NEWS/INFO) indicator goes off from the display. The receiver exits from Enhanced Other Networks standby mode and goes back to the previously selected station.

### When an emergency broadcast (Alarm ! signal) is sent from an FM station

The receiver automatically tunes in the station except in the following cases:

- When you are listening to non-RDS Networks—all AM (MW) stations, some FM stations and other sources.
- When the receiver is in standby mode or TV Direct mode.

While receiving an emergency broadcast, “Alarm !” appears on the display.

### The TEST signal is used for equipment test—whether it can receive the Alarm ! signal correctly

The TEST signal makes the receiver work in the same way as the Alarm ! signal does. If the TEST signal is received, the receiver automatically switches to the station broadcasting the TEST signal. While receiving the TEST signal, “TEST” appears on the display.

### NOTES

- Enhanced Other Networks data sent from some stations may not be compatible with this receiver.
- Enhanced Other Networks does not function for some FM stations with RDS service.
- While listening to a program tuned in by the Enhanced Other Networks function, the station does not change even if another network station starts broadcasting a program of the same Enhanced Other Networks data.
- While listening to a program tuned in by the Enhanced Other Networks function, you can only use the TA/NEWS/INFO and DISPLAY.
- The Enhanced Other Networks mode only works when receiving an FM station with the Enhanced Other Networks code.

### CAUTION:

If the stations alternate intermittently between the station tuned by the Enhanced Other Networks function and the currently tuned station, press TA/NEWS/INFO repeatedly to cancel the Enhanced Other Networks function. If you do not press the button, the currently tuned station is received finally, and the indication of the Enhanced Other Networks data type flashing on the display disappears.

# Creating realistic sound fields

## Reproducing theater ambience

In a movie theater, many speakers are located on the walls to reproduce impressive multi-surround sound, reaching you from all directions.

With these many speakers, sound localization and sound movement can be expressed.

Surround/DSP modes built in this receiver can create almost the same surround sound as you can feel in a real movie theater.

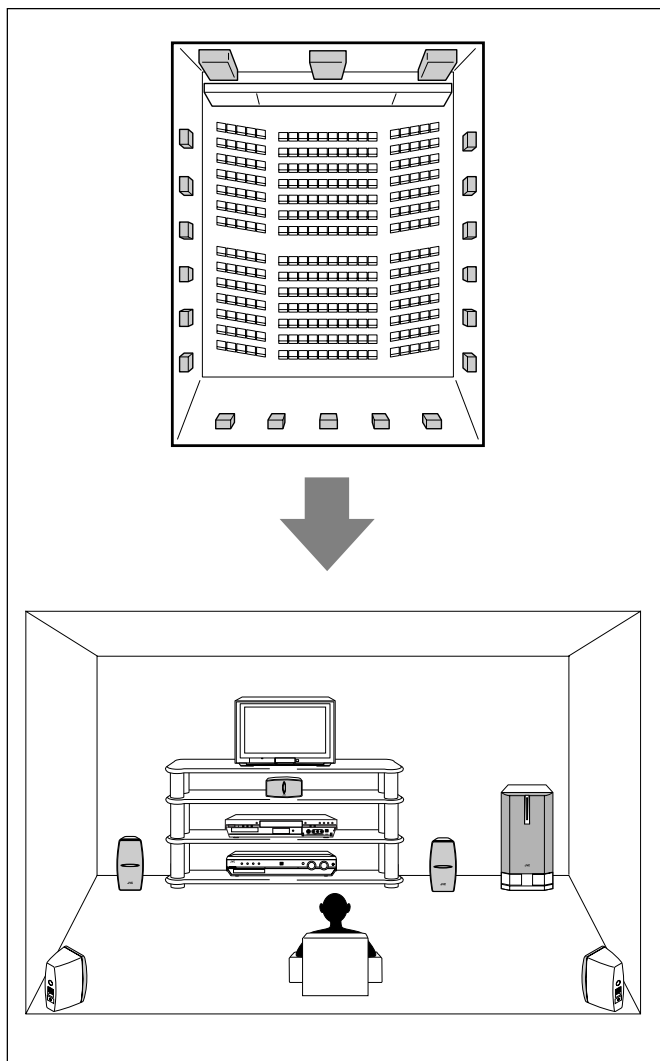

## Introducing the Surround/DSP modes

You can use the following Surround/DSP modes with this receiver.

- Surround modes
  - Dolby Pro Logic II
  - Dolby Digital
  - DTS
- DSP (Digital Signal Processor) modes
  - DAP (Digital Acoustic Processor) modes
  - All Channel Stereo

### ■ Surround modes

#### Dolby Pro Logic II\*

Dolby Pro Logic II has a newly developed multi-channel playback format to decode all 2 channel sources—stereo source and Dolby Surround encoded source—into 5.1 channel.

Matrix-based encoding/decoding method for Dolby Pro Logic II makes no limitation for the cutoff frequency of the surround treble and enables stereo surround sound compared to conventional Dolby Pro Logic.

Dolby Pro Logic II enables you to reproduce spacious sound from original sound without adding any new sounds and tonal colorations. Dolby Pro Logic II has two modes—**Movie mode** and **Music mode**:

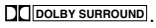
**Pro Logic II Movie**—suitable for reproduction of Dolby Surround encoded sources bearing the mark . You can enjoy a sound field very close to the one created with discrete 5.1 channel sounds.

**Pro Logic II Music**—suitable for reproduction of any 2-channel stereo music sources. You can enjoy wide and deep sound by using this mode. For this mode, Panorama control can be selected, which gives "wraparound" sound effect with side-wall image.

- When Dolby Pro Logic II is activated, the  PLII indicator lights up on the display.

#### Dolby Digital\*

Dolby Digital is a digital signal compression method, developed by Dolby Laboratories, and enables multi-channel encoding and decoding (1 channel up to 5.1 channel).

Dolby Digital 5.1 channel encoding method records and digitally compresses the left front channel, right front channel, center channel, left surround channel, right surround channel, and LFE channel signals (total 6 channels, but the LFE channel is counted as 0.1 channel). Therefore, it is called 5.1 channel).

Dolby Digital enables stereo surround sounds, and sets the cutoff frequency of the surround treble at 20 kHz, compared to 7 kHz for Dolby Pro Logic. As such, the sound movement and "being-there" feeling are enhanced much more than Dolby Pro Logic.

- To enjoy software encoded with Dolby Digital, connect the source component using the digital terminal on the rear of this receiver. (See page 7.)

#### NOTE

Dolby Digital software can be roughly grouped into two categories—multi-channel (up to 5.1 channel) and 2 channel software. To enjoy surround sound while playing Dolby Digital 2 channel software, you can use Dolby Pro Logic II.

\* Manufactured under license from Dolby Laboratories. "Dolby", "Pro Logic", and the double-D symbol are trademarks of Dolby Laboratories.

\*\* "DTS" and "DTS Digital Surround" are registered trademarks of Digital Theater Systems, Inc.



## Creating realistic sound fields

### DTS\*\*

DTS is another digital signal compression method, developed by Digital Theater Systems, Inc., and enables multi-channel encoding and decoding.

DTS Digital Surround is another discrete 5.1 channel digital audio format available on CD, LD, and DVD software.

Compared to Dolby Digital, the DTS Digital Surround format has a lower audio compression rate, which enables it to add breadth and depth to the sounds reproduced. As such, DTS Digital Surround features natural, solid and clear sound.

- To enjoy the software encoded with DTS Digital Surround, connect the source component using the digital terminal on the rear of this receiver. (See page 7.)

### DSP (Digital Signal Processor) modes

#### DAP (Digital Acoustic Processor) modes

DAP modes have been designed to create important acoustic surround elements.

The sound heard in a live club, dance club, hall or pavilion consists of direct sound and indirect sound—early reflections and reflections from behind. Direct sounds reach the listener directly without any reflection. On the other hand, indirect sounds are delayed by the distances of the ceiling and walls (see the diagram below). These indirect sounds are important elements of the acoustic surround effects. The DAP mode can create these important elements, and give you a real “being there” feeling.

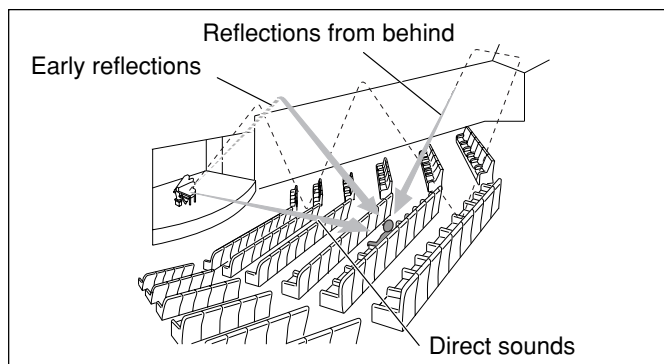

**DAP modes can be used when the front and surround speakers are connected to this receiver (without respect to the center speaker connection: no sound comes out of the center speaker even if it is connected).**

The following DAP modes are provided with this receiver:

<b>LIVE CLUB:</b>	Reproduces the spatial feeling of a live music club with a low ceiling.
<b>DANCE CLUB:</b>	Reproduces the spatial feeling of a rocking dance club.
<b>HALL:</b>	Reproduces the spatial feeling of a hall for classical recitals.
<b>PAVILION:</b>	Reproduces the spatial feeling of an exhibition hall.

These DAP modes can be used to add acoustic surround effects while reproducing 2 channel stereo software, either analogue or Linear PCM digital signal, and can give you a real “being there” feeling.

- When one of the DAP modes is selected, the DSP indicator lights up on the display.

#### All Channel Stereo

This mode can reproduce a larger stereo sound field using all the connected (and activated) speakers.

**All Channel Stereo can be used when the front and surround speakers are connected to this receiver without respect to the center speaker connection.**

- If the center speaker is connected and activated, the same phase of the front left and right signals are mixed and output through the center speaker.

All Channel Stereo can be used while reproducing 2 channel stereo software, either analogue or Linear PCM digital signal.

- When All Channel Stereo is selected, the DSP indicator lights up on the display.

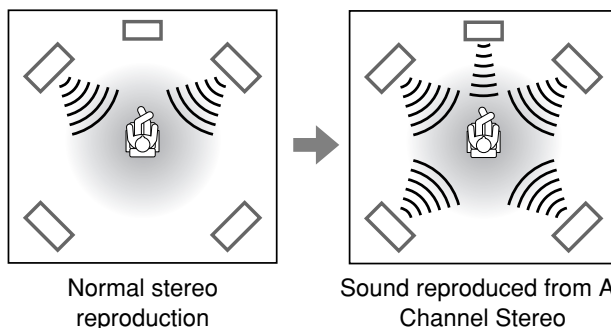

#### NOTE

MPEG Multichannel signals cannot be reproduced.

#### Available Surround/DSP modes for each input signal

○: Possible ×: Impossible

Mode Signals	STEREO	DOLBY DIGITAL	DTS SURROUND	PROLOGIC II MOVIE	PROLOGIC II MUSIC	LIVE CLUB	DANCE CLUB	HALL	PAVILION	ALL CH ST.
Dolby Digital (Multi-channel)	○	○	×	×	×	×	×	×	×	×
Dolby Digital (2-channel)	○	×	×	○	○	×	×	×	×	×
DTS Digital Surround (Multi-channel)	○	×	○	×	×	×	×	×	×	×
DTS Digital Surround (2-channel)	○	×	×	○	○	×	×	×	×	×
Linear PCM	○	×	×	○	○	○	○	○	○	○
Analogue	○	×	×	○	○	○	○	○	○	○
DVD MULTI	×	×	×	×	×	×	×	×	×	×

## Creating realistic sound fields

### About relations between speaker layout and Surround/DSP modes

Available Surround/DSP modes will vary depending on how many speakers are used with this receiver.

**Make sure that you have set the speakers information correctly (see pages 15 to 18).**

- If only front speakers are connected, you cannot use the Surround modes.
- If surround speakers are not connected, you cannot use DSP modes.

**When multi-channel digital software such as Dolby Digital or DTS Digital Surround is played back, the appropriate multichannel Surround mode is automatically activated ("DOLBY D" or "DTS") by pressing SURROUND (with the digital input mode selected).**

- For Dolby Digital 2 channel software, you can select "PLII MOVIE" or "PLII MUSIC" by pressing SURROUND.
- For more details, see "Available Surround/DSP modes for each input signal" on page 29.

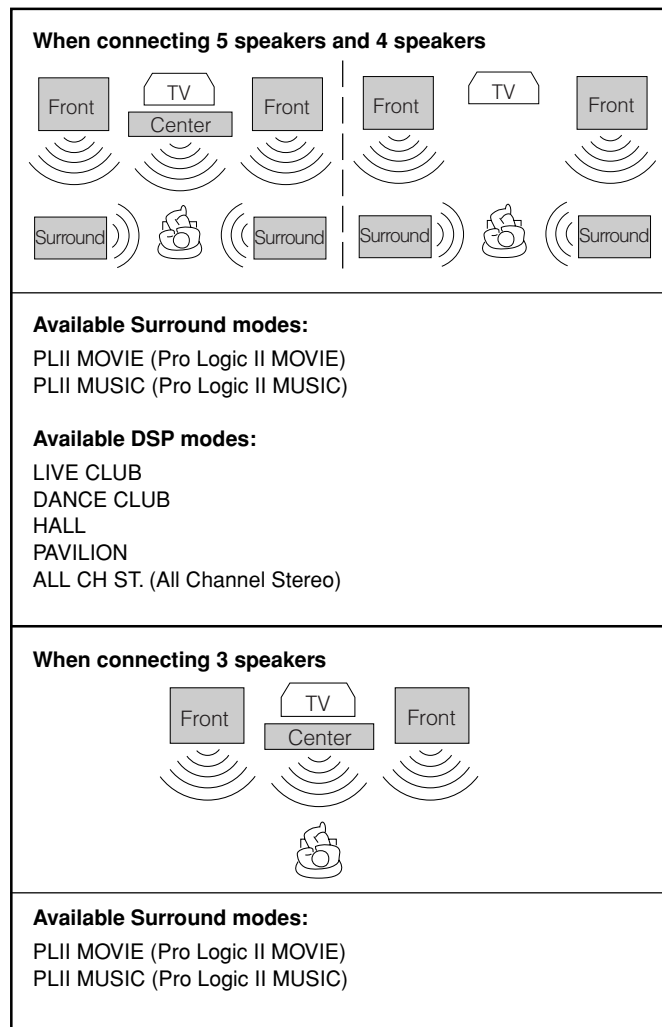

#### NOTE

When "AUTO SR (Auto Surround)" is turned "ON" (see page 20), Surround mode is automatically activated when you select and start playing back a multi-channel digital source.

### Using Surround modes

Once you have adjusted the Surround modes, the adjustment is memorized for each source.

- If you set the speaker information using Smart Surround Setup (see page 15), you do not have to adjust speaker output level.

**When operating this receiver using the remote control, always set the mode selector to AUDIO/TV/VCR/STB.**



#### Before you start, remember...

Make sure that you have set the speaker information correctly (see pages 15 to 18).

#### From the remote control:

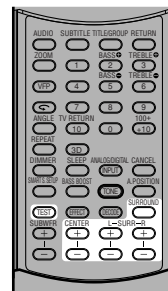

It will be convenient for you to use the remote control for the sound adjustments, since you can make adjustments from your listening point, and use the test signal.

- For selecting Panorama control for Pro Logic II Music, use the buttons on the front panel.

#### 1 Select and play software you like.

If "AUTO SR (Auto Surround)" is set to "ON"

Playing a digital source automatically activates an appropriate Surround mode. (See page 20.) → Go to step 3.

#### 2 Press SURROUND to select an appropriate Surround mode.

- Each time you press the button, the Surround/DSP modes change as follows:

**When playing back multi-channel digital software such as Dolby Digital or DTS Digital Surround:**



DOLBY D or DTS ↔ STEREO (Surround/DSP off)

**When playing back 2 channel digital software such as Dolby Digital or DTS Digital Surround:**

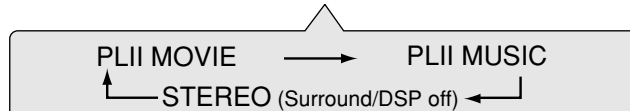

PLII MOVIE → PLII MUSIC

← STEREO (Surround/DSP off) ←

**When playing back any software other than above:**



PLII MOVIE → PLII MUSIC →

LIVE CLUB → DANCE CLUB →

HALL → PAVILION →

ALL CH ST. → STEREO (Surround/DSP off) →

(Back to the beginning)



## Creating realistic sound fields

### 3 Press TEST to check the speakers output balance.

"TEST L" starts flashing on the display, and a test tone comes out of the speakers as follows:

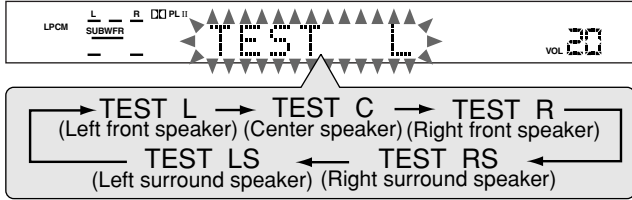

### 4 Adjust the following speaker output levels (from -10 dB to +10 dB).

- Make adjustments so that the sound level of the selected speaker is set at the same level as that of the front speakers.

To adjust the center speaker level, press CENTER +/-.

To adjust the left surround speaker level, press SURR L +/-.

To adjust the right surround speaker level, press SURR R +/-.



Ex.: When selecting "+8 (dB)" for "CENTER."

### 5 Press TEST again to stop the test tone.

The currently selected source name appears on the display.

#### On the front panel:

- No test tone is available when using the buttons on the front panel.

#### Before you start, remember...

There is a time limit in doing the following steps. If the setting is canceled before you finish, start from step 2 again.

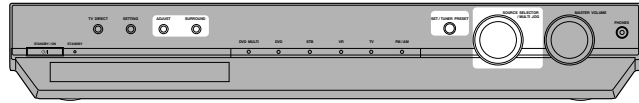

### 1 Select and play software you like.

If "AUTO SR (Auto Surround)" is set to "ON"  
 Playing a digital source automatically activates an appropriate Surround mode. (See page 20.) → Go to step 4.

### 2 Press SURROUND.

MULTI JOG now works for the Surround/DSP mode selection.

### 3 Turn MULTI JOG to select a appropriate Surround mode.

- As you turn MULTI JOG, the indication changes as follows:

When playing back multi-channel digital software such as Dolby Digital or DTS Digital Surround:

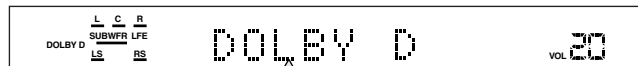

DOLBY D or DTS ↔ STEREO (Surround/DSP off)

When playing back 2 channel digital software such as Dolby Digital or DTS Digital Surround:

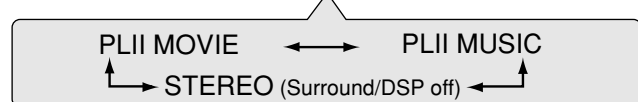

When playing back any software other than above:



### 4 Press ADJUST.

MULTI JOG now works for the sound adjustment.

### 5 Turn MULTI JOG until the setting item you want to set appears on the display, then press SET.

- As you turn MULTI JOG, the indication changes as follows:

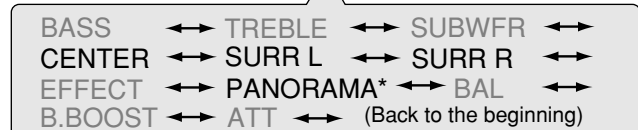

\* Available only for "PLII MUSIC."

CONTINUED ON THE NEXT PAGE

## Creating realistic sound fields

<b>CENTER*1:</b>	To adjust the center speaker output level (from -10 dB to +10 dB).
<b>SURR L*1:</b>	To adjust the left surround speaker output level (from -10 dB to +10 dB).
<b>SURR R*1:</b>	To adjust the right surround speaker output level (from -10 dB to +10 dB).
<b>PANORAMA control*2:</b>	<ul style="list-style-type: none"> <li>• Select "ON" when you would like to enjoy "wraparound" sound effect with side-wall image.</li> <li>• Select "OFF" when you would like to hear originally recorded sound.</li> </ul>

\*1 "0" is the initial setting for each speaker setting.

\*2 "OFF" is the initial setting.

### 6 Turn MULTI JOG to adjust the item selected in step 5, then press SET.

Your setting is stored.

- When adjusting the speaker output levels, make adjustments so that the sound level of the selected speaker is set at the same level as that of the front speakers.



Ex.: When selecting "+8 (dB)" for "CENTER."

### 7 Repeat steps 5 and 6 to adjust the other settings.

#### To cancel Surround mode

Press SURROUND repeatedly on the remote control or press SURROUND then turn MULTI JOG on the front panel so that "STEREO" appears on the display.

- If Surround mode is canceled while playing back multi-channel digital software, all channel signals are mixed and output through the front speakers (and subwoofer if you have connected a subwoofer and set the subwoofer setting correctly—"USE" for Quick Setup or "YES" for Manual Setup—see pages 16 and 17).

#### NOTES

- You can adjust the speaker output levels using the remote control without outputting the test tone.
- You cannot adjust the center speaker output level and no test tone comes out of the center speaker when "CNTR SP" is set to "NO."
- You cannot adjust the surround speaker output levels and no test tone comes out of the surround speakers when "SURR SP" is set to "NO."
- Remember not to change the speaker setting while using any Surround modes; otherwise, the Surround mode may be canceled when you deactivate the speakers required for it.
- You cannot use any Surround modes when selecting DVD MULTI as a playback source.

## Using DSP modes

Once you have adjusted the DSP modes, the adjustment is memorized for each source.

- You cannot use the DSP modes if no surround speakers are connected.
- You cannot adjust the effect level for "ALL CH ST."

**When operating this receiver using the remote control, always set the mode selector to AUDIO/TV/VCR/STB.**



#### Before you start, remember...

Make sure that you have set the speaker information correctly (see pages 15 to 18).

#### From the remote control:

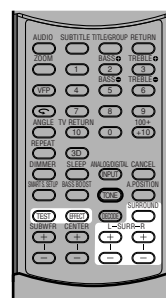

It will be convenient for you to use the remote control for the sound adjustments, since you can make adjustments from your listening point, and use the test signal.

### 1 Start playing 2 channel software—either Linear PCM or analogue signal—and select the source.

### 2 Press SURROUND repeatedly until one of the DSP modes you want to apply appears on the display.

The DSP indicator lights up on the display.

- Each time you press the button, the DSP modes change as follows:

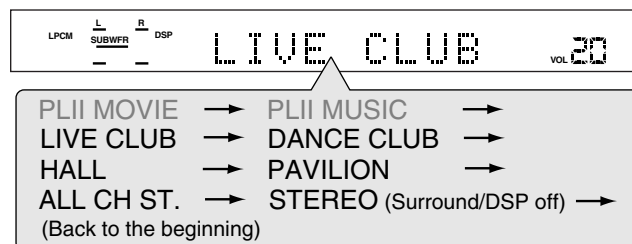

### 3 Press TEST to check the speakers output balance.

"TEST L" starts flashing on the display, and a test tone comes out of the speakers as follows:

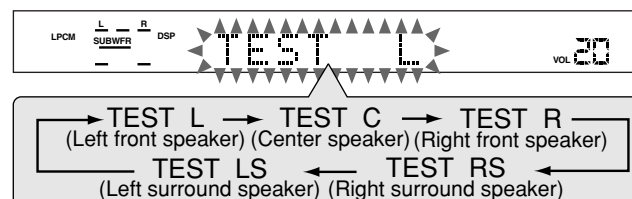

## Creating realistic sound fields

### 4 Adjust the surround speaker output levels (from -10 dB to +10 dB).

- Make adjustments so that the sound level of the selected speaker is set at the same level as that of the front speakers.

To adjust the left surround speaker level, press SURR L +/-.

To adjust the right surround speaker level, press SURR R +/-.



Ex.: When selecting “-8 (dB)” for “SURR R.”

### 5 Press TEST again to stop the test tone.

### 6 Only for DAP modes: Press EFFECT to select the DAP effect level (1 to 5) you want.

- As the number increases, the DAP effect becomes stronger (normally set it to “EFFECT 3”).

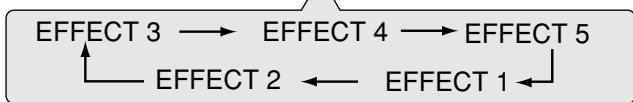

### On the front panel:

- No test tone is available when using the buttons on the front panel.

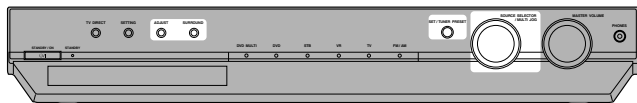

### Before you start, remember...

There is a time limit in doing the following steps. If the setting is canceled before you finish, start from step 2 again.

### 1 Start playing 2 channel software—either Linear PCM or analogue signal—and select the source.

### 2 Press SURROUND.

MULTI JOG now works for the Surround/DSP mode selection.

### 3 Turn MULTI JOG until one of the DSP modes you want to apply appears on the display.

The DSP indicator lights up on the display.

- As you turn MULTI JOG, the indication changes as follows:

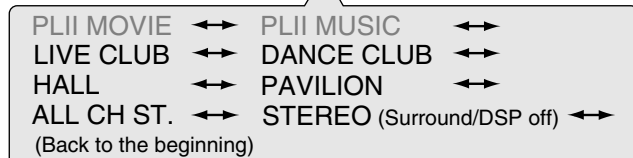

### 4 Press ADJUST.

MULTI JOG now works for the sound adjustment.

### 5 Turn MULTI JOG until the setting item you want to set appears on the display, then press SET.

- As you turn MULTI JOG, the indication changes as follows:

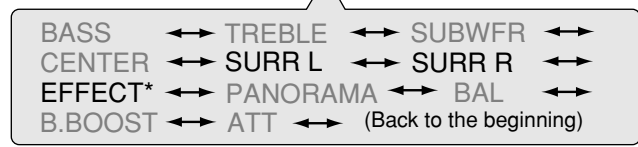

- \* Available only for DAP modes.

**SURR L\*1:** To adjust the left surround speaker output level (from -10 dB to +10 dB).

**SURR R\*1:** To adjust the right surround speaker output level (from -10 dB to +10 dB).

**EFFECT (available only for DAP modes) \*2:**

To adjust the DAP effect level.

As the number increases, the effect becomes stronger (normally set it to “EFFECT 3”).

\*1 “0 (dB)” is the initial setting for each speaker setting.

\*2 “3” is the initial setting.

### 6 Turn MULTI JOG to adjust the item selected in step 5, then press SET.

Your setting is stored.

- When adjusting the speaker output levels, make adjustments so that the sound level of the selected speaker is set at the same level as that of the front speakers.



Ex.: When selecting “-8 (dB)” for “SURR R.”

### 7 Repeat steps 5 and 6 to adjust the other settings.

### To cancel DSP Modes

Press SURROUND repeatedly on the remote control or press SURROUND then turn MULTI JOG on the front panel so that “STEREO” appears on the display. The DSP indicator goes off from the display.

### NOTES

- You can adjust the speaker output levels using the remote control without outputting the test tone.
- You cannot adjust the center speaker output level and no test tone comes out of the center speaker when “CNTR SP” is set to “NO.”
- You cannot adjust the surround speaker output levels and no test tone comes out of the surround speakers when “SURR SP” is set to “NO.”

# Using the DVD MULTI playback mode

This receiver provides the DVD MULTI playback mode for reproducing the analogue discrete output mode (5.1 channel reproduction) of the DVD player.

In addition, the DVD MULTI playback mode can be used for reproducing a DVD Audio sound.

Before playing back a DVD, refer also to the manual supplied with the DVD player.

- When using the DVD MULTI playback mode, connect the DVD player with its analogue discrete output jacks to the DVD IN jacks on the rear panel (see page 10).

**When operating this receiver using the remote control, always set the mode selector to AUDIO/TV/VCR/STB.**



## Activating the DVD MULTI playback mode

**On the front panel:**

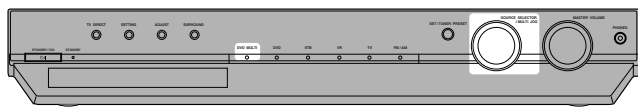

- 1 Turn **SOURCE SELECTOR** until "DVD MULTI" appears on the display.

The DVD MULTI indicator lights in red.

- 2 Select the analogue discrete output mode on the DVD player, and start playing a DVD.

**From the remote control:**

- 1 Press **DVD MULTI**.

The DVD MULTI indicator lights in red.

- 2 Select the analogue discrete output mode on the DVD player, and start playing a DVD.

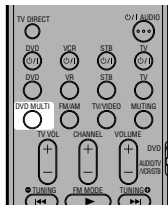

## Adjusting the speaker output level

You can adjust the speaker output level while playing a DVD using the analogue discrete output mode on the DVD player.

Once you have adjusted the sound, the adjustment is memorized.

- The test tone does not output through the speakers to adjust the speakers output levels when selecting DVD MULTI.

**From the remote control:**

It will be convenient for you to use the remote control for the sound adjustments, since you can make adjustments from your listening point.

### Adjust the following speaker output levels (from -10 dB to +10 dB).

- Make adjustments so that the sound level of the selected speaker is set at the same level as that of the front speakers.

**To adjust the center speaker level,** press **CENTER +/-**.

**To adjust the left surround speaker level,** press **SURR L +/-**.

**To adjust the right surround speaker level,** press **SURR R +/-**.

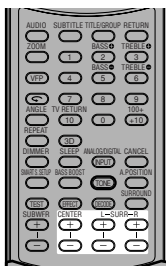

**On the front panel:**

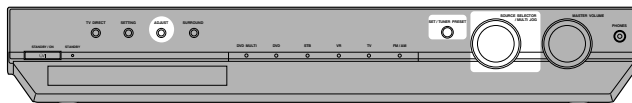

**Before you start, remember...**

There is a time limit in doing the following steps. If the setting is canceled before you finish, start from step 1 again.

- 1 Press **ADJUST**.

MULTI JOG now works for the sound adjustment.

- 2 Turn **MULTI JOG** until the setting item you want to set appears on the display, then press **SET**.

- As you turn MULTI JOG, the indication changes as follows:

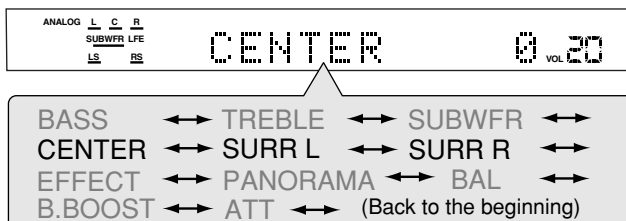

**CENTER\*:** To adjust the center speaker output level (from -10 dB to +10 dB).

**SURR L\*:** To adjust the left surround speaker output level (from -10 dB to +10 dB).

**SURR R\*:** To adjust the right surround speaker output level (from -10 dB to +10 dB).

\* "0 (dB)" is the initial setting.

- 3 Turn **MULTI JOG** to adjust the item selected in step 2, then press **SET**.

Your setting is stored.

- Make adjustments so that the sound level of the selected speaker is set at the same level as that of the front speakers.



Ex.: When selecting "+8 (dB)" for "CENTER."

- 4 Repeat steps 2 and 3 to adjust the other settings.

### NOTES

- When you select DVD MULTI as a source to play, the selected Surround/DSP mode is canceled, and the SURROUND button does not work.
- When using a pair of headphones, the sounds of front left and right channels are output from the headphones.
- The DVD MULTI button does not work for TV Direct.

# Operating other JVC products

You can use the remote control to operate not only this receiver but also other JVC products.

- Refer also to the manuals supplied for the other products.
  - Some JVC VCRs can accept two types of the control signals—remote codes “A” and “B”. This remote control can operate a VCR whose remote control code is set to “A.”
- To operate other products, aim the remote control directly at the remote sensor on the target product.
- **You cannot use the remote control to operate the VDR. To operate the VDR, use the remote control supplied with your VDR.**

Set the mode selector to **AUDIO/TV/VCR/STB**.

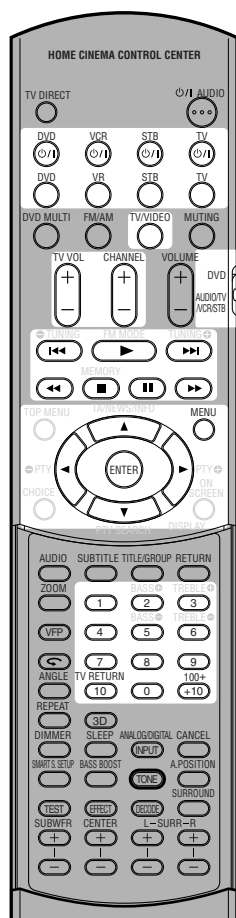

## ■ TV

You can always perform the following operations:

<b>TV <math>\phi</math>/I:</b>	Turn on or off the TV.
<b>TV VOL +/-:</b>	Adjust the volume on the TV.
<b>TV/VIDEO:</b>	Change the input mode (Video input and TV tuner) on the TV.

After pressing TV (source selecting button), you can perform the following operations on the TV.

<b>CHANNEL +/-:</b>	Change the channel numbers.
<b>1 – 9, 0, +10 (100+):</b>	Select the channel numbers.
<b>10 (TV RETURN):</b>	Function as the TV RETURN button.

## ■ VCR

You can always perform the following operations:

<b>VCR <math>\phi</math>/I:</b>	Turn on or off the VCR.
---------------------------------	-------------------------

After pressing VR (source selecting button), you can perform the following operations on the VCR.

<b>CHANNEL +/-:</b>	Change the channel numbers on the VCR.
<b>1 – 9, 0:</b>	Select the channel numbers on the VCR.
<b>▶:</b>	Start playback.
<b>■:</b>	Stop playback.
<b>  :</b>	Pause playback. To release it, press ▶.
<b>▶▶:</b>	Fast-wind a tape.
<b>◀◀:</b>	Rewind a tape.

## ■ STB

You can always perform the following operations:

<b>STB <math>\phi</math>/I:</b>	Turn on or off the STB.
---------------------------------	-------------------------

After pressing STB (source selecting button), you can perform the following operations on the STB.

<b>CHANNEL +/-:</b>	Change the channel numbers on the STB.
<b>1 – 9, 0:</b>	Select the channel numbers on the STB.

## ■ DVD player

You can always perform the following operations:

<b>DVD <math>\phi</math>/I:</b>	Turn on or off the DVD player.
---------------------------------	--------------------------------

After setting the mode selector to “DVD” then pressing DVD (source selecting button), you can perform the following operations on the DVD Player.

<b>▶:</b>	Start playback.
<b>■:</b>	Stop playback.
<b>  :</b>	Pause playback. To release it, press ▶.
<b>▶▶:</b>	Skip to the beginning of the next chapter.
<b>◀◀:</b>	Return to the beginning of the current (or previous) chapter.
<b>MENU:</b>	Display or erase the menu screen.
<b>▲/▼/▶/◀:</b>	Select an item on the menu screen.
<b>ENTER:</b>	Enter a selected item.

You can also use AUDIO, SUBTITLE, TITLE/GROUP, RETURN, ZOOM, VFP, ◀, ANGLE, REPEAT, DIMMER, 3D, and numeric buttons for operating JVC DVD player.

- If these buttons do not function normally, use a remote control supplied with your DVD player. See the instruction supplied with the DVD player for details.

# Operating other manufacturers' equipment

By changing the transmittable signals, you can use the remote control supplied for this unit to operate other manufacturers' equipment.

- Refer also to the manuals supplied with the other products.
- To operate those components with the remote control, first you need to set the manufacturers' codes each for the STB, VCR, and TV.
- After replacing batteries of the remote control, set the manufacturers' codes again.
- **You cannot use the remote control to operate a VDR such as a DVD recorder. To operate the VDR, use the remote control supplied with your VDR.**

## Changing the transmittable signals for operating an STB

- 1 Press and hold STB  $\odot/\text{I}$ .
- 2 Press STB.
- 3 Enter the manufacturer's code using buttons 1 – 9, and 0.
- 4 Release STB  $\odot/\text{I}$ .

Now, you can perform the following operations on the STB.

**STB  $\odot/\text{I}$ :** Turn on or off the STB.

After pressing STB (source selecting button), you can perform the following operations on the STB.

**CHANNEL +/-:** Change the channel numbers on the STB.

**1 – 9, 0:** Select the channel numbers on the STB.

## 5 Try to operate your STB by pressing STB $\odot/\text{I}$ .

When your STB turns on or off, you have entered the correct code.

If more than one codes are listed for your brand of STB, try each one until the correct one is entered.

Manufacturers' codes for STB

Manufacturer	Codes
JVC	01*, 02
AMSTRAD	03 – 06, 31
BT	01
CANAL STELLITE	20
CANAL +	20
D-BOX	24
ECHOSTAR	17 – 19, 21
FINLUX	11
FORCE	28
GALAXIS	27
GRUNDIG	07, 08
HIRSCHMANN	07, 17, 37
ITT NOKIA	11
JERROLD	16
KATHREIN	13, 14, 34
LUXOR	11
MASCOM	32
MASPRO	13
NOKIA	24, 26, 33
PACE	10, 25, 31
PANASONIC	15
PHILIPS	09, 23
RFT	12
SABA	35
SAGEM	22, 29
SALORA	11
SELECTOR	29
SKYMASTER	12, 36
THOMSON	35
TPS	22
TRIAx	30
WISI	07

\* Initial setting

Manufacturers' codes are subject to change without notice. If they are changed, this remote control cannot operate the equipment.

Set the mode selector to AUDIO/TV/VCR/STB.

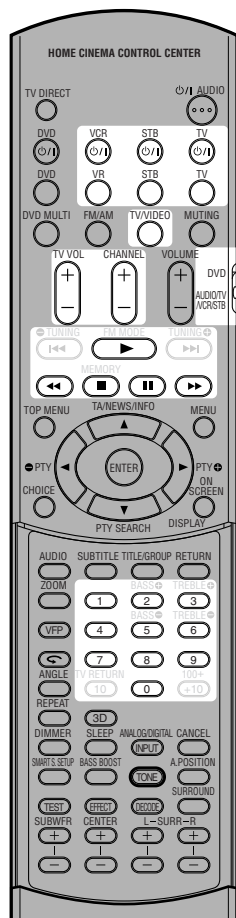



## Operating other manufacturers' equipment

### □ Changing the transmittable signals for operating a VCR

- 1 Press and hold VCR  $\odot$ /I.
- 2 Press VR.
- 3 Enter the manufacturer's code using buttons 1 – 9, and 0.
- 4 Release VCR  $\odot$ /I.

Now, you can perform the following operations on the VCR.

VCR $\odot$ /I:	Turn on or off the VCR.
-----------------	-------------------------

After pressing VR (source selecting button), you can perform the following operations on the VCR.

CHANNEL +/-:	Change the channel numbers on the VCR.
1 – 9, 0:	Select the channel numbers on the VCR.
▶:	Start playback.
■:	Stop playback.
⏸:	Pause playback. To release it, press ▶.
⏮:	Fast-wind a tape.
⏪:	Rewind a tape.

### 5 Try to operate your VCR by pressing VCR $\odot$ /I.

When your VCR turns on or off, you have entered the correct code.

If more than one codes are listed for your brand of VCR, try each one until the correct one is entered.

Manufacturers' codes for VCR

Manufacturer	Codes
JVC	01*
AKAI	02, 36
BELL+HOWELL	03, 16
BLAUPUNKT	04
CGM	03, 05, 16
DAEWOO	34
DIGITAL	05
FISHER	03, 16
G.E.	06
GRUNDIG	07
HITACHI	08, 09
LOEWE	05, 10, 11
MAGNAVOX	04, 05
MITSUBISHI	12 – 15
NOKIA	16
NORDMENDE	17 – 19, 31
ORION	20
PANASONIC	21
PHILIPS	05, 22
PHONOLA	05
SABA	17 – 19, 23, 31
SAMSUNG	24, 25
SANYO	03, 16
SHARP	26, 27
SIEMENS	07
SONY	28 – 30, 35
TELEFUNKEN	17 – 19, 31, 32
TOSHIBA	33

\* Initial setting

### □ Changing the transmittable signals for operating a TV

- 1 Press and hold TV  $\odot$ /I.
- 2 Press TV.
- 3 Enter the manufacturer's code using buttons 1 – 9, and 0.
- 4 Release TV  $\odot$ /I.

Now, you can perform the following operations on the TV.

TV $\odot$ /I:	Turn on or off the TV.
----------------	------------------------

TV VOL +/-:	Adjust the volume.
-------------	--------------------

TV/VIDEO:	Change the input mode (either TV or VIDEO).
-----------	---

After pressing TV (source selecting button), you can perform the following operations on the TV.

CHANNEL +/-:	Change the channel numbers.
--------------	-----------------------------

1 – 9, 0:	Select the channel numbers.
-----------	-----------------------------

### 5 Try to operate your TV by pressing TV $\odot$ /I.

When your TV turns on or off, you have entered the correct code.

If more than one codes are listed for your brand of TV, try each one until the correct one is entered.

Manufacturers' codes for TV

Manufacturer	Codes
JVC	01*
AKAI	02, 05
BLAUPUNKT	03
DAEWOO	09, 30, 31
FENNER	04, 30, 31
FISHER	05
GRUNDIG	06
HITACHI	07, 08
IRRADIO	02, 05
MAGNAVOX	09
MITSUBISHI	10, 32
MIVER	03
NOKIA	11, 33
NORDMENDE	12, 13, 17, 25 – 27
ORION	14
PANASONIC	15, 16
PHILIPS	09
SABA	12, 13, 17, 25 – 27
SAMSUNG	09, 18, 31
SANYO	05
SCHNEIDER	02, 05
SHARP	19
SONY	20 – 24
TELEFUNKEN	12, 13, 17, 25 – 27
THOMSON	12, 13, 17, 25 – 27, 29
TOSHIBA	28

\* Initial setting

Manufacturers' codes are subject to change without notice. If they are changed, this remote control cannot operate the equipment.

# Troubleshooting

Use this chart to help you solve daily operational problems. If there are any problems you cannot solve, contact your JVC's service center.

	PROBLEM	POSSIBLE CAUSE	SOLUTION
General	The power does not come on.	The power cord is not plugged in.	Plug the power cord into an AC outlet.
	No sound from speakers.	Speaker signal cables are not connected.	Check speaker wiring and reconnect if necessary.
		An incorrect source is selected.	Select the correct source.
		Muting is activated.	Press MUTING to cancel the mute.
		An incorrect input mode (analogue or digital) is selected.	Select the correct input mode (analogue or digital).
		Connections are incorrect.	Check connections.
		TV Direct is activated.	Deactivate TV Direct (see pages 13 and 20).
	Buttons cannot be used.	TV Direct is activated.	Deactivate TV Direct (see pages 13 and 20).
	Sound from one speaker only.	The balance is set to one extreme.	Adjust the balance properly (see page 22).
	The unit turns off and becomes standby mode.	Speakers are overloaded because of high volume.	1. Stop the playback source. 2. Turn on the unit again, and adjust the volume.
		Speakers are overloaded because of a short circuit at the speaker terminals.	Check the speaker wiring. If speaker wiring is not short-circuited, contact your dealer.
		The unit is overloaded because of a high voltage.	Consult your dealer after unplugging the power cord.
	Remote control does not operate as you intend.	The remote control is not ready for your intended operation.	Press a source selecting button or TONE first, then press the buttons you want to use. (See pages 21, 35, 36 and 37.)
	Remote control does not work.	There is an obstruction hiding the remote sensor on the unit.	Remove the obstruction.
		Batteries are weak.	Replace batteries.
The mode selector is set to the incorrect position.		Set the mode selector to the proper position.	
Remote control does not work for the VDR.	You cannot use this remote control to operate the VDR.	Use the remote control supplied with the VDR.	
Bass sound is reinforced too much when listening in stereo.	Appropriate bass level is not selected.	Adjust audio position level (see page 22).	



## Troubleshooting

PROBLEM	POSSIBLE CAUSE	SOLUTION	
Surround mode cannot be selected.	Surround mode is not available on the software being played back, or only the front speakers are set for use.	Play not multi-channel software or check the speaker setting.	Surround/DSP
DSP mode cannot be selected.	DSP mode is not available on the software being played back, or only the front speakers are set for use.	Play back Linear PCM or analogue software or check the speaker setting.	
Continuous hiss or buzzing during FM reception.	Incoming signal is too weak.	Connect an outdoor FM antenna or contact your dealer.	FM/AM
	The station is too far away.	Select a new station.	
	An incorrect antenna is used.	Check with your dealer to be sure you have the correct antenna.	
	Antennas are not connected properly.	Check connections.	
Occasional cracking noise during FM reception.	Ignition noise from automobiles.	Move the antenna farther from automobile traffic.	

### NOTE

When you use the digital coaxial connection, the sounds may be intermittently distorted by the outside noise such as a lightning discharge but they will restore automatically. This is not a malfunction.

# Specifications

Designs & specifications are subject to change without notice.

## Amplifier

Output Power	
At stereo operation:	
Front channels:	100 W per channel, min. RMS, both channels driven into 8 $\Omega$ at 1 kHz with no more than 10% total harmonic distortion. (IEC268-3)
At surround operation:	
Front channels:	100 W per channel, min. RMS, driven into 8 $\Omega$ at 1 kHz with no more than 0.8% total harmonic distortion.
Center channel:	100 W, min. RMS, driven into 8 $\Omega$ at 1 kHz, with no more than 0.8% total harmonic distortion.
Surround channels:	100 W per channel, min. RMS, driven into 8 $\Omega$ at 1 kHz, with no more than 0.8% total harmonic distortion.

## Audio

Audio Input Sensitivity/Impedance (1 kHz):	
DVD, DVD MULTI, STB, VR, TV:	260 mV/47 k $\Omega$
Audio Input (DIGITAL IN)* :	
Coaxial: DIGITAL 1 (VR):	0.5 V(p-p)/75 $\Omega$
Optical: DIGITAL 2/3 (STB/DVD):	-21 dBm to -15 dBm (660 nm $\pm$ 30 nm)
* Corresponding to Linear PCM, Dolby Digital, and DTS Digital Surround (with sampling frequency—32 kHz, 44.1 kHz, 48 kHz).	
Audio Output Level:VR, TV:	250 mV
Signal-to-Noise Ratio ('66 IHF/DIN):	
DVD MULTI:	87 dB/62 dB
Frequency Response (8 $\Omega$ ):	
DVD, STB, VR, TV:	20 Hz to 20 kHz ( $\pm$ 1 dB)
Tone Control:	
Bass (100 Hz):	$\pm$ 10 dB $\pm$ 2 dB
Treble (10 kHz):	$\pm$ 10 dB $\pm$ 2 dB
Bass Boost:	+4 dB $\pm$ 1 dB at 100 Hz

## Video

Video Input Sensitivity/Impedance (1 kHz):	
Composite video:DVD, STB, VR, TV:	1 V(p-p)/75 $\Omega$
S-VIDEO:DVD, STB, VR:	
(Y: luminance):	1 V(p-p)/75 $\Omega$
(C: chrominance):	0.286 V(p-p)/75 $\Omega$
RGB:DVD, STB, VR:	0.7 V(p-p)/75 $\Omega$
Video Output Level/Impedance (1 kHz):	
Composite video:VR, TV:	1 V(p-p)/75 $\Omega$
S-VIDEO:TV:	
(Y: luminance):	1 V(p-p)/75 $\Omega$
(C: chrominance):	0.286 V(p-p)/75 $\Omega$
RGB:TV:	0.7 V(p-p)/75 $\Omega$
Signal-to-Noise Ratio (S/N):	45 dB
Synchronize:	Negative

## FM tuner (IHF)

Tuning Range:	87.50 MHz to 108.00 MHz
Usable Sensitivity:	
Monaural:	17.0 dBf (1.95 $\mu$ V/75 $\Omega$ )
50 dB Quieting Sensitivity:	
Monaural:	21.3 dBf (3.2 $\mu$ V/75 $\Omega$ )
Stereo:	41.3 dBf (31.5 $\mu$ V/75 $\Omega$ )
Stereo Separation at REC OUT:	35 dB at 1 kHz

## AM (MW) tuner

Tuning Range:	
MW:	522 kHz to 1 629 kHz

## General

Power Requirements:	AC $\sim$ 230 V, 50 Hz
Power Consumption:	105 W (at operation) 2 W (in standby mode)
Dimensions (W x H x D):	435 mm x 69.5 mm x 330.5 mm
Mass:	6.6 kg

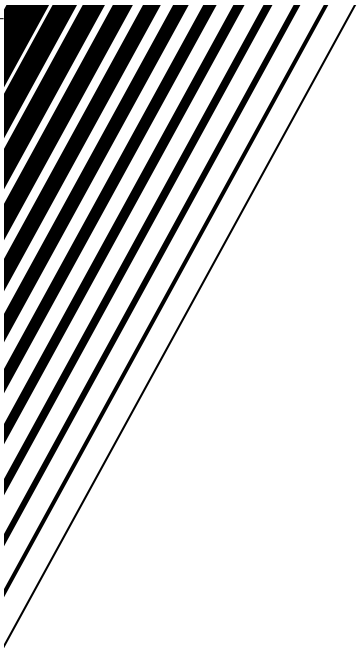

RX-ES9SL  
HOME CINEMA CONTROL CENTER

**JVC**  
VICTOR COMPANY OF JAPAN, LIMITED



 EN

© 2003 VICTOR COMPANY OF JAPAN, LIMITED

 0703NHMMDWJEIN

## Free Manuals Download Website

<http://myh66.com>

<http://usermanuals.us>

<http://www.somanuals.com>

<http://www.4manuals.cc>

<http://www.manual-lib.com>

<http://www.404manual.com>

<http://www.luxmanual.com>

<http://aubethermostatmanual.com>

Golf course search by state

<http://golfingnear.com>

Email search by domain

<http://emailbydomain.com>

Auto manuals search

<http://auto.somanuals.com>

TV manuals search

<http://tv.somanuals.com>