

JVC



DVD DIGITAL CINEMA SYSTEM

TH-D51

Consists of XV-THD51, SP-THD51W, SP-THD51F and SP-THD51C

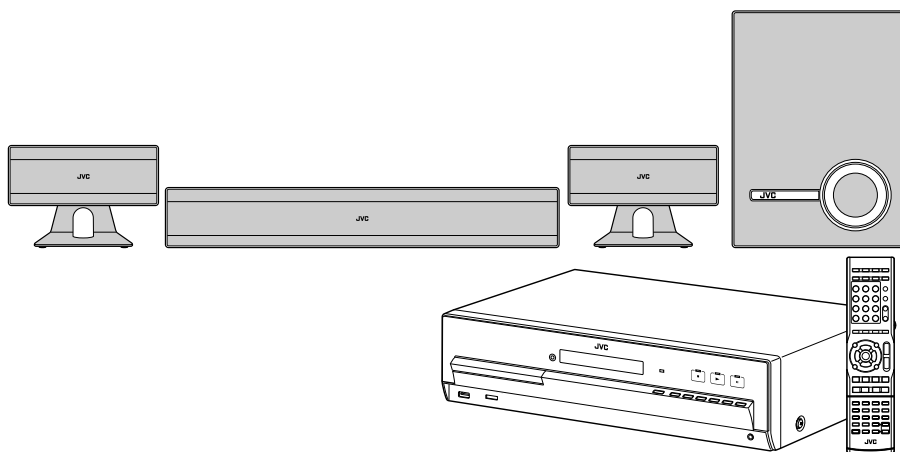

HDMI



MPEG-4
ASF PLAYBACK

Radio Data System Digital Direct Progressive Scan

INSTRUCTIONS

LVT1767-001A
[B]

Warnings, Cautions and Others

IMPORTANT for the U.K.

DO NOT cut off the mains plug from this equipment. If the plug fitted is not suitable for the power points in your home or the cable is too short to reach a power point, then obtain an appropriate safety approved extension lead or consult your dealer.

BE SURE to replace the fuse only with an identical approved type, as originally fitted.

If nonetheless the mains plug is cut off ensure to remove the fuse and dispose of the plug immediately, to avoid a possible shock hazard by inadvertent connection to the mains supply.

If this product is not supplied fitted with a mains plug then follow the instructions given below:

IMPORTANT.

DO NOT make any connection to the terminal which is marked with the letter E or by the safety earth symbol or coloured green or green-and-yellow.

The wires in the mains lead on this product are coloured in accordance with the following code:

Blue: Neutral
Brown: Live

As these colours may not correspond with the coloured markings identifying the terminals in your plug proceed as follows:

The wire which is coloured blue must be connected to the terminal which is marked with the letter N or coloured black.

The wire which is coloured brown must be connected to the terminal which is marked with the letter L or coloured red.

IF IN DOUBT - CONSULT A COMPETENT ELECTRICIAN.

CAUTION — button!

Disconnect the mains plug to shut the power off completely (the STANDBY lamp goes off). When installing the apparatus, ensure that the plug is easily accessible.

The  button in any position does not disconnect the mains line.

- When the System is on standby, the STANDBY lamp lights red.
- When the System is turned on, the STANDBY lamp goes off.

The power can be remote controlled.

CAUTION

To reduce the risk of electrical shocks, fire, etc.:

1. Do not remove screws, covers or cabinet.
2. Do not expose this appliance to rain or moisture.

CAUTION

- Do not block the ventilation openings or holes. (If the ventilation openings or holes are blocked by a newspaper or cloth, etc., the heat may not be able to get out.)
- Do not place any naked flame sources, such as lighted candles, on the apparatus.
- When discarding batteries, environmental problems must be considered and local rules or laws governing the disposal of these batteries must be followed strictly.
- Do not expose this apparatus to rain, moisture, dripping or splashing and that no objects filled with liquids, such as vases, shall be placed on the apparatus.

CAUTION:

Excessive sound pressure from earphones or headphones can cause hearing loss.

IMPORTANT FOR LASER PRODUCTS

1. CLASS 1 LASER PRODUCT
2. **CAUTION:** Do not open the top cover or cabinet. There are no user serviceable parts inside the unit; leave all servicing to qualified service personnel.
3. **CAUTION:** Visible and/or invisible class 1M laser radiation when open. Do not view directly with optical instruments.
4. REPRODUCTION OF LABEL: CAUTION LABEL, PLACED INSIDE THE UNIT.

CAUTION VISIBLE AND/OR INVISIBLE CLASS 1M LASER RADIATION WHEN OPEN. DO NOT VIEW DIRECTLY WITH OPTICAL INSTRUMENTS. (ENG)	ATTENTION RAYONNEMENT LASER VISIBLE ET/OU INVISIBLE DE CLASSE 1M LORS QU'EST LE PAS REGARDER DIRECTEMENT AVEC DES INSTRUMENTS OPTIQUES. (ENG)	AVISO RADIACION LASER DE CLASE 1M VISIBLE Y/O INVISIBLE CUANDO ESTA ABIERTO. NO MIRAR DIRECTAMENTE CON INSTRUMENTAL OPTICO. (FRA)	VARNING SYNLIG OCH/ELLER OSYNLIG LASERSTRÅLNING, KLASS 1M, NÄR DENNA DEL ÄR ÖPPNAD. BETRÄKTA EJ STRÅLEN MED OPTISKA INSTRUMENT. (SWE)	注意 この装置はレーザー光線 及び赤外線が のぞき出し、 レーザー光線が 出ます。 光学機器で直視 しないでください。 (JPN)	CAUTION VISIBLE AND/OR INVISIBLE CLASS 1 LASER RADIATION WHEN OPEN. DO NOT STARE INTO BEAM. FDA 21 CFR (ENG) LW4603-003A
--	--	--	--	---	--

Dear Customer,

This apparatus is in conformance with the valid European directives and standards regarding electromagnetic compatibility and electrical safety.

European representative of Victor Company of Japan, Limited is:

JVC Technology Centre Europe GmbH
Postfach 10 05 52
61145 Friedberg
Germany

Caution: Proper Ventilation

To avoid risk of electric shock and fire and to protect from damage, place the apparatus on a level surface. The minimal clearances are shown below:

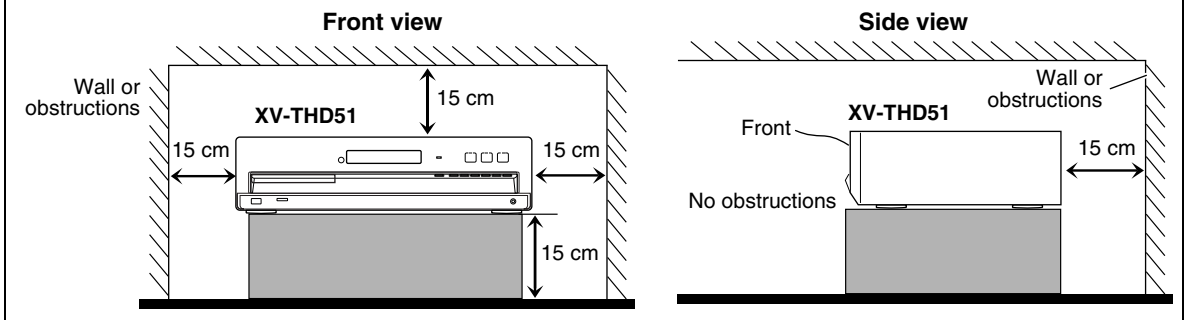

Information for Users on Disposal of Old Equipment

[European Union]

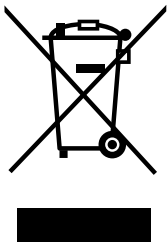

Attention:

This symbol is only valid in the European Union.

This symbol indicates that the electrical and electronic equipment should not be disposed as general household waste at its end-of-life. Instead, the product should be handed over to the applicable collection point for the recycling of electrical and electronic equipment for proper treatment, recovery and recycling in accordance with your national legislation.

By disposing of this product correctly, you will help to conserve natural resources and will help prevent potential negative effects on the environment and human health which could otherwise be caused by inappropriate waste handling of this product. For more information about collection point and recycling of this product, please contact your local municipal office, your household waste disposal service or the shop where you purchased the product.

Penalties may be applicable for incorrect disposal of this waste, in accordance with national legislation.

(Business users)

If you wish to dispose of this product, please visit our web page www.jvc-europe.com to obtain information about the take-back of the product.

[Other Countries outside the European Union]

If you wish to dispose of this product, please do so in accordance with applicable national legislation or other rules in your country for the treatment of old electrical and electronic equipment.

How to read this manual

The following icons and illustrations are used to make the explanations simple and easy-to-understand.















Icons for System operations	
	Operations from the center unit
	Operations from the remote control
	The function can be operated from the on-screen bar (21).
Icons for the references and notes	
	Reference page for the function/operation
	Caution for the function/operation
	Note for the function/operation
	Tip for the function/operation
Icons for operating information	
	The function is available while playing.
	The function is available while paused.
	The function is available while stopped.
	There is a time limit on performing the target operation.
Illustrations for button operations	
	Press the button briefly.
	Press the button repeatedly.
	Press and hold the button.
	Press button (A), then press button (B).
	Press button (B) while holding button (A).

Table of contents

Before using this System	2
Playable discs/devices/files.....	3
Playable disc types	3
Playable digital devices	3
Playable file types	4
Getting started	5
Checking the supplied accessories	5
Putting batteries into the remote control	5
Attaching the stands to the front speakers.....	5
Speaker layout and connection	5
Connecting the AM (MW) and FM antennas.....	7
Connecting a TV	7
Connecting external components	8
Connecting the AC power cord	8
Basic and common operations.....	9
Sound and monitor settings	11
Sound settings and adjustments.....	11
Monitor settings.....	12
Audio/video settings for external components	13
iPod playback	14
Disc/file playback	15
Basic playback.....	15
Using the disc menu	17
Locating a desired scene or song.....	17
Changing the playback mode	18
Advanced operations	19
Special playback for DVD Audio.....	20
Operation from the TV screen.....	21
Personal settings	23
Tuner operations	25
Tuning in to a station.....	25
Presetting stations	25
Selecting the FM reception mode.....	25
Receiving FM stations with Radio Data System.....	26
Operating external components	29
Setting the manufacturer's code	29
Operating external components.....	29
References	30
Manufacturer's code list.....	30
Messages and icons shown on the TV.....	31
Available surround modes.....	31
Language code list.....	32
Troubleshooting.....	33
Specifications	34

Before using this System

Precautions

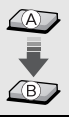
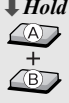
There are no user-serviceable parts inside. If anything goes wrong, unplug the power cord and consult your dealer.

Notes on installing the System

- Select a location which is level, dry and neither too hot nor too cold between 5°C and 35°C.
- Do not install the System in a location subject to vibrations.
- Do not put heavy objects on the System.

Avoid moisture, water, dust, and high temperatures

- Do not install the System in moist or dusty locations.
- If water gets inside the System, turn off the power and remove the plug from the wall outlet, then consult your dealer. Using the System in this state may cause a fire or electrical shock.
- Do not expose the System to direct sunlight or place it near a heating device.

To prevent malfunctions or damage to the System

- Do not insert any metallic objects, such as wires, hairpins, coins, etc. into the System.
- Do not block the vents.

Notes on the power cord

- When you are away on travel or otherwise for an extended period of time, remove the plug from the wall outlet. A small amount of power is always consumed while the power cord is connected to the wall outlet.
- When unplugging the System from the wall outlet, always pull the plug, not the power cord.
- Disconnect the power cord before cleaning or moving the System.
- Do not modify, twist or pull the power cord, or put anything heavy on it. Doing so may cause fire, electric shock, or other accidents.

About copyright laws

Observe the copyright laws in your country before recording from original sources. Recording of copyrighted material may infringe copyright laws.

About the copyguard system

The discs are protected by the copyguard system. When connecting the System to a TV via a VCR, or to a TV with a built-in VCR, the copyguard system activates and distortion of the picture may occur.

Notes on installing and using the speakers

- Place the speakers and subwoofer on a flat and level surface.
 - The speakers are magnetically shielded to avoid color distortions on TVs. If the color on a TV is distorted, perform the following procedure:
 - Turn off the TV's main power switch or unplug it before installing the speakers. Then wait at least 30 minutes before turning on the TV's main power switch again.
- Some TVs may still be affected even though you have followed the above procedure. If this happens, move the speakers away from the TV.
- The subwoofer is not magnetically shielded. To avoid color distortion, do not place it near the TV or monitor.
 - When moving the speakers and subwoofer, do not pull the speaker cords. Doing so may cause the speakers and/or subwoofer to fall over, causing damage or injury.
 - When installing the speakers on a wall, be sure to have them installed by qualified personnel. DO NOT install the speakers on a wall by yourself.
 - Do not lean against the speakers, as they could fall down or break, possibly causing an injury. Be especially careful that children do not lean against them.

About the adjustment of volume

Always set the volume to the minimum level before starting any source. If the volume is set at a high level, the sudden blast of sound could permanently damage your hearing and/or blow out the speakers.

To clean the System

- Use a soft cloth. Follow the relevant instructions on the use of chemically-coated cloths.
- If the System is heavily stained, apply a small amount of water or neutral detergent to the cloth and wipe clean, then wipe with a dry cloth.
- Do not use benzene, thinner or other organic solvents and disinfectants. These may cause deformation or discoloring.

Playable discs/devices/files

- ✔ Some discs/files may require operations that differ from those explained in this manual.
- ✔ Some discs/devices/files may not be recognized or played back correctly due to their characteristics.

Playable disc types

Type of format	Types of media
DVD Video	<ul style="list-style-type: none"> • Discs on the market • DVD-R/-R DL/-RW • +R/+RW • DualDisc* (DVD side only)
DVD Audio	<ul style="list-style-type: none"> • Discs on the market • DVD-R/-R DL/-RW • +R/+RW
Super Video CD (SVCD)/Video CD (VCD)	<ul style="list-style-type: none"> • Discs on the market • CD-R/-RW
Audio CD (CD-DA)	<ul style="list-style-type: none"> • Discs on the market • CD Text (Audio part only) • CD-R/-RW
DVD VR	<ul style="list-style-type: none"> • DVD-R/-RW
Audio/video files (  4)	<ul style="list-style-type: none"> • DVD-R/-R DL/-RW in UDF Bridge format • CD-R/-RW in ISO 9660 format

- ✔ It is possible to play back finalized +R/+RW (DVD Video format only) discs. “DVD” lights on the display panel when a +R/+RW disc is loaded.
- ✔ DVD-R/-RW: This System does not support “multi-border” discs.
- ✔ CD-R/-RW:
 - This System supports “multi-session” discs (up to 20 sessions).
 - This System cannot play “packet write” discs.

Region code of DVD Video

DVD Video players and DVD Video discs have their own Region Code numbers. This System can play back DVD Video discs whose Region Code numbers include “2.”

Ex.:



Unplayable discs—unwarranted

Playing back the following discs generates noise and damages the speakers.

- DVD-ROM, DVD-RAM, DualDisc* (non-DVD side)
- CD-ROM, CD-I (CD-I Ready), Photo CD, SACD
- Unfinalized discs (except DVD VR)
- Discs with an irregular shape or discs with tape, stickers or paste on either the label side or playback side
- Warped, dirty, or scratched discs

* *The Non-DVD side of a “DualDisc” does not comply with the “Compact Disc Digital Audio” standard. Therefore, the use of Non-DVD side of a DualDisc on this product may not be recommended.*

Playable digital devices

JVC bears no responsibility for any loss of data in an iPod and USB mass storage class device while using this System.

iPod

iPod model	AUDIO	VIDEO
iPod nano 1GB/2GB/4GB	√	
iPod nano (2nd Generation) 2GB/4GB/8GB	√	
iPod mini 4GB/6GB	√	
iPod (4th Generation) 20GB/40GB	√	
iPod photo (4th Generation) 20GB/30GB/40GB/60GB	√	√*
iPod video (5th Generation) 30GB/60GB/80GB	√	√

* *Only still pictures are available.*

- ✔ If the iPod does not play correctly, update your iPod software to the latest version. For details about updating your iPod, check on the Apple web site <<http://www.apple.com>>.

iPod is a trademark of Apple Inc., registered in the U.S. and other countries.

USB mass storage class device

A USB flash memory device, hard disk drive, multimedia card reader, digital camera, etc. can be used with this System through USB connection.

- ✔ This System is compatible with USB 2.0 Full Speed.
- ✔ This System cannot recognize a USB mass storage class device whose rating exceeds 5 V/500 mA.

Playable file types

The following files in a disc or a USB mass storage class device can be played back.

Type of file		Extensions
Audio	MP3	<.mp3>
	WMA	<.wma>
	WAV	<.wav>
Picture	JPEG	<.jpg>, <.jpeg>
Movie	ASF	<.asf>
	MPEG-1	<.mpg>, <.mpeg>
	MPEG-2	<.mpg>, <.mpeg>, <.mod>
	DivX (6.x, 5.x, 4.x and 3.11)	<.divx>, <.div>, <.avi>

- ❗ If a file on a USB mass storage class device exceeds the following conditions, it may not be played back correctly:
 - Maximum data transfer rate: 2 Mbps
 - Maximum frame rate: 30 fps for progressive
 - Maximum file size: 2 GB
- ❗ The System recognizes up to 150 tracks (files) per group, and 99 groups per disc/device. The total number of tracks (files) that the System can detect is 4 000.

Information about the recording conditions for the files on a disc/device

MP3/WMA files

- The System supports MP3/WMA files recorded at a bit rate of 32 kbps – 320 kbps and a sampling frequency of 16 kHz, 22.05 kHz, 24 kHz*, 32 kHz, 44.1 kHz, or 48 kHz.
- It is recommended to record each file at a sample rate of 44.1 kHz and at a data transfer rate of 128 (96*) kbps.

* For WMA only

WAV files

- The System supports WAV files recorded at a quantization rate of 8 bit or 16 bit and a sampling frequency of 8 kHz, 11.025 kHz, 12 kHz, 16 kHz, 22.05 kHz, 24 kHz, 32 kHz, 44.1 kHz, or 48 kHz.
- It is recommended to record each file at a sample rate of 44.1 kHz and at a quantization rate of 16 bit Linear PCM.

JPEG files

- It is recommended to record a file at 640 x 480 resolution. (If a file has been recorded at a resolution of more than 640 x 480, it will take a longer time to be displayed.)
- This System can only play baseline JPEG files.

ASF files

- The System supports MPEG-4 files with the following conditions:
File format: ASF
Visual profile: MPEG-4 SP (Simple Profile)
Audio CODEC: G.726
Max. picture size: 352 x 288 (CIF)
Max. bit rate: 384 kbps

MPEG1/MPEG2 files

- The stream format should conform to the MPEG system/program stream.
- 720 x 576 pixels (25 fps)/720 x 480 pixels (30 fps) is recommended for the highest resolution.
- This System also supports resolutions of 352 x 576/480 x 576/352 x 288 pixels (25 fps) and 352 x 480/480 x 480/352 x 240 pixels (30 fps).
- The file format should be MP@ML (Main Profile at Main Level)/SP@ML (Simple Profile at Main Level)/MP@LL (Main Profile at Low Level).
- Audio streams should conform to MPEG1 Audio Layer-2 or MPEG2 Audio Layer-2.

DivX files

- The System supports DivX files whose resolution is 720 x 480 pixels or less (30 fps), and 720 x 576 pixels or less (25 fps).
- Audio stream should conform to Dolby Digital (including multi-channel) or MPEG1 Audio Layer-3 (MP3).
- The System does not support GMC (Global Motion Compression).
- Files encoded in the interlaced scanning mode may not be played back correctly.

Getting started

Checking the supplied accessories

If anything is missing, contact your dealer immediately.

- Remote control (x 1)
- Batteries (x 2)
- FM antenna (x 1)
- AM (MW) loop antenna (x 1)
- Docking station for iPod (x 1)
- Feet (x 8) (For front speakers)
- Stands (x 2) (For front speakers)
- Screws: M5 x 12 mm (x 4) (For front speakers)

Putting batteries into the remote control

R03 (UM-4)/AAA (24F) type dry-cell batteries (supplied)

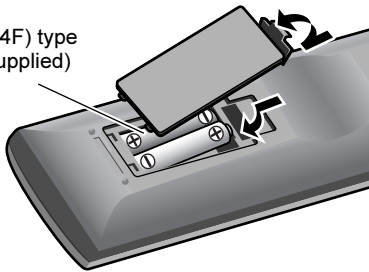

- ❗ Battery shall not be exposed to excessive heat such as sunshine, fire or the like.
- ❗ If the range or effectiveness of the remote control decreases, replace both batteries.

Attaching the stands to the front speakers

To place the front speakers horizontally, attach a stand to each one.

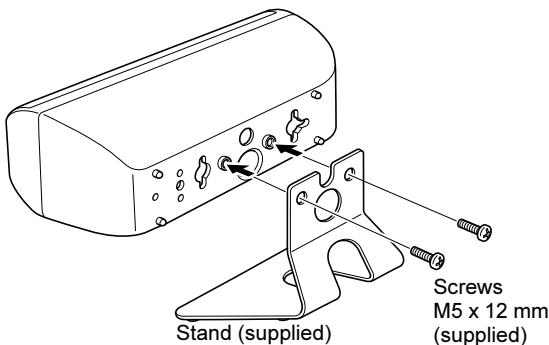

- ❗ You can install the front and center surround speakers on the wall. When installing the front speakers on the wall, do not attach the stands.

Speaker layout and connection

You can enjoy the sound of the center channel, surround right channel, and surround left channel with the center surround speaker.

Speaker layout

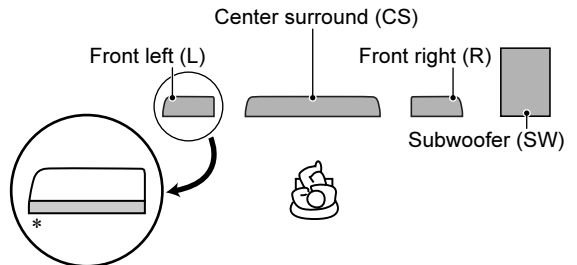

- * Place each front speaker with the curved-side facing outward.

- ❗ Select "S.SPK F" as the speaker position mode for this layout. (📖 11)

Attaching the feet

When placing the front speakers vertically, attach the feet as illustrated.

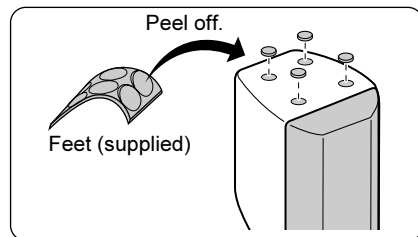

- ❗ You can turn the JVC logos to make them legible.



Do not connect the power cord until all other connections have been made.

Speaker connection

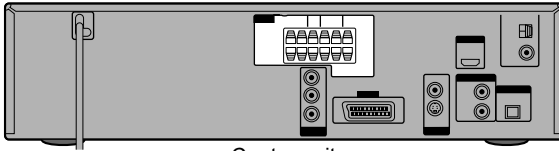

Connecting the speaker cords

Connect the speaker cords to the center unit.

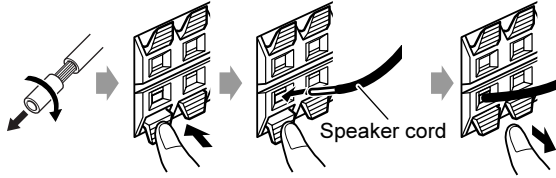

- Connect the black cords to the ⊖ terminals.
- Connect the gray cords to the ⊕ terminals.

- ⚠ If you connect the speakers other than those supplied for the System, use speakers of the same speaker impedance (SPEAKER IMPEDANCE) indicated on the rear of the center unit.
- ⚠ DO NOT connect more than one speaker cord to one speaker terminal.

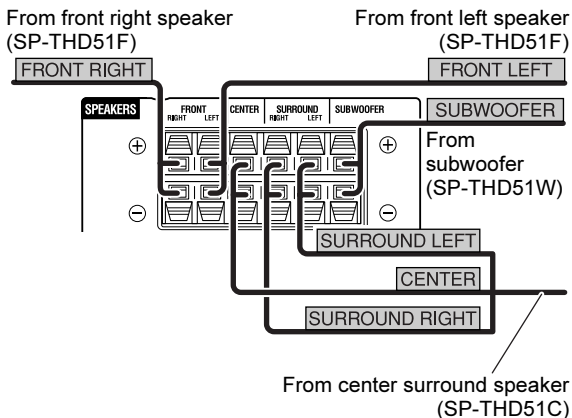

Optional speaker layout and connection

You can connect separately purchased speakers to the System as the center, surround right, and surround left speakers.

- See “Attaching the feet” (📖 5) and “Connecting the speaker cords” on the left column before connecting.

Speaker layout

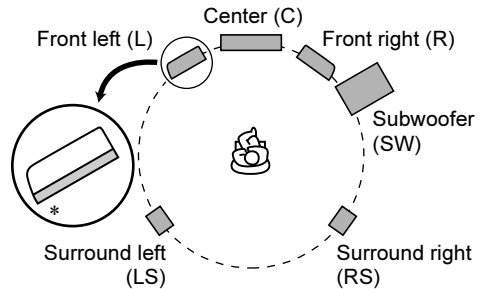

- * Place each front speaker with the curved-side facing outward.

- ⚠ Select “S.SP.K R” as the speaker position mode for this layout. (📖 11)
- ⚠ To obtain the best possible surround sound from this System, place all the speakers except the subwoofer at the same distance from the listening position. If it is impossible, adjust the delay time from DELAY menu. (📖 24)

Speaker connection

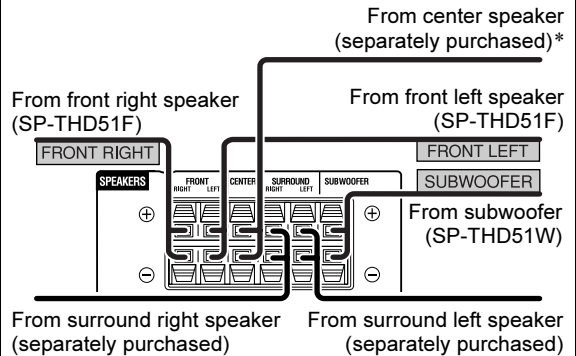

- * You can use the supplied center surround speaker as the center speaker.

When you connect the center surround speaker, connect only the CENTER speaker cord to the CENTER speaker terminal of the center unit.

- ⚠ When you connect the supplied center surround speaker as the center speaker, be sure to keep the followings for the unused cords and handle them with care.
 - Do insulate the SURROUND RIGHT and SURROUND LEFT speaker cords with insulating tape.
 - Do not let the unused cords touch any materials.

Getting started

Connecting the AM (MW) and FM antennas

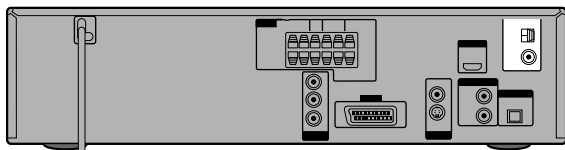

- ✔ Make sure the antenna conductors do not touch any other terminals, connecting cords or power cords.
- ✔ Keep the AM loop antenna cable wrapped around the AM loop antenna frame, otherwise the effectiveness and sensitivity of the AM loop antenna may be reduced.

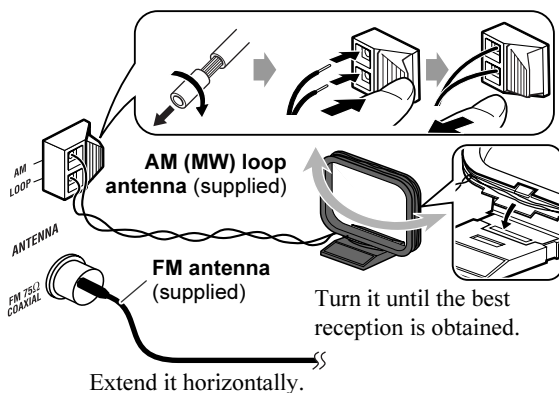

For better FM reception

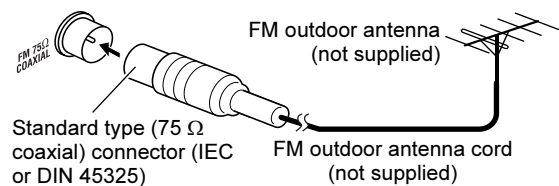

Connecting a TV

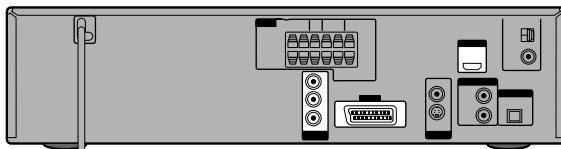

Connect the TV to the appropriate video out jacks to view the playback picture.

- ✔ Make the following settings after connecting the TV:
 - Scanning mode (📖 12)
 - Monitor out (📖 13)
 - MONITOR TYPE (📖 23)

Connection using the HDMI terminal

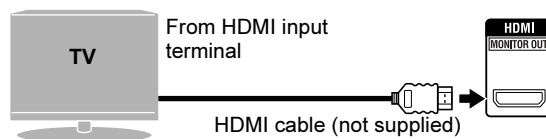

- ✔ You can make the following settings for the TV when the HDMI connection is used:
 - HDMI DVI COLOR (📖 23)
 - HDMI OUT (📖 23)
 - HDMI AUDIO OUT (📖 24)
 - DOWN MIX (📖 24)*
- ✔ Use a certified HDMI cable, which has the HDMI logo.
- ✔ You can use a monitor with a DVI terminal by connecting with a DVI-HDMI conversion cable.
- ✔ When you play HDCP (High-Bandwidth Digital Content Protection) source, allow a few seconds for the sound and picture to be transmitted to the speakers and TV while the confirmation process is completed.
- ✔ On some TVs, no sound may come out during playback of sources such as DVD Audio even when the HDMI AUDIO OUT setting is "ON" (📖 24).

* This setting is available only when the speaker position mode is set to "S.SPK F" (📖 11).

Do not connect the power cord until all other connections have been made.

Connection using the component video jacks

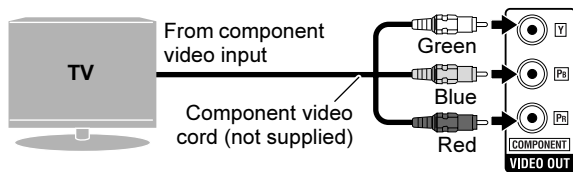

- ✔ If your TV does not support progressive video input, connect a TV via the AV (scart) connector (see below).
- ✔ For the BNC connection, use a plug adapter (not supplied).

Connection using the scart connector

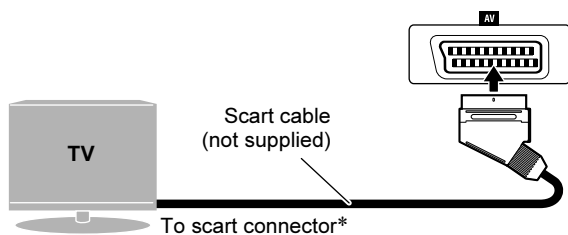

* Some TVs' scart connectors emit audio signals. In such a case, you can enjoy the TV sound through this System by selecting TV SOUND as the source to play. (13 10)

- ✔ No sound signal comes out from the AV (scart) connector.

Connecting external components

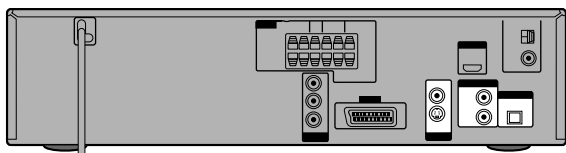

- ✔ Select "VIDEO" as the source (13 10) for playing a component connected as follows.

Video connection

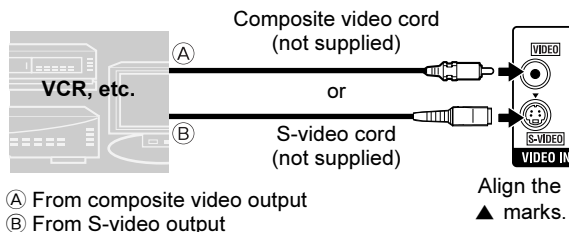

- ✔ To view a video from the external component connected as above:
 - Connect a TV via the AV (scart) connector (see the left column).
 - Select an appropriate video input setting according to the video connection. (13 13)

Audio connection

Connecting a digital component

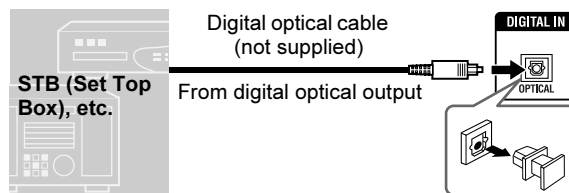

- ✔ Select "OPT" as the audio input setting before playing back. (13 13)

Connecting an analog component

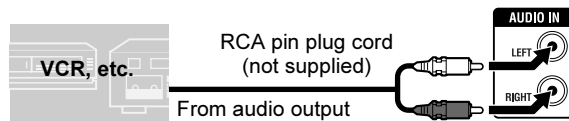

- ✔ Select "2CH" as the audio input setting before playing back. (13 13)

Connecting the AC power cord

Plug in the System only after all other connections have been completed.

Available video output terminals for each source

✔: Available —: Not available

Terminal \ Source	DVD USB	iPod	VIDEO
HDMI	✔	—	—
COMPONENT	✔	—	—
AV (scart)	✔	✔ (Composite signal only)	✔ (Composite signal only)

Basic and common operations

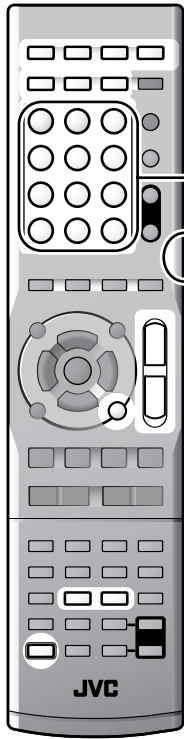

How to use the number buttons

To select 3: Press 3.
 To select 10: Press 10.
 To select 14: Press ≥ 10 , 1, then 4.
 To select 24: Press ≥ 10 , 2, then 4.
 To select 40: Press ≥ 10 , 4, then 0.
 To select 114: Press ≥ 10 , ≥ 10 , 1, 1, then 4.

Set the remote control mode before operation.

AUDIO \rightarrow TV \rightarrow VCR/STB \rightarrow

Point at the remote sensor directly.

STANDBY lamp:

- Goes off when the System is turned on.
- Lights when the System is turned off.

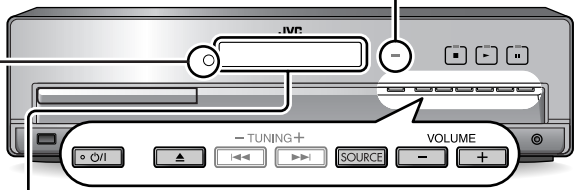

Display

To change the display brightness

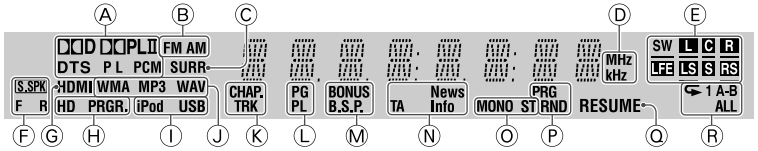

- (A) Digital audio signal format indicators
- (B) Tuner band indicators (25)
- (C) Lights when one of the surround modes is activated. (12)
- (D) Frequency unit indicators for FM/AM
- (E) Signal and speaker indicators
 - L** (front left), **C** (center), **R** (front right), **LFE** (low frequency effect), **LS** (surround left), **RS** (surround right), **S** (monaural surround): Lights when the signal comes in for the digital input or when the System is ready to receive the signal for the analog input.
 - SW** (subwoofer): Always lights.
 - _**: Lights while reproducing the channel's sound through the speaker.
- (F) Speaker position mode indicators (11)
- (G) Lights when both the System and the TV (with HDMI connection) are ready to communicate each other.
- (H) Scanning mode indicators (12)
 - HD**: Lights when "720P" or "1080I" is selected.
 - PRGR**.: Lights when the progressive scanning mode is activated.
- (I) Digital device indicators
- (J) File type indicators
- (K) Lights when the chapter (**CHAP.**) or track (**TRK**) number is displayed.
- (L) Lights when selecting a program number (**PG**) or playlist number (**PL**) of a DVD VR disc by using TITLE/GROUP. (17)
- (M) Special playback indicators for DVD Audio (20)
 - BONUS**: Lights when a bonus group is detected.
 - B.S.P**: Lights when browsable still pictures are detected.
- (N) Program type (for Radio Data System) indicators (26)
- (O) FM reception mode indicators (25)
 - MONO**: Lights when receiving an FM stereo station in monaural.
 - ST**: Lights when receiving an FM stereo station.
- (P) Lights during program play (**PRG**) or random play (**RND**). (18)
- (Q) Lights when the System memorizes the position where the playback is interrupted. (16)
- (R) Repeat mode indicators (18, 21)

Turning the power on or off

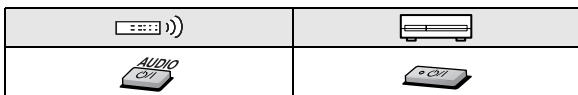

To turn off the System by using the sleep timer



-- (off) → 10 → 20 → 30 → 60 → 90 → 120
→ 150 → 180 → (back to the beginning)
(unit: minutes)

To check the remaining time, press the button once.

Selecting the source

To do		Indication	
Play back a disc		DVD	15
Play back a file on a USB mass storage class device		USB	15
Play back an iPod		iPod	14
Listen to an FM or AM (MW) station		FM or AM	25
Play back an external component		VIDEO*	29
Listen to the sound from the TV connected via the AV (scart) connector.		TV SOUND	8

To select the source from the center unit



* Make sure that the appropriate audio and video input settings have been made for the source. For details about the settings, see "Setting the audio input" and "Setting the video input" (13).

Adjusting the volume

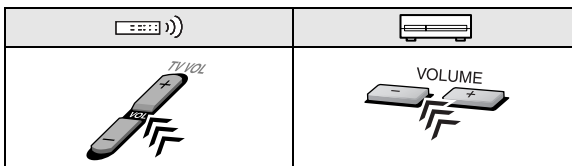

To turn off the sound instantly



"MUTING" is shown on the display.

To restore the sound, press the button again, or adjust the volume level.

Prohibiting disc ejection

1 Turn off the System.

2 Lock the disc tray.

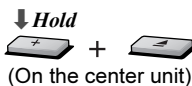

"LOCKED" appears on the display.

To unlock the disc tray, perform the above procedure again. "UNLOCKED" appears on the display.

Listening with headphones

Be sure to turn down the volume before connecting or putting on the headphones.

When headphones are connected, the System automatically deactivates the speakers and cancels the surround mode (12) temporarily.

- "H.PHONE" appears on the display.

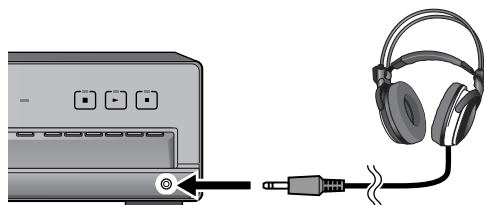

While a multi-channel source is played back, the channel signals are down-mixed.

Sound and monitor settings

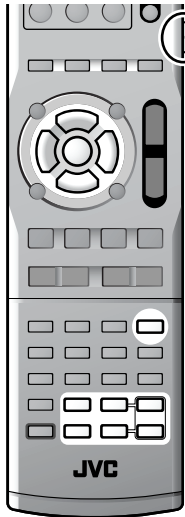

Set the remote control mode before operation.

AUDIO ~
TV -
VCR/STB -

Adjusting the output level of the speakers and subwoofer

1 The items you can adjust differ depending on the selected speaker position mode (see the left column).



• When the speaker position mode is “S.SP K F”:

CENTER → SURR → SUBWFR → (back to the beginning)

• When the speaker position mode is “S.SP K R”:

FRNT L → FRNT R → CENTER → SURR L → SURR R → SUBWFR → (back to the beginning)

2 Adjust the output level.



- Different output level settings can be stored for the two groups of sources—FM/AM and the others.
- You can also make adjustments from the LEVEL menu (page 24) when the speaker position mode is “S.SP K R.”

Sound settings and adjustments

Selecting the speaker position mode

For optional speaker layout (page 6), change the speaker position mode.

1 Turn off the System. (page 10)

2 **Hold**

S . SP K F

3 Select “S.SP K R.”



S.SP K F (Surround speaker: Front)	Initial setting • The S.SP K F indicator lights on the display.
S.SP K R (Surround speaker: Rear)	For optional speaker layout • The S.SP K R indicator lights on the display.

- As the speaker position mode is changed, the following settings are also changed automatically:
 - The output level settings of the speakers and of subwoofer (see the right column) are initialized.
 - The surround mode (page 12) is set to “AUTO SUR.”

Adjusting the bass and treble sounds

1



TRE	Adjusts the treble sound
BASS	Adjusts the bass sound

2 Adjust the level.



Using the surround mode



Select one of the available surround modes.



The surround modes you can select depend on the playback source and the selected speaker position mode (11). For details on each surround mode, see “Available surround modes” (31).

- During playback with “S.SP K F” speaker position mode:

AUTO SUR → MOVIE → WIDE/2CH → SUPER W → OFF → (back to the beginning)

When the source is “FM” or “AM,” the surround mode cannot be activated.

- When the speaker position mode is “S.SP K R”:

During 2-channel playback:

AUTO SUR → MOVIE → MUSIC → STADIUM → ALL ST → OFF → (back to the beginning)

When the source is “FM” or “AM,” you can only select “ALL ST.”

During multi-channel playback:

AUTO SUR → currently selected mode* → OFF → (back to the beginning)

* When “AUTO SUR” is selected, the System automatically selects a proper multi-channel surround mode, such as “DOLBY D (Dolby Digital)” or “DTS (DTS Digital Surround).”

To check the surround mode currently selected, press SURROUND once.

- During playback of ASF, MPEG-2, or MPEG-1 files, the surround mode setting is ineffective.
- During playback of DivX, the surround mode setting is effective only for multi-channel files with “S.SP K R” selected as the speaker position mode.
- For DVD Audio, when “LR ONLY” appears on the display, activate the surround mode for the multi-channel reproduction.

Monitor settings

Setting the scanning mode



Select the scanning mode for the sources “DVD” and “USB” according to the type of TV and to connection method.

- 1 Select “DVD” or “USB” as the source.

(10)

- 2 ↓ Hold
SCAN MODE

- 3 Select an appropriate scanning mode, then confirm the selection.



- When connecting the TV via the HDMI MONITOR OUT terminal (7), select “AUTO,” “1080I,” “720P,” or “576P.”
- When connecting the TV via the COMPONENT jacks (8), select “576P.”
- When connecting the TV via the AV (scart) connector (8), select “RGB” or “Y/C.”

RGB	Select for the TV accommodating the interlaced RGB/composite video signal.
Y/C	Select for the TV accommodating the interlaced S-video signal.
1080I	To watch the picture in interlaced scanning mode.
576P	To watch the picture in progressive scanning mode.
720P	
AUTO	The System automatically emits the video signal to give you the best picture quality on your TV.

- You can get better picture quality in the following orders:
 - 1080I > 720P > 576P
 - RGB > Y/C
- If the HDMI MONITOR OUT terminal and the AV (scart) connector are both connected to a TV or TVs, you cannot change the scanning mode for the AV (scart) connector.
- When the scanning mode does not correspond to that of the TV, the picture is not displayed normally.

Sound and monitor settings

See page 11 for button locations.

Setting the monitor out parameter

Select the video output jack type of the TV you will use to watch the playback. (🔊📖 7)

1 

2 Select “MON. (monitor).”

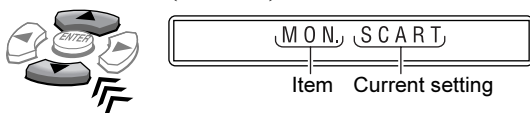

3 Select an appropriate video output according to the TV connection.



SCART	For connection via the AV (scart) connector
HDMI	For connection via the HDMI MONITOR OUT terminal
COMP	For connection via the COMPONENT jacks

Setting the video input

Set the video input of the external component for “VIDEO.”

1 

2 Select “VIN. (video input).”

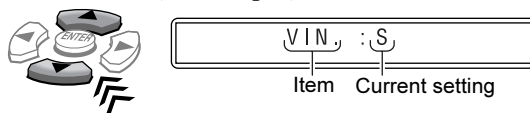

3 Select an appropriate video input according to the video connection. (🔊📖 8)



S	For connection via the S-VIDEO jack
CV	For connection via the VIDEO (composite) jack

Audio/video settings for external components

Setting the audio input

Set the audio input of the external component for “VIDEO.”

1 

2 Select “AIN. (audio input).”

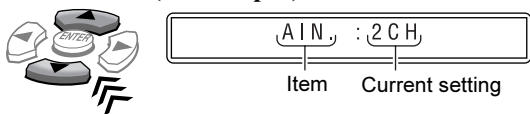

3 Select an appropriate audio input according to the audio connection. (🔊📖 8)



2CH	For connection via the AUDIO IN jacks
OPT	For connection via the DIGITAL IN terminal

iPod playback

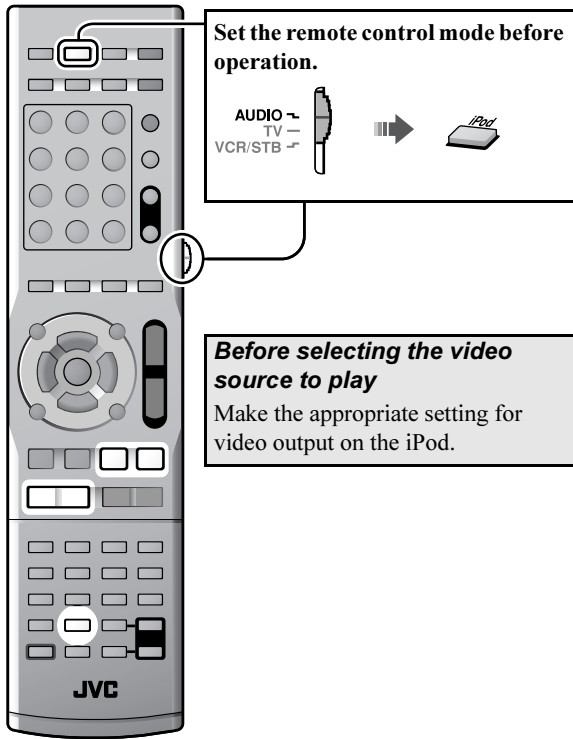

Play/pause/search/skip

To do		
Start playback		
Pause		
Fast-forward/fast-reverse search within the current track		
Skip to the next/previous item*		

* While playing back a video

- The iPod enters sleep mode when you turn off the System or select another source.
- To show the still pictures in the iPod, play them back in slide-show mode on the iPod.

- DO NOT touch the iPod terminal pins or the connector pins.
- When the iPod is not charged through the System, the iPod may not be turned on from the System.
- If the sound is distorted when audio sources with high recording levels are played, you are recommended to deactivate the equalizer on your iPod.
- To view a video/picture from the iPod on the TV, connect the System to the TV via the AV (scart) connector. (8)
- You cannot send any data to your iPod from the System.
- The iPod battery is charged only when "iPod" is selected as the source.

Starting playback

- DO NOT connect or disconnect the iPod when the System is turned on.
- Be sure to reduce the volume on the System to the minimum level before connecting an iPod. Adjust the volume after playback has started.

1 Connect an iPod while the System is turned off.

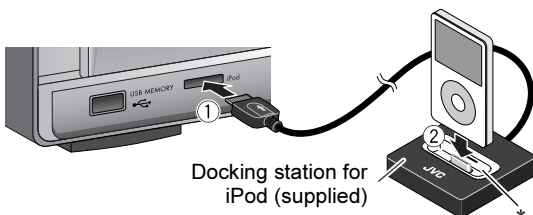

* Attach the dock adapter (supplied for the iPod or separately purchased) before placing the iPod. (33)

2 Turn on the System, then select "iPod" as the source. (10)

"CONNECT" appears on the display. If the iPod is not connected firmly, "NO CONNE" appears.

3 Start playing the iPod.



- Press ► (play button) again if the iPod does not start playback.

If the iPod which is not listed in "Playable digital devices" (3) is connected, the iPod may not be operated from the System. In this case, deactivate the iPod battery charge function so that the iPod may be operated, but the iPod cannot be charged through the System.

To deactivate the battery charge function

↓ Hold "P.OFF" appears on the display.

To use the battery charge function, perform the above procedure again. "P.ON" appears on the display.

Disc/file playback

The following icons show the available disc/file types for the target function:



Initial settings

Make the following settings before playing back discs/files.

- Scanning mode (12)
- Monitor out (13)
- MONITOR TYPE (23)
- ON SCREEN LANGUAGE (23)

Set the remote control mode before operation.

For disc playback



For playback of a file on a USB mass storage class device



Operating the touch sensor panel

You can operate the playback control buttons on the center unit simply by touching them.

When you touch any one of these buttons, it lights briefly in blue.

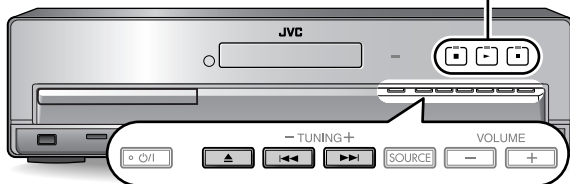

✔ If a still picture is displayed for about 5 minutes, the System automatically dims the screen (screen saver function). You can deactivate the screen saver function. (23)

✔ When several types of files (music, picture or movie) are recorded on a disc or device, select the file type you want to play. (23)

✔ For messages and icons shown on the display, see "Messages and icons shown on the TV" (31).

Basic playback

Playing back a disc

1 Select "DVD" as the source. (10)

2 (On the center unit)

3 Place a disc on the tray.

Label side up

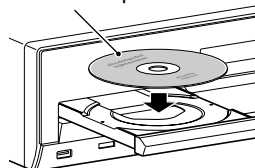

When placing an 8 cm disc

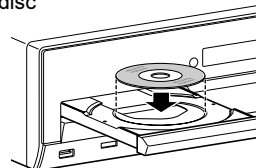

4 Start playback.

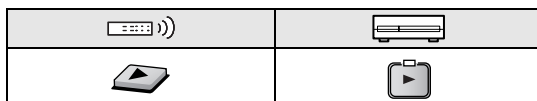

- JPEG: Slide-show playback starts.
- MP3/WMA/WAV: The file control display appears on the TV. (22)

Playing back a file on a USB mass storage class device

1 Connect a USB mass storage class device while the System is turned off.

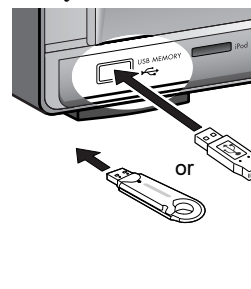

Digital Audio Player

2 Turn on the System, then select "USB" as the source. (10)









Playback starts automatically.

Press ► (play button) to start playback if the file is not played back automatically.

- JPEG: Slide-show playback starts.
- MP3/WMA/WAV: The file control display appears on the TV. (22)

- ❗ DO NOT connect or disconnect the device when the System is turned on.
- ❗ You cannot connect a computer to the USB MEMORY terminal of the System.
- ❗ DO NOT connect the device through a USB hub.
- ❗ iPod does not play through the USB MEMORY terminal. When iPod is connected to the USB MEMORY terminal, "RESTRICT" appears on the display.
- ❗ This System may not play back some USB mass storage class devices and does not support DRM (Digital Rights Management).
- ❗ When connecting with a USB cable, use the USB 2.0 cable whose length is less than 1 m.

Play/stop/pause/search

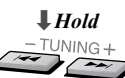

To do		
Start playback		
Stop playback		
Pause		
Fast-forward/fast-reverse search*1	 *2	

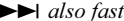
*1 To return to normal playback, press  (play button).

*2 Pressing and holding  also fast-forwards/fast-reverses tracks or files.

Resume function

The System memorizes the position where the playback has been interrupted by one of the following operations:

- Pressing  once
- Turning off the power ( 10)
- Changing the source ( 10)

DVD VIDEO	DVD AUDIO	DVD VR
VCD	SVCD	CD
MP3 WMA WAV	JPEG	ASF
MPEG 1	MPEG 2	DivX

To resume playback, press  (play button) or the corresponding source button.

To clear the memorized position, press  twice.

- Opening the disc tray or disconnecting the USB mass storage class device also clears the memorized position.

❗ This function does not work in program play and random play. ( 18)

💡 You can deactivate the resume function. ( 24)

Changing the playback information



Each time you press the button, the playback information alternates between "type A" and "type B" on the display as follows:

Ex.: When a DVD Video disc is played back

Information type A

DCID	SURR	2 4	1: 2 3: 3 1	SV	MP3	WMA	ASF	MPEG 1	MPEG 2	DivX
------	------	-----	-------------	----	-----	-----	-----	--------	--------	------

Chapter number Time information*1

Information type B

DCID	SURR	T 1 5	C 2 4	SV	MP3	WMA	ASF	MPEG 1	MPEG 2	DivX
------	------	-------	-------	----	-----	-----	-----	--------	--------	------

Title number Chapter number

Disc/file type	Information type A	Information type B
DVD VIDEO	Chapter number with time information*1	Title (T) number and chapter (C) number
DVD VR		Program (PG) number/Playlist (PL) number and chapter (C) number
VCD SVCD CD	Track number with time information*1 *2	_____
DVD AUDIO ASF MPEG 2		Group (G) number and track (T) number
MP3 WMA WAV JPEG MPEG 1 DivX	File number	Group (G) number and file (F) number

*1 For DVD Video, DVD Audio, DVD VR, VCD, SVCD, or CD, you can change the time information mode ( 21). For MP3, WMA, WAV, ASF, MPEG1, MPEG2, or DivX, elapsed playing time is shown.

*2 While playing a VCD or SVCD with PBC ( 17), only track number is displayed.

Disc/file playback

Using the disc menu

For DVD Video/DVD Audio



- For a DVD Video disc For a DVD Audio disc

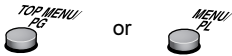

- Select the desired item, then confirm the selection.



Select



Confirm

For some discs, you can also select items by using the number buttons.

For VCD/SVCD with PBC



The Play Back Control function (PBC) allows you to operate the VCD/SVCD using menus.

Select the number of the desired item while the menu is displayed on the TV.*



- To move to the next or previous page of the current menu



- To return to the previous menu



To perform playback without PBC

- While playback is stopped, select the desired track by using the number buttons.*
- While playback is stopped, select the desired track by pressing ►► repeatedly, then press ► (play button).

To activate the PBC function, press TOP MENU(/PG) or MENU(/PL).

While playing back a VCD or SVCD with PBC (“PBC” is shown on the display), some functions such as time search do not work.

* For details on using the number buttons, see “How to use the number buttons” (9).

Locating a desired scene or song

- Selecting the beginning of a desired scene or song

To do		Disc/file												
Skip chapter/track/file		<table border="1"> <tr><td>DVD VIDEO</td><td>DVD AUDIO</td><td>DVD VR</td></tr> <tr><td>VCD</td><td>SVCD</td><td>CD</td></tr> <tr><td>MP3 WMA WAV</td><td>JPEG</td><td>ASF</td></tr> <tr><td>MPEG 1</td><td>MPEG 2</td><td>DivX</td></tr> </table>	DVD VIDEO	DVD AUDIO	DVD VR	VCD	SVCD	CD	MP3 WMA WAV	JPEG	ASF	MPEG 1	MPEG 2	DivX
DVD VIDEO	DVD AUDIO	DVD VR												
VCD	SVCD	CD												
MP3 WMA WAV	JPEG	ASF												
MPEG 1	MPEG 2	DivX												
Select the chapter/track/file number* ³ * ⁴		<table border="1"> <tr><td>DVD VIDEO</td><td>DVD AUDIO</td><td>DVD VR</td></tr> <tr><td>VCD</td><td>SVCD</td><td>CD</td></tr> <tr><td>MP3 WMA WAV</td><td>JPEG</td><td>ASF</td></tr> <tr><td>MPEG 1</td><td>MPEG 2</td><td>DivX</td></tr> </table>	DVD VIDEO	DVD AUDIO	DVD VR	VCD	SVCD	CD	MP3 WMA WAV	JPEG	ASF	MPEG 1	MPEG 2	DivX
DVD VIDEO	DVD AUDIO	DVD VR												
VCD	SVCD	CD												
MP3 WMA WAV	JPEG	ASF												
MPEG 1	MPEG 2	DivX												
Select the title/program or playlist/group number* ³		<table border="1"> <tr><td>DVD VIDEO</td><td>DVD AUDIO</td><td>DVD VR</td></tr> <tr><td>VCD</td><td>SVCD</td><td>CD</td></tr> <tr><td>MP3 WMA WAV</td><td>JPEG</td><td>ASF</td></tr> <tr><td>MPEG 1</td><td>MPEG 2</td><td>DivX</td></tr> </table>	DVD VIDEO	DVD AUDIO	DVD VR	VCD	SVCD	CD	MP3 WMA WAV	JPEG	ASF	MPEG 1	MPEG 2	DivX
DVD VIDEO	DVD AUDIO	DVD VR												
VCD	SVCD	CD												
MP3 WMA WAV	JPEG	ASF												
MPEG 1	MPEG 2	DivX												
Enter the number while “—” is flashing on the display		<table border="1"> <tr><td>DVD VIDEO</td><td>DVD AUDIO</td><td>DVD VR</td></tr> <tr><td>VCD</td><td>SVCD</td><td>CD</td></tr> <tr><td>MP3 WMA WAV</td><td>JPEG</td><td>ASF</td></tr> <tr><td>MPEG 1</td><td>MPEG 2</td><td>DivX</td></tr> </table>	DVD VIDEO	DVD AUDIO	DVD VR	VCD	SVCD	CD	MP3 WMA WAV	JPEG	ASF	MPEG 1	MPEG 2	DivX
DVD VIDEO	DVD AUDIO	DVD VR												
VCD	SVCD	CD												
MP3 WMA WAV	JPEG	ASF												
MPEG 1	MPEG 2	DivX												

The features above may not work for some discs/files.

*¹ For DVD Video, DVD VR, VCD, and SVCD discs, this function is not available while playback is stopped.

*² For DVD Video and DVD VR discs, you can select a title/program while playback is stopped.

*³ For details on using the number buttons, see “How to use the number buttons” (9).

*⁴ When selecting the chapter/track/file number from the on-screen bar, see “Using the on-screen bar” (21).

- Selecting the desired position of a scene or song

To do		Disc/file												
Move the playback position back by 10 seconds (one-touch replay)* ¹ * ²		<table border="1"> <tr><td>DVD VIDEO</td><td>DVD AUDIO</td><td>DVD VR</td></tr> <tr><td>VCD</td><td>SVCD</td><td>CD</td></tr> <tr><td>MP3 WMA WAV</td><td>JPEG</td><td>ASF</td></tr> <tr><td>MPEG 1</td><td>MPEG 2</td><td>DivX</td></tr> </table>	DVD VIDEO	DVD AUDIO	DVD VR	VCD	SVCD	CD	MP3 WMA WAV	JPEG	ASF	MPEG 1	MPEG 2	DivX
DVD VIDEO	DVD AUDIO	DVD VR												
VCD	SVCD	CD												
MP3 WMA WAV	JPEG	ASF												
MPEG 1	MPEG 2	DivX												
Skip in approximately 5-minute intervals* ¹		<table border="1"> <tr><td>DVD VIDEO</td><td>DVD AUDIO</td><td>DVD VR</td></tr> <tr><td>VCD</td><td>SVCD</td><td>CD</td></tr> <tr><td>MP3 WMA WAV</td><td>JPEG</td><td>ASF</td></tr> <tr><td>MPEG 1</td><td>MPEG 2</td><td>DivX</td></tr> </table>	DVD VIDEO	DVD AUDIO	DVD VR	VCD	SVCD	CD	MP3 WMA WAV	JPEG	ASF	MPEG 1	MPEG 2	DivX
DVD VIDEO	DVD AUDIO	DVD VR												
VCD	SVCD	CD												
MP3 WMA WAV	JPEG	ASF												
MPEG 1	MPEG 2	DivX												

*¹ This function works only within the same title/program/file.

*² This function is not available during repeat play.

Changing the playback mode

Program play and random play cannot be used for a USB mass storage class device.

Programming the playing order—program play

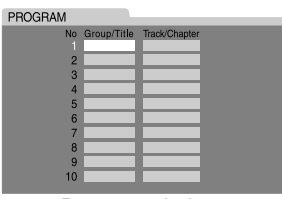
1  

PROGRAM

No	Group/Title	Track/Chapter
1		
2		
3		
4		
5		
6		
7		
8		
9		
10		

Program window



DVD VIDEO	DVD AUDIO	DVD VR
VCD	SVCD	CD
MP3 WMA WAV	JPEG	ASF
MPEG 1	MPEG 2	DivX

2 Select the desired chapters/ tracks.

- For DVD Video, DVD Audio, MP3 and WMA: Enter a title/group number, then a chapter/track number.*
- For VCD, SVCD and CD: Enter a track number.*



To clear the programs

One by one  All programs at once 

3

To check the program contents

To return to normal playback

 Press the button repeatedly until both the program window and **RANDOM** disappear from the TV.

- To program the tracks in the bonus group on a DVD Audio disc, perform the “Playing back a bonus group” procedure (20) before operation.
- You can program up to 99 steps.

* For details on using the number buttons, see “How to use the number buttons” (9).

Playing at random—random play

1  **RANDOM**

2 

DVD VIDEO	DVD AUDIO	DVD VR
VCD	SVCD	CD
MP3 WMA WAV	JPEG	ASF
MPEG 1	MPEG 2	DivX

To return to normal playback













 Press the button repeatedly until both the program window and **RANDOM** disappear from the TV.

- To play the tracks in the bonus group on a DVD Audio disc during random play, perform the “Playing back a bonus group” procedure (20) before operation.

Playing repeatedly—repeat play

 The repeat modes you can select depend on the playback discs/files.

DVD VIDEO	DVD AUDIO	DVD VR
VCD	SVCD	CD
MP3 WMA WAV	JPEG	ASF
MPEG 1	MPEG 2	DivX

On the display	On the TV	Meaning
	 REPEAT GROUP	Repeat current group
	 REPEAT TITLE	Repeat current title
	 REPEAT PROGRAM	Repeat current program
	 REPEAT PLAYLIST	Repeat current playlist
	 REPEAT ALL	Repeat all titles/ programs/tracks/files
	 ,  REPEAT TRACK, REPEAT STEP	Repeat current track
	 ,  REPEAT CHAPTER	Repeat current chapter
No indication	 OFF	Repeat mode is deactivated

- You can repeat the desired part from the on-screen bar (A-B repeat). (21)
- For VCD and SVCD discs, this function is available only when PBC (17) is deactivated.
- * For DVD Video and DVD VR discs, this function is not available while playback is stopped.

Disc/file playback

Advanced operations

Changing the language/sound/scene angle

To do		Disc/file												
<p>Select the subtitle language*¹ *²</p> <p>• To show/hide the subtitle, press SUBTITLE.</p>		<table border="1"> <tr><td>DVD VIDEO</td><td>DVD AUDIO</td><td>DVD VR</td></tr> <tr><td>VCD</td><td>SVCD</td><td>CD</td></tr> <tr><td>MP3 WMA WAV</td><td>JPEG</td><td>ASF</td></tr> <tr><td>MPEG 1</td><td>MPEG 2</td><td>DivX</td></tr> </table>	DVD VIDEO	DVD AUDIO	DVD VR	VCD	SVCD	CD	MP3 WMA WAV	JPEG	ASF	MPEG 1	MPEG 2	DivX
DVD VIDEO	DVD AUDIO	DVD VR												
VCD	SVCD	CD												
MP3 WMA WAV	JPEG	ASF												
MPEG 1	MPEG 2	DivX												
<p>Select the audio language/audio channel*²</p>		<table border="1"> <tr><td>DVD VIDEO</td><td>DVD AUDIO</td><td>DVD VR</td></tr> <tr><td>VCD</td><td>SVCD</td><td>CD</td></tr> <tr><td>MP3 WMA WAV</td><td>JPEG</td><td>ASF</td></tr> <tr><td>MPEG 1</td><td>MPEG 2</td><td>DivX</td></tr> </table>	DVD VIDEO	DVD AUDIO	DVD VR	VCD	SVCD	CD	MP3 WMA WAV	JPEG	ASF	MPEG 1	MPEG 2	DivX
DVD VIDEO	DVD AUDIO	DVD VR												
VCD	SVCD	CD												
MP3 WMA WAV	JPEG	ASF												
MPEG 1	MPEG 2	DivX												
<p>Select the view angle</p>		<table border="1"> <tr><td>DVD VIDEO</td><td>DVD AUDIO</td><td>DVD VR</td></tr> <tr><td>VCD</td><td>SVCD</td><td>CD</td></tr> <tr><td>MP3 WMA WAV</td><td>JPEG</td><td>ASF</td></tr> <tr><td>MPEG 1</td><td>MPEG 2</td><td>DivX</td></tr> </table>	DVD VIDEO	DVD AUDIO	DVD VR	VCD	SVCD	CD	MP3 WMA WAV	JPEG	ASF	MPEG 1	MPEG 2	DivX
DVD VIDEO	DVD AUDIO	DVD VR												
VCD	SVCD	CD												
MP3 WMA WAV	JPEG	ASF												
MPEG 1	MPEG 2	DivX												

For DVD Audio, the functions take effect for the moving picture part only.

¹For DVD VR and SVCD discs, the subtitle indication appears and can be changed by performing the above procedure even if no subtitles are recorded.

²Some subtitle or audio languages are abbreviated in the pop-up window. See "Language code list" (32).

Special picture playback

To do		Disc/file												
<p>Play back frame-by-frame</p>		<table border="1"> <tr><td>DVD VIDEO</td><td>DVD AUDIO</td><td>DVD VR</td></tr> <tr><td>VCD</td><td>SVCD</td><td>CD</td></tr> <tr><td>MP3 WMA WAV</td><td>JPEG</td><td>ASF</td></tr> <tr><td>MPEG 1</td><td>MPEG 2</td><td>DivX</td></tr> </table>	DVD VIDEO	DVD AUDIO	DVD VR	VCD	SVCD	CD	MP3 WMA WAV	JPEG	ASF	MPEG 1	MPEG 2	DivX
DVD VIDEO	DVD AUDIO	DVD VR												
VCD	SVCD	CD												
MP3 WMA WAV	JPEG	ASF												
MPEG 1	MPEG 2	DivX												
<p>Play back in slow-motion*¹</p>		<table border="1"> <tr><td>DVD VIDEO</td><td>DVD AUDIO</td><td>DVD VR</td></tr> <tr><td>VCD</td><td>SVCD</td><td>CD</td></tr> <tr><td>MP3 WMA WAV</td><td>JPEG</td><td>ASF</td></tr> <tr><td>MPEG 1</td><td>MPEG 2</td><td>DivX</td></tr> </table>	DVD VIDEO	DVD AUDIO	DVD VR	VCD	SVCD	CD	MP3 WMA WAV	JPEG	ASF	MPEG 1	MPEG 2	DivX
DVD VIDEO	DVD AUDIO	DVD VR												
VCD	SVCD	CD												
MP3 WMA WAV	JPEG	ASF												
MPEG 1	MPEG 2	DivX												
<p>Enlarge the picture*² *³</p> <p>• Change the scene magnification, then move the zoomed-in area.</p>		<table border="1"> <tr><td>DVD VIDEO</td><td>DVD AUDIO</td><td>DVD VR</td></tr> <tr><td>VCD</td><td>SVCD</td><td>CD</td></tr> <tr><td>MP3 WMA WAV</td><td>JPEG</td><td>ASF</td></tr> <tr><td>MPEG 1</td><td>MPEG 2</td><td>DivX</td></tr> </table>	DVD VIDEO	DVD AUDIO	DVD VR	VCD	SVCD	CD	MP3 WMA WAV	JPEG	ASF	MPEG 1	MPEG 2	DivX
DVD VIDEO	DVD AUDIO	DVD VR												
VCD	SVCD	CD												
MP3 WMA WAV	JPEG	ASF												
MPEG 1	MPEG 2	DivX												

To return to normal playback

- While playing back frame-by-frame or in slow-motion, press ► (play button).
- While zooming in on the picture, select "OFF" by pressing ZOOM repeatedly while holding SHIFT.

For DVD Audio, the functions take effect for the moving picture part only.

¹For DVD Video and DVD Audio, reverse slow-motion is also available by pressing ◀ SLOW repeatedly.

²For JPEG files, you can zoom in only during pause.

³On some files, using cursor (►/◀/▼/▲) cannot move the zoomed-in area during playback.

Adjusting the picture quality (VFP)

You can adjust the picture quality.

1

NORMAL	
GAMMA	0
BRIGHTNESS	0
CONTRAST	0
SATURATION	0
TINT	0
SHARPNESS	0



2 Select the desired preset, then finish the setting.



NORMAL	Normally select this.
CINEMA	Suitable for movies
USER1/ USER2	You can adjust parameters that affect picture appearance. (See below.)

To adjust the picture tone

- Select "USER1" or "USER2" (see above).
- Select a parameter, then confirm the selection.



GAMMA	Controls the brightness of the neutral color
BRIGHTNESS	Controls the brightness of the entire picture
CONTRAST	Controls the contrast
SATURATION	Controls the color depth
TINT	Controls the tint
SHARPNESS	Controls the sharpness

3 Adjust the parameter, then confirm the selection.



4 Repeat steps 2 and 3 to adjust others.

5

When connecting the TV to the HDMI MONITOR OUT terminal (7), the VFP setting has no effect.

Special playback for DVD Audio

Playing back a bonus group

Some DVD Audio discs have a "bonus group." To play back a bonus group, you have to enter the specific "key number" (a password).

The way of getting the key number depends on the disc.

1 Select a bonus group.



The key number entry screen appears.

On the TV

On the display



2 Enter the key number, then confirm the entry.



Enter the number



Confirm

When the key number is accepted, playback starts and the BONUS indicator goes off.

- If playback does not start, enter correct key number again.

To clear the key number entry



Selecting browsable still pictures

While playing back a track linked to browsable still pictures (B.S.P), you can select the still pictures (turn the page).

- If a track is linked to browsable still pictures, they are usually shown automatically during playback.

Select the desired still picture.

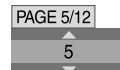

Disc/file playback

Operation from the TV screen

Using the on-screen bar

You can use various functions from the on-screen bar.

Basic operation procedure

1

Ex.: ON SCREEN ON SCREEN

Status bar

Function bar*

2 Select the desired item (see the right column), then confirm the selection.



After confirming the selection...

- When the pull-down menu appears, select the desired item by pressing cursor \blacktriangle / \blacktriangledown repeatedly, then confirm the selection by pressing ENTER.

Ex.: OFF

- When a number-entry box appears, enter the number by using the number buttons (0-9), then confirm the entry by pressing ENTER.

Ex.: TIME : 1 :

To correct a misentry:

- setting: press cursor \blacktriangleleft repeatedly to clear the misentry, then re-enter the number.
- setting: re-enter the number.

- When changing the time information mode (), select the desired item by pressing ENTER repeatedly.

To clear the on-screen bar



- The contents of the on-screen bar differ according to the type of discs/files.

* During playback of ASF, MPEG-1, MPEG-2, or DivX files, the function bar does not appear.

On-screen bar functions

	<p>Selects the time information mode shown on the display and the status bar.</p> <p>TIME*¹: Elapsed time of chapter/track</p> <p>REM*¹: Remaining time of chapter/track</p> <p>TOTAL: Elapsed time of title (DVD Video)/group (DVD Audio)/program (DVD VR)/disc (VCD/CD/SVCD)</p> <p>T.REM: Remaining time of title (DVD Video)/group (DVD Audio)/program (DVD VR)/disc (VCD/CD/SVCD)</p>
	<p>Selects repeat mode.</p> <p> / / / / / / / / :</p> <p>See also "Playing repeatedly—repeat play" (18).</p> <p> : Repeats the desired part (A-B repeat).*² *³ *⁴</p> <p>After selecting this, select the beginning point (A) by pressing ENTER, then the end point (B) by pressing ENTER again.</p>
	Specifies the playback point by the time.
	Specifies a chapter to play back from.
	Specifies a track to play back from.
	Selects the audio language or audio channel during playback.
	Selects the subtitle language during playback.
	Selects the desired scene angle in a multi-angle part during playback.
	Selects the desired browsable still picture.

*¹ Not available for DVD VR discs

*² During playback of DVD Video or DVD VR discs, A-B repeat play is available only within the same title/program.

*³ A-B repeat play is not available during program and random playback.

*⁴ During playback of VCD and SVCD discs, A-B repeat play is available only when PBC (17) is deactivated.

Using the file control display

- The file control display appears in the following cases.
 - Audio files: Always appears.
 - Movie and picture files: When TOP MENU(/PG) or MENU(/PL) is pressed or playback is stopped.

DVD VIDEO	DVD AUDIO	DVD VR
VCD	SVCD	CD
MP3 WMA WAV	JPEG	ASF
MPEG 1	MPEG 2	DivX

File control display

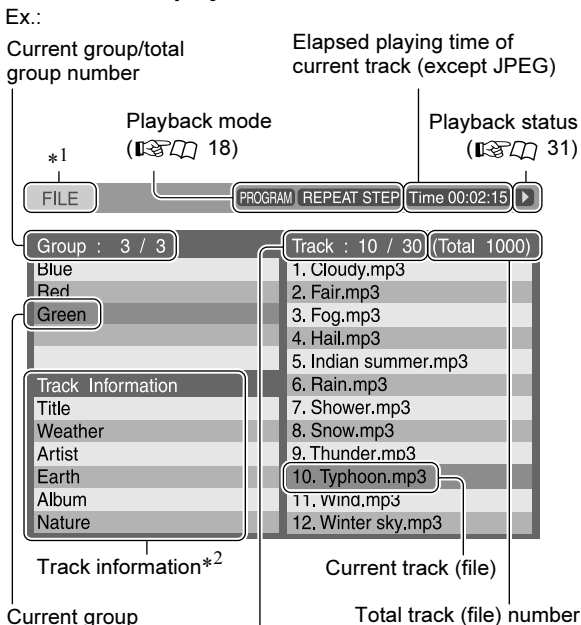

Current track (file)/total track (file) number in current group

To play back the desired track/file

Select a desired group/track/file, then start playback.

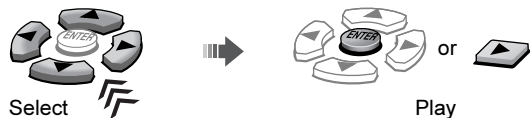

- For JPEG:
 - To start a slide-show from the selected file, press ► (play button).
 - To play the selected file only, press ENTER.

*1 When the source is "DVD," "FILE" appears, and when the source is "USB," "USB" appears.

*2 For MP3/WMA/WAV only.

Using the program list/playlist (for DVD VR)



Program list

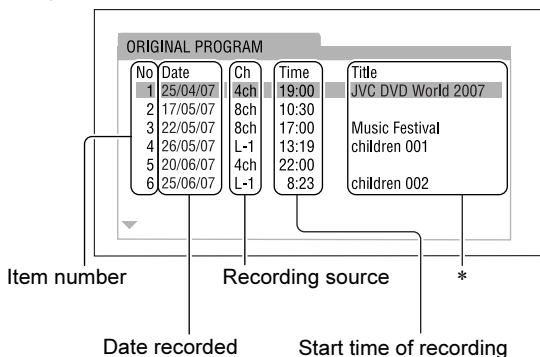

Playlist

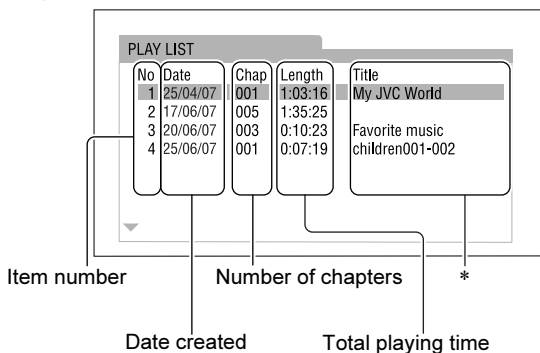

* The title may not be displayed depending on the recording equipment.

To play back the desired item

1 To display the program list

To display the playlist



The System starts playing the first item.

2 Select the desired item.



3



Personal settings

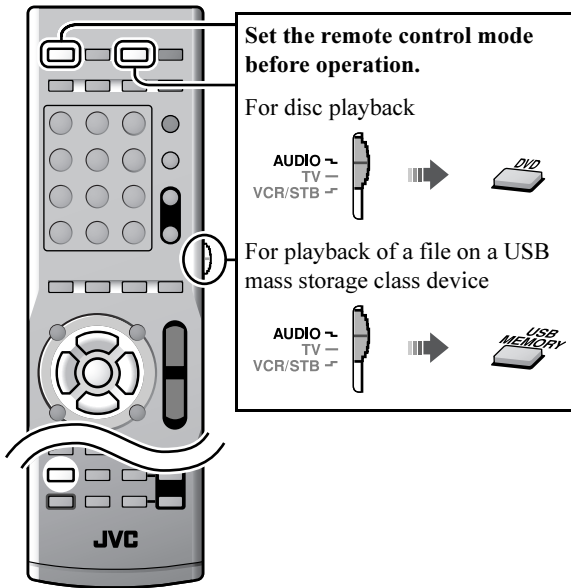

You can change the settings of the System according to your preferences and playing environment.



1 SET UP

2 Select the menu.



3 Select the item, then confirm.



Repeat this procedure until all the options have been confirmed.

To close the setup screen



Language menu (LANGUAGE)

MENU LANGUAGE	Select the language for the DVD/DivX menu.	See "Language code list" (see page 32) for the code of each language, such as "AA," etc.
AUDIO LANGUAGE	Select the language for the audio language.	
SUBTITLE	Select the language for the subtitle language.	
ON SCREEN LANGUAGE	Select the language for the screen.	

Picture menu (PICTURE)

MONITOR TYPE	<p>Select 16:9 wide-screen playback to fit your monitor.</p> <p>For wide TV: 16:9 NORMAL: For fixed 16:9 wide TV 16:9 AUTO: For ordinary wide TV</p> <p>For conventional (4:3) TV: 4:3 LB 4:3 PS</p>
PICTURE SOURCE	<p>Select the source type of the disc/file contents when selecting the progressive scanning mode (see page 12).</p> <p>AUTO: Normally select this. FILM: For a film source movie VIDEO: For a video source movie</p>
SCREEN SAVER	Activate (ON) or deactivate (OFF) the screen saver function.
FILE TYPE	<p>Select the file type to play when several types of files are recorded on a disc/device.</p> <p>AUDIO: For audio files STILL PICTURE: For picture files VIDEO: For movie files</p>
HDMI DVI COLOR	<p>Select the picture appearance for a TV with HDMI connection.</p> <p>STANDARD: No effect applied. ENHANCE: Select when you need automatic picture adjustment.</p>
HDMI OUT	<p>Select the type of video signal output from the HDMI MONITOR OUT terminal.</p> <p>AUTO: Normally select this. RGB: Select this when no picture appears on the TV with "AUTO."</p>

Audio menu (AUDIO)

DOWN MIX	This menu is available only when the speaker position mode is set to "S.SP K F" (11). Select the audio signal output to the TV connected to the HDMI MONITOR OUT terminal. DOLBY SURROUND: For the TV equipped with Dolby Pro Logic decoder STEREO: For ordinary TV
D. RANGE COMPRESSION	You can enjoy powerful audio even at low volume level while playing Dolby Digital software. AUTO: Select this to apply the compression only to the multi-channel software (except 1-channel and 2-channel sources). ON: Select this to always apply the compression.
HDMI AUDIO OUT	This setting is effective only for the source "DVD" or "USB." Select whether the System emits the audio signal from the HDMI MONITOR OUT terminal (ON) or not (OFF).

Other setting menu (OTHERS)

RESUME	Activate (ON) or deactivate (OFF) the resume function.
ON SCREEN GUIDE	Activate (ON) or deactivate (OFF) the on-screen guide icons.
DivX REGISTRATION	The System has its own Registration Code for DivX playback. You can confirm the code of your System. <ul style="list-style-type: none"> Once you play back a DivX file created by using the Registration Code, the System's code is overwritten by a totally different new one for copyright protection purposes.

Speaker setting menu (SPK.SETTING)

SPK.SETTING menu is available only when the speaker position mode is set to "S.SP K R" (11).

LEVEL	Adjust the output level of each speaker while monitoring the test tone. FRONT LEFT/RIGHT SPEAKER, CENTER SPEAKER, SURROUND RIGHT/LEFT SPEAKER: Select the speaker, then adjust the output level. TEST TONE: Turns on/off the test tone.
DELAY	Adjust the delay time of the speakers. FRONT LEFT/RIGHT SPEAKER, CENTER SPEAKER, SURROUND RIGHT/LEFT SPEAKER: Select the speaker, then adjust the distance from the listening position to the speakers. <ul style="list-style-type: none"> 1 ms increase (or decrease) in delay time corresponds to about 30 cm decrease (or increase) in distance. Set to 0 ms for the furthest speaker from your position as the basis for the delay time setting. <div style="display: flex; align-items: center;"> <div style="margin-right: 20px;">Ex.:</div> </div>
SUBWOOFER	Make the subwoofer setting. LEVEL: Adjust the output level of the subwoofer. CROSS OVER: Select an appropriate crossover frequency according to the size of the cone speaker unit built into the small speaker connected. <ul style="list-style-type: none"> 120Hz: Select this when the cone speaker unit size is 8 cm or more. 150Hz: Select this when the cone speaker unit size is between 6 cm and 8 cm. 200Hz: Select this when the cone speaker unit size is 5 cm or less.

Tuner operations

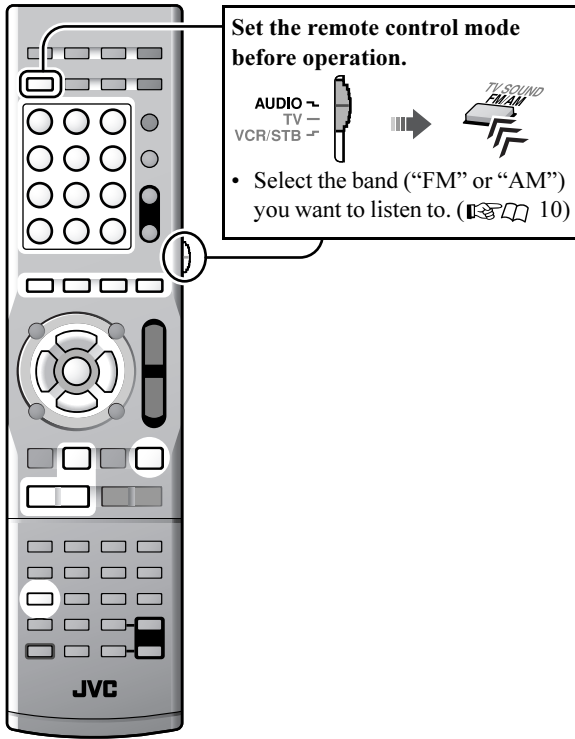

Presetting stations

You can preset 30 FM stations and 15 AM (MW) stations.



Storing stations

- Tune in to the station you want to preset.**
- “__” flashes on the display.** Perform the next step while “__” is flashing.
- Select a preset number, then store the station to that number.**



Enter a preset number*

- “STORED” appears on the display.

Tuning in to a preset station

Select a preset number.*



You can also select a preset number by pressing PRESET UP or PRESET DOWN.

* For details on using the number buttons, see “How to use the number buttons” (9).

Tuning in to a station

Tuning manually

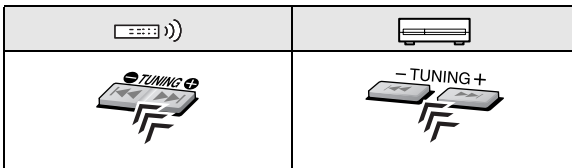

You can also tune in to the station by pressing cursor ▲/▼.

Tuning automatically

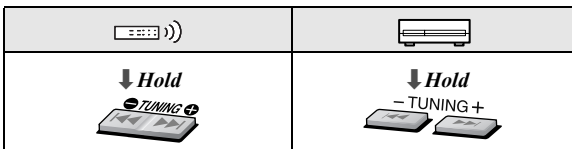

The System tunes in the first-found station of sufficient signal strength.

You can also tune in to the station by pressing and holding cursor ▲/▼.

Selecting the FM reception mode

When the stereo FM program currently tuned in is noisy, you can change the FM reception mode to improve the reception.



AUTO	Normally select this. • When a stereo station is tuned in, the ST indicator lights on the display.
MONO	Select to improve reception. (You will lose the stereo effect.)

Receiving FM stations with Radio Data System

Radio Data System allows FM stations to send an additional signal along with their regular program signals. For example, the stations send their station names, as well as information about what type of program they broadcast, such as sports or music, etc.

With the system, you can receive the following types of Radio Data System signals.

PS (Program Service)	Shows commonly known station names.
PTY (Program Type)	Shows types of broadcast programs.
RT (Radio Text)	Shows text messages the station sends.
Enhanced Other Network	Provides the information about the types of the programs broadcast by the Radio Data System stations of the different networks. (28)

- ❗ Radio Data System is not available for AM (MW) broadcasts.
- ❗ Radio Data System may not operate correctly if the station tuned is not transmitting Radio Data System signal properly or if the signal strength is weak.

Changing the Radio Data System information

While listening to an FM station...



PS → PTY → RT → Frequency (Non-Radio Data System signal) → (back to the beginning)

- While searching, “PS,” “PTY,” or “RT” appears on the display.
- If no Radio Data System signals are sent by a station, “NO PS,” “NO PTY,” or “NO RT” appears on the display.
- ❗ If searching finishes at once, “PS,” “PTY,” or “RT” will not appear on the display.
- ❗ When PS, PTY, or RT signals appear on the display, some special characters and marks may not be displayed correctly.

Searching for a program by PTY codes



One of the advantages of the Radio Data System service is that you can locate a particular kind of program from the preset stations (25) by specifying a PTY code.

While listening to an FM station...

- 1 “PTY” and “SELECT” flash alternately on the display.

- 2 Select a PTY code (27).



- 3 While searching, “SEARCH” and the selected PTY code alternate on the display.

The System searches 30 preset FM stations, stops when it finds the one you have selected, and tunes in to that station.

- If no program is found, “NOT FOUND” appears on the display.
- To continue searching after the first stop, press PTY SEARCH.
- To stop searching during search, press PTY SEARCH.

Tuner operations

Description of the PTY codes

NEWS	News	FINANCE	Stock Market reports, commerce, trading etc.
AFFAIRS	Topical program expanding or enlarging upon the news—debate, or analysis	CHILDREN	Programs targeted at a young audience
INFO	Programs the purpose of which is to impart advice in the widest sense.	SOCIAL	Programs about sociology, history, geography, psychology and society
SPORT	Programs concerned with any aspect of sports	RELIGION	Religious programs
EDUCATE	Educational programs	PHONE IN	Involving members of the public expressing their views either by phone or at a public forum
DRAMA	All radio plays and serials	TRAVEL	Travel information
CULTURE	Programs concerning any aspect of national or regional culture, including language, theater, etc.	LEISURE	Programs about recreational activities
SCIENCE	Programs about natural sciences and technology	JAZZ	Jazz music
VARIED	Used for mainly speech-based programs such as quizzes, panel games and personality interviews.	COUNTRY	Songs which originate from, or continue the musical tradition of the American Southern States
POP M	Commercial music of current popular appeal	NATION M	Current popular music of the nation or region in that country's language
ROCK M	Rock music	OLDIES	Music from the so-called "golden age" of popular music
EASY M	Current contemporary music considered to be "easy-listening"	FOLK M	Music which has its roots in the musical culture of a particular nation
LIGHT M	Instrumental music, and vocal or choral works	DOCUMENT	Programs concerning factual matters, presented in an investigative style
CLASSICS	Performances of major orchestral works, symphonies, chamber music, etc.	TEST	Broadcasts for testing emergency broadcast equipment or unit
OTHER M	Music not fitting into any of the other categories	ALARM	Emergency announcement
WEATHER	Weather reports and forecasts	NONE	No program type, undefined program, or difficult to categorize into particular types

☛ Classification of the PTY codes for some FM stations may be different from the above list.

Switching temporarily to a program of your choice automatically

Another convenient Radio Data System service is called “Enhanced Other Network.”

This allows the system to switch temporarily to a broadcast program of your choice (TA, News, and Info) from a different station.

- The Enhanced Other Network works while listening to an FM station providing the required signals.
- The Enhanced Other Network function is only applicable to preset stations.

Select the program type(s).



Each time you press the button, the corresponding indicator on the display lights.

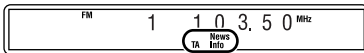

TA	Traffic announcement in your area
News	News
Info	Program the purpose of which is to impart advice in the widest sense.

How the Enhanced Other Network function actually works

Case 1

If there is no station broadcasting the program you have selected

The system continues tuning in to the current station.



When a station starts broadcasting the program you have selected, the system automatically switches to the station. The indicator of received PTY code starts flashing.



When the program is over, the system goes back to the previously tuned station, but the Enhanced Other Network function still remains activated.

Case 2

If the FM station you are listening to is broadcasting the program you have selected

The system continues to receive the station but the indicator of received PTY code starts flashing.



When the program is over, the indicator of received PTY code stops flashing and remains lit, but the Enhanced Other Network function still remains activated.

To stop listening to the program selected by Enhanced Other Network

Press TA/News/Info repeatedly again so that the program type indicator (TA/News/Info) goes off from the display. The system exits from Enhanced Other Network standby mode and goes back to the previously selected station.

When an emergency broadcast (ALARM signal) is sent from an FM station

The system automatically tunes in to the station and “ALARM” is shown on the display while the system receives the emergency broadcast.

Note that an emergency broadcast cannot be received in the following cases:

- When you are listening to non-Radio Data System stations—all AM (MW) stations and some FM stations.
- When you select any source other than “FM.”
- When the system is in standby mode.

The TEST signal is used for equipment test—whether it can receive the ALARM signal correctly

The TEST signal makes the system work in the same way as the ALARM signal does. If the TEST signal is received, the system automatically switches to the station broadcasting the TEST signal.

While receiving the TEST signal, “TEST” appears on the display.

- In Enhanced Other Network standby mode, if you change the source to play, Enhanced Other Network standby mode is canceled temporarily. If you change the source to FM again, the system returns to Enhanced Other Network standby mode.
- Enhanced Other Network data sent from some stations may not be compatible with this system.
- Enhanced Other Network does not function for some FM stations with Radio Data System service.
- While listening to a program tuned in by the Enhanced Other Network function, the station does not change even if another network station starts broadcasting a program of the same Enhanced Other Network data.
- While listening to a program tuned in by the Enhanced Other Network function, you can only use TA/News/Info and DISPLAY as the tuner operation buttons.

Operating external components

Set the remote control mode before operation.

For TV

AUDIO TV VCR/STB

For STB

AUDIO TV VCR/STB

For VCR

AUDIO TV VCR/STB

Preparation
Make the audio/video input setting before operation. (13)

Operating external components

Set the remote control mode before operating each external component (see the left column).

Operating the TV

TV	Turns the power on and off
TV VOL +/-	Adjusts the volume
TV/VIDEO	Selects the input mode (either TV or VIDEO)
CH +/-	Changes the channels
1-10, 0, ≥ 10 (100+)	Selects the channels
TV RETURN	Alternates between the previously selected channel and the current channel

Operating the STB

VCR/STB	Turns the power on and off
CH +/-	Changes the channels
1-10, 0, ≥ 10 (100+)	Selects the channels
RETURN	Alternates between the previously selected channel and the current channel

Operating the VCR

VCR/STB	Turns the power on and off
(play button)	Starts playback
	Stops playback
	Pauses
	Fast-forwards the tape
	Rewinds the tape
REC	Press this button together with (play button) to start recording or together with to enter recording-pause.
CH +/-	Changes the TV channels
0 - 9	Selects the TV channels

Setting the manufacturer's code

Before operating external components from the remote control, set the manufacturer's code.

- 1 Set the remote control mode (see above).
- 2 Press and hold for the target component until the setting is finished.

For TV	For STB	For VCR
Hold	Hold	



- 4 Enter the manufacturer's code.

See "Manufacturer's code list" for the manufacturer's code. (30)



- 5 Release .

- ✔ If there is more than one code listed for the corresponding brand, try each one until you enter the correct one.
- ✔ Set the codes after replacing batteries of the remote control.

References

Manufacturer's code list

TV

JVC	01*	Magnavox	10	Samsung	10, 19, 32, 35, 36, 37, 38
Akai	02, 05	Mitsubishi	11, 33	Sanyo	05
Blaupunkt	03	Miver	03	Schneider	02, 05
Daewoo	10, 31, 32	Nokia	12, 34	Sharp	20, 39, 40
Fenner	04, 31, 32	Nordmende	13, 14, 18, 26, 27, 28	Sony	21, 22, 23, 24, 25
Fisher	05	Okano	09	Telefunken	13, 14, 18, 26, 27, 28
Grundig	06	Orion	15	Thomson	13, 14, 18, 26, 27, 28
Hitachi	07, 08	Panasonic	16, 17	Toshiba	29
Inno-Hit	09	Philips	10		
Irradio	02, 05	Saba	13, 14, 18, 26, 27, 28		

STB

Echostar	21	Jerrold	01, 02, 03, 04, 05, 06, 07, 08	Scientific Atlanta	09, 10
G.I.	01*, 02, 03, 04, 05, 06, 07, 08	Pioneer	13, 14	Sony	20
Hamlin	15, 16, 17, 18	RCA	19	Zenith	11, 12

VCR

JVC	01*	Hitachi	08, 09	Saba	17, 18, 19, 23, 31
Aiwa	02, 20	Loewe	05, 10, 11	Samsung	24, 25
Bell+Howell	03, 16	Magnavox	04, 05	Sanyo	03, 16
Blaupunkt	04	Mitsubishi	12, 13, 14, 15	Sharp	26, 27
CGM	03, 05, 16	Nokia	16	Siemens	07
Daewoo	34	Nordmende	17, 18, 19, 31	Sony	28, 29, 30, 35
DIGITAL	05	Orion	20	Telefunken	17, 18, 19, 31, 32
Fisher	03, 16	Panasonic	21	Toshiba	33
G.E	06	Philips	05, 22		
Grundig	07	Phonola	05		

* Initial setting

⚠ Manufacturers' codes are subject to change without notice.

References

Messages and icons shown on the TV

CANNOT PLAY THIS DEVICE	An unplayable USB mass storage class device is connected.
CANNOT PLAY THIS DISC	An unplayable disc is loaded.
NO DISC	No disc or an unfinalized disc is loaded.
NO USB DEVICE	No USB mass storage class device is loaded.
NOT SUPPORT	The file cannot be played back.
NOW READING	Reading the disc/file information
OPEN/CLOSE	Opening or closing the disc tray
READING INDEX...	Reading the DivX file
REGION CODE ERROR!	The Region Code of the DVD Video disc does not match the code the System supports. (3)
RESTRICTED DEVICE	iPod is connected to the USB MEMORY terminal.

	The operation is unacceptable.
	Playback
	Pause
	Fast-forward/fast-reverse
	Forward/reverse slow-motion playback
	The scene contains multi-audio languages.
	The scene contains multi-subtitle languages.
	The scene contains multi-angle views.

You can change the setting so that the on-screen guide icons do not appear on the TV. (24)

Available surround modes

Surround mode for "S.SP K F"	
AUTO SUR (Auto Surround)	Selects an appropriate surround mode according to the incoming signals
MOVIE	For movie or multi-channel music sources
WIDE/2CH	For 2-channel music sources
SUPER W (Super Wide)	Reproduces broader sound field
OFF (Off)	Deactivates surround mode
Surround mode for "S.SP K R"	
AUTO SUR (Auto Surround)	Selects an appropriate surround mode according to the incoming signals
MOVIE (Dolby Pro Logic II Movie)	For movie sources
MUSIC (Dolby Pro Logic II Music)	For music sources
STADIUM	Adds clarity and spreads the sound as if in an outdoor stadium
ALL ST (All Channel Stereo)	Reproduces a larger stereo sound field using all the activated speakers
OFF (Off)	Deactivates surround mode

Language code list

AA	Afar	GD	Scots Gaelic	MI	Maori	SN	Shona
AB	Abkhazian	GL	Galician	MK	Macedonian	SO	Somali
AF	Afrikaans	GN	Guarani	ML	Malayalam	SQ	Albanian
AM	Ameharic	GU	Gujarati	MN	Mongolian	SR	Serbian
AR	Arabic	HA	Hausa	MO	Moldavian	SS	Siswati
AS	Assamese	HI	Hindi	MR	Marathi	ST	Sesotho
AY	Aymara	HR	Croatian	MS	Malay (MAY)	SU	Sundanese
AZ	Azerbaijani	HY	Armenian	MT	Maltese	SV	Swedish
BA	Bashkir	IA	Interlingua	MY	Burmese	SW	Swahili
BE	Byelorussian	IE	Interlingue	NA	Nauru	TA	Tamil
BG	Bulgarian	IK	Inupiak	NE	Nepali	TE	Telugu
BH	Bihari	IN	Indonesian	NL	Dutch	TG	Tajik
BI	Bislama	IS	Icelandic	NO	Norwegian	TH	Thai
BN	Bengali, Bangla	IW	Hebrew	OC	Occitan	TI	Tigrinya
BO	Tibetan	JI	Yiddish	OM	(Afan) Oromo	TK	Turkmen
BR	Breton	JW	Javanese	OR	Oriya	TL	Tagalog
CA	Catalan	KA	Georgian	PA	Panjabi	TN	Setswana
CO	Corsican	KK	Kazakh	PS	Pashto, Pushto	TO	Tonga
CY	Welsh	KL	Greenlandic	PT	Portuguese	TR	Turkish
DA	Danish	KM	Cambodian	QU	Quechua	TS	Tsonga
DZ	Bhutani	KN	Kannada	RM	Rhaeto-Romance	TT	Tatar
EL	Greek	KO	Korean (KOR)	RN	Kirundi	TW	Twi
EO	Esperanto	KS	Kashmiri	RO	Rumanian	UK	Ukrainian
ET	Estonian	KU	Kurdish	RW	Kinyarwanda	UR	Urdu
EU	Basque	KY	Kirghiz	SA	Sanskrit	UZ	Uzbek
FA	Persian	LA	Latin	SD	Sindhi	VI	Vietnamese
FI	Finnish	LN	Lingala	SG	Sangho	VO	Volapuk
FJ	Fiji	LO	Laothian	SH	Serbo-Croatian	WO	Wolof
FO	Faroese	LT	Lithuanian	SI	Singhalese	XH	Xhosa
FY	Frisian	LV	Latvian, Lettish	SL	Slovenian	YO	Yoruba
GA	Irish	MG	Malagasy	SM	Samoan	ZU	Zulu

Troubleshooting

Power does not come on.

- ➔ The power plug is not inserted securely. Plug it in securely.

Unable to operate the System from the remote control.

- ➔ The path between the remote control and the remote sensor on the center unit is blocked.
- ➔ The batteries are exhausted.

No sound is heard.

- ➔ The speaker connections or audio cord connections are incorrect or loose. (📖 6, 8)
- ➔ Headphones are connected.

The sound is distorted.

- ➔ The speaker layout (📖 5) does not match the speaker position mode (📖 11).

No picture appears on the TV.

- ➔ The video cord connections are incorrect or loose. (📖 7, 8)

The picture does not fit the TV.

- ➔ The monitor type is not set correctly. (📖 23)

No picture is displayed on the TV, the picture is blurred, or the picture is divided into two parts.

- ➔ The scanning mode is set to the progressive mode even though the TV connected to the System does not support progressive video input. (📖 12)
- ➔ Inappropriate scanning mode is selected. (📖 12)

No picture is displayed on the TV or no sound comes out through the HDMI connection.

- ➔ The connected TV is not HDCP-compatible. ("HDCP ERR" appears on the display.)
- ➔ Disconnect the HDMI cable and connect it again, or use a shorter cable.

Video and audio are distorted.

- ➔ The disc is scratched or dirty.
- ➔ Audio/video files have not been properly copied on to the USB mass storage class device.
- ➔ A VCR is connected between the center unit and the TV. Connect the center unit and TV directly. (📖 7, 8)

VCD/SVCD operation cannot be performed.

- ➔ Some functions do not work for VCDs/SVCDs when the PBC function is used.

No sound is heard or no picture appears while playing the external components, or the video and audio do not match.

- ➔ The selected audio or video input is not appropriate. Select the audio/video input to match the component connected. (📖 13)

The iPod does not play even though "CONNECT" appears on the display.

- ➔ The battery of the iPod is exhausted. Leave the iPod connected for at least 10 minutes.

The iPod cannot be operated from the System.

- ➔ The iPod battery charge function is deactivated. (📖 14)
- ➔ The iPod is not compatible with the System. Check the compatibility. (📖 3)

iPod is not charged.

- ➔ The source is not "iPod."
- ➔ The iPod battery charge function is deactivated. (📖 14)

The broadcast is hard to hear because of noise.

- ➔ Antenna connections are incorrect or loose. (📖 7)
- ➔ The AM (MW) loop antenna is too close to the System.
- ➔ The FM Antenna is not properly extended and positioned. (📖 7)

Attaching the dock adapter to the docking connection

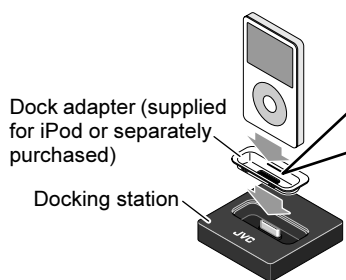

To detach the dock adapter from the docking station:

Push the slot then pull up to remove the dock adapter.



- ⚠️ Disconnect the docking station from the center unit when attaching/detaching the dock adapter.
- ⚠️ Take care not to damage the terminal on the docking station when attaching/detaching the dock adapter.

Specifications

Center unit (XV-THD51)

Output power

Front:

140 W per channel, RMS at 4 Ω at 1 kHz, with 10% total harmonic distortion.

Center:

130 W, RMS at 4 Ω at 1 kHz, with 10% total harmonic distortion.

Surround:

130 W per channel, RMS at 4 Ω at 1 kHz, with 10% total harmonic distortion.

Subwoofer:

140 W, RMS at 4 Ω at 100 Hz, with 10% total harmonic distortion.

Audio section

Digital Input*

DIGITAL IN

OPTICAL: -21 dBm to -15 dBm (660 nm \pm 30 nm)

Analog Input:

AUDIO IN

Video section

Video System:

PAL

Horizontal Resolution:

500 lines

Signal-to-Noise Ratio:

54 dB

(Composite signal when "RGB" is selected)

Video Output Level

(AV—Scart)

Composite video: 1.0 V(p-p)/75 Ω

Y: 1.0 V(p-p)/75 Ω

C: 0.3 V(p-p)/75 Ω

RGB: 0.7 V(p-p)/75 Ω

(VIDEO OUT)

Component (Y): 1.0 V(p-p)/75 Ω

(PB/PR): 0.7 V(p-p)/75 Ω

Video Input Sensitivity/Impedance (VIDEO IN)

Composite: 1.0 V(p-p)/75 Ω

S-video (Y): 1.0 V(p-p)/75 Ω

(C): 0.3 V(p-p)/75 Ω

HDMI

HDMI Output (MONITOR OUT):

576p/720p/1080i

USB storage

USB Specification:

Compatible with USB 2.0 Full Speed

Compatible Device:

Mass Storage Class

Compatible File System:

FAT16, FAT32

Bus Power Supply:

Max. 500 mA

Tuner section

Tuner Range

FM:

87.50 MHz to 108.00 MHz

AM (MW):

522 kHz to 1 629 kHz

General

Power Requirements:

AC 230 V \sim , 50 Hz

Power Consumption:

160 W (during operation)

1.0 W (in standby mode)

Dimensions (W \times H \times D):

435 mm \times 115 mm \times 270 mm

Mass:

6.8 kg

* Corresponding to Linear PCM, Dolby Digital, and DTS (with sampling frequency — 32 kHz, 44.1 kHz, 48 kHz)

Subwoofer (SP-THD51W)

Type:

Bass-Reflex Type

Speaker:

16 cm cone \times 1

Power Handling Capacity: 140 W

Impedance: 4 Ω

Frequency Range:

30 Hz to 200 Hz

Sound Pressure Level:

72 dB/W-m

Dimensions (W \times H \times D):

214 mm \times 296 mm \times 329 mm

Mass:

4.9 kg

References

■ Front speakers (SP-THD51F)

Type:

1-Way 2-Speaker Bass-Reflex Type (Magnetically Shielded Type)

Speaker: 5.5 cm cone × 2
 Power Handling Capacity: 140 W
 Impedance: 4 Ω
 Frequency Range: 100 Hz to 20 000 Hz
 Sound Pressure Level: 80 dB/W·m
 Dimensions (W × H × D):
 Without the stand: 180 mm × 73 mm × 91 mm
 With the stand: 180 mm × 119 mm × 91 mm
 Mass: 0.93 kg each (with the stand)

■ Center surround speaker (SP-THD51C)

Type:

Center:
 1-Way 2-Speaker Bass-Reflex Type (Magnetically Shielded Type)

Surround Left:
 1-Way 2-Speaker Bass-Reflex Type (Magnetically Shielded Type)

Surround Right:
 1-Way 2-Speaker Bass-Reflex Type (Magnetically Shielded Type)

Speaker:
 Center: 5.5 cm cone × 2
 Surround Left: 5.5 cm cone × 2
 Surround Right: 5.5 cm cone × 2
 Power Handling Capacity:
 Center: 140 W
 Surround Left: 140 W
 Surround Right: 140 W
 Impedance:
 Center: 4 Ω
 Surround Left: 4 Ω
 Surround Right: 4 Ω
 Frequency Range:
 Center: 100 Hz to 20 000 Hz
 Surround Left: 100 Hz to 20 000 Hz
 Surround Right: 100 Hz to 20 000 Hz
 Sound Pressure Level:
 Center: 80 dB/W·m
 Surround Left: 80 dB/W·m
 Surround Right: 80 dB/W·m
 Dimensions (W × H × D): 435 mm × 74 mm × 91 mm
 Mass: 2.1 kg

Dimensions of the wall-mount attachment for the front and center surround speakers:

SP-THD51F

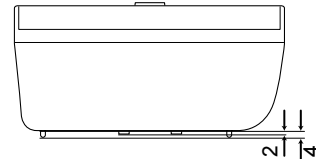
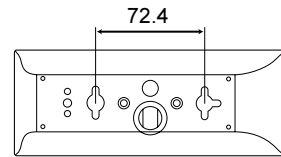

SP-THD51C

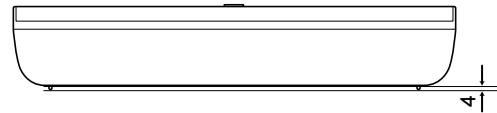
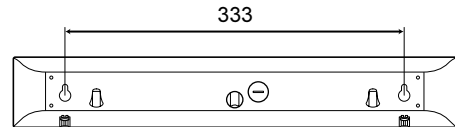

Unit: mm

Designs and specifications are subject to change without notice.

- This product incorporates copyright protection technology that is protected by U.S. patents and other intellectual property rights. Use of this copyright protection technology must be authorized by Macrovision, and is intended for home and other limited viewing uses only unless otherwise authorized by Macrovision. Reverse engineering or disassembly is prohibited.
- “CONSUMERS SHOULD NOTE THAT NOT ALL HIGH DEFINITION TELEVISION SETS ARE FULLY COMPATIBLE WITH THIS PRODUCT AND MAY CAUSE ARTIFACTS TO BE DISPLAYED IN THE PICTURE. IN CASE OF 525 OR 625 PROGRESSIVE SCAN PICTURE PROBLEMS, IT IS RECOMMENDED THAT THE USER SWITCH THE CONNECTION TO THE ‘STANDARD DEFINITION’ OUTPUT. IF THERE ARE QUESTIONS REGARDING OUR TV SET COMPATIBILITY WITH THIS MODEL 525p AND 625p DVD PLAYER, PLEASE CONTACT OUR CUSTOMER SERVICE CENTER.”
- USE OF THIS PRODUCT IN ANY MANNER THAT COMPLIES WITH THE MPEG-4 VISUAL STANDARD IS PROHIBITED, EXCEPT FOR USE BY A CONSUMER ENGAGING IN PERSONAL AND NON-COMMERCIAL ACTIVITIES.
- DivX, DivX Ultra Certified, and associated logos are trademarks of DivX, Inc. and are used under license.
- Official DivX® Ultra Certified product
- Plays all versions of DivX® video (including DivX® 6) with enhanced playback of DivX® media files and the DivX® Media Format
- Microsoft and Windows Media are either registered trademarks or trademarks of Microsoft Corporation in the United States and/or other countries.
- DVD Logo is a trademark of DVD Format/Logo Licensing Corporation.
- Manufactured under license from Dolby Laboratories. “Dolby”, “Pro Logic”, “MLP Lossless”, and the double-D symbol are trademarks of Dolby Laboratories.
- “DTS” and “DTS Digital Surround” are registered trademarks of DTS, Inc.
- HDMI, the HDMI logo and High-Definition Multimedia Interface are trademarks or registered trademarks of HDMI Licensing LLC.
- HDCP is the abbreviation of “High-bandwidth Digital Content Protection,” and is the high-reliable copy control technology licensed by Digital Content Protection, LLC.

SAFETY INSTRUCTIONS

“SOME DOS AND DON'TS ON THE SAFE USE OF EQUIPMENT”

This equipment has been designed and manufactured to meet international safety standards but, like any electrical equipment, care must be taken if you are to obtain the best results and safety is to be assured.

Do read the operating instructions before you attempt to use the equipment.

Do ensure that all electrical connections (including the mains plug, extension leads and interconnections between pieces of equipment) are properly made and in accordance with the manufacturer's instructions. Switch off and withdraw the mains plug when making or changing connections.

Do consult your dealer if you are ever in doubt about the installation, operation or safety of your equipment.

Do be careful with glass panels or doors on equipment.

DON'T continue to operate the equipment if you are in any doubt about it working normally, or if it is damaged in any way—switch off, withdraw the mains plug and consult your dealer.

DON'T remove any fixed cover as this may expose dangerous voltages.

DON'T leave equipment switched on when it is unattended unless it is specifically stated that it is designed for unattended operation or has a standby mode.

Switch off using the switch on the equipment and make sure that your family know how to do this.

Special arrangements may need to be made for infirm or handicapped people.

DON'T use equipment such as personal stereos or radios so that you are distracted from the requirements of traffic safety. It is illegal to watch television whilst driving.

DON'T listen to headphones at high volume as such use can permanently damage your hearing.

DON'T obstruct the ventilation of the equipment, for example with curtains or soft furnishings. Overheating will cause damage and shorten the life of the equipment.

DON'T use makeshift stands and NEVER fix legs with wood screws—to ensure complete safety always fit the manufacturer's approved stand or legs with the fixings provided according to the instructions.

DON'T allow electrical equipment to be exposed to rain or moisture.

ABOVE ALL

- NEVER let anyone, especially children, push anything into holes, slots or any other opening in the case
—this could result in a fatal electrical shock.;
- NEVER guess or take chances with electrical equipment of any kind—it is better to be safe than sorry!

E43486-340B

JVC

Free Manuals Download Website

<http://myh66.com>

<http://usermanuals.us>

<http://www.somanuals.com>

<http://www.4manuals.cc>

<http://www.manual-lib.com>

<http://www.404manual.com>

<http://www.luxmanual.com>

<http://aubethermostatmanual.com>

Golf course search by state

<http://golfingnear.com>

Email search by domain

<http://emailbydomain.com>

Auto manuals search

<http://auto.somanuals.com>

TV manuals search

<http://tv.somanuals.com>