

JVC



DVD DIGITAL THEATER SYSTEM

TH-C7

Consists of XV-THC7, SP-PWC7, SP-THC7F, SP-THC7C and SP-THC5S

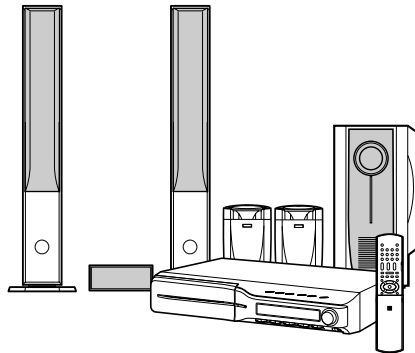

TH-C6

Consists of XV-THC6, SP-PWC6, SP-THC6F, SP-THC6C and SP-THC6S

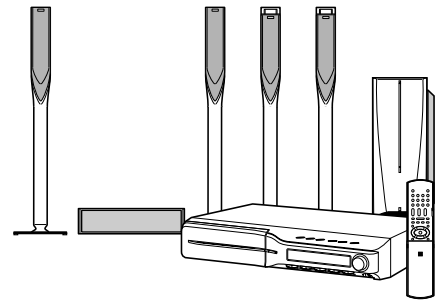

TH-C5

Consists of XV-THC5, SP-PWC5, SP-THC5F, SP-THC5C and SP-THC5S

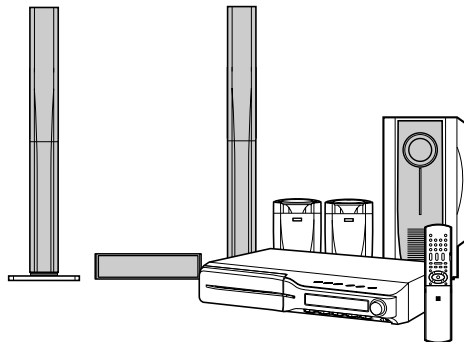

TH-C4/TH-C3

Consists of XV-THC4, SP-PWC4, SP-THC4F, SP-THC4C and SP-THC4S
Consists of XV-THC3, SP-PWC3, SP-THC3F, SP-THC3C and SP-THC3S

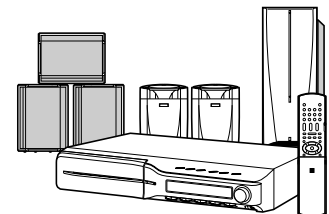

**Digital Direct Progressive Scan
AV COMPU LINK**

INSTRUCTIONS

For Customer Use:

Enter below the Model No. and Serial No. which are located either on the rear, bottom or side of the cabinet. Retain this information for future reference.

Model No. _____

Serial No. _____

GVT0150-001C
[J/C]

précautions et

tested and found to comply with the
device, pursuant to part 15 of the FCC
designed to provide reasonable
interference in a residential

, uses and can radiate radio frequency
and used in accordance with the
harmful interference to radio

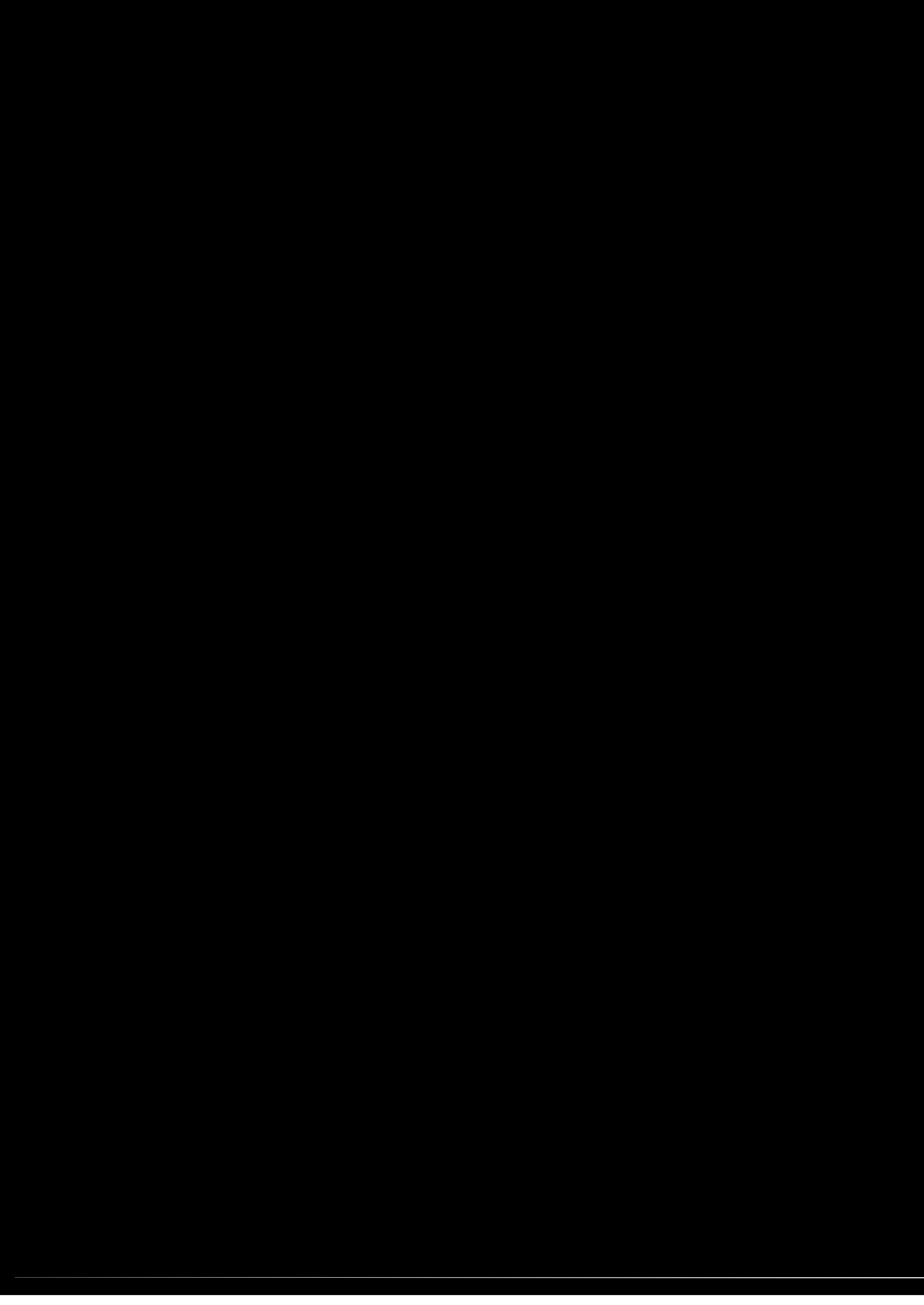

Table of contents

Introduction 2

Notes on handling2

Supplied accessories2

About discs 3

Playable disc types3

Notes on file types3

Description of parts and controls ... 4

Connections 7

Connecting the FM and AM antennas7

Connecting the satellite (front, center, surround) speakers 8

Speaker layout12

Connecting a TV12

Connecting the powered subwoofer13

Connecting to an analog component13

Connecting to a digital component13

Connecting the power cord13

Operating external components with the remote control 14

Operating the TV14

Operating the DBS tuner or CATV converter14

Operating the VCR15

Basic operations 16

Turning the system on/off16

Selecting the source to play17

Adjusting the volume [VOLUME]17

Listening with headphones (not supplied)17

Turning off the sound temporarily [MUTING]17

Adjusting the brightness of the indications [DIMMER]17

Sleep Timer [SLEEP]18

Adjusting the output level of the subwoofer and speakers ..18

Adjusting the treble sound [TREBLE]18

Adjusting the bass sound [BASS]18

Changing the scan mode18

Optimizing the speaker settings [Smart Surround Setup] ...19

Playback 20

Basic playback20

One Touch Replay22

Fast-forward/fast-reverse search22

Skip to the beginning of a desired selection22

Locating a desired title/group using number buttons23

Playing back a bonus group23

Selecting the desired title/playlist from the control display .23

Advanced operations 24

Using the surround mode24

Using the on-screen bar25

Playing from a specified position on a disc27

Using the file control display28

Resume Playback29

Selecting a view angle29

Selecting the subtitle29

Selecting the audio30

Special picture playback30

Program Playback32

Random Playback33

Repeat Playback33

Tray lock34

Sound and other settings35

Setting DVD preferences 36

Using the setup menus36

Menu description36

Tuner operations 39

Manual tuning39

Preset tuning40

Selecting the FM reception mode40

Reducing the noise of AM broadcast40

AV COMPU LINK remote control system 41

References 42

Maintenance42

Troubleshooting42

Specifications43

Notes on handling

■ Important cautions

- Select a place which is level, dry and neither too hot nor too cold; between 5°C and 35°C.
- Leave sufficient distance between the system and the TV.
- Do not use the system in a place subject to vibration.
- Do not handle the power cord with wet hands!
- A small amount of power is always consumed while the power cord is connected to the wall outlet (center unit only).
- When unplugging the power cord from the wall outlet, always pull on the plug, not the power cord.
- There are no user-serviceable parts inside. If anything goes wrong, unplug the power cord and consult your dealer.
- Do not insert any metallic object into the system.
- Do not use any non-standard shape disc (like a heart, flower or credit card, etc.) available on the market, because it may damage the system.
- Do not use a disc with tape, stickers, or paste on it, because it may damage the system.

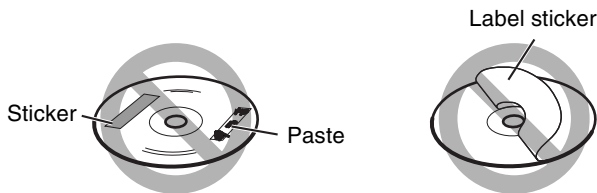

Check the copyright laws in your country before recording from the discs. Recording of copyrighted material may infringe copyright laws.

The discs are protected by copyguard system. When you connect the system to your VCR directly, the copyguard system activates and the picture may not be played back correctly.

■ Safety precautions

- Do not place the system in moist or dusty places.
- Do not expose the system to direct sunlight and do not place it near a heating device.
- When away on travel or for other reasons for an extended period of time, disconnect the power cord plugs from the wall outlet.
- Blocking the vents may damage the system.
- When cleaning the system, use a soft cloth and follow the relevant instructions on the use of chemically-coated cloths. Do not use benzene, thinner or other organic solvents including disinfectants. These may cause deformation or discoloring.
- Turn the system off and disconnect the power cord plug from the wall outlet, then call the store where you made your purchase. Using the system in this condition may cause fire or electrical shock.

Supplied accessories

Check to be sure you have all of the supplied accessories. The number in parentheses is the quantity of the pieces supplied. If anything is missing, contact your dealer immediately.

- Remote control (1)
- Batteries (2)
- FM antenna (1)
- AM loop antenna (1)
- Power cord (1)
- System cord (1)
- Composite video cord (1)
- Speaker cords (except for TH-C3)
 - For satellite (front left/right) and center speakers (3)
 - For satellite speakers (surround left/right) (2)
- Screws
 - TH-C7 (for satellite speakers):
 - M4 x 35 mm (8)
 - TH-C6 (for satellite speakers):
 - M5 x 25 mm (4)
 - M4 x 55 mm (12)
 - TH-C5 (for satellite speakers):
 - M4 x 40 mm (6)
- Bottom covers (for TH-C6 only)
 - For satellite speakers (front and surround) (4)

Description of parts and controls

Front panel (center unit)

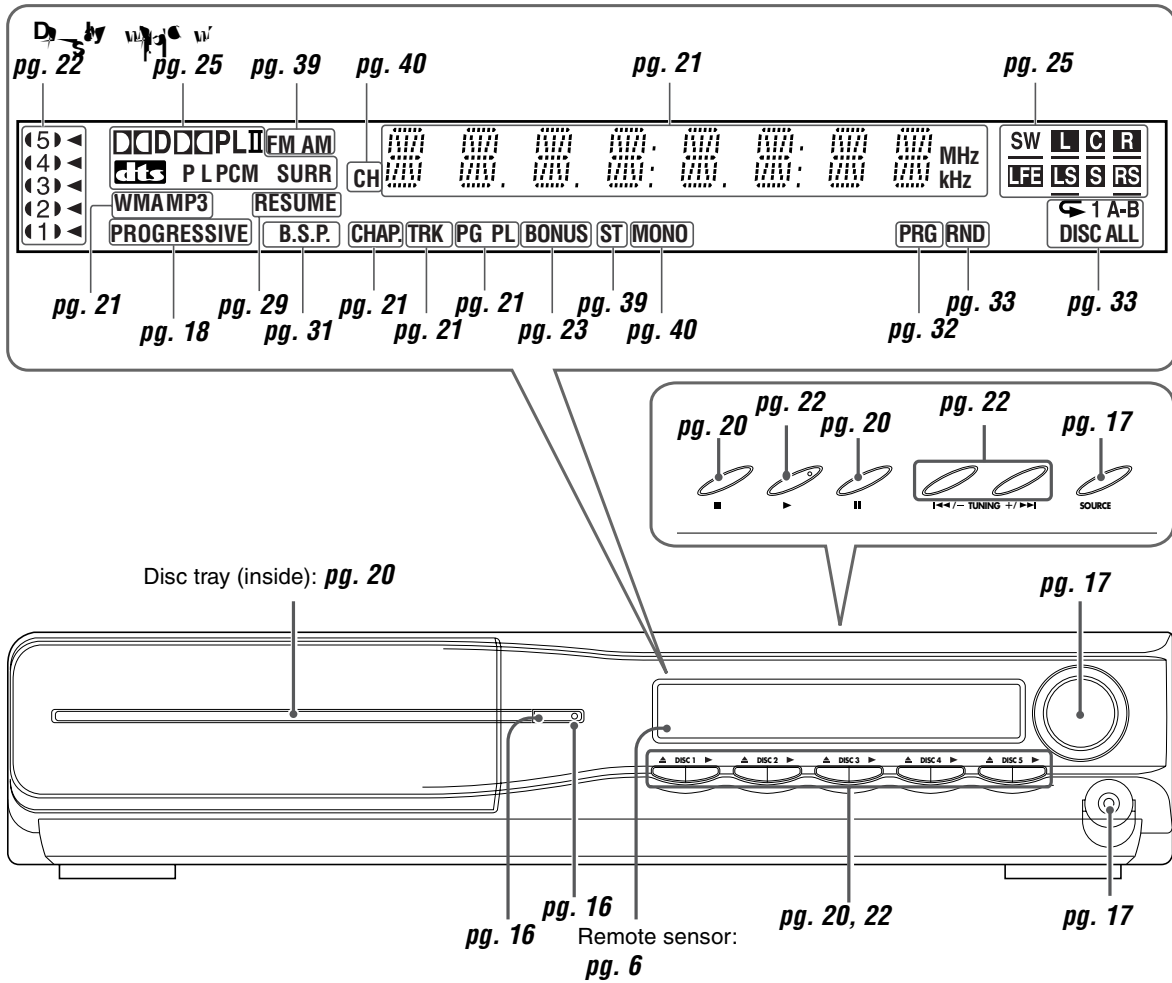

Rear panel (center unit)

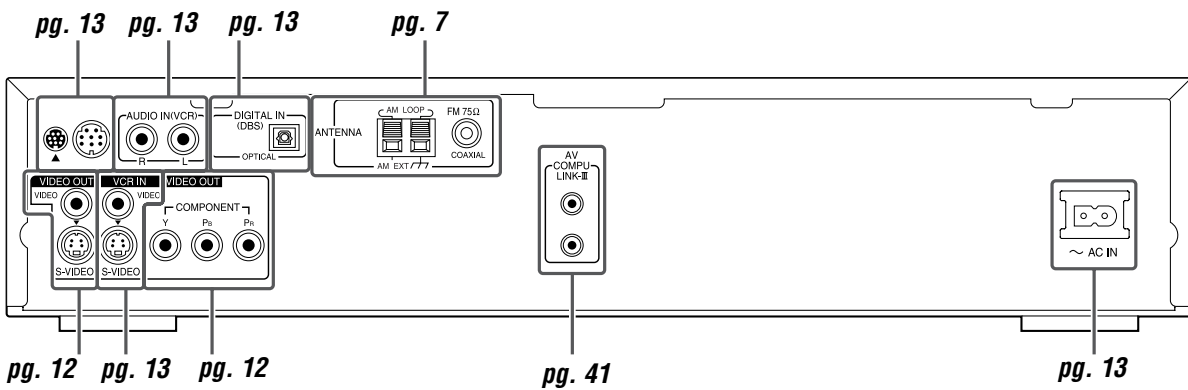

Powered subwoofer

SP-P C7/SP-P C5

Note that the illustration below is for SP-PWC5.

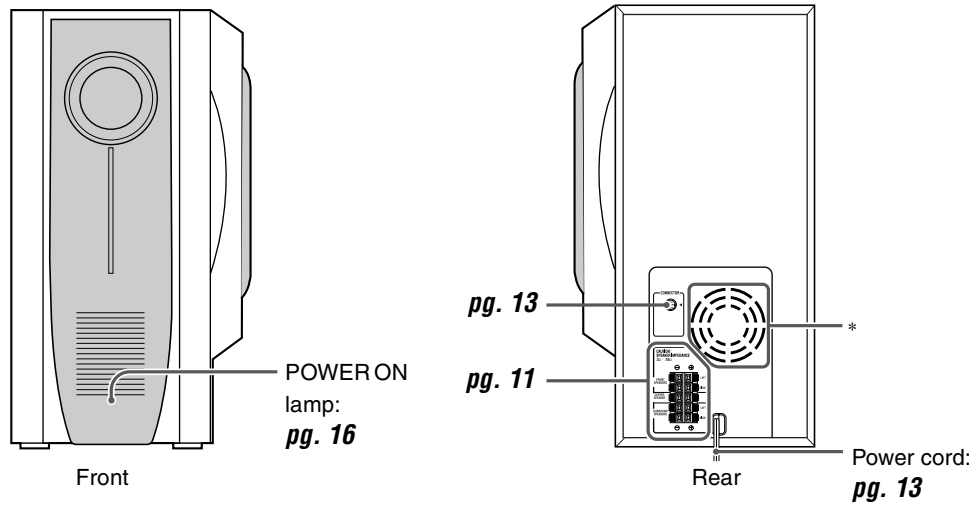

SP-P C6/SP-P C4/SP-P C3

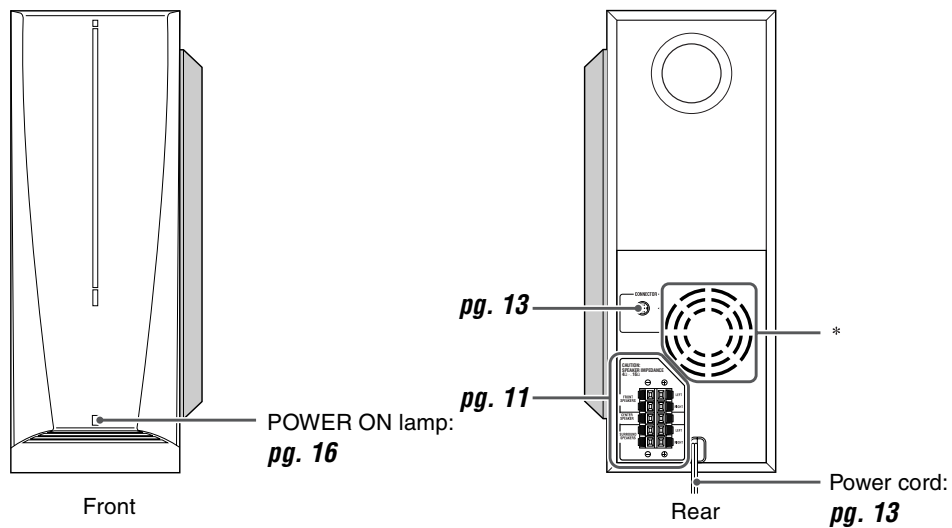

NOTE

- For safety reasons, always ensure that there is sufficient space behind the powered subwoofer.

* Do not block the ventilation openings.

Remote control

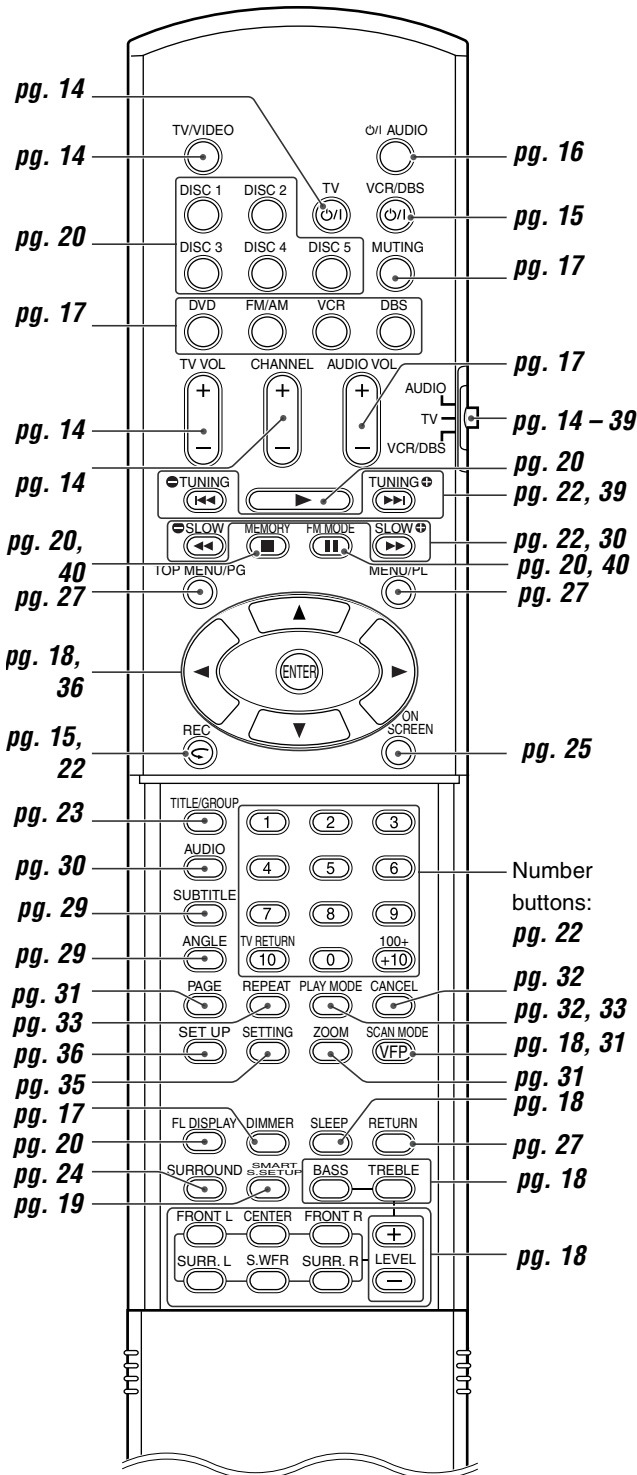

Putting batteries in the remote control

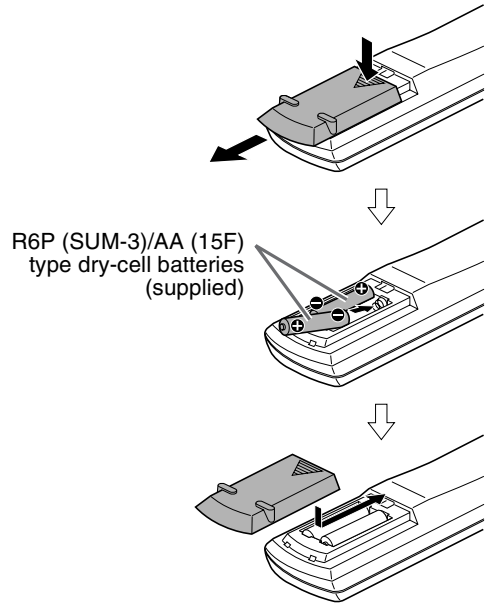

If the range or effectiveness of the remote control decreases, replace both batteries.

CAUTION

- Do not expose batteries to heat or flame.

Operating the system from the remote control

Aim the remote control directly to the front panel of the center unit.

- Do not hide the remote sensor.

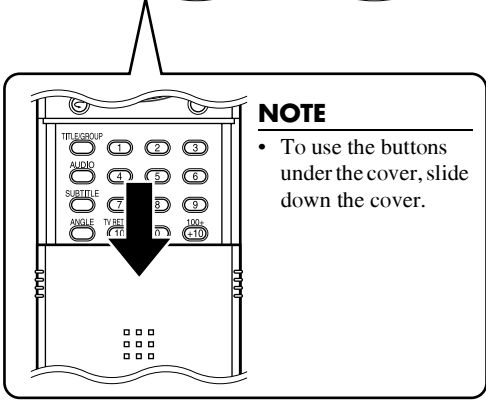

NOTE

- To use the buttons under the cover, slide down the cover.

Connecting the FM and AM antennas

■ AM loop antenna

Setting up supplied AM loop antenna

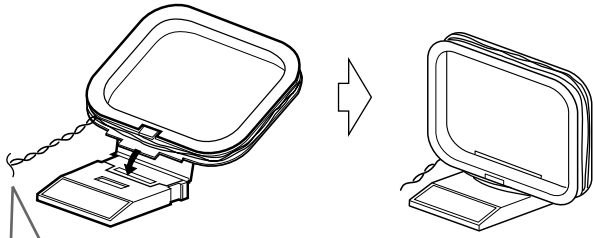

If the antenna cord is covered with the insulation coat, twist and pull the insulation coat off and remove.

Connecting AM loop antenna

1

Center unit

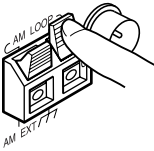

2

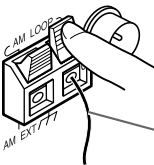

Antenna cord

3

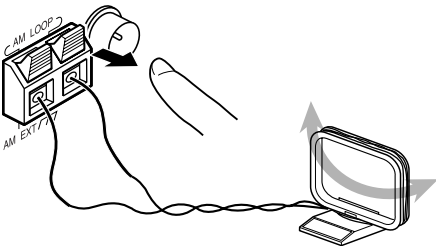

- Turn the loop antenna until you have the best reception during AM broadcast program reception.

NOTE

- Make sure the antenna conductors do not touch any other terminals, connecting cords and power cords. This could cause poor reception.

If reception is poor

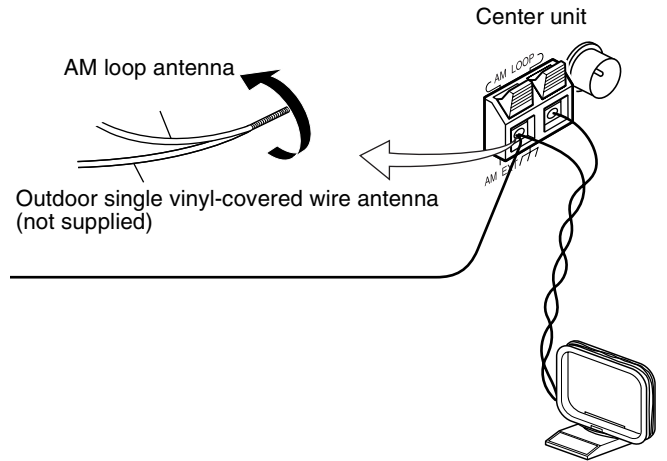

■ FM antenna

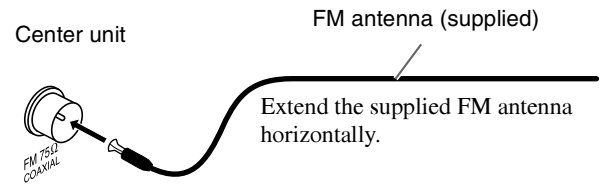

If reception is poor

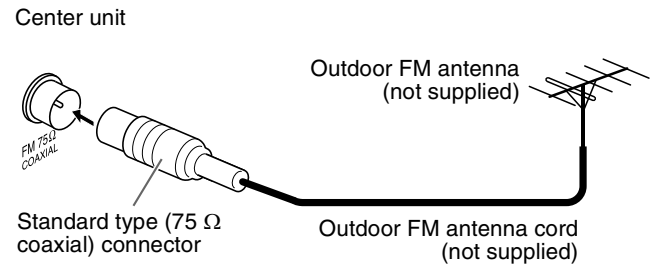

NOTE

- We recommend that you use coaxial cable for the FM antenna as it is well-shielded against interference.

Connecting the satellite (front, center, surround) speakers

■ The front speakers — TH-C7

For the surround speakers of TH-C7, see “The surround speakers — Except for TH-C6” (pg. 10)

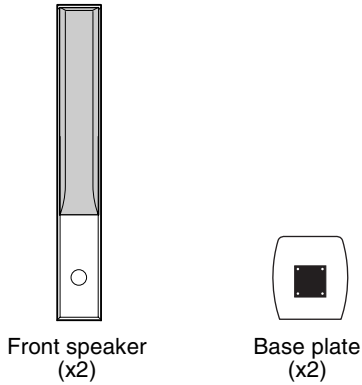

Before assembling —

- Prepare a Phillips screwdriver (not supplied).
- Take care not to drop any component part while assembling; otherwise, it may cause damage to the floor or injury.

1

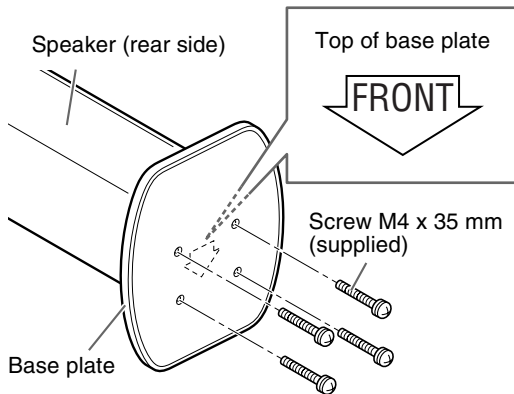

CAUTION

- NEVER insert your finger in between the speaker and the base plate, as it may get hurt.

2

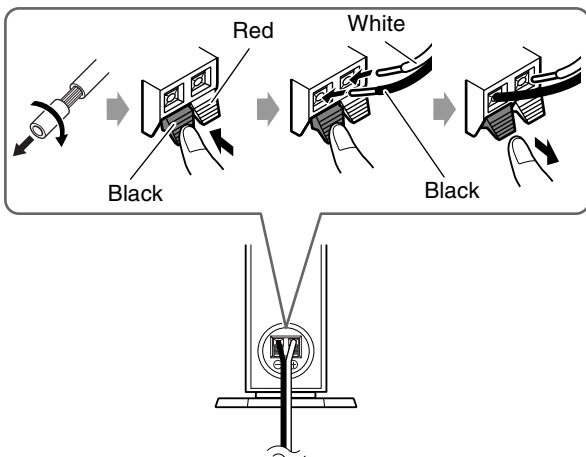

■ The front speakers — TH-C5

For the surround speakers of TH-C5, see “The surround speakers — Except for TH-C6” (pg. 10)

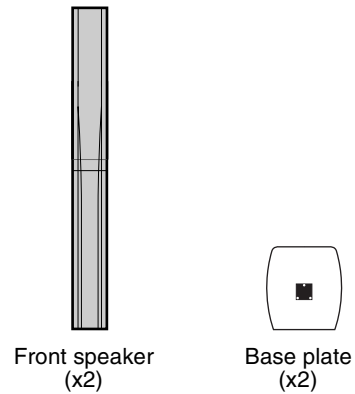

Before assembling —

- Prepare a Phillips screwdriver (not supplied).
- Take care not to drop any component part while assembling; otherwise, it may cause damage to the floor or injury.

1

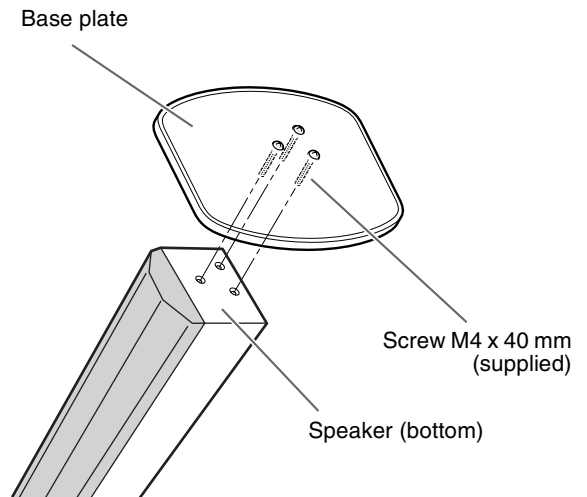

CAUTION

- NEVER insert your finger in between the speaker and the base plate, as it may get hurt.

2

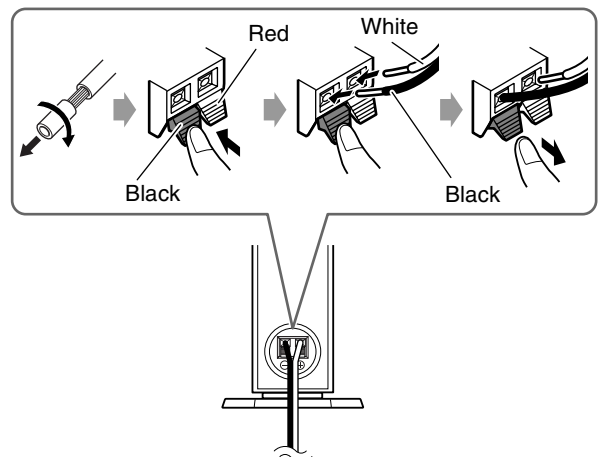

■ The front speakers — TH-C4

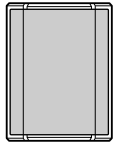

Front speaker (x2)

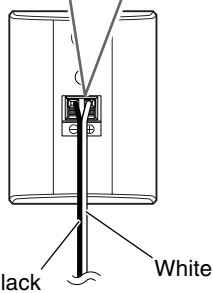
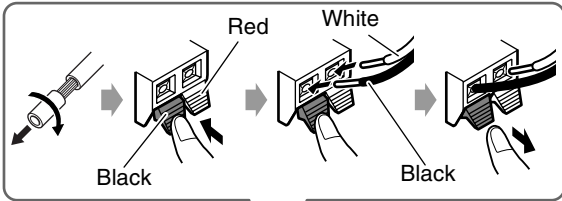

■ The center speaker

The following procedure explains SP-THC5C assembly. The assembly of other center speakers is done in the same manner.



Center speaker (x1)

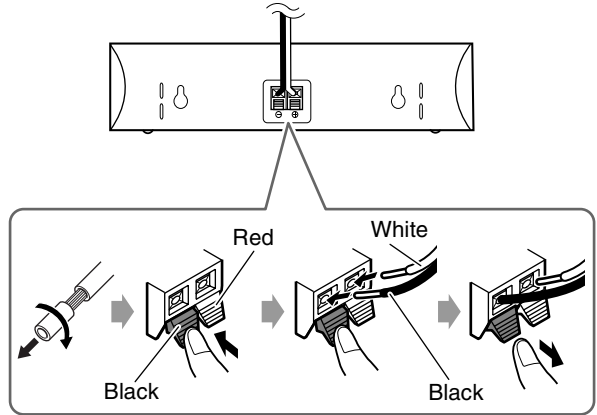

■ The surround speakers — Except for TH-C6

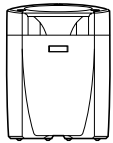

Surround speaker (x2)

For TH-C3, the front, surround and center speakers are equipped with their speaker cords attached directly to their speaker unit instead of having speaker terminals on their cabinet.

Front speaker Surround speaker Center speaker

1

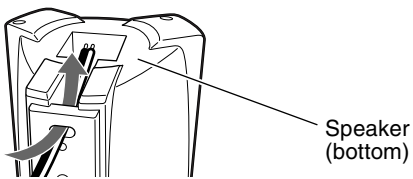

2

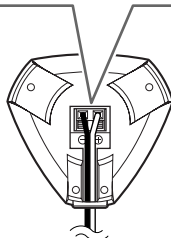
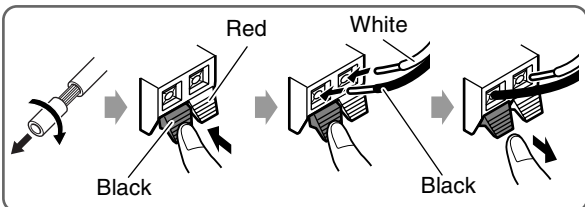

SP-PWC6.

speakers other than the supplied ones, use
speaker impedance (SPEAKER IMPEDANCE)
speaker terminals on the rear of the powered
more than one speaker to one speaker terminal.

Precautions for daily use

- When moving the speakers, do not pull the speaker cords; otherwise, the speakers may fall over, causing damage or injury.
- Do not reproduce sounds at so high a volume that they are distorted; otherwise, the speakers may be damaged by internal heat buildup.
(For TH-C7, TH-C6 and TH-C5)
- When holding a speaker, always grasp the lower portion.
- Do not lean against the speakers, as the speakers could fall down or break, possibly causing an injury. Especially be careful that children do not lean against them.

Speaker layout

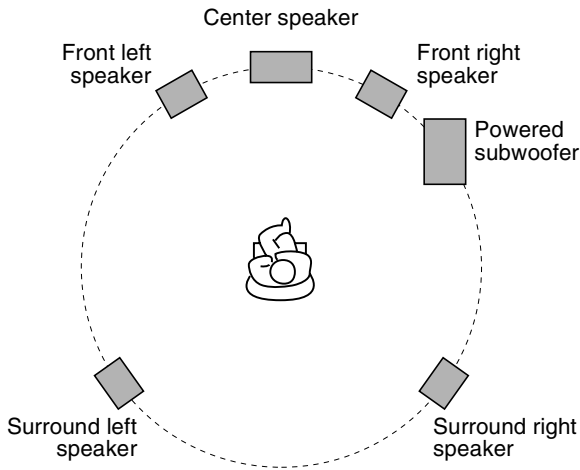

- Place the satellite speakers on a flat and level surface.
- The front and center speakers are magnetically shielded to avoid color distortions on TVs. However, if not installed properly, they may cause color distortions. So, pay attention to the following when installing the speakers.
 - When placing the speakers near a TV set, turn off the TV's main power switch or unplug it before installing the speakers. Then wait at least 30 minutes before turning on the TV's main power switch again.
- Some TVs may still be affected even though you have followed the above. If this happens, move the speakers away from the TV.
- The surround speakers are not magnetically shielded. If it is located nearby the TV or monitor, it will probably cause color distortion on the screen. To avoid this, do not place the speaker nearby the TV or monitor.
- Be sure to place the powered subwoofer to the TV's right. If you place the powered subwoofer to the TV's left, keep sufficient distance between them to prevent the TV screen from appearing mottled.

Connecting a TV

- You can get better picture quality in the order — Component video > S-video > Composite video.
- Distortion of picture may occur when connecting to the TV via a VCR, or to a TV with a built-in VCR.
- You need to set "MONITOR TYPE" in the PICTURE menu correctly according to the aspect ratio of your TV. (☞ pg. 37)

■ To connect a TV equipped with the component video input jacks

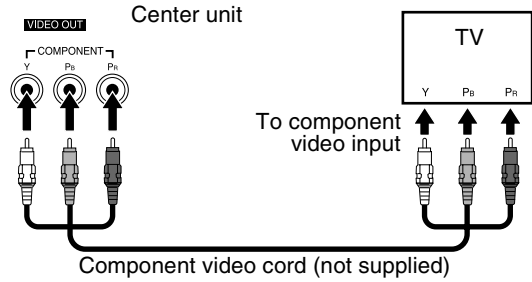

NOTE

- If your TV supports progressive video input, you can enjoy a high quality picture by setting the progressive scan mode to active. (☞ pg. 18)
- If the component video input jacks of your TV are of the BNC type, use a plug adapter (not supplied) to convert the pin plugs to BNC plugs.
- The component video signals can be output only when you select "DVD" as the source to play. (☞ pg. 17)

■ To connect a TV equipped with the composite or S-video jacks

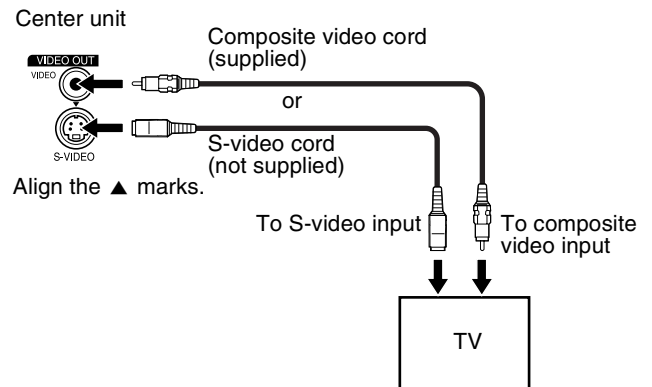

Connecting the powered subwoofer

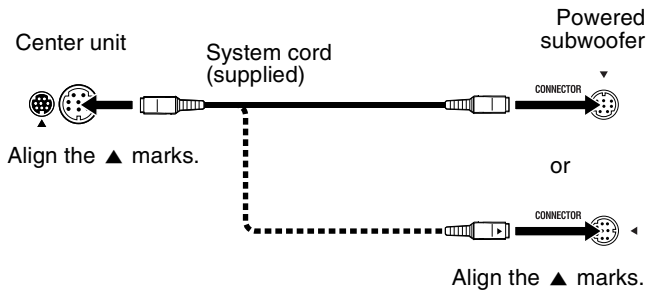

NOTE

- The way of connecting the system cord varies depending on the type of the powered subwoofer.

Connecting to an analog component

You can enjoy the sound of an analog component.

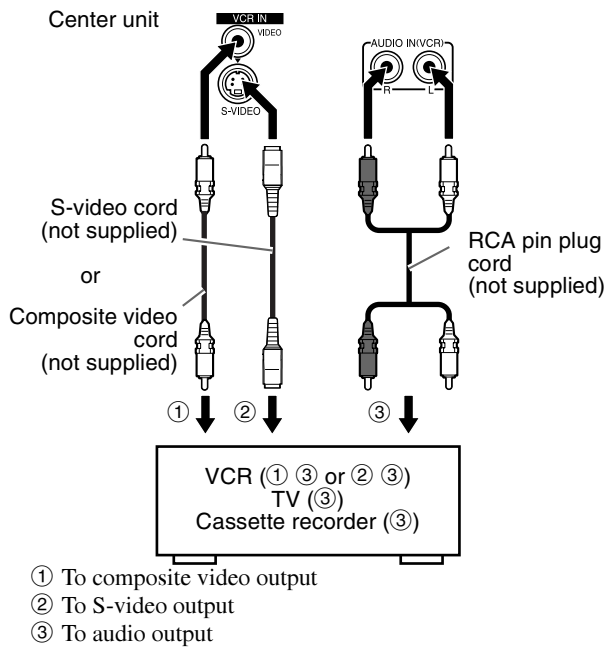

NOTE

- The signals input to the VIDEO jack of the VCR IN jacks will be output only from the VIDEO jack of the VIDEO OUT jacks, not from the S-VIDEO jack of the VIDEO OUT jacks.

Connecting to a digital component

You can enjoy the sound of a digital component.

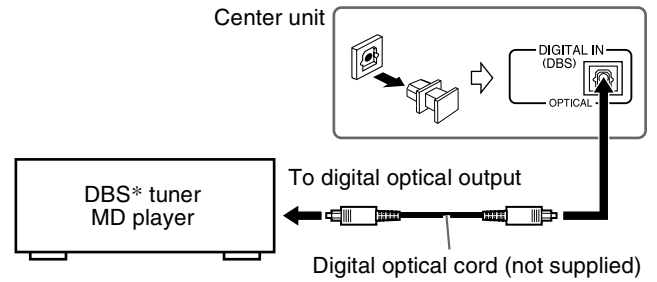

* DBS = Direct Broadcasting Satellite

NOTE

- Only digital audio signals can be input when selecting "DBS" as the source to play. (pg. 17) When connecting a video component such as a DBS tuner, operate this system to listen to the sound.

Connecting the power cord

Make sure that all other connections have been completed.

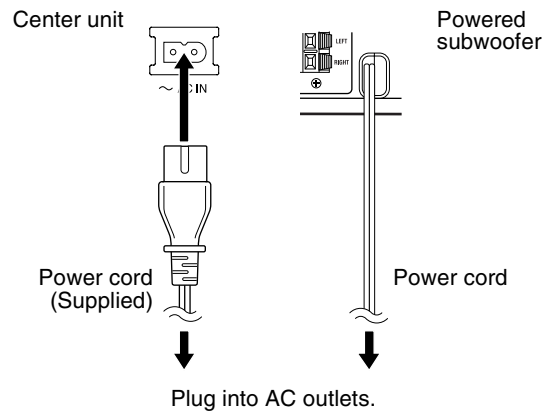

CAUTION

- Disconnect the power cord before cleaning or moving the system.
- Do not pull on the power cord to unplug the cord. When unplugging the cord, always grasp and pull the plug so as not to damage the cord.

Operating external components with the remote control

The buttons described below are used on pages 14 and 15.

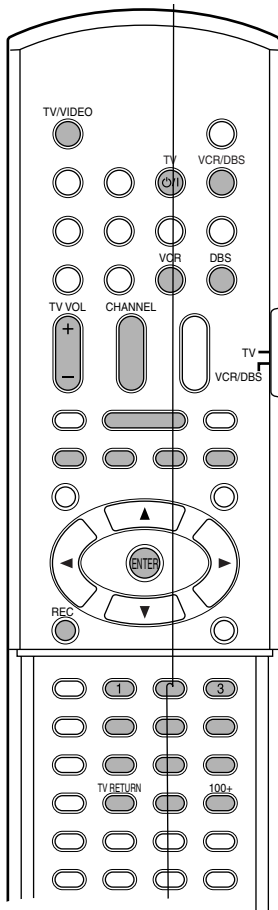

NOTE

- Manufacturers' codes are subject to change without notice.
- Set the codes again after replacing the batteries of the remote control.

Operating the TV

■ To set the manufacturer's code

You can operate a JVC TV without setting the manufacturer's code.

- 1** Slide the remote control mode selector to TV.
- 2** Press and hold **TV**.
Keep the button pressed until step 4 is finished.
- 3** Press **ENTER**.

4 Press number buttons (1-9, 0) to enter the manufacturer's code (2 digits).

Examples:

For a Hitachi TV:

Press 1, then 0.

For a Toshiba TV:

Press 0, then 8.

5 Release **TV**.

If there is more than one code listed for corresponding brand, try each one until you enter the correct one.

■ Operation

Aim the remote control at the TV.

IMPORTANT

Before using the remote control to operate a TV;

- Set the remote control mode selector to TV.

The following buttons are available:

- | | |
|----------------------|---|
| TV: | Turns TV on and off. |
| TV VOL +/-: | Adjusts the volume. |
| TV/VIDEO: | Selects the input mode (either TV or VIDEO). |
| CHANNEL +/-: | Changes the channels. |
| 1-10, 0, +10 (100+): | Selects the channel. |
| TV RETURN: | Alternates between the previously selected channel and the current channel. |

■ To set the manufacturer's code

- 1** Slide the remote control mode selector to VCR/DBS.
- 2** Press **DBS**.
- 3** Press and hold **TV** VCR/DBS.
Keep the button pressed until step 5 is finished.
- 4** Press **ENTER**.

5 Press number buttons (1-9, 0) to enter the manufacturer's code (2 digits).

Examples:

For a GI Jerrold product:

Press 0, then 1.

For a Sony product:

Press 2, then 0.

Manufacturer	Code
Echostar	21
GI Jerrold	01, 02, 03, 04, 05, 06, 07, 08
Hamlin	15, 16, 17, 18
Pioneer	13, 14
RCA	19
Scientific Atlanta	09, 10
Sony	20
Zenith	11, 12

6 Release \odot /I VCR/DBS.

If there is more than one code listed for your brand, try each one until you enter the correct one.

■ Operation

Aim the remote control at the DBS tuner or CATV converter.

IMPORTANT

Before using the remote control to operate a DBS tuner or CATV converter;

- 1 Set the remote control mode selector to VCR/DBS.
- 2 Press DBS.

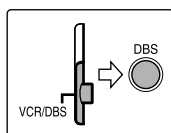

The following buttons are available:

\odot /I VCR/DBS: Turns DBS tuner or CATV converter on and off.

CHANNEL +/-: Changes the channels.

1-10, 0, +10 (100+): Selects the channel.

Operating the VCR

■ To set the manufacturer's code

1 Slide the remote control mode selector to VCR/DBS.

2 Press VCR.

3 Press and hold \odot /I VCR/DBS.

Keep the button pressed until step 5 is finished.

4 Press ENTER.

5 Press number buttons (1-9, 0) to enter the manufacturer's code (2 digits).

Examples:

For a Philips VCR:

Press 0, then 9.

For an NEC VCR:

Press 2, then 5.

Manufacturer	Code	Manufacturer	Code
JVC	01, 02, 03	Philips	09
Emerson	11, 26	RCA	05, 06
Fisher	29	Samsung	24
Funai	10, 14, 15, 16	Sanyo	21, 22, 23
Gold Star	12	Sharp	27, 28
Hitachi	04	Shintom	30
Mitsubishi	13	Sony	18, 19, 20
NEC	25	Zenith	08
Panasonic	07, 17		

6 Release \odot /I VCR/DBS.

If there is more than one code listed for your brand, try each one until you enter the correct one.

■ Operation

Aim the remote control at the VCR.

IMPORTANT

Before using the remote control to operate a VCR;

- 1 Set the remote control mode selector to VCR/DBS.
- 2 Press VCR.

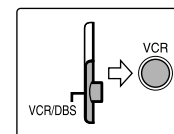

The following buttons are available:

\odot /I VCR/DBS: Turns VCR on and off.

▶ (play button): Starts playback.

■ : Stops operation.

|| : Pauses playback.

▶▶ : Fast forwards video tape.

◀◀ : Rewinds video tape.

REC: Press this button together with ▶ (play button) to start recording or together with || to pause recording.

CHANNEL +/-: Changes the TV channels on the VCR.

NOTE

When operating a VCR or DBS tuner/CATV converter;

- The source setting of VCR or DBS remains after you have changed the remote control mode selector to AUDIO or TV. When operating VCR or DBS tuner/CATV converter again, it is not necessary to press VCR or DBS after setting the remote control mode selector.

Basic operations

The buttons on the remote control are used to explain most of the operations in this manual. You can use the buttons on the center unit same as on the remote control for operations unless otherwise noted.

IMPORTANT

Before using the remote control for the following operation;

- Set the remote control mode selector to AUDIO.

The buttons described below are used on pages 16 to 19.

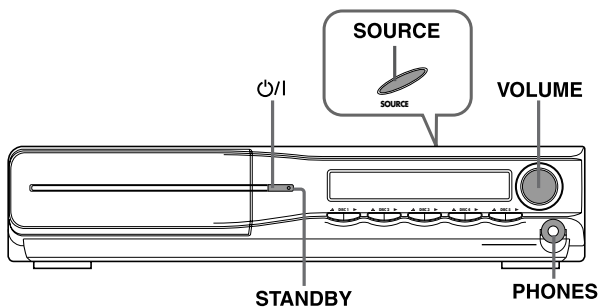
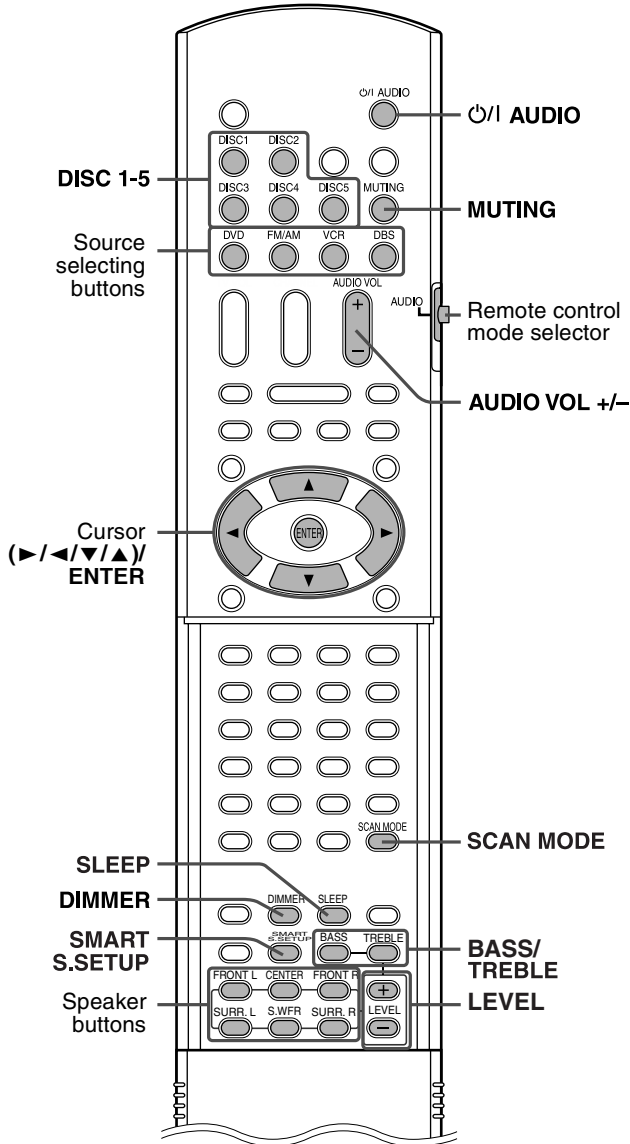
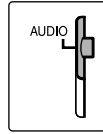

Turning the system on/off

On the remote control:

Press AUDIO.

On the center unit:

Press .

When DVD is selected as the source (see pg. 17), the following messages will appear on the TV screen.

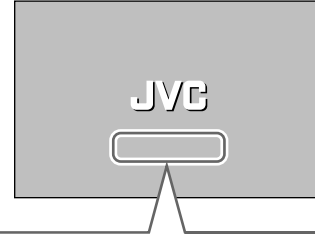

- “OPEN”/“CLOSE”:
Appears when opening or closing the disc tray.
- “NOW READING”:
Appears when the system is reading the disc information.
- “REGION CODE ERROR!”:
Appears when the Region Code of the DVD VIDEO does not match the code the system supports. The disc cannot be played back.
- “NO DISC”:
Appears when no disc is loaded.
- “CANNOT PLAY THIS DISC”:
Appears when unplayable disc is loaded.

NOTE

- The STANDBY lamp turns on when the power is turned off and turns off when the power is turned on.
- The power supply to the subwoofer is linked to the center unit. The POWER ON lamp on the subwoofer lights green when the power is turned on.
- A small amount of the power is consumed even when the power is turned off (center unit only). This is called standby mode and the STANDBY lamp lights in this mode. Unplug the power cord from the AC outlet to turn the power off completely.
- You can also turn on the system by pressing the following buttons;
 - One of buttons on the center unit
 - One of the source selecting buttons on the remote control
 - One of the DISC (1-5) buttons or on the center unit
 You can use the same buttons on the remote control.

Selecting the source to play

On the remote control:

Press one of the source selecting buttons (DVD, FM/AM, VCR or DBS).

DVD: To play back a disc (DVD VIDEO, VCD etc.). (☞ pg. 20)

FM/AM: To tune in an FM or AM station. (☞ pg. 39)

Each time you press the button, the band alternates between FM and AM.

VCR: To select the source from a component connected to the VCR IN jacks and AUDIO IN (VCR) jacks. (☞ pg. 13)

DBS: To select the source from a component connected to the DIGITAL IN (DBS) jack. (☞ pg. 13)

On the center unit:

Press SOURCE repeatedly until the source name you want appears on the display window.

NOTE

- When AM, FM or DBS is selected, this system does not output video signals.
- It may take time to change the source.

Adjusting the volume [VOLUME]

CAUTION

- Always set the volume to minimum level before starting any source. If the volume is set at its high level, the sudden blast of sound could permanently damage your hearing and/or blow out the speakers.

On the remote control:

Press AUDIO VOL +/-.

On the center unit:

Turn VOLUME.

Listening with headphones (not supplied)

CAUTION

Be sure to turn down the volume;

- Before connecting or putting on headphones as high volume may damage both the headphones and your hearing.
- Before disconnecting headphones as high volume may be suddenly output from the speakers.

While connecting a pair of headphones to the PHONES jack on the center unit, the system automatically cancels the surround mode (☞ pg. 24) currently selected, deactivates the speakers, turns the subwoofer's power off, and activates the headphone mode. "H. PHONE" appears on the display window.

Headphone mode

When using the headphones, the following signals are output regardless of your speaker setting;

- For 2 channel sources, the front left and right channel signals are output from the headphones.
- Multi-channel signals are down-mixed and output from the headphones.
- (For DVD AUDIO) When the disc prohibits down-mixing, only the front left and right channels are output from the headphones. In this case, "LR ONLY" appears on the display window for a few seconds.

Turning off the sound temporarily [MUTING]

Press MUTING.

To restore the sound

Perform one on the following:

- Press MUTING again.
- Press AUDIO VOL +/- (or turn VOLUME on the center unit).

Adjusting the brightness of the indications [DIMMER]

Press DIMMER.

Each time you press the button, the brightness level changes.

Sleep Timer [SLEEP]

The system turns off automatically when the specified period of time has passed.

Press SLEEP.

Each time you press the button, the shut-off time changes.

Example:



To check the remaining time

Press SLEEP once.

To change the remaining time

Press SLEEP repeatedly.

To cancel

Press SLEEP repeatedly until "SLEEP –" appears.

- Turning off the power also cancels the Sleep Timer.

Adjusting the output level of the subwoofer and speakers

Press each speaker button you want to adjust the output level and then LEVEL +/-.

- FRONT L: Front Left speaker
- FRONT R: Front Right speaker
- SURR. L: Surround Left speaker
- SURR. R: Surround Right speaker
- CENTER: Center speaker
- S.WFR: Subwoofer

NOTE

- You can also make adjustments by using the setup menu shown on the TV screen. (pg. 37)
- The adjustments take effect for all sources.

Adjusting the treble sound [TREBLE]

Press TREBLE and then LEVEL +/-.

NOTE

- The adjustments take effect for all sources.

Adjusting the bass sound [BASS]

Press BASS and then LEVEL +/-.

NOTE

- The adjustments take effect for all sources.

Changing the scan mode

The system can be accommodated to your TV's scan mode.

NOTE

- To use the system in PROGRESSIVE mode, it is required that the center unit is connected to the TV by using a component video cord (not supplied). (pg. 12)

- While DVD is selected as the source and stopped

1 Press and hold SCAN MODE for 2 seconds.

"INT-LACE" or "PROGRESS" appears on the display window.

2 Press Cursor ▶/◀ to select the desired mode.

- INT-LACE: Select this when your TV supports the interlaced video input only.
- PROGRESS: Select this when your TV equipped with component jacks supports the progressive video input.

You can get better picture quality in PROGRESSIVE mode than in INTERLACE mode.

3 Press ENTER while the selected mode is displayed.

When "PROGRESS" is selected, the PROGRESSIVE indicator lights on the display window.

NOTE

- Although the picture may be distorted when you press ENTER, this is not a malfunction of the system.

- There are some progressive TVs and High-Definition TVs that are not fully compatible with this system, resulting in an unnatural picture when playing back a DVD VIDEO in the progressive scan mode. In such a case, change the scan mode to "INT-LACE". To check the compatibility of your TV, contact your local JVC customer service center.
- All JVC progressive TVs and High-Definition TVs are fully compatible with this system.

Optimizing the speaker settings [Smart Surround Setup]

NOTE

- When you change the positioning of the speakers or listener, or replace the supplied speakers with other ones, perform Smart Surround Setup again.

- While DVD is selected as the source and stopped

1 Take your position where you listen to the sound.

2 Press and hold SMART S. SETUP.

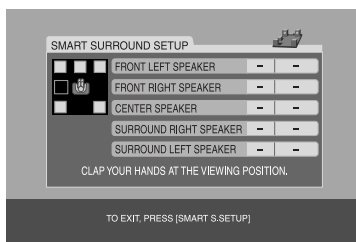

“SETTING” appears on the display window.

3 Clap your hands over your head once.

4 Make sure that “COMPLETED !” appears on the TV screen, then press SMART S. SETUP.

The system detects your clapping sound through the satellite speakers, then automatically makes the best settings for each speaker. “COMPLETED !” appears on the TV screen when Smart Surround Setup completes.

When “FAILED !” appears on the TV screen

The system could not detect the clapping sound correctly. In such a case, follow the instructions that appear on the TV screen.

- When the system detects the clapping sound as “FAILED !” three times, set the delay time (DELAY) and the output level (LEVEL) manually. (☞ pg. 37)

To cancel

Press SMART S. SETUP.

NOTE

- You need to set the subwoofer’s output level (LEVEL) manually. (☞ pg. 18)
- In step 2, “SW ERROR” appears on the display window if the center unit and the powered subwoofer are not connected correctly by using the supplied system cord.

Playback

- The icon such as  shows the disc formats or file types the operation is available for.

IMPORTANT

Before using the remote control for the following operation;

- Set the remote control mode selector to **AUDIO**.
- Press **DVD**.

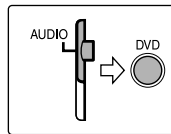

The buttons described below are used on pages 20 to 23.

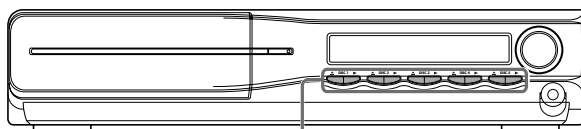
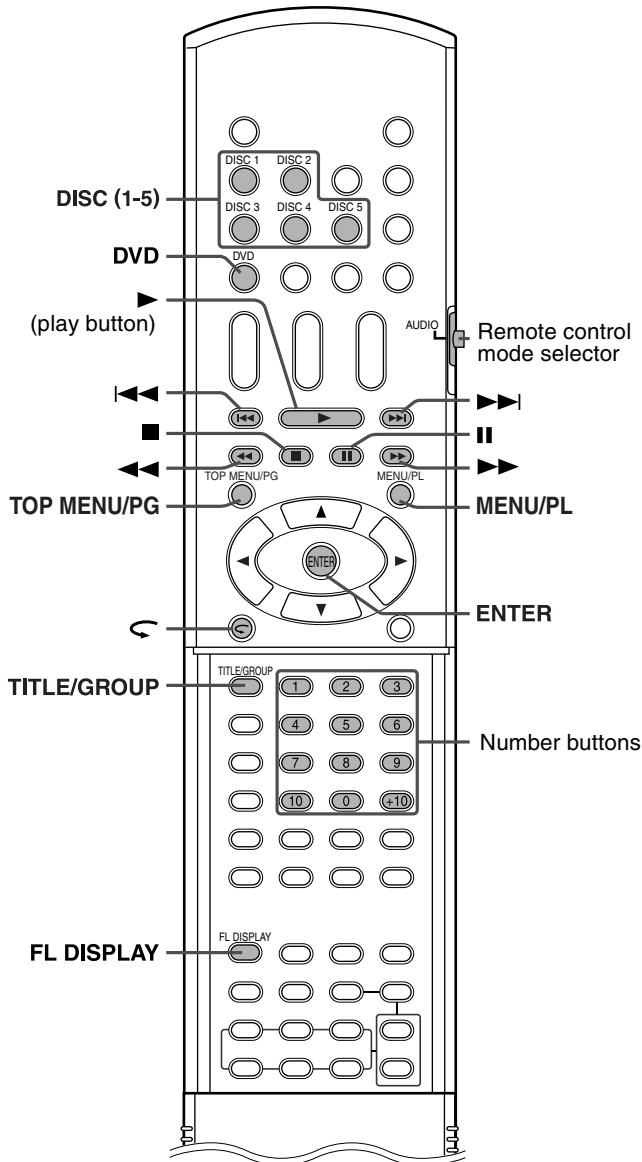

DISC (1-5) 

Basic playback

1 Press the desired DISC (1-5) on the center unit.

- The system turns on and the disc tray comes out.



2 Place a disc.

Label side up

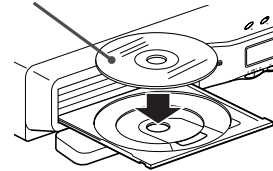

When placing an 8 cm disc

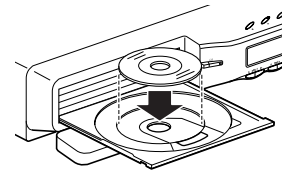

3 Press DISC (1-5).

For MP3/WMA files

The file control display ( pg. 28) appears on the TV screen.

For JPEG files

Each file (still pictures) is shown on the TV screen for about 3 seconds (slide-show). When stopping playback, the file control display ( pg. 28) appears on the TV screen.

For DVD VR disc

Pressing TOP MENU/PG or MENU/PL shows the control display on the TV screen. ( pg. 23)

■ To pause playback

Press **II**.











To return to playback, press  (play button).

■ To stop

Press **■**.

■ On-screen guide icons

During DVD VIDEO playback, the following guide icons may appear for a while on the TV screen;

- : appears at the beginning of a scene containing multi-subtitle languages.
- : appears at the beginning of a scene containing multi-audio languages.
- : appears at the beginning of a scene containing multi-angle views.
-  (Play),  (Pause),  /  (Fast forward/fast-reverse),  /  (Slow-motion forward/reverse): appears when you perform each operation.
- : the disc cannot accept an operation you have tried to do.

NOTE

- Up to 5 discs can be loaded.
- You can also start playback by pressing ► (play button) or DVD.
- The system plays back available discs sequentially until you stop playback or until the disc loaded on the DISC 5 tray reaches to the end. However, when DVD VIDEO or DVD AUDIO is loaded in the system, playback of the disc next to the DVD VIDEO or DVD AUDIO will not start.
- (For JPEG) The system cannot accept operations even though you press any buttons before the entire picture appears on the TV screen.
- If you do not want the on-screen guide icons to appear, see page 38.

■ Playback information on the display window

DVD VIDEO

Example:

When a DVD VIDEO encoded with Dolby Digital 5.1ch is played

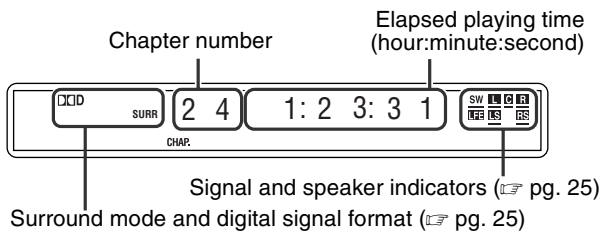

Pressing FL DISPLAY

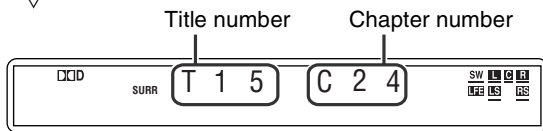

DVD AUDIO

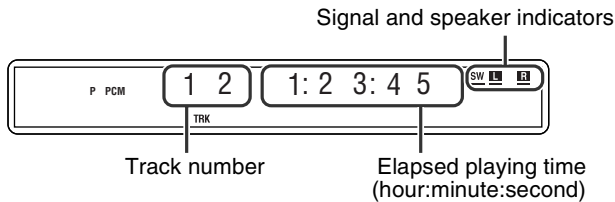

Pressing FL DISPLAY

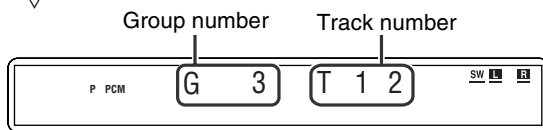

VCD/SVCD/CD

Example:

When a CD is played back

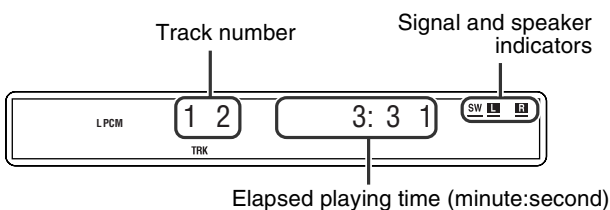

NOTE

- When a VCD or SVCD with PBC function is played, the elapsed playing time does not appear, but "PBC" appears.

MP3/WMA file

Example:

When an MP3 is played back

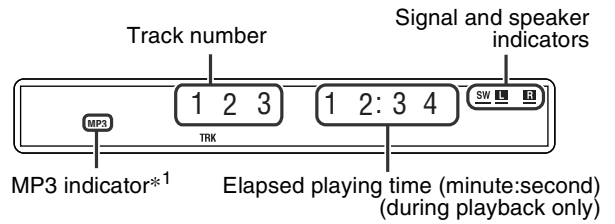

Pressing FL DISPLAY

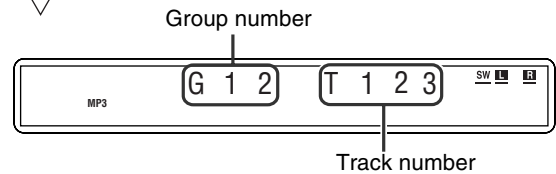

*1 WMA indicator lights for WMA disc.

JPEG file

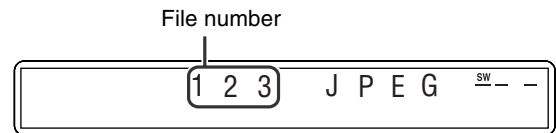

Pressing FL DISPLAY

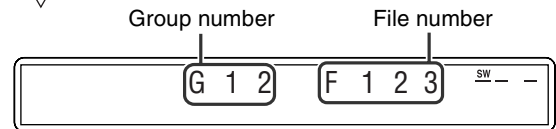

DVD VR disc

Example:

During playback on the Original program*

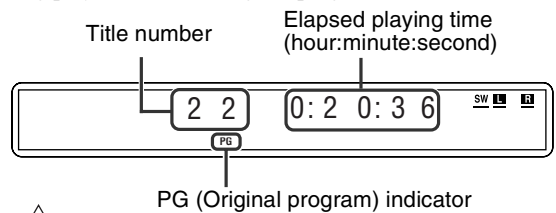

Pressing FL DISPLAY

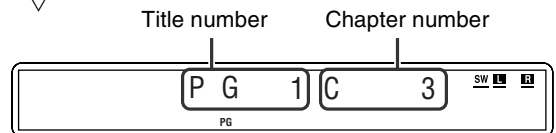

Example:

During playback on the Playlist*

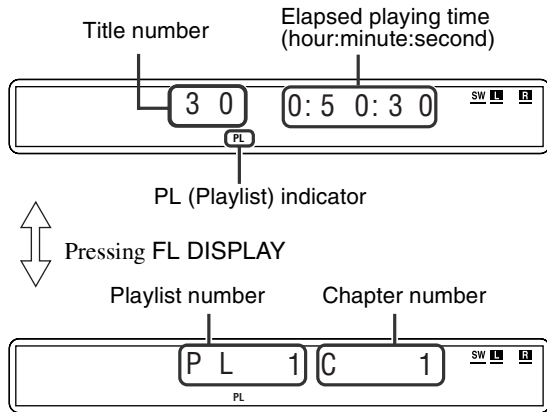

* Pressing TOP MENU/PG or MENU/PL, you can change the play mode. (☞ pg. 23)

NOTE

- You can change the time information mode (except for MP3/WMA/JPEG). (☞ pg. 26)
- You can also check the playback information on the TV screen. (☞ pg. 25)

Disc information on the display window

The disc indicators on the display window show the current status of the corresponding disc tray.

Example:

When the discs are loaded to disc trays 1, 2 and 5, and the disc in the disc tray 5 is selected.

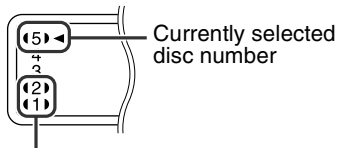

Screen saver

A TV screen may burn out if a static picture is displayed for a long time. To prevent this, the system automatically dims the screen if a static picture is displayed for over 5 minutes (the screen saver function).

- Pressing any button will cancel the screen saver function.
- If you do not want to use the screen saver function, see page 37.

One Touch Replay

You can move back the playback position by 10 seconds from the current position.



■ During playback

On the remote control:

Press ◀.

NOTE

- This function works in the same title.
- This function is not available during the repeat playback.
- This feature may not work for some discs.

Fast-forward/fast-reverse search

■ During playback

On the remote control:

Press ►► or ◀◀.

Each time you press the button, the search speed changes.

To return to normal speed playback

Press ► (play button).

Press and hold ►►| or |◀◀.

Continuously pressing ►►| or |◀◀ increases the fast-forward/reverse search speed.

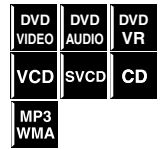

NOTE

- The operation with ►►| or |◀◀ above is available for a disc other than MP3 and WMA.
- When a DVD VIDEO, DVD VR, VCD and SVCD is played back, no sound comes out during fast-forward/reverse search.
- When a DVD AUDIO or CD is played back, sound is intermittent and low during fast-forward/reverse search.
- This feature may not work for some discs.

Skip to the beginning of a desired selection

■ Using ►►|/|◀◀ buttons

■ For DVD VIDEO/DVD VR (chapter):

During playback

For VCD/SVCD (track):

During playback without PBC function

For DVD AUDIO/CD/MP3/WMA/JPEG (track/file): During playback or while stopped

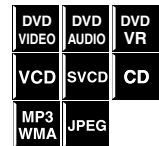

Press ►►| or |◀◀ repeatedly.

NOTE

- When playing back an MP3/JPEG file, you can make operations using the file control display. (☞ pg. 28)
- This feature may not work for some discs.

■ Using number buttons on the remote control

■ For DVD VIDEO/DVD VR (title, chapter):

While stopped, the title number is selected.

During playback, the chapter number is selected.

For DVD AUDIO (track):

During playback or while stopped

For VCD/SVCD (track):

During playback without PBC function

For CD/MP3/WMA/JPEG (track/file):

During playback or while stopped

Press number buttons (0-10, +10) to select the desired number.

- For details on using the number buttons, see "How to use the number buttons" below.

How to use the number buttons

- To select 3: Press 3.
- To select 14: Press +10, then 4.
- To select 24: Press +10 twice, then 4.
- To select 40: Press +10 three times, then 10. Or press +10 four times, then 0.

Locating a desired title/group using number buttons

■ During playback or while stopped

1 Press TITLE/GROUP.

“_ _” or “_” is shown in the title/group display area in the display window.

Example:

During DVD VIDEO playback

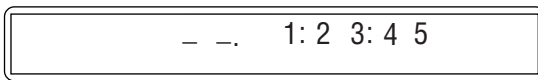

2 While the display window shows “_ _” or “_”, use number buttons (0-10, +10) to enter the desired title or group number.

The system starts playback from the first chapter/track/file of the selected title/group.

- For details on using the number buttons, see “How to use the number buttons” (pg. 22).

NOTE

- This feature may not work for some discs.

Playing back a bonus group

Some DVD AUDIOS have a special group called “bonus group” whose contents are not open to the public. The bonus group is always assigned to the last group of a disc.



To play back a bonus group, you have to enter the specific “key number” (a password). The way of getting the key number depends on the disc. After getting the key number, you can play back the bonus group by following the procedure below.

■ While the BONUS indicator lights up on the display window

1 Select the bonus group.

For selecting the group, see “Locating a desired title/group using number buttons” described above. The key number entry indication appears.

On the TV



On the display window

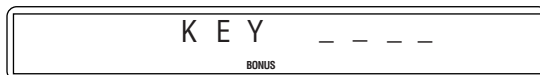

2 Press number buttons (0-9) to enter the key number, then press ENTER.

When you enter the correct key number, playback starts and the BONUS indicator goes off.

- If you enter the wrong number, reenter the correct number.

To clear the key number entry

Perform whichever one of the following:

- Open the disc tray.
- Turn off the system.

NOTE

- In Random Playback, tracks in the bonus group are not played back.

Selecting the desired title/playlist from the control display

■ During playback or while stopped.

1 Press TOP MENU/PG or MENU/PL.



The control display is shown on the TV screen, and the system starts playback of the first title/playlist.

- The PLAY LIST is shown only when the playlist is on the DVD VR disc.

TOP MENU/PG: shows the ORIGINAL PROGRAM.

Example:

ORIGINAL PROGRAM					
No	Date	Ch	Time	Title	
1	25/04/04	4ch	19:00	JVC DVD World 2004	
2	17/05/04	8ch	10:30		
3	22/05/04	8ch	17:00	Music Festival	
4	26/05/04	L-1	13:19	children 001	
5	20/06/04	4ch	22:00		
6	25/06/04	L-1	8:23	children 002	

- *1: Title number
- *2: Recording date
- *3: Recording source (TV station, the input terminal of the recording equipment etc.)
- *4: Start time of recording
- *5: Title of the original program/playlist (The title may not be displayed depending on the recording equipment.)
- *6: Current title

MENU/PL: shows the PLAY LIST.

Example:

PLAY LIST					
No	Date	Chap	Length	Title	
1	25/05/04	001	1:03:16	My JVC World	
2	17/06/04	005	1:35:25		
3	20/06/04	003	0:10:23	Favorite music	
4	25/06/04	001	0:07:19	children001-002	

- *7: Playlist number
- *8: Creating date of playlists
- *9: Number of chapters
- *10: Total playing time
- *11: Current playlist

2 Press ▼/▲ to select the desired title/playlist.

The system starts playback of the selected title/playlist.

To clear the control display

- Press ENTER.

About the play mode on a DVD VR disc

- Original program (ORIGINAL PROGRAM):
The system can play back the original picture in the recorded order.
- Playlist (PLAY LIST):
The system can play back the playlist edited by the recording equipment.

Advanced operations

- The icon such as  shows the disc formats or file types the operation is available for.

IMPORTANT

Before using the remote control for the following operation;

- Set the remote control mode selector to **AUDIO**.
- There are exceptions in the operation mentioned above. In such a case, follow each instruction.

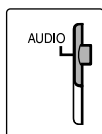

The buttons described below are used on pages 24 to 35.

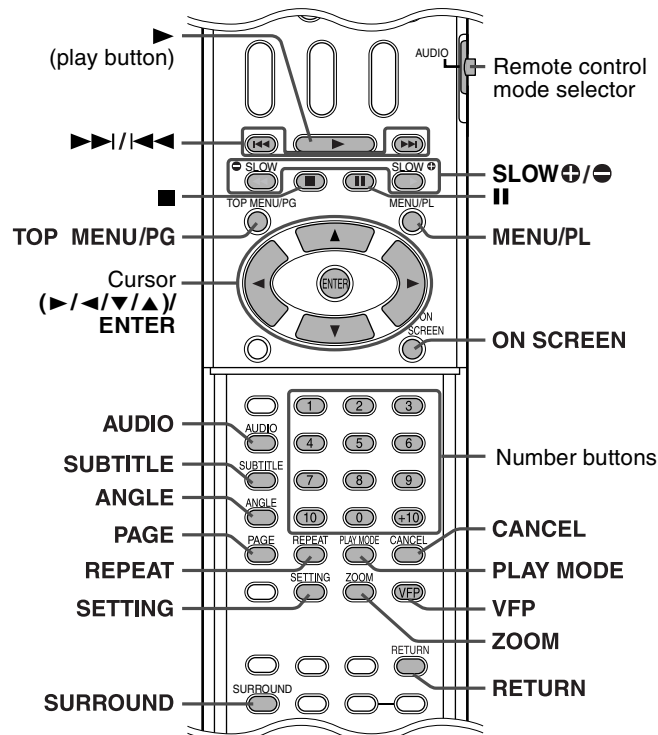

Using the surround mode

■ Auto Surround (AUTO SUR)

Used to reproduce the sound as it is recorded without any conversion (downmixing or simulation, etc.). For example, a multichannel source is automatically reproduced in multichannel audio.

■ Dolby Surround

Dolby Pro Logic II*1

Dolby Pro Logic II has a newly developed multichannel playback format to decode all 2 channel sources — stereo source and Dolby Surround encoded source — into a 5.1 channel.

Dolby Pro Logic II has two modes — Movie mode and Music mode:

• Pro Logic II Movie (MOVIE)

Suitable for reproduction of Dolby Surround encoded sources bearing the mark .

• Pro Logic II Music (MUSIC)

Suitable for reproduction of any 2 channel stereo music sources.

■ Dolby Digital*1

Used to reproduce multichannel soundtracks of the software encoded with Dolby Digital (.

■ DTS Digital Surround*2

Used to reproduce multichannel soundtracks of the software encoded with DTS Digital Surround (.

DTS Digital Surround (DTS) is another discrete multichannel digital audio format available on CD and DVD software.

Available Surround modes for each input signal

The ✓ marks show available surround modes.

Mode	Surround off	Auto Surround	Dolby Surround			DTS Digital Surround	Linear PCM	Packed PCM	DSP
	SURR OFF	AUTO SUR	MOVIE*3	MUSIC*3	DOLBY D	DTS	LPCM	PPCM	ALL ST*3
Dolby D (Multichannel)	✓	✓	—	—	✓	—	—	—	—
Dolby D (2 channel)	✓	✓	✓	✓	—	—	—	—	✓
DTS Digital Surround (Multichannel)	✓	✓	—	—	—	✓	—	—	—
DTS Digital Surround (2 channel)	✓	✓	✓	✓	—	—	—	—	✓
Analog (VCR) or Linear/Packed PCM (2 channel)	✓	✓	✓	✓	—	—	—	—	✓
Linear/Packed PCM (Multichannel)	✓	✓	—	—	—	—	✓	✓	—

*1 Manufactured under license from Dolby Laboratories. “Dolby”, “Pro Logic”, “MLP Lossless”, and the double-D symbol are trademarks of Dolby Laboratories.

*2 “DTS” and “DTS Digital Surround” are registered trademarks of Digital Theater Systems, Inc.

*3 You can select these modes by pressing **SURROUND**. (pg. 25)

■ All Channel Stereo (DSP)

All Channel Stereo (ALL ST) mode can reproduce a larger stereo sound field using all the connected (and activated) speakers. All Channel Stereo can be used while reproducing 2 channel stereo source.

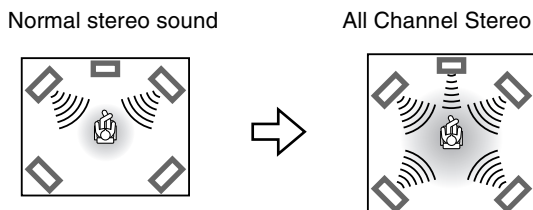

■ Indicators on the display window

Digital signal format indicators

- PPCM, SURR: Lights when DVD AUDIO packed PCM signals comes in.
- LPCM, SURR: Lights when Linear PCM signal comes in.
- DD, SURR: Lights when Dolby D signals come in.
- DTS, SURR: Lights when DTS Digital (Surround) signals come in.
- No indication: No digital signal indicator lights when analog signals come in.

Dolby Surround/DSP mode indicators

- DDPLII, SURR: Lights when Dolby Pro Logic II mode is activated.
- SURR: Lights when All Channel Stereo mode is activated.

Source signal indicators, etc.

Light to indicate the incoming signals.



- L**: Lights when the left channel signal comes in.
- C**: Lights when the center channel signal comes in.
- R**: Lights when the right channel signal comes in.
- LFE**: Lights when the LFE channel signal comes in.
- LS**: Lights when the surround left channel signal comes in.
- RS**: Lights when the surround right channel signal comes in.
- S**: Lights when the monaural surround channel signal or 2 channel Dolby Surround signal comes in.
- SW**: Always lights.

The channel with “—” shows that the corresponding speakers are reproducing the channels’ sound. If the channels’ sound decoded into 5.1 channel is reproduced, only “—” lights.

Selecting the surround mode

The system is set up to automatically select the optimal surround mode for input signal from digital multichannel software. When playing back 2 channel source, you can select the desired surround mode manually.

IMPORTANT

Before using the remote control for the following operation;

- Set the remote control mode selector to AUDIO.

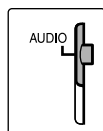

■ When playing back digital multichannel software (except during SURR OFF mode)

The appropriate multichannel surround mode (Dolby D, DTS Digital Surround or Linear/Packed PCM) is automatically selected.

■ When playing back 2 channel source

You can select either mode of Dolby Pro Logic II (MOVIE/MUSIC) or the DSP (ALL ST) mode.

Press SURROUND repeatedly to select the desired mode.

The surround mode is turned on and the current surround mode appears on the display window. Each time you press the button, the surround mode changes. For details on each mode, see page 24.

To turn off the surround mode

Press SURROUND repeatedly until SURR OFF appears on the display window.

Storing adjustments — auto memory

When you turn the power off, the system memorizes the current surround mode. The memorized mode is automatically recalled when you turn the power on.

NOTE

- When FM or AM is selected as the source, you can select All Channel Stereo (ALL ST) and SURR OFF mode.
- For a down-mixing prohibited DVD AUDIO disc, the system continues to output multi-channel signals with “MULTI CH” shown on the display window even if the surround mode is turned off during playback. On the other hand, the system outputs only the front left and right channel signals with “LR ONLY” shown on the display window when you start playback with the surround mode having been set to “SURR OFF” or “H. PHONE”.

Using the on-screen bar

You can check disc information and you can use some functions using the on-screen bar.

Showing the on-screen bar

- Whenever a disc is loaded



Press ON SCREEN.

Each time you press the button, the on-screen bar changes as follows on the TV screen.

Example:

During DVD VIDEO playback



OFF
(The on-screen bar disappears)



(back to the beginning)

- The currently selected item shows green.

■ Contents of the on-screen bar during playback

DVD VIDEO

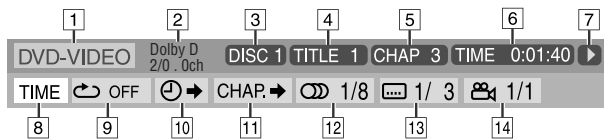

DVD AUDIO

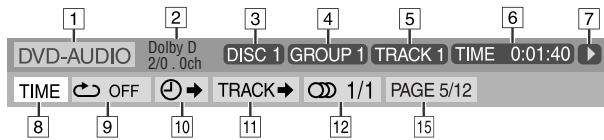

VCD

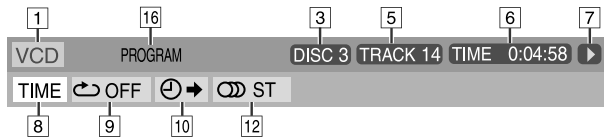

SVCD

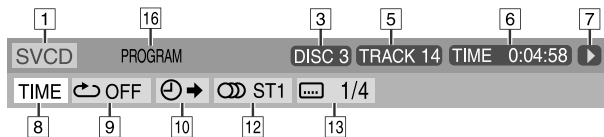

CD

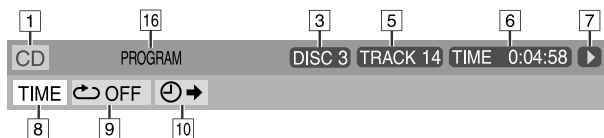

DVD VR disc

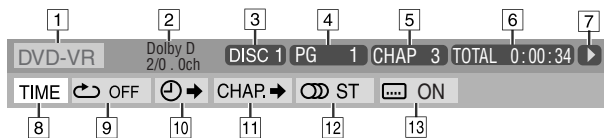

- 1 Shows disc type.
- 2 Shows audio information.
- 3 Shows disc number.
- 4 Shows current title (for DVD VIDEO), group (for DVD AUDIO) number or play mode (for DVD VR).
- 5 Shows current chapter number (for DVD VIDEO and DVD VR) or track number (for other type of discs).
- 6 Shows time information. See “Changing the time information”.

- 7 Shows playback status.
 - ▶: appears during playback.
 - ▶▶ / ◀◀: appears during fast forward/reverse.
 - ▶◀ / ◀▶: appears during playback in forward slow-motion/reverse slow-motion.
 - ||: appears when paused.
 - : appears when stopped.
- 8 Select this to change time information (6). See “Changing the time information” below.
- 9 Select this for Repeat Playback. (pg. 33)
- 10 Select this for time search function. (pg. 28)
- 11 Select this for chapter (for DVD VIDEO and DVD VR) or track (for DVD AUDIO) search function. (pg. 27)
- 12 Select this to change audio language, channel, or stream. (pg. 30)
- 13 Select this to change subtitle language and subpicture. (pg. 29)
- 14 Select this to change view angle. (pg. 29)
- 15 Select this to change the page. (pg. 31)
- 16 Shows Playback Mode status.
 - PROGRAM: appears during Program Playback. (pg. 32)
 - RANDOM: appears during Random Playback. (pg. 33)

Changing the time information

You can change the time information in the on-screen bar on the TV screen and the display window of the center unit.

DVD VIDEO	DVD AUDIO	DVD VR
VCD	SVCD	CD

■ During playback

- 1 Press ON SCREEN twice.
The on-screen bar appears on the TV screen.
- 2 Press Cursor ▶/◀ to highlight TIME .
- 3 Press ENTER repeatedly to select the desired information.

Example:

When elapsed playing time of disc is selected.

TOTAL 1:25:58

■ VCD/SVCD/CD

- TIME: Elapsed playing time of current track
- REM: Remaining time of current track
- TOTAL: Elapsed time of disc
- T. REM: Remaining time of disc

■ DVD VIDEO/DVD AUDIO/DVD VR

- TIME: Elapsed playing time of current chapter/track
- REM: Remaining time of current chapter/track
- TOTAL: Elapsed time of Title/Group/Program
- T. REM: Remaining time of Title/Group/Program

4 Press ON SCREEN.

The on-screen bar disappears.

NOTE

- When playing back DVD VR, “TIME” and “REM” cannot be shown.

Locating a desired scene using a DVD VIDEO menu with PBC

You can still use the PBC function to locate a desired scene. You can also play a DVD VIDEO with PBC function.

Locating a desired scene using a DVD VIDEO menu

DVD VIDEOS generally have a menu which lists the disc contents and you can locate a desired scene. You can locate a desired scene using the following steps.

- Whenever a DVD VIDEO is played, the menu appears on the TV screen.

1 Press TOP MENU/PG.

The menu appears on the TV screen.

Example:

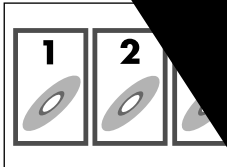

Normally, a DVD VIDEO which contains more than one title will have a "top" menu which lists the titles. Press TOP MENU/PG to show the title menu.

Some DVD VIDEO may also have a different menu shown by pressing MENU/PL.

See the instructions for each DVD VIDEO regarding its particular menu.

2 Use Cursor ▶/◀/▼/▲ to select a desired item.

3 Press ENTER.

- With some discs, you can also select items by entering the corresponding number using number buttons.

Locating a desired scene using a VCD/SVCD menu with PBC

A VCD or SVCD recorded with PBC has its own menus such as a list of contained songs. You can locate a specific scene by using these menus.



- During playback with PBC function

1 Press RETURN repeatedly until the menu appears on the TV screen.

Example:

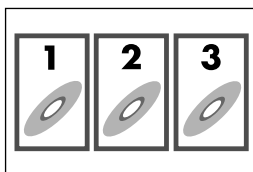

4 Press 8/10/20/37.

Example:

To select 8: Press 8.

To select 10: Press 10.

To select 20: Press 20.

To select 37: Press 37.

To correct a misentry:

Repeat step 4.

5 Press ENTER.

6 Press ON SCREEN.

The on-screen bar disappears.

NOTE

- You can select up to the 99th chapter/track.

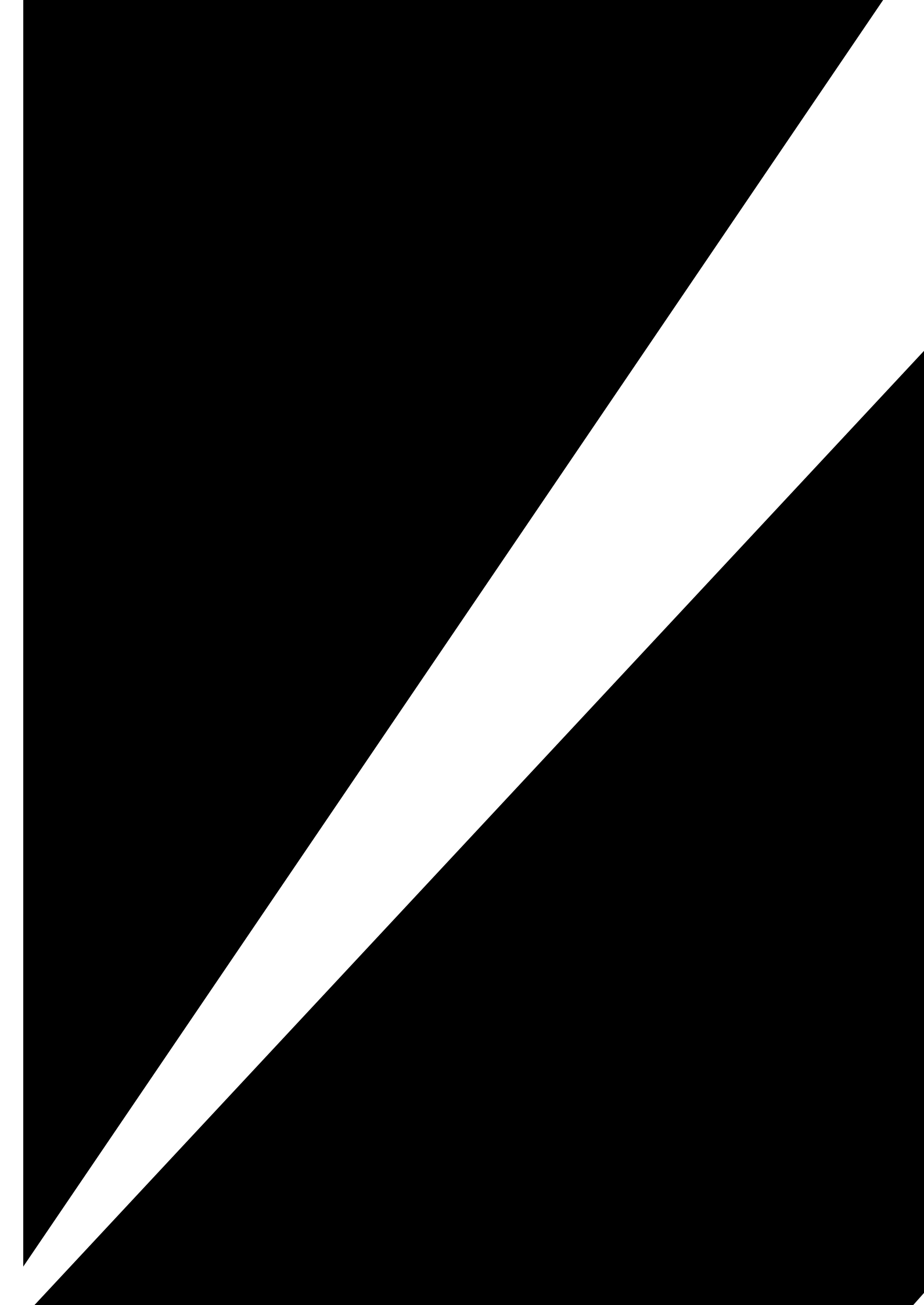

Resume Playback

When Resume Playback is set to "ON" (☞ pg. 38) and you stop playback by the following operations, the position where playback has been stopped is stored. ("RESUME" appears on the display window.)

- Turning off the power (☞ pg. 16)
- Pressing ■ once
- Changing the source (☞ pg. 17)



To start playback from the stored position

Press ► (play button) or DVD.

- There may be a case where ► (play button) does not work after changing the source.

To clear the stored position

Press ■ again or open the disc tray with the playback disc.

Selecting a view angle

- During playback of a disc containing multi-view angles



When using the ANGLE button:

1 Press ANGLE.

Example:

The first view angle is selected out of 3 view angles recorded.

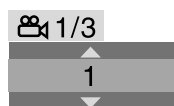

2 Press ANGLE repeatedly or press Cursor ▼/▲ to select the desired view angle.

When using the on-screen bar:

1 Press ON SCREEN twice.

The on-screen bar appears on the TV screen.

2 Press Cursor ►/◀ to highlight 1/3.

3 Press ENTER.



4 Press Cursor ▼/▲ to select the desired view angle.

5 Press ENTER.

6 Press ON SCREEN.

The on-screen bar disappears.

NOTE

- During DVD AUDIO playback, this feature is available only for the video part.

Selecting the subtitle

- During playback of a disc containing subtitles in several languages



When using the SUBTITLE button:

1 Press SUBTITLE.

Example (DVD VIDEO):

"ENGLISH" is selected out of 3 subtitle languages recorded.

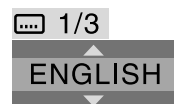

2 Press Cursor ▼/▲ to select the desired subtitle.

For DVD VR

- Pressing SUBTITLE activates the subtitles (subpictures) regardless of whether the subtitles are recorded or not. (subpictures will not change if no subpictures is recorded.)

For SVCD

- An SVCD can contain up to four subtitles. Pressing SUBTITLE changes the subtitles regardless of whether the subtitles are recorded or not. (Subtitles will not change if no subtitle is recorded.)

NOTE

- To clear the subtitle, press SUBTITLE. Each time you press SUBTITLE, subtitle appears and disappears alternately.

When using the on-screen bar:

1 Press ON SCREEN twice.

The on-screen bar appears on the TV screen.

2 Press Cursor ►/◀ to highlight 1/3.

3 Press ENTER.

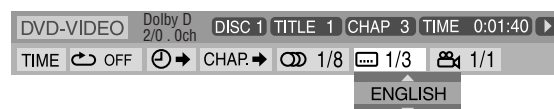

4 Press Cursor ▼/▲ repeatedly to select the desired subtitle.

5 Press ENTER.

6 Press ON SCREEN.

The on-screen bar disappears.

NOTE

- To clear the subtitle, press SUBTITLE. Each time you press SUBTITLE, subtitle appears and disappears alternately.
- Some subtitle or audio languages are abbreviated in the pop-up window. See "The language codes list" (☞ pg. 36).
- During DVD AUDIO playback, this feature is available only for the video part.



ges recorded.

ress
sired audio.

ght 1/3 .

ct the desired

4
5
6

NOTE

- Some logos are abbreviated in the pop-up window. See the "codes list" (pg. 36).
- "ST", "L", "R" are displayed when playing a VCD, SVCD or DVD VR recording. The text indicating "stereo", "left sound" and "right sound".

Frame-by-frame playback

■ During playback

Press **II** repeatedly.

Each time you press the button, the still picture advances by one frame.

To return to normal playback

Press **▶** (play button).

Playing back in slow-motion

■ During playback

1 Press **II** at the point where you want to start playback in slow-motion from.

The system pauses playback.

2 Press **SLOW** .

- Playback in forward slow-motion starts.

For DVD VIDEO/DVD AUDIO only:

- To play back in reverse slow-motion, press **SLOW** .

Each time you press the button, the playback speed become faster.

Example: On the TV

To return to normal playback

Press **▶** (play button).

NOTE

- Sound cannot be heard during slow-motion playback.
- During DVD AUDIO playback, this feature is available only for the video part.

Selecting browsable still picture recorded on DVD AUDIO

Most DVD AUDIOS include browsable still pictures (B.S.P.), which usually appear by turns automatically during playback according to the playback sequence. You can change the picture (turn the page) manually when the current group/track has selectable pictures (pages).



- During playback and while the B.S.P. indicator lights up on the display window

When using the PAGE button:

Press PAGE repeatedly to select a desired still picture.

When using the on-screen bar:

1 Press ON SCREEN twice.

The on-screen bar appears on the TV screen.

2 Press Cursor ►/◄ to highlight

3 Press ENTER.

4 Press Cursor ▲/▼ to select the desired still picture.

5 Press ENTER.

6 Press ON SCREEN.

The on-screen bar disappears.

Zooming in

- During playback or while paused

1 Press ZOOM.

Each time you press ZOOM, scene magnification changes.

2 While zoomed in, press Cursor ►/◄/▼/▲ to move zoom-in area.

To return to normal playback

Press ZOOM repeatedly to select ZOOM OFF.

NOTE

- The number of the magnification steps varies depending on the disc type.
- During slide-show playback of JPEG, zooming in is not available. In such a case, press **II** to pause slide-show playback, then zoom in.
- During DVD AUDIO playback, this feature is available only for the video part.
- During playback, there may be a case where Cursor (►/◄/▼/▲) does not work in step 2 above.

Changing the VFP setting

The VFP (Video Fine Processor) function enables you to adjust the picture character according to the type of programming, picture tone or personal preference.

- During playback

1 Press VFP.

The current VFP settings appear on the TV screen.

Example:

2 Press Cursor ►/◄ repeatedly to select the VFP mode.

- NORMAL: Normally select this.
- CINEMA: Suitable for movies.

When you select "NORMAL" or "CINEMA", press VFP to complete the setting.

- USER 1 and USER 2:

You can adjust parameters that affect picture appearance.

Only when selecting "USER 1" or "USER 2" in step 2, proceed to perform the following operation;

3 Press Cursor ▼/▲ repeatedly to select a parameter you want to adjust.

Adjust gradually and confirm picture appearance results are as preferred.

- GAMMA:
Controls brightness of neutral tints while maintaining brightness of dark and bright portions.
- BRIGHTNESS:
Controls screen brightness.
- CONTRAST:
Controls screen contrast.
- SATURATION:
Controls screen color depth.
- TINT:
Controls screen tint.
- SHARPNESS:
Controls screen sharpness.

program window appears on the TV screen.

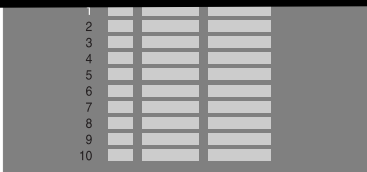

USE NUMERIC KEYS TO PROGRAM TRACKS.
USE CANCEL TO DELETE THE PROGRAM.

If all of the programmed tracks/files have been played back, playback stops and the program window appears again. Note that program setting remains.

To check the program contents

During playback, press **■**. Playback stops and the program window appears.

To quit the Program mode

While stopped, press **PLAY MODE** repeatedly until both program window and **RANDOM** disappear from the TV screen.

NOTE

- There may be a case where bonus group on a DVD AUDIO cannot be played.
- The Resume function cannot be used with Program Playback.
- Program Playback may not work for some discs.

Random Playback

You can play titles or tracks on a disc in random order.

- While stopped

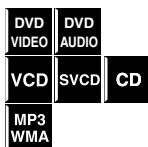

1 Press PLAY MODE repeatedly until **RANDOM appears on the TV screen.**

2 Press ► (play button).

- When more than one discs are loaded, the system starts Random Playback of the next disc after completing current disc playback.

To quit Random mode

While stopped, press PLAY MODE repeatedly until both program window and **RANDOM** disappear from the TV screen. You can also clear the Random mode by turning off the system.

NOTE

- The same title/track will not be played back more than once during Random Playback.

Repeat Playback

Repeating the current selection or all discs

- For DVD VIDEO/DVD VR: During playback
- For VCD/SVCD: During playback without PBC function or stopped
- For DVD AUDIO/CD/MP3/JPEG: During playback or stopped



When using the REPEAT button: Press REPEAT.

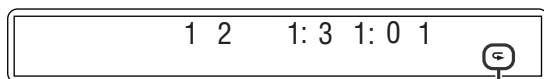

Repeat mode indicator

Each time you press REPEAT, the Repeat mode changes.

Display window	TV screen	Meanings
↺	↺GROUP REPEAT GROUP	Repeats the current group for DVD AUDIO/MP3/WMA/JPEG.
	↺TITLE	Repeats the current title for DVD VIDEO.
	↺PG	(For DVD VR) Repeats the current title for Original program.
	↺PL	(For DVD VR) Repeats the current playlist for Playlist.
↺ DISC	↺DISC	Repeats all titles and tracks on the current disc for DVD VR/VCD/SVCD/CD/MP3/WMA/JPEG.
↺ ALL	↺ALL REPEAT ALL	Repeats all the available discs.
	↺ 1	↺TRACK , ↺STEP REPEAT TRACK, REPEAT STEP
↺ 1	↺CHAP , ↺STEP REPEAT STEP	Repeats the current chapter for DVD VIDEO/DVD VR.
	No indication	↺OFF

NOTE

- When DVD VIDEO or DVD AUDIO is loaded in the system, playback of the disc next to the DVD VIDEO or DVD AUDIO will not start, although ↺ALL /REPEAT ALL on the TV screen or ↺ ALL in the display window is shown.
- For DVD VIDEO and DVD AUDIO, REPEAT ALL and REPEAT DISC may not be available depending on the disc.

When using the on-screen bar (except for MP3/WMA/JPEG):

- 1 Press ON SCREEN twice.**
The on-screen bar appears on the TV screen.
- 2 Press Cursor ►/◀ to highlight ↺ OFF .**
- 3 Press ENTER.**



- 4 Press Cursor ▼/▲ repeatedly to select the Repeat mode.**
- 5 Press ENTER.**
- 6 Press ON SCREEN.**

The on-screen bar disappears.

To cancel Repeat Playback

Select "OFF" in step 4.

Repeating a desired part [A-B Repeat]

You can repeat playback of a desired part by specifying the beginning (point A) and ending (point B).

- During playback

1 Press ON SCREEN twice.

The on-screen bar appears on the TV screen.

Sound and other settings

IMPORTANT

Before using the remote control for the following operation;

- Set the remote control mode selector to AUDIO.

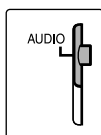

NOTE

Before you start operation;

- There is a time limit when doing the following steps. If the setting is cancelled before you finish, start from step 1 again.

1 Press SETTING.

Example:

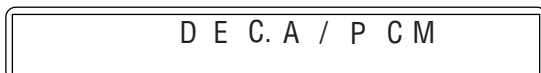

2 Press Cursor ▼/▲ to select the item you want to set.

- DEC (Decode):
When you play an external source (DBS is selected as a source) that was encoded with Dolby D or DTS Digital Surround, the following symptoms may occur;
 - No sound comes out at the beginning of playback.
 - Noise comes out while searching for or skipping chapters or tracks.

A/PCM (Auto/PCM):
Normally select this. The system automatically detects the incoming signals.

DD: Select this if the symptoms above occur when playing a disc (or software) encoded with Dolby D.

DTS: Select this if the symptoms above occur when playing a disc (or software) encoded with DTS Digital Surround.
- MON (Monitor Out):
Select the video output jack type by which you watch DVD playback after connecting your TV. (☞ pg. 12)
Set the video output to use AV COMPU LINK remote control system. (☞ pg. 41)
- VIDEO: To watch DVD playback via the VIDEO jack.
- S: To watch DVD playback via the S-VIDEO jack.
- COMP (Component):
To watch DVD playback via the COMPONENT VIDEO OUT jacks.

3 Press Cursor ►/◀ to make an adjustment or selection.

Example:

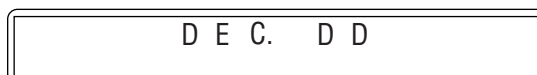

The adjustment is set and the display automatically disappears a few seconds later.

NOTE

- When “DD” or “DTS” is selected, if a signal encoded with another digital format comes in, you cannot listen to the sound. (The DIGITAL or DTS indicator flashes.)

Picture menu (PICTURE)

MONITOR TYPE

You can select the monitor type to match your TV when you play DVDs recorded in the picture's height/width ratio of 16:9.

- 16:9 (Wide television conversion)**
 Select this when the aspect ratio of your TV is fixed on 16:9 (wide TV).
 When you play DVDs recorded in the picture's height/width ratio of 4:3, the system adjust the ratio of output signal automatically.
- 4:3 LB (Letter Box conversion)**
 Select this when the aspect ratio of your TV is 4:3 (conventional TV). While viewing a wide screen picture, the black bars appear on the top and the bottom of the screen.
- 4:3 PS (Pan Scan conversion)**
 Select this when the aspect ratio of your TV is 4:3 (conventional TV). While viewing a wide screen picture, the black bars do not appear, however, the left and right edges of the pictures will not be shown on the screen.



Ex.: 16:9



Ex.: 4:3 LB



Ex.: 4:3 PS

NOTE

- Even if "4:3 PS" is selected, the screen size may become "4:3 LB" with some DVDs. This depends on how DVDs are recorded.

PICTURE SOURCE

When you set the scan mode to "PROGRESS" (pg. 18), you can obtain optimal picture quality by selecting whether the content on the disc is processed by frame (film source) or by field (video source).

Normally set to "AUTO".

- AUTO**
 Used to play a disc containing both video and film source materials.
 This system recognizes the source type (video or film) of the current disc according to the disc information.
- If the playback picture is unclear or noisy, or the oblique lines of the picture are rough, try to change to other modes.
- FILM**
 Suitable for playing back a film source disc.
- VIDEO**
 Suitable for playing back a video source disc.

SCREEN SAVER (pg. 22)

You can activate or deactivate Screen Saver function.

FILE TYPE

When several types of files are recorded on a disc, you can select which files to play.

- AUDIO**
 Select this to play MP3/WMA files.
- STILL PICTURE**
 Select this to play JPEG files.

Audio menu (AUDIO)

D. RANGE COMPRESSION

(Dynamic range compression)

You can enjoy low level recorded sound clearly at night even at a low volume when listening to the sound with Dolby Digital.

- AUTO**
 Select this when you want to enjoy surround sound with its full dynamic range (no effect applied).
- ON**
 Select this when you want to fully apply the compression effect (useful at midnight).

NOTE

- When you play a multichannel Dolby Digital source with the surround mode is off, the setting of D. RANGE COMPRESSION is set to ON automatically.

Speaker setting menu (SPK. SETTING)

Level menu (LEVEL)

FRONT LEFT SPEAKER/FRONT RIGHT SPEAKER/CENTER SPEAKER/SURROUND RIGHT SPEAKER/SURROUND LEFT SPEAKER

While monitoring the test tone, adjust the center and surround speakers volume as much as that of the front speakers.

TEST TONE*

Outputs the test tone.

- * The test tone comes out of all of the activated speakers in the following sequence:

⇒ Front left speaker ⇒ Center speaker ⇒ Front right speaker ⇒ Surround right speaker ⇒ Surround left speaker ⇒ (back to the beginning)

Delay menu (DELAY)

Example:

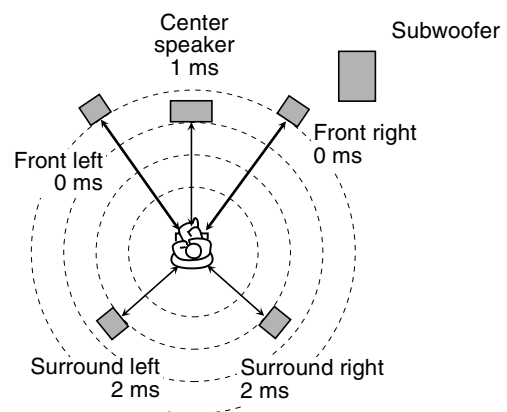

In this case, set the delay time of each speaker as follows;

- Delay time of front speakers: 0 ms
- Delay time of center speaker: 1 ms
- Delay time of surround speakers: 2 ms

FRONT LEFT SPEAKER/FRONT RIGHT SPEAKER/CENTER SPEAKER/SURROUND RIGHT SPEAKER/SURROUND LEFT SPEAKER

Adjust the distance from the listening position to the speakers.

Within the range from 0 ms to 15 ms. (by 1 ms)

Setting DVD preferences

■ Subwoofer menu (SUBWOOFER)

LEVEL

You can set the output level of the subwoofer in the -6 dB to +6 dB range.

CROSS OVER

The signals below the preset frequency level will be sent to and be reproduced by the subwoofer.

Select one of the cross over frequency levels according to the bass sound quality from the front/center/surround speakers.

: Other setting menu (OTHERS)

■ RESUME

You can activate or deactivate Resume Playback function.
( pg. 29)

■ ON SCREEN GUIDE

You can activate or deactivate the on-screen guide icons.
( pg. 20)

Tuner operations

IMPORTANT

Before using the remote control for the following operation;

- 1 Set the remote control mode selector to AUDIO.
- 2 Press FM/AM.

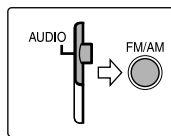

NOTE

- When FM or AM is selected as the source, you can select All Channel Stereo (ALL ST) and SURR OFF mode.

The buttons described below are used on pages 39 to 40.

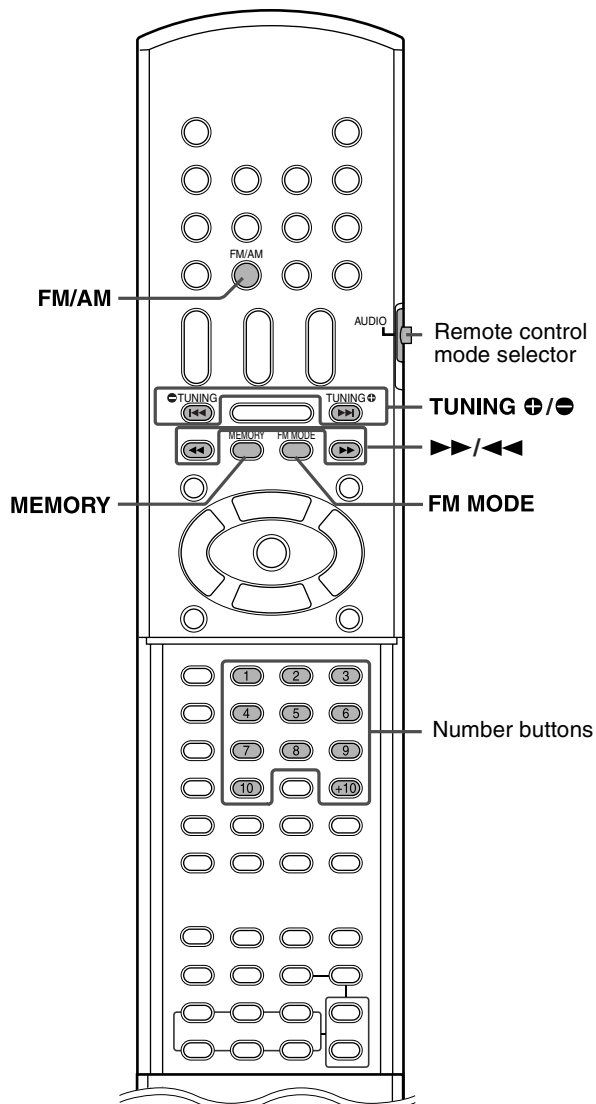

Manual tuning

1 Press FM/AM repeatedly to select the band.

Example:

When the system is tuned in to 810 kHz.



2 Press TUNING \oplus/\ominus repeatedly until you find the frequency you want.

When you hold down the button until the system starts searching for stations and then release it, the system stops searching automatically when a station of sufficient signal strength is tuned in to.

NOTE

- When an FM stereo program is received, the ST indicator lights on the display window.

Preset tuning

Once a station is assigned to a channel number, the station can be quickly tuned in. You can preset 30 FM and 15 AM stations.

■ To preset the stations

1 Tune in the station you want to preset.

- If you want to store the FM reception mode for an FM station, select the reception mode you want. See “Selecting the FM reception mode” below.

Example:

When the system is tuned in to 103.5 MHz.

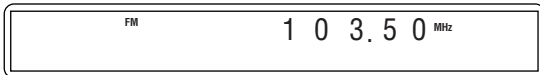

2 Press MEMORY.

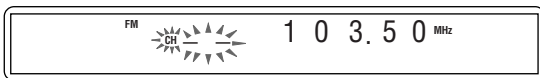

While “CH” and “-” are flashing:

3 Press number button(s) (1-10, +10) to select a preset number you want.

- For details on using the number buttons, see “How to use the number buttons” (pg. 22).

Example:

When the preset channel 1 is selected.

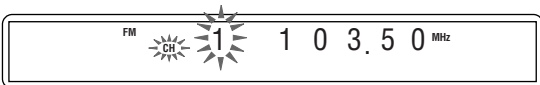

If the setting is cancelled before you finish, start from step 2 again.

While the selected number is flashing:

4 Press MEMORY.

The selected number stops flashing.

The station is assigned to the selected preset number.

If the setting is cancelled before you finish, start from step 2 again.

5 Repeat steps 1 to 4.

- Storing a new station to a used number erases the previously stored one.

■ To tune in to a preset station

1 Press FM/AM repeatedly to select FM or AM.

2 Press number button(s) (1-10, +10) to select a preset number.

- For details on using the number buttons, see “How to use the number buttons” (pg. 22).

NOTE

- You can also select a preset number by pressing ►►/◄◄.

Selecting the FM reception mode

When the stereo FM program currently tuned in is noisy, you can change the FM reception mode to improve the reception.

- While listening to an FM station

Press FM MODE.

The FM reception mode appears on the display window.

Each time you press the button, the FM reception mode changes.

- **AUTO:**

When a program is broadcast in stereo, you will hear stereo sound. (The ST indicator lights on the display window.) When in monaural, you will hear monaural sound. This mode is also useful to suppress static noise between stations.

- **MONO:**

Reception will be improved although you will lose the stereo effect. (The MONO indicator lights on the display window.) In this mode, you will hear noise until you are tuned in to a station.

Reducing the noise of AM broadcast

When listening to an AM broadcast with a lot of noise interference, you can change the Beat Cut mode to reduce the noise.

- While listening to an AM station

Press FM MODE.

The current Beat Cut mode appears on the display window.

Each time you press the button, the Beat Cut mode changes.

- Choose “BEATCUT1” or “BEATCUT2” according to which gives clearer sound.

control system allows you to use

cassette without its safety tab
playback without manually s
automatically turns on and cha

turns on and changes the i
so that you can view the p
video cassette with its saf
on the VCR or on the

DVD play

starting playback on the
back without manuall
turns on and ch
appropriate position so that

Automatic selection

when you select DVD
the TV automaticall
position so that y

Automatic E

The TV and
When you

- If the
- If the

PULINK
VCR

S C
D L

Maintenance

■ Handling Discs

- Remove the disc from its case by holding it at the edge while pressing the center hole lightly.
- Do not touch the shiny surface of the disc or bend the disc.
- Put the disc back in its case after use to prevent warping.
- Be careful not to scratch the surface of the disc when placing it back in its case.
- Avoid exposure to direct sunlight, temperature extremes and moisture.



To clean the disc

Wipe the disc with a soft cloth in a straight line from center to edge.

- **DO NOT use any solvent — such as conventional record cleaner, spray, thinner or benzine — to clean the disc.**



■ Cleaning the system

- Stains on the system should be wiped off with a soft cloth. If the system is heavily stained, wipe it with a cloth soaked in water-diluted neutral detergent and wrung well, then wipe clean with a dry cloth.
- Since the system may deteriorate in quality, become damaged or get its paint peeled off, be careful about the following.
 - DO NOT wipe it with a hard cloth.
 - DO NOT wipe it strong.
 - DO NOT wipe it with thinner or benzine.
 - DO NOT apply any volatile substance such as insecticides to it.
 - DO NOT allow any rubber or plastic to remain in contact with it for a long time.

Troubleshooting

PROBLEM	POSSIBLE CAUSE	SOLUTION
Power does not come on.	The power cord and/or system cord is not connected.	Connect the power cord and system cord correctly. (☞ pg. 13)
The remote control does not work.	The batteries are exhausted.	Replace the batteries. (☞ pg. 6)
	Sunlight is falling directly on the remote sensor.	Hide the remote sensor from direct sunlight.
No sound.	The system cord and/or speaker cord is not connected.	Check the connection.
	The audio cord is not connected to AUDIO IN (VCR) and/or DIGITAL IN (DBS) correctly.	Connect the cord correctly. (☞ pg. 13)
	An incorrect source has been selected.	Select the correct source. (☞ pg. 17)
	The decode mode is not set correctly.	Select the proper decode mode. (☞ pg. 35)
No picture is displayed on the TV screen.	The video cord is not connected correctly.	Connect the cord correctly. (☞ pg. 12)
	The disc is not playable.	Use a playable disc. (☞ pg. 3)
No picture is displayed on the TV screen, the picture is blurred, or the picture is divided into two parts.	The scan mode is set to "PROGRESS" though the center unit is connected to the TV which does not support the progressive video input such as a conventional TV.	Change the scan mode to "INT-LACE". (☞ pg. 18)
Video and audio are distorted.	The disc is scratched or dirty.	Replace or clean the disc.
	A VCR is connected between the center unit and the TV.	Connect the center unit and TV directly. (☞ pg. 12)
The picture does not fit the TV screen.	The monitor type is not set correctly.	Set "MONITOR TYPE" properly. (☞ pg. 37)
Hard to listen to broadcast because of noise.	Antennas are disconnected.	Reconnect the antennas correctly and securely. (☞ pg. 7)

Specifications

■ Center unit (XV-THC7/XV-THC6/XV-THC5/XV-THC4/XV-THC3)

Audio section

Total Harmonic Distortion 0.02 %

NOTE: This value is measured at System cord CONNECTOR for reference.

Digital input*1:

DIGITAL IN (DBS): -21 dBm to -15 dBm
(OPTICAL) (660 nm ±30 nm)

*1 Corresponding to Linear PCM, Dolby Digital, and DTS Digital Surround (with sampling frequency — 32 kHz, 44.1 kHz, 48 kHz)

Video section

Video System: NTSC

Horizontal Resolution: 500 lines

Signal-to-Noise Ratio: 64 dB

Video output level

Composite: 1.0 V(p-p)/75 Ω

S-video-Y: 1.0 V(p-p)/75 Ω

S-video-C: 0.286 V(p-p)/75 Ω

Component-Y: 1.0 V(p-p)/75 Ω

Component-Pb/Pr: 0.7 V(p-p)/75 Ω

Video input sensitivity/Impedance (VCR IN)

Composite: 1.0 V(p-p)/75 Ω

S-video-Y: 1.0 V(p-p)/75 Ω

S-video-C: 0.286 V(p-p)/75 Ω

Tuner section

Tuning Range

FM: 87.5 MHz to 108.0 MHz

AM: 530 kHz to 1 710 kHz

General

Power Requirements: AC 120 V ~, 60 Hz

Power Consumption: 16 W (at operation)
1.3 W (in standby mode)

Dimensions (W × H × D):

400 mm × 85 mm × 399 mm
(15-3/4 inches × 3-3/8 inches ×
15-3/4 inches)

Mass: 4.2 kg (9.3 lbs)

■ Subwoofer (SP-PWC7)

Amplifier section

Front/Center/Surround: 167 W per channel, RMS at 3 Ω at 1 kHz, with 10 % total harmonic distortion.

Subwoofer: 167 W, RMS at 3 Ω at 100 Hz, with 10 % total harmonic distortion.

Speaker section

Speaker unit: 25 cm (9-7/8 inches) Bass-reflex

Power Handling Capacity: 170 W

Impedance: 3 Ω

Frequency Range: 25 Hz to 200 Hz

General

Power Requirements: AC 120 V ~, 60 Hz

Power Consumption: 160 W (at operation)
0 W (in standby mode)

Dimensions (W × H × D):

264 mm × 481 mm × 459 mm
(10-7/16 inches × 18-15/16 inches ×
18-1/8 inches)

Mass: 16.5 kg (37 lbs)

■ Subwoofer (SP-PWC6)

Amplifier section

Front/Center/Surround: 167 W per channel, RMS at 3 Ω at 1 kHz, with 10 % total harmonic distortion.

Subwoofer: 167 W, RMS at 3 Ω at 100 Hz, with 10 % total harmonic distortion.

Speaker section

Speaker unit: 16 cm (6-5/16 inches) Bass-reflex

Power Handling Capacity: 170 W

Impedance: 3 Ω

Frequency Range: 30 Hz to 200 Hz

General

Power Requirements: AC 120 V ~, 60 Hz

Power Consumption: 160 W (at operation)
0 W (in standby mode)

Dimensions (W × H × D):

169 mm × 411 mm × 451 mm
(6-11/16 inches × 16-3/16 inches ×
17-13/16 inches)

Mass: 11.5 kg (25.4 lbs)

■ Subwoofer (SP-PWC5)

Amplifier section

Front/Center/Surround: 167 W per channel, RMS at 3 Ω at 1 kHz, with 10 % total harmonic distortion.

Subwoofer: 167 W, RMS at 3 Ω at 100 Hz, with 10 % total harmonic distortion.

Speaker section

Speaker unit: 25 cm (9-7/8 inches) Bass-reflex

Power Handling Capacity: 170 W

Impedance: 3 Ω

Frequency Range: 25 Hz to 200 Hz

General

Power Requirements: AC 120 V ~, 60 Hz

Power Consumption: 160 W (at operation)
0 W (in standby mode)

Dimensions (W × H × D):

264 mm × 481 mm × 459 mm
(10-7/16 inches × 18-15/16 inches ×
18-1/8 inches)

Mass: 16.5 kg (37 lbs)

■ Subwoofer (SP-PWC4)

Amplifier section

Front/Center/Surround: 167 W per channel, RMS at 3 Ω at 1 kHz, with 10 % total harmonic distortion.

Subwoofer: 167 W, RMS at 3 Ω at 100 Hz, with 10 % total harmonic distortion.

Speaker section

Speaker unit: 16 cm (6-5/16 inches) Bass-reflex

Power Handling Capacity: 170 W

Impedance: 3 Ω

Frequency Range: 25 Hz to 200 Hz

General

Power Requirements: AC 120 V ~, 60 Hz

Power Consumption: 160 W (at operation)
0 W (in standby mode)

Dimensions (W × H × D):

169 mm × 411 mm × 451 mm
(6-11/16 inches × 16-3/16 inches ×
17-13/16 inches)

Mass: 11.5 kg (25.4 lbs)

■ Subwoofer (SP-PWC3)

Amplifier section

Front:	140W per channel, RMS at 4 Ω at 1 kHz, with 10 % total harmonic distortion.
Center/Surround:	130W per channel, RMS at 4 Ω at 1 kHz, with 10 % total harmonic distortion.
Subwoofer:	140 W, RMS at 4 Ω at 100 Hz, with 10 % total harmonic distortion.

Speaker section

Speaker unit:	16 cm (6-5/16 inches) Bass-reflex
Power Handling Capacity:	140 W
Impedance:	4 Ω
Frequency Range:	30 Hz to 200 Hz

General

Power Requirements:	AC 120 V ~, 60 Hz
Power Consumption:	135 W (at operation) 0 W (in standby mode)
Dimensions (W × H × D):	169 mm × 411 mm × 451 mm (6-11/16 inches × 16-3/16 inches × 17-13/16 inches)
Mass:	11.5 kg (25.4 lbs)

■ Satellite Speakers — SP-XTHC7

Front speakers (SP-THC7F)

Speaker unit:	
Woofer:	10 cm (3-15/16 inches) × 4
Tweeter:	4 cm (1-5/8 inches) Bass-reflex, Magnetically Shielded
Power Handling Capacity:	170 W
Impedance:	3 Ω
Frequency Range:	60 Hz to 20 kHz
Dimensions (W × H × D):	270 mm × 1 085 mm × 310 mm (10-11/16 inches × 42-3/4 inches × 12-1/4 inches)
Mass:	8.8 kg (19.4 lbs) each

Center speaker (SP-THC7C)

Speaker unit:	
Woofer:	10 cm (3-15/16 inches) × 2
Tweeter:	4 cm (1-5/8 inches) Bass-reflex, Magnetically Shielded
Power Handling Capacity:	170 W
Impedance:	3 Ω
Frequency Range:	65 Hz to 20 kHz
Dimensions (W × H × D):	380 mm × 141 mm × 163 mm (15 inches × 4-9/16 inches × 6-7/16 inches)
Mass:	3.4 kg (7.5 lbs)

Surround speakers (SP-THC5S)

Speaker unit:	8.0 cm (3-3/16 inches) Bass-reflex
Power Handling Capacity:	170 W
Impedance:	3 Ω
Frequency Range:	80 Hz to 20 kHz
Dimensions (W × H × D):	111.5 mm × 148 mm × 106.5 mm (4-7/16 inches × 5-7/8 inches × 4-1/4 inches)
Mass:	0.44 kg (0.97 lbs) each

■ Satellite Speakers — SP-XTHC6

Front speakers (SP-THC6F)

Speaker unit:	5.5 cm (2-3/16 inches) × 2 1.5 cm (5/8 inches) Bass-reflex, Magnetically Shielded
Power Handling Capacity:	170 W
Impedance:	3 Ω
Frequency Range:	90 Hz to 20 kHz
Dimensions (W × H × D):	250 mm × 1 104 mm × 250 mm (9-7/8 inches × 43-1/2 inches × 9-7/8 inches)
Mass:	2.6 kg (5.8 lbs) each

Center speaker (SP-THC6C)

Speaker unit:	5.5 cm (2-3/16 inches) × 2 1.5 cm (5/8 inches) Bass-reflex, Magnetically Shielded
Power Handling Capacity:	170 W
Impedance:	3 Ω
Frequency Range:	90 Hz to 20 kHz
Dimensions (W × H × D):	320 mm × 75 mm × 92 mm (12-5/8 inches × 3 inches × 3-5/8 inches)
Mass:	0.9 kg (2.0 lbs)

Surround speakers (SP-THC6S)

Speaker unit:	5.5 cm (2-3/16 inches) × 2 1.5 cm (5/8 inches) Bass-reflex
Power Handling Capacity:	170 W
Impedance:	3 Ω
Frequency Range:	90 Hz to 20 kHz
Dimensions (W × H × D):	250 mm × 1 142 mm × 250 mm (9-7/8 inches × 45 inches × 9-7/8 inches)
Mass:	2.6 kg (5.8 lbs) each

■ Satellite Speakers — SP-XTHC5

Front speakers (SP-THC5F)

Speaker unit: 5.5 cm (2-3/16 inches) × 2
Bass-reflex, Magnetically Shielded

Power Handling Capacity: 170 W

Impedance: 3 Ω

Frequency Range: 95 Hz to 20 kHz

Dimensions (W × H × D): 230 mm × 110.5 mm × 285 mm
(9-1/16 inches × 4-3/8 inches × 11-5/16 inches)

Mass: 3.5 kg (7.8 lbs) each

Center speaker (SP-THC5C)

Speaker unit: 5.5 cm (2-3/16 inches) × 2
Bass-reflex, Magnetically Shielded

Power Handling Capacity: 170 W

Impedance: 3 Ω

Frequency Range: 90 Hz to 20 kHz

Dimensions (W × H × D): 320 mm × 75 mm × 92 mm
(12-5/8 inches × 3 inches × 3-5/8 inches)

Mass: 0.90 kg (2.0 lbs)

Surround speakers (SP-THC5S)

Speaker unit: 8.0 cm (3-3/16 inches)
Bass-reflex

Power Handling Capacity: 170 W

Impedance: 3 Ω

Frequency Range: 80 Hz to 20 kHz

Dimensions (W × H × D): 111.5 mm × 148 mm × 106.5 mm
(4-7/16 inches × 5-7/8 inches × 4-1/4 inches)

Mass: 0.44 kg (0.97 lbs) each

■ Satellite Speakers — SP-XTHC4

Front speakers (SP-THC4F)

Speaker unit: 8.0 cm (3-3/16 inches)
1.5 cm (5/8 inches)
Bass-reflex, Magnetically Shielded

Power Handling Capacity: 170 W

Impedance: 3 Ω

Frequency Range: 80 Hz to 20 kHz

Dimensions (W × H × D): 104.5 mm × 139 mm × 101 mm
(4-1/8 inches × 5-1/2 inches × 4 inches)

Mass: 0.56 kg (1.3 lbs) each

Center speaker (SP-THC4C)

Speaker unit: 8.0 cm (3-3/16 inches)
1.5 cm (5/8 inches)
Bass-reflex, Magnetically Shielded

Power Handling Capacity: 170 W

Impedance: 3 Ω

Frequency Range: 80 Hz to 20 kHz

Dimensions (W × H × D): 137 mm × 105 mm × 104.5 mm
(5-7/16 inches × 4-3/16 inches × 4-1/8 inches)

Mass: 0.57 kg (1.3 lbs)

Surround speakers (SP-THC4S)

Speaker unit: 8.0 cm (3-3/16 inches)
Bass-reflex

Power Handling Capacity: 170 W

Impedance: 3 Ω

Frequency Range: 80 Hz to 20 kHz

Dimensions (W × H × D): 111.5 mm × 148 mm × 106.5 mm
(4-7/16 inches × 5-7/8 inches × 4-1/4 inches)

Mass: 0.56 kg (1.3 lbs) each

■ Satellite Speakers — SP-XTHC3

Front speakers (SP-THC3F)

Speaker unit: 8.0 cm (3-3/16 inches)
1.5 cm (5/8 inches)
Bass-reflex, Magnetically Shielded

Power Handling Capacity: 140 W

Impedance: 4 Ω

Frequency Range: 80 Hz to 20 kHz

Dimensions (W × H × D): 104.5 mm × 139 mm × 101 mm
(4-1/8 inches × 5-1/2 inches × 4 inches)

Mass: 0.56 kg (1.3 lbs) each

Center speaker (SP-THC3C)

Speaker unit: 8.0 cm (3-3/16 inches)
1.5 cm (5/8 inches)
Bass-reflex, Magnetically Shielded

Power Handling Capacity: 140 W

Impedance: 4 Ω

Frequency Range: 80 Hz to 20 kHz

Dimensions (W × H × D): 137 mm × 105 mm × 104.5 mm
(5-7/16 inches × 4-3/16 inches × 4-1/8 inches)

Mass: 0.57 kg (1.3 lbs)

Surround speakers (SP-THC3S)

Speaker unit: 8.0 cm (3-3/16 inches)
Bass-reflex

Power Handling Capacity: 140 W

Impedance: 4 Ω

Frequency Range: 80 Hz to 20 kHz

Dimensions (W × H × D): 111.5 mm × 148 mm × 106.5 mm
(4-7/16 inches × 5-7/8 inches × 4-1/4 inches)

Mass: 0.56 kg (1.3 lbs) each

Designs & specifications are subject to change without notice.

JVC COMPANY OF AMERICA (JVC) warrants this product and all parts thereof, except as set forth below ONLY TO THE ORIGINAL RETAIL PURCHASER to be FREE FROM DEFECTIVE MATERIALS AND WORKMANSHIP from the date of original purchase for the period shown below. ("The Warranty Period")

THIS LIMITED WARRANTY IS VALID ONLY IN THE FIFTY (50) UNITED STATES, THE DISTRICT OF COLUMBIA AND IN THE COMMONWEALTH OF PUERTO RICO.

WHAT WE WILL DO:

WHAT YOU MUST DO FOR WARRANTY SERVICE:

If you have any questions concerning /

WHAT IS NOT COVERED:

This limited warranty provided by JVC does not cover:

1. Products which have been subject to abuse, accident, alteration, modification, tampering, negligence, misuse, faulty installation, lack of reasonable care, or if repaired or serviced by anyone other than a service facility authorized by JVC to render such service, or if affixed to any attachment not provided with the products, or if the model or serial number has been altered, tampered with, defaced or removed;
2. Initial installation, installation and removal from cabinets or mounting systems.
3. Operational adjustments covered in the Owner's Manual, normal maintenance, video and audio head cleaning;
4. Damage that occurs in shipment, due to act of God, and cosmetic damage;
5. Signal reception problems and failures due to line power surge;
6. User Removal Memory Devices/Video Pick-up Tubes/CCD Image Sensors are covered for 90days from the date of purchase;
7. Accessories;
8. Batteries (except that Rechargeable Batteries are covered for 90 days from the date of purchase);
9. Products used for commercial purposes, including, but not limited to rental.
10. Loss of data resultant from malfunction of hard drive or other data storage device.

JVC COMPANY OF AMERICA
DIVISION OF JVC AMERICAS CORP.

1700 Valley Road
Wayne, NJ 07470

<http://www.jvc.com>

TO OUR VALUED CUSTOMER ———

THANK YOU FOR PURCHASING THIS JVC PRODUCT.

WE WANT TO HELP YOU

**NEED HELP ON HOW TO HOOK UP?
NEED ASSISTANCE ON HOW TO OPERATE?
NEED TO LOCATE A JVC SERVICE CENTER?
LIKE TO PURCHASE ACCESSORIES?**

JVC[®] IS HERE TO HELP!

————— **Do not attempt to service the product yourself** —————

Caution

To prevent electrical shock, do not open the cabinet.
There are no user serviceable parts inside.
Please refer to qualified service personnel for repairs.

JVC

Free Manuals Download Website

<http://myh66.com>

<http://usermanuals.us>

<http://www.somanuals.com>

<http://www.4manuals.cc>

<http://www.manual-lib.com>

<http://www.404manual.com>

<http://www.luxmanual.com>

<http://aubethermostatmanual.com>

Golf course search by state

<http://golfingnear.com>

Email search by domain

<http://emailbydomain.com>

Auto manuals search

<http://auto.somanuals.com>

TV manuals search

<http://tv.somanuals.com>