

JVC

English

DVD DIGITAL THEATER SYSTEM

TH-F3

Consists of XV-THF3, SP-THF3F and SP-THF3W

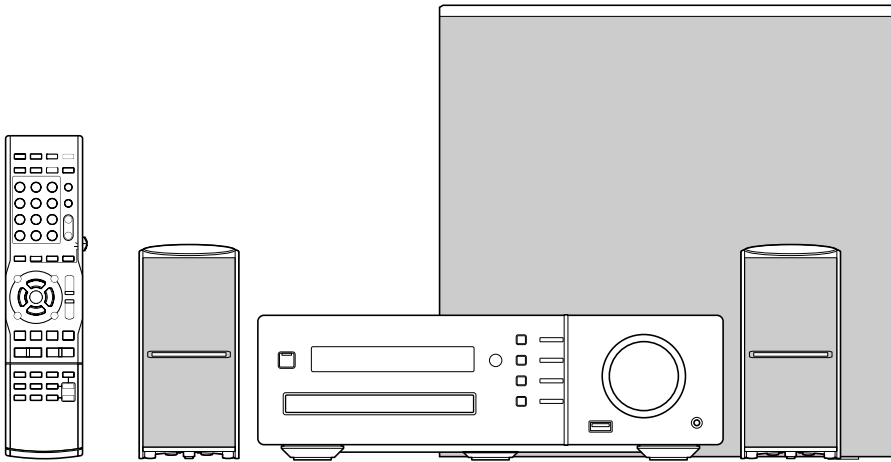

MPEG-4
ASF PLAYBACK

Digital Direct Progressive Scan

HDMI



INSTRUCTIONS

For Customer Use:

Enter below the Model No. and Serial No. which are located either on the rear, bottom or side of the cabinet. Retain this information for future reference.

Model No. _____







Serial No. _____

LVT1833-001A

[J, C]

Warnings, cautions and others

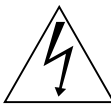
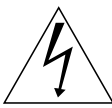
(For U.S.A.)

 CAUTION RISK OF ELECTRIC SHOCK DO NOT OPEN 	 ATTENTION RISQUE D'ÉLECTROCUTION NE PAS OUVRIR 
CAUTION: TO REDUCE THE RISK OF ELECTRIC SHOCK, DO NOT REMOVE COVER (OR BACK). NO USER-SERVICEABLE PARTS INSIDE. REFER SERVICING TO QUALIFIED SERVICE PERSONNEL.	ATTENTION: POUR ÉVITER TOUT RISQUE D'ÉLECTROCUTION, NE PAS OUVRIR LE BOÎTIER. AUCUNE PIÈCE INTÉRIEURE N'EST À RÉGLER PAR L'UTILISATEUR. SE RÉFÉRER À UN AGENT QUALIFIÉ EN CAS DE PROBLÈME.
 <p>The lightning flash with arrowhead symbol, within an equilateral triangle, is intended to alert the user to the presence of uninsulated "dangerous voltage" within the product's enclosure that may be of sufficient magnitude to constitute a risk of electric shock to persons.</p>	 <p>Le symbole de l'éclair à l'intérieur d'un triangle équilatéral est destiné à alerter l'utilisateur sur la présence d'une "tension dangereuse" non isolée dans le boîtier du produit. Cette tension est suffisante pour provoquer l'électrocution de personnes.</p>
 <p>The exclamation point within an equilateral triangle is intended to alert the user to the presence of important operating and maintenance (servicing) instructions in the literature accompanying the appliance.</p>	 <p>Le point d'exclamation à l'intérieur d'un triangle équilatéral est destiné à alerter l'utilisateur sur la présence d'opérations d'entretien importantes au sujet desquelles des renseignements se trouvent dans le manuel d'instructions.</p>

(For U.S.A.)

WARNING: TO REDUCE THE RISK OF FIRE OR ELECTRIC SHOCK, DO NOT EXPOSE THIS APPLIANCE TO RAIN OR MOISTURE.

(For U.S.A.)

INFORMATION

This equipment has been tested and found to comply with the limits for a Class B digital device, pursuant to part 15 of the FCC Rules. These limits are designed to provide reasonable protection against harmful interference in a residential installation.

This equipment generates, uses and can radiate radio frequency energy and, if not installed and used in accordance with the instructions, may cause harmful interference to radio communications. However, there is no guarantee that interference will not occur in a particular installation. If this equipment does cause harmful interference to radio or television reception, which can be determined by turning the equipment off and on, the user is encouraged to try to correct the interference by one or more of the following measures:

- Reorient or relocate the receiving antenna.
- Increase the separation between the equipment and receiver.
- Connect the equipment into an outlet on a circuit different from that to which the receiver is connected.
- Consult the dealer or an experienced radio/TV technician for help.

CAUTION

Changes or modifications not approved by JVC could void the user's authority to operate the equipment.

(For U.S.A.)

Note to CATV system installer:

This reminder is provided to call the CATV system installer's attention to Section 820-40 of the NEC which provides guidelines for proper grounding and, in particular, specifies that the cable ground shall be connected to the grounding system of the building, as close to the point of cable entry as practical.

For Canada/pour le Canada

THIS DIGITAL APPARATUS DOES NOT EXCEED THE CLASS B LIMITS FOR RADIO NOISE EMISSIONS FROM DIGITAL APPARATUS AS SET OUT IN THE INTERFERENCE-CAUSING EQUIPMENT STANDARD ENTITLED "DIGITAL APPARATUS", ICES-003 OF THE DEPARTMENT OF COMMUNICATIONS.

CET APPAREIL NUMERIQUE RESPECTE LES LIMITES DE BRUITS RADIOELECTRIQUES APPLICABLES AUX APPAREILS NUMIRIQUES DE CLASSE B PRESCRITES DANS LA NORME SUR LE MATERIEL BROUILLEUR: "APPAREILS NUMERIQUES", NMB-003 EDICTEE PAR LE MINISTRE DES COMMUNICATIONS.

CAUTION

To reduce the risk of electrical shocks, fire, etc.:

1. Do not remove screws, covers or cabinet.
2. Do not expose this appliance to rain or moisture.

ATTENTION

Afin d'éviter tout risque d'électrocution, d'incendie, etc.:

1. Ne pas enlever les vis ni les panneaux et ne pas ouvrir le coffret de l'appareil.
2. Ne pas exposer l'appareil à la pluie ni à l'humidité.

CAUTION — ϕ/I button!

Disconnect the mains plug to shut the power off completely (the STANDBY lamp goes off). When installing the apparatus, ensure that the plug is easily accessible.

The ϕ/I button in any position does not disconnect the mains line.

- When the system is on standby, the STANDBY lamp lights red.
 - When the system is turned on, the STANDBY lamp goes off.
- The power can be remote controlled.

ATTENTION — Touche ϕ/I !

Déconnectez la fiche secteur pour mettre l'appareil complètement hors tension (le témoin STANDBY s'éteint). Lors de l'installation de l'appareil, assurez-vous que la fiche soit facilement accessible.

La touche ϕ/I , dans n'importe quelle position, ne déconnecte pas le système du secteur.

- Quand le système est en attente, le témoin STANDBY est allumé en rouge.
- Quand le système est sous tension, le témoin STANDBY s'éteint.

L'alimentation peut être télécommandée.

CAUTION

- Excessive sound pressure from earphones or headphones can cause hearing loss.

ATTENTION:

- Une pression acoustique excessive des écouteurs ou du casque d'écoute peut entraîner une perte auditive.

**IMPORTANT FOR LASER PRODUCTS /
IMPORTANT POUR PRODUITS LASER**

1. CLASS 1 LASER PRODUCT
 2. **CAUTION:** Do not open the top cover or cabinet. There are no user serviceable parts inside the unit; leave all servicing to qualified service personnel.
 3. **CAUTION:** Visible and/or invisible class 1M laser radiation when open. Do not view directly with optical instruments.
 4. REPRODUCTION OF LABEL: CAUTION LABEL, PLACED INSIDE THE UNIT.
1. PRODUIT LASER CLASSE 1
 2. **ATTENTION:** N'ouvrez pas le couvercle supérieur ni le coffret de l'appareil. Il n'y a aucune pièce réparable par l'utilisateur à l'intérieur de l'appareil; confiez toute réparation à un personnel qualifié.
 3. **ATTENTION:** Rayonnement laser visible et/ou invisible de classe 1M une fois ouvert. Ne pas regarder directement dans le faisceau avec des instruments optiques.
 4. REPRODUCTION DE L'ÉTIQUETTE: ÉTIQUETTE DE PRÉCAUTION PLACÉE À L'INTERIEUR DE L'APPAREIL.

CAUTION VISIBLE AND/OR INVISIBLE CLASS 1M LASER RADIATION WHEN OPEN. DO NOT VIEW DIRECTLY WITH OPTICAL INSTRUMENTS. IEC60825-1:2001 (ENG)	ATTENTION RAYONNEMENT LASER VISIBLE ET/OU INVISIBLE DE CLASSE 1M UNE FOIS OUVERT. NE PAS REGARDER DIRECTEMENT AVEC DES INSTRUMENTS OPTIQUES. (FRA)	AVISO RADIACIÓN LASER DE CLASE 1M VISIBLE Y/O INVISIBLE CUANDO ESTA ABIERTO. NO MIRAR DIRECTAMENTE CON INSTRUMENTAL ÓPTICO. (ESP)	VARNING SYNLIG OCH/ELLER OSYNLIG LASERSTRÅLNING, KLASS 1M, NÄR DENNA DEL ÄR ÖPPNAD. BETRÄKTA EJ STRÅLEN MED OPTISKA INSTRUMENT. (SWE)	注意 ここを開くと可視 及び/または不可視 のクラス1M レーザー放射が 出ます。 光学装置で直接 見ないでください。 (JPN)	CAUTION VISIBLE AND/OR INVISIBLE CLASS 1 LASER RADIATION WHEN OPEN. DO NOT STARE INTO BEAM. FDA 21 CFR (ENG) LV44603-003A
--	--	---	---	--	--

CAUTION

- Do not block the ventilation openings or holes.
(If the ventilation openings or holes are blocked by a newspaper or cloth, etc., the heat may not be able to get out.)
- Do not place any naked flame sources, such as lighted candles, on the apparatus.
- When discarding batteries, environmental problems must be considered and local rules or laws governing the disposal of these batteries must be followed strictly.
- Do not expose this apparatus to rain, moisture, dripping or splashing and that no objects filled with liquids, such as vases, shall be placed on the apparatus.

ATTENTION

- Ne bloquez pas les orifices ou les trous de ventilation.
(Si les orifices ou les trous de ventilation sont bloqués par un journal un tissu, etc., la chaleur peut ne pas être évacuée correctement de l'appareil.)
- Ne placez aucune source de flamme nue, telle qu'une bougie, sur l'appareil.
- Lors de la mise au rebut des piles, veuillez prendre en considération les problèmes de l'environnement et suivre strictement les règles et les lois locales sur la mise au rebut des piles.
- N'exposez pas cet appareil à la pluie, à l'humidité, à un égouttement ou à des éclaboussures et ne placez pas des objets remplis de liquide, tels qu'un vase, sur l'appareil.

CAUTION — Proper Ventilation

To avoid risk of electric shock and fire and to protect from damage, locate the apparatus as follows:

Top/Front/Back/Sides: No obstructions should be placed in the areas shown by the dimensions below.

Bottom: Place on the level surface. Maintain adequate air path for ventilation by placing on a stand with a height of 10 cm more.

In addition, maintain the best possible air circulation.

Attention: Ventilation correcte

Pour éviter tout risque d'électrocution et d'incendie, et pour ne pas endommager les appareils, placez-les de la façon suivante:

Faces supérieure /avant / arrière / côtés : Aucune obstruction ne doit se trouver dans les zones indiquées par les dimensions ci-dessous.

Bas : Placez l'appareil sur une surface plane. Maintenez une entrée d'air adéquate pour la ventilation en plaçant l'appareil sur un support avec une hauteur d'au moins 10 cm.

De plus, maintenez la meilleure circulation d'air possible.

Front view of the main unit and speakers (XV-THF3 and SP-THF3F)

Vue avant de l'unité principale et des haut-parleurs (XV-THF3 et SP-THF3F)

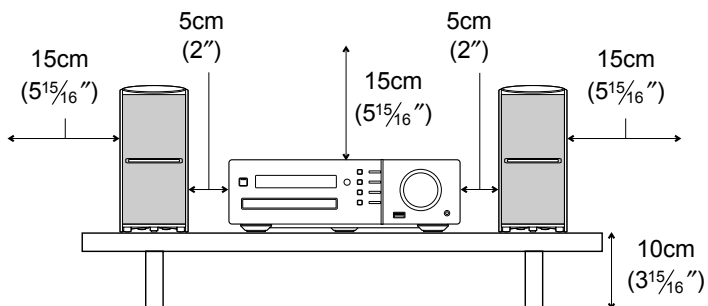

Side view of the main unit (XV-THF3)

Vue latérale de l'unité principale (XV-THF3)

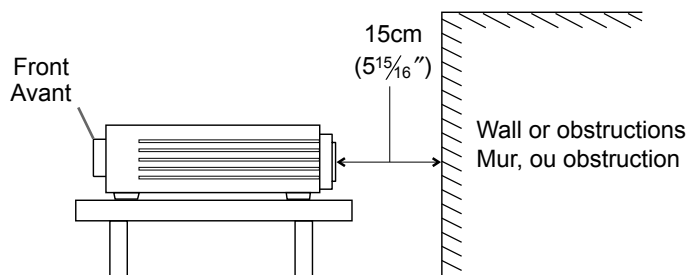

CAUTION

- Battery shall not be exposed to excessive heat such as sunshine, fire or the like.

PRECAUTION

- Les piles ne doivent en aucun cas être exposées à une chaleur excessive (lumière du soleil, feu, etc.).



[European Union only]

[Union européenne seulement]

Table of contents

Thank you for purchasing a JVC product.

Please read all instructions carefully before operation, to ensure your complete understanding and to obtain the best possible performance from the unit.

Introduction

Part description 3

Using the remote control 4

- Inserting the batteries into the remote control 4
- Operating the system from the remote control 4

Preparation

Preparation 5

- Connecting the antennas 5
- Connecting the speakers and subwoofer 6
- Connecting the docking station for iPod 7
- Connecting a TV 8
- Connecting external digital audio devices 9
- Connecting external analog audio devices 9
- Connecting the power cable 9
- Selecting the video signal type 10

Basic operations

Basic operations 11

- Using the number buttons 11
- Turning on/off the main unit 11
- Adjusting the volume 12
- Turning off the sound temporarily 12
- Adjusting the treble/bass 12
- Adjusting the volume level for surround/subwoofer sound 12
- Selecting the surround mode 12
- Selecting the headphone surround mode 13
- Sharpening the voice sound 13
- Selecting the surround volume level 13
- Using the sleep timer 14
- Changing the brightness of the display window 14
- Locking disc ejection 14

Listening to radio broadcasts

Listening to radio broadcasts 15

- Selecting a radio station 15
- Tuning in to a preset radio station 16

Playing back sources from external devices

Playing back sources from external devices 17

- Playing back sources from external devices 17
- Selecting the signal gain 17

Basic operations of disc/file playback

Basic operations of disc/file playback 18

- Playing back a disc 18
- Playing back a file 19
- Display window on the main unit for disc/file types 20
- Stopping playback 25
- Resuming playback 25
- Pausing playback 25
- Advancing the picture frame by frame 25
- Fast reverse/fast forward search 26
- Playing back from a position 10 seconds before 26
- Slow motion playback 26
- Skipping to the beginning of a chapter/track/file 27
- Selecting a chapter/track using the number buttons 27
- Skipping at approximately 5 minute intervals 27
- Selecting a chapter/track from the menu screen 28

Convenient functions of disc/file playback

Convenient functions of disc/file playback	29
Playing back a disc/file in the desired order (Program playback)	29
Playing back a disc/file in a random order (Random playback)	31
Playing back a disc/file repeatedly (Repeat playback)	31
Selecting the audio language and subtitle language	32
Magnifying the picture	32
Adjusting the picture quality (VFP)	33
Playing back the bonus group	34
Using the status bar and the menu bar	35
Playing back a specified part repeatedly (A-B repeat playback)	37
Designating the time (Time search)	37
Changing the initial settings with the preference screen	38
Basic operations	38
LANGUAGE	38
PICTURE	39
AUDIO	40
OTHERS	40
Language codes	42

Playing back sound from an iPod

Playing back sound from an iPod	43
Playing back sound from an iPod	43
Operating the iPod using the remote control	44
Changing the time when the backlight turns on	45
Charging the battery of the connected iPod	45
Notes on an iPod	45

Operating external devices using the remote control

Operating external devices using the remote control	46
Operating a TV using the remote control	46
Operating a DBS using the remote control ...	47
Operating a VCR using the remote control ...	48

Basic operations of HDMI CEC

Basic operations of HDMI CEC ...	50
---	-----------

Reference

Notes on operation	51
Suitable locations for the main unit	51
Condensation	51
Cleaning the main unit	51
Notes on handling	51
License and trademark	52
Notes on discs/files	53
Playable disc/file types	53
Data hierarchy	56
Handling discs	56
Troubleshooting	57
Specifications	61
Main unit (XV-THF3)	61
Speaker (SP-THF3F)	61
Subwoofer (SP-THF3W)	61
Supplied accessories	61

How to read this manual

- This manual explains the operations assuming that you will use the remote control. Some buttons on the main unit are the same as those on the remote control. You can use either button in this case.
- Some diagrams in this manual are simplified or exaggerated for the purpose of explanation.
- You can operate some functions differently from the explanation given in this manual.
- Depending on the disc/file, you may not obtain the explained result even after following the operation in this manual.
- The following marks refer to the usable discs/files for the explained function.



Part description

The numbers refer to the pages in which the parts are explained.

Front view

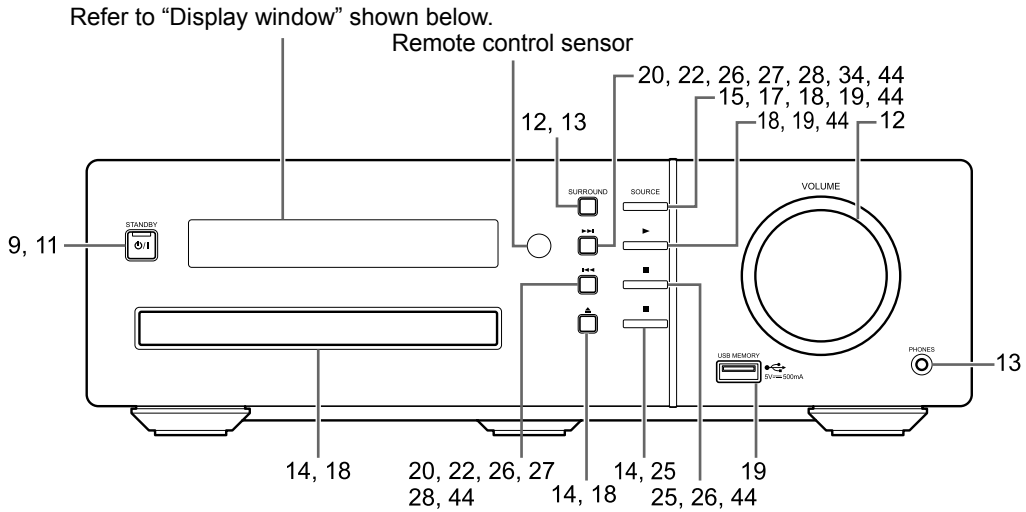

Rear view

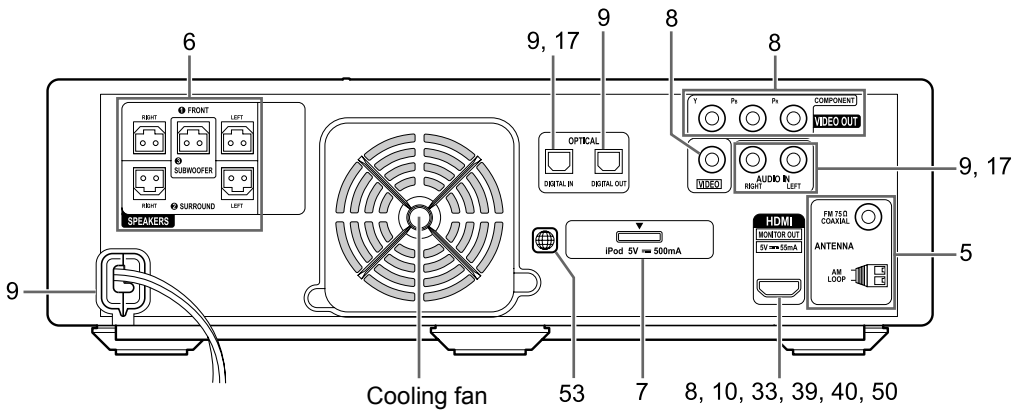

Display window

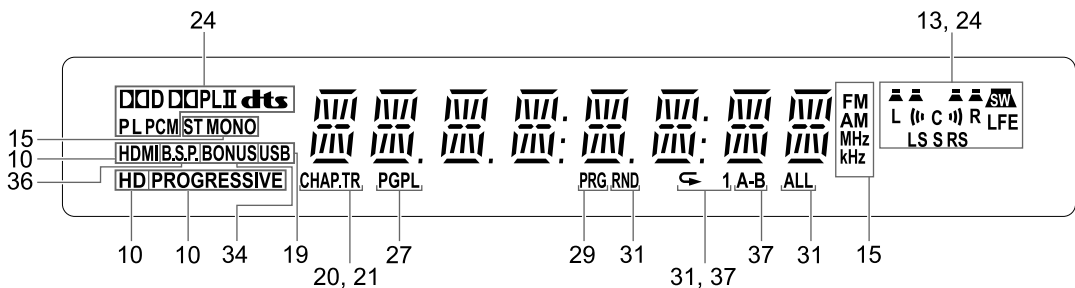

Using the remote control

The numbers refer to the pages in which the parts are explained.

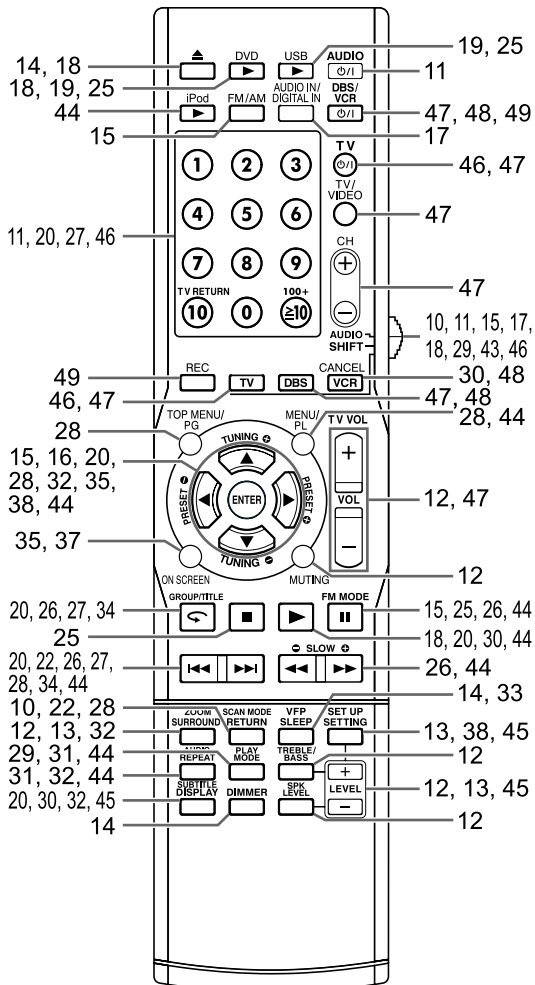

Inserting the batteries into the remote control

Insert the batteries into the remote control by matching the polarity (+ and -) correctly.

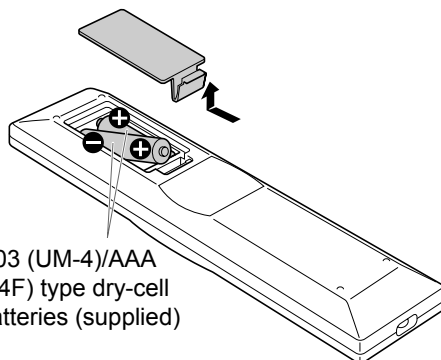

R03 (UM-4)/AAA (24F) type dry-cell batteries (supplied)

- If the range or effectiveness of the remote control decreases, replace both batteries.

Operating the system from the remote control

Point the remote control directly at the front of the main unit.

- Do not block the remote control sensor on the main unit.

Preparation

Do not connect the power cable until all other connections have been made.

Connecting the antennas

AM loop antenna (supplied)

Setting up the AM loop antenna

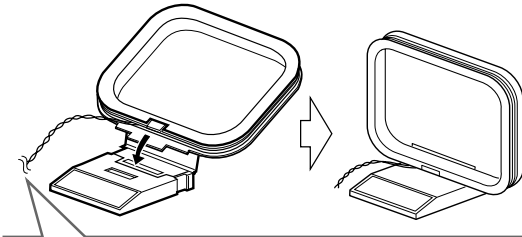

If insulation covers the tips of the antenna cable, twist and pull off the insulation.

NOTE

- Keep the AM loop antenna cable wrapped around the AM loop antenna frame, otherwise the effectiveness and sensitivity of the AM loop antenna may be reduced.

Connecting the AM loop antenna

Main unit (rear view)

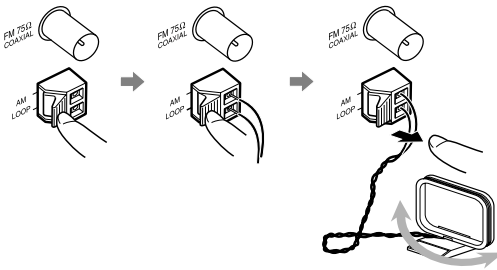

Turn the AM loop antenna to find the best position for radio reception.

NOTE

- Make sure that the antenna conductors do not touch any other terminals. This could cause poor reception.

FM antenna (supplied)

Main unit (rear view)

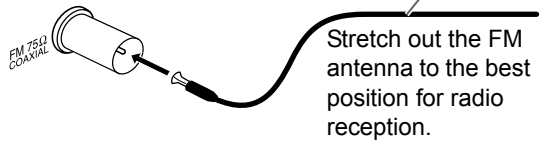

When radio reception with the supplied FM antenna is poor, or when using a communal antenna

Main unit (rear view)

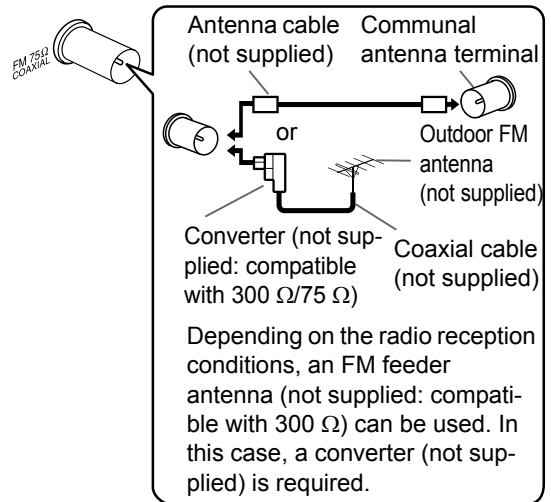

- When using an antenna other than those supplied with this system, refer to the operation manuals for the antenna and converter for details of connection.
- When positioning the antennas, find the best position for reception while listening to an actual radio program (refer to "Listening to radio broadcasts" on page 15).
- You cannot receive an FM/AM radio broadcast without the antenna connection.

Connecting the speakers and subwoofer

Connect the speakers to the main unit by connecting the colored connectors to the same color terminals on the rear of the main unit.

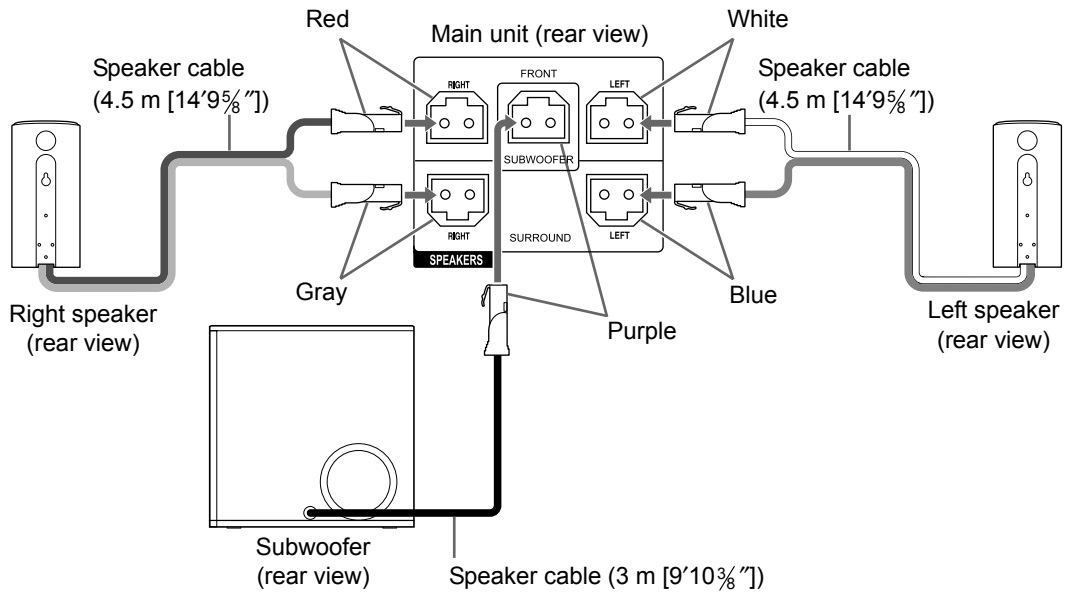

■ IMPORTANT

- Improper speaker cable connection reduces the stereo effect and sound quality.
 - The supplied left/right speakers are magnetically shielded, but color irregularity may occur on the TV depending on some conditions. To prevent color irregularity, set up the speakers following the instructions below.
(The subwoofer is not magnetically shielded.)
1. Turn off the main power of the TV before setting up the speakers.
 2. Place the speakers enough distance from the TV so that they do not cause color irregularity on the TV.
 3. Wait for approximately 30 minutes before turning on the main power of the TV again.

CAUTION

- The supplied speakers are manufactured exclusively for use with the supplied main unit as parts of this system. Do not connect the supplied speakers to devices other than the supplied main unit. Doing so may damage the speakers.
- Do not connect external speakers together with the supplied speakers. The change in impedance may damage the main unit and the speakers.

Using the speakers with commercially available speaker stands

The left and right speakers can be fitted onto commercially available speaker stands. Before fitting the speakers onto commercially available speaker stands, remove the speaker cables from the tabs and slots on the speakers.

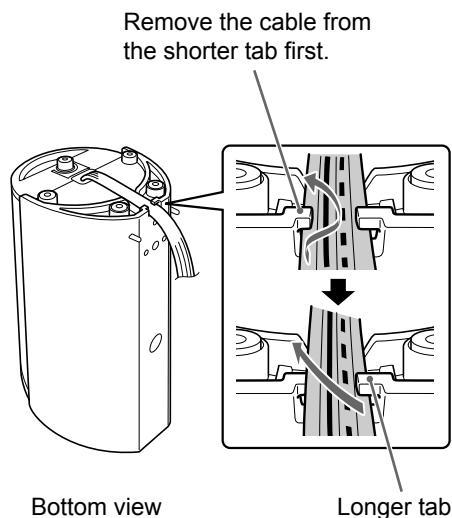

CAUTION

- The left and right speakers can be installed on a wall.
- When installing the speakers on a wall, be sure to have the speakers installed by qualified personnel.
- DO NOT install the speakers on the wall by yourself to avoid unexpected damage from them falling off the wall due to incorrect installation or weakness in wall structure.
- Care must be taken in selecting a location for speaker installation on a wall. Injury to personnel or damage to devices may result if the installed speakers interfere with daily activities.

Speaker layout

This system is designed to provide virtual surround sound by positioning the 3 speakers in front. (The set of the left and right speakers and the subwoofer refers to 2.1 channel.) The front surround function processes input signals to create a realistic sound field.

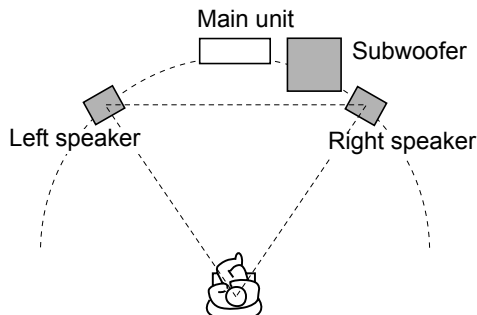

Connecting the docking station for iPod

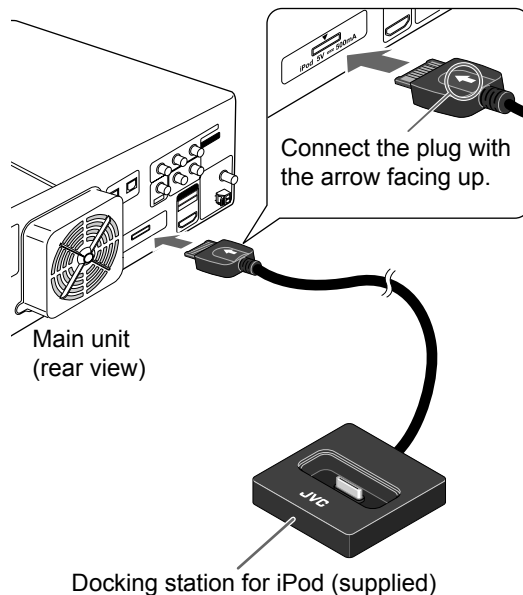

CAUTION

- Do not touch the pins of the [iPod] terminal on the rear of the main unit or the pins of the docking station for iPod.
- Do not carry the main unit with the docking station for iPod connected. You may drop them and damage the connector part.

Connecting a TV

After connecting a TV, follow the instructions on page 10.

■ IMPORTANT

- Connect the main unit directly to a TV (or a monitor) without routing through a video cassette recorder (VCR). Otherwise picture distortion may occur during playback. (Routing the connection through a VCR, however, does not affect the audio quality.)

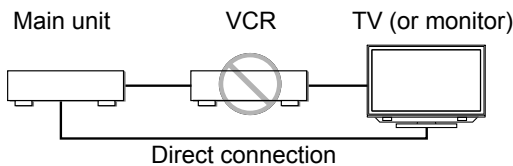

- Connecting the main unit to a VCR-built-in-TV may also cause picture distortion during playback.

Connecting a TV with the [VIDEO] terminal

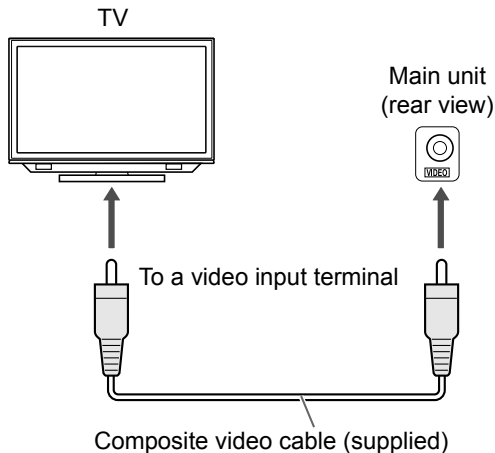

Connecting a TV with the [COMPONENT] terminals

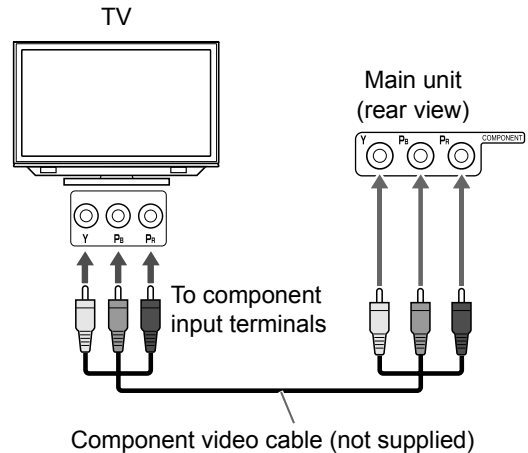

Connecting a TV with the [HDMI MONITOR OUT] terminal

This system can output uncompressed digital video signals to a TV compatible with HDMI (High Definition Multimedia Interface).

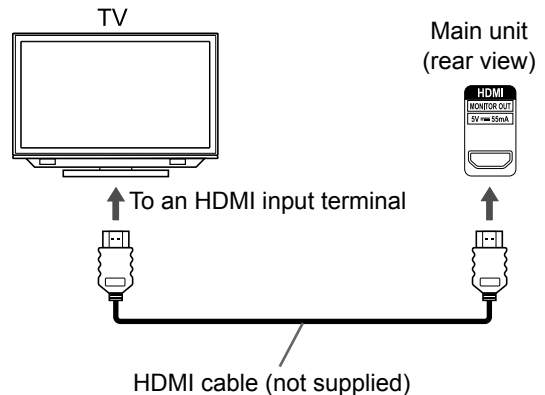

NOTE

- The HDMI video signal type can be checked with the "HDMI" indicator in the display window. (Refer to "Selecting the video signal type" on page 10.)
- If the picture is distorted while an HDMI TV is connected, turn off the main unit and turn it on again.
- A TV compatible with HDCP (High-Bandwidth Digital Content Protection) can also be connected to the [HDMI MONITOR OUT] terminal, so that the uncompressed HD video signal type can be output as well.
- This system is compatible with some basic functions of HDMI CEC. (Refer to page 50.)

Connecting external digital audio devices

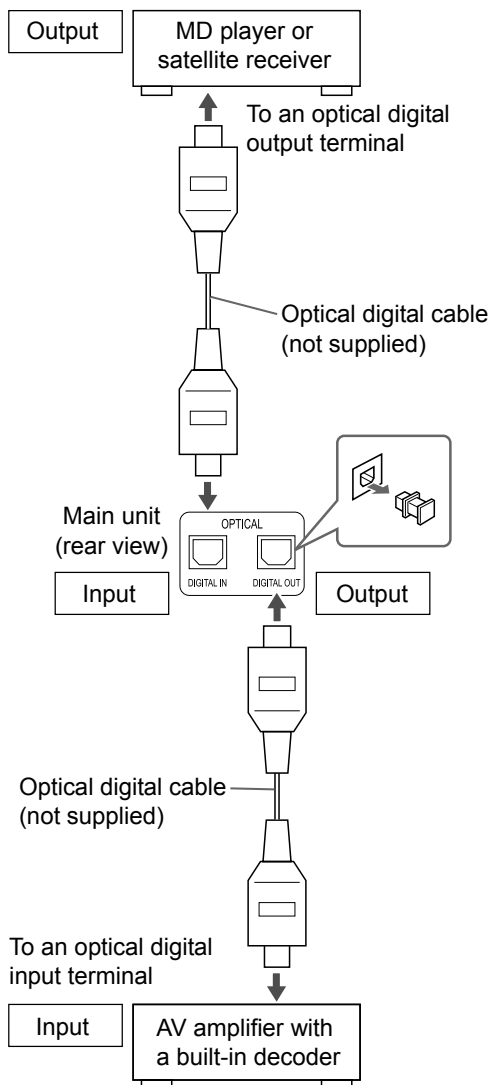

NOTE

- You can output the audio signal from the [DIGITAL OUT] terminal when "DVD", "USB" or "DGTL IN" is selected as the source in the display window.
- When "DGTL IN" is selected as the source in the display window, digital audio from the [DIGITAL OUT] terminal is decoded to a linear PCM signal.

Connecting external analog audio devices

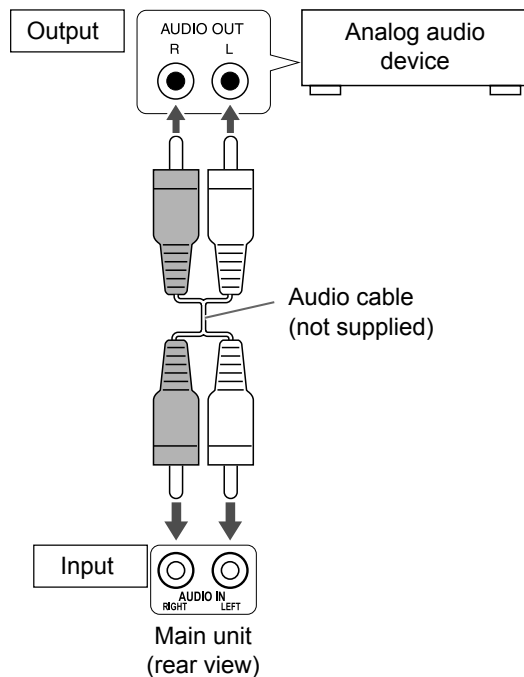

Connecting the power cable

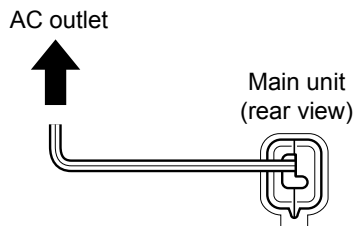

- Connect the power cable after you complete the other connections.
- The [STANDBY ϕ /I] lamp on the main unit lights up.

Selecting the video signal type

To view an image on the TV screen, select the video signal type correctly according to the TV after connecting the main unit to the TV.

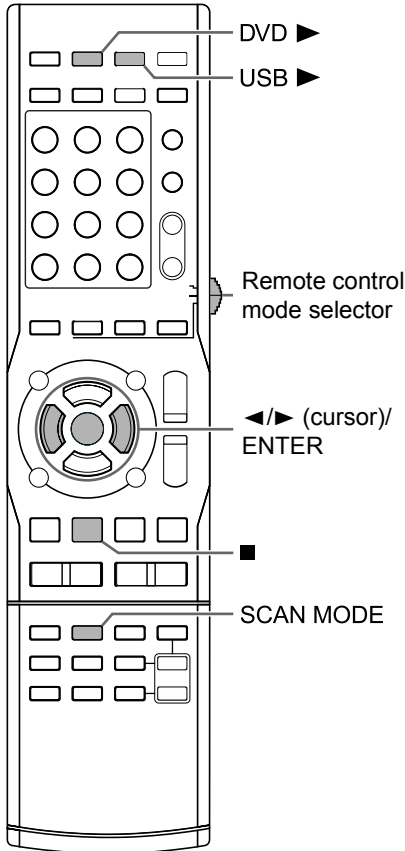

■ IMPORTANT

- Slide the remote control mode selector to [SHIFT].

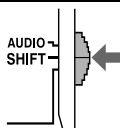

1 Turn on the main unit.

- Refer to "Turning on/off the main unit" on page 11.

2 Press [DVD ▶] or [USB ▶].

- When a disc is loaded or a USB device is connected, press ■ to stop playback.

3 Press [SCAN MODE].

- The current video signal type appears.

Example: When "480I" is selected as the video signal

480I

4 Press ◀ or ▶ (cursor) to select the video signal type suitable for the TV.

- When the TV is connected to the [VIDEO] terminal, select "480I".
- When the TV is connected to the [COMPONENT] terminals, select "480P". (If the TV is not compatible with a progressive video signal, select "480I".)
- When the TV is connected to the [HDMI MONITOR OUT] terminal, the video signal type can be selected as instructed below.
 - Select "AUTO" for normal usage. (the initial setting)
 - Select "480P", "720P", "1080I" or "1080P" as needed. (The selectable settings differ according to the resolution of the connected TV.)
- You can also select the video signal type by repeatedly pressing [SCAN MODE].

NOTE

- "480", "720" and "1080" refer to the number of the scanning lines. Generally, the larger the number, the better picture that can be obtained.
- "I" refers to the interlaced format. "P" refers to the progressive format. A better picture can be obtained in the progressive format than in the interlaced format.
- When an HDMI video signal is output, the "HDMI" indicator lights up in the display window.
- When an HD video signal is output, the "HD" indicator lights up.
- When "480P", "720P" or "1080P" is selected, the "PROGRESSIVE" indicator lights up in the display window.

5 Press [ENTER].

NOTE

- It is recommended that you slide the remote control mode selector to [AUDIO] after selecting the video signal type. Most of the other functions can be used when the remote control mode selector is at [AUDIO].
- To check the compatibility of your TV, contact your local JVC customer service center.
- Even if the main unit is turned off, the video signal type setting is stored.

Basic operations

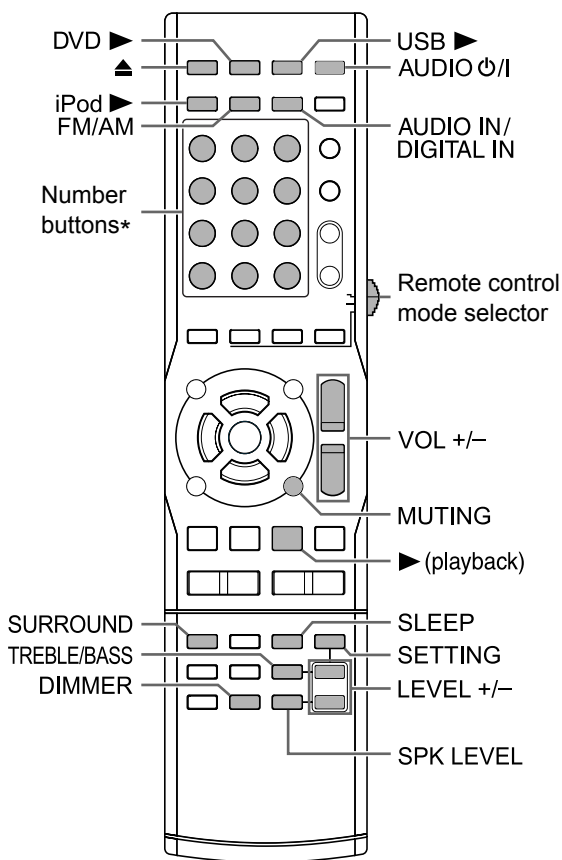

■ IMPORTANT

- Slide the remote control mode selector to [AUDIO].

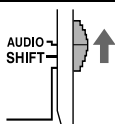

Using the number buttons

Examples:

5: [5]

15: [\cong 10] → [1] → [5]

150: [\cong 10] → [\cong 10] → [1] → [5] → [0]

Turning on/off the main unit

Press [AUDIO ϕ /I] (or [STANDBY ϕ /I] on the main unit).

- The power of the main unit turns on and the [STANDBY ϕ /I] lamp (button) on the main unit turns off.
- Press [AUDIO ϕ /I] (or [STANDBY ϕ /I] on the main unit) again to turn off the power of the main unit. (The main unit enters the standby mode.)
- With the power off, pressing any of the following buttons also turns on the main unit.
 - [DVD \blacktriangleright], [USB \blacktriangleright], [iPod \blacktriangleright], [FM/AM], [AUDIO IN/DIGITAL IN], \blacktriangleright (playback) or \blacktriangle on the remote control
 - \blacktriangleright (playback) or \blacktriangle on the main unit

The function assigned to the pressed button starts working at the same time. (When \blacktriangleright (playback) is pressed, "DVD" is selected as the source in the display window.)

- An internal cooling fan turns on when the main unit turns on. This is to prevent overheating of the main unit. The cooling fan produces noise during operation. This is not a malfunction.

Adjusting the volume

Press [VOL +] or [VOL -] repeatedly.

- You can also adjust the volume by turning the [VOLUME] control on the main unit.

Turning off the sound temporarily

Press [MUTING].

- Press [MUTING] again or [VOL +] or [VOL -], or turn the [VOLUME] control on the main unit to restore the sound. The sound is also restored when the main unit is turned off once and turned on.

Adjusting the treble/bass

- 1 Press [TREBLE/BASS] repeatedly to select “TRE” or “BASS” in the display window.
- 2 Press [LEVEL +] or [LEVEL -] repeatedly to adjust the sound quality.
 - Adjustable sound quality is from -10 to +10.

Adjusting the volume level for surround/subwoofer sound

You can adjust the volume level for the left and right surround sound and the subwoofer sound respectively.

- 1 Press [SPK LEVEL] repeatedly to select “SURR” or “SUBWFR” in the display window.
 - “SURR” refers to the left and right surround sound.
 - “SUBWFR” refers to the subwoofer sound.
- 2 Press [LEVEL +] or [LEVEL -] repeatedly to adjust the volume level.
 - The adjustable volume range is from -6 to +6.

Selecting the surround mode

Press [SURROUND].

- Each time you press [SURROUND], the display changes in the display window as follows.
 - “AUTO SUR”
When a multi-channel signal is input, surround sound is automatically produced.
 - “MOVIE”
Surround sound suitable for a movie or multi-channel signal is produced.
 - “WIDE/2CH”
When a 2ch signal is input, surround sound is produced. The sound is broader than the one with “MOVIE”.
 - “SUPER W”
Surround sound broader than the one with the “WIDE/2CH” is produced.

NOTE

- Depending on the signal type, surround sound may not be produced as the surround mode setting.
- During playback, when you change the surround mode setting, sound from the [DIGITAL OUT] terminal may be intermittent. Before recording sound to an external device, select the desired surround mode setting.
- This function does not work for a JPEG/ASF/DivX/MPEG1/MPEG2 file.

Selecting the headphone surround mode

You can listen to surround sound via headphones connected to the [PHONES] terminal.

- When headphones are connected to the [PHONES] terminal

Press [SURROUND].



H.P. SURR

- Each time you press [SURROUND], the setting toggles between “H.P. SURR” and “H.PHONE” in the display window.

NOTE

- The [PHONES] terminal is for connecting a pair of headphones equipped with a stereo mini plug (not supplied). When headphones are connected, no sound is output from the speakers.
- This function does not work for a JPEG/ASF/DivX/MPEG1/MPEG2 file.

Sharpening the voice sound

This function allows you to easily understand dialog recorded on the disc/file even with the volume down low. This function is useful when you are watching a movie.

1 Press [SETTING] repeatedly to select “CLR VOIC” in the display window.

- “CLR VOIC” refers to a clear voice.

2 Press [LEVEL +] or [LEVEL –] repeatedly to select “CLR: ON” in the display window.

This indicator lights up when the clear voice function is activated.



- Each time you press [LEVEL +] or [LEVEL –], the clear voice function turns on and off.
- When you want to deactivate the clear voice function, select “CLR: OFF”.

Selecting the surround volume level

You can increase the surround volume level. This function is effective for the following conditions:

- (1) When the surround mode is set to an item other than “AUTO SUR” (Refer to page 12.)
- (2) When the surround mode is set to “AUTO SUR” and a DVD VIDEO, DVD AUDIO or DVD VR is played back (Refer to page 18.)
- (3) When the surround mode is set to “AUTO SUR” and the source is set to “DGTL IN” (Refer to page 17.)

1 Press [SETTING] repeatedly to select “SURR VOL” in the display window.

2 Press [LEVEL +] or [LEVEL –] repeatedly to select the desired setting in the display window.

- Each time you press [LEVEL +] or [LEVEL –], the surround volume level display changes to one of three levels. The surround volume level increases in the order of “SURR: NRML”, “SURR: MID” and “SURR: HIGH”.
- Select the surround volume level while listening to the actual sound to confirm the difference.



SURR: NRML

NOTE

- This function does not affect the sound with the headphone surround mode.

Using the sleep timer

When the time you specify elapses, the main unit automatically turns off.

Press [SLEEP].

- Each time you press [SLEEP], the time indicated in the display window changes. You can set the time to 10, 20, 30, 60, 90, 120, 150 or 180 minutes.

Example: Display when the sleep timer is set to 60 minutes

S L E E P 6 0

Changing the remaining time

Press [SLEEP] repeatedly to select the time again.

Confirming the remaining time

Press [SLEEP] once.

Canceling the sleep timer

Press [SLEEP] repeatedly until "SLEEP --" appears.

Turning off the main unit cancels the sleep timer.

Changing the brightness of the display window

■ When the main unit is turned on

Press [DIMMER] repeatedly.

- Each time you press [DIMMER], the brightness changes in 3 levels.

Locking disc ejection

You can lock the disc tray to prevent the disc from being ejected.

Setting the disc ejection lock

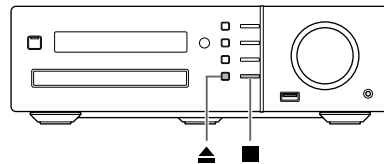

■ When the main unit is turned off

Hold down ▲ on the main unit for one or more seconds while holding down ■ on the main unit.

L O C K E D

If you attempt to open the disc tray by pressing ▲, the disc tray does not open and "LOCKED" appears in the display window.

To cancel the disc ejection lock, press ▲ on the main unit while holding down ■ on the main unit again. "UNLOCKED" is displayed in the display window.

Listening to radio broadcasts

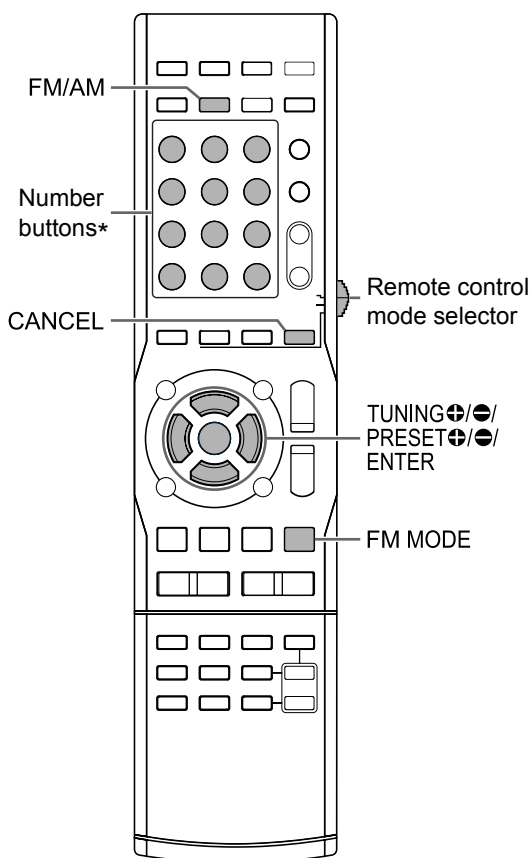

* For the number button usage, refer to "Using the number buttons" on page 11.

■ IMPORTANT

- Slide the remote control mode selector to [AUDIO].

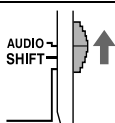

Selecting a radio station

1 Press [FM/AM] to select "FM" or "AM" in the display window.

- Pressing [FM/AM] selects a radio broadcast as the sound source.
- Repeatedly pressing [SOURCE] on the main unit can also select a radio broadcast as the source.
- Each time you press [FM/AM], the band toggles between "FM" and "AM".

Example: When an FM radio broadcast is received

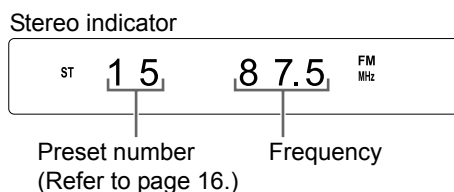

2 Press [TUNING +] or [TUNING -] repeatedly to select a radio station (frequency).

- When the main unit has received an FM stereo broadcast, the "ST" (stereo) indicator lights up in the display window.

■ Automatic tuning:

You can also select a radio station using automatic tuning.

Hold down [TUNING +] or [TUNING -] until the frequency starts changing, and then release the button.

- When the main unit has received a broadcast, the frequency automatically stops changing.
- You can select a specific radio station while searching for a broadcast. Press [TUNING +] or [TUNING -] to stop automatic tuning when the desired frequency appears in the display window.

NOTE



- If an FM stereo broadcast is difficult to hear because of noise, you may be able to hear the broadcast more easily by pressing [FM MODE] to switch the sound to monaural reception. In this case, the "MONO" (monaural) indicator lights up in the display window. To return the sound to stereo reception, press [FM MODE] again. "AUTO" is displayed and the "ST" (stereo) indicator lights up in the display window.

Tuning in to a preset radio station

Presetting radio stations in the main unit allows you to easily tune in to a radio station.

■ Presetting radio stations

You can store up to 30 FM radio stations and up to 15 AM radio stations.

- 1 Select a radio station you want to store.**
 - Refer to “Selecting a radio station” on page 15.
- 2 Press [ENTER].**
 - “--” flashes in the display window for approximately 5 seconds.
- 3 While “--” is flashing, press the number buttons to select the preset number you want to assign.**
 - You can also select the preset number by pressing [PRESET ] or [PRESET .
- 4 Press [ENTER] while the selected number is flashing.**
 - “STORED” appears and the selected radio station is stored.



NOTE

- When you store a radio station to a preset number to which another radio station has previously been stored, the newly set radio station replaces the previously stored radio station.

■ Tuning in to a preset radio station

- When an FM or AM radio broadcast is selected as the source

Press the number buttons to select the preset number of the radio station to which you want to tune in.

- You can also select the preset number by pressing [PRESET ] or [PRESET .

Playing back sources from external devices

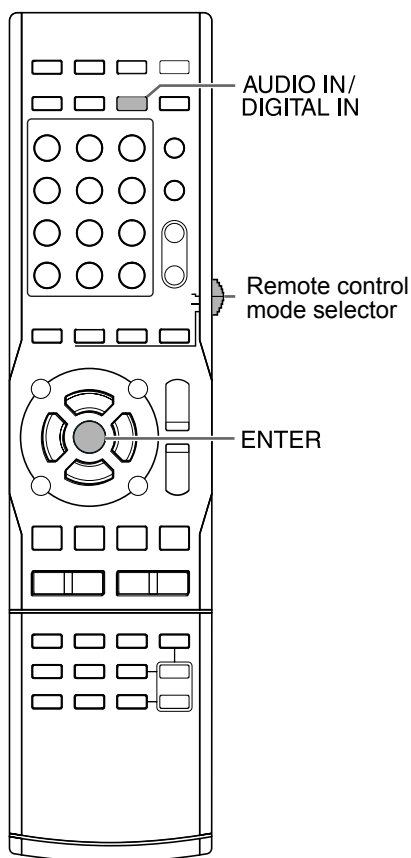

Playing back sources from external devices

- 1 Press [AUDIO IN/DIGITAL IN].**
 - Each time you press [AUDIO IN/DIGITAL IN], the display changes to “AUDIO IN” or “DGTL IN” in the display window.
 - “AUDIO IN” is for selecting the device connected to the [AUDIO IN] terminals.
 - “DGTL IN” is for selecting the device connected to the [DIGITAL IN] terminal.
 - You can also select the connected device as the source by repeatedly pressing [SOURCE] on the main unit.
- 2 Start playback on the connected device.**
- 3 Adjust the volume or the sound quality for your preference.**
 - Refer to page 12.

NOTE

- Refer also to the operation manual for the connected device.
- You can also operate your digital broadcast satellite and video cassette recorder using the remote control of this system. Refer to pages 47-49.

■ IMPORTANT

- Slide the remote control mode selector to [AUDIO].

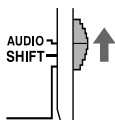

Selecting the signal gain

You can select the gain of the signal from the [AUDIO IN] terminals. Use the initial settings for normal operation. If the sound is too small or too loud, change the settings.

- 1 Press [AUDIO IN/DIGITAL IN] repeatedly to select “AUDIO IN” in the display window.**
- 2 Hold down [ENTER].**
 - “LEVEL 1” or “LEVEL 2” appears in the display window.
- 3 Press [ENTER] repeatedly to select “LEVEL 1” or “LEVEL 2”.**
 - Each time you press [ENTER], the display toggles between “LEVEL 1” and “LEVEL 2”.
 - The signal gain in “LEVEL 1” is lower than that in “LEVEL 2”.
 - The display returns to “AUDIO IN” in approximately 5 seconds.

Basic operations of disc/file playback

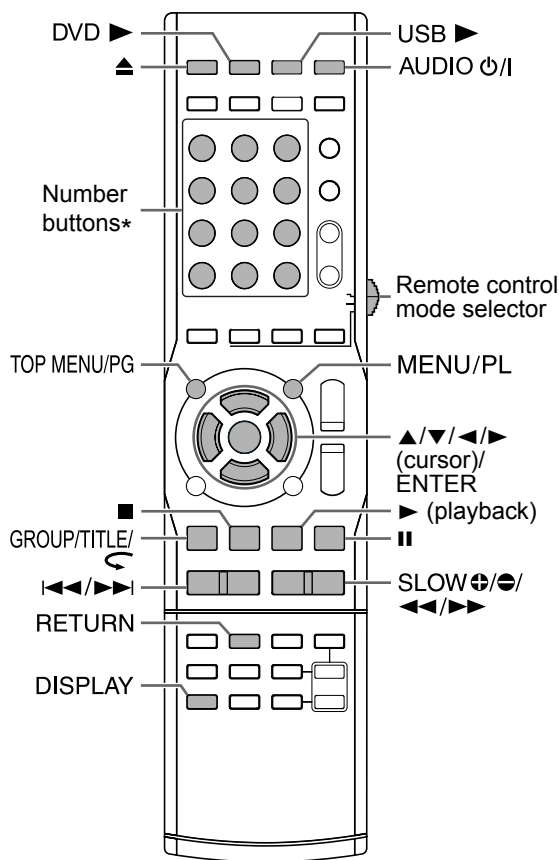

* For the number button usage, refer to "Using the number buttons" on page 11.

■ IMPORTANT

- Slide the remote control mode selector to [AUDIO].

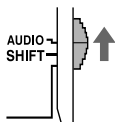

Playing back a disc



This part explains how to play back the types of discs shown above.

- 1 Press ▲ on the remote control or on the main unit.**
 - The disc tray ejects.
- 2 Place a disc on the disc tray.**

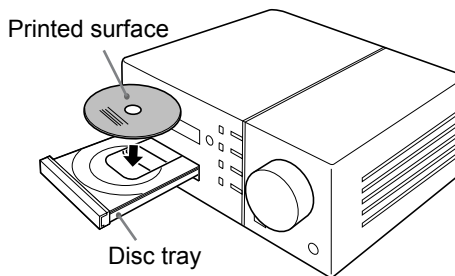

- To play back an 8-cm (3³/₁₆") disc, place it on the inner hollow of the disc tray.

- 3 Press [DVD ►].**

- If "DVD" is selected as the source, pressing ► (playback) can start playback.

NOTE

- Instead of using the remote control in step 3, you can use the buttons on the main unit. Repeatedly pressing [SOURCE] can select "DVD" as the source, and pressing ► (playback) starts playback.
- A menu screen may appear on the TV screen after DVD playback starts. In such a case, operate the menu screen, using ▲, ▼, ◀, ▶ (cursor), the number buttons and [ENTER]. (Refer to "Selecting a chapter/track from the menu screen" on page 28.)

Playing back a file

MP3 WMA WAV JPEG ASF DivX MPEG1 MPEG2

This part explains how to play back 1) files recorded on the loaded disc, and 2) files recorded on a USB mass storage class device (hereinafter referred to as “USB device”) connected to the main unit. The operations are explained with a display of MP3 files as an example.

NOTE

- Also refer to “Notes on files recorded on a connected USB device” on page 55.
- When files of different types (audio/still picture/video) are recorded on a loaded disc or connected USB device, select the file type before playback. (Refer to “FILE TYPE” on page 39.)

1

(To play back files on a disc)

Place a disc on the disc tray.

- Refer to steps 1 and 2 on page 18.

(To play back files on a USB device)

Connect the USB device.

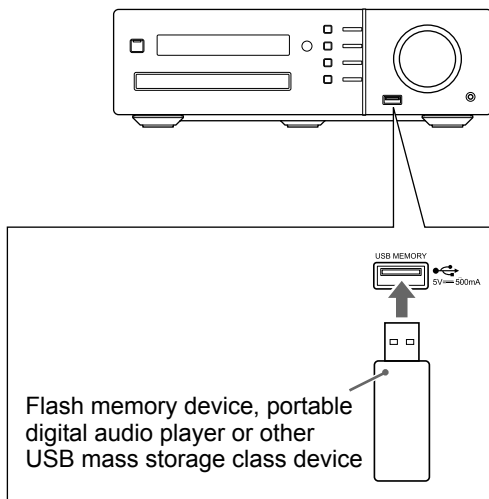

NOTE

- You cannot connect a computer to the [USB MEMORY] terminal of the system.
- When connecting with a USB cable, use a USB 2.0 cable with a length of less than 1 m (3'3 1/4").

2

(To play back files on a disc)

Press [DVD ▶].

(To play back files on a USB device)

Press [USB ▶].

NOTE

- When a file on a USB device is played back, the “USB” indicator lights up in the display window.
- You can also use the buttons on the main unit. When you repeatedly press [SOURCE] to select “DVD” or “USB” in the display window, playback automatically starts. If playback does not start, press ▶ (playback) on the main unit.

3 Press ■ to stop playback.

- The menu screen appears on the TV screen.

When a file recorded on the connected USB device is selected as the source, “USB” is displayed.

Numbers of the current group and total groups recorded on the loaded disc or connected USB device

Numbers of the current track (file) and total tracks (files) included in the current group

Elapsed playback time of the current track (MP3/WMA/WAV/ASF file only)

Playback status

Number of the total tracks (files) recorded on the loaded disc or connected USB device

Current track (file)

Tag information (MP3/WMA file only)

Current group

NOTE

- Depending on the file type, the menu screen appears without pressing ■. At this time, you can skip step 3.

4 Press ▲, ▼, ◀ or ▶ (cursor) to select a group and track.

NOTE

- You can also use the number buttons and ◀◀ or ▶▶ to select a track.
- You can also select a group by another method. (1) Slide the remote control mode selector to [SHIFT], (2) press [GROUP/TITLE], and then (3) use the number buttons to enter the desired group number while “_ _” is displayed in the display window.

5 Press [DVD ▶], [USB ▶] or ▶ (playback).

NOTE

- If you have skipped step 3, you do not have to proceed to step 5.

Slide-show playback

- JPEG files are continuously played back beginning with the selected file.
- Display time for a file in slide-show playback is approximately 3 seconds.
- Press [ENTER] to view only the selected file.

Display window on the main unit for disc/file types



DVD VIDEO

- When a disc is played back

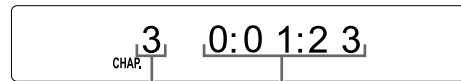

Chapter number Elapsed playback time

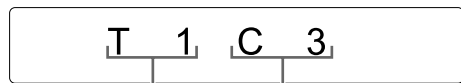
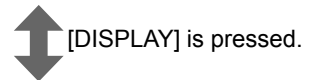

Title number Chapter number

- When a disc is stopped



Total number of titles

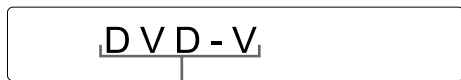
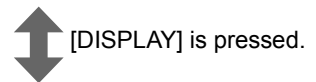

Disc type

- When “RESUME” is displayed in the display window, refer to page 25.

DVD AUDIO

■ When a disc is played back

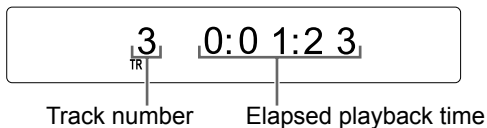

↕ [DISPLAY] is pressed.

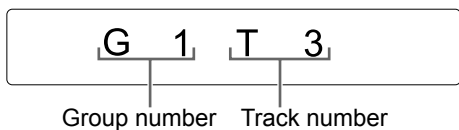

- If the "BONUS" or "B.S.P." indicator lights up during DVD AUDIO playback, refer to pages 34 or 36.

■ When a disc is stopped

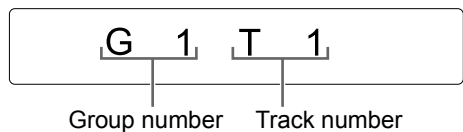

↕ [DISPLAY] is pressed.

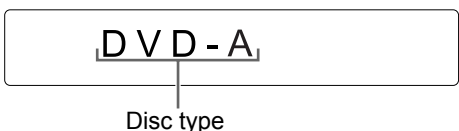

- When "RESUME" is displayed in the display window, refer to page 25.

DVD VR

■ When a disc is played back

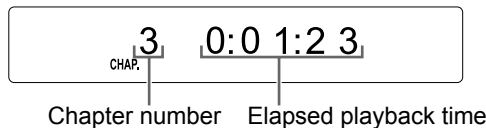

↕ [DISPLAY] is pressed.

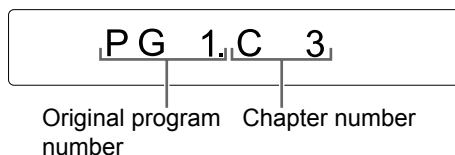

- When a play list is played back, "PL" is displayed instead of "PG".

■ When a disc is stopped

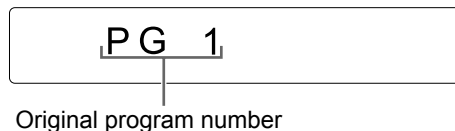

- When a play list is played back, "PL" is displayed instead of "PG".

↕ [DISPLAY] is pressed.

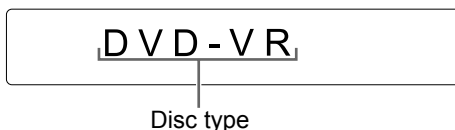

- When "RESUME" is displayed in the display window, refer to page 25.

VCD/SVCD

When a disc is played back

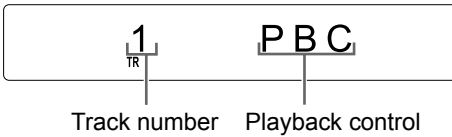

- You can use the menu screen to control playback of a PBC compatible disc.
- To cancel the PBC function, follow the instructions below.
 - Specify the track number using the number buttons when the disc is stopped.
 - Specify the track number using **◀◀** or **▶▶** when the disc is stopped, and then press [DVD ▶] or ▶ (playback).
- When the PBC function is canceled, the “PBC” display disappears and the elapsed playback time appears.
- To restore the PBC function, press [TOP MENU/PG] or [MENU/PL], or open the disc tray once.
- Press [RETURN] to return to the upper layer during PBC playback.

When a disc is stopped

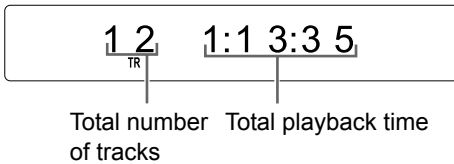

↓ A few seconds later

(When the PBC function is activated)

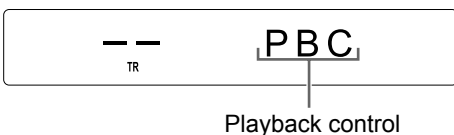

↕ [DISPLAY] is pressed.

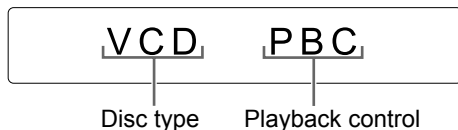

- When “RESUME” is displayed in the display window, refer to page 25.
- When a VCD is stopped, “VCD” is displayed as shown above.
- When an SVCD is stopped, “SVCD” is displayed as the disc type.

CD

When a disc is played back



When a disc is stopped

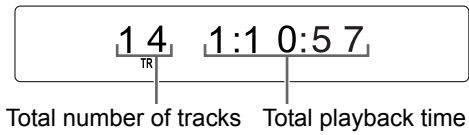

↕ [DISPLAY] is pressed.

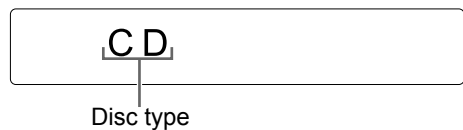

MP3/WMA/WAV/ASF/DivX/MPEG1/MPEG2 file

■ When a file is played back

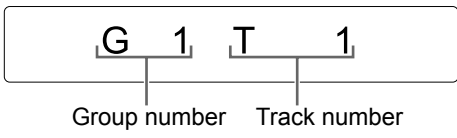
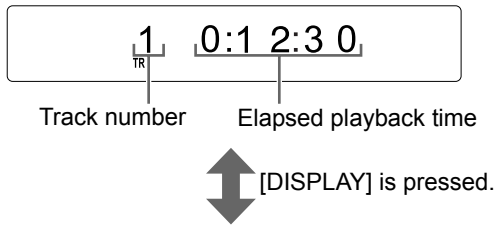

■ When a file is stopped

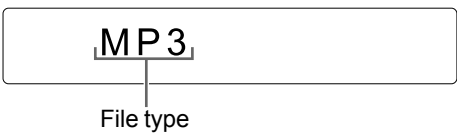
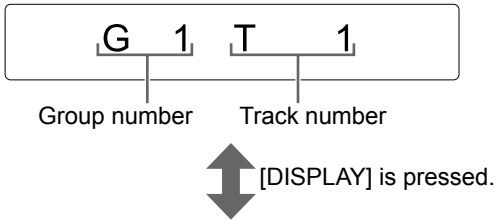

- When "RESUME" is displayed in the display window, refer to page 25.
- The display differs according to the file type. When a file is stopped, "MP3", "WMA", "WAV", "ASF", "DIVX" or "MPEG" appears. (The "MPEG" display refers to an MPEG1 or MPEG2 file.)

JPEG file

■ When a file is played back

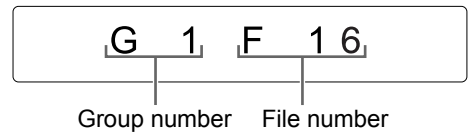
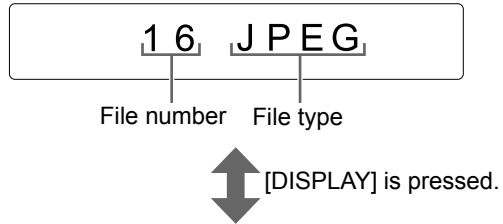

■ When a file is stopped

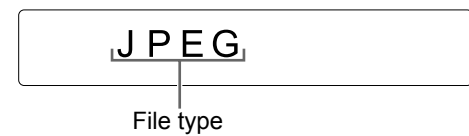
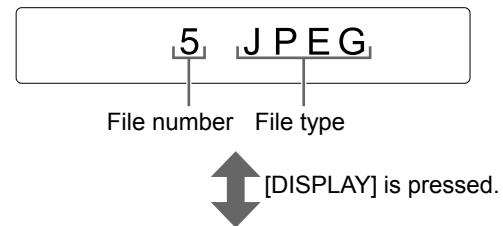

Messages on the TV screen

When a DVD VIDEO or a USB device is selected as the source, the messages shown below are displayed on the TV screen to indicate the status of the DVD VIDEO or USB device.

NOW READING:

Appears when the main unit is reading the disc/file information. Wait for a short time.

REGION CODE ERROR!:

Appears when the region code of the disc does not match the code supported by the main unit. (Refer to page 53.)

NO DISC:

Appears when no disc is loaded.

NO USB DEVICE:

Appears when a USB device is not connected.

OPEN:

Appears when the disc tray is opening.

CLOSE:

Appears when the disc tray is closing.









CANNOT PLAY THIS DISC:

Appears when attempting to play back an unplayable disc.

CANNOT PLAY THIS DEVICE:

Appears when there are no playable files on a USB device.





Guide icons on the TV screen (on-screen guide)

	: Play
	: Pause
	: Fast reverse/fast forward search
	: Slow motion playback (reverse/forward directions)
	: Containing multi-view angles (Refer to page 36.)
	: Containing multi-audio languages (Refer to page 32.)
	: Containing multi-subtitle languages (Refer to page 32.)
	: The disc/file cannot accept the operation you have attempted.

Indicators in the display window

The indicators corresponding to the status below light up in the display window.

Digital signal format indicators

	Lights up when Dolby Digital signal comes in.
	Lights up when DTS Digital (Surround) signal comes in.
	Lights up when DVD AUDIO packed PCM signal comes in.
	Lights up when linear PCM signal comes in.









NOTE

- Any digital signal indicators do not light up when an analog signal comes in.

Dolby Surround mode indicator

	Lights up when Dolby Pro Logic II mode is activated.
---	--

Source signal and other indicators

	Lights up when the left channel signal comes in.
	Lights up when the center channel signal comes in.
	Lights up when the right channel signal comes in.
	Lights up when the LFE channel signal comes in.
	Lights up when the left surround channel signal comes in.
	Lights up when the monaural surround channel signal or 2-channel Dolby Surround signal comes in.
	Lights up when the right surround channel signal comes in.
	Lights up when the left/right speakers and the subwoofer are in use. (Disappears when headphones are connected to the [PHONES] terminal.)
	

Stopping playback



■ When a disc/file is played back

Press **■**.

Resuming playback



When playback is stopped in the middle, playback can be started from the stopped position.

Temporarily stopping playback

■ When a disc/file is played back

Follow any of the operations below.

Press ■ once to stop playback.*1 *2
Select a source other than “DVD” or “USB” in the display window.*2
Press [AUDIO \odot /I] to turn off the main unit.*3

*1 “RESUME” is displayed in the display window. If **■** is pressed twice, the position where playback has been stopped is cleared.

*2 After this operation, the position where playback has been stopped is stored even when the main unit is turned off by pressing [AUDIO \odot /I].

*3 When you press [AUDIO \odot /I] to turn on the main unit again, the position where playback has been stopped is cleared.

Starting playback from the stored position

■ When a disc/file is stopped in the middle

Press [DVD \blacktriangleright] or [USB \blacktriangleright].

NOTE

- This function does not work in program playback or random playback.
- The stored position is cleared if the disc tray is opened or the USB device is disconnected.
- You can deactivate the resume playback function. (Refer to “RESUME” on page 40.)
- When a file on the USB device is selected as the source, this function may not work as explained above.

Pausing playback



■ When a disc/file is played back

Press **II**.

- To return to normal playback, press [DVD \blacktriangleright], [USB \blacktriangleright] or \blacktriangleright (playback).

Advancing the picture frame by frame



DVD AUDIO (only for moving images)

■ When a disc/file is paused

Press **II repeatedly**.

- To return to normal playback, press [DVD \blacktriangleright], [USB \blacktriangleright] or \blacktriangleright (playback).

Fast reverse/fast forward search



There are two methods.

■ When a disc/file is played back

• Press ◀◀ or ▶▶.

Each time you press ▶▶, the speed increases.
To restore the normal speed, press [DVD ▶], [USB ▶] or ▶(playback).

• Hold down ◀◀ or ▶▶.

NOTE

- For some discs/files, sound is intermittent or no sound is produced during fast reverse/fast forward search.
- The selectable speeds and displays vary by the disc/file type.

Playing back from a position 10 seconds before



■ When a disc is played back

Press ↶.

NOTE

- You cannot go back to the previous title and original program (play list).

Slow motion playback



DVD AUDIO (only for moving images)

■ When a disc is paused

Press [◀ SLOW] or [SLOW ▶].

- Each time you press [◀ SLOW] or [SLOW ▶], the speed increases.
- Press || to pause playback, and press [DVD ▶] or ▶(playback) to return to normal playback.

NOTE

- No sound is produced.
- The picture motion in the reverse direction may not be smooth.
- For a VCD, SVCD or DVD VR, slow motion playback can be used in the forward direction only.

Skipping to the beginning of a chapter/track/file



■ When a disc/file is played back
Press **⏮** or **⏭** repeatedly.

NOTE

- You cannot skip to the previous track even by pressing **⏮** during random playback. (Refer to page 31.)
- You can also select a title or group. (1) Slide the remote control mode selector to [SHIFT], (2) press [GROUP/TITLE], and then (3) use the number buttons to enter the desired title or group number while “_ _” is displayed in the display window. At this time, for a DVD VR, the “PG” or “PL” indicator lights up in the display window.

Selecting a chapter/track using the number buttons



■ When a disc/file is played back
Use the number buttons to select the chapter number or track number.

NOTE

- To cancel the PBC function for VCD/SVCD, refer to page 22.

Skipping at approximately 5 minute intervals



You can skip within a file at approximately 5 minute intervals. This is useful especially when you want to skip within a long file.

■ When a disc/file is played back
Press **◀** or **▶** (cursor).

- Each time you press **◀** or **▶** (cursor), the playback position skips to the beginning of the previous or next interval. Each interval is approximately 5 minutes.

NOTE

- Intervals are automatically assigned from the beginning of a file.
- You can use this function only within the same file.

Selecting a chapter/track from the menu screen



■ When a disc is stopped or played back

- 1 Press [TOP MENU/PG] or [MENU/PL].
 - The menu screen is displayed.
 - Pressing [TOP MENU/PG] may not work depending on the disc type. In this case, press [MENU/PL].
- 2 Press ▲, ▼, ◀ or ▶ (cursor) to select the selection menu for chapters or tracks.
- 3 Press [ENTER].
- 4 Press ▲, ▼, ◀ or ▶ (cursor) to select the desired chapter or track.
- 5 Press [ENTER].

NOTE

- You can use this function only when a menu screen is recorded on the disc.
- Depending on a disc, you may proceed to step 4 when you finish step 1.
- Playback may start for some discs without pressing [ENTER] in step 5.



■ When a disc is played back with the PBC function activated

- 1 Press [RETURN] once or more.
- 2 Press the number buttons to select the desired track.

NOTE

- For a VCD/SVCD whose menu screen has a couple of pages, you can change the page by pressing ◀◀ or ▶▶ in step 2.



■ When a disc is stopped or played back

- 1 Press [TOP MENU/PG] to display the original program or press [MENU/PL] to display the play list.

Original program

ORIGINAL PROGRAM				
No	Date	Ch	Time	Title
1	12/03/07	L 1	10:15am	La fleur
2	12/09/07	L 1	11:05pm	The last struggle
3	12/18/07	L 1	8:17am	free flyer
4	12/20/07	L 1	7:47am	BOOM!
5	12/25/07	L 1	7:38pm	Mr. Lawrence
6	12/28/07	L 1	2:20pm	Satisfy U

Labels for the table:
 - Title name: points to the Title column
 - Starting time for the title recording: points to the Time column
 - Channel information: points to the Ch column
 - Recording date: points to the Date column

Play list

PLAY LIST				
No	Date	Chap	Length	Title
1	12/03/07	2	0:23:24	Nebula G.
2	12/15/07	4	1:04:39	CDJ
3	12/24/07	13	0:41:26	Secret Garden
4	12/27/07	17	0:03:03	S. Walker

Labels for the table:
 - Total playback time for the title: points to the Length column
 - Number of chapters included in the title: points to the Chap column
 - Recording date: points to the Date column

- The play list does not appear when a play list has not been recorded to the disc.
- 2 Press ▲ or ▼ (cursor) to select the desired title.
 - 3 Press [ENTER].
 - When you have selected the original program by pressing [TOP MENU/PG] in step 1, playback starts from the selected title.
 - When you have selected the play list by pressing [MENU/PL] in step 1, only the selected title is played back.

Convenient functions of disc/file playback

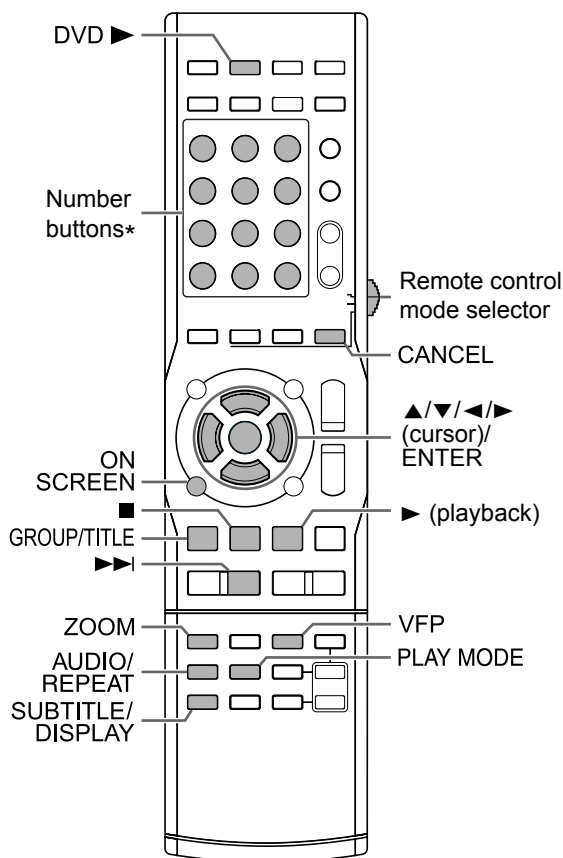

* For the number button usage, refer to “Using the number buttons” on page 11.

■ IMPORTANT

- Some buttons change their functions according to the remote control mode.
- Before using the functions described in “Convenient functions of disc/file playback” (other than [AUDIO], [SUBTITLE], [ZOOM], [VFP] or [GROUP/TITLE]), slide the remote control mode selector to [AUDIO].

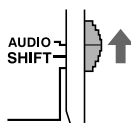

Playing back a disc/file in the desired order (Program playback)



(only on a loaded disc)

You can program a maximum of 99 chapters or tracks. The same chapter or track can be programmed more than once.

■ When a disc/file is stopped

1 Press [PLAY MODE] to display “PROGRAM” in the display window.

- If you accidentally pressed [PLAY MODE] twice or more, press [PLAY MODE] repeatedly until “PROGRAM” is displayed.

Display window

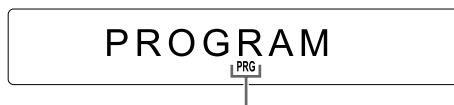

This indicator lights up when the program playback function is activated.

Example: TV screen for a DVD VIDEO (Program screen)

PROGRAM		
No	Group/Title	Track/Chapter
1		
2		
3		
4		
5		
6		
7		
8		

2 Press the number buttons to program tracks/chapters.

- You can refer to the program number in the display window by pressing [DISPLAY].

Display for a DVD VIDEO

- Select a title number, and then a chapter number.

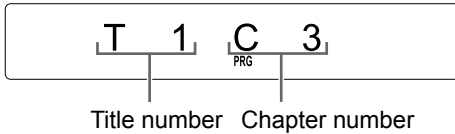

↑↓ [DISPLAY] is pressed.

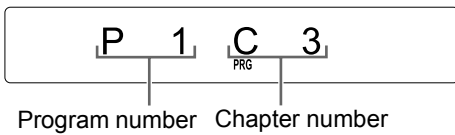

Display for a DVD AUDIO/MP3/WMA/WAV file

- Select a group number and then a track number.

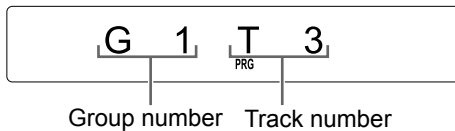

↑↓ [DISPLAY] is pressed.

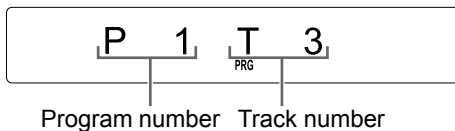

Display for a VCD/SVCD/CD

- Select a track number.
- As you finish the track selection, the total time for the program playback is displayed.

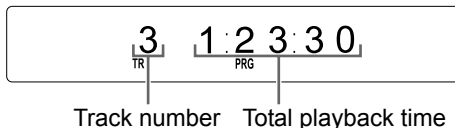

↑↓ [DISPLAY] is pressed.

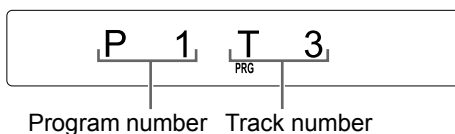

Example: TV screen for a DVD VIDEO (Program screen)

PROGRAM		
No.	Group/Title	Track/Chapter
1	1	3
2		
3		
4		
5		
6		
7		
8		

- Before selecting a bonus group of a DVD AUDIO, cancel the “BONUS” indicator as explained in “Playing back the bonus group” on page 34.

NOTE

- Instead of using the number buttons, when you press [ENTER] in the “Track/Chapter” column on the TV screen, “ALL” appears and all the chapters/tracks in the selected title/group are programmed. (Only for a DVD VIDEO/DVD AUDIO/MP3/WMA/WAV file)
- You can erase the programmed tracks one by one from the bottom of the list on the program screen by pressing [CANCEL] repeatedly.
- You can erase the whole program by holding down [CANCEL].
- Opening the disc tray also erases the program.

3 Press [DVD ►] or ►(playback).

Confirming the program

- When a disc/file is played back

Press ■.

- Playback stops and the program screen appears on the TV screen.

Canceling program playback

- When a disc/file is stopped

Press [PLAY MODE] repeatedly to display an item other than “PROGRAM” in the display window.

- This operation does not erase the program.

Playing back a disc/file in a random order (Random playback)



(only on a loaded disc)

■ When a disc/file is stopped

1 Press [PLAY MODE] repeatedly to display “RANDOM” in the display window.



This indicator lights up when the random playback function is activated.

2 Press [DVD ►] or ►(playback).

NOTE

- Each chapter or track is played back only once.

Canceling random playback

■ When a disc/file is stopped

Press [PLAY MODE] repeatedly to display an item other than “RANDOM” in the display window.

- Opening the disc tray also cancels random playback.

Playing back a disc/file repeatedly (Repeat playback)



■ When a disc/file is played back

Press [REPEAT].

- Each time you press [REPEAT], the repeat mode changes.

Indicator in the display window	Display on the TV screen*1	Usage for the repeat mode
C	📁TITLE	Repeats the current title.
	📁PG	Repeats the current original program.
	📁PL	Repeats the current play list.
	📁GROUP	Repeats the current group.
C 1	📁CHAP*2	Repeats the current chapter.
	📁TRACK*2	Repeats the current track.
C ALL	📁ALL	Repeats all chapters/tracks.*3
—	📁OFF*4	Cancels repeat.

*1 For some discs/files, “REPEAT” may appear instead of “📁”

*2 “STEP” is displayed during program/random playback.

*3 Repeats the whole program during program playback.

*4 For some discs/files, no display may appear.

NOTE

- You can also use the menu bar to set repeat playback. (Refer to page 36.)
- You can also specify a part to be played back repeatedly by using A-B repeat playback. (Refer to page 37.)
- The repeat mode is automatically canceled if there is a file that cannot be played back.
- For some discs, stopping playback may automatically cancel repeat playback.
- To cancel the PBC function for VCD/SVCD, refer to page 22.

Selecting the audio language and subtitle language

■ When a disc/file is played back

■ IMPORTANT

- Slide the remote control mode selector to [SHIFT].

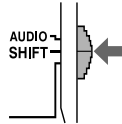

1 Press the desired button shown below.

Function	Button	Available disc/file
Audio language	[AUDIO]	
Subtitle language	[SUBTITLE]	 <p>(only for moving images)</p>

Example: TV screen for the subtitle language

- : Audio language
- : Subtitle language

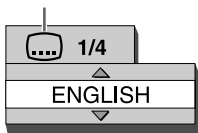

2 Press ▲ or ▼ (cursor) to select the desired language.

NOTE

- It is recommended that you slide the remote control mode selector to [AUDIO] after using these functions. Most of the other functions can be used when the remote control mode selector is at [AUDIO].
- Pressing [AUDIO] repeatedly also changes the audio languages.
- Pressing [SUBTITLE] repeatedly turns the subtitle display on and off.
- You can only select these function settings when the disc/file contains multiple audio languages or subtitle languages.
- When a language code such as "AA" and "AB" is displayed, refer to "Language codes" on page 42.
- You can also use the menu bar to set the functions. Refer to page 36.
- When a DVD VR, VCD or SVCD is played back, "ST" (stereo), "L" (left) and "R" (right) are displayed on the TV screen.

Magnifying the picture



(only for moving images)

■ When a disc/file is played back or paused

■ IMPORTANT

- Slide the remote control mode selector to [SHIFT].

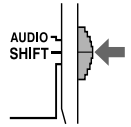

1 Press [ZOOM].

- Each time you press [ZOOM], the picture magnification changes on the TV screen.

2 Select the area of image you want to magnify by using ▲, ▼, ◀ or ▶ (cursor).

- To return to normal playback, select "ZOOM OFF" in step 1.

NOTE

- It is recommended that you slide the remote control mode selector to [AUDIO] after using this function. Most of the other functions can be used when the remote control mode selector is at [AUDIO].
- You cannot change the picture magnification during slide-show playback of JPEG files.
- During ASF file playback, ▲, ▼, ◀ or ▶ (cursor) may not work in step 2.
- When you magnify a picture, image quality may be deteriorated or the image may be distorted.

Adjusting the picture quality (VFP)



■ When a disc/file is played back or paused

■ IMPORTANT

- Slide the remote control mode selector to [SHIFT].

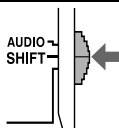

1 Press [VFP].

- The current settings are displayed.

Example: TV screen for the VFP mode

Selected VFP mode

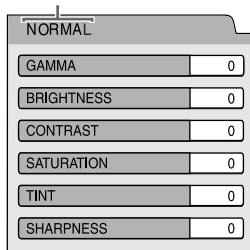

2 Press ◀ or ▶ (cursor) to select the video fine processor (VFP) mode.

- Each time you press ◀ or ▶ (cursor), VFP mode changes on the TV screen as follows.
 - "NORMAL"
For normal playback. (You cannot adjust the image quality.) Go to step 7.
 - "CINEMA"
Suitable for viewing a movie in a dim room. (You cannot adjust the image quality.) Go to step 7.
 - "USER1/USER2"
You can adjust the image quality. Go to step 3.

3 Press ▲ or ▼ (cursor) to select the item you want to adjust.

- Each time you press ▲ or ▼ (cursor), the item changes on the TV screen as follows.
 - "GAMMA"
Controls the brightness of neutral tints while maintaining the brightness of dark and light portions. (Setting range: -3 to +3)
 - "BRIGHTNESS"
Controls the brightness of the display. (Setting range: -8 to +8)
 - "CONTRAST"
Controls the contrast of the display. (Setting range: -7 to +7)
 - "SATURATION"
Controls the saturation of the display. (Setting range: -7 to +7)
 - "TINT"
Controls the tint of the display. (Setting range: -7 to +7)
 - "SHARPNESS"
Controls the sharpness of the display. (Setting range: -8 to +8)

4 Press [ENTER].

Example: TV screen for "GAMMA"



5 Press ▲ or ▼ (cursor) to change the value.

6 Press [ENTER].

- To adjust other items, go back to step 3.

7 Press [VFP].

NOTE

- It is recommended that you slide the remote control mode selector to [AUDIO] after using this function. Most of the other functions can be used when the remote control mode selector is at [AUDIO].
- If no operation is made for several seconds during the procedure, the settings made so far are automatically stored.
- When the [HDMI MONITOR OUT] terminal is connected, this function does not affect the picture quality.

Playing back the bonus group

DVD AUDIO

Some DVD AUDIOS may have a special group, called “bonus group”. You can use this function when the “BONUS” indicator lights up in the display window.

■ When a disc is played back

■ IMPORTANT

- Slide the remote control mode selector to [SHIFT].

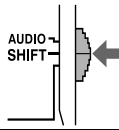

1 Press [GROUP/TITLE].

2 Press ►►| repeatedly to select a bonus group.

- “KEY_” appears on the TV screen, and in the display window.

3 Press the number buttons to enter the pin code (four digits).

- The method of obtaining a pin code differs depending on the disc.

4 Press [ENTER].

- When the correct pin code is entered, the “BONUS” indicator disappears in the display window and the playback of the bonus group starts.
- If an incorrect pin code is entered, try entering the correct pin code again.

Using the status bar and the menu bar

■ When a disc/file is played back

1 Press [ON SCREEN] twice.

Example: TV screen for a DVD VIDEO

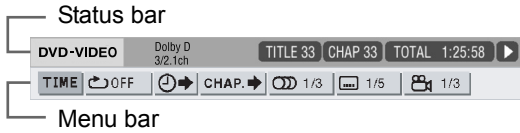

2 Press ◀ or ▶ (cursor) to select an item you want to operate.

3 Press [ENTER].

4 Press ▲ or ▼ (cursor) to select your desired setting.

NOTE

- To turn off the status bar and the menu bar, press [ON SCREEN].

Information displayed on the status bar

DVD VIDEO/DVD AUDIO/DVD VR

Example: Status bar for a DVD VIDEO

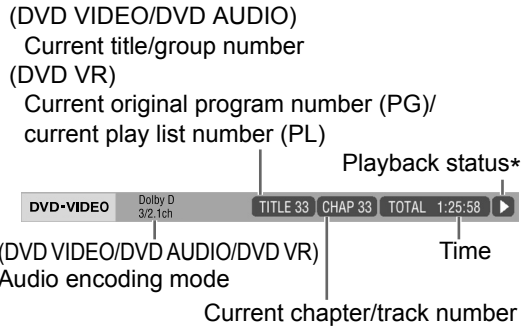

VCD/SVCD/CD/ASF/DivX/MPEG1/MPEG2 file

Example: Status bar for a CD

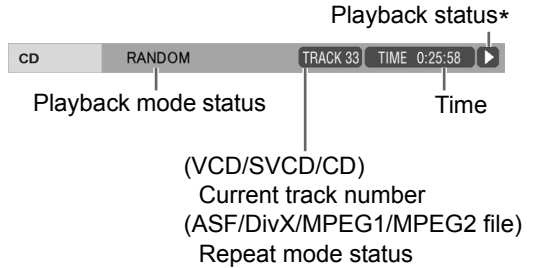







NOTE

- * The playback status has the same meaning of the guide icons on the TV screen. (Refer to page 24.)

Function list

<p>TIME</p> <p>Time display selection</p>	<p>Changes the time information in the display window and the status bar. Instead of steps 3 and 4 on page 35, press [ENTER] repeatedly. Each time [ENTER] is pressed, the display changes on the status bar.</p> <p>DVD VIDEO DVD AUDIO</p> <p>■ When a disc is played back</p> <p>TOTAL : Elapsed playback time of the current title/group.</p> <p>T.REM : Remaining time of the current title/group.</p> <p>TIME : Elapsed playback time of the current chapter/track.</p> <p>REM : Remaining time of the current chapter/track.</p> <p>DVD VR</p> <p>■ When a disc is played back</p> <p>TOTAL : Elapsed playback time of the current original program/play list.</p> <p>T.REM : Remaining time of the current original program/play list.</p> <p>VCD SVCD CD</p> <p>■ When a disc is played back</p> <p>TIME : Elapsed playback time of the current track.</p> <p>REM : Remaining time of the current track.</p> <p>TOTAL : Elapsed playback time of the disc.</p> <p>T.REM : Remaining time of the disc.</p>
--	---

<p> OFF</p> <p>Repeat mode</p>	<p>Refer to page 31. (For A-B repeat playback, refer to page 37.)</p>
<p></p> <p>Time search</p>	<p>Refer to page 37.</p>
<p></p> <p>Chapter search/ track search</p>	<p>DVD VIDEO DVD VR (chapter search)</p> <p>DVD AUDIO (track search)</p> <p>Selects a chapter/track. Instead of steps 4 on page 35, press the number buttons to enter the chapter/track number and press [ENTER].</p> <p>Examples:</p> <p>5 : [5]</p> <p>24 : [2] → [4]</p>
<p> 1/3</p> <p>Audio language</p>	<p>Refer to page 32.</p>
<p> 1/5</p> <p>Subtitle language</p>	<p>Refer to page 32.</p>
<p> 1/3</p> <p>View angle</p>	<p>DVD VIDEO DVD AUDIO</p> <p>(only for moving images)</p> <p>■ When a disc is played back</p> <p>Selects a view angle if the disc contains multiple view angles.</p>
<p>PAGE -/-</p> <p>Page selection</p>	<p>DVD AUDIO</p> <p>■ When a disc is played back</p> <p>Selects browsable still pictures (B.S.P.) if the DVD AUDIO contains ones and the "B.S.P." indicator lights up in the display window. The pictures can be viewed as if you are turning pages. For some pictures, you may have to press [ENTER] or wait for a short time after step 4 on page 35.</p>

Playing back a specified part repeatedly (A-B repeat playback)



You can play back a desired part repeatedly by specifying a start point (A) and an end point (B).

■ When a disc is played back

- 1 Press [ON SCREEN] twice.
 - The menu bar appears. (Refer to page 35.)
- 2 Press ◀ or ▶ (cursor) to select OFF.
- 3 Press [ENTER].
- 4 Press ▲ or ▼ (cursor) to select "A-B".



- 5 Press [ENTER] at the start point of the part to be repeated (specifying point A).
 - The icon on the menu bar is A-.
- 6 Press [ENTER] at the end point of the part to be repeated (specifying point B).
 - The icon on the menu bar is A-B.
 - The "↶" and "A-B" indicators light up in the display window and the part between points A and B is played back repeatedly.

Canceling A-B repeat playback

There are two methods.

- Press ■.
- Select OFF. (Select A-B and press [ENTER] twice.)

NOTE

- You can use A-B repeat playback only within the same title or track.
- You cannot use A-B repeat playback during program playback or random playback.
- To cancel the PBC function for VCD/SVCD, refer to page 22.
- For some discs, stopping playback may automatically cancel A-B repeat playback.

Designating the time (Time search)



■ When a disc is played back

- 1 Press [ON SCREEN] twice.
 - The menu bar appears. (Refer to page 35.)
 - 2 Press ◀ or ▶ (cursor) to select .
 - 3 Press [ENTER].
-
- 4 Enter the time using the number buttons.

Example:

When you want to play back a DVD VIDEO from the position of (0 hour) 23 minutes 45 seconds, press the number buttons in the order of [0], [2], [3], [4] and [5].

- You can skip entering the minute and second settings.
- If an incorrect value is entered, press ◀ (cursor) to delete the value and enter the correct value.

- 5 Press [ENTER].

- To turn off the menu bar, press [ON SCREEN].

NOTE

- This function does not work during program playback or random playback.
- Time search for a DVD VIDEO is from the beginning of the title.
- Time search for a DVD AUDIO is from the beginning of the track being played back.
- Time search for a VCD, an SVCD and a CD is as follows:
 - When the disc is stopped, time search is from the beginning of the disc.
 - When the disc is played back, time search is within the track currently being played back.
- To cancel the PBC function for VCD/SVCD, refer to page 22.

Changing the initial settings with the preference screen



You can use the preference screen to change the initial settings of the main unit according to the environment where the main unit is used.

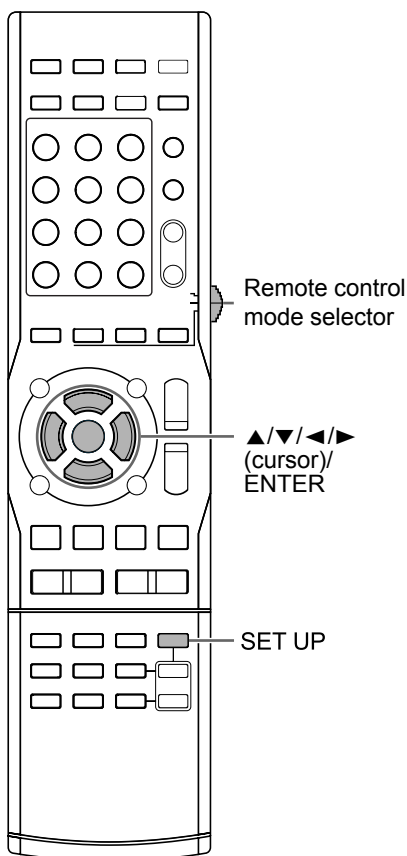

■ IMPORTANT

- Slide the remote control mode selector to [SHIFT].

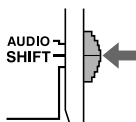

NOTE

- The top and bottom of the preference screen may not be displayed on a widescreen TV. Adjust the picture size on the TV.

Basic operations

- When a disc/file is stopped or no disc is loaded ("NO DISC" is displayed in the display window)

1 Press [SET UP].

- The preference screen appears on the TV screen.

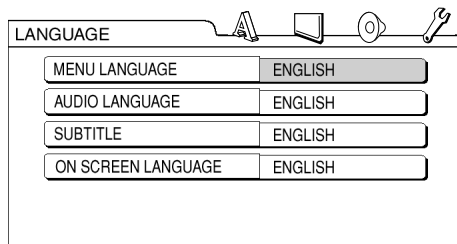

2 Use ▲, ▼, ◀, ▶ (cursor) and [ENTER] to operate the preference screen.

- Follow the description on the TV screen to operate the preference screen.

NOTE

- It is recommended that you slide the remote control mode selector to [AUDIO] after using this function. Most of the other functions can be used when the remote control mode selector is at [AUDIO].



A LANGUAGE

Items	Contents
MENU LANGUAGE	Select the language for the DVD VIDEO menu screen.
AUDIO LANGUAGE	Select the audio language for the DVD VIDEO.
SUBTITLE	Select the subtitle language for the DVD VIDEO.
ON SCREEN LANGUAGE	Select the language displayed on the preference screen.

NOTE

- If the selected language is not recorded on the disc/file, the optimum language set for the disc/file is displayed.
- For a language code such as "AA", refer to the "Language codes" on page 42.

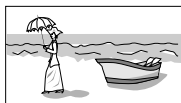
PICTURE

Items	Contents (<input type="checkbox"/> : initial setting)
MONITOR TYPE	<p>Select the display method suitable for your TV.</p> <p>16 : 9 NORMAL : For a widescreen TV whose aspect ratio is fixed at 16:9. When a conventional screen picture whose aspect ratio is 4:3 is input, black bars appear on the left and right sides of the screen.</p> <p>16:9 AUTO : For a widescreen TV which automatically detects the aspect ratio of the input screen picture.</p> <p>When a conventional screen picture is input</p>  <p>When a widescreen picture is input</p>  <p>4 : 3 LB (Letterbox) : For a TV with conventional 4:3 aspect ratio. When a widescreen picture is input, black bars appear on the top and bottom of the screen.</p>  <p>4 : 3 PS (Pan Scan) : For a TV with conventional 4:3 aspect ratio. When a widescreen picture is input, the left and right edges of the picture are not shown on the screen. (If the disc/file is not compatible with Pan Scan, the picture is displayed at the Letterbox ratio.)</p> 

Items	Contents (<input type="checkbox"/> : initial setting)
PICTURE SOURCE	<p>Select the item suitable to the video source.</p> <p>AUTO : The video source type (a video or film) is automatically selected.</p> <p>FILM : To view a film or video recorded with the progressive scan method</p> <p>VIDEO : Suitable for playing back a video</p>
SCREEN SAVER	<p>You can turn ON or OFF the screen saver. The screen saver activates when there is no operation made for approximately 5 minutes since a still picture was last displayed.</p>
FILE TYPE	<p>When files of different types are recorded on a loaded disc or connected USB device, select the file type before playback.</p> <p>AUDIO : For MP3/WMA/WAV files</p> <p>STILL PICTURE : For JPEG files</p> <p>VIDEO : For ASF/DivX/MPEG1/MPEG2 files</p>
HDMI DVI COLOR	<p>You can select the settings for the picture appearance (image quality, color intensity and black fading) on the TV connected to the [HDMI MONITOR OUT] terminal.</p> <p>STANDARD : For normal usage</p> <p>ENHANCE : The main unit automatically adjusts the picture appearance.</p>
HDMI OUT	<p>You can select the video signal type output from the [HDMI MONITOR OUT] terminal.</p> <p>AUTO : For normal usage. The main unit automatically selects the output video signal type according to the TV connected to the [HDMI MONITOR OUT] terminal.</p> <p>RGB : Select this item if no picture appears on the TV with the "AUTO" setting. The output video signal type is set to the RGB signal.</p>



AUDIO

Items	Contents ([] : initial setting)
DIGITAL AUDIO OUTPUT	<p>Select the output signal type suitable to the device connected to the [DIGITAL OUT] terminal. Refer to "List of relationships of DIGITAL AUDIO OUTPUT preference items and output signals" on page 41.</p> <p>PCM ONLY : Device corresponding only to linear PCM</p> <p>DOLBY DIGITAL/PCM : Dolby Digital decoder or device having the same function</p> <p>STREAM/PCM : DTS/Dolby Digital decoder or device having the same function</p> <p>NOTE</p> <ul style="list-style-type: none"> When the [HDMI MONITOR OUT] terminal is connected and "HDMI AUDIO OUT" is set to "ON", this setting is deactivated.
DOWN MIX	<p>Select the signal suitable to the device connected to the [DIGITAL OUT] terminal. Set "DOWN MIX" only when "DIGITAL AUDIO OUTPUT" is set to "PCM ONLY".</p> <p>DOLBY SURROUND : Dolby Pro Logic decoder-built-in device</p> <p>STEREO : Ordinary audio device</p>
D (Dynamic). RANGE COMPRESSION	<p>To correct the difference between high volume and low volume when playing back with low volume (only for a DVD recorded with Dolby Digital).</p> <p>AUTO : The D. RANGE COMPRESSION function automatically turns on.</p> <p>ON : The D. RANGE COMPRESSION function is always on.</p>
HDMI AUDIO OUT	<p>You can select whether or not the audio signal from the [HDMI MONITOR OUT] terminal is output.</p> <p>ON : The audio signal from the [HDMI MONITOR OUT] is output.</p> <p>OFF : The audio signal from the [HDMI MONITOR OUT] is not output.</p> <p>NOTE</p> <ul style="list-style-type: none"> Depending on the connected TV, when "HDMI AUDIO OUT" is set to "ON", only PCM signals can be output via an HDMI cable.



OTHERS

Items	Contents ([] : initial setting)
RESUME	Select ON or OFF . (Refer to page 25.)
ON SCREEN GUIDE	Select ON or OFF . (Refer to page 24.)
CEC	<p>You can select the usage for the HDMI CEC functions. (Refer to page 50.)</p> <p>ON 1 : For using the HDMI CEC functions normally</p> <p>ON 2: Select this item if you do not want to have the main unit automatically turned on/off by turning on/off the TV or external connected HDMI CEC compatible devices. All other available HDMI CEC functions operate the same as when "ON 1" is selected.</p> <p>OFF: For deactivating the HDMI CEC functions</p>
DivX REGISTRATION	The main unit has its own registration code. You can confirm the registration code, when necessary. Once you have played back a disc/file on which the registration code is recorded, the registration code of the main unit is overwritten for copyright protection.

List of relationships of DIGITAL AUDIO OUTPUT preference items and output signals

Playback disc/file	DIGITAL AUDIO OUTPUT preference		
	STREAM/PCM	DOLBY DIGITAL/PCM	PCM ONLY
48 kHz, 16/20/24-bit linear PCM DVD VIDEO 96 kHz linear PCM DVD VIDEO	48 kHz, 16-bit stereo linear PCM		
48/96/192 kHz, 16/20/24-bit linear PCM DVD AUDIO	48 kHz, 16-bit stereo linear PCM		
44.1/88.2/176.4 kHz, 16/20/24-bit linear PCM DVD AUDIO	44.1 kHz, 16-bit stereo linear PCM		
DTS DVD VIDEO/DVD AUDIO	DTS bit stream	48 kHz, 16-bit stereo linear PCM	
DOLBY DIGITAL DVD VIDEO/ DVD AUDIO	DOLBY DIGITAL bit stream		48 kHz, 16-bit stereo linear PCM
CD/VCD/SVCD	44.1 kHz, 16-bit stereo linear PCM 48 kHz, 16-bit linear PCM		
DTS CD	DTS bit stream	44.1 kHz, 16-bit linear PCM	
MP3/WMA/WAV/DivX/MPEG1/ MPEG2 file	32/44.1/48 kHz, 16-bit linear PCM		

NOTE

- Among DVD VIDEOS without copyright protection, there may be some DVD VIDEOS that output a 20- or 24-bit signal through the [DIGITAL OUT] terminal.

Language codes

Code	Language	Code	Language	Code	Language	Code	Language
AA	Afar	GD	Scots Gaelic	MI	Maori	SN	Shona
AB	Abkhazian	GL	Galician	MK	Macedonian	SO	Somali
AF	Afrikaans	GN	Guarani	ML	Malayalam	SQ	Albanian
AM	Ameharic	GU	Gujarati	MN	Mongolian	SR	Serbian
AR	Arabic	HA	Hausa	MO	Moldavian	SS	Siswati
AS	Assamese	HI	Hindi	MR	Marathi	ST	Sesotho
AY	Aymara	HR	Croatian	MS	Malay (MAY)	SU	Sundanese
AZ	Azerbaijani	HY	Armenian	MT	Maltese	SV	Swedish
BA	Bashkir	IA	Interlingua	MY	Burmese	SW	Swahili
BE	Byelorussian	IE	Interlingue	NA	Nauru	TA	Tamil
BG	Bulgarian	IK	Inupiak	NE	Nepali	TE	Telugu
BH	Bihari	IN	Indonesian	NL	Dutch	TG	Tajik
BI	Bislama	IS	Icelandic	NO	Norwegian	TH	Thai
BN	Bengali, Bangla	IW	Hebrew	OC	Occitan	TI	Tigrinya
BO	Tibetan	JI	Yiddish	OM	(Afan) Oromo	TK	Turkmen
BR	Breton	JW	Javanese	OR	Oriya	TL	Tagalog
CA	Catalan	KA	Georgian	PA	Panjabi	TN	Setswana
CO	Corsican	KK	Kazakh	PS	Pashto, Pushto	TO	Tonga
CY	Welsh	KL	Greenlandic	PT	Portuguese	TR	Turkish
DA	Danish	KM	Cambodian	QU	Quechua	TS	Tsonga
DZ	Bhutani	KN	Kannada	RM	Rhaeto-Romance	TT	Tatar
EL	Greek	KO	Korean (KOR)	RN	Kirundi	TW	Twi
EO	Esperanto	KS	Kashmiri	RO	Rumanian	UK	Ukrainian
ET	Estonian	KU	Kurdish	RW	Kinyarwanda	UR	Urdu
EU	Basque	KY	Kirghiz	SA	Sanskrit	UZ	Uzbek
FA	Persian	LA	Latin	SD	Sindhi	VI	Vietnamese
FI	Finnish	LN	Lingala	SG	Sangho	VO	Volapuk
FJ	Fiji	LO	Laothian	SH	Serbo-Croatian	WO	Wolof
FO	Faroese	LT	Lithuanian	SI	Singhalese	XH	Xhosa
FY	Frisian	LV	Latvian, Lettish	SL	Slovenian	YO	Yoruba
GA	Irish	MG	Malagasy	SM	Samoan	ZU	Zulu

Playing back sound from an iPod

You can listen to the sound from an iPod. You can also operate the iPod using the remote control of this system.

NOTE

- Depending on your iPod model or playback content, you may not obtain the explained result even after following the operation in this manual.
- This manual explains the operations assuming that you are using an iPod model with a click wheel on its front surface.
- You cannot view the video source and still picture from an iPod on a connected TV.
- Refer also to the operation manual for the iPod.

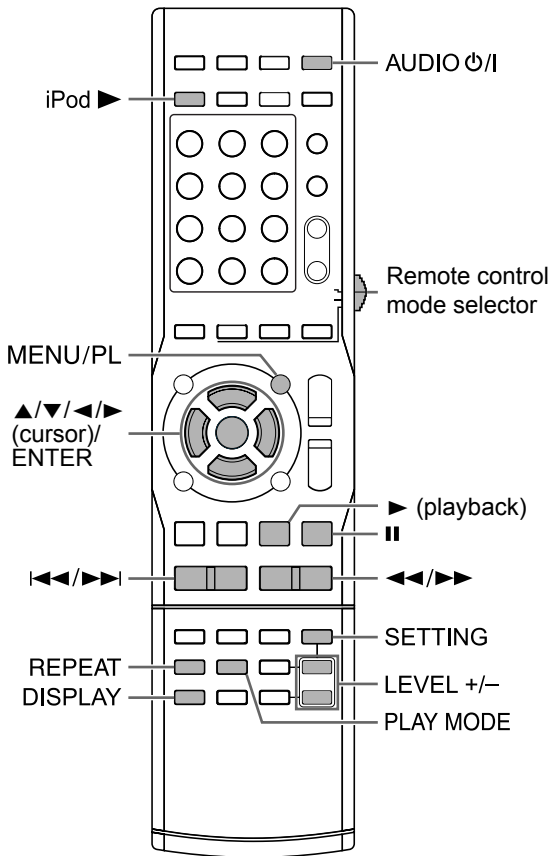

IMPORTANT

- Slide the remote control mode selector to [AUDIO].

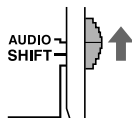

Playing back sound from an iPod

CAUTION

- Before connecting an iPod to the main unit, turn down the volume on the main unit to avoid unexpected loud sound right after the connection is made.
- You cannot use an iPod connected to the [USB MEMORY] terminal. Doing so displays "RESTRICT" or "NO USB" in the display window.

■ When the main unit is turned off

1 Attach the dock adapter and iPod to the docking station for iPod.

- The dock adapter is supplied with the iPod or sold separately.

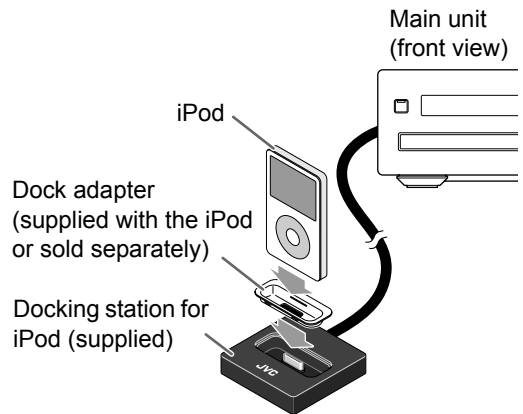

NOTE

- To remove the dock adapter, ① lift the slot with your fingertip, and then ② pull out the dock adapter.
- Before attaching or removing the dock adapter, press [AUDIO 0/I] to turn off the main unit.
- When attaching or removing the dock adapter, be careful not to damage the terminal on the docking station for iPod.

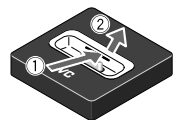

CAUTION

- Do not connect or disconnect the iPod when the main unit is on.
- Do not touch the pins of the iPod or the pins of the docking station for iPod.
- Do not carry the main unit with an iPod connected. You may drop them and damage the connector part.

NOTE

- When you turn off the main unit or select a source other than “iPod” in the display window, the connected iPod enters sleep mode.
- If the sound is distorted when audio sources with high recording levels are played back, deactivate the equalizer on the iPod. You may be able to hear the sound more clearly.
- You cannot send any data from the main unit to the iPod.
- You cannot use the main unit to control an iPod other than those listed on page 45. In this case, you can operate the remote control to deactivate the iPod battery charge function so that you may be able to control the iPod. Refer to page 45.

2 Press [iPod ▶].

- The main unit turns on, “iPod” and then “CONNECT” appear in the display window, and playback starts.
- If “NO CONNE” appears in the display window, press [AUDIO 0/1] to turn off the main unit, and then return to step 1 to securely connect the iPod again.
- Instead of using the remote control in this step, you can use the buttons on the main unit. Repeatedly pressing [SOURCE] can select “iPod” as the source, and pressing ▶ (playback) starts playback.

Operating the iPod using the remote control

The following remote control buttons are assigned to some buttons and functions on the iPod.

Remote control button	iPod button	Basic function
▶ (playback)	▶	Starts playback.
		Pauses playback.
[MENU/PL]	[MENU]	Returns to the previous menu.
[MENU/PL] (when held down)	[MENU] (when held down)	Displays the main menu.
▲/▼ (cursor) *	Click wheel	Selects an item. Changes the volume.
◀/▶ (cursor)	–	Skips to the beginning of a play list.
[ENTER]	Center button	Executes the selected item.
⏮/⏭	⏮/⏭	Skips to the beginning of a track.
⏮/⏭ (when held down)	⏮/⏭ (when held down)	Fast-reverses/fast-forwards playback.
⏪/⏩ (when held down)		
[PLAY MODE]	–	Changes the shuffle playback setting.
[REPEAT]	–	Changes the repeat playback setting.

* Pressing ▲ (cursor) corresponds to turning the click wheel counterclockwise.
Pressing ▼ (cursor) corresponds to turning the click wheel clockwise.

NOTE

- When you cannot operate a connected iPod using the remote control of this system, operate the iPod directly.

Changing the time when the backlight turns on

Press [DISPLAY] repeatedly.

- Each time you press [DISPLAY], the setting changes in the display window as follows.
 - "B.LIGHT1"
Turns on the backlight for approximately 30 seconds after a button is pressed to operate the iPod.
 - "B.LIGHT2"
The backlight stays on.
- The backlight setting of this system has priority over the "Backlight" setting on the iPod.

Charging the battery of the connected iPod

The main unit can charge an iPod battery when the connected iPod is selected as the source.

1 Press [SETTING] repeatedly to select "iPod PWR" in the display window.

2 Press [LEVEL +] or [LEVEL -] repeatedly to select "iPod: ON" in the display window.

- Each time you press [LEVEL +] or [LEVEL -], the battery charging function turns on and off.
- When you want to deactivate the battery charging function, select "iPod: OFF".

Notes on an iPod

- JVC is not responsible for any loss of data on an iPod when used with this system.
- This system can receive sound from the following iPod models.
 - iPod touch
 - iPod classic
 - iPod 5th generation
 - iPod 4th generation
 - iPod nano (1st/2nd/3rd generation)
 - iPod mini (1st/2nd generation)
- If content on the iPod is not played back correctly, update your iPod software to the latest version. For details about updating the iPod, check the Apple web site <<http://www.apple.com>>.

Operating external devices using the remote control

You can operate your TV, digital broadcast satellite (DBS) and video cassette recorder (VCR) using the remote control of this system.

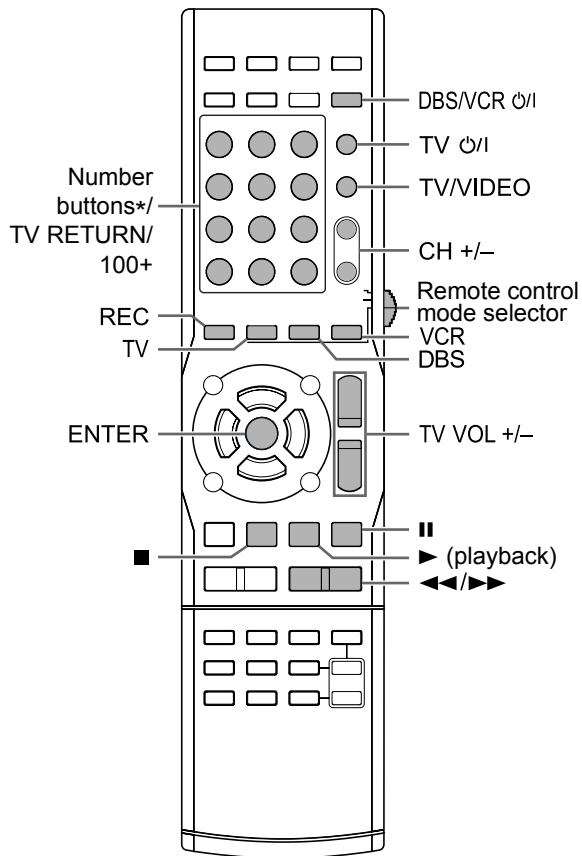

* For the number button usage, refer to "Using the number buttons" on page 11.

Operating a TV using the remote control

Setting the manufacturer code

■ IMPORTANT

- Slide the remote control mode selector to the lowest position.

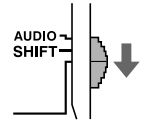

- 1 Press [TV].
- 2 Hold down [TV O/I].
 - Hold down [TV O/I] until you finish step 5.
- 3 Press [ENTER] and release.
- 4 Press number buttons to enter the manufacturer code.

Examples:

For a Hitachi TV: Press [1], then [0].

For a Toshiba TV: Press [0], then [8].

When the manufacturer of your TV has 2 or more codes, select the manufacturer codes in turn and find the one that operates the TV and the remote control properly.

Manufacturer	Code
JVC	01
Hitachi	10
Magnavox	02
Mitsubishi	03
Panasonic	04, 11
Philips	15
RCA	05
Samsung	12, 18, 19, 20, 21
Sanyo	13, 14
Sharp	06, 16, 17
Sony	07
Toshiba	08
Zenith	09

The initial code setting is "01 (JVC)".

- 5 Release [TV O/I].

NOTE

- It is recommended that you slide the remote control mode selector to [AUDIO] after using this function. Most of the other functions can be used when the remote control mode selector is at [AUDIO].
- Manufacturer codes are subject to change without notice. You may not be able to operate the TV produced by the manufacturer.
- After replacing the batteries of the remote control, set the manufacturer code again.

Using the remote control for the TV operation

Before the TV operation, select the remote control mode for the TV.

■ IMPORTANT

- Slide the remote control mode selector to the lowest position.

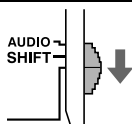

- 1 Press [TV].
- 2 Operate the remote control by pointing it at the TV.

Remote control button	Usage
[TV \odot /I]	Turns on/off the TV.
[TV/VIDEO]	Changes between the TV and video input.
[CH +/-]	Changes channels.
[TV VOL +/-]	Adjusts volume.
Number buttons (1-9, 0, 100+)	Selects the channels.
[TV RETURN]	Changes between the previously selected channel and the current channel.

NOTE

- When the remote control mode selector is slid to the lowest position and [TV] is pressed, some buttons may not work.
- It is recommended that you slide the remote control mode selector to [AUDIO] after using this function. Most of the other functions can be used when the remote control mode selector is at [AUDIO].

Operating a DBS using the remote control

Setting the manufacturer code

■ IMPORTANT

- Slide the remote control mode selector to the lowest position.

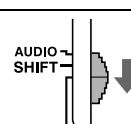

- 1 Press [DBS].
- 2 Hold down [DBS/VCR \odot /I].
 - Hold down [DBS/VCR \odot /I] until you finish step 5.
- 3 Press [ENTER] and release.
- 4 Press number buttons to enter the manufacturer code.

Examples:

For an Echostar DBS: Press [2], then [1].

For a Sony DBS: Press [2], then [0].

When the manufacturer of your DBS has 2 or more codes, select the manufacturer codes in turn and find the one that operates the DBS and the remote control properly.

Manufacturer	Code
G. I.	01, 02, 03, 04, 05, 06, 07, 08
Echostar	21
Hamlin	15, 16, 17, 18
Jerrold	01, 02, 03, 04, 05, 06, 07, 08
Pioneer	13, 14
RCA	19
Scientific Atlanta	09, 10
Sony	20
Zenith	11, 12

The initial code setting is "01 (G.I.)".

- 5 Release [DBS/VCR \odot /I].

NOTE

- It is recommended that you slide the remote control mode selector to [AUDIO] after using this function. Most of the other functions can be used when the remote control mode selector is at [AUDIO].
- Manufacturer codes are subject to change without notice. You may not be able to operate the DBS produced by the manufacturer.
- After replacing the batteries of the remote control, set the manufacturer code again.

Using the remote control for the DBS operation

Before the DBS operation, select the remote control mode for the DBS.

■ IMPORTANT

- Slide the remote control mode selector to the lowest position.

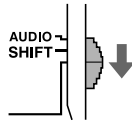

- 1 Press [DBS].
- 2 Operate the remote control by pointing it at the DBS.

Remote control button	Usage
[DBS/VCR \odot /I]	Turns on/off the DBS.
[CH +/-]	Changes channels.
Number buttons (1-9, 0, \cong 10)	Selects the channels.

NOTE

- When the remote control mode selector is slid to the lowest position and [DBS] is pressed, some buttons may not work.
- It is recommended that you slide the remote control mode selector to [AUDIO] after using this function. Most of the other functions can be used when the remote control mode selector is at [AUDIO].

Operating a VCR using the remote control

Setting the manufacturer code

■ IMPORTANT

- Slide the remote control mode selector to the lowest position.

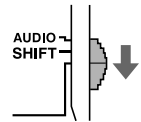

- 1 Press [VCR].
- 2 Hold down [DBS/VCR \odot /I].
 - Hold down [DBS/VCR \odot /I] until you finish step 5.
- 3 Press [ENTER] and release.
- 4 Press number buttons to enter the manufacturer code.

Examples:

For a Hitachi VCR: Press [0], then [4].

For a Mitsubishi VCR: Press [1], then [3].

When the manufacturer of your VCR has 2 or more codes, select the manufacturer codes in turn and find the one that operates the VCR and the remote control properly.

Manufacturer	Code
JVC	01, 02, 03
Emerson	11, 26
Fisher	29
Funai	10, 14, 15, 16
Gold Star	12
Hitachi	04
Mitsubishi	13
NEC	25
Panasonic	07, 17
Philips	09
RCA	05, 06
Samsung	24
Sanyo	21, 22, 23
Sharp	27, 28
Shintom	30
Sony	18, 19, 20
Zenith	08

The initial code setting is "01 (JVC)".

(Continued on the next page)

5 Release [DBS/VCR 0/1].

NOTE

- It is recommended that you slide the remote control mode selector to [AUDIO] after using this function. Most of the other functions can be used when the remote control mode selector is at [AUDIO].
- Manufacturer codes are subject to change without notice. You may not be able to operate the VCR produced by the manufacturer.
- After replacing the batteries of the remote control, set the manufacturer code again.

Using the remote control for the VCR operation

Before the VCR operation, select the remote control mode for the VCR.

■ IMPORTANT

- Slide the remote control mode selector to the lowest position.

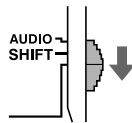

1 Press [VCR].

2 Operate the remote control by pointing it at the VCR.

Remote control button	Usage
[DBS/VCR 0/1]	Turns on/off the VCR.
[CH +/-]	Changes channels.
Number buttons (1-10, 0, ≥10)	Selects the channels.
▶ (playback)	Starts playback.
■	Stops playback.
	Pauses playback.
▶▶	Fast-forwards the tape.
◀◀	Fast-rewinds the tape.
[REC] + ▶ (playback)	Starts recording.
[REC] +	Pauses recording.

NOTE

- When the remote control mode selector is slid to the lowest position and [VCR] is pressed, some buttons may not work.
- It is recommended that you slide the remote control mode selector to [AUDIO] after using this function. Most of the other functions can be used when the remote control mode selector is at [AUDIO].

Basic operations of HDMI CEC

Consumer Electronics Control (CEC) is device controlling signals optionally employed for the High-Definition Multimedia Interface (HDMI) standard. When devices equipped with CEC are connected, each device can control the others.

This system is compatible with some basic functions of HDMI CEC.

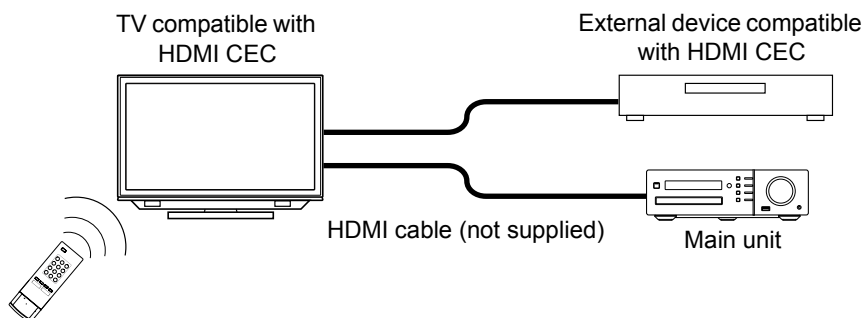

- When you start playback on the main unit, the connected TV automatically turns on.
- When you select the main unit as the source of the TV, picture and sound from the main unit are automatically produced.
- When you turn off the TV, the main unit automatically turns off. (This function works when “ON 1” is selected for “CEC” in the preference screen. Refer to page 40.)
- When you select the menu screen language of the TV, and then the main unit is turned off and turned on again, the same language is automatically selected on the main unit. (The selectable languages are limited to those supported by this system.)
- As long as the connected TV is compatible, you can use the operations of the TV to start playback, adjust the volume and operate other functions on the main unit.

NOTE

- This function is available only when the source is set to “DVD” or “USB”.
- This function is available when “ON 1” or “ON 2” is selected for “CEC” in the preference screen (refer to page 40).
- For details about the CEC function, refer to the operations manuals of the connected CEC devices.
- If the power cable is not connected to an AC outlet, the CEC function does not work, even when the main unit is connected to CEC devices.
- Not all HDMI devices are compatible with CEC. If the main unit is connected to non-CEC compatible devices, these devices cannot be controlled using the CEC function.
- The CEC function may not work with some CEC devices. (When the main unit is connected to a non-JVC product, the CEC function may not work.)
- The CEC function may not work depending on the settings or status of the main unit or the connected CEC devices.
- When connecting the main unit to a TV with an HDMI cable for the first time after purchase, confirm that “JVC” (the initial screen) appears.
- When you disconnect the HDMI cable and connect it again, confirm that “JVC” appears.
- If the CEC function does not work properly, select “OFF” for the “CEC” setting, and then select “ON 1” or “ON 2” again. (Refer to page 40.)

Notes on operation

Suitable locations for the main unit

To minimize the need for servicing and maintain the high quality of this system, do not place the main unit in the following locations:

- In a position subject to high humidity or considerable dust
- On an uneven or unstable surface
- Near a heat source
- Near a computer, fluorescent light or other electric appliance
- In a small room with insufficient ventilation
- In a position exposed to direct sunlight
- In a position exposed to excessive cold
- In a position exposed to strong vibration
- Near a TV, other amplifier, or tuner
- Near a magnetic source

CAUTION

- The operating temperature of this system is 5°C to 35°C (41°F to 95°F). Use in temperatures outside this range may cause a malfunction or damage the system.

Condensation

Under the following conditions, you may not be able to operate this system properly due to condensation formed on the lens of the main unit:

- When you have just started an air conditioner to warm your room
- When you have placed the main unit at an area with high humidity
- When you have moved the main unit from a cold place to a warm place

When condensation forms, leave the main unit turned on, wait for approximately 1 or 2 hours, and then operate the main unit.

Cleaning the main unit

When the operation panel becomes dirty, dust it with a soft dry cloth. When the operation panel is very dirty, wipe it with a cloth dampened with a small amount of a neutral detergent, and then wipe it with a soft dry cloth.

CAUTION

- Do not wipe the operation panel with thinners, benzenes or other chemical agents. Do not spray insecticides onto the operation panel. These may discolor and damage the surface.

Notes on handling

Important cautions

Installation of the system

- Select a place that is level, dry and neither too hot nor too cold, and between 5°C and 35°C (between 41°F and 95°F).
- Leave sufficient distance between the system and the TV.
- Do not use the system in a place subject to vibration.

Power cable

- Do not handle the power cable with wet hands!
- A small amount of power is always consumed while the power cable is connected to the wall outlet.
- When unplugging the power cable from the wall outlet, always pull on the plug, not the power cable.

To prevent malfunctions of the system

- There are no user-serviceable parts inside. If anything goes wrong, unplug the power cable and consult your dealer.
- Do not insert any metallic object into the system.

Note about copyright laws

Check the copyright laws in your country before recording from CDs. Recording of copyrighted material may infringe copyright laws.

Safety Precautions

Avoid moisture, water and dust

Do not place the system in moist or dusty places.

Avoid high temperatures

Do not expose the system to direct sunlight and do not place it near heating equipment.

When you are away

When away on travel or for other reasons for an extended period of time, disconnect the power cable plug from the wall outlet.

Do not block the vents

Blocking the vents may damage the system.

Care of the cabinet

When cleaning the system, use a soft cloth and follow the relevant instructions on the use of chemically-coated cloths. Do not use benzene, thinner or other organic solvents including disinfectants. These may cause deformation or discoloring.

If water gets inside the system

Turn the system off and disconnect the power cable plug from the wall outlet, then call the store where you made your purchase. Using the system in this condition may cause fire or electrical shock.

License and trademark

- This product incorporates copyright protection technology that is protected by U.S. patents and other intellectual property rights. Use of this copyright protection technology must be authorized by Macrovision, and is intended for home and other limited viewing uses only unless otherwise authorized by Macrovision. Reverse engineering or disassembly is prohibited.
- CONSUMERS SHOULD NOTE THAT NOT ALL HIGH DEFINITION TELEVISION SETS ARE FULLY COMPATIBLE WITH THIS PRODUCT AND MAY CAUSE ARTIFACTS TO BE DISPLAYED IN THE PICTURE. IN CASE OF 525 OR 625 PROGRESSIVE SCAN PICTURE PROBLEMS, IT IS RECOMMENDED THAT THE USER SWITCH THE CONNECTION TO THE "STANDARD DEFINITION" OUTPUT. IF THERE ARE QUESTIONS REGARDING OUR TV SET COMPATIBILITY WITH THIS MODEL 525p AND 625p DVD PLAYER, PLEASE CONTACT OUR CUSTOMER SERVICE CENTER.
- USE OF THIS PRODUCT IN ANY MANNER THAT COMPLIES WITH THE MPEG-4 VISUAL STANDARD IS PROHIBITED, EXCEPT FOR USE BY A CONSUMER ENGAGING IN PERSONAL AND NON-COMMERCIAL ACTIVITIES.
- DivX, DivX Ultra Certified, and associated logos are trademarks of DivX, Inc. and are used under license.
- Official DivX® Ultra Certified product
- Plays all versions of DivX® video (including DivX® 6) with enhanced playback of DivX® media files and the DivX® Media Format
- Microsoft and Windows Media are either registered trademarks or trademarks of Microsoft Corporation in the United States and/or other countries.
- DVD Logo is a trademark of DVD Format/Logo Licensing Corporation.
- Manufactured under license from Dolby Laboratories. "Dolby", "Pro Logic", "MLP Lossless", and the double-D symbol are trademarks of Dolby Laboratories.
- "DTS" and "DTS Digital Surround" are registered trademarks of DTS, Inc.
- HDMI, the HDMI logo and High-Definition Multimedia Interface are trademarks or registered trademarks of HDMI Licensing LLC.
- HDCP is the abbreviation of "High-bandwidth Digital Content Protection," and is the high-reliable copy control technology licensed by Digital Content Protection, LLC.
- iPod is a trademark of Apple Inc., registered in the U.S. and other countries.

Notes on discs/files

Playable disc/file types

Playable discs * ¹	DVD VIDEO, DVD AUDIO, DVD VR * ³ , VCD, SVCD, CD, CD-R * ⁴ , CD-RW * ⁴ , DVD-R * ⁵ , * ⁶ , DVD-RW * ⁶ , +R, +RW
Playable files recorded on a disc * ¹	MP3, WMA, WAV, JPEG, ASF, DivX, MPEG1, MPEG2
Playable files recorded on a USB device * ²	

• Even though listed above, some types may be unplayable.

*¹ Discs should be finalized before being played back.

*² This system may not recognize some USB devices. This system cannot play back a file whose data volume is more than 2 gigabytes and a file whose data transfer rate is more than 2 Mbps.

*³ DVD VR means a DVD-R/DVD-RW recorded in Video Recording (VR) format.

*⁴ A CD-R/CD-RW recorded in multi-session format (up to 20 sessions) is playable.

*⁵ A DVD-R recorded in multi-border format is also playable (including dual layer discs).

*⁶ For files recorded on a DVD-R/DVD-RW, the disc should be formatted with UDF Bridge.

It is possible to play back finalized +R/+RW (DVD Video Format only) discs. "DVD" lights on the front display panel when a +R/+RW disc is loaded.

Some discs may not be played back because of their disc characteristics, recording conditions, or damage or stains on them.

Only sounds can be played back from the following discs:

MIX-MODE CD	CD-G
CD-EXTRA	CD TEXT

This system is designed for use with the NTSC standard.

Region code of DVD VIDEO

DVD VIDEO players and DVD VIDEO discs have their own region code numbers. This system can play back a DVD VIDEO whose region code number includes the system's region code, which is indicated on the rear panel of the main unit.

Examples:



If a DVD VIDEO with an improper region code number is loaded, playback cannot start.

• **On some DVD VIDEOS, DVD AUDIOS, VCDs, SVCDs or DivX files, their actual operation may be different from what is explained in this manual. This is due to the disc/file programming and disc/file structure, not a malfunction of this system.**

Unplayable discs

- The following discs cannot be played back:
- DVD-ROM (except for MP3/WMA/JPEG/ASF/DivX/MPEG1/MPEG2 format), DVD-RAM, CD-ROM, CD-I (CD-I Ready), Photo CD, SACD, etc.
- Playing back these discs generates noise and may damage the speakers.
- Damaged discs and discs with an unusual shape (other than a disc of 12 cm or 8 cm ($4\frac{3}{4}$ " or $3\frac{3}{16}$ " in diameter) cannot be played back.
- JVC does not guarantee the operation and sound quality of discs not authorized by CD-DA, which is a CD specification.
Before playback, confirm that the disc complies with this CD specification by checking the marks and reading notes printed on the package.

Playable MP3/WMA/WAV/JPEG/ASF/DivX/MPEG1/MPEG2 discs/files

- CDs recorded in the ISO 9660 format are playable (except CDs recorded in the "packet write" format (UDF format)).
- Files with an extension of ".mp3", ".wma", ".wav", ".jpg", ".jpeg", ".asf", ".divx", ".div", ".avi", ".mpg", ".mpeg" or ".mod" (extensions with mixed cases are also acceptable) are playable.

Notes on MP3/WMA/WAV/JPEG/ASF discs/files

- A disc may not be played back, or reading it may take a long time depending on its recording conditions or properties.
- The time needed for reading varies with the number of groups or tracks (files) recorded on the disc.
- If characters other than single-byte alphanumeric characters are used in the file name of an MP3/WMA/WAV/JPEG/ASF file, the track/file name is not displayed correctly.
- The order of tracks/groups displayed on the MP3/WMA/WAV menu screen, and the order of files/groups displayed on the JPEG menu screen may be different from that of files/folders displayed on a computer monitor screen.
- Playing back an MP3/WMA file that contains a still image may take a long time. The elapsed time is not displayed until playback starts. This elapsed time may not be displayed correctly.
- For an MP3/WMA file, a disc with a sampling frequency of 44.1 kHz and transmission rate of 128 kbps is recommended.
- This system is not compatible with an MP3i or MP3PRO file.
- This system can play back a baseline JPEG file, excluding monochromatic JPEG files.
- This system can play back JPEG data taken with a digital camera conforming to the DCF (Design Rule for Camera File System) standard (when a function such as the automatic rotation function of a digital camera is applied, the data may no longer conform to the DCF standard, and the image may not be displayed).
- If data has been processed, edited or restored with computer image editing software, the data may not be displayed.
- This system cannot play back animations such as MOTION JPEG files, still pictures (TIFF etc.) other than JPEG files, or image data with sound.
- The resolution of 640 x 480 pixels is recommended for JPEG files. If a file has been recorded at a resolution of more than 640 x 480 pixels, it may take a long time to display the file. An image with a resolution of more than 8 192 x 7 680 pixels cannot be displayed.
- The system supports ASF files recorded with the maximum bit rate of 384 kbps and an audio coder decoder of G.726.
- A WAV file with a sampling frequency of 44.1 kHz and a quantization bit rate of 16 bits is recommended.

Notes on DivX discs/files

- The system supports DivX 5.x, 4.x and 3.11.
- The system supports DivX files with a resolution of 720 x 480 pixels or less (30 fps) and 720 x 576 pixels or less (25 fps).
- Audio streams should conform to MPEG1 Audio Layer-2, MPEG Audio Layer-3 (MP3) or Dolby Digital.
- The system does not support GMC (Global Motion Compression).
- Files encoded in the interlaced scanning mode may not be played back correctly.
- Playing back a DivX file may take a long time. The elapsed time is not displayed until playback starts. The elapsed time may also not be displayed correctly.

Notes on MPEG1/MPEG2 discs/files

- The stream structure of MPEG1/MPEG2 discs and files should conform to MPEG system/program stream.
- 720 x 576 pixels (25 fps)/720 x 480 pixels (30 fps) is recommended for the highest resolution.
- This system also supports the resolutions of 352 x 576/480 x 576/352 x 288 pixels (25 fps) and 352 x 480/480 x 480/352 x 240 pixels (30 fps).
- The profile and level should be MP@ML (Main Profile at Main Level)/SP@ML (Simple Profile at Main Level)/MP@LL (Main Profile at Low Level).
- Audio streams should conform to MPEG1 Audio Layer-2, MPEG2 Audio Layer-2 or Dolby Digital (MPEG2 files only).

Caution for DualDisc playback

The Non-DVD side of a “DualDisc” does not comply with the “Compact Disc Digital Audio” standard. Therefore, the use of Non-DVD side of a DualDisc on this product is not recommended.

Notes on files recorded on a connected USB device

- This system is compatible with USB 2.0 Full-Speed.
- This system may not play back some USB devices and some files.
- This system does not support DRM (Digital Rights Management).
- This system cannot recognize a USB device whose rating exceeds 5V/500mA.
- When connecting a USB device, refer also to its manual.
- Connect the USB device directly to the main unit without routing through a USB hub.
- Disconnect the USB device after stopping playback or turning off this system.
- The main unit can charge a USB device when the USB device is selected as the source.
- Always set the volume to the minimum on this system when connecting or disconnecting a USB device.
- JVC bears no responsibility for any loss of data on the USB device while using this system.

Data hierarchy

DVD VIDEO/DVD VR

A DVD VIDEO consists of "titles" and each title may be divided into "chapters".

A DVD VR consists of "original programs" or "play lists" and each original program/play list may be divided into "chapters".

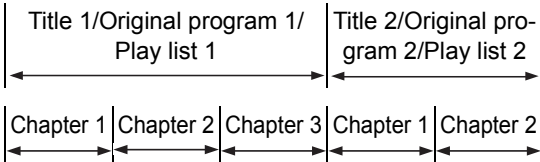

DVD AUDIO

A DVD AUDIO consists of "groups" and each group may be divided into "tracks".

Some discs include a "bonus group" that requires a password for playback. (Refer to page 34.)

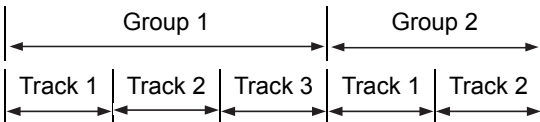

VCD/SVCD/CD

A VCD/SVCD/CD consists of "tracks".

In general, each track has its own track number. (On some discs, each track may also be further divided by indexes.)

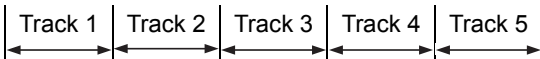

MP3/WMA/WAV/JPEG/ASF/DivX/MPEG1/ MPEG2 files

Audio, still pictures and video are recorded as tracks/files on a disc or a USB device. Tracks/files are usually grouped into a folder. Folders can also include other folders, creating hierarchical folder layers.

This system simplifies the hierarchical construction of files and manages folders by "groups".

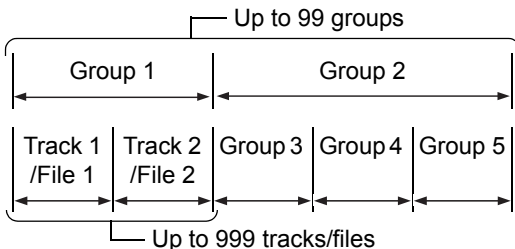

This system can recognize up to 4 000 tracks/files on a disc. Also, the system can recognize up to 999 tracks/files per group and up to 99 groups on a disc. Since the system ignores the tracks/files with numbers exceeding 999 and the groups with numbers exceeding 99, these cannot be played back. If there are any type of files other than MP3/WMA/WAV/JPEG/ASF/DivX/MPEG1/MPEG2 files on a disc, those files are also counted in the total number of files.

Handling discs

- Do not use a commercially-available non-standard shape disc (like a heart, flower or credit card, etc.), because it may damage the system.
- Do not use a disc with tape, stickers, or paste on it, because it may damage the system.
- Do not bend the disc.

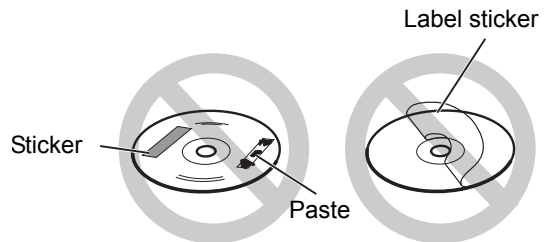

Cleaning discs



Wipe the disc from the center outward with a soft cloth.

- Scratches concentrated on a certain part cause sound dropout.
- Be sure not to use thinners, benzenes, cleaners for analog records, or other chemical agents.

Troubleshooting

■ General

Problem	Possible cause	Possible solution	Reference page
Power does not come on.	The power cable is not connected to an AC outlet.	Connect the power cable correctly.	9
You cannot operate any button.	Some specific operations are restricted.	This is not a malfunction.	–
The remote control does not work.	The batteries are running low.	Replace the batteries.	4
You cannot operate the main unit using the remote control.	Function assigned to some buttons change according to the remote control mode.	Slide the remote control mode selector to [AUDIO], [SHIFT] or the lowest position to select an appropriate mode to your desired function.	–
A whirring noise can be heard.	The main unit is located close to a TV, computer, or other electric appliance.	Place the main unit away from a TV, computer, or other electric appliance.	51
No picture is produced.	Improper connection.	Connect all cables properly.	8-9
The picture is distorted.	A video cassette recorder is connected between the main unit and the TV.	Connect the main unit directly to the TV.	8
	The video signal type setting is not appropriate.	Select the video signal type suitable for your TV.	10
The screen size is abnormal.	The screen size setting is not appropriate.	Select the display method suitable for your TV.	39
The TV screen darkens.	The screen saver setting is activated.	Press any button.	39
No picture/sound is produced via the [HDMI MONITOR OUT] terminal.	A disc/file recorded in a format incompatible with the main unit/TV is played back.	Confirm the playable disc/file types.	53
	The connected TV is not compatible with HDCP.	Connect a TV compatible with HDCP.	8
	The main unit fails to recognize the TV connected to the [HDMI MONITOR OUT] terminal.	Disconnect the HDMI cable and connect it again.	8
	An HDMI cable longer than 5 m (15 feet) is used.	Use an HDMI cable of 5 m (15 feet) or shorter to assure stable operation and picture quality.	–
The picture is distorted when the TV is connected to the [HDMI MONITOR OUT] terminal.	The proportion of the picture is not appropriate.	Connect the TV to the [VIDEO] terminal or the [COMPONENT] terminals, and select the video signal type setting.	8-10

■ General (continued)

Problem	Possible cause	Possible solution	Reference page
No sound is produced.	The speakers are not connected correctly.	Connect the speakers correctly.	6
	Headphones are connected.	Disconnect the headphone plug.	13
	The sound is turned off.	Restore the sound.	12
	If "NO AUDIO" is displayed in the display window, the disc may have been produced through illegal copying.	Check the disc at the store where it was purchased.	–
The sound is weak and can hardly be heard.	The volume level is low.	Increase the volume level.	12
The sound is distorted.	The volume is too high.	Turn down the volume.	12
A radio broadcast has interference from noise.	The antennas are not connected correctly.	Connect the antennas correctly.	5
A radio broadcast cannot be received.			
A noise is produced from the rear of the main unit.	The internal cooling fan produces the noise as the fan rotates.	The noise is not a malfunction. The cooling fan is used to prevent overheating of the main unit.	11
The HDMI CEC function does not work.	The connected TV is not compatible with the HDMI CEC function.	Refer to the operation manual of the TV.	–
	"OFF" is selected for the "CEC" setting.	Select "ON 1" or "ON 2" for the "CEC" setting.	40
When you disconnect the HDMI cable and connect it again, the HDMI CEC function does not work properly.	The previous connection setting is stored on the main unit.	Select "OFF" for the "CEC" setting, and then select "ON 1" or "ON 2" again.	50

(Continued on the next page)

■ For a loaded disc

Problem	Possible cause	Possible solution	Reference page
A disc cannot be played back.	If "REGION CODE ERROR!" appears on the TV screen, the region code number of a disc is not compatible with this system. (only for a DVD VIDEO)	Confirm the region code number compatible with this system.	53
	If "CANNOT PLAY THIS DISC" appears on the TV screen, the disc cannot be played back with this system.	Confirm the disc type playable with this system.	53
	The disc is upside down.	Place the disc on the disc tray with the printed surface facing up.	18
	Moisture has condensed on the lens.	Leave the main unit turned on, wait for approximately 1 or 2 hours, and then operate the main unit.	51
You cannot change the audio language/subtitle language/view angle.	The disc/file does not contain multiple audio languages/subtitle languages/view angles.	If only one audio language/subtitle language/view angle is recorded on the disc, you cannot change the setting.	32 and 36
No subtitles are displayed.	The disc/file contains no subtitles.	If no subtitles are recorded on the disc/file, you cannot display subtitles.	32
	You have not selected the subtitle language.	Select the subtitle language.	32
"LR ONLY" is displayed in the display window. (only for a DVD AUDIO)	When you play back a track for which down-mixing is prohibited and with multi-channel sound, the left and right sounds are output directly as they are.	This is not a malfunction.	–
A certain point on the disc cannot be played back properly.	The disc is scratched or dirty.	Clean or replace the disc.	56
MP3, WMA, WAV, JPEG, ASF, DivX, MPEG1 or MPEG2 file cannot be played back.	The loaded disc may include files of different types (MP3, WMA, WAV, JPEG, ASF, DivX, MPEG1 or MPEG2).	Select "FILE TYPE". You can play back only the files of the types selected with "FILE TYPE". If the main unit has read the file before you make the "FILE TYPE" setting, reset "FILE TYPE" to the desired file type, and then reload the disc.	39
The disc cannot be ejected.	Disc ejection is locked.	Unlock the disc ejection.	14

■ For a connected USB device

Problem	Possible cause	Possible solution	Reference page
Files on a USB device cannot be played back.	If "CANNOT PLAY THIS DEVICE" appears on the TV screen, the files on a USB device are not playable.	Check that the file types recorded on the USB device are compatible with this system.	53
MP3, WMA, WAV, JPEG, ASF, DivX, MPEG1 or MPEG2 file cannot be played back.	The connected USB device may include files of different types (MP3, WMA, WAV, JPEG, ASF, DivX, MPEG1 or MPEG2).	Select "FILE TYPE". You can play back only the files of the types selected with "FILE TYPE". If the main unit has read the file before you make the "FILE TYPE" setting, reset "FILE TYPE" to the desired file type, and then disconnect the USB device and connect it again.	39

■ For a connected iPod

Problem	Possible cause	Possible solution	Reference page
Content on an iPod cannot be played back even though "CONNECT" is displayed in the display window.	The battery of the iPod is running low.	Charge the battery.	45
The iPod cannot be controlled from the main unit.	The iPod is not compatible with the main unit.	Confirm the playable iPod type.	45
	The iPod battery charge function is deactivated.	Activate the function.	45
The main unit does not charge the iPod.	An item other than "iPod" is selected as the source.	Select "iPod".	44

If this system does not work properly even after taking the action in the above "Possible solution"

Many functions of this system are controlled by microprocessors that can be reset by recycling the power supply. If pressing any button does not result in the normal action, disconnect the power cable from the outlet, wait for a while, and connect the power cable again.

Specifications

Main unit (XV-THF3)

Tuner

FM frequency: 87.5 MHz – 108.0 MHz
AM frequency: 530 kHz – 1 710 kHz

Terminal (front of the main unit)

- USB digital input terminal x 1
- Audio output headphone terminal x 1
Impedance: 16 Ω – 1 kΩ

Terminal (rear of the main unit)

- Audio output speaker terminals x 1
Left/right speakers:
 - Output power: 200 W (50 W x 4) at 3 Ω
(1 kHz/10 % THD)
 - Impedance: 3 Ω – 16 ΩSubwoofer
 - Output power: 150 W at 6 Ω
(100 Hz/10 % THD)
 - Impedance: 6 Ω – 16 Ω
- Optical digital input terminal x 1
–23 dBm to –15 dBm
- Optical digital output terminal x 1
–23 dBm to –15 dBm
- iPod analog input terminal x 1
- Component video output terminals x 1
Y: 1.0 V_{p-p}, 75 Ω terminated
P_B: 0.7 V_{p-p}, 75 Ω terminated
P_R: 0.7 V_{p-p}, 75 Ω terminated
- Composite video output terminal x 1
1.0 V_{p-p}, 75 Ω terminated
- Audio input terminals x 1
500 mV/47 kΩ
- HDMI monitor output terminal x 1
- FM antenna terminal x 1
- AM antenna terminal x 1

USB

Compatible with USB 2.0 Full-Speed
Compatible device: USB mass storage class device
Compatible file system: FAT16, FAT32
Output power: DC 5 V = 500 mA

iPod

Output power: DC 5 V = 500 mA

HDMI

Output power: DC 5 V = 55 mA

General

Power source: AC 120 V ~, 60 Hz
Power consumption (in operation): 90 W
Power consumption (on standby): 0.8 W
Dimensions (W x H x D) [including projecting parts]:
300 mm x 95 mm x 295 mm
(11¹³/₁₆" x 3³/₄" x 11⁵/₈")
Mass: 3.4 kg (7.5 lbs)

Speaker (SP-THF3F)

Type: 1-way bass reflex type
Magnetically shielded type

Speaker driver:
Front ch: 5.5 cm (2³/₁₆") cone
Surround ch: 5.5 cm (2³/₁₆") cone

Power handling capacity:
Front ch: 50W
Surround ch: 50W

Impedance: 3 Ω

Frequency range: 80 Hz - 20 kHz

Sound pressure level: 77 dB/W•m

Dimensions (W x H x D) [including projection parts]:
88 mm x 184 mm x 125 mm
(3¹/₂" x 7¹/₄" x 4¹⁵/₁₆")

Mass (1 speaker): 1.2 kg (2.7 lbs)

Subwoofer (SP-THF3W)

Type: Bass reflex type

Speaker driver: 16 cm (6⁵/₁₆") cone

Power handling capacity: 150 W

Impedance: 6 Ω

Frequency range: 30 Hz - 200 Hz

Sound pressure level: 76 dB/W•m

Dimensions (W x H x D): 300 mm x 301 mm x 305 mm
(11¹³/₁₆" x 11⁷/₈" x 12¹/₁₆")

Mass: 8.2 kg (18.1 lbs)

Supplied accessories

Remote control x 1
Batteries x 2
FM antenna x 1
AM loop antenna x 1
Composite video cable x 1
Docking station for iPod x 1

Designs and specifications are subject to change without notice.



LIMITED WARRANTY

USA ONLY

ONLY FOR PRODUCT PURCHASED IN U.S.A.

CONSUMER VIDEO 1-90

JVC COMPANY OF AMERICA (JVC) warrants this product and all parts thereof, except as set forth below ONLY TO THE ORIGINAL RETAIL PURCHASER to be FREE FROM DEFECTIVE MATERIALS AND WORKMANSHIP from the date of original purchase for the period shown below. ("The Warranty Period")

Table with 2 columns: PARTS (1 YR), LABOR (90 DAYS)

THIS LIMITED WARRANTY IS VALID ONLY IN THE FIFTY (50) UNITED STATES, THE DISTRICT OF COLUMBIA AND IN THE COMMONWEALTH OF PUERTO RICO.

WHAT WE WILL DO:

If this product is found to be defective within the warranty period, JVC will repair or replace defective parts with new or rebuilt equivalents at no charge to the original owner. Such repair and replacement services shall be rendered by JVC during normal business hours at JVC authorized service centers. Parts used for replacement are warranted only for the remainder of the Warranty Period. All products may be brought to a JVC authorized service center on a carry-in basis. Color televisions with a screen size of 27" or greater qualify for in-home service. In such cases, a technician will come to your home and either repair the TV there or remove and return it if it cannot be repaired in your home.

WHAT YOU MUST DO FOR WARRANTY SERVICE:

Please do not return your product to the retailer

Instead, return your product to the JVC authorized service center nearest you. If shipping the product to the service center, please be sure to package it carefully, preferably in the original packaging, and include a brief description of the problem(s). Please call 1-800-252-5722 to locate the nearest JVC authorized service center. Service locations can also be obtained from our website http://www.jvc.com. If your product qualifies for in-home service, the service representative will require clear access to the product.

If you have any questions concerning your JVC Product, please contact our Customer Relations Department at 800-252-5722

WHAT IS NOT COVERED:

This limited warranty provided by JVC does not cover:

- 1. Products which have been subject to abuse, accident, alteration, modification, tampering, negligence, misuse, faulty installation, lack of reasonable care, or if repaired or serviced by anyone other than a service facility authorized by JVC to render such service, or if affixed to any attachment not provided with the products, or if the model or serial number has been altered, tampered with, defaced or removed;
2. Initial installation, installation and removal from cabinets or mounting systems.
3. Operational adjustments covered in the Owner's Manual, normal maintenance, video and audio head cleaning;
4. Damage that occurs in shipment, due to act of God, and cosmetic damage;
5. Signal reception problems and failures due to line power surge;
6. User Removal Memory Devices/Video Pick-up Tubes/CCD Image Sensors are covered for 90days from the date of purchase;
7. Accessories;
8. Batteries (except that Rechargeable Batteries are covered for 90 days from the date of purchase);
9. Products used for commercial purposes, including, but not limited to rental.
10. Loss of data resultant from malfunction of hard drive or other data storage device.

There are no express warranties except as listed above.

THE DURATION OF ANY IMPLIED WARRANTIES, INCLUDING THE IMPLIED WARRANTY OF MERCHANTABILITY, IS LIMITED TO THE DURATION OF THE EXPRESS WARRANTY HEREIN.

JVC SHALL NOT BE LIABLE FOR ANY LOSS OF USE OF THE PRODUCT, INCONVENIENCE, OR ANY OTHER DAMAGES, WHETHER DIRECT, INCIDENTAL OR CONSEQUENTIAL (INCLUDING, WITHOUT LIMITATION, DAMAGE TO TAPES, RECORDS OR DISCS) RESULTING FROM THE USE OF THIS PRODUCT, OR ARISING OUT OF ANY BREACH OF THIS WARRANTY. ALL EXPRESS AND IMPLIED WARRANTIES, INCLUDING THE WARRANTIES OF MERCHANTABILITY AND FITNESS FOR PARTICULAR PURPOSE, ARE LIMITED TO THE WARRANTY PERIOD SET FORTH ABOVE.

Some states do not allow the exclusion of incidental or consequential damages or limitations on how long an implied warranty lasts, so these limitations or exclusions may not apply to you. This warranty gives you specific legal rights and you may also have other rights which vary from state to state.

JVC COMPANY OF AMERICA 1700 Valley Road
DIVISION OF JVC AMERICAS CORP. Wayne, NJ 07470
http://www.jvc.com

REFURBISHED PRODUCTS CARRY A SEPARATE WARRANTY, THIS WARRANTY DOES NOT APPLY. FOR DETAIL OF REFURBISHED PRODUCT WARRANTY, PLEASE REFER TO THE REFURBISHED PRODUCT WARRANTY INFORMATION PACKAGED WITH EACH REFURBISHED PRODUCT.

For customer use:
Enter below the Model No. and Serial No. which is located either on the rear, bottom or side of the cabinet. Retain this information for future reference.
Model No. : _____ Serial No. : _____
Purchase date : _____ Name of dealer : _____

For U.S.A.

TO OUR VALUED CUSTOMER _____

THANK YOU FOR PURCHASING THIS JVC PRODUCT.
WE WANT TO HELP YOU ACHIEVE A PERFECT EXPERIENCE.

**NEED HELP ON HOW TO HOOK UP?
NEED ASSISTANCE ON HOW TO OPERATE?
NEED TO LOCATE A JVC SERVICE CENTER?
LIKE TO PURCHASE ACCESSORIES?**

JVC[®] IS HERE TO HELP!
TOLL FREE: 1(800)252-5722
<http://www.jvc.com>

Remember to retain your Bill of Sale for Warranty Service.

_____ **Do not attempt to service the product yourself** _____

Caution

To prevent electrical shock, do not open the cabinet.
There are no user serviceable parts inside.
Please refer to qualified service personnel for repairs.

BT-51005-9
(0904)

JVC



Free Manuals Download Website

<http://myh66.com>

<http://usermanuals.us>

<http://www.somanuals.com>

<http://www.4manuals.cc>

<http://www.manual-lib.com>

<http://www.404manual.com>

<http://www.luxmanual.com>

<http://aubethermostatmanual.com>

Golf course search by state

<http://golfingnear.com>

Email search by domain

<http://emailbydomain.com>

Auto manuals search

<http://auto.somanuals.com>

TV manuals search

<http://tv.somanuals.com>