

JVC



DVD DIGITAL CINEMA SYSTEM

TH-M45

Consists of XV-THM45, SP-PWM45, SP-THM45C, SP-THM45F and SP-THM45S

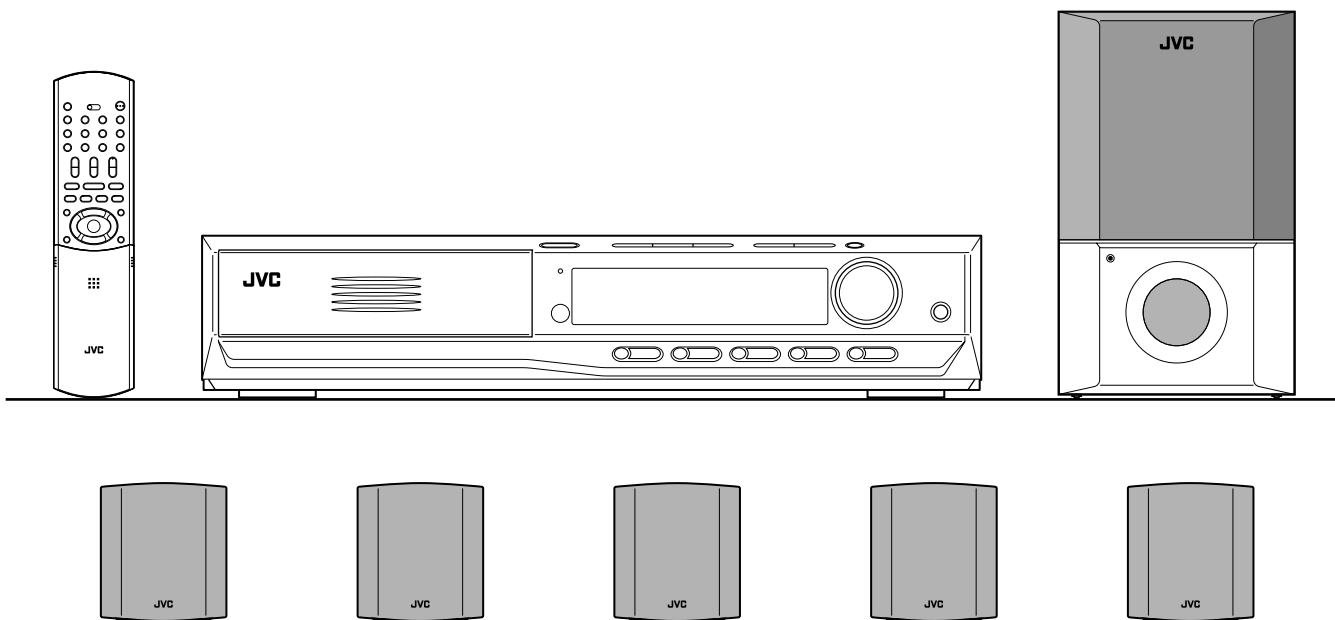

INSTRUCTIONS

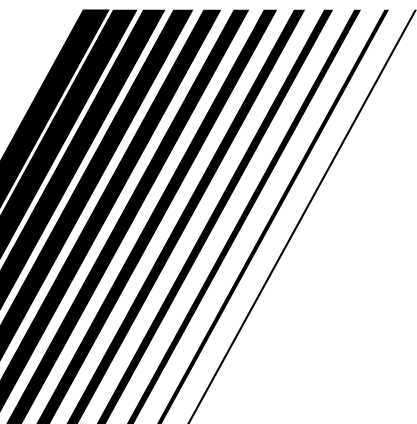

Warnings, Cautions and Others

IMPORTANT for the U.K.

DO NOT cut off the mains plug from this equipment. If the plug fitted is not suitable for the power points in your home or the cable is too short to reach a power point, then obtain an appropriate safety approved extension lead or consult your dealer.

BE SURE to replace the fuse only with an identical approved type, as originally fitted.

If nonetheless the mains plug is cut off ensure to remove the fuse and dispose of the plug immediately, to avoid a possible shock hazard by inadvertent connection to the mains supply.

If this product is not supplied fitted with a mains plug then follow the instructions given below:

IMPORTANT.

DO NOT make any connection to the terminal which is marked with the letter E or by the safety earth symbol or coloured green or green-and-yellow.

The wires in the mains lead on this product are coloured in accordance with the following code:

Blue: Neutral

Brown: Live

As these colours may not correspond with the coloured markings identifying the terminals in your plug proceed as follows:

The wire which is coloured blue must be connected to the terminal which is marked with the letter N or coloured black.

The wire which is coloured brown must be connected to the terminal which is marked with the letter L or coloured red.

IF IN DOUBT - CONSULT A COMPETENT ELECTRICIAN.

CAUTION

To reduce the risk of electrical shocks, fire, etc.:

1. Do not remove screws, covers or cabinet.
2. Do not expose this appliance to rain or moisture.

CAUTION – button! (XV-THM45)

Disconnect the mains plug to shut the power off completely (the STANDBY lamp goes off).

The  button in any position does not disconnect the mains line.

- When the system is on standby, the STANDBY lamp lights red.
- When the system is turned on, the STANDBY lamp goes off.

The power can be remote controlled.

CAUTION (SP-PWM45)

The power supply to the subwoofer is linked to the center unit. The POWER ON lamp on the subwoofer lights green when the power is turned on.

CAUTION

- Do not block the ventilation openings or holes.
(If the ventilation openings or holes are blocked by a newspaper or cloth, etc., the heat may not be able to get out.)
- Do not place any naked flame sources, such as lighted candles, on the apparatus.
- When discarding batteries, environmental problems must be considered and local rules or laws governing the disposal of these batteries must be followed strictly.
- Do not expose this apparatus to rain, moisture, dripping or splashing and that no objects filled with liquids, such as vases, shall be placed on the apparatus.

IMPORTANT FOR LASER PRODUCTS

REPRODUCTION OF LABELS

① CLASSIFICATION LABEL, PLACED ON EXTERIOR SURFACE

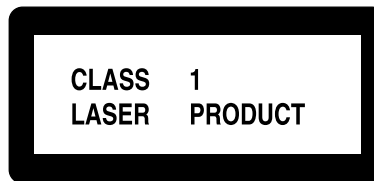

② WARNING LABEL, PLACED INSIDE THE UNIT

CAUTION : Visible and invisible laser radiation when open and interlock failed or defeated. AVOID DIRECT EXPOSURE TO BEAM. (e)	ADVARSEL : Synlig og usynlig laserstråling når maskinen er åben eller interlocken fejler. Undgå direkte eksponering til stråling. (d)	VARNING : Synlig och osynlig laserstrålning när den öppnas och spärren är urkopplad. Betrakta ej strålen. (s)	VARO : Avattaessa ja suojalukitus ohitettuna tai viallisena olet alttiina näkyvälle ja näkymättömälle lasersäteilylle. Vältä säteen kohdistumista suoraan itseesi. (f)
--	---	---	--

1. CLASS 1 LASER PRODUCT
2. **CAUTION**: Visible and invisible laser radiation when open and interlock failed or defeated. Avoid direct exposure to beam.
3. **CAUTION**: Do not open the top cover. There are no user serviceable parts inside the Unit; leave all servicing to qualified service personnel.

Warnings, Cautions and Others

Caution: Proper Ventilation

To avoid risk of electric shock and fire and to protect from damage, place the apparatus on a level surface. The minimal clearances are shown below:

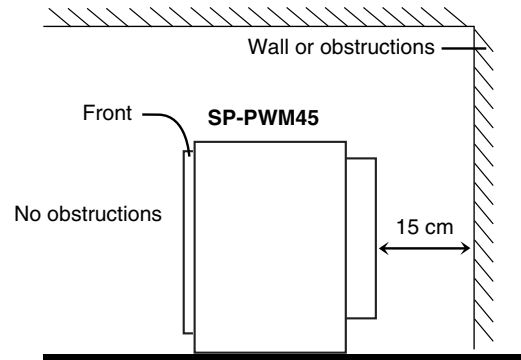
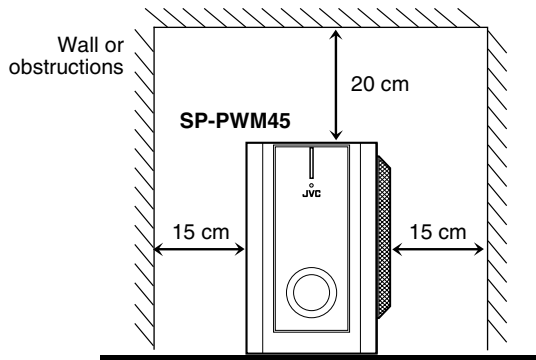
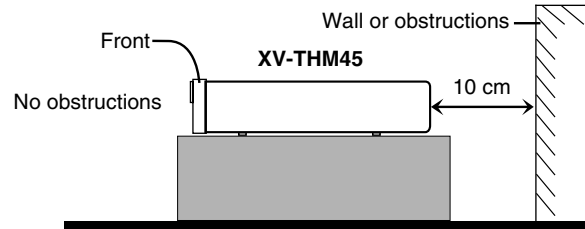
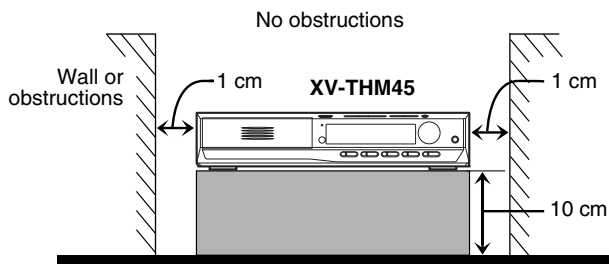

SAFETY INSTRUCTIONS

“SOME DOS AND DON'TS ON THE SAFE USE OF EQUIPMENT”

This equipment has been designed and manufactured to meet international safety standards but, like any electrical equipment, care must be taken if you are to obtain the best results and safety is to be assured.

Do read the operating instructions before you attempt to use the equipment.

Do ensure that all electrical connections (including the mains plug, extension leads and interconnections between pieces of equipment) are properly made and in accordance with the manufacturer's instructions. Switch off and withdraw the mains plug when making or changing connections.

Do consult your dealer if you are ever in doubt about the installation, operation or safety of your equipment.

Do be careful with glass panels or doors on equipment.

DON'T continue to operate the equipment if you are in any doubt about it working normally, or if it is damaged in any way — switch off, withdraw the mains plug and consult your dealer.

DON'T remove any fixed cover as this may expose dangerous voltages.

DON'T leave equipment switched on when it is unattended unless it is specifically stated that it is designed for unattended operation or has a standby mode.

Switch off using the switch on the equipment and make sure that your family know how to do this.

Special arrangements may need to be made for infirm or handicapped people.

DON'T use equipment such as personal stereos or radios so that you are distracted from the requirements of traffic safety. It is illegal to watch television whilst driving.

DON'T listen to headphones at high volume as such use can permanently damage your hearing.

DON'T obstruct the ventilation of the equipment, for example with curtains or soft furnishings.

Overheating will cause damage and shorten the life of the equipment.

DON'T use makeshift stands and NEVER fix legs with wood screws — to ensure complete safety always fit the manufacturer's approved stand or legs with the fixings provided according to the instructions.

DON'T allow electrical equipment to be exposed to rain or moisture.

ABOVE ALL

- NEVER let anyone, especially children, push anything into holes, slots or any other opening in the case — this could result in a fatal electrical shock.;
- NEVER guess or take chances with electrical equipment of any kind — it is better to be safe than sorry!

Table of contents

Introduction..... 2

Notes on handling2

Supplied accessories2

About discs 3

Playable disc types3

Disc structure4

Playback Control function (PBC) — VCD and SVCD only4

Names of parts and controls 5

Getting started..... 8

Connections8

Using the remote control14

Basic operations 17

Turning the system on/off17

Selecting the source to play18

Adjusting the volume18

Listening with headphones18

Turning off the sound temporarily18

Adjusting the brightness19

Using the Sleep Timer19

Adjusting the output level of the subwoofer20

Adjusting the bass/treble sound20

Changing the decode mode20

Playback 21

Basic playback21

Playback features23

Tuner operations..... 25

Manual tuning25

Preset tuning25

Selecting the FM reception mode26

Reducing the noise of AM (MW) broadcast26

Using the RDS (Radio Data System) when receiving

FM stations27

Creating realistic sound fields 31

Using the surround mode33

Adjusting the sound34

Advanced operations 35

Using the on-screen bar35

Playing from a specified position on a disc36

Using the MP3 control display38

Using the JPEG control display39

Selecting a view angle of DVD40

Selecting the subtitle/audio languages41

Special picture playback43

Program Playback45

Random Playback46

Repeat Playback46

Setting DVD preferences 48

Using the choice menus48

Menu description50

Parental Lock53

System setting 56

References 57

Maintenance57

Trouble shooting57

Glossary60

Index61

Specifications62

Introduction

Notes on handling

■ Important cautions

Installation of the system

- Select a place which is level, dry and neither too hot nor too cold; between 5°C and 35°C.
- Leave sufficient distance between the system and the TV.
- Do not use the system in a place subject to vibration.

Power cord

- Do not handle the power cord with wet hands!
- A small amount of power (1.6 watts) is always consumed while the power cord is connected to the wall outlet (center unit only).
- When unplugging the power cord from the wall outlet, always pull on the plug, not the power cord.

To prevent malfunctions of the system

- There are no user-serviceable parts inside. If anything goes wrong, unplug the power cord and consult your dealer.
- Do not insert any metallic object into the system.
- Do not use any non-standard shape disc (like a heart, flower or credit card, etc.) available on the market, because it may damage the system.
- Do not use a disc with tape, stickers, or paste on it, because it may damage the system.

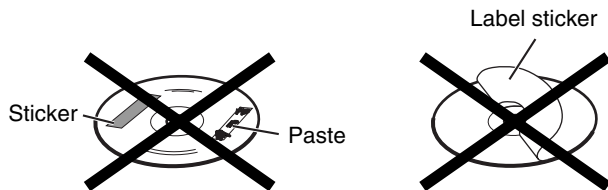

Note about copyright laws

Check the copyright laws in your country before recording from DVDs, Super Video CDs (SVCs), Video CDs (VCDs) and Audio CDs. Recording of copyrighted material may infringe copyright laws.

Note about copyguard system

DVDs are protected by copyguard system. When you connect the system to your VCR directly, the copyguard system activates and the picture may not be played back correctly.

■ Safety precautions

Avoid moisture, water and dust

Do not place the system in moist or dusty places.

Avoid high temperatures

Do not expose the system to direct sunlight and do not place it near a heating device.

When you are away

When away on travel or for other reasons for an extended period of time, disconnect the power cord plug from the wall outlet.

Do not block the vents

Blocking the vents may damage the system.

Care of the cabinet

When cleaning the system, use a soft cloth and follow the relevant instructions on the use of chemically-coated cloths. Do not use benzene, thinner or other organic solvents including disinfectants. These may cause deformation or discoloring.

If water gets inside the system

Turn the system off and disconnect the power cord plug from the wall outlet, then call the store where you made your purchase. Using the system in this condition may cause fire or electrical shock.

Supplied accessories

Check to be sure you have all of the supplied accessories. The number in parentheses is the quantity of the pieces supplied. If anything is missing, contact your dealer immediately.

- Remote control (1)
- Batteries (2)
- FM antenna (1)
- AM (MW) loop antenna (1)
- Power cord (1)
- System cord (1)
- Speaker cords
 - 5 m: For satellite (front left/right) and center speakers (3)
 - 10 m: For satellite speakers (surround left/right) (2)
 - (Length of speaker cords is approximate.)

This product incorporates copyright protection technology that is protected by method claims of certain U.S. patents and other intellectual property rights owned by Macrovision Corporation and other rights owners. Use of this copyright protection technology must be authorized by Macrovision Corporation, and is intended for home and other limited viewing uses only unless otherwise authorized by Macrovision Corporation. Reverse engineering or disassembly is prohibited.

About discs

Playable disc types

This system has been designed to play back the following discs: DVD Video (DVD), Video CD (VCD), Super Video CD (SVCD), Audio CD, CD-R and CD-RW.

- This system can also play back MP3 and JPEG files recorded on CD-Rs and CD-RWs. (☞ pg. 21)
- This system can also play back finalized DVD-Rs recorded in DVD VIDEO format. However, some discs may not be played back because of their disc characteristics or recording conditions.

Discs you can play:

Disc Type	Mark (Logo)	Video Format	Region Code Number*
DVD		PAL	2/ALL
VCD		PAL	—
SVCD		PAL	—
Audio CD		—	—
CD-R		—	—
CD-RW		—	—

* Note on Region Code

DVD players and DVDs have their own Region Code numbers. This system can only play back DVDs recorded with the color system of PAL whose Region Code number includes "2".

Examples:



If a DVD with an improper Region Code number is loaded, "REGION CODE ERROR!" appears on the TV screen and playback cannot start.

- The following discs cannot be played back: DVD Audio, DVD-ROM, DVD-RAM, DVD-RW, CD-ROM, CD-I (CD-I Ready), Photo CD, etc. Playing back these discs will generate noise and damage the speakers.
- **On some DVDs, Video CDs or SVCDs, their actual operation may be different from what is explained in this manual. This is due to the disc programming and disc structure, not a malfunction of this system.**

Notes on CD-R and CD-RW

- User-edited CD-Rs (Recordable) and CD-RWs (Rewritable) can be played back only if they are already "finalized".
- This system can play back CD-Rs or CD-RWs recorded on a personal computer if they have been recorded in the audio CD format. This system can also play back CD-Rs or CD-RWs if MP3 files or JPEG files are recorded on them. However, some discs may not be played back because of their disc characteristics, recording conditions, or damage or stain on them.

Especially, the configuration and characteristics of an MP3 disc or a JPEG disc are determined by the writing (encoding) software and hardware used for recording. Therefore, due to the software and hardware used, the following symptoms may occur:

- Some discs may not be played back.
- Some tracks on an MP3 disc may be skipped or may not be played back normally.
- Some files on a JPEG disc may be played back distortedly.
- Before playing back CD-Rs or CD-RWs, read their instructions or cautions carefully.
- CD-RWs may require a longer readout time. This is caused by the fact that the reflectance of CD-RWs is lower than that of regular CDs.

About MP3 discs

MP3 is an abbreviation for Motion Picture Experts Group 1 (or MPEG-1) Audio Layer 3. MP3 is simply a compressed data file format. By using MP3 format, one CD-R or CD-RW can contain 10 times as much data as one regular CD.

About JPEG discs

A still-picture data compression system proposed by the Joint Photographic Expert Group, which features small decrease in image quality in spite of its high compression ratio.

Notes on MP3/JPEG discs

- MP3/JPEG discs (either CD-R or CD-RW) require a longer readout time. (It differs due to the complexity of the directory/file configuration.)
- When making an MP3/JPEG disc, select ISO 9660 Level 1 or Level 2 for the disc format.
- This system supports "multi-session" discs (up to 5 sessions).
- This system cannot play "packet write" discs.
- The system can only play MP3/JPEG files with the following file extensions:
MP3: ".MP3", ".Mp3", ".mP3" and ".mp3"
JPEG: ".jpg", ".jpeg", ".JPG", ".JPEG" and any uppercase and lowercase combination (such as ".Jpg")
- If both MP3 files and JPEG files are recorded on a disc, set the MP3/JPEG setting in the PICTURE menu to the appropriate setting for the data to be read ("MP3" or "JPEG"). (☞ pg. 51)
- Some MP3/JPEG discs may not be played back because of their disc characteristics or recording conditions.

Notes on MP3 discs only

- ID3* tags cannot be shown on the display.
* An MP3 file can contain file information called an "ID3 Tag" where its album name, performer, track title, etc. are recorded. There are two versions, ID3v1 (ID3 Tag version 1) and ID3v2 (ID3 Tag version 2).
- We recommend to record each piece of material (song) at a sample rate of 44.1 kHz and at a data transfer rate of 128 kbps.
- Some tracks on an MP3 disc may be skipped or may not be played back normally.

Notes on JPEG discs only

- We recommend to record a file at 640 x 480 resolution. (If a file has been recorded at a resolution of more than 640 x 480, it will take a longer time to be displayed.)
- This system can only play baseline JPEG files*. Progressive JPEG files* or lossless JPEG files* cannot be played.
* Baseline JPEG format: Used for digital cameras, web, etc.
Progressive JPEG format: Used for web.
Lossless JPEG format: An old type and rarely used now.
- Some files on a JPEG disc may be played back distortedly.

About discs

IMPORTANT

Before playing a disc, make sure of the following;

- Check the connection with the TV.
- Turn on your TV and select the correct input mode on the TV to view the pictures or on-screen information on the TV screen.
- For DVD playback, you can change the initial setting to your preference. (☞ pg. 48 – 55)

If appears on the TV screen when pressing a button;

The disc cannot accept the operation you have tried to do, or the information required for that operation is not recorded on the disc.

NOTICE: In some cases, without showing , operations will not be accepted.

Disc structure

DVD

A DVD consists of “titles” and each title may be divided into “chapters”.

For example, if a DVD contains movies, each movie may have its own title number and may be further divided into chapters.

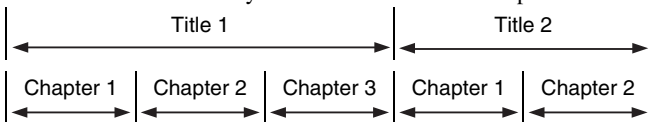

Video CD/SVCD/Audio CD

A Video CD, SVCD, Audio CD consists of “tracks”.

In general, each track has its own track number. (On some discs, each track may also be further divided by indexes.)

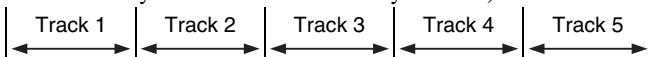

MP3 discs

On an MP3 disc, each song is recorded as a track (file). Tracks are usually grouped into a group (folder). Groups can also include other groups, creating hierarchical group layers. This system can recognize up to 150 tracks per group and up to 99 groups per disc.

- If there is any type of file other than MP3 files in a group (folder), those files are also counted in the total number of 150.

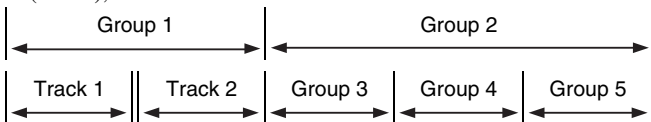

JPEG discs

On a JPEG disc, each still picture is recorded as a file. Files are usually grouped into a group (folder). Groups can also include other groups, creating hierarchical folder layers. This system can recognize up to 150 files per group and up to 99 groups per disc.

- If there is any type of file other than JPEG files in a group (folder), those files are also counted in the total number of 150.

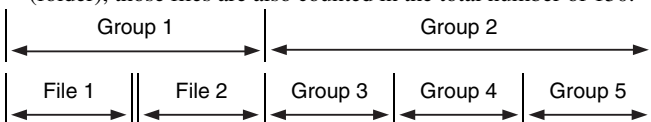

Playback Control function (PBC) — VCD and SVCD only

The Playback Control function allows you to enjoy menu-driven operation and high-resolution still images which have a resolution four times greater than moving pictures.

High-resolution still image display

You can display high-quality images which are four times clearer than moving pictures.

Menu-driven playback

A selection menu is displayed when you start playing a Video CD or SVCD with the Playback Control feature. The selection menu shows a list of numbers for selection. Some discs may show moving pictures or a divided screen.

You can interact with the screen using a menu display to select and play an entry.

See example illustration below about basic features of menu-driven playback (for details about the operation through the menu, also see page 37).

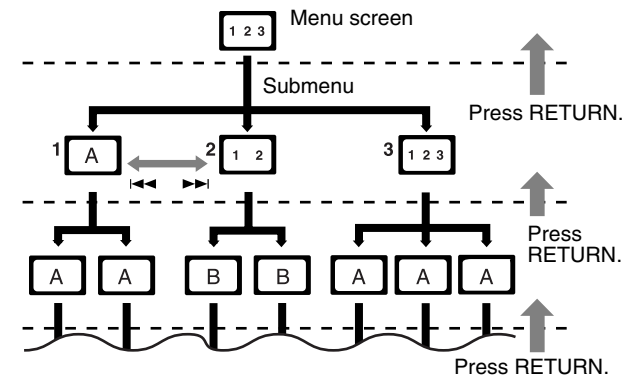

A: Moving picture
B: Still picture

NOTE

- When operating a Video CD or SVCD using the menu, some functions such as Repeat Playback may not work.

Names of parts and controls

Front panel (center unit)

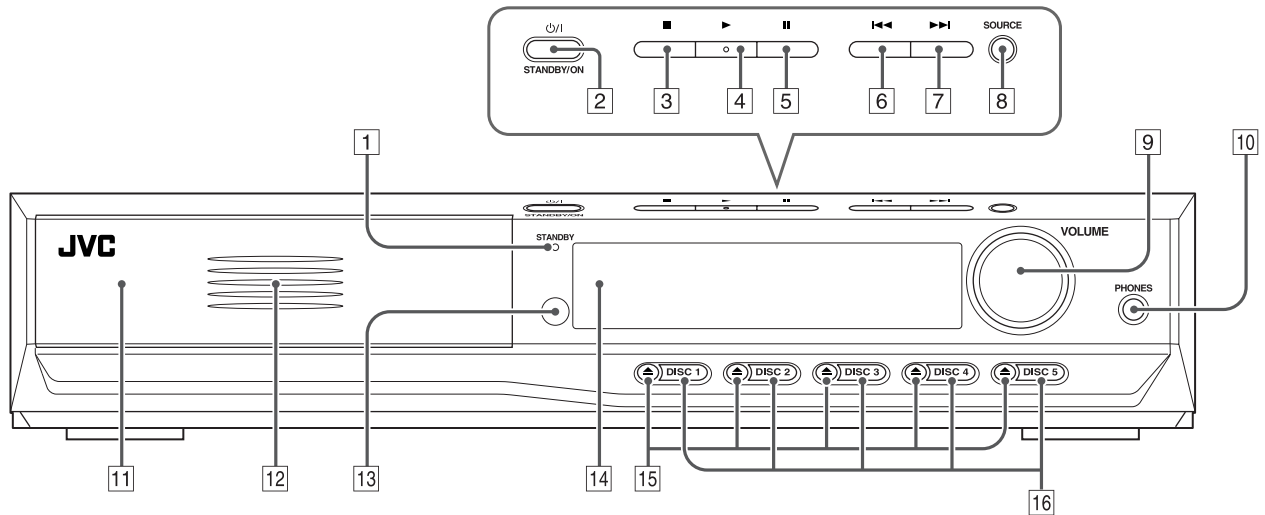

- | | |
|---|--|
| 1 Standby lamp (STANDBY) ↗ pg. 17 | 9 Volume control (VOLUME) ↗ pg. 18 |
| 2 Standby-on button (⏻/I STANDBY/ON) ↗ pg. 17 | 10 Headphones jack (PHONES) ↗ pg. 18 |
| 3 Stop button (■) ↗ pg. 21 | 11 Disc trays ↗ pg. 21 |
| 4 Play button (▶) ↗ pg. 21 | 12 Illumination lamp ↗ pg. 19 |
| 5 Pause button (⏸) ↗ pg. 21 | 13 Remote sensor ↗ pg. 14 |
| 6 Reverse skip button (◀◀) ↗ pg. 24 | 14 Display window ↗ pg. 6, 22 |
| 7 Forward skip button (▶▶) ↗ pg. 24 | 15 Open/close buttons (▲) ↗ pg. 21 |
| 8 Source button (SOURCE) ↗ pg. 18 | 16 Disc buttons (DISC 1-5) ↗ pg. 21 |

Rear panel (center unit)

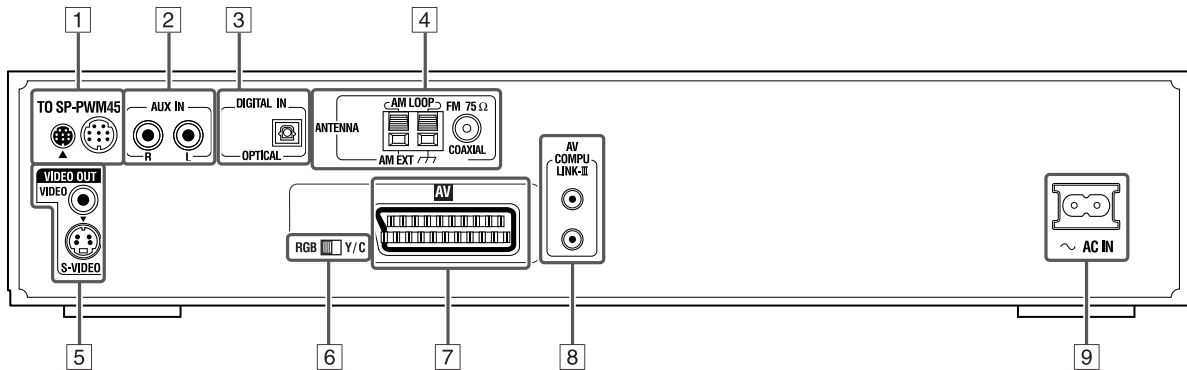

- | |
|--|
| 1 System cord connector ↗ pg. 10 |
| 2 Audio input jacks (AUX IN) ↗ pg. 12 |
| 3 Digital input jack (DIGITAL IN) ↗ pg. 12 |
| 4 Antenna terminals (ANTENNA) ↗ pg. 9 |
| 5 Video output jacks (VIDEO OUT) ↗ pg. 8
VIDEO, S-VIDEO |
| 6 Video output signal selector (RGB-Y/C) ↗ pg. 8 |
| 7 AV (SCART) connector (AV) ↗ pg. 8 |
| 8 AV COMPU LINK-III jacks (for future use) |
| 9 ~ AC IN socket ↗ pg. 13 |

Display window (center unit)

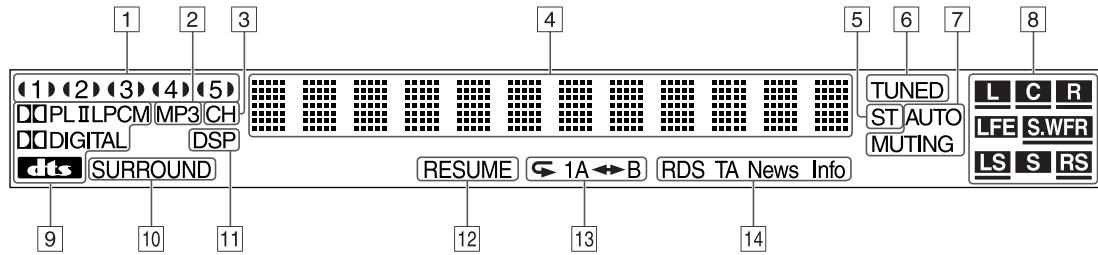

- 1 Disc indicators ☞ pg. 23
- 2 MP3 indicator ☞ pg. 22
- 3 Channel indicator (CH) ☞ pg. 26
- 4 Main display ☞ pg. 22
- 5 Stereo indicator (ST) ☞ pg. 25
- 6 Tuning indicator (TUNED) ☞ pg. 25
- 7 Auto muting indicator (AUTO MUTING) ☞ pg. 26
- 8 • Source signal indicators (**L C R LFE LS S RS**) ☞ pg. 32
 - Subwoofer indicator (**R**) ☞ pg. 32
 - Sound reproducing speaker indicator (**—**) ☞ pg. 32
- 9 • Dolby Pro Logic II indicator (**PLII**) ☞ pg. 31
 - Linear PCM indicator (LPCM) ☞ pg. 32
 - Digital signal format indicators ☞ pg. 32
 - Dolby Digital (**DIGITAL**), DTS (**DTS**)
- 10 Surround indicator (SURROUND) ☞ pg. 33
- 11 DSP indicator ☞ pg. 31 – 33
- 12 Resume indicator (RESUME) ☞ pg. 22
- 13 Repeat mode indicators ☞ pg. 46
- 14 RDS reception mode indicators ☞ pg. 27 – 30
RDS, TA, News, Info

Powered subwoofer

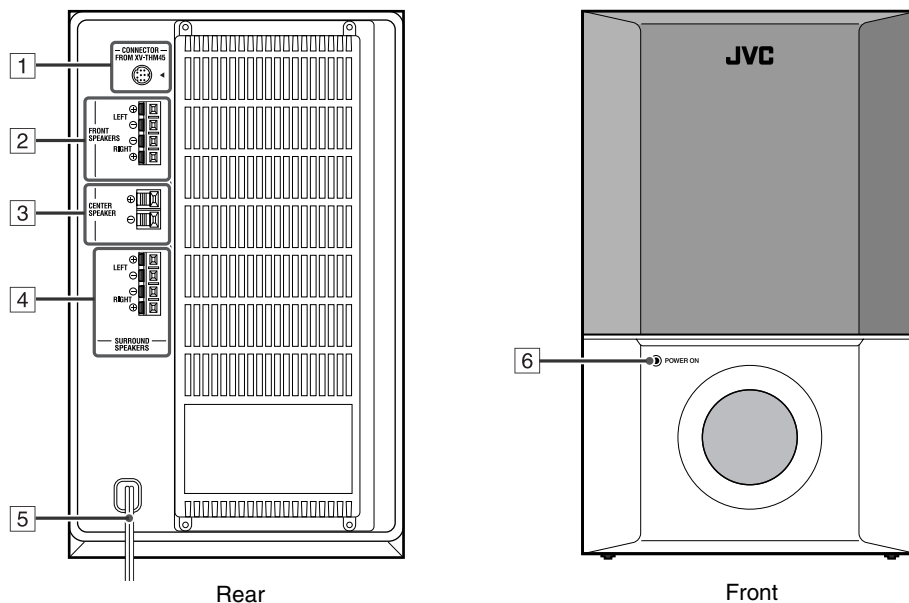

- 1 System cord connector ☞ pg. 10
- 2 Front speaker terminals (FRONT SPEAKERS) ☞ pg. 11
- 3 Center speaker terminals (CENTER SPEAKER) ☞ pg. 11
- 4 Surround speaker terminals (SURROUND SPEAKERS) ☞ pg. 11
- 5 Power cord ☞ pg. 13
- 6 Power lamp (POWER ON) ☞ pg. 17

Remote control

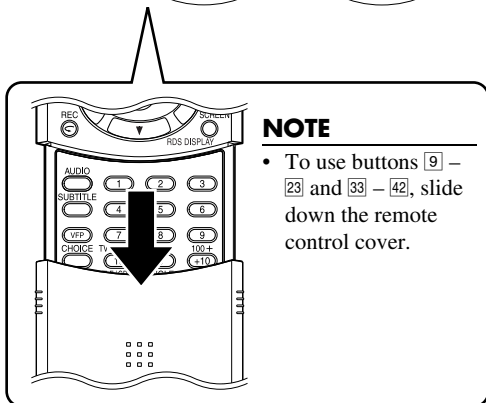
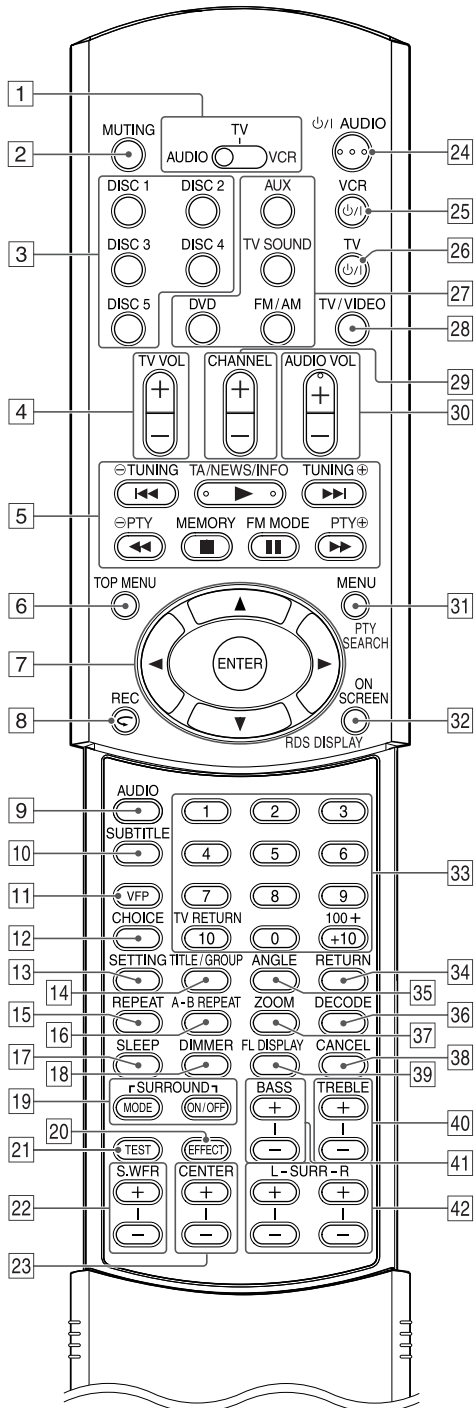

NOTE

- To use buttons 9 – 23 and 33 – 42, slide down the remote control cover.

- 1 Remote control mode selector ☞ pg. 15 – 56
AUDIO, TV, VCR
- 2 Muting button (MUTING) ☞ pg. 18
- 3 Disc buttons (DISC 1-5) ☞ pg. 21
- 4 TV volume buttons (TV VOL +/-) ☞ pg. 15
- 5 Operating buttons
 - Play button (▶) ☞ pg. 22
 - Forward/reverse skip buttons (▶▶/◀◀) ☞ pg. 24
 - Fast-forward/reverse playback buttons (▶▶/◀◀) ☞ pg. 24
 - Stop button (■) ☞ pg. 21
 - Pause button (⏸) ☞ pg. 21
 - Tuning buttons (TUNING ⊕, TUNING ⊖) ☞ pg. 25
 - Memory button (MEMORY) ☞ pg. 26
 - FM reception/Beat Cut mode button (FM MODE) ☞ pg. 26
 - Enhanced Other Network operating button (TA/NEWS/INFO) ☞ pg. 29
 - PTY selection buttons (PTY ⊕, PTY ⊖) ☞ pg. 28
- 6 Top menu button (TOP MENU) ☞ pg. 36
- 7 Cursor buttons (▶/◀/▼/▲) ☞ pg. 36
- 8 Enter button (ENTER) ☞ pg. 15
- 9 One Touch Replay button (⏮) ☞ pg. 23
- 10 Record button (REC) ☞ pg. 16
- 11 Audio button (AUDIO) ☞ pg. 41, 42
- 12 Subtitle button (SUBTITLE) ☞ pg. 41
- 13 VFP setting button ☞ pg. 44
- 14 Choice menu button (CHOICE) ☞ pg. 48
- 15 Setting button (SETTING) ☞ pg. 56
- 16 Title/group button (TITLE/GROUP) ☞ pg. 37
- 17 Repeat button (REPEAT) ☞ pg. 46
- 18 A-B repeat button (A-B REPEAT) ☞ pg. 47
- 19 Sleep button (SLEEP) ☞ pg. 19
- 20 Dimmer button (DIMMER) ☞ pg. 19
- 21 Surround buttons (SURROUND)
 - Mode (MODE), On/Off (ON/OFF) ☞ pg. 33
- 22 Effect button (EFFECT) ☞ pg. 34
- 23 Test tone button (TEST) ☞ pg. 34
- 24 Subwoofer adjustment buttons (S.WFR +/-) ☞ pg. 20
- 25 Center speaker adjustment buttons (CENTER +/-) ☞ pg. 34
- 26 Standby-on button (⏻ AUDIO) ☞ pg. 17
- 27 Standby-on button (⏻ VCR) ☞ pg. 16
- 28 Standby-on button (⏻ TV) ☞ pg. 15
- 29 Source selecting buttons ☞ pg. 18
DVD, FM/AM, AUX, TV SOUND
- 30 TV/Video mode button (TV/VIDEO) ☞ pg. 15
- 31 Channel buttons (CHANNEL +/-) ☞ pg. 15
- 32 Volume buttons (AUDIO VOL +/-) ☞ pg. 18
- 33 Menu button (MENU) ☞ pg. 36
- 34 PTY search button (PTY SEARCH) ☞ pg. 28
- 35 On-screen button (ON SCREEN) ☞ pg. 35
- 36 RDS display button (RDS DISPLAY) ☞ pg. 27
- 37 Number buttons ☞ pg. 15, 24, 37
- 38 TV returning button (TV RETURN) ☞ pg. 15
- 39 Return button (RETURN) ☞ pg. 4, 37
- 40 Angle button (ANGLE) ☞ pg. 40
- 41 Decode mode button (DECODE) ☞ pg. 20
- 42 Zoom button (ZOOM) ☞ pg. 43
- 43 Cancel button (CANCEL) ☞ pg. 45
- 44 Display window button (FL DISPLAY) ☞ pg. 22
- 45 Treble adjustment buttons (TREBLE +/-) ☞ pg. 20
- 46 Bass adjustment buttons (BASS +/-) ☞ pg. 20
- 47 Surround speaker adjustment buttons (SURR) ☞ pg. 34
Left (L +/-), Right (R +/-)

Getting started

Connections

- Do not connect the AC power cord until all other connections have been made.
- Since different components often have different terminal names, carefully read the instructions supplied with the components you are going to connect.

Connecting a TV

To view pictures and on-screen displays, connect the TV to the center unit.

- Distortion of picture may occur when connecting to the TV via a VCR, or to a TV with a built-in VCR.
- You need to set “MONITOR TYPE” in the PICTURE menu correctly according to the aspect ratio of your TV. (☞ pg. 51)

■ To connect a TV with the SCART connector

Connect the center unit’s AV (SCART) connector with your TV’s SCART connector using a SCART cable (not supplied).

- Set the RGB-Y/C selector correctly according to your TV.
 - If the TV accommodates the RGB video signal, set the RGB-Y/C selector to “RGB” so that you can enjoy better-quality pictures.
 - If the TV accommodates the S-video signal, set the RGB-Y/C selector to “Y/C”.
 - If the TV accommodates the composite video signal only, set the RGB-Y/C selector to “RGB”.

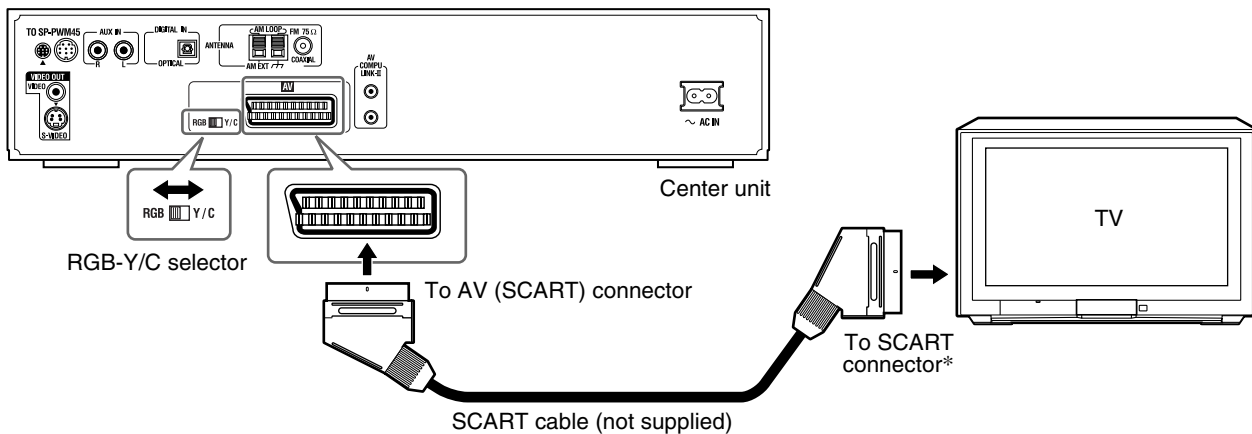

* Some TV’s SCART connectors output audio signal. In such a case, you can enjoy the TV sound through this system.

NOTE

- No sound comes out from “AV” (SCART) connector.

■ To connect a TV through the composite or S-video jacks

Connect the TV using the composite video cord (not supplied) or an S-video cord (not supplied).

- If your TV has an S-video (Y/C-separation) jack, you can get better picture quality than by using composite video connection.
- Connect the S-video cord by matching the ▼ mark on the plug to the one on the rear of the center unit.

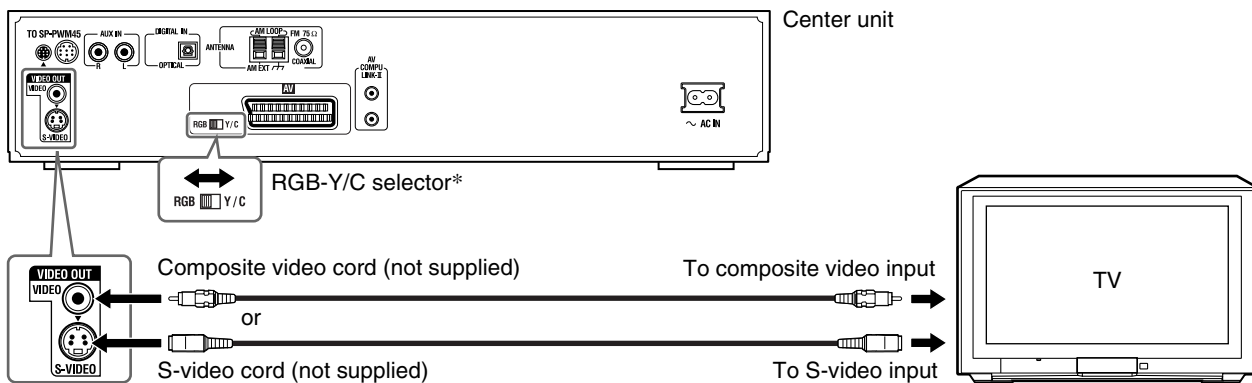

- * When connecting an S-video cord, set the RGB-Y/C selector to “Y/C”.
- When connecting a composite video cord, set the RGB-Y/C selector to “RGB”.

NOTE

- When the RGB-Y/C selector is set to “RGB”, correct video signal is not output from the S-VIDEO jack on the rear panel.
- Whether the RGB-Y/C selector is set to “RGB” or “Y/C”, the composite video signal is always output from the VIDEO jack of the VIDEO OUT.

Getting started

Connecting the FM and AM (MW) antennas

Make sure the antenna conductors do not touch any other terminals, connecting cords and power cords. This could cause poor reception.

■ AM (MW) loop antenna

Setting up supplied AM (MW) loop antenna

Attach the AM (MW) loop to its base by snapping the tabs on the loop into the slot on the base.

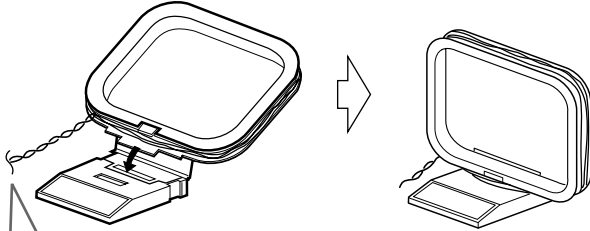

If the antenna cord is covered with the insulation coat, twist and pull the insulation coat off and remove.

Connecting AM (MW) loop antenna

Center unit

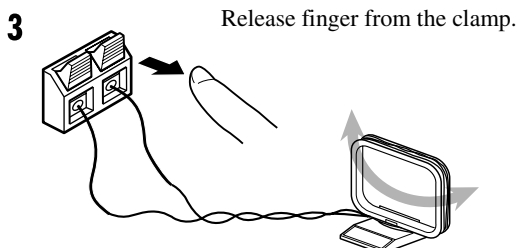
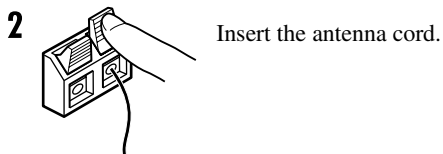
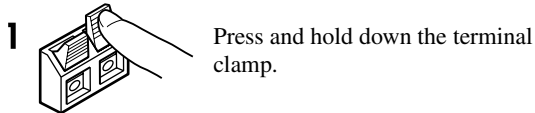
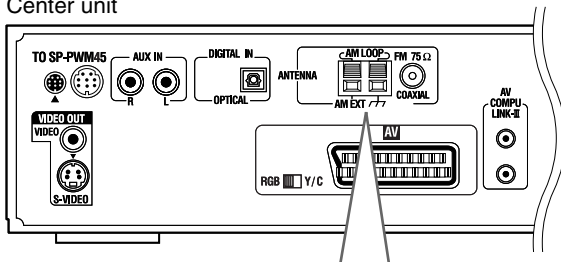

- Turn the loop antenna until you have the best reception.

If reception is poor

Connect an outdoor single vinyl-covered wire antenna (not supplied) to the AM EXT terminal. (Keep the AM (MW) loop antenna connected.)

- Twist together both wires.

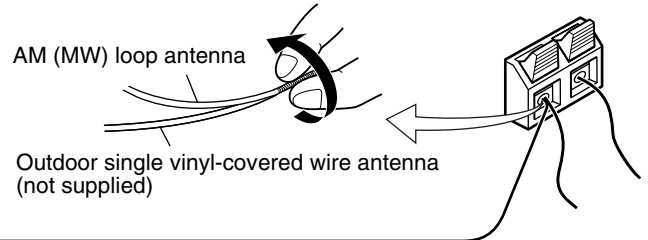

■ FM antenna

Connecting supplied FM antenna

Center unit

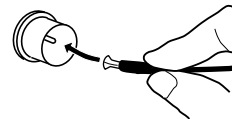
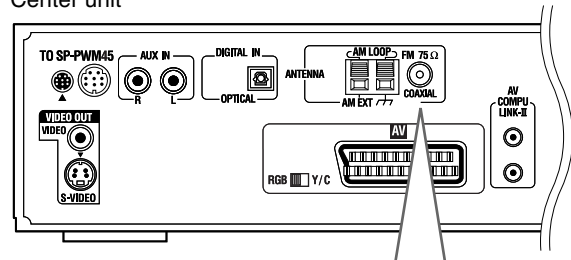

Extend the supplied FM antenna horizontally.

If reception is poor

Connect an outdoor FM antenna with standard type (75 Ω coaxial) connector.

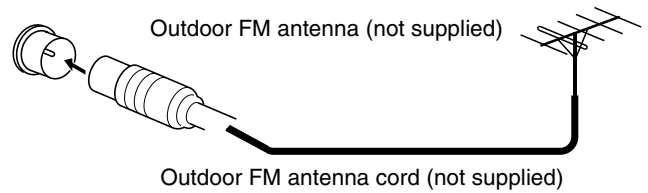

NOTE

- Disconnect the supplied FM antenna before attaching a 75 Ω coaxial connector (the kind with a round wire going to an outdoor antenna).
- We recommend that you use coaxial cable for the FM antenna as it is well-shielded against interference.

Connecting the powered subwoofer

Connect the supplied powered subwoofer (SP-PWM45) using the system cord (supplied).

- Connect the system cord by matching the ▲ marks on the plugs to the ones on the center unit and powered subwoofer.

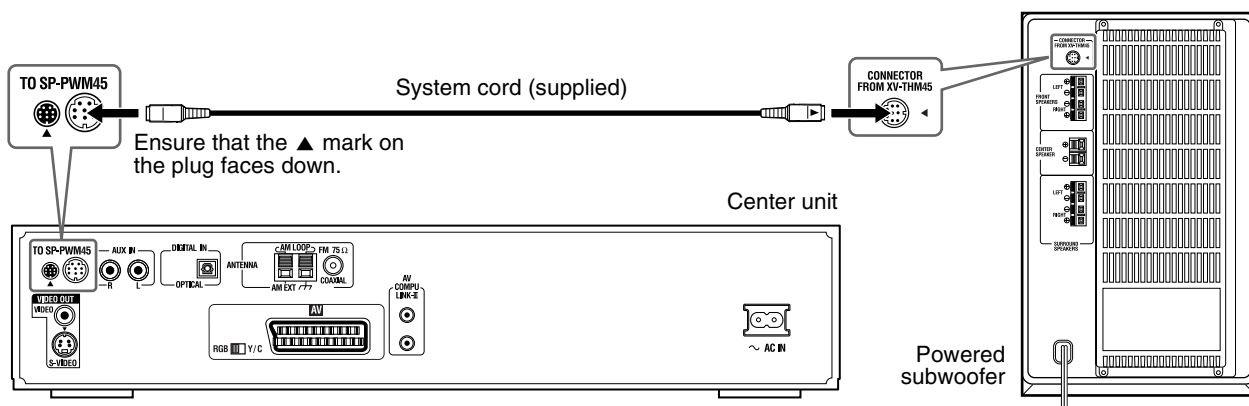

Connecting the satellite speakers

■ Speaker layout

When positioning the speakers, to obtain the best possible sound from this system you need to place all satellite speakers at the same distance from the listening position with the front of each speaker facing toward the listener.

When you cannot place them at the same distance from the listening position, you can make adjustment so that speakers operate as if they are placed at the best position. (pg. 52)

- Normally place the powered subwoofer in front of you. (Since bass sound is non-directional, you do not need to place it at the same distance as the other speakers.)

NOTE

- Although the satellite speakers and the powered subwoofer are magnetically shielded, the TV screen may appear mottled. In this case, keep the distance between them to the TV to over 10 cm.
- For safety reasons, always ensure that there is sufficient space behind the powered subwoofer.
- When you position the satellite speakers in a relatively high place, such as the top of your bookshelf, place them on a flat and level surface.
- Speaker grilles are not removable. Trying to remove them by force may damage them.

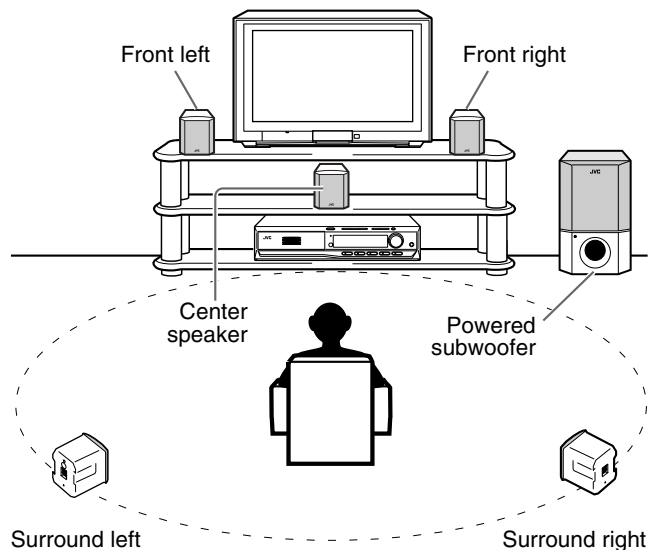

Getting started

■ Connecting the satellite (front, center, surround) speakers

Be sure to identify each speaker (SP-THM45C/SP-THM45F/SP-THM45S) and connect them to the corresponding terminals of the powered subwoofer.

CAUTION

- When you connect (larger) speakers other than the supplied ones, only use speakers with the same speaker impedance (SPEAKER IMPEDANCE) as indicated by the speaker terminals on the rear of the powered subwoofer.
- DO NOT connect more than one speaker to one speaker terminal.

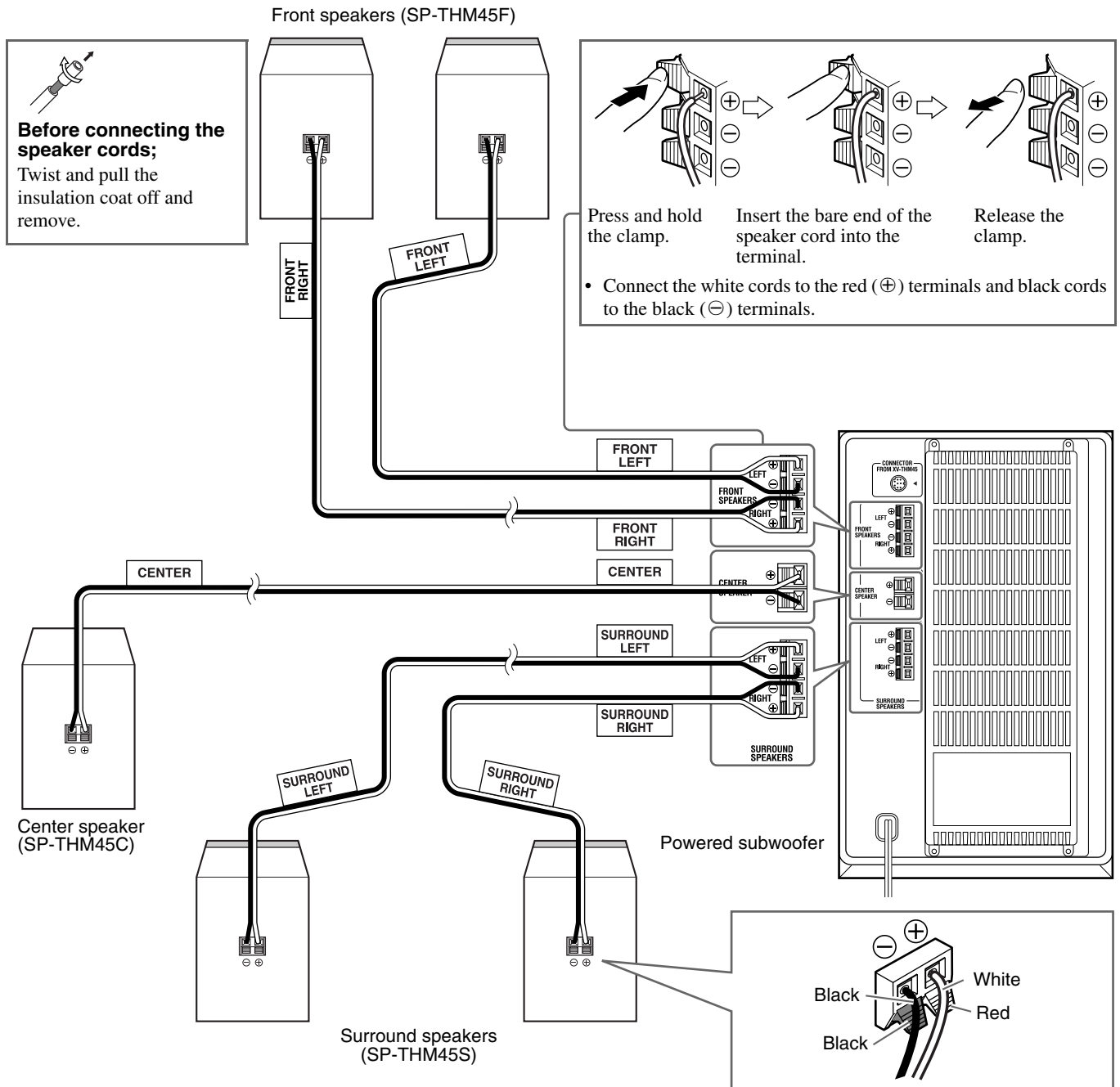

CAUTION

When installing the satellite speakers on the wall;

- Be sure to have them installed on the wall by a qualified personnel.
DO NOT install the satellite speakers on the wall by yourself to avoid unexpected damage from their falling off the wall due to incorrect installation or weakness in wall structure.
- Care must be taken in selecting a location for speaker installation on a wall. Injury to personnel or damage to equipment may result if the speakers installed interfere with daily activities.

Getting started

Connecting to an analog component

You can enjoy the sound of an analog component such as a VCR, TV, or Cassette recorder with this system. Use RCA pin plug cords (not supplied) for connection.

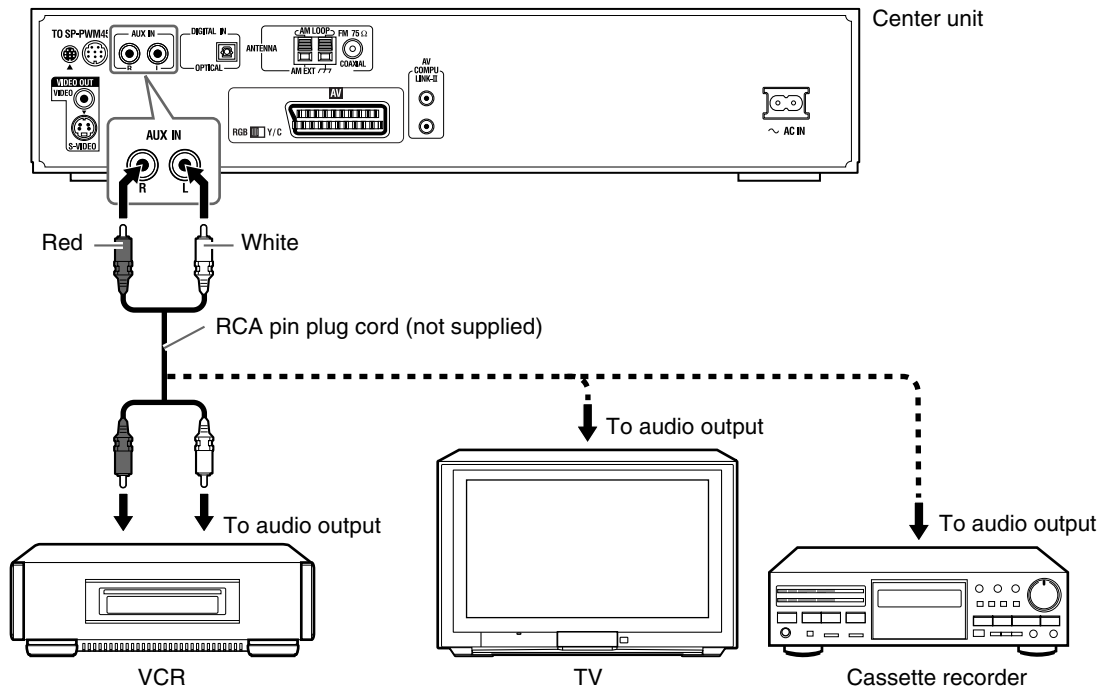

Connecting to a digital component

You can enjoy the sound of a digital component such as a DBS (Direct Broadcast Satellite) tuner or MD recorder with this system. Use digital optical cord (not supplied) for connection.

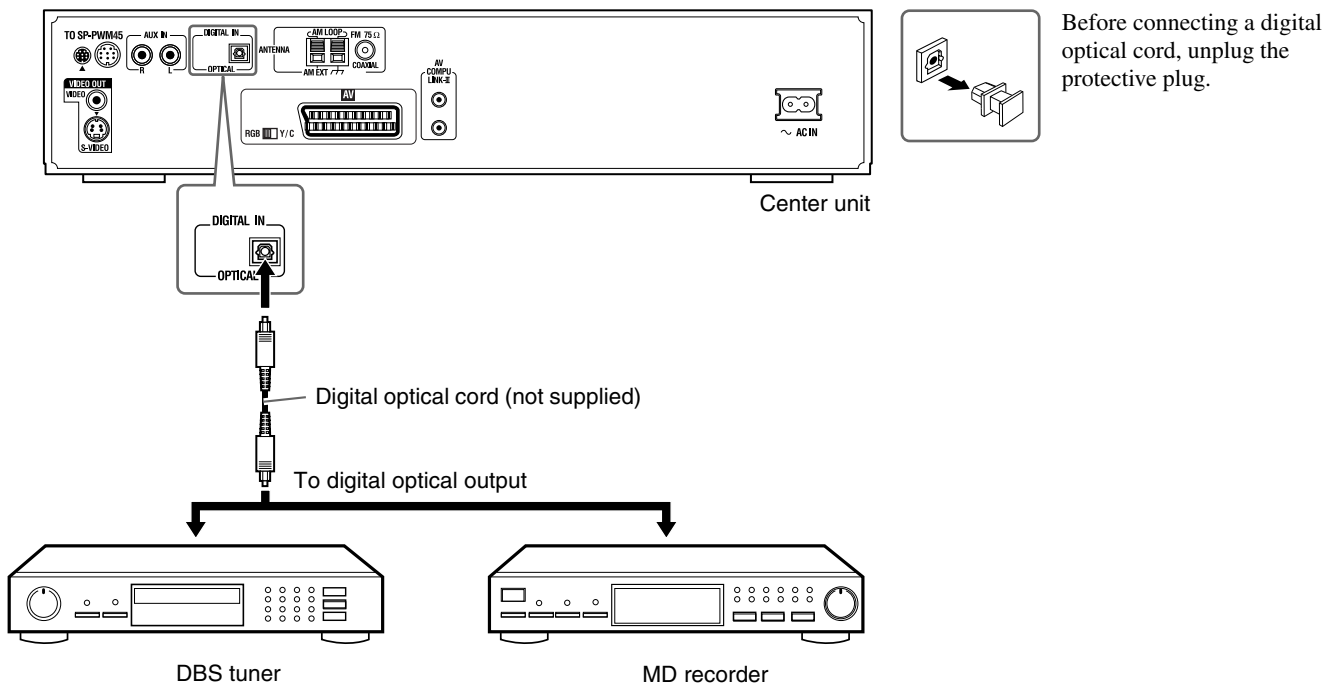

NOTE

- Only digital audio signals can be input when selecting "AUX DIGITAL" as the source to play. (☞ pg. 18) When connecting a video component such as a DBS tuner, operate this system to listen to the sound.

Connecting the power cord

Make sure that all connections have been completed, before plugging in the power cords of the center unit and powered subwoofer.

- 1 Firmly insert the supplied power cord into the ~ AC IN socket on the rear of the center unit.
- 2 Plug both power cords into AC outlets.

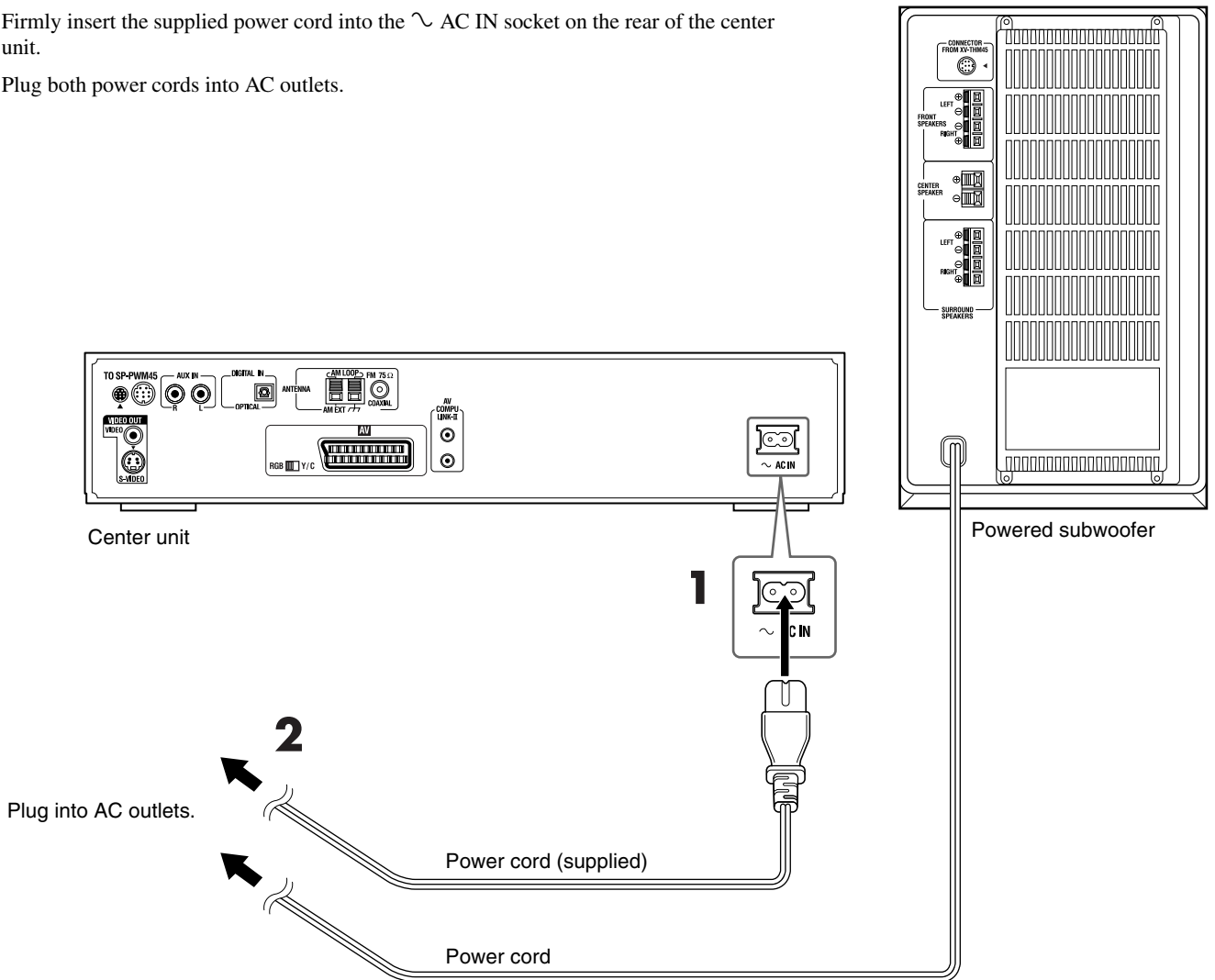

CAUTION

- Disconnect the power cord before cleaning or moving the system.
- Do not touch the power cord with wet hands.
- Do not pull on the power cord to unplug the cord. When unplugging the cord, always grasp and pull the plug so as not to damage the cord.

NOTE

- Keep power cords away from other connected cords. The power cords may cause noise or screen interference.
- Preset settings, such as preset stations and surround mode adjustment, may be erased in a few days in the following cases;
 - If you unplug the power cord of the center unit.
 - If a power failure occurs.
- The speakers will not produce any sound if the power cord of the powered subwoofer is removed from the AC outlet while the center unit is turned on. In this case, press \odot / AUDIO on the remote control or \odot / STANDBY/ON on the center unit to turn the power off, plug in the powered subwoofer, then press \odot / AUDIO or \odot / STANDBY/ON again.

Using the remote control

The remote control makes it easy to use many of the system functions from a distance of up to 7 m away.

- You can also use the remote control supplied for this system to operate other manufacturers' TVs (see pg. 15) and VCRs (see pg. 16).

Putting batteries in the remote control

Before using the remote control, first put in the 2 supplied batteries.

1 Remove the battery cover on the back of the remote control.

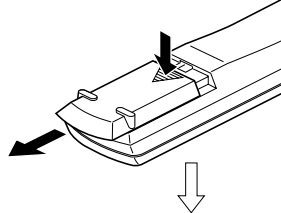

2 Insert the batteries.

- Make sure to match polarity: (+) to (+) and (-) to (-).

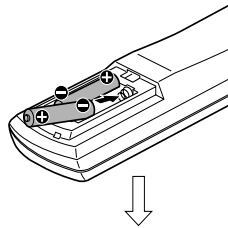

3 Replace the cover.

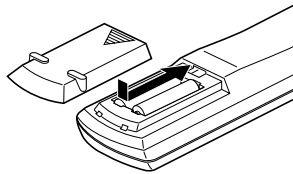

If the range or effectiveness of the remote control decreases, replace the batteries. Use two R6P (SUM-3)/AA (15F) type dry-cell batteries.

CAUTION

- Follow these precautions to avoid leaking or cracking batteries;
 - Use the correct type of batteries. Batteries that look similar may differ in voltage.
 - Always replace both batteries at the same time.
 - Do not expose batteries to heat or flame.

Operating the system from the remote control

Aim the remote control directly at the remote sensor on the center unit.

- To control other components, aim the remote control directly at the remote sensor on each component. Refer also to their instruction manuals.
- To operate the remote control properly, do not hide the remote sensor by placing any obstructions in front of it.

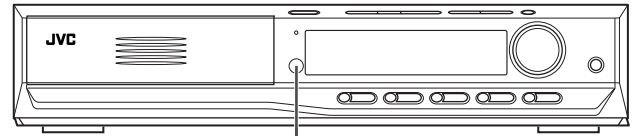

Remote sensor

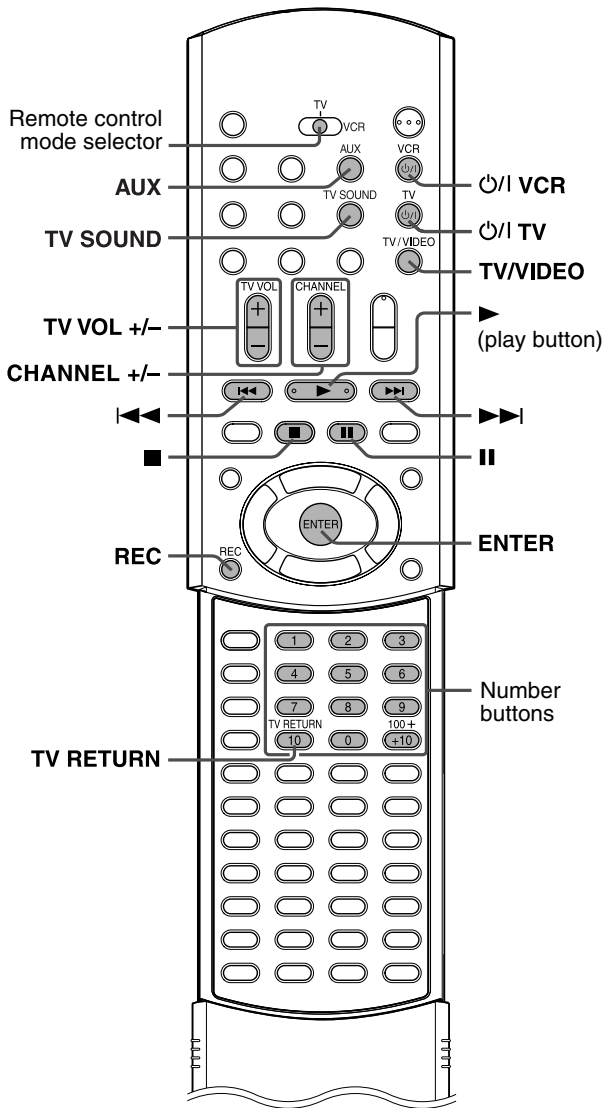

4 Press number buttons (1-9, 0) to enter the manufacturer's code (2 digits).

Examples:
 For a Hitachi TV: Press 0, then 7.
 For a Toshiba TV: Press 2, then 9.

Manufacturer	Code	Manufacturer	Code
JVC	01	Nordmende	13, 14, 18, 26 – 28
Akai	02, 05	Okano	09
Blaupunkt	03	Orion	15
Daewoo	10, 31, 32	Panasonic	16, 17
Fenner	04, 31, 32	Philips	10
Fisher	05	Saba	13, 14, 18, 26 – 28
Grundig	06	Samsung	10, 19, 32
Hitachi	07, 08	Sanyo	05
Inno-Hit	09	Schneider	02, 05
Irradio	02, 05	Sharp	20
Magnavox	10	Sony	21 – 25
Mitsubishi	11, 33	Telefunken	13, 14, 18, 26 – 28
Miver	03	Thomson	13, 14, 18, 26 – 28, 30
Nokia	12, 34	Toshiba	29

5 Release $\text{\textcircled{I}}$ TV.

6 Try operating your TV by pressing $\text{\textcircled{I}}$ TV.

When your TV turns on or off, you have entered the correct code.
 If there is more than one code listed for corresponding brand, try each one until you enter the correct one.

NOTE

- Manufacturers' codes are subject to change without notice. If they are changed, this remote control cannot operate the equipment.
- Set the codes again after replacing the batteries of the remote control.

■ Operation

IMPORTANT

Before using the remote control to operate a TV;
 • Set the remote control mode selector to TV.

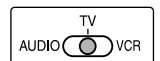

The following buttons are available:

- $\text{\textcircled{I}}$ TV: Turns TV on and off.
- TV VOL +/-: Adjusts the volume.
- TV/VIDEO: Selects the input mode (either TV or VIDEO).
- CHANNEL +/-: Changes the channels.
- 1-10, 0, +10 (100+): Selects the channel.
- TV RETURN: Alternates between the previously selected channel and the current channel.

For TV operations

You can operate your TV using the remote control supplied with this system.

- Refer also to the instruction manuals supplied with your TV.

■ To set the manufacturer's code

You can operate a JVC TV without setting the remote control signal.

1 Slide the remote control mode selector to TV.

2 Press and hold $\text{\textcircled{I}}$ TV.

Keep the button pressed until step 4 is finished.

3 Press ENTER.

For VCR operations

You can operate your VCR using the remote control supplied with this system.

- Refer also to the instruction manuals supplied with your VCR.

■ To set the manufacturer's code

1 Slide the remote control mode selector to VCR.

2 Press and hold **TV/VCR**.

Keep the button pressed until step 4 is finished.

3 Press **ENTER**.

4 Press number buttons (1-9, 0) to enter the manufacturer's code (2 digits).

Examples:

For a Panasonic VCR: Press 2, then 1.

For a Philips VCR: Press 0, then 5.

Manufacturer	Code	Manufacturer	Code
JVC	01	Nokia	16
Aiwa	02, 20	Nordmende	17 – 19, 31
Bell+Howell	03, 16	Orion	20
Blaupunkt	04	Panasonic	21
CGM	03, 05, 16	Philips	05, 22
Daewoo	34	Phonola	05
Digital	05	Saba	17 – 19, 23, 31
Fisher	03, 16	Samsung	24, 25
G.E.	06	Sanyo	03, 16
Grundig	07	Sharp	26, 27
Hitachi	08, 09	Siemens	07
Loewe	05, 10, 11	Sony	28 – 30, 35
Magnavox	04, 05	Telefunken	17 – 19, 31, 32
Mitsubishi	12 – 15	Toshiba	33

5 Release **TV/VCR**.

6 Try operating your VCR by pressing **TV/VCR**.

When your VCR turns on or off, you have entered the correct code.

If there is more than one code listed for your brand, try each one until you enter the correct one.

NOTE

- Manufacturers' codes are subject to change without notice. If they are changed, this remote control cannot operate the equipment.
- Set the codes again after replacing the batteries of the remote control.

■ Operation

IMPORTANT

Before using the remote control to operate a VCR:

- Set the remote control mode selector to VCR.

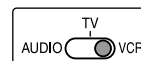

The following buttons are available:

- TV/VCR**: Turns VCR on and off.
- ▶ (play button)**: Starts playback.
- : Stops operation.
- ||**: Pauses playback.
- ▶▶**: Fast forwards video tape.
- ◀◀**: Rewinds video tape.
- REC**: Press this button together with **▶** (play button) to start recording or together with **||** to pause recording.

CHANNEL +/-: Changes the TV channels on the VCR.

Basic operations

This section mainly explains operations commonly used when you enjoy this system.

- Turn on your TV and select the correct input mode on the TV.

IMPORTANT

Before using the remote control for the following operation,

- Set the remote control mode selector to AUDIO.

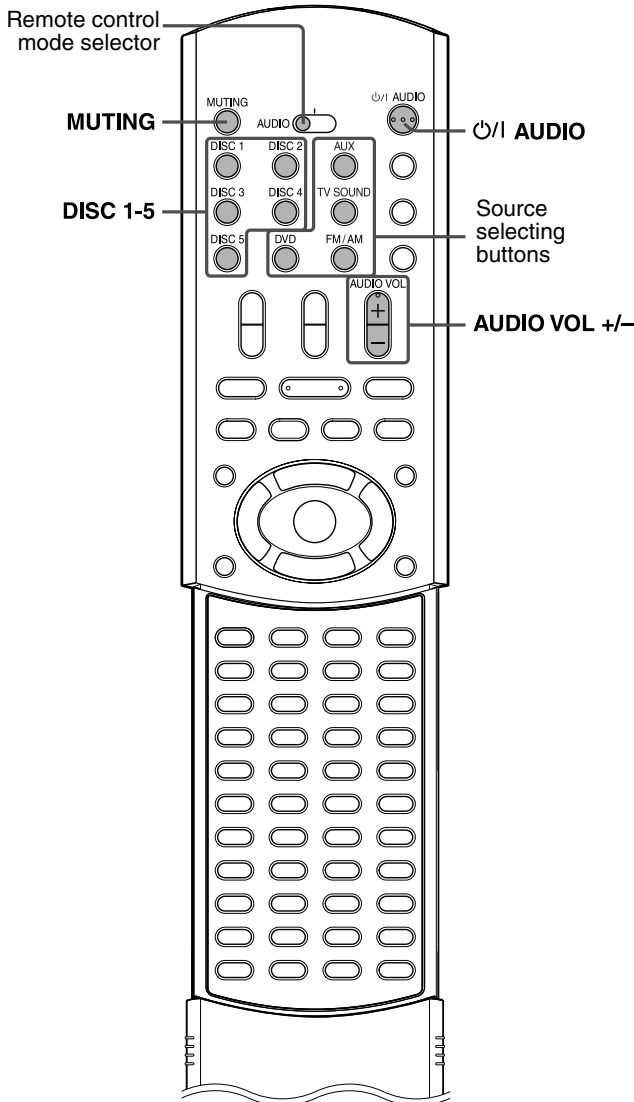
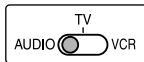

Turning the system on/off

- To turn the power on

On the remote control:
Press **⏻/I AUDIO**.

On the center unit:
Press **⏻/I STANDBY/ON**.

The STANDBY lamp goes off.

When DVD is selected as the source (see pg. 18), the opening screen* appears on the TV screen.

* Opening screen

The following messages may appear in the message area depending on the status of this system.

- “OPEN”/“CLOSE”:
Appears when opening or closing the selected disc tray.
- “NOW READING”:
Appears when the system is reading the disc information.
- “REGION CODE ERROR!”:
Appears when the Region Code of the DVD does not match the code the center unit supports. The DVD cannot be played back.
- “NO DISC”:
Appears when no disc is loaded to the selected disc tray.

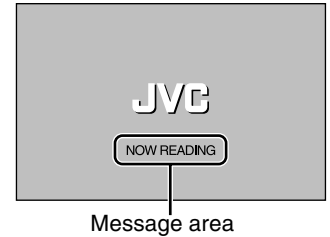

- To turn the power off

On the remote control:
Press **⏻/I AUDIO** again.

On the center unit:
Press **⏻/I STANDBY/ON** again.

The STANDBY lamp lights.

NOTE

- The power supply to the subwoofer is linked to the center unit. The POWER ON lamp on the subwoofer lights green when the power is turned on.
- A small amount of the power is consumed even when the power is turned off (center unit only). This is called standby mode and the STANDBY lamp lights in this mode. Unplug the power cord from the AC outlet to turn the power off completely.
- You can also turn on the system by pressing the following buttons;
 - One of **▲** buttons on the center unit
 - One of the source selecting buttons on the remote control
 - One of the DISC (1-5) buttons or **▶** on the center unit.
 You can use the same buttons on the remote control except after pressing FM/AM.

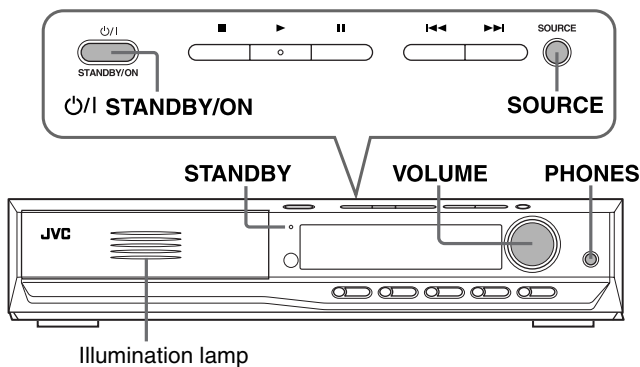

Selecting the source to play

On the remote control:

Press one of the source selecting buttons (DVD, FM/AM, AUX or TV SOUND).

- DVD:** To play back a disc (DVD, Video CD etc.). (pg. 21, 23)
- FM/AM:** To tune in an FM or AM (MW) station. (pg. 25)
Each time you press the button, the band alternates between FM and AM (MW).
- AUX:** To select the source from a component connected to the AUX IN jacks or DIGITAL IN jack. (pg. 12)
Each time you press the button, the source alternates between "AUX" and "AUX DIGITAL".
- TV SOUND:** To select the TV (that outputs sound signals) connected to the AV (SCART) connector. (pg. 8)

On the center unit:

Press SOURCE repeatedly until the source name you want appears on the display window.

Each time you press the button, the source changes as follows;

⇒ DVD ⇒ AM ⇒ FM ⇒ AUX ⇒ AUX DIGITAL ⇒ TV SOUND ⇒ (back to the beginning)

The selected source name appears on the display window.

Example: When "AUX" is selected.

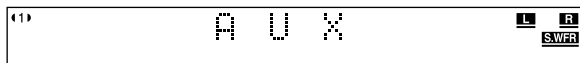

NOTE

- When a source except DVD is selected, this system does not output video signals.

Adjusting the volume

CAUTION

- Always set the volume to minimum level before starting any source. If the volume is set at its high level, the sudden blast of sound could permanently damage your hearing and/or blow out the speakers.

You can adjust the volume level within the range from "0" (minimum) to "70" (maximum).

On the remote control:

Press AUDIO VOL + or -.

- Press + to increase volume.
- Press - to decrease volume.

On the center unit:

Turn VOLUME.

- Turn VOLUME clockwise to increase volume.
- Turn VOLUME counterclockwise to decrease volume.

The volume level appears on the display window.

Listening with headphones

CAUTION

Be sure to turn down the volume;

- Before connecting or putting on headphones as high volume may damage both the headphones and your hearing.
- Before disconnecting headphones as high volume may be suddenly output from the speakers.

Connect a pair of headphones to the PHONES jack on the center unit. This cancels the surround mode (pg. 33) currently selected, deactivates the speakers, turns the subwoofer's power off, and activates the headphone mode. "HEADPHONE" appears on the display window.



- Disconnecting a pair of headphones from the PHONES jack cancels the headphone mode and activates the speakers at the previously selected surround mode.

Headphone mode

When using the headphones, the following signals are output regardless of your speaker setting;

- For 2 channel sources, the front left and right channel signals are output directly from the left and right headphones.
- For multi-channel sources, the front left and right, center and surround channel signals are down-mixed and then output from the headphones.
You can enjoy the down-mixed multi-channel sound source using the headphones.

Turning off the sound temporarily

On the remote control:

Press MUTING.

"MUTING" appears on the display window and the sound turns off.



To restore the sound

Press MUTING again.

- Pressing AUDIO VOL +/- (or turning VOLUME on the center unit) also restores the sound.

IMPORTANT

Before using the remote control for the following operation,

- Set the remote control mode selector to **AUDIO**.

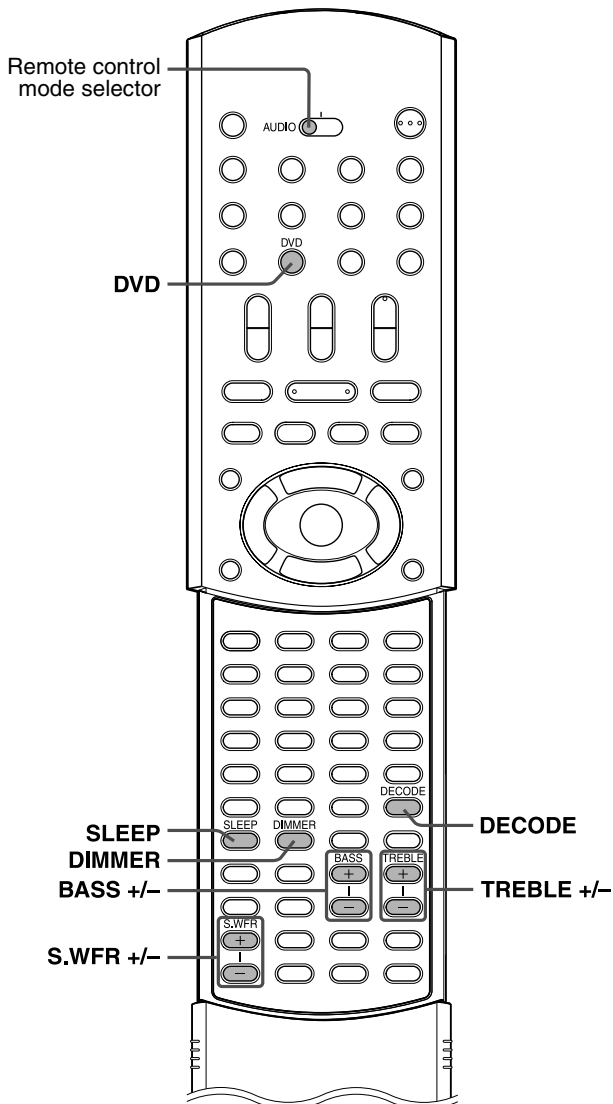
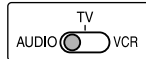

Adjusting the brightness

You can dim the indications on the display window and the illumination lamp level on the center unit.

On the remote control:

Press DIMMER.

Each time you press the button, the brightness level changes as follows;

⇒ **OFF** ⇒ **DIMMER1** ⇒ **DIMMER2** ⇒ **(back to the beginning)**

- **OFF:** Returns to the normal level.
- **DIMMER1:** Dims the display window and the illumination lamp.
- **DIMMER2:** Dims the display window more than DIMMER1 and turns off the illumination lamp.

Using the Sleep Timer

Using the Sleep Timer, you can fall asleep while listening to music and know the system will turn off by itself rather than play all night.

On the remote control:

Press SLEEP.

Each time you press the button, the shut-off time changes as follows;

⇒ **0min (cancelled)** ⇒ **10min (minutes)** ⇒ **20min** ⇒ **30min**
⇒ **60min** ⇒ **90min** ⇒ **120min** ⇒ **150min** ⇒ **(back to the beginning)**

To check the remaining time until the shut-off time

Press **SLEEP** once.

- The remaining time until the shut-off time appears on the display window for a while.

To change the remaining time until the shut-off time

Press **SLEEP** repeatedly.

- Each time you press the button, the shut-off time changes.

To cancel the Sleep Timer

Press **SLEEP** repeatedly until "0min" appears on the display window.

- Turning off the power also cancels the Sleep Timer.

NOTE

- When DVD is selected as the source to play, the system can also turn off automatically if playback is not restarted within the length of time you have specified (Auto Standby function). (☞ pg. 53)
- When both the Sleep Timer and Auto Standby function are activated, if the shut-off time set by the Auto Standby function comes earlier than the one set by the Sleep Timer, the Auto Standby function controls shut-off time.

Adjusting the output level of the subwoofer

You can adjust the output level within the range from -10 to 10.

On the remote control:

Press S.WFR +/-.

NOTE

- You can also make adjustments using the choice menu shown on the TV screen. (☞ pg. 52)
- The adjustments on a source take effect for the other sources.

Adjusting the bass/treble sound

You can adjust each enhancement level from the front speakers within the range from -10 to 10.

On the remote control:

Press BASS +/- for bass sound.

Press TREBLE +/- for treble sound.

NOTE

- You can also make adjustments using the choice menu shown on the TV screen. (☞ pg. 51)
- The adjustments on a source take effect for the other sources.
- You can adjust bass/treble enhancement level only for front left/right channel. However, the supplied speakers cannot add the effective change to the bass sound because of their cutoff frequency even if the bass sound adjustment is made. (☞ pg. 52)

To change the bass enhancement level more efficiently, adjust the output level of the subwoofer. (☞ “Adjusting the output level of the subwoofer”)

(When you change the front speakers to the larger ones and select “LARGE” for the front speakers in the SIZE sub-menu (☞ pg. 52), the effective adjustment of bass sound is also possible by pressing BASS +/- .)

Changing the decode mode

When you play a disc (or software) encoded with Dolby Digital or DTS Digital Surround, the following symptoms may occur;

- Sound does not come out at the beginning of playback.
- Noise comes out while searching for or skipping chapters or tracks.

In these cases, change the decode mode to “DOLBY D” (for Dolby Digital) or “DTS” (for DTS Digital Surround).

- When DVD or AUX DIGITAL is selected as the source

On the remote control:

Press DECODE to select the decode mode.

The current decode mode appears on the display window.

Example: When “AUTO/PCM” is selected.



Each time you press the button, the decode mode changes as follows;

⇒ **AUTO/PCM** ⇒ **DOLBY D** ⇒ **DTS** ⇒ **(back to the beginning)**

- **AUTO/PCM:** Normally select this. The system automatically detects the incoming signals.
- **DOLBY D:** Select this if the symptoms above occur when playing a disc (or software) encoded with Dolby Digital.
- **DTS:** Select this if the symptoms above occur when playing a disc (or software) encoded with DTS Digital Surround.

NOTE

- When “DOLBY D” or “DTS” is selected, if a signal encoded with another digital format comes in, you cannot listen to the sound. (The DIGITAL or indicator flashes.)
- Changing the source returns the decode mode to “AUTO/PCM” automatically.

Playback

This section explains basic operations of DVD player. For more details about DVD player operations, see pages 35 to 47.

- **DVD VIDEO SUPER AUDIO MP3 JPEG** shows the types of discs the operation is available for.
- Turn on your TV and select the correct input mode on the TV.

IMPORTANT

Before using the remote control for the following operation;

- 1 Set the remote control mode selector to **AUDIO**.
- 2 Press **DVD**.

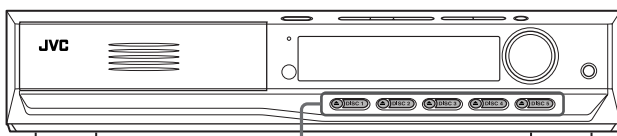
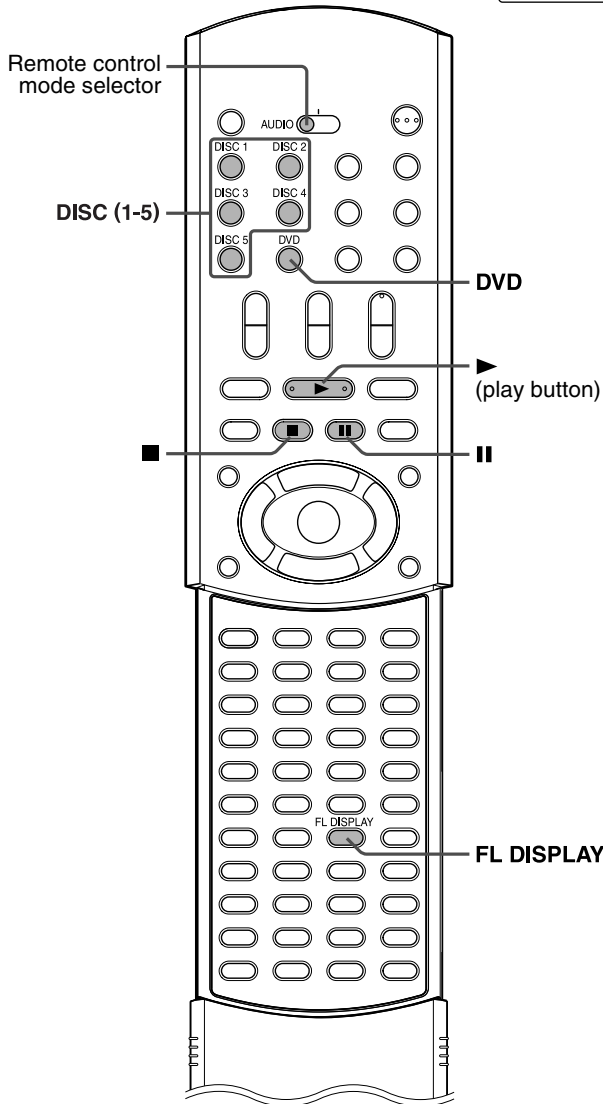
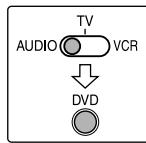

▲/DISC (1-5)

Basic playback

■ To load a disc

Up to 5 discs can be loaded.



1 Press ▲ for a desired disc tray on the center unit to open the disc tray.

The system turns on and the disc tray comes out.

2 Place a disc on the disc tray.

With the label side up

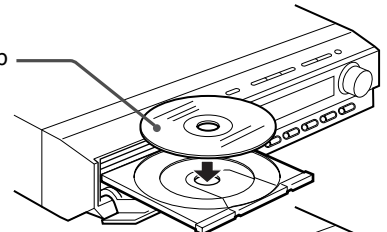

When placing an 8 cm disc

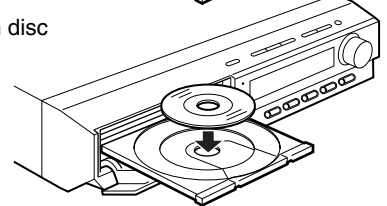

■ To start playback

3 Press the selected DISC (1-5) button.

The system starts playback after closing the disc tray.

You can use the same buttons on the center unit for operations unless otherwise noted.

When loading an MP3 disc

The MP3 control display (☞ pg. 38) appears on the TV screen and playback starts from the first track in the first group after pressing the DISC button in step 3. When all tracks in a group have been played, the system starts playback of tracks in the next group.

When loading a JPEG disc

The slide-show* playback starts from the first file in the first group after pressing the DISC button in step 3. When stopping playback of a JPEG disc, the JPEG control display (☞ pg. 39) appears on the TV screen.

* Slide-show

Each file (still picture) is shown on the TV screen for about 3 seconds, then changed to the next file one after another automatically. When all files in a group have been played, the system starts playback of files in the next group.

■ To pause playback

Press **II**.

To return to normal playback, press ► (play button).

■ To stop playback

Press **■**.

To change the playback disc while playing back the another disc

Press the desired DISC (1-5) button.

- If no disc is set in the specified tray, the system starts playback of the disc in the next tray automatically.

To remove a disc

Press ▲ for a desired disc tray on the center unit.

Playback

NOTE

- You can also start playback by pressing ► (play button) or DVD.
- Regardless of the operation for starting playback, the system plays back all available discs sequentially until you stop playback. However, the system stops playback after playback of the disc in the fifth tray.
- When Video CDs/SVCDs with PBC function (ⓘ pg. 4) or DVD that automatically go to the menu screen and wait for the next instruction, the system does not move to the next disc. In such a case, select the item to be played back from the menu. (ⓘ pg. 37)
- You can check playback information on the display window and the TV screen. (ⓘ pg. 35)
- Some tracks on an MP3 disc may be skipped or may not be played back normally.
- When you play back a JPEG disc, press buttons after the whole picture appears on the TV screen. The system cannot accept operations even though you press buttons while showing a picture.
- Some files on a JPEG disc may be played back distortedly.
- If a black screen continuously appears in the slide-show playback, the file currently being played may be a non-baseline JPEG file. In this case, select a playable file (a baseline JPEG file). For example, press ■ or MENU to open the JPEG control display, etc. Note that it may take a long time to select another file.

■ Resume Playback (DVD/Video CD/SVCD only)

When Resume Playback is set to "ON" (ⓘ pg. 53) and you stop playback by the following operations, the position where playback has been stopped is stored. (The RESUME indicator lights.)

- Turning off the power (ⓘ pg. 17)
- Pressing ■
- Changing the source (ⓘ pg. 18)

To start playback from the stored position

(The RESUME indicator goes off.)

- Press the selected DISC button or ► (play button) on the remote control or the center unit.
- Select DVD as the source again if you changed the source.

To clear the stored position

Press ■ again or open the disc tray with the playback disc.

- When the stored position has been cleared, playback starts from the beginning of the disc.

■ To prevent screen burn-out with the screen saver

A TV screen may burn out if a static picture is displayed for a long time. To prevent this, the system automatically dims the screen if a static picture is displayed for over 5 minutes (the screen saver function).

- Pressing any button will cancel the screen saver function.
- If you do not want to use the screen saver function, see page 51.

■ On-screen guide icons

During DVD playback, the following guide icons may appear for a while on the TV screen;

- : appears at the beginning of a scene containing multi-subtitle languages.
- : appears at the beginning of a scene containing multi-audio languages.
- : appears at the beginning of a scene containing multi-angle views.
- (Play), (Pause), / (Fast forward/fast-reverse), / (Slow-motion forward/reverse): appears when you perform each operation.
- If "⊙" appears on the TV screen when pressing a button, the disc cannot accept an operation you have tried to do or information required for that operation is not recorded to the disc.

NOTE

- In some cases, without showing "⊙", operations will not be accepted.
- If you do not want the on-screen guide icons to appear, see page 53.

■ Playback information on the display window

DVD

Example: When a DVD encoded with Dolby Digital 5.1ch is played

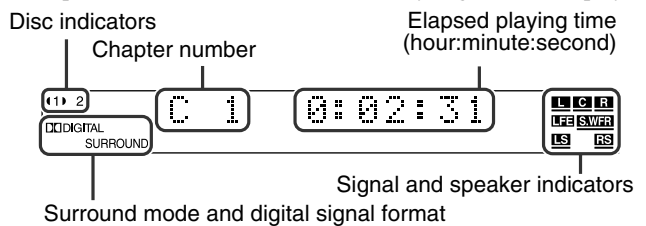

Each time FL DISPLAY is pressed, the indications alternate between those shown above and below.

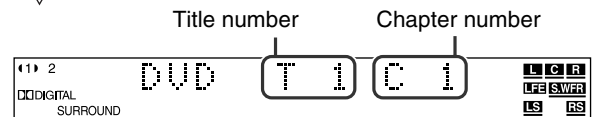

Video CD/SVCD/Audio CD

Example: When a Video CD is played back

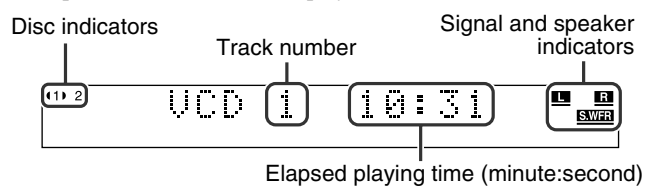

NOTE

- When a Video CD or SVCD with PBC function is played, the elapsed playing time does not appear, but "PBC" appears.

MP3 disc

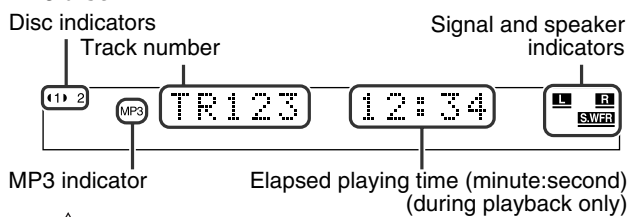

Each time FL DISPLAY is pressed, the indications alternate between those shown above and below.

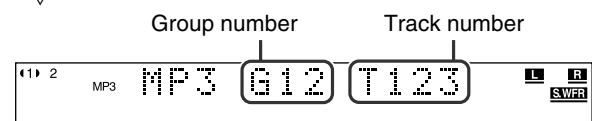

JPEG disc

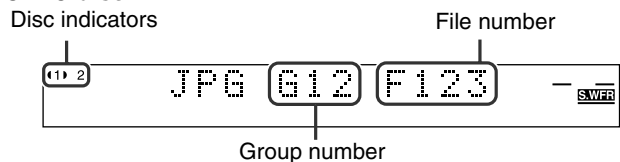

Continued on next page

Playback

NOTE

- You can change the time information mode. (☞ pg. 36)
- You can also check the playback information on the TV screen. (☞ pg. 35)

■ Disc information on the display window

The disc indicators on the display window show the current status of the corresponding disc tray.

Example: When the discs are loaded to disc trays 1, 2 and 5, and the disc in the disc tray 5 is selected.

Currently loaded disc numbers

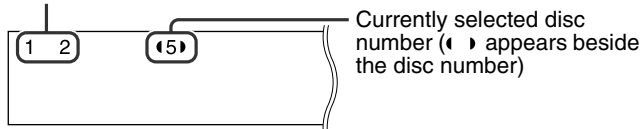

NOTE

- When loading a disc;
- Only after a DISC button is pressed the system starts reading the information of the disc on the specified tray. After that, the disc indicators show the current disc status correctly.

■ Tray lock

You can lock trays and prohibit the unwanted disc ejection by children.

On the center unit ONLY:

While the system is turned off

Press and hold ■, then press ▲ for DISC 1.

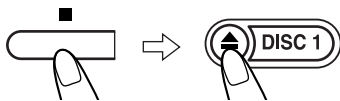

- The system turns on and "LOCKED" appears on the display window.
- If you try to eject discs, "LOCKED" appears and indicates that trays are locked.

To unlock trays

When the system is turned off, press and hold ■, then press ▲ for DISC 1.

- The system turns on and "UNLOCKED" appears on the display window.

Playback features

IMPORTANT

Before using the remote control for the following operation;

- 1 Set the remote control mode selector to AUDIO.
- 2 Press DVD.

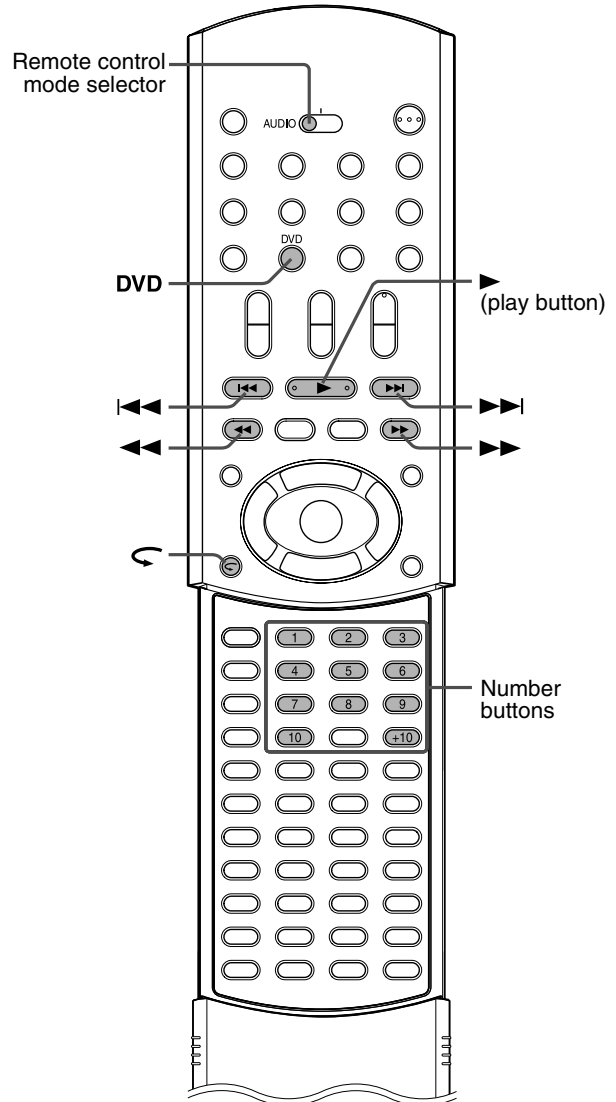
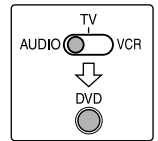

One Touch Replay

You can move back the playback position by 10 seconds from the current position.



- During playback

On the remote control:

Press ◀.

NOTE

- This function works between chapters in the same title.
- This function may not work for some DVDs.

Playback

Fast-forward/fast-reverse search

You can search for a particular point while playing a disc.



- During playback

On the remote control:

Press **▶▶/◀◀**.

Each time you press the button, the search speed changes as follows;

Forward:



Reverse:

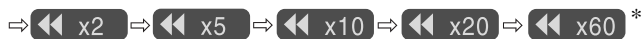

* **▶▶ x60** and **◀◀ x60** are only available for DVD.

To return to normal speed playback

Press **▶** (play button).

On the remote control and the center unit:

Press and hold **▶▶/◀◀**.

Continuously pressing **▶▶/◀◀** increases the fast-forward/reverse search speed as follows;



To return to normal speed playback

Release the button.

NOTE

- When a DVD, Video CD or SVCD is played back, no sound comes out during fast-forward/reverse search.
- When an Audio CD is played back, sound is intermittent and low during fast-forward/reverse search.
- This function may not work for some DVDs.

Locating the beginning of a desired selection

You can locate the beginning of a chapter, track or file.



- For DVD (chapter): During playback
For Video CD/SVCD (track): During playback without PBC function
For Audio CD/MP3/JPEG (track/file): During playback or while stopped

To skip chapters, tracks or files forward

Press **▶▶|** as many times as required.

To skip to the beginning of the current chapter, track or file

Press **|◀◀** once.

To skip chapters, tracks or files backward

Press **|◀◀** as many times as required.

NOTE

- This function may not work for some DVDs.
- When playing a Video CD or SVCD with the PBC function, **▶▶|** and **|◀◀** may be used for the operations of menu-driven playback. (☞ pg. 4, 37)
- When playing back an MP3/JPEG disc, you can make operations using the MP3/JPEG control display. (☞ pg. 38, 39)

Locating a desired selection using number buttons

You can locate the desired title, chapter, track or file by selecting its number.



- For DVD (title, chapter):
While stopped (the title number is selected.)
During playback (the chapter number is selected.)
For Video CD/SVCD (track): During playback without PBC function
For Audio CD/MP3/JPEG (track/file): During playback or while stopped

On the remote control:

Press number buttons (1-10, +10) to select the desired title, chapter or track number.

Examples:

To select 3: Press 3.

To select 14: Press +10, then 4.

To select 24: Press +10 twice, then 4.

To select 40: Press +10 three times, then 10.

The specified title, chapter, track or file number appears on the display window and playback begins from that location.

NOTE

- While playing a DVD, if a menu is shown on the TV screen, number buttons may be used for selecting an item in the menu. (☞ pg. 36)
- While playing a Video CD or SVCD with the PBC function, if a menu is shown on the TV screen, number buttons are used for selecting an item in the menu. (☞ pg. 37)

Tuner operations

You can browse through all the stations or use the preset function to go immediately to a particular station.

IMPORTANT

Before using the remote control for the following operation;

- 1 Set the remote control mode selector to AUDIO.
- 2 Press FM/AM.

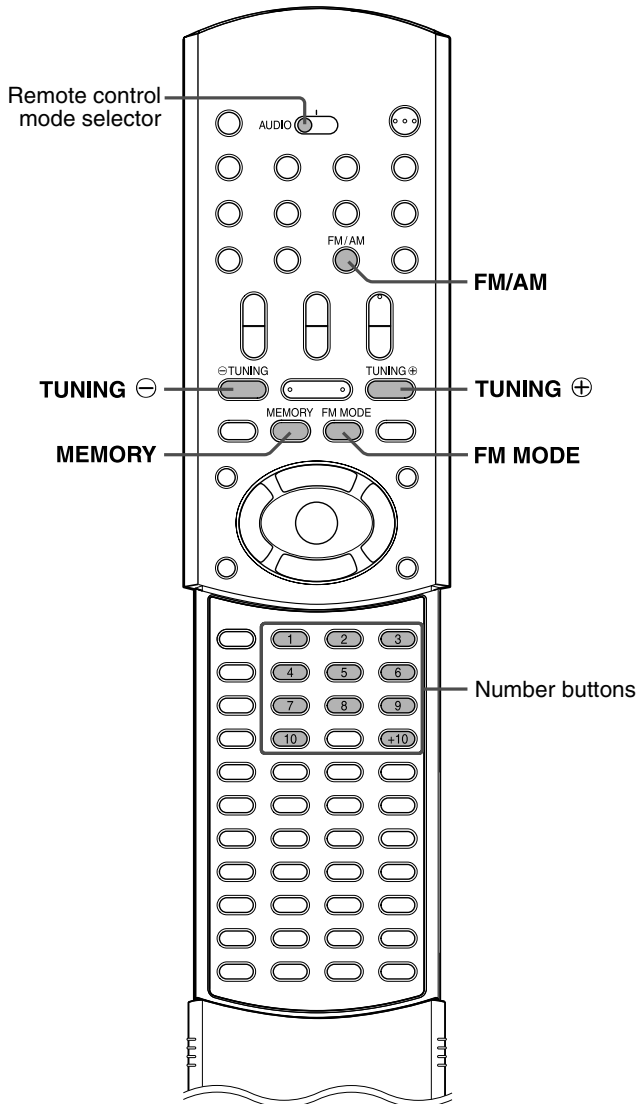
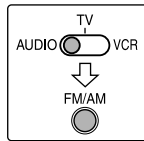

Manual tuning

On the remote control:

1 Press FM/AM repeatedly to select the band.

Each time you press the button, the band alternates between FM and AM (MW).

The selected band appears on the display window, then the last received station appears.

Example: When AM is selected



↓ After a few seconds

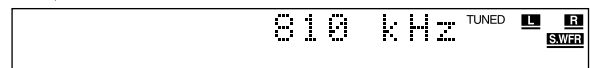

2 Press TUNING + or TUNING - repeatedly until you find the frequency you want.

When you hold down the button until the system starts searching for stations and then release it, the system stops searching automatically when a station of sufficient signal strength is tuned in to.

- TUNING +: Increases frequency.
- TUNING -: Decreases frequency.

NOTE

- When a station of sufficient signal strength is tuned in, the TUNED indicator lights on the display window.
- When an FM stereo program is received, the ST indicator lights on the display window.

Preset tuning

Once a station is assigned to a channel number, the station can be quickly tuned in. You can preset 30 FM and 15 AM (MW) stations.

■ To preset the stations

NOTE

Before you start operation;

- There is a time limit when doing the following steps. If the setting is cancelled before you finish, start from step 2 again.

1 Tune in the station you want to preset.

- For the detailed procedure, see "Manual tuning".
- If you want to store the FM reception mode for an FM station, select the reception mode you want. See "Selecting the FM reception mode" (pg. 26).



Tuner operations

2 Press MEMORY.

The channel number position starts flashing on the display window for about 5 seconds.



While the channel number position is flashing:

3 Press number button(s) (1-10, +10) to select a channel number.

The channel number and the CH indicator start flashing.

Examples:

For channel number 3: Press 3.

For channel number 14: Press +10, then 4.

(For FM stations only)

For channel number 24: Press +10 twice, then 4.

For channel number 30: Press +10 twice, then 10.

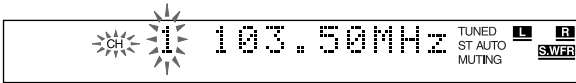

While the selected number is flashing:

4 Press MEMORY again.

The selected number stops flashing.

The station is assigned to the selected preset number.

5 Repeat steps 1 to 4 until you store all the stations you want.

To erase a stored preset station

Storing a new station to a used number erases the previously stored one.

■ To tune in to a preset station

On the remote control:

1 Press FM/AM repeatedly to select the band.

Each time you press the button, the band alternates between FM and AM (MW).

2 Press number button(s) (1-10, +10) to select a preset channel number.

Examples:

For channel number 3: Press 3.

For channel number 14: Press +10, then 4.

(For FM stations only)

For channel number 24: Press +10 twice, then 4.

For channel number 30: Press +10 twice, then 10.

Selecting the FM reception mode

When the stereo FM program currently tuned in is noisy, you can change the FM reception mode to improve the reception.

- You can store the FM reception mode for each preset station. See “Preset tuning” (☞ pg. 25).

- While listening to an FM station

On the remote control:

Press FM MODE.

The FM reception mode appears on the display window.

Each time you press the button, the FM reception mode alternates between “AUTO MUTING” and “MONO”.

• AUTO MUTING:

When a program is broadcast in stereo, you will hear stereo sound. (The ST indicator lights on the display window.) When in monaural, you will hear monaural sound. This mode is also useful to suppress static noise between stations. The AUTO MUTING indicator lights on the display window.

• MONO:

Reception will be improved although you will lose the stereo effect. (The ST indicator goes off.) In this mode, you will hear noise until you are tuned in to a station. (The AUTO MUTING indicator also goes off.)

Reducing the noise of AM (MW) broadcast

When listening to an AM (MW) broadcast with a lot of noise interference, you can change the Beat Cut mode to reduce the noise.

- While listening to an AM (MW) station

On the remote control:

Press FM MODE.

The current Beat Cut mode appears on the display window.

Each time you press the button, the Beat Cut mode alternates between “BEAT CUT 1” and “BEAT CUT 2”.

- Choose “BEAT CUT 1” or “BEAT CUT 2” according to which gives clearer sound.

Using the RDS (Radio Data System) when receiving FM stations

RDS allows FM stations to send an additional signal along with their regular program signals. For example, the stations send their station names, as well as information about what type of program they broadcast, such as sports or music, etc.

When tuned in to an FM station which provides the RDS service, the RDS indicator lights up on the display window.

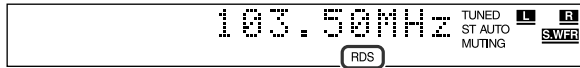

RDS indicator

With the system, you can receive the following types of RDS signals:

- PS (Program Service): Shows commonly known station names.
- PTY (Program Type): Shows types of broadcast programs.
- RT (Radio Text): Shows text messages the station sends.
- Enhanced Other Network: See page 29.

NOTE

- RDS is not available for AM (MW) broadcasts.
- RDS may not operate correctly if the station tuned is not transmitting RDS signal properly or if the signal strength is weak.

IMPORTANT

Before using the remote control for the following operation;

- 1 Set the remote control mode selector to AUDIO.
- 2 Press FM/AM.

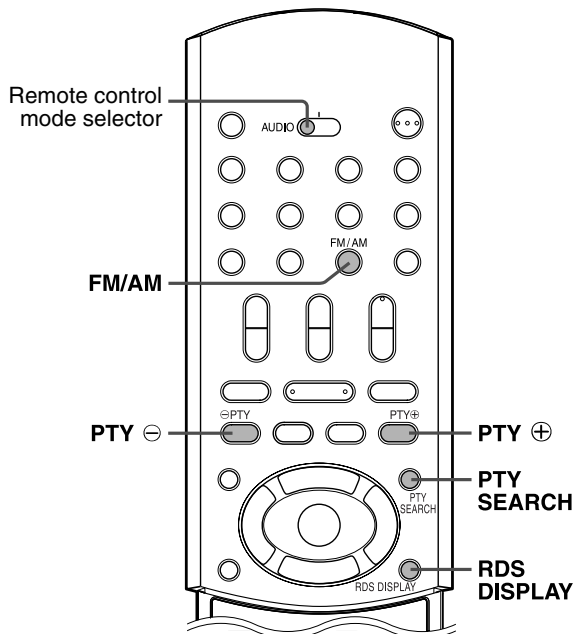
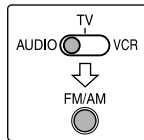

■ To show the RDS signals information

On the remote control:

Press **RDS DISPLAY** while listening to an FM station.

Each time you press the button, the indication on the display window changes to show you the following information:

⇒ **PS** ⇒ **PTY** ⇒ **RT** ⇒ **Frequency (Normal indication)** ⇒ **(back to the beginning)**

PS (Program Service):

While searching, "PS" appears and then the station names will be displayed. "NO PS" appears if no signal is sent.

PTY (Program Type):

While searching, "PTY" appears and then the type of the broadcast program will be displayed. "NO PTY" appears if no signal is sent.

RT (Radio Text):

While searching, "RT" appears and then text messages the station sends will be displayed. "NO RT" appears if no signal is sent.

Frequency:

Station frequency (non-RDS service).

About characters shown on the display window

When PS, PTY, or RT signals appear on the display window, some special characters and marks may not be displayed correctly.

NOTE

- If searching finishes at once, "PS", "PTY", and "RT" will not appear on the display window.

Searching for a program by PTY codes

One of the advantages of the RDS service is that you can locate a particular kind of program from the preset channels (☞ pg. 25) by specifying the PTY codes.

■ To search for a program using the PTY codes

NOTE

Before you start operation;

- The PTY Search is only applicable to preset stations.
- To stop searching any time during the process, press PTY SEARCH while searching.
- There is a time limit in doing the following steps. If the setting is canceled before you finish, start from step 1 again.

On the remote control:

1 Press PTY SEARCH while listening to an FM station.

“PTY SELECT” flashes on the display window.

While “PTY SELECT” is flashing:

2 Press PTY ⊕ or PTY ⊖ until the PTY code you want appears on the display window.

- For details, see “Description of the PTY codes” (☞ pg. 29).

While the PTY code selected in step 2 is still on the display window:

3 Press PTY SEARCH again.

While searching, “SEARCH” and the selected PTY code alternate on the display window.

The system searches 30 preset FM stations, stops when it finds the one you have selected, and tunes in that station.

To continue searching after the first stop

Press PTY SEARCH again while the indications on the display window are flashing.

If no program is found, “NOT FOUND” appears on the display window.

The PTY codes appears on the display window in the order of the table below.



Continued on next page

Tuner operations

Description of the PTY codes

News:	News.
Affairs:	Topical program expanding or enlarging upon the news — debate, or analysis.
Info:	Programs the purpose of which is to impart advice in the widest sense.
Sport:	Programs concerned with any aspect of sports.
Educate:	Educational programs.
Drama:	All radio plays and serials.
Culture:	Programs concerning any aspect of national or regional culture, including language, theater, etc.
Science:	Programs about natural sciences and technology.
Varied:	Used for mainly speech-based programs such as quizzes, panel games and personality interviews.
Pop M:	Commercial music of current popular appeal.
Rock M:	Rock music.
Easy M:	Current contemporary music considered to be “easy-listening”.
Light M:	Instrumental music, and vocal or choral works.
Classics:	Performances of major orchestral works, symphonies, chamber music, etc.
Other M:	Music not fitting into any of the other categories.
Weather:	Weather reports and forecasts.
Finance:	Stock Market reports, commerce, trading etc.
Children:	Programs targeted at a young audience.
Social:	Programs about sociology, history, geography, psychology and society.
Religion:	Religious programs.
Phone In:	Involving members of the public expressing their views either by phone or at a public forum.
Travel:	Travel information.
Leisure:	Programs about recreational activities.
Jazz:	Jazz music.
Country:	Songs which originate from, or continue the musical tradition of the American Southern States.
Nation M:	Current popular music of the nation or region in that country’s language.
Oldies:	Music from the so-called “golden age” of popular music.
Folk M:	Music which has its roots in the musical culture of a particular nation.
Document:	Programs concerning factual matters, presented in an investigative style.
TEST:	Broadcasts for testing emergency broadcast equipment or unit.
Alarm !:	Emergency announcement.
None:	No program type, undefined program, or difficult to categorize into particular types.

NOTE

- Classification of the PTY codes for some FM stations may be different from the above list.

Switching to broadcast program of your choice temporarily

Another convenient RDS service is called “Enhanced Other Network”.

This allows the system to switch temporarily to a broadcast program of your choice (TA, News, and/or Info) from a different station except in the following cases:

- When you are listening to non-RDS stations (all AM – MW stations, some FM stations and other sources).
- When the system is in standby mode.

NOTE

Before you start operations;

- The Enhanced Other Network function is only applicable to preset stations.

IMPORTANT

Before using the remote control for the following operation;

- Set the remote control mode selector to **AUDIO**.
- Press **FM/AM**.

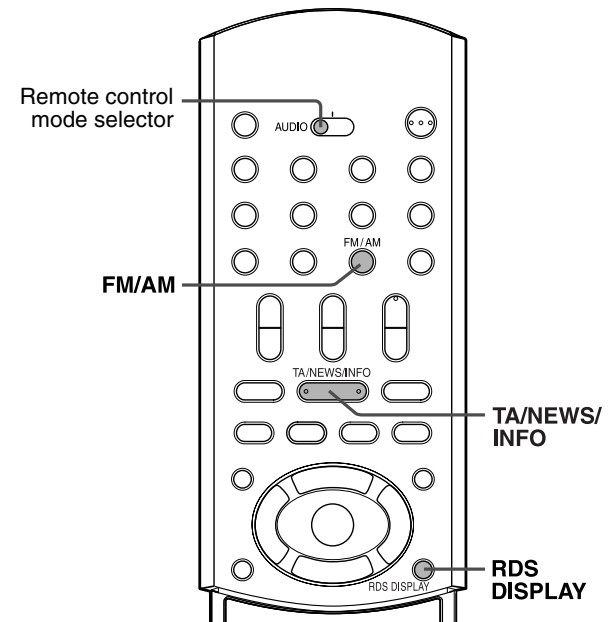
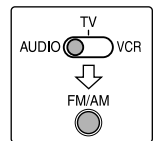

Press TA/NEWS/INFO repeatedly until the program type indicator (TA/News/Info) you want appears on the display window.

Each time you press the button, the indicator on the display window changes to show the following:



The program type indicator

⇒ **TA** ⇒ **News** ⇒ **Info** ⇒ **TA/News** ⇒ **TA/Info** ⇒ **News/Info** ⇒ **TA/News/Info** ⇒ **None** ⇒ (back to the beginning)

TA: Traffic Announcement in your area.

News: News.

Info: Program the purpose of which is to impart advice in the widest sense.

Tuner operations

To stop listening to the program selected by Enhanced Other Network

Press TA/NEWS/INFO repeatedly again so that the program type indicator (TA/News/Info) goes off from the display window. The system exits from Enhanced Other Network standby mode and goes back to the previously selected station.

When an emergency broadcast (Alarm ! signal) is sent from an FM station

The system automatically tunes in to the station and "Alarm !" appears on the display window while the system receiving the emergency broadcast.

Note that an emergency broadcast cannot be received in the following cases;

- When you are listening to non-RDS stations (all AM — MW stations, some FM stations and other sources).
- When the system is in standby mode.

The TEST signal is used for equipment test — whether it can receive the Alarm signal correctly

The TEST signal makes the system work in the same way as the Alarm signal does. If the TEST signal is received, the system automatically switches to the station broadcasting the TEST signal. While receiving the TEST signal, "TEST" appears on the display window.

■ How the Enhanced Other Network function actually works

Case 1

If there is no station broadcasting the program you have selected

The system continues tuning in to the current station.



When a station starts broadcasting the program you have selected, the system automatically switches to the station. The indicator of received PTY code starts flashing.



When the program is over, the system goes back to the previously tuned station, but the Enhanced Other Network function still remains activated.

Case 2

If the FM station you are listening to is broadcasting the program you have selected

The system continues to receive the station but the indicator of received PTY code starts flashing.



When the program is over, the indicator of received PTY code stops flashing and remains lit, but the Enhanced Other Network function still remains activated.

NOTE

- In Enhanced Other Network standby mode, if you change the source to play, Enhanced Other Network standby mode is canceled temporarily.
If you change the source to FM again, the system returns to Enhanced Other Network standby mode.
- Enhanced Other Network data sent from some stations may not be compatible with this system.
- Enhanced Other Network does not function for some FM stations with RDS service.
- While listening to a program tuned in by the Enhanced Other Network function, the station does not change even if another network station starts broadcasting a program of the same Enhanced Other Network data.
- While listening to a program tuned in by the Enhanced Other Network function, you can only use TA/NEWS/INFO and RDS DISPLAY as the tuner operation buttons.

Creating realistic sound fields

You can use the following surround modes to reproduce a realistic sound field.

- **Dolby Surround**
 - Dolby Pro Logic II
 - Dolby Digital
- **DTS Digital Surround**
- **DSP modes**
 - DAP modes
 - All Channel Stereo

■ Dolby Surround

Dolby Pro Logic II*

Dolby Pro Logic II has a newly developed multichannel playback format to decode all 2 channel sources — stereo source and Dolby Surround encoded source — into a 5.1 channel.

The matrix-based encoding/decoding method used by Dolby Pro Logic II makes no limitation for the cutoff frequency of the treble from surround channel and enables stereo surround sound compared to conventional Dolby Pro Logic.

Dolby Pro Logic II enables to reproduce spacious sound from original sound without adding any new sounds and tonal coloration. Dolby Pro Logic II has two modes — Movie mode and Music mode:

- **Pro Logic II Movie (PL II MOVIE)**

Suitable for reproduction of Dolby Surround encoded sources bearing the mark . You can enjoy soundfield very close to the one created with discrete 5.1 channel sounds.

- **Pro Logic II Music (PL II MUSIC)**

Suitable for reproduction of any 2 channel stereo music sources. You can enjoy wide and deep sound by using this mode.

- When Dolby Pro Logic II is activated, the  indicator lights on the display window.

Dolby Digital*

Used to reproduce multichannel soundtracks of the software encoded with Dolby Digital ().

Dolby Digital 5.1 ch (DOLBY D) encoding method (so-called discrete multichannel digital audio format) records and digitally compresses the front left channel, front right channel, center channel, surround left channel, surround right channel and LFE channel signals.

Since each channel is completely independent from the other channel signals to avoid interference, you can obtain much better sound quality with much stereo and surround effects.

NOTE

- Dolby Digital software can be roughly grouped into two categories—multichannel (up to “5.1” channel) and 2 channel software. To enjoy surround sounds while playing Dolby Digital 2 ch software, you can use Dolby Pro Logic II.

■ DTS Digital Surround**

Used to reproduce multichannel soundtracks of the software encoded with DTS Digital Surround ().

DTS Digital Surround (DTS) is another discrete multichannel digital audio format available on CD, LD and DVD software. Compared to Dolby Digital, audio compression ratio is relatively low. This fact allows DTS Digital Surround format to add breadth and depth to the reproduced sounds. As a result, DTS Digital Surround features natural, solid and clear sound.

■ DSP modes

DAP (Digital Acoustic Processor) modes

DAP modes have been designed to create important acoustic surround elements.

The sound heard in a live club, dance club, hall or pavilion consists of direct sound and indirect sound — early reflections and reflections from behind. Direct sounds reach the listener directly without any reflection. On the other hand, indirect sounds are delayed by the distances of the ceiling and walls (see the diagram below).

These indirect sounds are important elements of the acoustic surround effects. The DAP mode can reproduce a realistic sound field by adding these indirect sounds.

The following DAP modes are provided with this system.

LIVE CLUB	Gives the feeling of a live music club with a low ceiling.
DANCE CLUB	Gives a throbbing bass beat.
HALL	Gives clear vocal and the feeling of a concert hall.
PAVILION	Gives the spacious feeling of a pavilion with a high ceiling.

These DAP modes can be used to add the acoustic surround effects while reproducing 2 channel stereo source, and can give you a real “being there” feeling.

- When one of the DAP modes is selected, the DSP indicator lights on the display window.

* **Manufactured under license from Dolby Laboratories. “Dolby”, “Pro Logic” and the double-D symbol are trademarks of Dolby Laboratories.**

** **“DTS” and “DTS Digital Surround” are registered trademarks of Digital Theater Systems, Inc.**

Creating realistic sound fields

Creating sound field

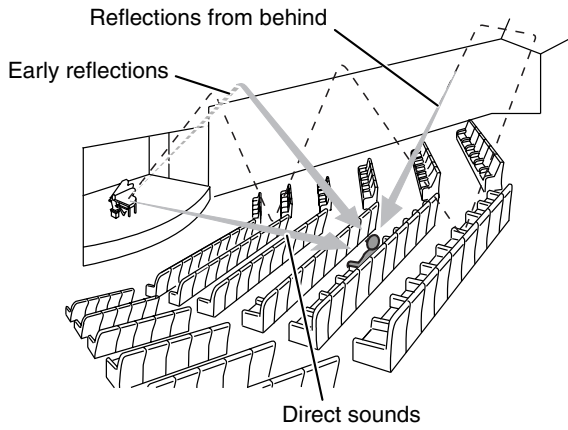

All Channel Stereo

All Channel Stereo (ALL CH ST.) mode can reproduce a larger stereo sound field using all the connected (and activated) speakers. All Channel Stereo can be used while reproducing 2 channel stereo source.

- When All Channel Stereo is selected, the DSP indicator lights on the display window.

All Channel Stereo reproduction

Normal stereo sound

All Channel Stereo

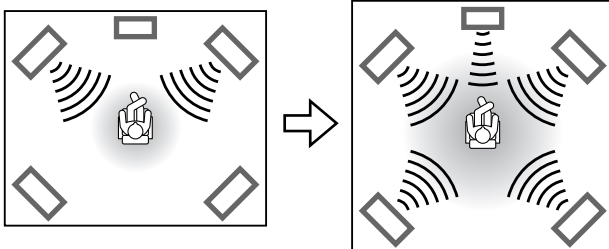

Indicators on the display window

Digital signal format indicators

- LPCM:** Lights when Linear PCM signal comes in.
- DIGITAL:** Lights when Dolby Digital signals come in.
- DTS:** Lights when DTS Digital (Surround) signals come in.
- No indication: No digital signal indicator lights when analog signals come in.

Source signal indicators, etc.

Light to indicate the incoming signals.

- L:** Lights when the left channel signal comes in.
- C:** Lights when the center channel signal comes in.
- R:** Lights when the right channel signal comes in.
- LFE:** Lights when the LFE channel signal comes in.
- LS:** Lights when the surround left channel signal comes in.
- RS:** Lights when the surround right channel signal comes in.
- S:** Lights when the monaural surround channel signal or 2 channel Dolby Surround signal comes in.
- SWFR:** Always lights.



The channel with “—” shows that the corresponding speakers are reproducing the channels’ sound.

If the channels’ sound decoded into 5.1 channel is reproduced, only “—” lights.

Available Surround modes for each input signal

The ✓ marks show available surround modes.

Signal	Mode	Surround off (SURR OFF)	Dolby Surround			DTS Digital Surround (DTS)	DSP mode				
			PL II MOVIE*	PL II MUSIC*	Dolby Digital		DAP mode				ALL CH ST.*
							LIVE CLUB*	DANCE CLUB*	HALL*	PAVILION*	
Dolby Digital (Multichannel)		✓	—	—	✓	—	—	—	—	—	—
Dolby Digital (2 channel)		✓	✓	✓	—	—	—	—	—	—	—
DTS Digital Surround (Multichannel)		✓	—	—	—	✓	—	—	—	—	—
DTS Digital Surround (2 channel)		✓	✓	✓	—	—	—	—	—	—	—
Analog (VCR/FM/AM) or Linear PCM		✓	✓	✓	—	—	✓	✓	✓	✓	✓

* You can select these modes by pressing SURROUND (MODE). (pg. 33)

IMPORTANT

Before using the remote control for the following operation;

- Set the remote control mode selector to **AUDIO**.

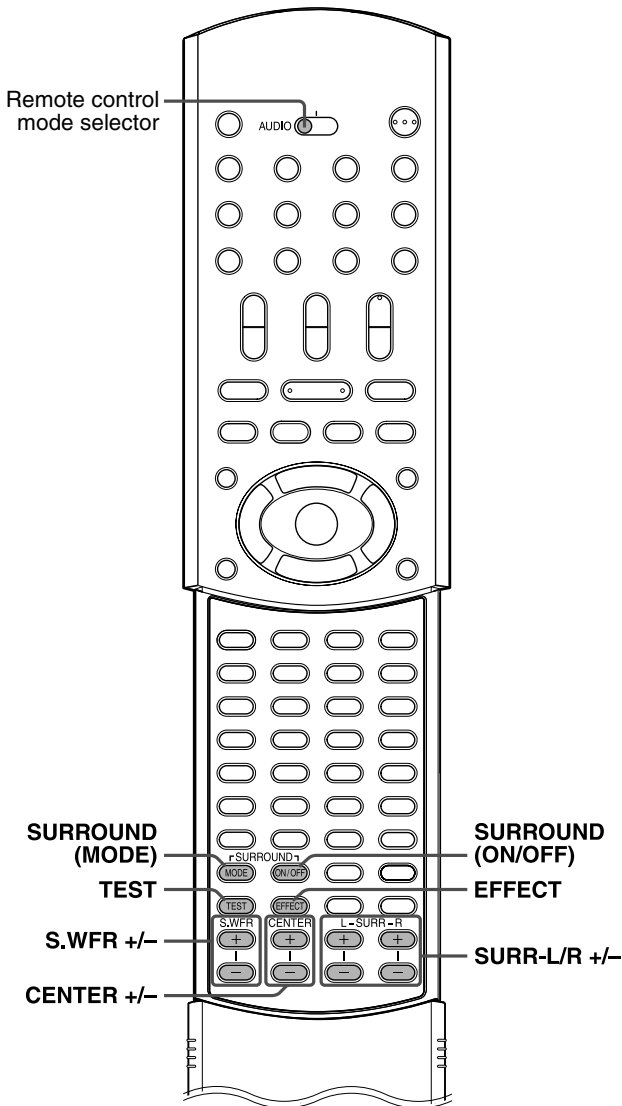
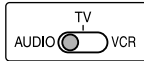

Using the surround mode

The system is set up to automatically select the optimal surround mode for input signal from digital multichannel software. When playing back 2 channel source, you can select the desired surround mode manually.

On the remote control:

■ When playing back digital multichannel software

The appropriate multichannel surround mode is automatically activated.

“DOLBY D”: When a software encoded with Dolby Digital is played back

“DTS”: When a software encoded with DTS Digital Surround is played back

In these cases, you can only turn on or off (“SURR OFF”) the surround mode.

■ When playing back 2 channel source

You can select either mode of Dolby Pro Logic II (PL II MOVIE/ PL II MUSIC) or one of the DSP modes (LIVE CLUB/DANCE CLUB/HALL/PAVILION/ALL CH ST.).

Press SURROUND (MODE).

The surround mode is turned on and the current surround mode appears on the display window.

Each time you press the button, the surround mode changes as follows;

⇒ PL II MOVIE ⇒ PL II MUSIC ⇒ LIVE CLUB ⇒ DANCE CLUB ⇒ HALL ⇒ PAVILION ⇒ ALL CH ST. ⇒ (back to the beginning)

For details on each mode, see pages 31 and 32.

To turn off the surround mode

Press SURROUND (ON/OFF).

Each time you press the button, the surround mode turns on and off alternately.

SURR OFF (surround off) ⇐ current selected mode (surround on)

NOTE

- When selecting “PL II MUSIC”, “PL II MOVIE”, “DOLBY D” or “DTS” as the surround mode, the SURROUND indicator lights.
- When selecting one of the DSP modes (“LIVE CLUB”/“DANCE CLUB”/“HALL”/“PAVILION”/“ALL CH ST.”) as the surround mode, the DSP indicator lights.
- For Dolby Digital 2 channel software, you can select “PL II MUSIC” or “PL II MOVIE”.

Storing adjustments — auto memory

This system memorizes the surround mode settings for each source.

- When you turn the power off:
 - When turning the power on again, the memorized settings for the current source are automatically recalled.
- When you change the source:
 - The memorized settings for the newly selected source are automatically recalled.

NOTE

- If the source is FM or AM (MW), you can assign a different setting for each band.

Adjusting the sound

On the remote control:

1 Press TEST.

Check if you can hear the sounds through all the speakers at the equal level.
“TEST TONE” and the corresponding signal indicator starts flashing on the display window, and the test tone comes out of the speakers in the following order;



⇒ **Front left speaker (FL)** ⇒ **Center speaker (C)** ⇒
Front right speaker (FR) ⇒ **Surround right speaker (SR)** ⇒
Surround left speaker (SL) ⇒ **(back to the beginning)**

2 Adjust the speaker output levels (-10 to +10).

Adjust the center speaker and surround speaker levels as much as the sound from the front speakers. Use one of the following buttons to adjust each speaker level.

- CENTER +/- for the center speaker
- SURR-L +/- for the surround left speaker
- SURR-R +/- for the surround right speaker

3 Press TEST again to stop the test tone.

■ For DAP modes (☞ pg. 31) only

4 Press EFFECT to select the effect level (1 to 5) you want.

Each time you press the button, the effect level changes as follows;

⇒ **DSP EFFECT 1** ⇒ **DSP EFFECT 2** ⇒ **DSP EFFECT 3**
⇒ **DSP EFFECT 4** ⇒ **DSP EFFECT 5** ⇒ **(back to the beginning)**

As the number increases, the selected mode will be more effective. (Normally set the level to “DSP EFFECT 3”.)

NOTE

- You cannot adjust the center speaker output level for the DAP modes and the effect level for All Channel Stereo.
- You can output the test tone in any surround mode, or even when surround mode is not activated.
- Speaker output levels whose source signal indicator is lit can be adjusted without pressing TEST.
- When selecting DVD as the source, you can also adjust the speaker output levels using the choice menu. (☞ pg. 51)

Advanced operations

This section explains advanced operations for disc playback using the remote control.

- shows the types of discs an operation is available for.
- Turn on your TV and select the correct input mode on the TV.

NOTE

- If "⊗" appears on the TV screen when pressing a button, the disc cannot accept an operation you have tried to do or information required for that operation is not recorded to the disc.

Using the on-screen bar

You can check disc information while the disc is loaded and you can use some functions using the on-screen bar.

IMPORTANT

Before using the remote control for the following operation;

- 1 Set the remote control mode selector to **AUDIO**.
- 2 Press **DVD**.

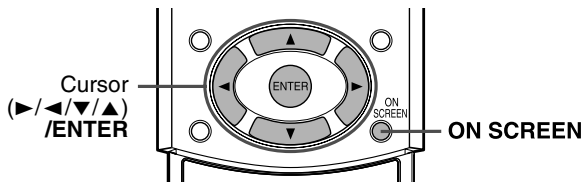
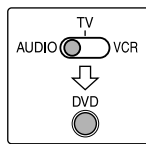

Showing the on-screen bar

- Whenever a disc is loaded



Press ON SCREEN.

Each time you press the button, the on-screen bar changes as follows on the TV screen.

Example: During DVD playback

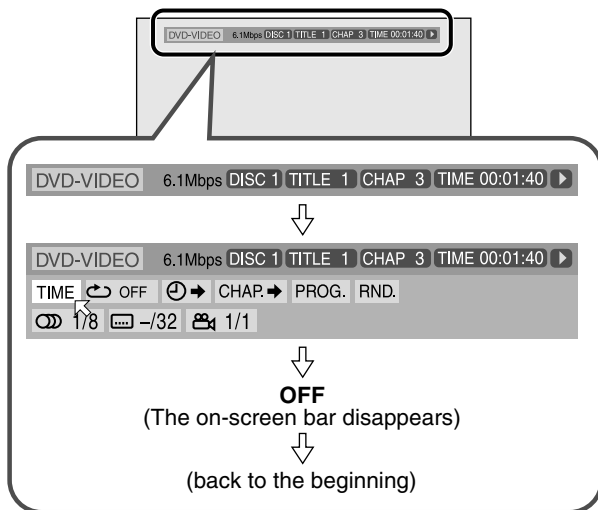

- The on-screen bar displays "NO-DISC" if no disc is loaded.

■ Contents of the on-screen bar during playback

DVD

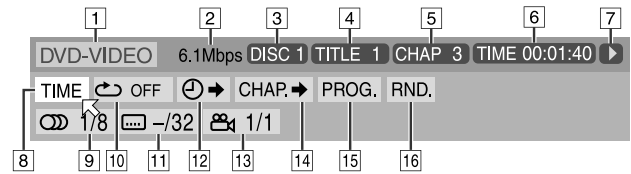

Video CD

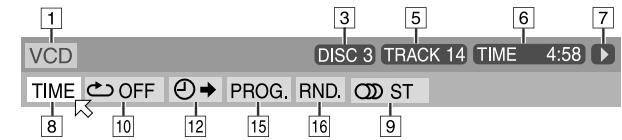

SVCD

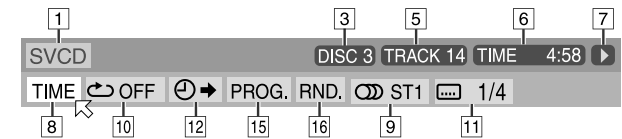

CD

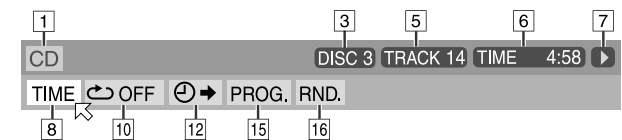

MP3 disc

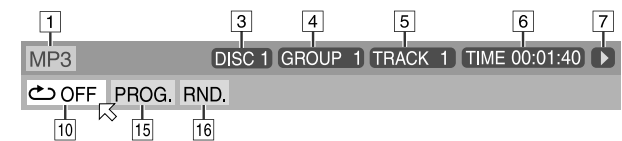

- 1 Shows disc type.
- 2 Shows current transfer rate (Megabits per second).
- 3 Shows disc number.
- 4 Shows current title (for DVD) or group (for MP3) number.
- 5 Shows current chapter number (for DVD) or track number (for other type of discs).
- 6 Shows time information. (⌚ pg. 36)
- 7 Shows playback status.
 - ▶: appears during playback.
 - ⏩ / ⏪: appears during fast forward/reverse.
 - ⏭ / ⏮: appears during playback in forward slow-motion/reverse slow-motion.
 - ⏸: appears when paused.
 - ⏹: appears when stopped.
- 8 Select this to change time information (6). (⌚ pg. 36)
- 9 Select this to change audio language or channel. (⌚ pg. 41, 42)
- 10 Select this for Repeat Playback. (⌚ pg. 46)
- 11 Select this to change subtitle language. (⌚ pg. 41)
- 12 Select this for time search function. (⌚ pg. 38)
- 13 Select this to change view angle. (⌚ pg. 40)
- 14 Select this for chapter search function. (⌚ pg. 37)
- 15 Select this for Program Playback. (⌚ pg. 45)
- 16 Select this for Random Playback. (⌚ pg. 46)

Basic operation on the on-screen bar

Example: When selecting the Repeat mode of DVD

- During playback or while stopped

1 Press ON SCREEN twice.

- The on-screen bar appears on the TV screen.
- The currently selected item shows green.

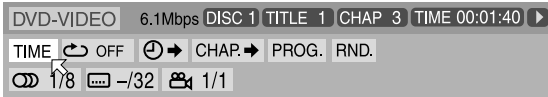

2 Press Cursor ▶/◀ to move to .

3 Press ENTER.

- The pop-up window appears under the selected item.
- The current setting appears.



4 Press Cursor ▼/▲ to select the desired option.

- Each time you press the button, the options change.

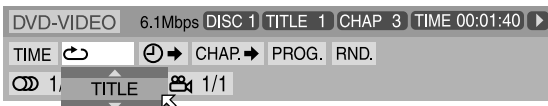

5 Press ENTER.

- The setting changes and the pop-up window disappears.



To turn off the on-screen bar

Press ON SCREEN.

NOTE

- See the corresponding pages for details on each function.

Changing the time information

You can change the time information in the on-screen bar on the TV screen and the display window of the center unit.



- During playback or while stopped

1 Press ON SCREEN twice.

- The on-screen bar appears on the TV screen.

2 Press Cursor ▶/◀ to move to to TIME.

3 Press ENTER.

- Each time you press the button, the time information changes as follows;

Example: During DVD playback

⇒ TIME 0:25:58 ⇒ REM 0:18:14 ⇒ TOTAL 1:25:58

⇒ T.REM 0:45:41 ⇒ (back to the beginning)

- TIME: Elapsed playing time of current chapter/track
- REM: Remaining time of current chapter/track
- TOTAL: Elapsed time of disc
- T. REM: Remaining time of disc

To turn off the on-screen bar

Press ON SCREEN.

NOTE

- While playing a Video CD, SVCD or Audio CD, the hour digit indication does not appear.

Playing from a specified position on a disc

You can start playing a title, chapter or track you specify. You can also play a disc from specified time.

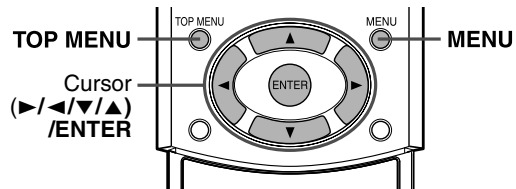

Locating a desired scene from the DVD menu

DVDs generally have their own menus which show disc contents. These menus contain various items such as titles of movies, names of songs or artist information, and you can display them on the TV screen. You can locate a desired scene by using these menus.



- Whenever a DVD is loaded

1 Press TOP MENU or MENU.

The menu appears on the TV screen.

Example:

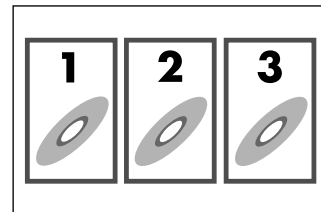

Normally, a DVD which contains more than one title will have a "title" menu which lists the titles. Press TOP MENU to show the title menu.

Some DVDs may also have a different menu which is shown by pressing MENU.

See the instructions for each DVD regarding its particular menu.

2 Use Cursor ▶/◀/▼/▲ to select a desired item.

3 Press ENTER.

The system starts playback of the selected item.

- With some discs, you can also select items by entering the corresponding number using number buttons.

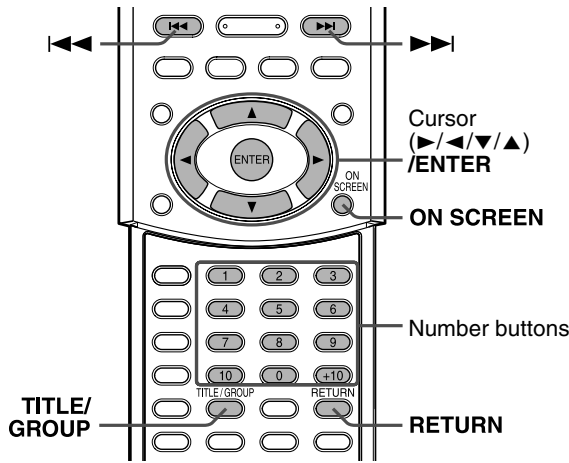

Locating a desired scene using a Video CD/SVCD menu with PBC

A Video CD or SVCD recorded with PBC has its own menus such as a list of contained songs. You can locate a specific scene by using these menus. (☞ pg. 4)



- When the menu appears on the TV screen during playback with PBC function

Press number buttons (1-10, +10) to select the number of the desired item.

The system starts playback from the selected item.

Example:

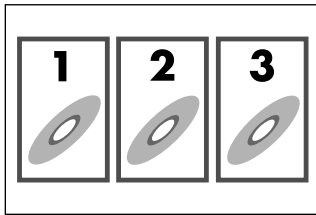

To select the number

Example:
To select 3: Press 3.
To select 11: Press +10, then 1.

To return to the menu

Press RETURN.

When "NEXT" or "PREVIOUS" is shown on the TV screen:

- To go to the next page, press ►►.
- To return to the previous page, press ◀◀.

NOTE

- If you want to play a PBC-compatible Video CD/SVCD without using the PBC function, perform any of the following:
 - Start playback by pressing number buttons while stopped.
 - Press ►► repeatedly until the desired track number is displayed, then start playback by pressing ► (play button).
The track number appears on the display window instead of "PBC".
- To activate the PBC function when playing a PBC-compatible Video CD/SVCD without using the PBC function, perform any of the following:
 - Press TOP MENU or MENU.
 - Press ■ twice to stop playback, then press ► (play button).

Locating a desired chapter using the on-screen bar

When playing back a DVD, you can locate the chapter number to be played using the on-screen bar.



- During playback

1 Press ON SCREEN twice.

The on-screen bar appears on the TV screen.

2 Press Cursor ►/◀ to move to CHAP.►.

3 Press ENTER.

The following pop-up window appears under the selected item.

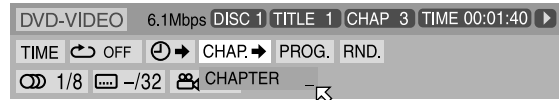

4 Press number buttons (0-10) to enter the desired chapter number.

Example:

- To select 8: Press 8.
- To select 10: Press 10.
- To select 20: Press 2, then 0.
- To select 37: Press 3, then 7.

To correct a misentry

Repeat step 4 until the correct number appears in the pop-up window.

5 Press ENTER.

The system starts playback from the selected chapter.

To turn off the on-screen bar

Press ON SCREEN.

NOTE

- The +10 button is not used by this function.
- You can select up to the 99th chapter.

Locating a desired title/group using number buttons

When playing back a disc with more than one title or one group, you can specify a desired title or group to be played using number buttons.



1 Press TITLE/GROUP.

"_ _" is shown in the title/group display area in the display window.

Example: During DVD playback

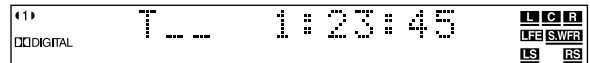

2 Use number buttons (0-10, +10) to enter the desired title or group number.

The system starts playback from the first chapter/track/file of the selected title/group.

Example:

To select 8: Press 8.

To select 10: Press 10.

Or press +10, then 0.

To select 20: Press +10, then 10.

Or press +10 twice, then 0.

To select 25: Press +10 twice, then 5.

- Specify the number within 5 seconds after pressing TITLE/GROUP (i.e. while the display window shows “_” for the title/group number, instead of the current number).

- You can also specify the desired chapter/track/file by using number button. (☞ pg. 24)

NOTE

- This function may not work for some DVDs.

Locating a desired position by specifying the time

You can start playing at your desired position by specifying the elapsed playing time from the beginning of the current title (for DVD), or from the beginning of the disc (for Video CD/SVCD/Audio CD).



- For DVD:
During playback
- For Video CD/SVCD:
While stopped or during playback without PBC function
- For Audio CD:
During playback or while stopped

1 Press ON SCREEN twice.

The on-screen bar appears on the TV screen.

2 Press Cursor ▶/◀ to move to ↻ to ⏮→.

3 Press ENTER.

The following pop-up window appears under the selected item.



4 Use number buttons (0-9) to enter the time.

Example:

To play back from a point 2 (hours): 34 (minutes): 08 (seconds) elapsed

TIME _ : _ : _ ⇒ TIME 2 : _ : _ ⇒
Press 2 Press 3

TIME 2 : 3 _ : _ ⇒ TIME 2 : 3 4 : _ ⇒
Press 4 Press 0

TIME 2 : 3 4 : 0 _ ⇒ TIME 2 : 3 4 : 0 8
Press 8

To correct a misentry

Press Cursor ◀ repeatedly until the wrong number is erased, then press number buttons to enter the correct numbers.

5 Press ENTER.

The system starts playback from the specified time.

To turn off the on-screen bar

Press ON SCREEN.

NOTE

- You can also use the 10 button to enter “0”.
- The +10 button is not used by this function.
- You can specify time in hours/minutes/seconds for DVD and in minutes/seconds for Video CD/SVCD/Audio CD.

Using the MP3 control display

You can search and play desired groups and tracks using the MP3 control display.

■ MP3 control display

The MP3 control display appears on the TV screen and playback starts when a MP3 disc is selected.

Total group number on Current track Total track number in disc number current group

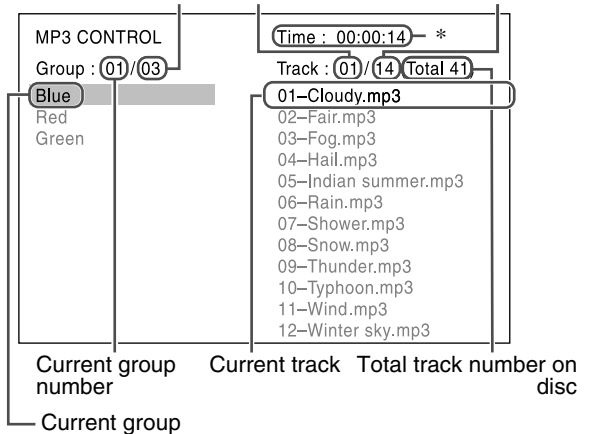

* Elapsed playing time of current track
Elapsed playing time is only shown during playback.

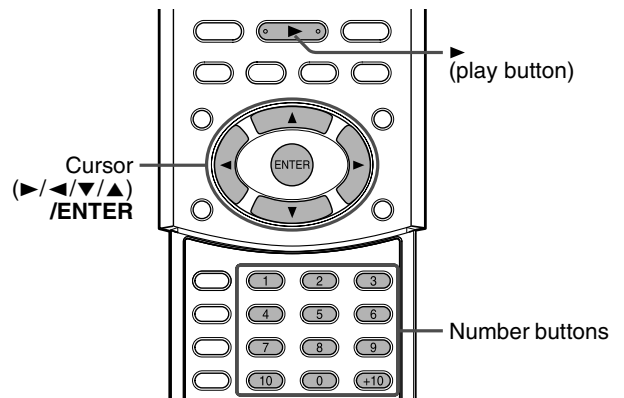

■ During playback

1 Press Cursor ▼/▲ to select the desired group.

2 Press Cursor ▶ to select the track list.

3 Press Cursor ▼/▲ to select the desired track.

The playback starts from the selected track.

If you select the track while stopped

Press ENTER or ▶ (play button) to start playback of the selected track.

Advanced operations

To select the other group

Press Cursor ◀ to return to the group list, then press Cursor ▼/▲ to select the desired group.

To skip groups/tracks during playback

Press Cursor ▼ repeatedly for forward-skip.
Press Cursor ▲ repeatedly for reverse-skip.

To start playback by specifying the track number

Press number buttons (0-10, +10) to enter the track number.

Example:

To select 3: Press 3.

To select 14: Press +10, then 4.

To select 20: Press +10, then 10.

Or press +10 twice, then 0.

To select 24: Press +10 twice, then 4.

To select 110: Press +10 ten times, then 10.

The entered number appears in the track number indication and playback starts from the track you have specified.

NOTE

- You can also check playback information on the display window. (☞ pg. 22)
- Some group and track names may not be displayed correctly depending on recording conditions.
- The order of groups and tracks on an MP3 disc may be displayed differently from the order displayed on your personal computer.
- Up to 12 groups and tracks are displayed at once. Pressing Cursor ▼/▲ repeatedly scrolls the display to show the hidden groups and tracks one by one.

Using the JPEG control display

You can search and show desired groups and files using the JPEG control display.

■ JPEG control display

The JPEG control display appears on the TV screen when stopping playback of a JPEG disc.

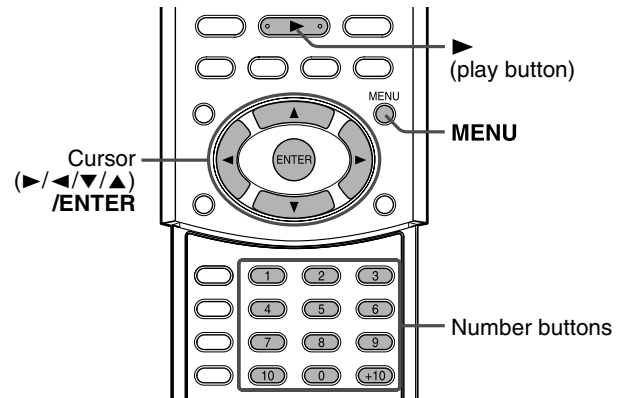
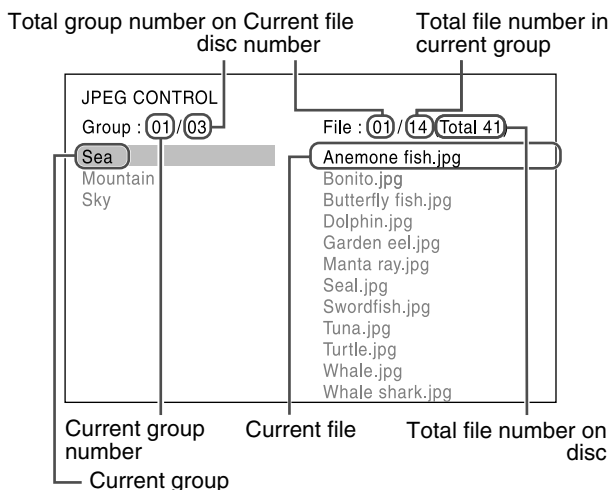

■ While stopped

1 Press Cursor ▼/▲ to select the desired group.

2 Press Cursor ▶ to select the file list.

3 Press Cursor ▼/▲ to select the desired file.

4 Press ▶ (play button) to start the slide-show playback from the selected file.

To show only the selected file

Press ENTER.

- When a still picture is completely shown on the TV screen, you can zoom in on areas in the still picture. (☞ pg. 43)

To select the other group

Press Cursor ◀ to return to the group list, then press Cursor ▼/▲ to select the desired group.

To start the slide-show playback by specifying the file number

Press number buttons (0-10, +10) to enter the file number.

Example:

To select 3: Press 3.

To select 14: Press +10, then 4.

To select 20: Press +10, then 10.

Or press +10 twice, then 0.

To select 24: Press +10 twice, then 4.

To select 110: Press +10 ten times, then 10.

The entered number appears in the file number indication and the slide-show playback starts from the file you have specified.

To return to the JPEG control display

Press MENU.

NOTE

- Some group and file names may not be displayed correctly depending on recording conditions.
- The order of groups and files on a JPEG disc may be displayed differently from the order displayed on your personal computer.
- Up to 12 groups and files are displayed at once. Pressing Cursor ▼/▲ repeatedly scrolls the display to show the hidden groups and files one by one.

Selecting a view angle of DVD

While playing back a DVD containing multi-view angles, you can enjoy the same scene at different angles.

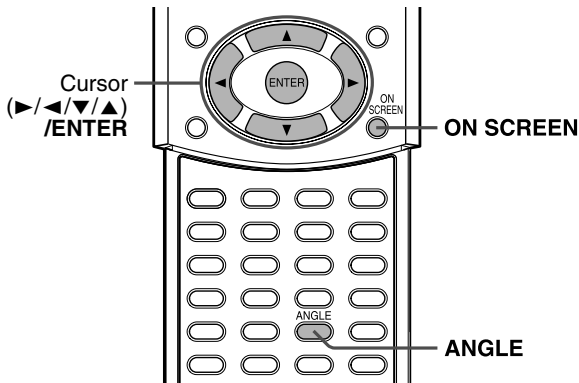

Selecting a view angle

■ During playback

When using the **ANGLE** button:

DVD

1 Press ANGLE.

The following pop-up window appears on the TV screen.

Example: The first view angle is selected out of 3 view angles recorded.

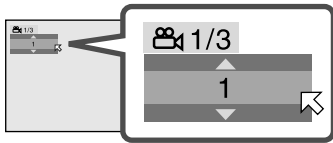

2 Press ANGLE repeatedly to select the desired view angle.

Each time you press the button, the angle of the scene changes.

Example:

⇒ 1/3 ⇒ 2/3 ⇒ 3/3 ⇒ (back to the beginning)

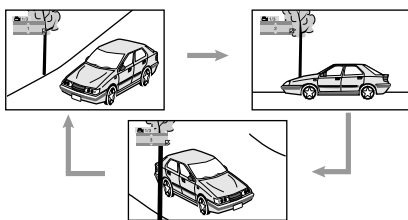

The pop-up window disappears if no operation is done for about 5 seconds.

When using the on-screen bar:

1 Press ON SCREEN twice.

The on-screen bar appears on the TV screen.

2 Press Cursor ►/◄ to move to [camera icon].

3 Press ENTER.

The following pop-up window appears under the selected item.

Example: The first view angle is selected out of 3 view angles recorded.

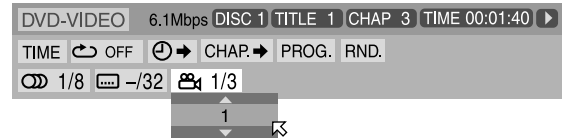

4 Press Cursor ▼/▲ repeatedly to select the desired view angle.

Each time you press the button, the angle of the scene changes.

5 Press ENTER.

The pop-up window disappears.

To turn off the on-screen bar

Press ON SCREEN.

Selecting the subtitle/ audio languages

When playing back a DVD (or SVCD) containing subtitles in several languages, you can select the subtitle language to be displayed on the TV screen.

When a DVD contains audio (sound track) in several languages, you can also select the language (sound track) to listen to.

- You can also select specific audio channel(s) on Video CDs/ SVCDs.

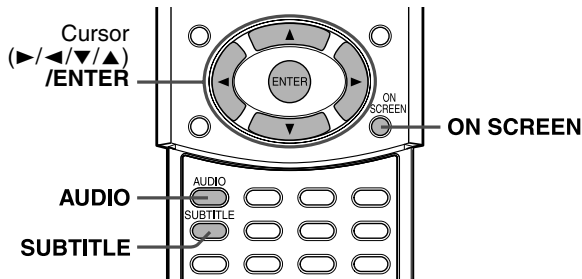

Selecting the subtitle language

- During playback



When using the **SUBTITLE** button:

1 Press SUBTITLE.

The following pop-up window appears on the TV screen.

Example (DVD): "ENGLISH" is selected out of 3 subtitle languages recorded.

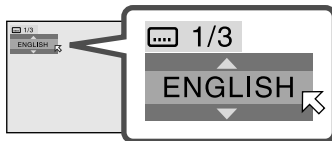

2 Press SUBTITLE repeatedly to select the desired subtitle language.

Each time you press the button, the subtitle language changes.

For SVCD

- An SVCD can contain up to four subtitles. Pressing SUBTITLE changes the subtitles regardless of whether the subtitles are recorded or not. (Subtitles will not change if no subtitle is recorded.)

The pop-up window disappears if no operation is done for about 5 seconds.

NOTE

- Some subtitle languages are abbreviated in the pop-up window. See "The language codes list" (pg. 50).

When using the on-screen bar:

1 Press ON SCREEN twice.

The on-screen bar appears on the TV screen.

2 Press Cursor ►/◄ to move to [] .

3 Press ENTER.

The following pop-up window appears under the selected item.

Example (DVD): "ENGLISH" is selected out of 3 subtitle languages recorded.

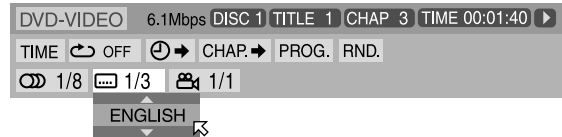

4 Press Cursor ▼/▲ repeatedly to select the desired subtitle language.

Each time you press the button, the subtitle language changes.

5 Press ENTER.

The pop-up window disappears.

To turn off the on-screen bar

Press ON SCREEN.

Selecting the audio language

- During playback



When using the **AUDIO** button:

1 Press AUDIO.

The following pop-up window appears on the TV screen.

Example: "ENGLISH" is selected out of 3 audio languages recorded.

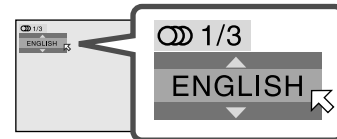

2 Press AUDIO repeatedly to select the desired audio language.

Each time you press the button, the audio languages change.

The pop-up window disappears if no operation is done for about 5 seconds.

NOTE

- Some audio languages are abbreviated in the pop-up window. See "The language codes list" (pg. 50).

When using the on-screen bar:

1 Press ON SCREEN twice.

The on-screen bar appears on the TV screen.

2 Press Cursor ►/◄ to move to [] .

3 Press ENTER.

The following pop-up window appears under the selected item.

Example: "ENGLISH" is selected out of 3 audio languages recorded.

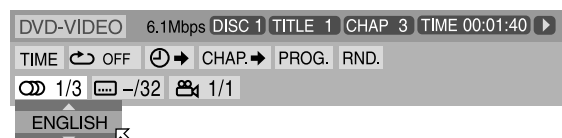

4 Press Cursor ▼/▲ to select the desired audio language.

Each time you press the button, the audio language changes.

5 Press ENTER.

The pop-up window disappears.

To turn off the on-screen bar

Press ON SCREEN.

NOTE

- Some audio languages are abbreviated in the pop-up window. See "The language codes list" (☞ pg. 50).

Selecting the audio channel

When you play certain karaoke (Video CD/SVCD), you can enjoy karaoke by selecting the audio channel to play.



- The sound of each audio channel depends on the contents of the disc.

- During playback

When using the AUDIO button:

1 Press AUDIO.

The following pop-up window appears on the TV screen.

Example: "ST" (stereo) is selected out of 3 audio channels recorded.

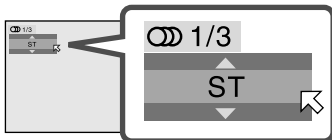

2 Press AUDIO repeatedly to select the desired audio channel.

Each time you press the button, the audio channel changes.

Example for Video CD:

⇒ ST ⇒ L ⇒ R ⇒ (back to the beginning)

- ST: To listen to normal stereo playback.
- L: To listen to L (left) audio channel only.
- R: To listen to R (right) audio channel only.

Example for SVCD:

⇒ ST 1 ⇒ ST 2 ⇒ L 1 ⇒ R 1 ⇒ L 2 ⇒ R 2 ⇒ (back to the beginning)

- ST 1/ST 2: To listen to normal stereo playback of ST 1 or 2 channel.
- L 1/L 2: To listen to L (left) 1 or 2 audio channel.
- R 1/R 2: To listen to R (right) 1 or 2 audio channel.

The pop-up window disappears if no operation is done for about 5 seconds.

When using the on-screen bar:

1 Press ON SCREEN twice.

The on-screen bar appears on the TV screen.

2 Press Cursor ►/◀ to move to .

3 Press ENTER.

The following pop-up window appears under the selected item.

Example: "ST" (stereo) is selected out of 3 audio channels recorded.

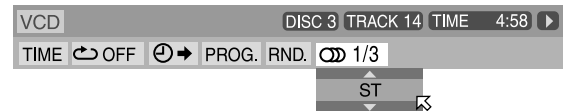

4 Press Cursor ▼/▲ to select the desired audio channel(s).

Each time you press the button, the audio channel changes.

5 Press ENTER.

The pop-up window disappears.

To turn off the on-screen bar

Press ON SCREEN.

Special picture playback

This system provides special picture playback functions including frame-by-frame, slow-motion and zoom.

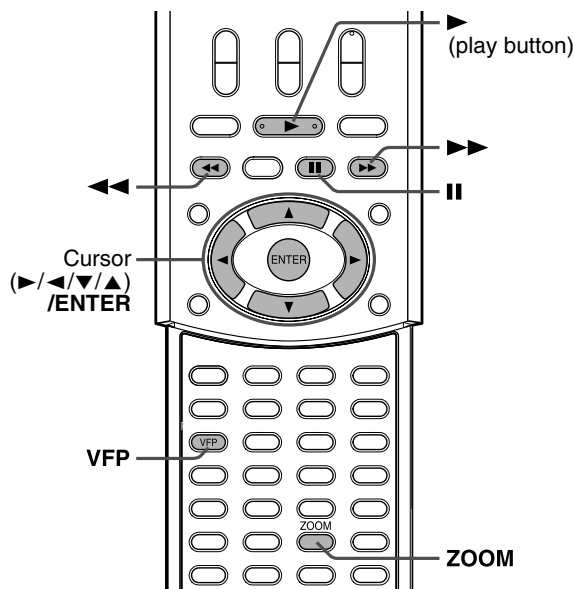

Frame-by-frame playback

■ During playback

Press II repeatedly.

Each time you press the button, the still picture advances by one frame.

To return to normal playback

Press ► (play button).

NOTE

- You can perform the above operation using the buttons on the center unit.



Playing back in slow-motion

■ During playback

1 Press II at the point where you want to start playback in slow-motion from.

The system pauses playback.

2 Press ►►.

- Playback in forward slow-motion starts.

For DVD only:

- To play back in reverse slow-motion, press ◀◀.

Each time you press the button, the playback speed become faster and on-screen guide icon changes as follows;

Forward:

⇒ ►► 1/32 ⇒ ►► 1/16 ⇒ ►► 1/8 ⇒ ►► 1/4 ⇒ ►► 1/2

Reverse:

⇒ ◀◀ 1/32 ⇒ ◀◀ 1/16 ⇒ ◀◀ 1/8 ⇒ ◀◀ 1/4 ⇒ ◀◀ 1/2

To pause slow-motion playback

Press II.

To return to normal playback

Press ► (play button).

NOTE

- Sound cannot be heard during slow-motion playback.

Zooming in

■ During playback or while paused

1 Press ZOOM.



Each time you press ZOOM, scene magnification changes as follows;

⇒ x 1 (normal size) ⇒ x 1.8 ⇒ x 4 ⇒ x 8 ⇒ x 16 ⇒ x 32
⇒ x 64 ⇒ (back to the beginning)

Example: When x4 zoom is selected.

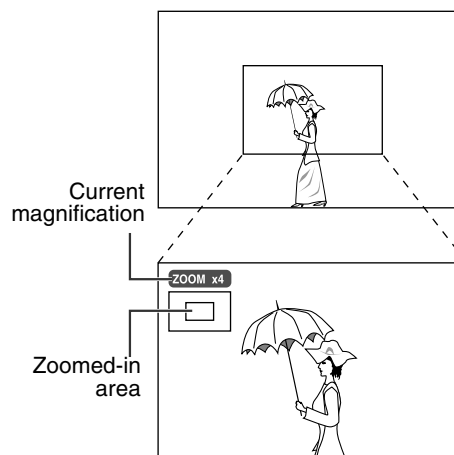

2 While zoomed in, press Cursor ►/◀/▼/▲ to move zoom-in area.

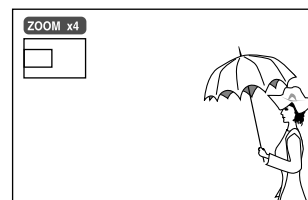

To return to normal playback

Press ENTER.

NOTE

- Picture may look coarse while zoomed in.

Changing the VFP setting

The VFP (Video Fine Processor) function enables you to adjust the picture character according to the type of programming, picture tone or personal preference.



NOTE

Before you start operation;

- The VFP setting screen disappears if no operations are done for more than about 10 seconds. If the setting screen disappears before you finish, start from step 1 again.

■ To select a VFP mode

1 Press VFP during playback.

The current VFP settings appear on the TV screen.

Example: When "NORMAL" is selected.

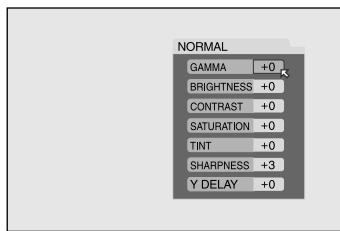

2 Press Cursor ▶/◀ repeatedly to select the VFP mode.

Each time you press the button, the VFP mode changes as follows;

⇄ NORMAL ⇄ CINEMA ⇄ USER 1 ⇄ USER 2 ⇄ (back to the beginning)

- NORMAL: Normally select this.
- CINEMA: Suitable for movies.
- USER 1 and USER 2:
You can adjust parameters that affect picture appearance and store settings. Go to step 3.

NOTE

- You cannot adjust the parameters of "NORMAL" and "CINEMA". Press VFP to return to normal screen.

■ To adjust picture appearance manually

3 Press Cursor ▶/◀ repeatedly to select "USER 1" or "USER 2".

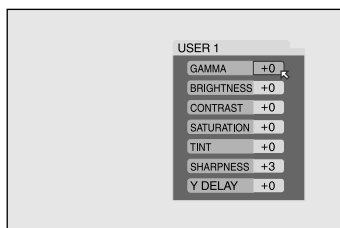

4 Press Cursor ▼/▲ repeatedly to select a parameter you want to adjust.

Adjust gradually and confirm picture appearance results are as preferred.

- GAMMA (-4 to +4):
Controls brightness of neutral tints while maintaining brightness of dark and bright portions.
- BRIGHTNESS (-16 to +16):
Controls screen brightness.
- CONTRAST (-16 to +16):
Controls screen contrast.
- SATURATION (-16 to +16):
Controls screen color depth.
- TINT (-16 to +16):
Controls screen tint.
- SHARPNESS (+0 to +3):
Controls screen sharpness.
- Y DELAY (-2 to +2):
Controls screen color gap.

5 Press ENTER.

VFP menu disappears and the following pop-up window appears on the TV screen.

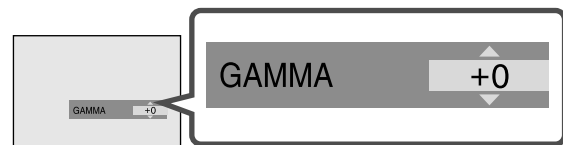

6 Press Cursor ▼/▲ repeatedly to change the setting.

7 Press ENTER.

The current VFP settings appear again.

8 Repeat steps 4 to 7 to adjust other parameters.

To return to the normal screen

Press VFP.

To activate your setting

Press VFP, then press Cursor ▶/◀ repeatedly to select "USER 1" or "USER 2" that you have changed the parameters.

Program Playback

You can play up to 99 titles (for DVD) or tracks (for other types of discs) in any order from among multiple discs. You may program the same title or track more than once.

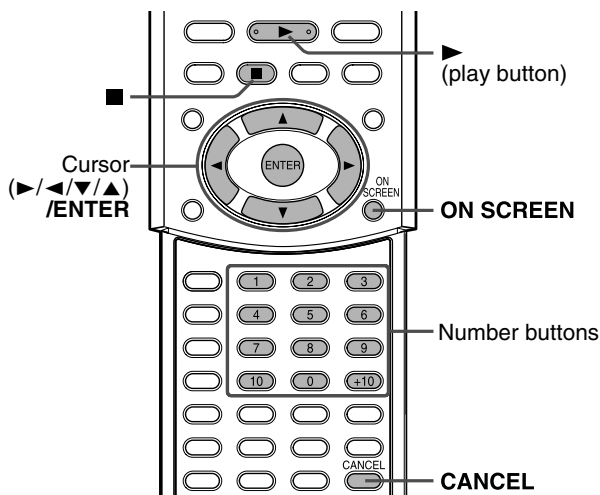

■ While stopped

1 Press ON SCREEN twice.

The on-screen bar appears on the TV screen.

2 Press Cursor ►/◄ to move to PROG.

3 Press ENTER.

The program menu appears on the TV screen.

- 10 orders appear at a time.

No.	Disc	Group	Track
1			
2			
3			
4			
5			
6			
7			
8			
9			
10			

4 ¹: When programming titles/tracks of DVD/Video CD/ SVCD/Audio CD

Press number buttons (1-10, +10) to specify selections by disc and title/track.

- At each program order use number buttons to specify source disc number first, press ENTER, then specify title/track number on source disc.

Example: To specify "title 3/track 3" of "disc 2"

Press 2 ⇒ ENTER* ⇒ 3

* You can also use any number buttons instead of ENTER.

(A number entered for a group number is invalid.)

When you specify the currently selected disc number (pg. 23), skips group number column and moves to track number column automatically.

²: When programming tracks of MP3 disc

Press number buttons (1-10, +10) to specify selections by disc, group and track.

- At each program order use number buttons to specify source disc number first, specify group number, then specify track number on source disc.

Example: To specify "track 14" in "group 2" of "disc 3"

Press 3 ⇒ 2 ⇒ +10 ⇒ 4

Example for 4 ¹

No.	Disc	Group	Track
1	4	1	4
2	2		3
3	1		5
4	3	2	14
5	4	2	6
6			

Example for 4 ²

Selected title/track number

Selected group number

Selected disc number

5 Repeat step 4 to program following orders.

Each time you enter a title/track number in the order at the bottom of the program menu, the program menu scrolls and the following orders appear.

To erase an order

Press Cursor ▼/▲ to move to the order to be erased, then press CANCEL.

6 Press ► (play button) to start Program Playback.

When all of the programmed titles/tracks have been played back, playback stops and the program menu appears again.

Note that program setting remains.

When playing back an Audio CD:

The program menu remains on the TV screen during Program Playback.

To check the program contents

During playback, press ■. Playback stops and the program menu appears.

To bring up the menu without stopping playback, carry out steps 1 to 3.

- You can also check playback status in the on-screen bar by pressing ON SCREEN.

To stop Program Playback

Press ■. Note that program setting remains.

To clear the program

While stopped and the program menu is shown on the TV screen, press ■.

All of the programmed titles/tracks are erased. You can also clear the program by turning off the system.

To quit the Program mode

After clearing all programmed titles/tracks, press ► (play button). The program menu disappears.

NOTE

- During Program Playback, you cannot edit program contents.
- During Program Playback, pressing ► skips to the next program selection. Pressing ◀ returns playback to the beginning of the current selection.
- The Resume function cannot be used with Program Playback.
- To close the program menu: Press ON SCREEN. The program menu is closed and the on-screen bar is shown.
- To turn off the on-screen bar: Press ON SCREEN repeatedly.
- Program Playback function cannot be used during Video CD/SVCD playback with PBC function.
- If you want to repeat the programmed titles/tracks, set the Repeat mode during Program Playback. (pg. 46)
- Program Playback may not work for some discs.

Random Playback

You can play titles or tracks on a disc in random order.

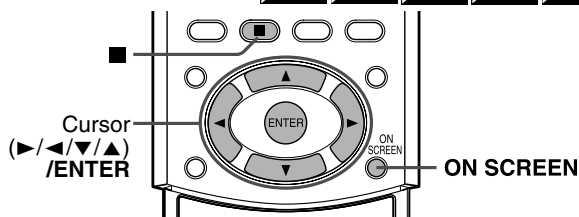

While stopped

1 Press ON SCREEN twice.

The on-screen bar appears on the TV screen.

2 Press Cursor >/< to move to RND..

Example: For Audio CD

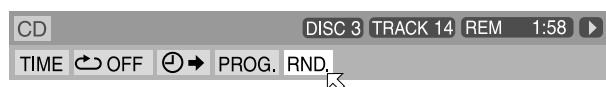

3 Press ENTER.

The system starts Random Playback. After playing all titles/tracks on the disc, the system stops playback and quits the Random mode. When more than one discs are loaded, the system starts Random Playback of the next disc after completing current disc playback.

To stop and quit Random Playback

Press ■. You can also clear the Random mode by turning off the system.

NOTE

- The same title/track will not be played back more than once during Random Playback.
- To return to normal playback without stopping playback, carry out steps 1 to 3 above.

Repeat Playback

You can repeat playback of the currently selected title or chapter (for DVD), track (for Video CD/SVCD/Audio CD), current group (for MP3/JPEG) or track (for MP3).

You can also repeat playback of a desired part.

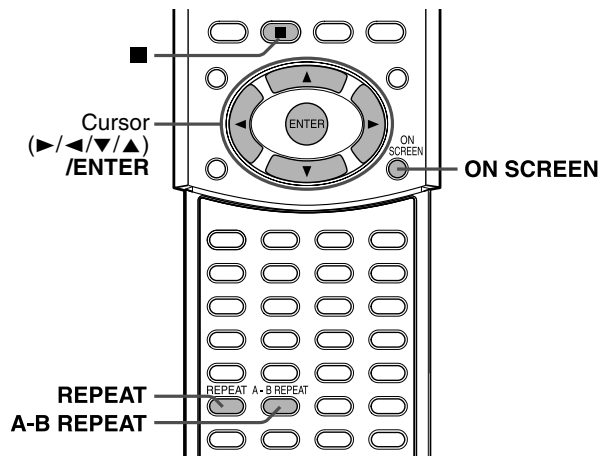

Repeating the current selection or all discs

- For DVD/Audio CD/MP3/JPEG: During playback
- For Video CD/SVCD: During playback without PBC function



When using the REPEAT button:

1 Press REPEAT.

Each time you press REPEAT, the Repeat mode changes cyclically.

- Repeat mode indicators appear on the display window and a repeat mode indication appears on the TV screen.



Repeat mode indicator

Followings are the description of indicators on the display window and indications on the TV screen.

Indicators	Indications	Meanings
↺	REPEAT GROUP*	Repeats the current group for MP3/JPEG disc.
	↺TITLE	Repeats the current title for DVD.
	↺DISC	Repeats all tracks on the current disc for Video CD/SVCD/Audio CD/MP3/JPEG.
	REPEAT DISC*	Repeats all the available discs.
	↺ALL	
↺	REPEAT ALL*	
↺ 1	↺TRACK	Repeats the current track for Video CD/SVCD/Audio CD/MP3 disc.
	REPEAT TRACK	
	↺CHAP	Repeats the current chapter for DVD.
No indication	↺OFF	Repeat mode is off. The system plays back all available discs normally.

* During playback of a JPEG disc, "REPEAT GROUP", "REPEAT DISC" and "REPEAT ALL" do not appear on the TV screen.

To stop Repeat Playback

- Press ■.
- When a disc except DVD is selected, the system stops playback but does not quit the Repeat mode.
 - When a DVD is set, the system stops playback and quits the Repeat mode.

To quit the Repeat mode

- Press REPEAT until the Repeat mode indicator goes off from the display window.
- You can also clear the Repeat mode by changing the current disc except when in repeat all mode (ALL).



NOTE

- If you press REPEAT while stopped, you need to press ► (play button) to start Repeat Playback.
- When the Program mode is active with a Video CD, SVCD, Audio CD, the Repeat mode changes in the same manner. Note that, however, in the "↺" mode the system repeats all the programmed tracks, instead of all tracks on the disc.
- During playback in the Repeat mode of the title/chapter/group/track, if you skip the title/chapter/group/track using ►►/◄◄, etc., the destination title/chapter/group/track is repeated.
- If Ⓞ appears when pressing REPEAT during DVD playback, you cannot repeat the title or chapter because of disc contents.

Continued on next page

Advanced operations

When using the on-screen bar (except for JPEG disc):

- 1 Press ON SCREEN twice.**
The on-screen bar appears on the TV screen.
- 2 Press Cursor ►/◄ to move**  **to**  .
- 3 Press ENTER.**

The following pop-up window appears under the selected item.

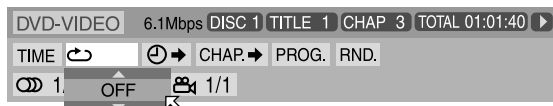

- 4 Press Cursor ▼/▲ repeatedly to select the Repeat mode.**

- You can select the Repeat modes as follows:

For DVD

◁ CHAPTER ▷ TITLE ▷ ALL ▷ A-B ▷ OFF ▷
(back to the beginning)

For Video CD/SVCD/Audio CD

◁ TRACK ▷ DISC ▷ ALL ▷ A-B ▷ OFF ▷ (back to the beginning)

For MP3 disc

◁ TRACK ▷ GROUP ▷ DISC ▷ ALL ▷ OFF ▷
(back to the beginning)

- 5 Press ENTER.**

To turn off the on-screen bar

Press ON SCREEN.

To cancel Repeat Playback

Repeat from step 1, select “OFF” in step 4, then press ENTER.

Repeating a desired part

You can repeat playback of a desired part by specifying the beginning (point A) and ending (point B).





- During playback

When using the A-B REPEAT button:

- 1 Press A-B REPEAT at the beginning of the part you want to repeat (point A).**

The repeat mode indicator “ A ” appears on the display window.

- 2 Press A-B REPEAT again at the end of the part you want to repeat (point B).**



The repeat mode indicator on the display window changes to “ A  B” and A-B Repeat Playback starts. The selected part of the disc (between point A and B) is played repeatedly.



To cancel A-B Repeat Playback

Press A-B REPEAT during A-B Repeat Playback.

When using the on-screen bar:

- 1 Press ON SCREEN twice.**
The on-screen bar appears on the TV screen.
- 2 Press Cursor ►/◄ to move**  **to**  .
- 3 Press ENTER.**

The following pop-up window appears under the selected item.

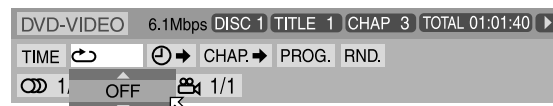

- 4 Press Cursor ▼/▲ repeatedly to select “A-B”.**

- 5 Press ENTER at the beginning of the part you want to repeat (point A).**

The following display appears in the on-screen bar.



- 6 Press ENTER at the end of the part you want to repeat (point B).**

A-B Repeat Playback starts. The selected part of the disc (between point A and B) is played repeatedly.

To turn off the on-screen bar

Press ON SCREEN.

To cancel A-B Repeat Playback

Repeat from step 1, select “OFF” in step 4, then press ENTER.

NOTE

- When playing back a DVD, A-B Repeat Playback is possible only within the same title.
- “A-B” cannot be selected during Program and Random Playback.
- “A-B” cannot be selected while stopped.

Setting DVD preferences

You can adjust the initial settings for DVD playback according to your preference or needs using 5 choice menus shown on the TV screen.

- Adjustments are possible only when selecting DVD as the source.

Using the choice menus

- Turn on your TV and select the correct input mode on the TV.
- You can only use the remote control for choice menu operations.
- You can change the language used in the choice menus. (pg. 50)
- You cannot show the choice menus when an MP3 disc or a JPEG disc is accessed.

Choice menus

A: Language menu (LANGUAGE) (pg. 50)

You can select the initial languages for the disc menu, audio and subtitles.

You can also select the language used on the TV screen while operating this system.

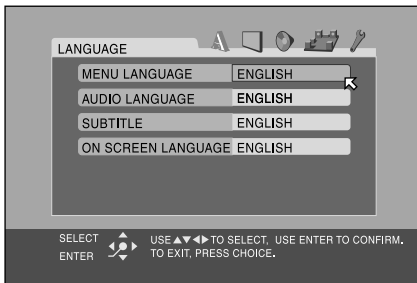

P: Picture menu (PICTURE) (pg. 51)

You can select the desired options concerning a picture or monitor screen.

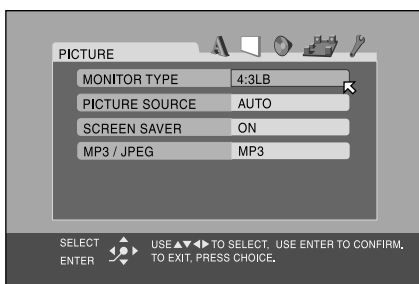

A: Audio menu (AUDIO) (pg. 51)

You can adjust sound settings.

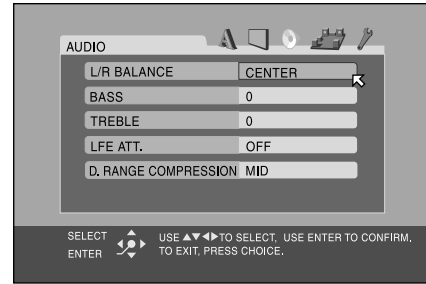

S: Speaker setting menu (SPK. SETTING) (pg. 51)

You can make speaker settings according to the size and layout of your speakers.

You can also adjust the output level of the subwoofer, center speaker and surround speakers.

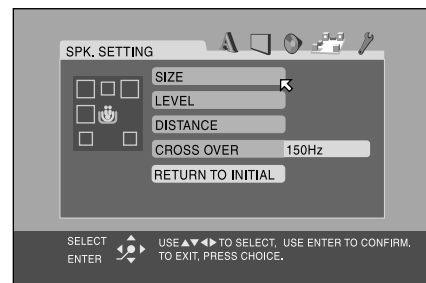

W: Other setting menu (OTHERS) (pg. 53)

You can change settings for some of the functions. Also use this menu to set Parental Lock.

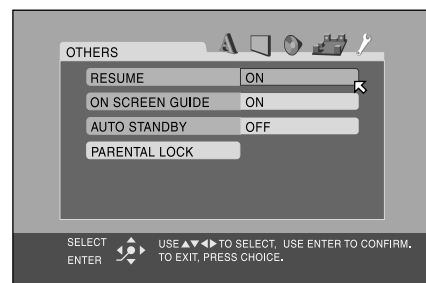

Setting DVD preferences

Basic operation on the choice menus

IMPORTANT

Before using the remote control for the following operation;

- 1 Set the remote control mode selector to AUDIO.
- 2 Press DVD.

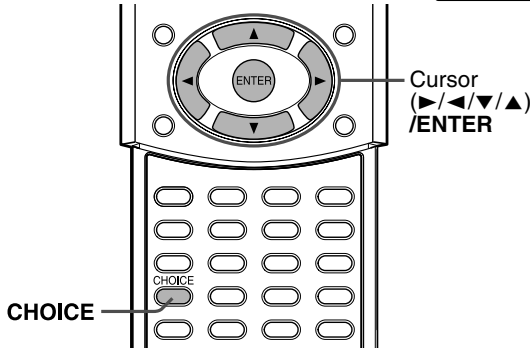
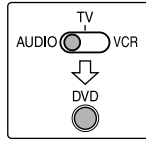

1 Press CHOICE.

The language menu (LANGUAGE) appears on the TV screen.

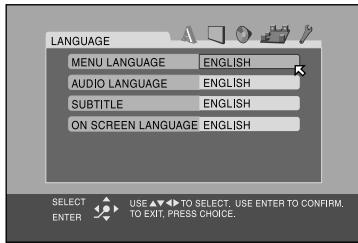

2 Press Cursor ▶/◀ repeatedly to display one of the choice menus.

Each time you press the button, the choice menus change as follows;

LANGUAGE ⇄ PICTURE ⇄ AUDIO ⇄ SPK. SETTING ⇄ OTHERS ⇄ (back to the beginning)

Example: When the picture menu (PICTURE) is selected.

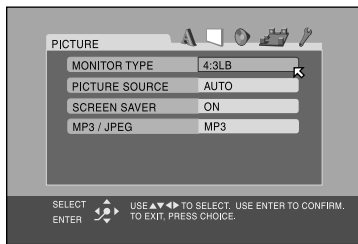

3 Press Cursor ▼/▲ repeatedly to move to the item you want to set up.

Example: When "PICTURE SOURCE" is selected.

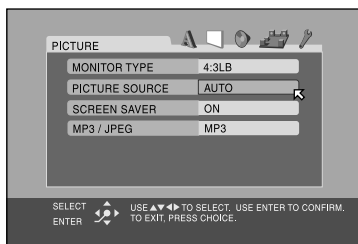

4 Press ENTER.

The pop-up window, listing the selectable options, appears on the choice menu.

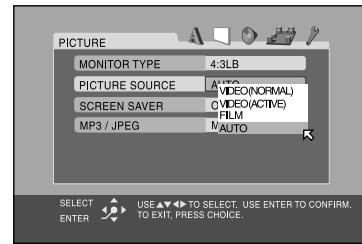

5 Press Cursor ▼/▲ repeatedly to select the desired option.

Example: When "FILM" is selected.

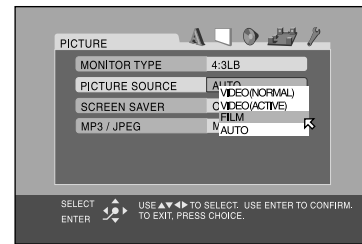

6 Press ENTER.

Your choice is stored.

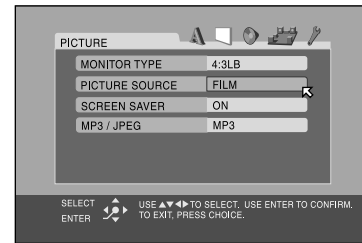

To set other items on the same choice menu

Repeat steps 3 to 6.

To move to another choice menu

Press Cursor ▶/◀ repeatedly to select a choice menu you want to set up.

To return to the normal screen

Press CHOICE.

NOTE

- Some items in the choice menus consist of sub-menus to set up. Selecting these items and pressing ENTER makes its related sub-menu appear on the TV screen. You can set submenus using Cursor ▶/◀/▼/▲ and ENTER (as explained in this basic operation).

Menu description

A: Language menu (LANGUAGE)

NOTE

- You can select "MENU LANGUAGE", "AUDIO LANGUAGE" and "SUBTITLE" only while playback is stopped.

■ MENU LANGUAGE

Some DVDs have their own menus in multiple languages.

- Select the initial language*.

ENGLISH, SPANISH, FRENCH, CHINESE, GERMAN, ITALIAN, JAPANESE and language codes from AA to ZU (see below)

■ AUDIO LANGUAGE

Some DVDs have multiple audio languages.

- Select the initial audio language*.

ENGLISH, SPANISH, FRENCH, CHINESE, GERMAN, ITALIAN, JAPANESE and language codes from AA to ZU (see below)

■ SUBTITLE

Some DVDs have multiple subtitle languages.

- Select the initial subtitle language*.

OFF (no indication of subtitles), ENGLISH, SPANISH, FRENCH, CHINESE, GERMAN, ITALIAN, JAPANESE and language codes from AA to ZU (see below)

■ ON SCREEN LANGUAGE

- Select the language shown on the TV screen when operating this system.

ENGLISH, GERMAN and FRENCH

- * When the language you have selected is not recorded to a disc, the original language is automatically used as the initial language.

The language codes list

AA	Afar	GL	Galician
AB	Abkhazian	GN	Guarani
AF	Afrikaans	GU	Gujarati
AM	Ameharic	HA	Hausa
AR	Arabic	HI	Hindi
AS	Assamese	HR	Croatian
AY	Aymara	HU	Hungarian
AZ	Azerbaijani	HY	Armenian
BA	Bashkir	IA	Interlingua
BE	Byelorussian	IE	Interlingue
BG	Bulgarian	IK	Inupiak
BH	Bihari	IN	Indonesian
BI	Bislama	IS	Icelandic
BN	Bengali, Bangla	IW	Hebrew
BO	Tibetan	JI	Yiddish
BR	Breton	JW	Javanese
CA	Catalan	KA	Georgian
CO	Corsican	KK	Kazakh
CS	Czech	KL	Greenlandic
CY	Welsh	KM	Cambodian
DA	Danish	KN	Kannada
DZ	Bhutani	KO	Korean (KOR)
EL	Greek	KS	Kashmiri
EO	Esperanto	KU	Kurdish
ET	Estonian	KY	Kirghiz
EU	Basque	LA	Latin
FA	Persian	LN	Lingala
FI	Finnish	LO	Laothian
FJ	Fiji	LT	Lithuanian
FO	Faroese	LV	Latvian, Lettish
FY	Frisian	MG	Malagasy
GA	Irish	MI	Maori
GD	Scots Gaelic	MK	Macedonian

ML	Malayalam	SO	Somali
MN	Mongolian	SQ	Albanian
MO	Moldavian	SR	Serbian
MR	Marathi	SS	Siswati
MS	Malay (MAY)	ST	Sesotho
MT	Maltese	SU	Sundanese
MY	Burmese	SV	Swedish
NA	Nauru	SW	Swahili
NE	Nepali	TA	Tamil
NL	Dutch	TE	Telugu
NO	Norwegian	TG	Tajik
OC	Occitan	TH	Thai
OM	(Afan) Oromo	TI	Tigrinya
OR	Oriya	TK	Turkmen
PA	Panjabi	TL	Tagalog
PL	Polish	TN	Setswana
PS	Pashto, Pushto	TO	Tonga
PT	Portuguese	TR	Turkish
QU	Quechua	TS	Tsonga
RM	Rhaeto-Romance	TT	Tatar
RN	Kirundi	TW	Twi
RO	Rumanian	UK	Ukrainian
RU	Russian	UR	Urdu
RW	Kinyarwanda	UZ	Uzbek
SA	Sanskrit	VI	Vietnamese
SD	Sindhi	VO	Volapuk
SG	Sangho	WO	Wolof
SH	Serbo-Croatian	XH	Xhosa
SI	Singhalese	YO	Yoruba
SK	Slovak	ZU	Zulu
SL	Slovenian		
SM	Samoan		
SN	Shona		

Picture menu (PICTURE)

■ MONITOR TYPE

You can select the monitor type to match your TV when you play DVDs recorded in the picture's height/width ratio of 16:9.

- **16:9 NORMAL (Wide television conversion)**
Select this when the aspect ratio of your TV is fixed to 16:9 (wide TV).
The system automatically adjusts the screen width of the output signal correctly when playing back a picture whose aspect ratio is 4:3.
- **16:9 AUTO (Wide television conversion)**
Select this when the aspect ratio of your TV is 16:9 (wide TV).
- **4:3 LB (Letter Box conversion)**
Select this when the aspect ratio of your TV is 4:3 (conventional TV). While viewing a wide screen picture, the black bars appear on the top and the bottom of the screen.
- **4:3 PS (Pan Scan conversion)**
Select this when the aspect ratio of your TV is 4:3 (conventional TV). While viewing a wide screen picture, the black bars do not appear, however, the left and right edges of the pictures will not be shown on the screen.

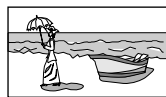

Ex.: 16:9

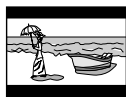

Ex.: 4:3 LB



Ex.: 4:3 PS

NOTE

- Even if "4:3 PS" is selected, the screen size may become "4:3 LB" with some DVDs. This depends on how DVDs are recorded.
- When you select "16:9 NORMAL" for a picture whose aspect ratio is 4:3, the picture slightly changes due to the process for converting the picture width.

■ PICTURE SOURCE

You can obtain optimal picture quality by selecting whether the content on the disc is processed by field (video source) or by frame (film source).

Normally set to "AUTO".

- **VIDEO (NORMAL)**
Suitable for playing back a video source disc with relatively a few movements.
- **VIDEO (ACTIVE)**
Suitable for playing back a video source disc with relatively a lot of movements.
- **FILM**
Suitable for playing back a film source disc.
- **AUTO**
Used to play a disc containing both video and film source materials.
This system recognizes the source type (video or film) of the current disc according to the disc information.
 - If the playback picture is unclear or noisy, or the oblique lines of the picture are rough, try to change to other modes.

■ SCREEN SAVER

You can activate or deactivate the screen saver function. (☞ pg. 22)

- **ON**
The picture on the TV screen becomes dark.
- **OFF**
Select this to deactivate the function.

■ MP3/JPEG

If both MP3 files and JPEG files are recorded on a disc, you can select which files to play.

- **MP3**
Select this to play MP3 files.
- **JPEG**
Select this to play JPEG files.

Audio menu (AUDIO)

■ L/R BALANCE

You can adjust the balance between the front left and front right speakers.

L-21 to L-1 ⇄ CENTER ⇄ R-1 to R-21 (by 1 step)

- **CENTER**
The levels of the front left and right speakers are identical.
- **L-21 to L-1 and R-1 to R-21**
As the number increases, the level from one speaker lowered than that of the other speaker. (When you select "-21", no sound comes out from the selected (L or R) speaker.)

■ BASS

You can adjust the enhancement level for bass sound from the front speakers.

Within the range from -10 to +10. (by 2 step)

■ TREBLE

You can adjust the enhancement level for treble sound from the front speakers.

Within the range from -10 to +10. (by 2 step)

NOTE

- You can adjust bass/treble enhancement level only for front left/right channel. However, the supplied speakers cannot add the effective change to the bass sound because of their cutoff frequency even if the bass sound adjustment is made. (☞ pg. 52)
To change the bass enhancement level more efficiently, adjust the output level of the subwoofer. (☞ pg. 20)
(When you change the front speakers to the larger ones and select "LARGE" for the front speakers in the SIZE sub-menu (☞ pg. 52), the effective adjustment of bass sound is also possible.)

■ LFE ATT.

The Low Frequency Effect attenuator diminishes distortion of the bass sound from the subwoofer when playing back a disc with Dolby Digital or DTS Digital Surround.

- **ON**
Select this to diminish distortion of the bass sound from the subwoofer.
- **OFF**
Select this to deactivate the function.

■ D. RANGE COMPRESSION

(Dynamic range compression)

You can enjoy low level recorded sound clearly at night even at a low volume when listening to the sound with Dolby Digital.

- **MAX**
Select this when you want to fully apply the compression effect (useful at midnight).
- **MID**
Select this when you want to reduce the dynamic range a little.
- **OFF**
Select this when you want to enjoy surround sound with its full dynamic range (no effect applied).

Speaker setting menu (SPK. SETTING)

■ SIZE

Accesses the SIZE sub-menu (speaker size setting menu). (See following.)

■ LEVEL

Accesses the LEVEL sub-menu (speaker level setting menu). (See following.)

■ DISTANCE

Accesses the DISTANCE sub-menu (speaker distance setting menu). (See following.)

Setting DVD preferences

■ CROSS OVER*

Small speakers cannot reproduce bass sounds efficiently. If you use a small speaker in any position, this system automatically reallocates the bass sound elements assigned to the small speaker to one of the large speakers.

To use this function properly, set crossover frequency level according to the size of the smallest speaker connected.

- **200 Hz**
Select this when the cone speaker unit in the smallest speaker connected is about 4 cm in diameter.
- **150 Hz (Select this when using the supplied speakers.)**
Select this when the cone speaker unit in the smallest speaker connected is about 6 cm in diameter.
- **120 Hz**
Select this when the cone speaker unit in the smallest speaker connected is about 8 cm in diameter.
- **100 Hz**
Select this when the cone speaker unit in the smallest speaker connected is about 10 cm in diameter.
- **80 Hz**
Select this when the cone speaker unit in the smallest speaker connected is about 12 cm in diameter.

* If you have selected "LARGE" for all speakers in the SIZE menu, this function will not take effect.

■ RETURN TO INITIAL

Resets all speaker settings to the initial settings.

■ Size menu (SIZE)

CAUTION

- When using the supplied speakers, select "SMALL" for each. Selecting "LARGE" may damage the speakers.

NOTE

- When "SMALL" is selected for the front speakers, you cannot select "LARGE" for the center speaker and surround speakers.

FRONT SPEAKER/CENTER SPEAKER/SURROUND SPEAKER

Select the speaker size according to the actual size of your speakers.

- **LARGE**
Select this when the cone speaker unit in the speaker is larger than 12 cm in diameter.
- **SMALL (Select this when using the supplied speakers.)**
Select this when the cone speaker unit in the speaker is smaller than 12 cm in diameter.

SUB WOOFER

USE

This item is fixed to "USE".

RETURN

Returns to the SPK. SETTING menu.

■ Level menu (LEVEL)

CENTER SPEAKER*/SURROUND LEFT SPEAKER*/SURROUND RIGHT SPEAKER*/SUB WOOFER

Adjust the output level of related speakers.

Within the range from -10 dB to +10 dB.

TEST TONE**

Outputs the test tone.

RETURN

Returns to the SPK. SETTING menu.

- * You cannot select "CENTER SPEAKER" when one of the DAP modes (☞ pg. 31) is selected as the surround mode. (☞ pg. 33)
- * You cannot select "CENTER SPEAKER", "SURROUND LEFT SPEAKER" and "SURROUND RIGHT SPEAKER" when the surround mode is off (stereo). (☞ pg. 33)

** The test tone comes out of all of the activated speakers in the following sequence:

⇒ Front left speaker ⇒ Center speaker ⇒ Front right speaker ⇒ Surround right speaker ⇒ Surround left speaker ⇒ (back to the beginning)

■ Distance menu (DISTANCE)

Example:

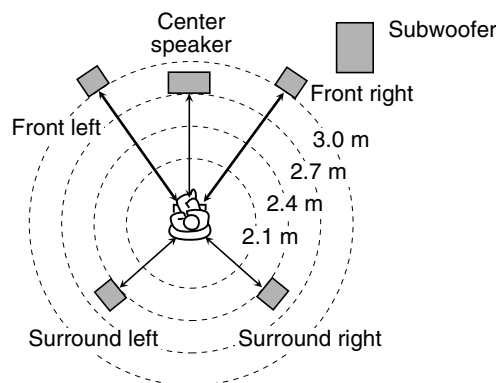

In this case, set the distance of each speaker as follows;

- Distance of front speakers: 3.0 m
- Distance of center speaker: 2.7 m
- Distance of surround speakers: 2.4 m

FRONT SPEAKER/CENTER SPEAKER/SURROUND SPEAKER

Adjust the distance from the listening position to the speakers.

Within the range from 0.3 m to 9.0 m. (by 0.3 m)

TEST TONE*

Outputs the test tone.

RETURN

Returns to the SPK. SETTING menu.

* The test tone comes out of all of the activated speakers in the following sequence:

⇒ Front left speaker ⇒ Center speaker ⇒ Front right speaker ⇒ Surround right speaker ⇒ Surround left speaker ⇒ (back to the beginning)

Setting DVD preferences

Other setting menu (OTHERS)

NOTE

- You can select "PARENTAL LOCK" only while playback is stopped.

RESUME

You can activate or deactivate Resume Playback function.

- ON**
Select this to activate the function.
- OFF**
Select this to deactivate the function.

ON SCREEN GUIDE

You can activate or deactivate the on-screen guide icons.

( pg. 22)

- ON**
Select this to activate the function.
- OFF**
Select this to deactivate the function.

AUTO STANDBY*

When playback ends and does not restart for more than the time you specify, this system turns off by itself.

- 60**
This system turns off by itself if playback does not restart within 60 minutes.
- 30**
This system turns off by itself if playback does not restart within 30 minutes.
- OFF**
Select this to deactivate the function.

* When both the Auto Standby function and the Sleep Timer are activated, if the shut-off time set by the Sleep Timer comes earlier than the one set by the Auto Standby function, the Sleep Timer controls shut-off time.

PARENTAL LOCK

You can restrict playback of a DVD containing violent scenes that is not suitable for your other family members.

Accesses the PARENTAL LOCK sub-menu. (See following "Parental Lock".)

Parental Lock

Using this function, you can restrict playback of a DVD containing violent scenes or scenes not suitable for your other family members. Nobody can play such a disc unless this function is canceled.

- This setting takes effect only for DVDs containing the Parental Lock level information — Level 1 (most restrictive) to Level 8 (least restrictive).
- You can set the Parental Lock only when playback is stopped.

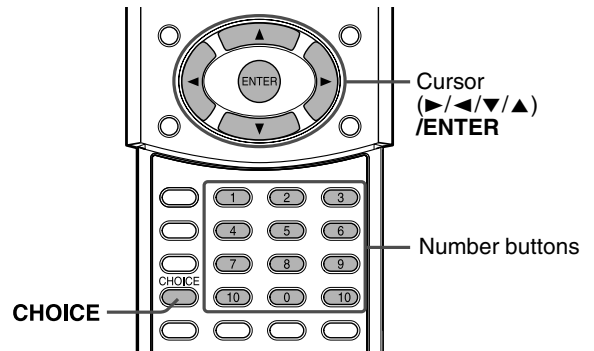

Setting Parental Lock

- Press CHOICE.
- Press Cursor ▶/◀ to display the OTHERS menu.
- Press Cursor ▼/▲ repeatedly to move  to "PARENTAL LOCK", then press ENTER.

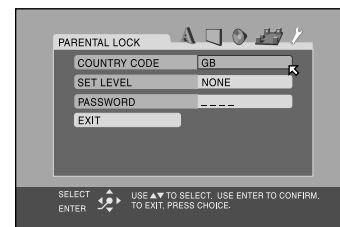

The PARENTAL LOCK sub-menu appears on the TV screen.

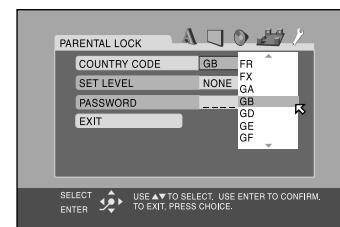

- Press Cursor ▼/▲ repeatedly to move  to "COUNTRY CODE", then press ENTER.



- Press Cursor ▼/▲ repeatedly to select the country code, then press ENTER.

See "Country/Area codes list for Parental Lock" ( pg. 55). The  moves to "SET LEVEL".

6 Press ENTER.

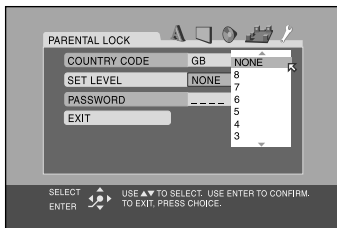

7 Press Cursor ▼/▲ repeatedly to select the level of restriction, then press ENTER.

The ⏏ moves to “PASSWORD”.

- Select “NONE” to cancel this function.

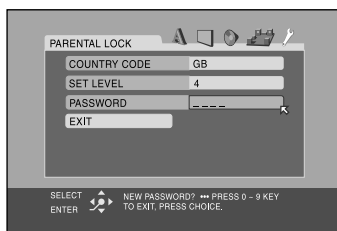

8 Press number buttons (0-9) to enter a four-digit number as your password, then press ENTER.

The ⏏ moves to “EXIT”.

9 Press ENTER.

The OTHERS menu resumes.

To return to the normal screen

Press CHOICE.

NOTE

- Remember your password, or make a note of it.

Changing the Parental Lock setting

1 Press CHOICE.

2 Press Cursor ►/◀ to display the OTHERS menu.

3 Press Cursor ▼/▲ repeatedly to move ⏏ to “PARENTAL LOCK”, then press ENTER.

The PARENTAL LOCK sub-menu appears on the TV screen.

- You can only move ⏏ to “PASSWORD” or to “EXIT” before you enter your password.

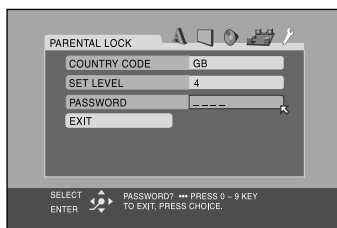

4 Press number buttons (0-9) to enter your password, then press ENTER.

- If you enter a wrong password, “WRONG! RETRY...” appears under the PARENTAL LOCK sub-menu. You cannot go to the next steps before you enter the correct password.

5 Press Cursor ▼/▲ repeatedly to move ⏏ to the item you want to change, then press ENTER.

6 Press Cursor ▼/▲ repeatedly to change the setting, then press ENTER.

7 Press number buttons (0-9) to enter your password, then press ENTER.

The new setting is stored.

NOTE

- You cannot set the Parental Lock before you set your password.
- If you go out of the PARENTAL LOCK sub-menu before setting your password in step 6, the new country code and parental lock level will not become effective. The old country code and parental level will remain in effect.
- When you enter wrong passwords more than three times, the ⏏ moves to “EXIT” automatically and Cursor ▼/▲ do not work. Press ENTER to exit from the PARENTAL LOCK sub-menu, then repeat from step 1.
- If you forget your password, enter “8888”.

Releasing Parental Lock temporarily

When you set a strict parental level, some discs may not be played back at all. When you load such a disc and try to play it, the following display appears on the TV screen. You can temporarily release the Parental Lock.

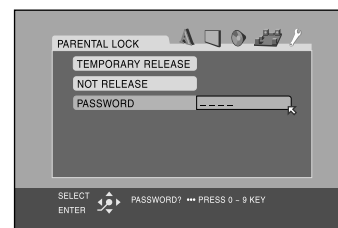

1 Press Cursor ▼/▲ repeatedly to move ⏏ to “TEMPORARY RELEASE”, then press ENTER.

The ⏏ moves to “PASSWORD”.

- When selecting “NOT RELEASE”, press one of ▲ buttons on the center unit to remove the disc.

2 Press number buttons (0-9) to enter your password.

Playback starts.

- If you enter a wrong password, “WRONG! RETRY...” appears under the PARENTAL LOCK sub-menu. You cannot play the disc before you enter the correct password.

NOTE

- When you enter wrong passwords more than three times, the ⏏ moves to “NOT RELEASE” automatically and Cursor ▼/▲ do not work. Press one of ▲ buttons on the center unit to remove the disc.

Country/Area codes list for Parental Lock

AD	Andorra	ER	Eritrea	LA	Lao People's Democratic Republic	RW	Rwanda
AE	United Arab Emirates	ES	Spain	LB	Lebanon	SA	Saudi Arabia
AF	Afghanistan	ET	Ethiopia	LC	Saint Lucia	SB	Solomon Islands
AG	Antigua and Barbuda	FI	Finland	LI	Liechtenstein	SC	Seychelles
AI	Anguilla	FJ	Fiji	LK	Sri Lanka	SD	Sudan
AL	Albania	FK	Falkland Islands (Malvinas)	LR	Liberia	SE	Sweden
AM	Armenia	FM	Micronesia (Fedelated States of)	LS	Lesotho	SG	Singapore
AN	Netherlands Antilles			LT	Lithuania	SH	Saint Helena
AO	Angola	FO	Faroe Islands	LU	Luxembourg	SI	Slovenia
AQ	Antarctica	FR	France	LV	Latvia	SJ	Svalbard and Jan Mayen
AR	Argentina	FX	France, Metropolitan	LY	Libyan Arab Jamahiriya	SK	Slovakia
AS	American Samoa	GA	Gabon	MA	Morocco	SL	Sierra Leone
AT	Austria	GB	United Kingdom	MC	Monaco	SM	San Marino
AU	Australia	GD	Grenada	MD	Moldova, Republic of	SN	Senegal
AW	Aruba	GE	Georgia	MG	Madagascar	SO	Somalia
AZ	Azerbaijan	GF	French Guiana	MH	Marshall Islands	SR	Suriname
BA	Bosnia and Herzegovina	GH	Ghana	ML	Mali	ST	Sao Tome and Principe
BB	Barbados	GI	Gibraltar	MM	Myanmar	SV	El Salvador
BD	Bangladesh	GL	Greenland	MN	Mongolia	SY	Syrian Arab Republic
BE	Belgium	GM	Gambia	MO	Macau	SZ	Swaziland
BF	Burkina Faso	GN	Guinea	MP	Northern Mariana Islands	TC	Turks and Caicos Islands
BG	Bulgaria	GP	Guadeloupe	MQ	Martinique	TD	Chad
BH	Bahrain	GQ	Equatorial Guinea	MR	Mauritania	TF	French Southern Territories
BI	Burundi	GR	Greece	MS	Montserrat	TG	Togo
BJ	Benin	GS	South Georgia and the South Sandwich Islands	MT	Malta	TH	Thailand Code Language
BM	Bermuda			MU	Mauritius	TJ	Tajikistan
BN	Brunei Darussalam	GT	Guatemala	MV	Maldives	TK	Tokelau
BO	Bolivia	GU	Guam	MW	Malawi	TM	Turkmenistan
BR	Brazil	GW	Guinea-Bissau	MX	Mexico	TN	Tunisia
BS	Bahamas	GY	Guyana	MY	Malaysia	TO	Tonga
BT	Bhutan	HK	Hong Kong	MZ	Mozambique	TP	East Timor
BV	Bouvet Island	HM	Heard Island and McDonald Islands	NA	Namibia	TR	Turkey
BW	Botswana			NC	New Caledonia	TT	Trinidad and Tobago
BY	Belarus	HN	Honduras	NE	Niger	TV	Tuvalu
BZ	Belize	HR	Croatia	NF	Norfolk Island	TW	Taiwan
CA	Canada	HT	Haiti	NG	Nigeria	TZ	Tanzania, United Republic of
CC	Cocos (Keeling) Islands	HU	Hungary	NI	Nicaragua	UA	Ukraine
CF	Central African Republic	ID	Indonesia	NL	Netherlands	UG	Uganda
CG	Congo	IE	Ireland	NO	Norway	UM	United States Minor Outlying Islands
CH	Switzerland	IL	Israel	NP	Nepal		
CI	Côte d'Ivoire	IN	India	NR	Nauru	US	United States
CK	Cook Islands	IO	British Indian Ocean Territory	NU	Niue	UY	Uruguay
CL	Chile	IQ	Iraq	NZ	New Zealand	UZ	Uzbekistan
CM	Cameroon	IR	Iran (Islamic Republic of)	OM	Oman	VA	Vatican City State (Holy See)
CN	China	IS	Iceland	PA	Panama	VC	Saint Vincent and the Grenadines
CO	Colombia	IT	Italy	PE	Peru		
CR	Costa Rica	JM	Jamaica	PF	French Polynesia	VE	Venezuela
CU	Cuba	JO	Jordan	PG	Papua New Guinea	VG	Virgin Islands (British)
CV	Cape Verde	JP	Japan	PH	Philippines	VI	Virgin Islands (U.S.)
CX	Christmas Island	KE	Kenya	PK	Pakistan	VN	Vietnam
CY	Cyprus	KG	Kyrgyzstan	PL	Poland	VU	Vanuatu
CZ	Czech Republic	KH	Cambodia	PM	Saint Pierre and Miquelon	WF	Wallis and Futuna Islands
DE	Germany	KI	Kiribati	PN	Pitcairn	WS	Samoa
DJ	Djibouti	KM	Comoros	PR	Puerto Rico	YE	Yemen
DK	Denmark	KN	Saint Kitts and Nevis	PT	Portugal	YT	Mayotte
DM	Dominica	KP	Korea, Democratic People's Republic of	PW	Palau	YU	Yugoslavia
DO	Dominican Republic			PY	Paraguay	ZA	South Africa
DZ	Algeria	KR	Korea, Republic of	QA	Qatar	ZM	Zambia
EC	Ecuador	KW	Kuwait	RE	Réunion	ZR	Zaire
EE	Estonia	KY	Cayman Islands	RO	Romania	ZW	Zimbabwe
EG	Egypt	KZ	Kazakhstan	RU	Russian Federation		
EH	Western Sahara						

System setting

You can adjust the sound and speaker settings of this system.

- The adjustments on a source take effect for the other sources.

IMPORTANT

Before using the remote control for the following operation;

- Set the remote control mode selector to AUDIO.

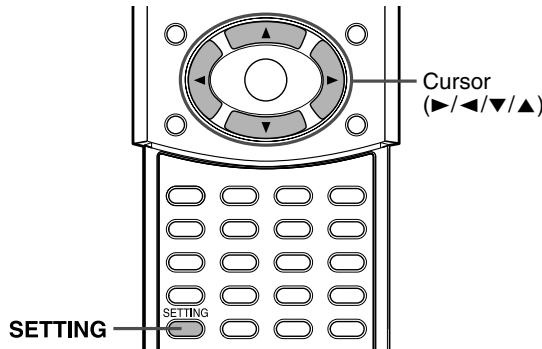
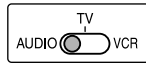

NOTE

Before you start operation;

- There is a time limit when doing the following steps. If the setting is cancelled before you finish, start from step 1 again.
- When selecting DVD as the source, the settings of the corresponding items in the choice menus also change.

On the remote control:

1 Press SETTING.

The item you last selected appears on the display window.

Example: "BAL" has been selected.



2 Press Cursor ▼/▲ repeatedly to select the item you want to set.

Each time you press the button, the items shown on the display window change as follows:

⇄ FRNT SP ⇄ CNTR SP ⇄ SURR SP ⇄ FRNT D ⇄ CNTR D ⇄ SURR D ⇄ CROSS ⇄ LFE ATT. ⇄ BAL ⇄ D. COMP ⇄ AUDIO POS ⇄ (back to the beginning)

See the corresponding pages for details on the related adjustments except for "AUDIO POS".

- FRNT SP (front speakers), CNTR SP (center speaker), SURR SP (surround speakers):
Select the size of each speaker. (pg. 52)
- FRNT D (front speakers distance), CNTR D (center speaker distance), SURR D (surround speakers distance):
Adjust distance from the listening position to the speakers. (pg. 52)
- CROSS:
Select the cutoff frequency of the subwoofer. (pg. 52)

- LFE ATT.:
Diminish the distortion of the bass sound from the subwoofer while playing back a disc with Dolby Digital or DTS Digital Surround. (pg. 51)
- BAL:
You can adjust the balance between the front left and front right speakers. (pg. 51)
- D. COMP (Dynamic Range Compression):
You can enjoy low level recorded sound clearly at night even at a low volume level when listening to the sound with Dolby Digital. (pg. 51)
- AUDIO POS (Audio Position):
Set the audio position of subwoofer so that the subwoofer level can be automatically adjusted properly. (The smaller the number becomes, the more the level decreases automatically when listening in stereo.)

3 Press Cursor ►/◄ to make an adjustment or selection.

Example:



- FRNT SP, CNTR SP, SURR SP:
"SML" (small) ⇄ "LRG" (large)
- FRNT D, CNTR D, SURR D:
Within the range between 0.3 m and 9.0 m. (by 0.3 m step)
- CROSS:
"80Hz" ⇄ "100Hz" ⇄ "120Hz" ⇄ "150Hz" ⇄ "200Hz" ⇄ (back to the beginning)
- LFE ATT.:
"ON" ⇄ "OFF"
- BAL:
"L-21" to "L-1" ⇄ "CENTER" ⇄ "R-1" to "R-21"
- D. COMP:
"MID" ⇄ "MAX" ⇄ "OFF" ⇄ (back to the beginning)
- AUDIO POS:
"0" ⇄ "-2" ⇄ "-4" ⇄ "-6" ⇄ (back to the beginning)

4 Repeat steps 2 and 3 to set other items.

NOTE

- If you selected "SML" for the front speakers, you cannot select "LRG" for the center and surround speakers.
- You can confirm your adjustment of speaker settings by listening to the test tone. To output the test tone, press TEST. (pg. 34)

References

Maintenance

To get the best performance out of this system, keep your discs and mechanism clean.

■ General Notes

In general, you will have the best performance by keeping your discs and the mechanism clean.

- Store discs in their cases and keep them in cabinets or on shelves.

■ Handling Discs

- Remove the disc from its case by holding it at the edge while pressing the center hole lightly.
- Do not touch the shiny surface of the disc or bend the disc.
- Put the disc back in its case after use to prevent warping.
- Be careful not to scratch the surface of the disc when placing it back in its case.
- Avoid exposure to direct sunlight, temperature extremes and moisture.

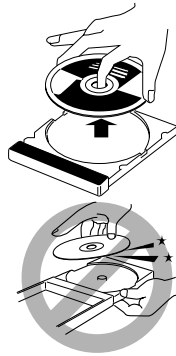

To clean the disc

Wipe the disc with a soft cloth in a straight line from center to edge.

- **DO NOT use any solvent — such as conventional record cleaner, spray, thinner or benzine — to clean the disc.**



■ Cleaning the system

- Stains on the system should be wiped off with a soft cloth. If the system is heavily stained, wipe it with a cloth soaked in water-diluted neutral detergent and wrung well, then wipe clean with a dry cloth.
- Since the system may deteriorate in quality, become damaged or get its paint peeled off, be careful about the following.
 - DO NOT wipe it with a hard cloth.
 - DO NOT wipe it strong.
 - DO NOT wipe it with thinner or benzine.
 - DO NOT apply any volatile substance such as insecticides to it.
 - DO NOT allow any rubber or plastic to remain in contact with it for a long time.

Trouble shooting

Use this chart to help you solve daily operational problems. If there is any problem you cannot solve, contact your JVC service center.

General

PROBLEM	POSSIBLE CAUSE	SOLUTION
Power does not come on.	The power cord is not connected to the center unit or an AC outlet.	Connect the power cord correctly. (☞ pg. 13)
Power is not supplied to the powered subwoofer.	The power cord of the subwoofer is not connected to an AC outlet.	Turn off the system, plug the power cord firmly into an AC outlet, and turn on the system again. (☞ pg. 13, 17)
	The system cord is not connected.	Connect the system cord. (☞ pg. 10)
The system does not work correctly.	Lightning or electronic noise interferes with operation of the microcomputer.	Switch the power off, then disconnect/reconnect the power plug.
	Immediately after beginning to heat the room, the system was moved to a cold location causing condensation to form inside.	Switch the power off and leave the system a few hours before switching the power on again.
The remote control does not work.	It is too far from the center unit, or is not facing the center unit.	Move closer to the center unit. (Operate the remote control within 7 m of the center unit.) (☞ pg. 14)
	There is something obstructing the remote sensor.	Remove any obstacles. (☞ pg. 14)
	The remote control is not aimed at the remote sensor on the center unit or components.	Aim the remote control at the remote sensor on the equipment you want to operate. (☞ pg. 14)
	The remote control mode selector is set at an incorrect position.	Set the selector to the correct position. (☞ pg. 17)
	The batteries are exhausted.	Replace the batteries. (☞ pg. 14)
	The batteries have been inserted the wrong way round (+/-).	Insert the batteries correctly. (☞ pg. 14)
	The remote control is not set to operate the DVD player or tuner (FM/AM – MW).	For the DVD player, press DVD before you perform the operations. (☞ pg. 21) For the tuner, press FM/AM before you perform the operations. (☞ pg. 25)
	Sunlight is falling directly on the remote sensor.	Hide the remote sensor from direct sunlight.
	The remote control signals are not set correctly.	Enter the correct manufacturer's code. (☞ pg. 15, 16)

References

PROBLEM	POSSIBLE CAUSE	SOLUTION
No sound.	The system cord and/or speaker cord is not connected.	Check the connection. (☞ pg. 10 – 11)
	There is a short in the speaker cord.	Reconnect the speaker cord.
	The audio cord is not connected to AUX IN and/or DIGITAL IN correctly.	Connect the cord correctly. (☞ pg. 12)
	An incorrect source has been selected.	Select the correct source. (☞ pg. 18)
	Muting is on.	Press MUTING to cancel muting. (☞ pg. 18)
	The decode mode is not set correctly.	Select the proper decode mode. (☞ pg. 20)
Sound from one front speaker only.	The speaker cord is not connected correctly.	Connect the speaker cord correctly. (☞ pg. 10)
	Left-right balance is not set properly.	Adjust the balance properly. (☞ pg. 51, 56)
No sound from the center and/or surround speakers.	The speaker setting is incorrect.	Set the speaker setting properly. (☞ pg. 51, 56)
Bass sound is heard reinforced when listening in stereo.	Appropriate bass level for stereo sound is not selected.	Set “AUDIO POS” properly. (☞ pg. 56)

DVD Playback

PROBLEM	POSSIBLE CAUSE	SOLUTION
No picture is displayed on the TV screen.	The video cord or SCART cable is not connected correctly.	Connect the cord correctly. (☞ pg. 8)
	The RGB-Y/C selector is not set correctly.	Set the selector properly for the video input format of the connected TV. (☞ pg. 8)
	TV input selection is incorrect.	Select the correct input on the TV.
	The disc is not playable.	Use a playable disc. (☞ pg. 3)
A disc cannot be played.	The center unit’s and disc’s Region Code numbers are incompatible.	Replace the disc. (☞ pg. 3)
	Parental Lock is in use.	Enter password to change the Parental Lock level. (☞ pg. 53)
A disc cannot be played and “0:00” is displayed on the display window.	The disc is loaded with its label and data sides inverted.	Load the disc correctly. (☞ pg. 21)
	The unplayable disc is loaded.	Replace the disc. (☞ pg. 3)
Video and audio are distorted.	The disc is scratched or dirty.	Replace or clean the disc. (☞ pg. 2)
	A VCR is connected between the center unit and the TV.	Connect the center unit and TV directly. (☞ pg. 8)
	With some discs, a picture may be blurred when setting “PICTURE SOURCE” to “FILM” or “AUTO”.	Set “PICTURE SOURCE” to “VIDEO (NORMAL)” or “VIDEO (ACTIVE)”. (☞ pg. 51)
The picture does not fit the TV screen.	The monitor type is not set correctly.	Set “MONITOR TYPE” properly. (☞ pg. 51)
	The TV is not set correctly.	Set the TV properly.
No subtitle appears on the TV screen though you have selected a certain language as your initial subtitle language.	—	Some DVDs are programmed to always display no subtitle initially. If this happens, press SUBTITLE on the remote control after starting play. (☞ pg. 41)
Audio language is different from the one you have selected as your initial audio language.	—	Some DVDs are programmed to always use the original language initially. If this happens, press AUDIO on the remote control after starting play. (☞ pg. 41)

References

MP3 Playback

PROBLEM	POSSIBLE CAUSE	SOLUTION
A disc cannot be played.	No MP3 files are recorded to the disc.	Replace the disc.
	MP3 files do not have the file extension in their file names.	Add correct file extension (.mp3, .Mp3, .mP3 or .MP3) to their file names. (☞ pg. 3)
	MP3 files are not recorded in a format compliant with ISO 9660 Level 1 or 2.	Replace the disc. (Record MP3 files using a compliant application.)
	The different types of files are recorded to the disc.	The disc which contains the different types of files may not be played because of its disc characteristics or recording conditions.
Not MP3 files but JPEG files are played.	The MP3/JPEG setting is set to “JPEG”.	When both MP3 files and JPEG files are recorded to a disc, set “MP3/JPEG” to “MP3” to play MP3 files. (☞ pg. 51)
The MP3 control display appears on the TV screen, but no operation can be performed.	No MP3 files or JPEG files are recorded to the disc, or the disc is an unplayable disc (such as CD-ROM).	Replace the disc. (☞ pg. 3)

JPEG Playback

PROBLEM	POSSIBLE CAUSE	SOLUTION
A disc cannot be played.	No JPEG files are recorded to the disc.	Replace the disc.
	JPEG files do not have the correct file extension in their file names.	Add correct file extension (.jpg, .jpeg, .JPG, .JPEG or any uppercase and lowercase combination such as “.Jpg”) to their file names. (☞ pg. 3)
	JPEG files are not recorded in a format compliant with ISO 9660 Level 1 or 2.	Replace the disc. (Record JPEG files using a compliant application.)
Not JPEG files but MP3 files are played.	The MP3/JPEG setting is set to “MP3”.	When both MP3 files and JPEG files are recorded to a disc, set “MP3/JPEG” to “JPEG” to play JPEG files. (☞ pg. 51)

FM/AM (MW)

PROBLEM	POSSIBLE CAUSE	SOLUTION
Hard to listen to broadcast because of noise.	Antennas are disconnected.	Reconnect the antennas correctly and securely.
	The AM (MW) loop antenna is too close to the center unit.	Change the position and direction of the AM (MW) loop antenna.
	The supplied FM antenna is not properly extended and positioned.	Extend the FM antenna to the best position.
	Beat Cut mode is not set properly while listening to an AM (MW) broadcast.	Try to change the Beat Cut mode. (☞ pg. 26)
Continuous static during FM broadcasts.	The received signal is too weak.	Connect an external FM antenna (☞ pg. 9), or contact your dealer.
	The station is too far away.	Select another station.

Others

PROBLEM	POSSIBLE CAUSE	SOLUTION
The system suddenly turns off by itself.	The Sleep Timer or Auto Standby function is activated.	Turn the functions off. (☞ pg. 19, 53)

NOTE

- Problems may be caused by components connected to the center unit, so also read all manuals for the connected components carefully.

Glossary

Aspect ratio

The ratio of vertical and horizontal sizes of a displayed image. The horizontal vs. vertical ratio of conventional TVs is 4:3, and that of wide-screens is 16:9.

Chapter

Refers to individual chapters included in a title.

Composite video signal

Refers to video signal comprised of three kinds of signals combined: an image signal made up of luminance and chrominance signals using the frequency multiplication technique; burst signal providing the basis for color reproduction; and synchronization signal.

Disc menu

A screen display prepared for allowing selection of images, sounds, subtitles, multiangles, etc. recorded on a DVD.

JPEG

A still-picture data compression system proposed by the Joint Photographic Expert Group, which features small decrease in image quality in spite of its high compression ratio.

Letter box

A method of displaying wide images like movies in the center of a 4:3 TV screen with no part of the image deleted, by placing black bands on the top and bottom of the screen. This name has resulted from the screen form looking literally like a letter box.

Linear PCM (PCM: Pulse Code Modulation)

A system for converting analog sound signal to digital signal for later processing, with no data compression used in conversion.

MP3

A file format with a sound data compression system. "MP3" is the abbreviation of Motion Picture Experts Group 1 (or MPEG-1) Audio Layer 3. By using MP3 format, one CD-R or CD-RW can contain about 10 times as much data volume as a regular CD can.

Multiangle

By recording multiple scenes progressing at the same time in a single title, the user can select view angles. This feature is called the multiangle function.

Multichannel

DVD is specified to have each sound track constitute one sound field. Multichannel refers to a structure of sound tracks having three or more channels.

Multilanguage

When a title is created to cope with multiple languages, it is generally called a multilanguage title.

Parental Lock

A feature of this system to automatically determine whether or not to reproduce particular DVD software by comparing its parental level (a measure of undesirability of scenes, etc. from educational viewpoint) set for the software beforehand with that set on this system by the user; if the software's level is less restrictive than the user-set level, it will be reproduced.

Playback control (PBC)

Refers to the signal recorded on video CDs or SVCDs for controlling reproduction. By using menu screens recorded on a Video CD or SVCD that supports PBC, you can enjoy interactive-type software as well as software having a search function.

Region Code

A system for allowing discs to be played back only in the regions designated beforehand. All the countries in the world are divided into six regions, each region being identified by a specified Region Code (or region number). If the Region Code given to a disc includes a numeral which matches one in the Region Code of a player, the player can play back the disc.

Sampling frequency

Frequency of sampling data when analog data is converted to digital data. Sampling frequency numerically represents how many times the original analog signal is sampled per second.

Surround

A system for creating three-dimensional sound fields full of realism by arranging multiple speakers around the listener.

Transfer rate

The rate of transferring digital data. Usually the measure is in baud per second. The DVD system applies a variable transfer rate system for high efficiency.

Index

- A**
- A-B Repeat Playback 47
 - All Channel Stereo (ALL CH ST.) 32 – 34
 - Angle 40
 - Audio CD 3, 4
 - Audio language (AUDIO LANGUAGE) 41, 50
 - Auto standby (AUTO STANDBY) 53
 - AUTO/PCM 20
- B**
- Bass (BASS) 20, 51
 - Beat cut mode (BEAT CUT) 26
- C**
- CD-R 3
 - CD-RW 3
 - Chapter 4
 - Choice menu 48 – 54
 - Audio menu (AUDIO) 51
 - Distance menu (DISTANCE) 52
 - Language menu (LANGUAGE) 50
 - Level menu (LEVEL) 52
 - Other setting menu (OTHERS) 53
 - Picture menu (PICTURE) 51
 - Size menu (SIZE) 52
 - Speaker setting menu (SPK. SETTING) 51
 - Composite video 8
 - Crossover (CROSS OVER) 52, 56
- D**
- DAP (Digital Acoustic Processor) mode 31 – 34
 - Dance club (DANCE CLUB) 31 – 34
 - Hall (HALL) 31 – 34
 - Live club (LIVE CLUB) 31 – 34
 - Pavilion (PAVILION) 31 – 34
 - Decode mode 20
 - Dimmer 19
 - Dolby Digital 31 – 33
 - Dolby Pro Logic II 31 – 33
 - Pro Logic II Movie (PL II MOVIE) 31 – 33
 - Pro Logic II Music (PL II MUSIC) 31 – 33
 - DSP mode 31 – 34
 - DTS Digital Surround 31 – 33
 - DVD Video (DVD) 3, 4
 - Dynamic range compression (D.RANGE COMPRESSION) 51, 56
- E**
- Enhanced Other Network (EON) 29
- F**
- Frame-by-frame playback 43
- G**
- Group 4
- J**
- JPEG 3, 4, 39
- L**
- Left/Right speaker balance (L/R BALANCE) 51, 56
 - Low frequency effect attenuater (LFE ATT.) 51, 56
- M**
- Menu language (MENU LANGUAGE) 50
 - Monitor type (MONITOR TYPE) 51
 - 16:9 AUTO 51
 - 16:9 NORMAL 51
 - 4:3 LB 51
 - 4:3 PS 51
 - MP3 3, 4, 38
 - Muting 18
- O**
- On-screen bar 35
 - On-screen guide icons (ON SCREEN GUIDE) 22, 53
 - On-screen language (ON SCREEN LANGUAGE) 50
- P**
- Parental Lock (PARENTAL LOCK) 53
 - Picture source (PICTURE SOURCE) 51
 - Playback Control function (PBC) 4, 37
 - Program Playback (PROGRAM) 45
 - Program Service (PS) 27 – 30
 - Program Type (PTY) 27 – 30
- R**
- Radio Data System (RDS) 27 – 30
 - Radio Text (RT) 27 – 30
 - Random Playback 46
 - Region Code 3, 17
 - Repeat Playback 46
 - Resume Playback (RESUME) 22, 53
- S**
- Screen saver (SCREEN SAVER) 22, 51
 - Sleep Timer 19
 - Slow-motion 43
 - Subtitle language (SUBTITLE) 41, 50
 - Super Video CD (SVCD) 3, 4
 - Surround mode 31 – 34
 - S-video 8
- T**
- Test tone (TEST TONE) 34, 52
 - Title 4
 - Track 4
 - Tray lock 23
 - Treble (TREBLE) 20, 51
- V**
- Video CD (VCD) 3, 4
 - Video Fine Processor (VFP) 44
- Z**
- Zoom 43

Specifications

■ Center unit (XV-THM45)

Audio section

Total Harmonic Distortion 0.02 %

NOTE: This value is measured at System cord CONNECTOR for reference.

Audio input sensitivity/Impedance (at 1 kHz)

Analog input:

AUX IN: 290 mV/47 k Ω

Digital input*:

DIGITAL IN: -21 dBm to -15 dBm
(OPTICAL) (660 nm \pm 30 nm)

* Corresponding to Linear PCM, Dolby Digital, and DTS Digital Surround (with sampling frequency — 32 kHz, 44.1 kHz, 48 kHz)

Video section

Color System: PAL

Horizontal Resolution: 500 lines

Signal-to-Noise Ratio: 64 dB

(Composite signal when "RGB" is selected)

Video output level

Composite: 1.0 V(p-p)/75 Ω

S-video-Y: 1.0 V(p-p)/75 Ω

S-video-C: 0.286 V(p-p)/75 Ω

Tuner section

Tuning Range

FM: 87.50 MHz to 108.00 MHz

AM (MW): 522 kHz to 1 629 kHz

General

Power Requirements: AC 230 V \sim , 50 Hz

Power Consumption: 20 W (at operation)

1.6 W (in standby mode)

Dimensions (W \times H \times D): 400 mm \times 85 mm \times 386 mm

Mass: 4.6 kg

■ Subwoofer (SP-PWM45)

Amplifier section

Front/Center/Surround: 80 W per channel, RMS at 6 Ω at 1 kHz, with 10 % total harmonic distortion.

Subwoofer: 120 W, RMS at 4 Ω at 100 Hz, with 10 % total harmonic distortion.

Speaker section

Speaker unit: 16 cm Bass-reflex, Magnetically Shielded

Frequency Range: 30 Hz to 200 Hz

General

Power Requirements: AC 230 V \sim , 50 Hz

Power Consumption: 150 W (at operation)

0 W (in standby mode)

Dimensions (W \times H \times D): 216 mm \times 353 mm \times 485 mm

Mass: 12.0 kg

■ Satellite Speakers

Front speakers (SP-THM45F)

Speakers: 8.0 cm
Bass-reflex, Magnetically Shielded

Power Handling Capacity: 80 W

Impedance: 6 Ω

Frequency Range: 90 Hz to 20 kHz

Dimensions (W \times H \times D): 103 mm \times 115 mm \times 100 mm

Mass: 0.64 kg

Surround speakers (SP-THM45S)

Speakers: 8.0 cm
Bass-reflex, Magnetically Shielded

Power Handling Capacity: 80 W

Impedance: 6 Ω

Frequency Range: 90 Hz to 20 kHz

Dimensions (W \times H \times D): 103 mm \times 115 mm \times 100 mm

Mass: 0.52 kg

■ Center Speaker (SP-THM45C)

Speakers: 8.0 cm
Bass-reflex, Magnetically Shielded

Power Handling Capacity: 80 W

Impedance: 6 Ω

Frequency Range: 90 Hz to 20 kHz

Dimensions (W \times H \times D): 103 mm \times 115 mm \times 100 mm

Mass: 0.64 kg

■ Accessories

- Remote control (1)
- Batteries (2)
- FM antenna (1)
- AM (MW) loop antenna (1)
- Power cord (1)
- System cord (1)
- Speaker cords
 - 5 m: For satellite (front left/right) and center speakers (3)
 - 10 m: For satellite speakers (surround left/right) (2)
 (The length of the above speaker cords are approximate.)

Designs & specifications are subject to change without notice.



Free Manuals Download Website

<http://myh66.com>

<http://usermanuals.us>

<http://www.somanuals.com>

<http://www.4manuals.cc>

<http://www.manual-lib.com>

<http://www.404manual.com>

<http://www.luxmanual.com>

<http://aubethermostatmanual.com>

Golf course search by state

<http://golfingnear.com>

Email search by domain

<http://emailbydomain.com>

Auto manuals search

<http://auto.somanuals.com>

TV manuals search

<http://tv.somanuals.com>