

JVC



ENGLISH

ESPAÑOL

FRANÇAIS

CD/SD RECEIVER

KD-AR5500/KD-LHX550

RECEPTOR CON CD/SD

KD-AR5500/KD-LHX550

RECEPTEUR CD/SD

KD-AR5500/KD-LHX550

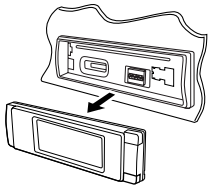

EXAD



**COMPACT
disc
DIGITAL AUDIO
TEXT**

**SIRIUS
READY**

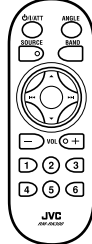

PICT

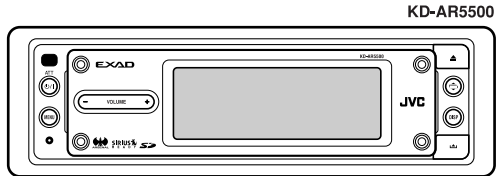

KD-AR5500

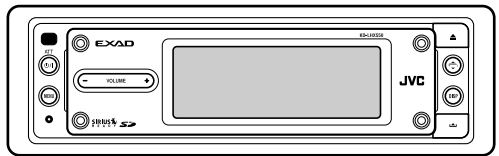

KD-LHX550

For canceling the display demonstration, see page 8.

Para cancelar la demostración en pantalla, consulte la página 8.

Pour annuler la démonstration des affichages, référez-vous à la page 8.

For installation and connections, refer to the separate manual.

Para la instalación y las conexiones, refiérase al manual separado.

Pour l'installation et les raccordements, se référer au manuel séparé.

For customer Use:

Enter below the Model No. and Serial No. which are located on the top or bottom of the cabinet. Retain this information for future reference.

Model No. _____

Serial No. _____

INSTRUCTIONS
MANUAL DE INSTRUCCIONES
MANUEL D'INSTRUCTIONS

GET0282-001A

[J]

Thank you for purchasing a JVC product.

Please read all instructions carefully before operation, to ensure your complete understanding and to obtain the best possible performance from the unit.

INFORMATION (For U.S.A.)

This equipment has been tested and found to comply with the limits for a Class B digital device, pursuant to Part 15 of the FCC Rules. These limits are designed to provide reasonable protection against harmful interference in a residential installation. This equipment generates, uses, and can radiate radio frequency energy and, if not installed and used in accordance with the instructions, may cause harmful interference to radio communications. However, there is no guarantee that interference will not occur in a particular installation. If this equipment does cause harmful interference to radio or television reception, which can be determined by turning the equipment off and on, the user is encouraged to try to correct the interference by one or more of the following measures:

- Reorient or relocate the receiving antenna.
- Increase the separation between the equipment and receiver.
- Connect the equipment into an outlet on a circuit different from that to which the receiver is connected.
- Consult the dealer or an experienced radio/TV technician for help.

IMPORTANT FOR LASER PRODUCTS

1. CLASS 1 LASER PRODUCT
2. **CAUTION:** Do not open the top cover. There are no user serviceable parts inside the unit; leave all servicing to qualified service personnel.
3. **CAUTION:** Visible and invisible laser radiation when open and interlock failed or defeated. Avoid direct exposure to beam.

Warning:

If you need to operate the receiver while driving, be sure to look ahead carefully or you may be involved in a traffic accident.

Cautions:

- Do not operate the touch panel using a ball-point pen or a similar tool with the sharp tip (it may damage the touch panel).
- If the temperature inside the car is below 0°C (32°F), the movement of animation and text scroll will be halted on the display to prevent the display from being blurred. **LowTEMP** appears on the display. When the temperature increases, and the operating temperature is resumed, these functions will start working again.

How to forcibly eject a disc

If a disc cannot be recognized by the receiver or cannot be ejected, ejects the disc as follows.

- If an SD card is inserted, ejects the SD card first (see page 14).

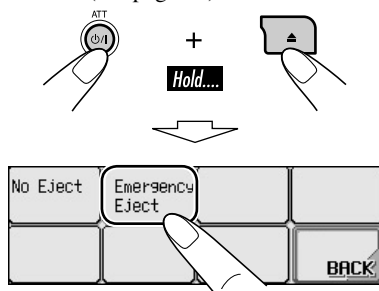

- If this does not work, reset your receiver.
- Be careful not to drop the disc when it ejects.

How to forcibly eject a disc	2	General settings — PSM.....	26
How to reset your unit	3	Basic procedure	26
How to read this manual	4	Selecting the dimmer mode	30
How to change the display pattern		Changing the display color	30
during playback.....	4	Other main functions	32
Control panel — KD-AR5500/KD-LHX550.....	5	Assigning titles to the sources	32
Parts identification	5	Changing the control panel angle	33
Remote controller — RM-RK300	6	Detaching the control panel	33
Main elements and features	6	External component operations	34
Getting started	7	SIRIUS® radio operations.....	35
Basic operations	7	Listening to the SIRIUS® radio	36
Canceling the display demonstrations ...	8	Storing channels in memory	37
Setting the clock	8	Listening to a user channel	37
Radio operations.....	9	Selecting a category/channel on	
Listening to the radio	9	the list.....	38
Storing stations in memory	10	Maintenance	40
Listening to a preset station	11	More about this receiver.....	41
Disc/SD card operations	12	Troubleshooting	45
Playing a disc in the receiver	12	Specifications	49
Playing discs in the CD changer	13		
Playing an SD card	14		
Other main functions	16		
Selecting the playback modes.....	19		
Sound adjustments	20		
Setting the basic sound selection			
menu—SEL	20		
Selecting preset sound modes			
(i-EQ: intelligent equalizer).....	21		
Storing your own sound modes	21		
Graphic displays.....	22		
Basic procedure.....	22		
Downloading the files.....	22		
Deleting the files.....	23		
Activating the downloaded files	25		

How to reset your unit

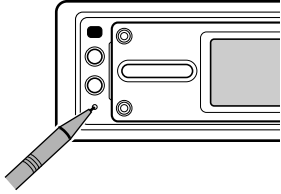

This will reset the microcomputer. Your preset adjustments will also be erased.

***For safety....**

- Do not raise the volume level too much, as this will block outside sounds, making driving dangerous.
- Stop the car before performing any complicated operations.

***Temperature inside the car....**

If you have parked the car for a long time in hot or cold weather, wait until the temperature in the car becomes normal before operating the unit.



How to read this manual

The following methods are used to make the explanations simple and easy-to-understand:

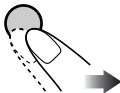
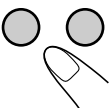
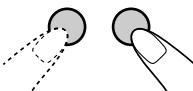
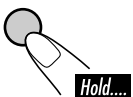
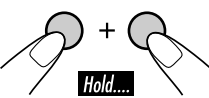
- Some related tips and notes are explained in “More about this receiver” (see pages 41 – 44).
- Button and touch panel operations are mainly explained with the illustrations as follows:

	Press briefly.
	Press repeatedly.
	Press either one.
	
	Press and hold until your desired response begins.
	Press and hold both buttons at the same time.

The following marks are used to indicate...

-  : Built-in CD player operations.
-  : External CD changer operations.
-  : SD card operations.

How to change the display pattern during playback

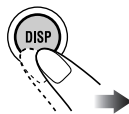

Source operation screen



Clock time is enlarged.

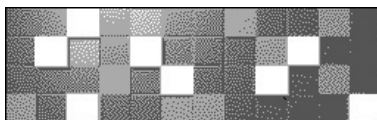

Audio Level Meters*
(see “Theme” on page 28)



Graphic screen* appears only after you have downloaded a file, see pages 22 – 25.



Goes back to the source operation screen.

- If the current source is “SIRIUS,” see page 39 for details.

* These screens will be temporarily canceled when you operate the receiver.

Parts identification

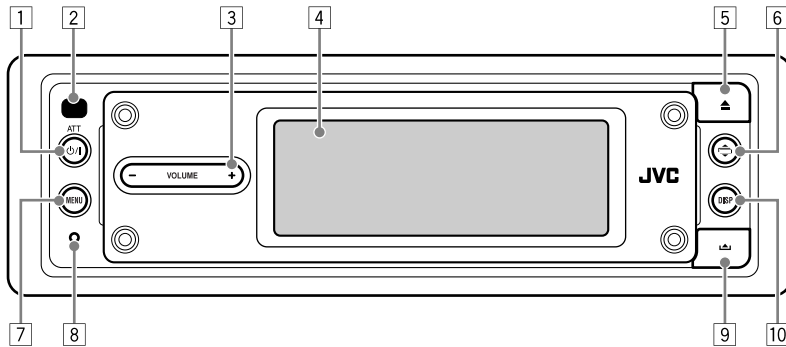

- | | |
|--|--|
| <ul style="list-style-type: none"> 1 ⏻/I ATT (standby/on attenuator) button 2 Remote sensor <ul style="list-style-type: none"> • <i>DO NOT</i> expose the remote sensor to strong light (direct sunlight or artificial lighting). 3 VOLUME + / - button 4 Touch panel | <ul style="list-style-type: none"> 5 ▲ (eject) button 6 ↻ (angle) button 7 MENU button 8 Reset button 9 ⏏ (control panel release) button 10 DISP (display) button |
|--|--|

Main touch panels

- Make sure to touch the area inside the key icon boundary when operating the touch panel.

Source Selection Screen



Either "CD-CH" or "EXT-IN" appears depending on the "Ext Input" setting (see page 29).

If the source is not ready, you cannot select the source. Key icon appears as negative pattern.

Main Menu



Not displayed when the source is "LINE-IN" or "EXT-IN" (external component).

Displayed only when playing an audio CD or when the source is "TUNER," "LINE-IN" or "EXT-IN."

- To return to the previous screen, press "BACK" (if shown). See also page 41.

Remote controller — RM-RK300

ENGLISH

Installing the lithium coin battery (CR2025)

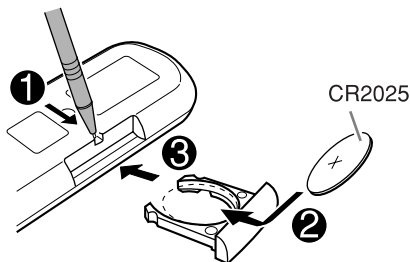

- When operating, aim the remote controller directly at the remote sensor on the receiver. Make sure there is no obstacle in between.

Warning:

- Store the battery in a place where children cannot reach to avoid risk of accident.
- To prevent the battery from over-heating, cracking, or starting a fire:
 - Do not recharge, short, disassemble, or heat the battery or dispose of it in a fire.
 - Do not leave the battery with other metallic materials.
 - Do not poke the battery with tweezers or similar tools.
 - Wrap the battery with tape and insulate when throwing away or saving it.

Caution:

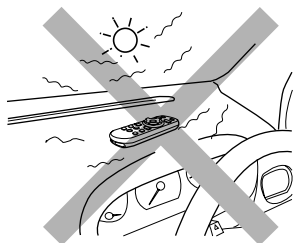

The receiver is equipped with the steering wheel remote control function.

- See the Installation/Connection Manual (separate volume) for connection.

Main elements and features

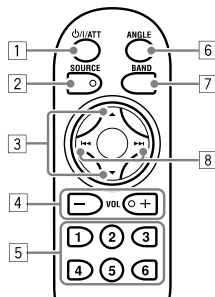

1. **⏻/ATT** (standby/on/attenuator) button
 - Turns on and off the power and also attenuates the sound.
2. **SOURCE** button
 - Selects the source.
3. **▲ (up) / ▼ (down)** buttons
 - Changes the preset stations.
 - Changes the categories for SIRIUS®.
 - Changes the MP3/WMA folders.
4. **VOL (volume) + / -** buttons
 - Adjusts the volume level.
5. **Number buttons**
 - Selects the preset station if pressed, or store a station if pressed and held.
 - Selects the preset channels while listening to SIRIUS radio, or store a channel if pressed and held.
 - Selects the tracks while playing an audio CDs or CD Texts.
 - Selects the folders while playing MP3/WMA discs or an SD card.
 - Selects the discs while operating the CD changer.
6. **ANGLE** button
 - Adjusts the control panel angle.
7. **BAND** button
 - Selects the band for FM/AM and SIRIUS.
8. **◀◀ / ▶▶** buttons
 - Searches for stations if pressed, or skips frequencies after pressed and held.
 - Changes the tracks of the disc or of the SD card if pressed.
 - Fast-forwards or reverses the track if pressed and held.
 - While listening to the SIRIUS radio:
 - Changes the channels if pressed briefly.
 - Changes the channels rapidly if pressed and held.

Getting started

Basic operations

ENGLISH

1

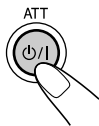

To drop the volume in a moment (ATT)



To restore the sound, press it again.

2

Select the source.

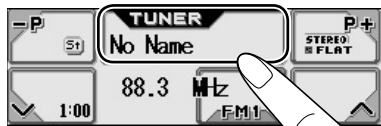

You can also select the source by....



To turn off the power



Caution on volume setting:

Discs produce very little noise compared with other sources. Lower the volume before playing a disc to avoid damaging the speakers by the sudden increase of the output level.

3

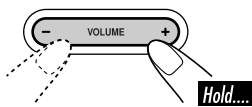

Voice support system (VSS)

You can select either "Beep" or "Voice" for the VSS.

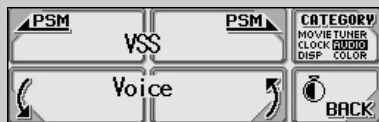

If "Voice" is selected, the language used for VSS changes to the selected language—English, Spanish, or French.

To change the VSS setting, see page 29.

4

Adjust the sound as you want.
(See pages 20 and 21.)

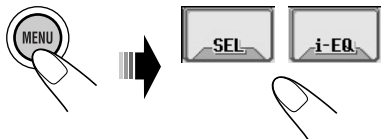

Canceling the display demonstrations

If no operations are done for about 20 seconds, display demonstration starts.

[Initial: All Time]—see page 26.

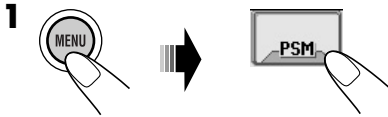

2 Select “Off.”

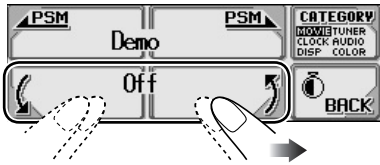

3 Exit from the setting.



To activate the display demonstration

In step 2 above, select “All Time” or “Interval.”
For more details, see page 26.

Setting the clock

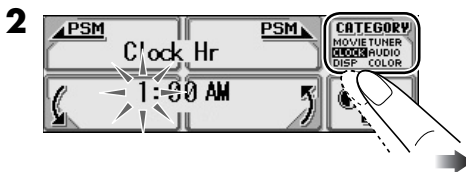
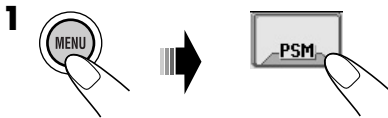

3 Adjust the hour.

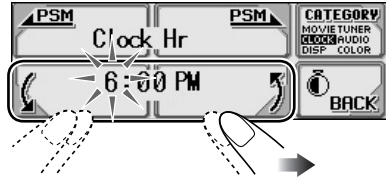

4 Select “Clock Min” (minute), then adjust the minute.

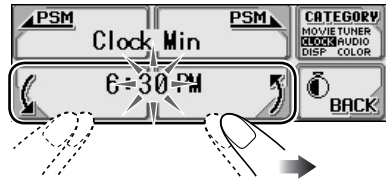
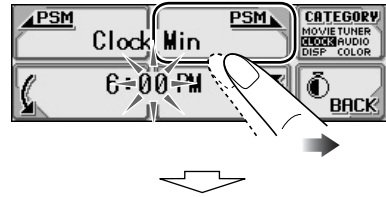

5 Select “24H/12H,” then select “24Hours” or “12Hours.”

6 Exit from the setting.



To check the current clock time when the power is turned off



Listening to the radio

- 1 Select "TUNER."

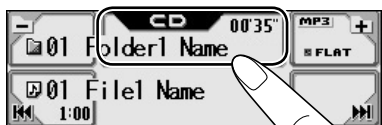

- 2 Select the band (FM/AM).

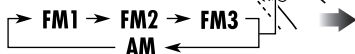

- 3 Start searching for a station.



When a station is received, searching stops.

To stop searching, press the same icon again.

To tune in to a station manually

In step 3 on the left...



- 2 Select the desired station frequencies.

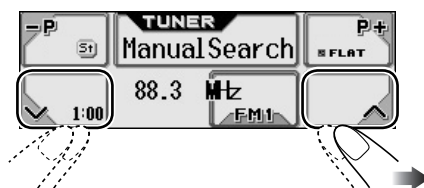

When an FM stereo broadcast is hard to receive



- 2 Select "MONO On."



Reception improves, but stereo effect will be lost.

- 3 Exit from the setting.



To restore the stereo effect, repeat the same procedure and select "MONO Off" in step 2.

Storing stations in memory

You can preset six stations for each band.

FM station automatic presetting—SSM (Strong-station Sequential Memory)

- 1 Select the FM band (FM1 – FM3) you want to store into.

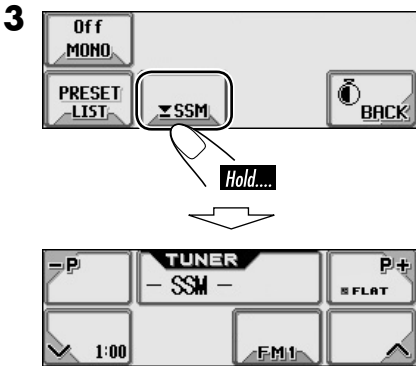
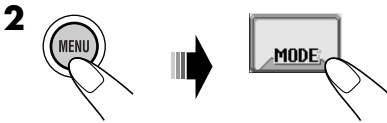
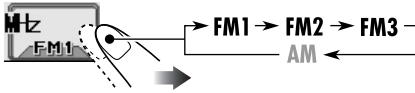

Local FM stations with the strongest signals are searched and stored automatically in the FM band.

Manual presetting

Ex.: Storing FM station of 92.5 MHz into preset number 4 of the FM1 band.

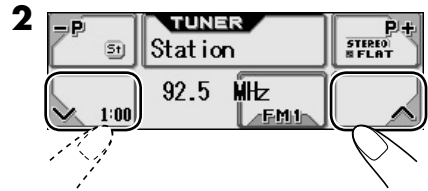
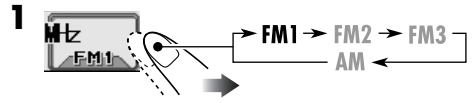

- Holding **P+** or **P-** can display the Preset Station List (see step 5 below).

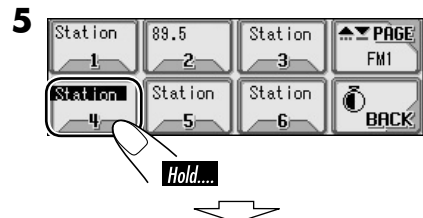
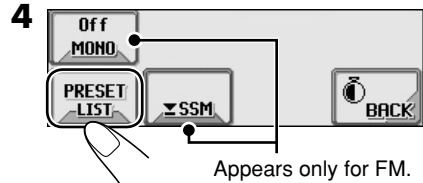
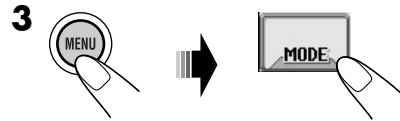

Listening to a preset station

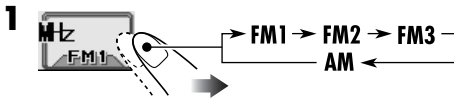

2 Select a preset station (1 – 6) you want.

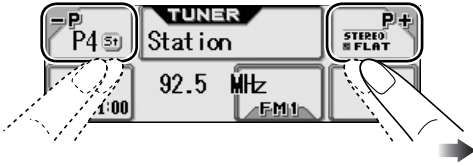

- Holding **P+** or **P-** can display the Preset Station List (see below).

To select a preset station using the Preset Station List

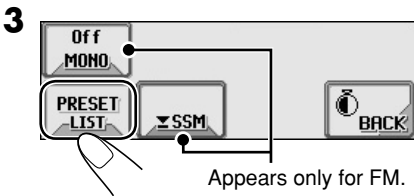
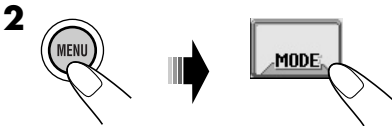
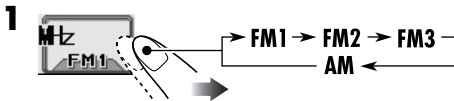

4 Select a preset number.

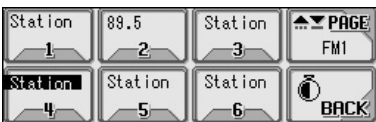

Preset Station List

The lists show either the station frequency or assigned name (the first 8 characters).

Appears only for FM.

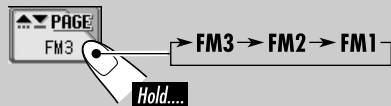
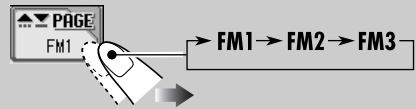

Disc/SD card operations

Playing a disc in the receiver

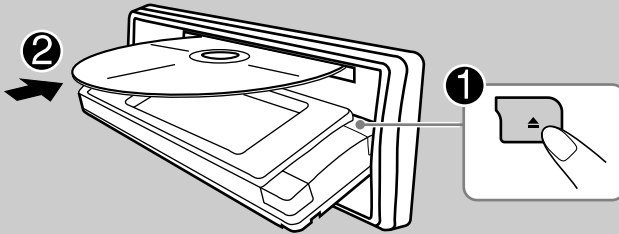

All tracks will be played repeatedly until you change the source or eject the disc.

About MP3 and WMA tracks

MP3 and WMA (Windows Media® Audio) “tracks” (words “file” and “track” are used interchangeably) are recorded in “folders.”

- When an MP3 or a WMA folder includes an image <jll> file edited by Image Converter (Wide Ver 1.2)—supplied in the CD-ROM, you can show the image on the display while the tracks in the folder are played back—ImageLink. (See pages 14, 26, and 43 for details.)

- When inserting an MP3 or a WMA disc:

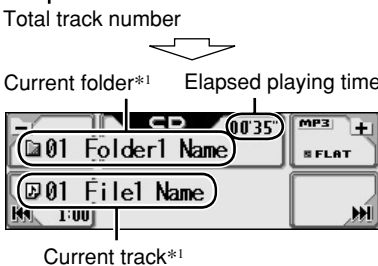
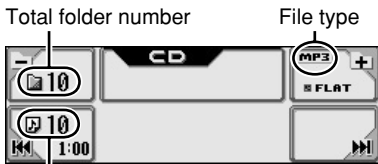

- When inserting an audio CD or a CD Text disc:

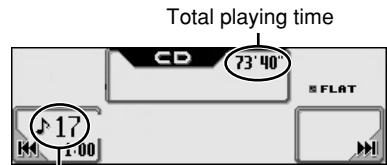

Total track number

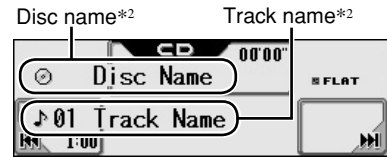

If no name is assigned to an audio CD:



To stop play and eject the disc

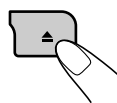

To return the control panel to its previous position, press it again.

Playing discs in the CD changer



About the CD changer

It is recommended to use the JVC MP3-compatible CD changer with your receiver.

- You can also connect other CH-X series CD changers (except CH-X99 and CH-X100). However, they are not compatible with MP3 discs, so you cannot play back MP3 discs.
- You cannot use the KD-MK series CD changers with this receiver.
- Disc text information recorded in the CD Text can be displayed when a JVC CD Text compatible CD changer is connected.
- You cannot control and play any WMA disc in the CD changer.

- When the current disc is an MP3 disc:

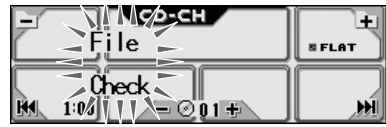

Current folder*1

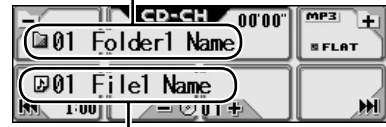

Current track*1

- When the current disc is an audio CD or a CD Text disc:

Disc name*2

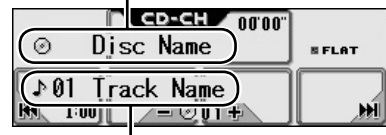

Track name*2

If no name is assigned to an audio CD:

Elapsed playing time



Current track number

*1 The album name/performer with indicator and the track title with indicator will appear if "Tag" is set to "On" (see page 28).

*2 Appear only for CD Texts and CDs if it has been assigned or recorded. ("No Name" appears for a while if no name is recorded or assigned to an audio CD.)

All tracks of the inserted discs in the magazine will be played repeatedly until you change the source or eject the magazine from the CD changer.

1 Select "CD-CH."

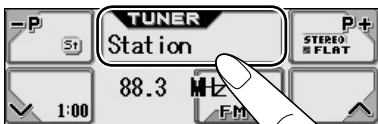

2 Select a disc.

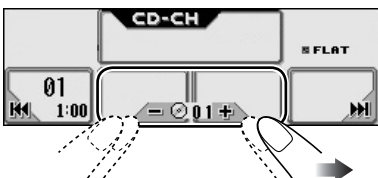

Playing an SD card



About the SD card

You can play back MP3/WMA tracks recorded on the SD card and show the stored image on the display during playback—ImageLink. (See pages 12, 26, and 43 for details.)

The required SD recording format is FAT 12/16 and the recommended storage type is 8 MB to 512 MB.

- You cannot use MMC or mini SD with this receiver.

Before detaching the control panel, turn off the power.

1 Detach the control panel.

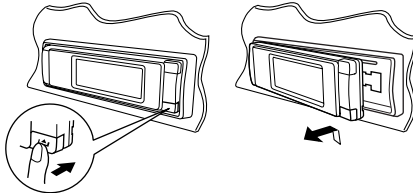

2

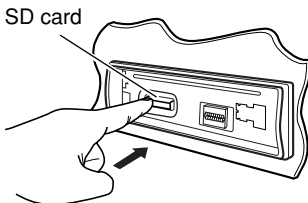
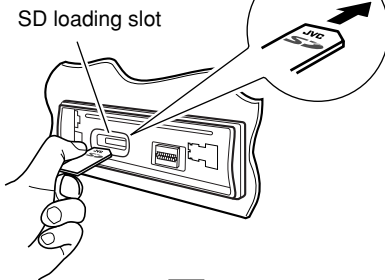

Press in the SD card until you hear a clicking sound.

To eject the SD card, press the SD card again.

3 Attach the control panel.

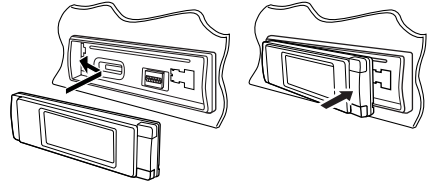

4



- The control panel goes back to the previous position (see page 33).

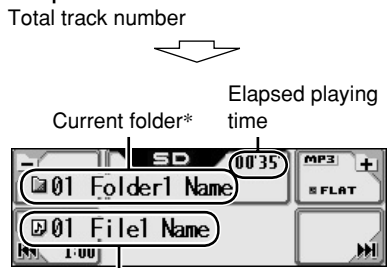
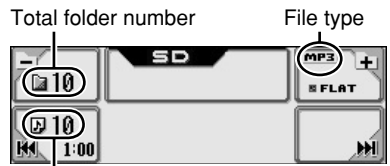
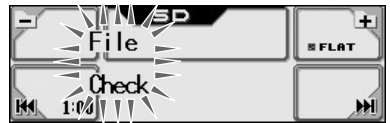

Playback starts automatically if tracks are recorded.

If an SD card has been loaded...

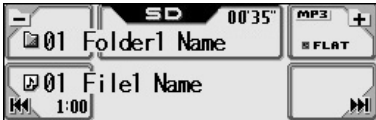

* The album name/performer with indicator and the track title with indicator will appear if "Tag" is set to "On" (see page 28).

Operation screens used for the following operations is of MP3 playback in the receiver.

To fast-forward or reverse the track

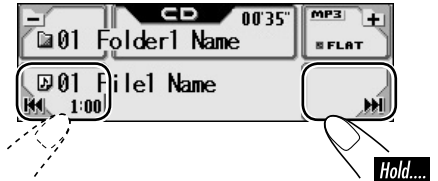

To go to the next or previous tracks

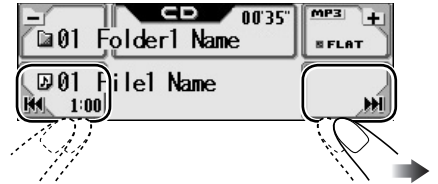

To go to the next or previous folders (only for MP3 and WMA tracks)

For MP3 tracks:



For WMA tracks:

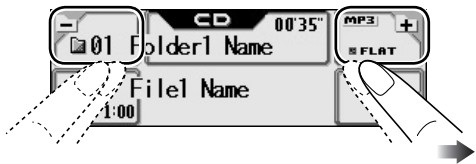

- If you hold the icon, the Folder List will appear on the display (see page 16).

To be continued...

To select a disc during playback

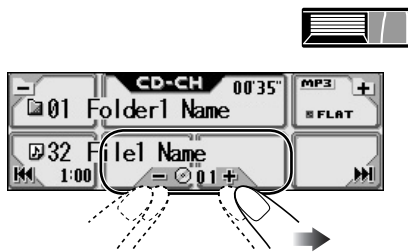

- If you hold the icon, the Disc List will appear on the display (see the right column).

Prohibiting disc ejection

You can lock a disc in the loading slot.

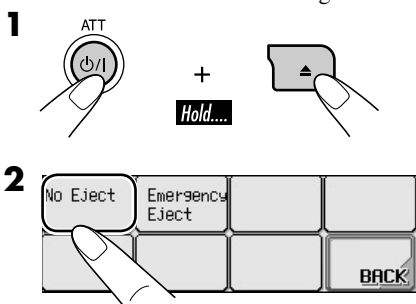

“No Eject” flashes, and the disc cannot be ejected.

To cancel the prohibition

In step 2 above, press “Eject OK.”
“Eject OK” flashes for a while.

Other main functions

Selecting a disc/folder/track on the list

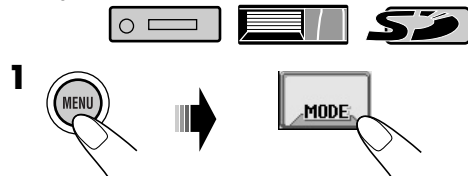

2 • Select a disc (only for the CD changer).

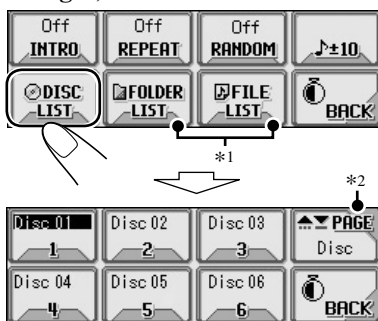

If the selected disc is an MP3/WMA disc, its Folder List appears.

• Select a folder (only for MP3/WMA disc or SD card).

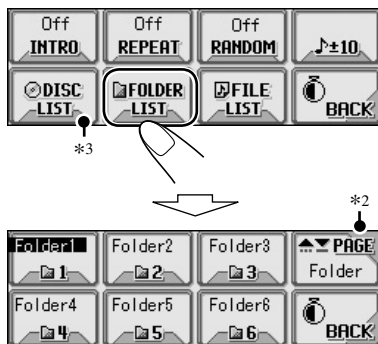

If you select the current folder (highlighted on the screen), its File List appears.

- Select a track (only for MP3/WMA disc or SD card).



File List of the current folder appears.

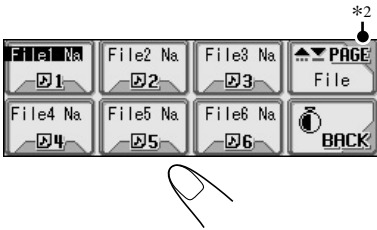

- *1 Appears only if the current disc is an MP3 discs.
- *2 Press to go to the next list; hold to go to the previous list.
- *3 Displayed only when the source is "CD-CH."

When using the remote controller....



- To directly select a disc in the CD changer
- To directly select a track of an audio CD or a CD Text
- To directly select a folder of an MP3/WMA disc or an SD card

To select a number from 1 – 6:

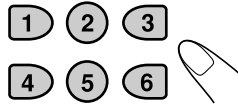

To select a number from 7 (1) – 12 (6):

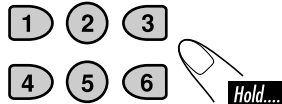

It is required that folders are assigned with 2-digit numbers at their beginning of their names—01, 02, 03, and so on.

■ Skipping a track quickly during play

For audio CD/CD Text:

For MP3 tracks:

For WMA tracks:

For MP3 or WMA tracks, you can skip a track within the same folder.

Ex.: To select track 32 while playing track 6 in the CD changer

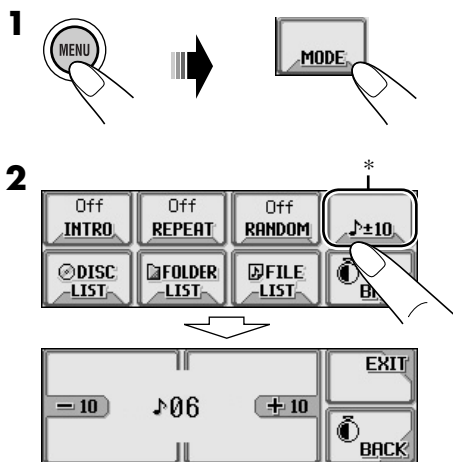

* If the source is "CD-CH": Works only when JVC MP3 compatible CD changer (CH-X1500) is connected.

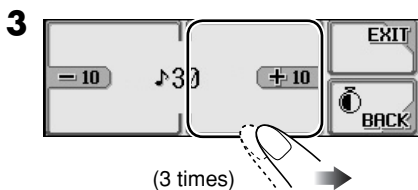

First time you press "+10" or "-10," the track skips to the nearest higher or lower track with a track number of multiple ten (ex. 10th, 20th, 30th).

Then each time you press the button, you can skip 10 tracks.

- After the last track, the first track will be selected and vice versa.

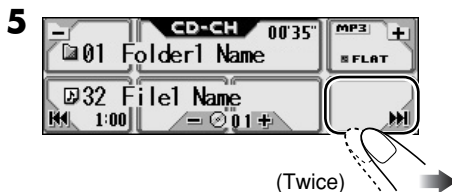
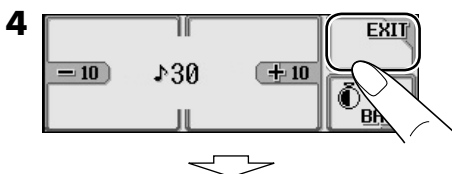

Selecting the playback modes

You can use only one of the following playback modes at a time.

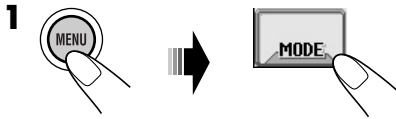



2 Select your desired playback mode.

Intro play





Mode Plays the beginning 15 seconds of ...

- Track:** All tracks of the current disc or the SD card.
- While playing,  lights up.
- Folder*¹:** First track of all folders of the current disc or the SD card.
- While playing,  lights up.
- Disc*²:** First tracks of all the inserted discs.
- While playing,  lights up.
- Off:** Cancels.

Repeat play







Mode Plays repeatedly

- Track:** The current track.
- While playing,  lights up.
- Folder*¹:** All tracks of the current folder.
- While playing,  lights up.
- Disc*²:** All tracks of the current disc.
- While playing,  lights up.
- Off:** Cancels.

Random play



Mode Plays at random

- Folder*¹:** All tracks of the current folder, then tracks of the next folder and so on.
- While playing,  lights up.
- Disc or SD:** All tracks of the current disc or the SD card.
- While playing,  or  lights up.
- All*²:** All tracks of all inserted discs.
- While playing,  lights up.
- Off:** Cancels.

*¹ Only while playing an MP3 ( /  / ) or WMA ( / ) track.

*² Only while playing discs in the CD changer ().

3 Exit from the setting.



Sound adjustments

Setting the basic sound selection menu—SEL

1

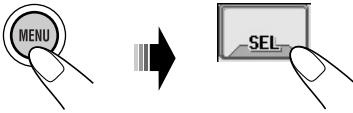

2

Select a setting item.

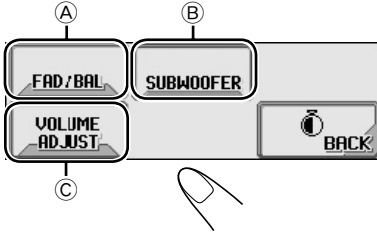

3

Adjust the selected item.

A To adjust the speaker output balance between the front and rear speakers—FAD (fader).

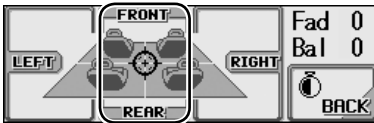

F6 (front only) to R6 (rear only)

To adjust the speaker output balance between the left and right speakers—BAL (balance).

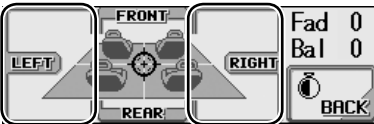

L6 (left only) to R6 (right only)

B To select the cutoff frequency to the subwoofer.



55Hz: Frequencies higher than 55 Hz are cut off.

85Hz: Frequencies higher than 85 Hz are cut off.

115Hz: Frequencies higher than 115 Hz are cut off.

Adjust the subwoofer output level.



00 (min.) to 08 (max.)

C To adjust the input level of each source (except FM). Adjust to match the input level to the FM sound level.

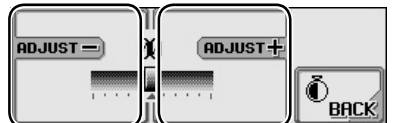

-05 (min.) to +05 (max.)

4

Exit from the setting.



Selecting preset sound modes (i-EQ: intelligent equalizer)

You can select a sound mode suitable to the music genre.

Available sound modes

FLAT (No sound mode is applied),
 HARD ROCK, R & B, POP, JAZZ,
 DANCE, COUNTRY, REGGAE,
 CLASSIC, USER 1, USER 2, USER 3

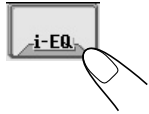
- 

- Select a sound mode.

FLAT	HARD ROCK	R & B	MORE
POP	JAZZ	DANCE	BACK



COUNTRY	REGGAE	CLASSIC	MORE
USER1	USER2	USER3	BACK
- Exit from the setting.



Storing your own sound modes

Ex.: To adjust "FLAT"

- Select "FLAT" (see left column).
- Select the frequency band—60Hz, 150Hz, 400Hz, 1kHz, 2.4kHz, 6kHz, 12kHz.
- Adjust the level of the selected band.
- Repeat steps 2 and 3 to adjust the other frequency bands.
- 

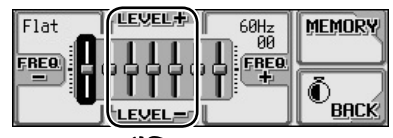
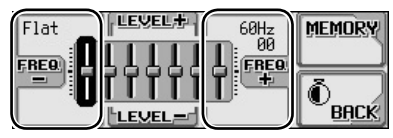

-05 (min.) to +05 (max.)

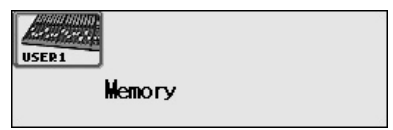
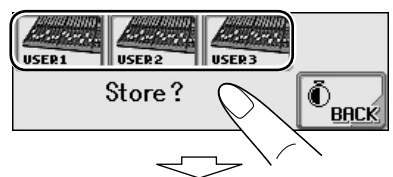
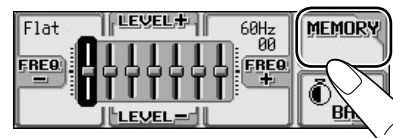

Ex.: When "USER1" is selected

Basic procedure

Before starting the following procedure, prepare a CD-R or an SD card including still images (pictures) and animations (movies).

- With Image Converter (Wide Ver 1.2) included in the supplied CD-ROM, you can create your own images and animations. (Samples are included in the CD-ROM.)

1 Insert a CD-R, an SD card, or supplied CD-ROM.

- CD-R/supplied CD-ROM

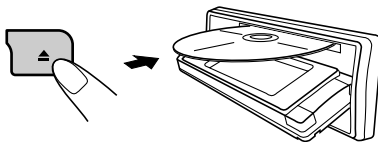

- SD card

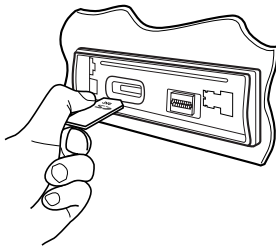

2

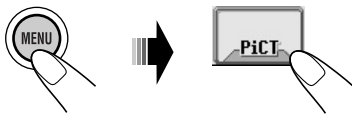

3



- To download the file(s):
➔ **Downloading the files** (see page 22)
- To delete the file(s):
➔ **Deleting the files** (see page 23)
- To activate the file(s):
➔ **Activating the downloaded files** (see page 25)

IMPORTANT:

- Refer also to Image Converter PDF files included in the “Manual” folder of the supplied CD-ROM.
- Still images (pictures) should have <jll>, and animations (movies) should have <jla> as their extension code in their file names.
- Before you download or delete the files, observe the following:
 - Do not download a file while driving.
 - Do not turn off the ignition key of the car while downloading or deleting a file.*
 - Do not detach the control panel while downloading or deleting a file.*

* If you do so, the file download or deletion will not be done correctly.

Downloading the files

- **OPENING:** Opening screen
To download/delete an animation (30 frames at maximum) which will be shown after the receiver is turned on.
- **ENDING:** Ending screen
To download/delete an animation (30 frames at maximum) which will be shown before the receiver is turned off.
- **PICTURE:** Graphic screen
To download/delete still images (30 still images at maximum) which will be shown while playing a source.
- **MOVIE:** Graphic screen
To download/delete an animation (90 frames at maximum) which will be shown while playing a source.

■ Downloading an animation or pictures

- It takes a long time to download an animation. For details, see page 44.
- To activate the downloaded files, see page 25.

1 In step ③ on page 22....



2



Appears only if "PICTURE" is selected.



- If "OPENING," "ENDING," or "MOVIE" is selected, only the folders including the <jla> files are shown.
- If "PICTURE" is selected, only the folders including the <jll> files are shown.

3 Select a folder.



(once for the currently selected; twice for the others)

4 Select a file.



5



File name appears.

- ### 6
- To download more pictures from the same folder, repeat steps 4 and 5.
 - To download more pictures from another folder, press BACK. Then, repeat steps 3 to 5.

7 Exit from the setting.



Deleting the files

■ Deleting the stored animation and pictures

1 In step ③ on page 22....



To be continued....

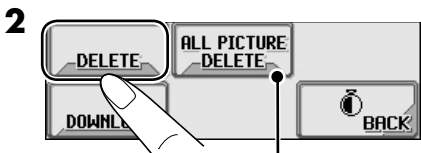

Appears only if "PICTURE" is selected.

3 • To delete the stored animation



File name appears.

• To delete the stored pictures



File name appears.

4 Repeat step 3 to delete more pictures.

5 Exit from the setting.



Deleting all the stored animation and pictures

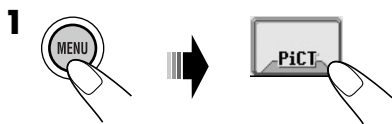

2 • To delete all the stored files

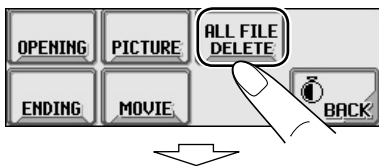

• To delete all the stored pictures

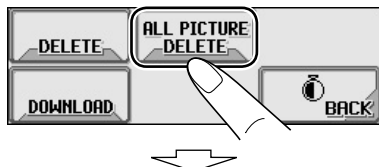
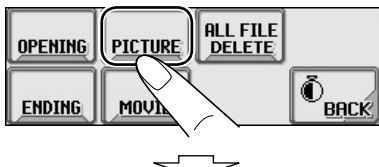

3 Exit from the setting.



Activating the downloaded files

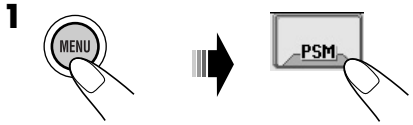

2 • To activate the animations stored for opening and ending screens

1 Select "Opening" or "Ending."

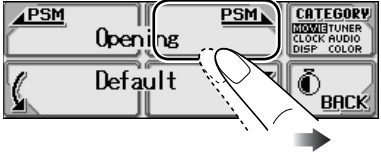

2 Select a setting you want.

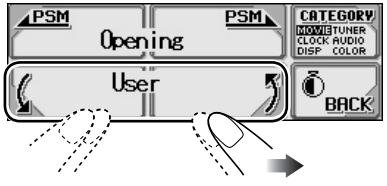

- Default:** Factory-preset animation is used.

- User:** Your own edited animation is used.

• To activate the graphic screen using either picture or movie

1 Select "Graphics."

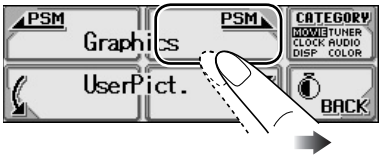

2 Select a setting you want.

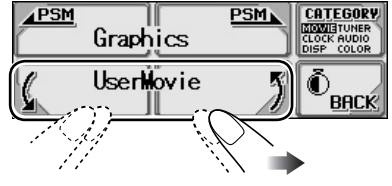

- UserMovie:** Your edited animation stored in "MOVIE" is activated.

- UserSlide:** Your edited still images stored in "PICTURE" are activated and shown in sequence.

- UserPict.:** One of your edited still images stored in "PICTURE" is activated.

• To select a still image for "UserPict."

If "UserPict." is not selected for "Graphics," you cannot select "UserPict." (see page 26).

1 Select "UserPict."

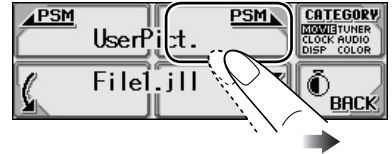

2 Select a file you want.

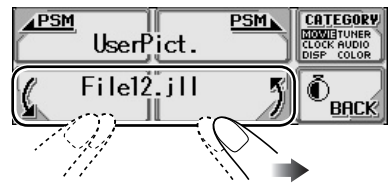

3 Exit from the setting.



General settings — PSM

Basic procedure

You can change PSM (Preferred Setting Mode) items listed in the table that follows.

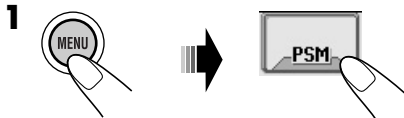

2 Select a PSM category.

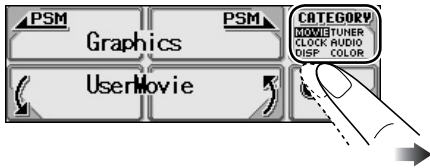

You can move to a different category by simply changing the PSM items.

3 Select a PSM item.



4 Adjust the PSM item selected.

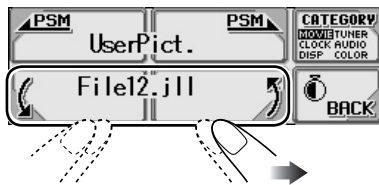

5 Repeat steps 2 to 4 to adjust the other PSM items if necessary.

6 Exit from the setting.



Indications

Selectable settings, [reference page]

Indications	Selectable settings, [reference page]
MOVIE	<p>Demo Display demonstration</p> <p>All Time: [Initial]; Display demonstration (animation) appears.</p> <p>ImageLink: To show a still image while playing back an MP3/WMA track, [12, 14, 43].</p> <p>Interval: Display demonstration (animation) and playback source indication appears alternately.</p> <p>Off: Cancels.</p> <ul style="list-style-type: none"> • These graphics appear if no operation is done for about 20 seconds.
	<p>Graphics Graphics</p> <p>You can activate the graphic screen using either movie or picture, [25].</p> <p>UserMovie: Your edited animation stored in “MOVIE” is activated.</p> <p>UserSlide: Your edited still images stored in “PICTURE” are activated and shown in sequence.</p> <p>UserPict.: [Initial]; One of your edited still images stored in “PICTURE” is activated.</p>
	<p>KeyIn CFM Key-in confirmation</p> <p>On: [Initial]; An animation screen appears when you turn on or off the power, change the source, and when you select an i-EQ.</p> <p>Off: Cancels.</p>

Indications **Selectable settings, [reference page]**

MOVIE	Opening* ¹ Opening screen	When you turn on (“Opening”) and off (“Ending”) the power, [25]... Default: [Initial]; Factory-preset animation is used.
	Ending* ¹ Ending screen	User: Your own edited animation is used.
	UserPict.* ² User picture	[Initial: First stored]; You can select one of the stored files as the graphics, [25].

CLOCK	Clock Hr Clock hour	1 – 12 (0 – 23), [8] [Initial: 1 (1:00 AM)]
	Clock Min Clock minute	00 – 59, [8] [Initial: 00 (1:00 AM)]
	24H/12H Clock system	12Hours ⇄ 24Hours, [8] [Initial: 12Hours]
	Clock Adj* ³ Automatic clock adjustment	Auto: [Initial]; The built-in clock is automatically adjusted using the clock time data provided via the SIRIUS® radio channel. Off: Cancels.
	Time Zone* ^{3, *4} Time zone	Select your residential area from one of the following time zone for clock adjustment. Eastern [Initial] ⇄ Atlantic ⇄ NewfndInd (Newfoundland) ⇄ Alaska ⇄ Pacific ⇄ Mountain ⇄ Central ⇄ (back to the beginning).
	DST* ^{3, *4} Daylight saving time	Activates this if your residential area is subject to DST. On: [Initial]; Activates daylight savings time. Off: Cancels.

DISP	Scroll Scroll	The entire text information can be shown by scrolling if it cannot be shown at a time. Once: [Initial]; Scrolls only once. Auto: Repeats scrolling (in 5-second intervals). Off: Cancels. • Holding DISP for more than one second can scrolls the display regardless of the setting.
	Dimmer Dimmer	Auto: [Initial]; Dims the display when you turn on the headlights. Off: Cancels. On: Activates dimmer. Time Set: Set the timer for dimmer, [30].

*1 Displayed only after a downloadable file is stored in memory.

*2 Displayed only after a downloadable file is stored in memory and when selecting “UserPict.” for “Graphics.”

*3 Displayed only when SIRIUS radio is connected.

*4 Displayed only when “Clock Adj” is set to “Auto.”

To be continued...

Indications

Selectable settings, [reference page]

DISP	From– To * ¹ Dimmer time	Any hour – Any hour, [30] [Initial: 6PM– 7AM]
	Contrast Contrast	1 – 10 [Initial: 5]
	LCD Type Display type	Auto: [Initial]; Positive pattern will be selected during the day time* ⁵ ; while negative pattern will be used during the night time* ⁵ . Positive: Positive pattern of the display. Negative: Negative pattern of the display (except still images, animations, and audio level meters).
	Font Type Font type	You can select the font type on the screen. 1 [Initial] ↔ 2
	Tag Tag display	On: [Initial]; To shows the ID3 tag display while playing MP3/WMA tracks, [12 – 15]. Off: Cancels.
	Theme Audio level meter	You can select the level meter during playback, [4]. Meter 1 [Initial] ↔ Meter 2 ↔ Meter 3 ↔ (back to the beginning) • Press DISP repeatedly to show the selected level meter.
	Key Info Key information	On: [Initial]; To show the key icon boundary on the touch panel to make the operations easy. Off: Cancels. (About 5 seconds after operation, the key icon boundary goes off.)
Sensitiv. Touch panel sensitivity	You can select the sensitivity level of the touch panel operations. 1 ↔ 2 [Initial] ↔ 3 ↔ (back to the beginning) • Sensitivity level decreases from 1 to 3.	
TUNER	IF Filter Intermediate frequency filter	Auto: [Initial]; Increases the tuner selectivity to reduce interference noises between the stations. (Stereo effect will be lost.) Wide: Subject to the interference noises from adjacent stations, but sound quality will not be degraded and remaining the stereo effect.
	AreaChange Tuner channel interval	EU: Select this when using the receiver in an area other than North and South America. (FM: 50 kHz—manual tuning, 100 kHz—auto search; AM: 9 kHz) US: [Initial]; Select this when using the receiver in North or South America. (FM: 200 kHz; AM: 10 kHz)
	Sirius ID * ² SIRIUS® ID	The 12-digit SIRIUS identification number is shown on the display, [35].

*¹ Displayed only when “Dimmer” is set to “Time Set.”*² Displayed only when SIRIUS radio is connected.

Indications		Selectable settings, [reference page]
AUDIO	VSS Voice support system	Beep: A beep sounds when you operate the receiver. Voice: [Initial]; Guidance is announced in the language you have selected when you operate the receiver.
	VSS Level VSS level	You can adjust the volume level of the VSS sounds. Off (cancels) \curvearrowright 1 \curvearrowright 2 \curvearrowright 3 [Initial] \curvearrowright 4
	Language Language	You can select the language for the VSS. English [Initial] \curvearrowright Español (Spanish) \curvearrowright Français (French) \curvearrowright (back to the beginning) • The indication on the display will also be shown in the selected language.
	Ext Input *3 External input	Changer: [Initial]; To use a JVC CD changer, [13]. Ext In: To use any external component (other than SIRIUS DLP), [34].
	Telephone *4 Telephone muting	Muting1/Muting2: Select either one which mutes the sounds while using the cellular phone. Off: [Initial]; Cancels. • If CD or CD changer has been selected as the source, playback pauses during telephone muting.
Amp Gain Amplifier gain control	You can change the maximum volume level of this receiver. High PWR: [Initial]; Volume 0 – Volume 50 Low PWR: Volume 0 – Volume 30 (Select this if the maximum power of the speaker is less than 52 W to prevent them from damaging the speaker.) Off: Deactivates the built-in amplifier.	
COLOR	SOURCE Source	[Initial: AllSource]; You can select your favorite display color for each source (or for all sources), [30, 31].
	USER DAY (USER NIGHT) User color	You can create your own colors, and select them for the display color, [31]. USER DAY: User color during the day time*5. USER NIGHT: User color during the night time*5.
	R Red G Green B Blue	00 – 11 [Initial: USER DAY: 07, USER NIGHT: 05] 00 – 11 [Initial: USER DAY: 07, USER NIGHT: 05] 00 – 11 [Initial: USER DAY: 07, USER NIGHT: 05]

*3 Cannot be selected if the source is "CD-CH" or "EXT-IN."

*4 Only for KD-AR5500.

*5 Depends on the "Dimmer" setting.

Selecting the dimmer mode

You can dim the display at night or as you set the timer.

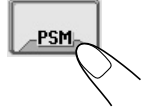
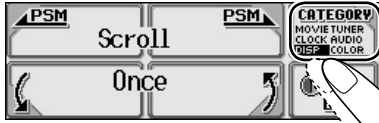
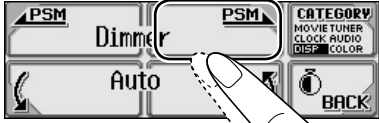
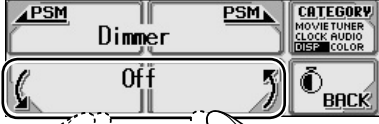
- 1  → 
- 2  →
- 3  →
- 4  →

Auto: Dims the display when you turn on the headlights.

→ Go to step 9.

Off: Cancels.

→ Go to step 9.

On: Always dims the display.

→ Go to step 9.

Time Set: Set the timer for dimmer.

→ Go to step 5.

5 Select "From-To."

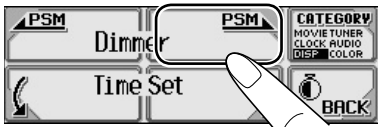

6 Set the dimmer start time.

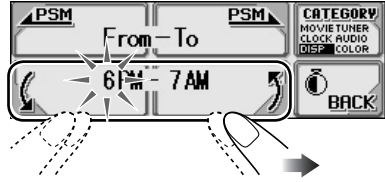

7

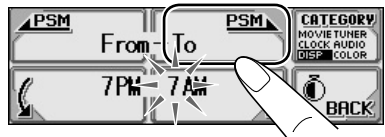

8 Set the dimmer end time.

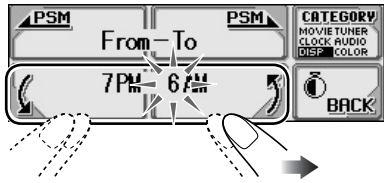



9 Exit from the setting.



Changing the display color

You can select your favorite display color for each source (or for all sources).

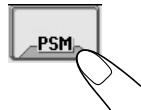
Setting the display color

- 1  → 
- 2  →

3 Select the source.

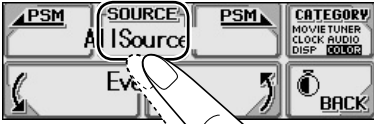

AllSource*¹ → CD → SD → Changer
 (or Ext In*²) → Line In → FM → AM
 → Sirius*³ → (back to the beginning)

- *¹ When you select "AllSource," you can use the same color for all the sources.
- *² Depends on the "Ext Input" setting, see page 29.
- *³ Appears only when SIRIUS radio is connected.

4 Select the color.

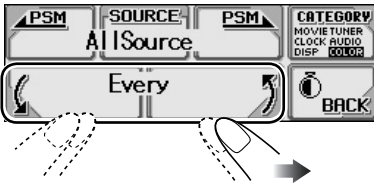

Every*⁴ ⇄ Aqua ⇄ Sky ⇄ Sea ⇄
 Leaves ⇄ Grass ⇄ Apple ⇄ Rose ⇄
 Amber ⇄ Honey ⇄ Violet ⇄ Grape ⇄
 Pale ⇄ User*⁵ ⇄ (back to the beginning)

- *⁴ The color changes every 2 seconds.
- *⁵ The user-edited colors—"USER DAY" and "USER NIGHT" will be applied (see the right column).

5 Repeat steps 3 and 4 to select the color for each source (except when selecting "AllSource" in step 3).

6 Exit from the setting.



Creating your own color—User

You can create your own colors—"USER DAY" and "USER NIGHT."

1 In step 3 on the left, select the user color.



USER DAY → USER NIGHT

2 Select the primary color (R/G/B).



3 Adjust the level (00 – 11) of the selected primary color.

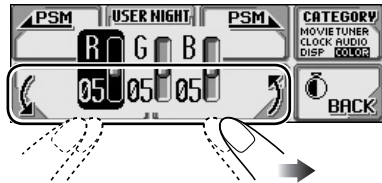

4 Repeat steps 2 and 3 to adjust the other primary color.

5 Exit from the setting.



Other main functions

Assigning titles to the sources

You can assign titles to station frequencies, CDs (both in this receiver and in the CD changer), and the external components (LINE-IN and EXT-IN).

Sources	Maximum number of characters
Station frequencies	Up to 10 characters (up to 30 station frequencies)
CDs/CD-CH	Up to 32 characters (up to 30 discs)
External components	Up to 8 characters

- You cannot assign a title to CD Text or an MP3/WMA disc.

1 Select the source.

- For FM/AM tuner: Tune into a station.
- For a CD in this receiver: Insert a CD.
- For CDs in the CD changer: Select "CD-CH," then select a disc number.
- For external component: Select "LINE-IN" or "EXT-IN."

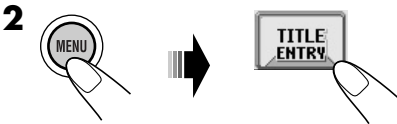

3 Assign a title (in this example, to a CD).

- Select a character set.

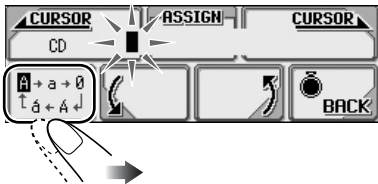

- Select a character.

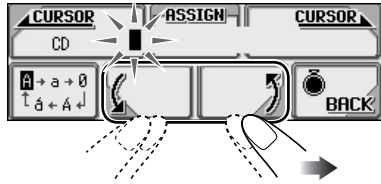

- Move to the next character position.

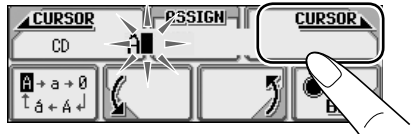

- Repeat steps 1 to 3 until you finish entering the title.

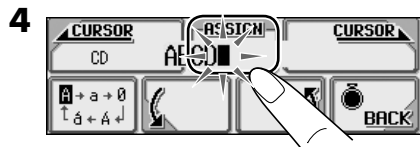

To erase the entire title

In step 3 on the left...



- For available characters, see page 44.

Changing the control panel angle

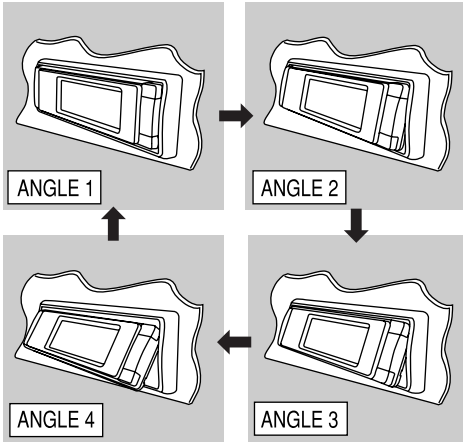
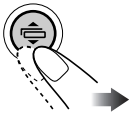

When using the remote controller....

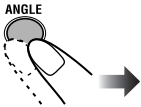

Caution:

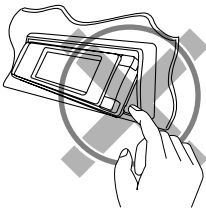

Detaching the control panel

When detaching or attaching the control panel, be careful not to damage the connectors on the back of the control panel and on the panel holder.

■ Detaching the control panel

Before detaching the control panel, be sure to turn off the power.

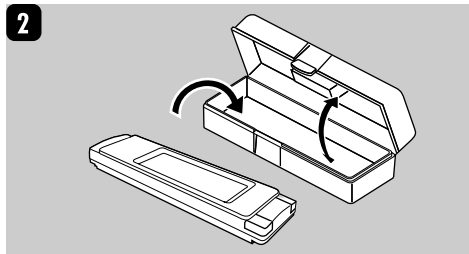
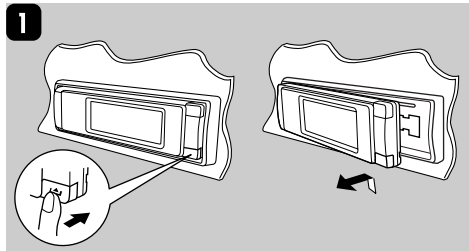

■ Attaching the control panel

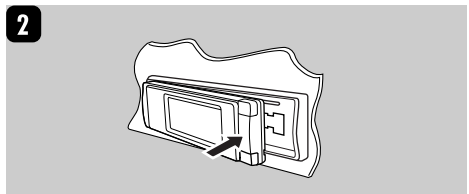
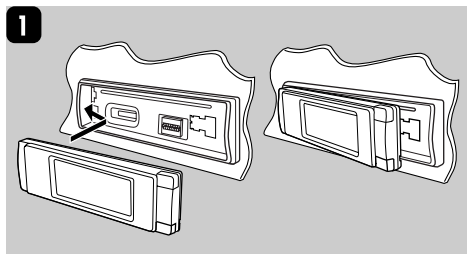

External component operations

You can connect an external component to the LINE IN plugs on the rear—LINE-IN and another to the CD changer jack on the rear using the Line Input Adapter KS-U57 (not supplied)—EXT-IN.

- For connection, see Installation/Connection Manual (separate volume).

1

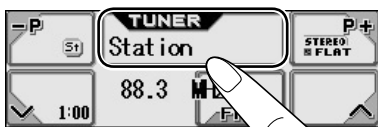

2

- To select “LINE-IN”

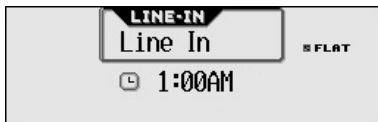

- To select “EXT-IN”

Before operating the external component, select the external input correctly (see page 29).



3

- Adjust the volume.

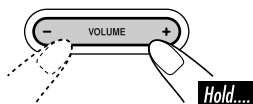

4

- Adjust the sound as you want.
(See pages 20 and 21.)

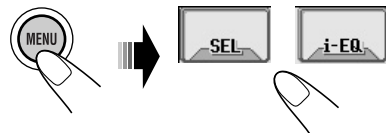

SIRIUS® radio operations

About SIRIUS radio

SIRIUS is a satellite radio that can deliver digital-quality sound. SIRIUS has 65 music channels which are all commercial-free and 50 channels of sports, news, and entertainment programs.

You can enjoy and control the SIRIUS radio digital entertainment channels from the receiver by connecting the JVC SIRIUS radio DLP—Down Link Processor (optionally purchased) to the CD changer jack on the rear.

- You can also connect the JVC SIRIUS radio PnP (Plug and Play), KT-SR1000 or KT-SR2000, using the JVC SIRIUS radio adapter, KS-U100K (not supplied). By turning on the power of the receiver, you can turn on/off the JVC PnP. However, you cannot control it from this receiver.

GCI (Global Control Information) update:

- If channels are updated after subscription, updating starts automatically. “Channels Updating XX%* Completed” appears and no sound can be heard.
- Update takes a few minutes to complete.
- Do not press any button/icon or perform any operation until updating has been completed.

Before operating your SIRIUS radio:

- For connection, see Installation/Connection Manual (separate volume).
- Refer also to the Instructions supplied with your SIRIUS radio.

* Changes when every 20% of update is completed, (ex. 20%, 40%, 60%).

Before you can listen to JVC DLP, activate your SIRIUS subscription after connection:

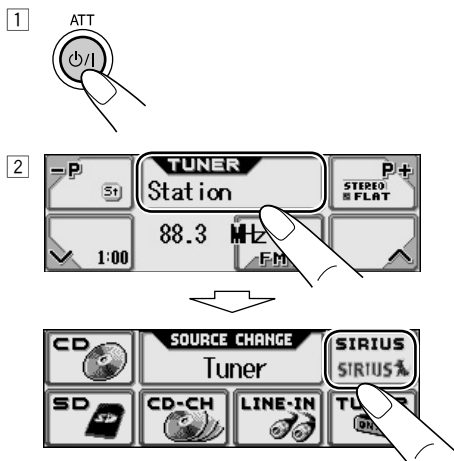

JVC DLP starts updating all the SIRIUS channels. (See GCI update on the left column.)

Once completed, JVC DLP tunes in to the preset channel, CH184.

- 3 Check your Sirius ID, see page 28.
- 4 Contact SIRIUS on the internet at <http://activate.siriusradio.com/> to activate your subscription, or you can call SIRIUS toll-free at 1-888-539-SIRIUS (7474). “Subscription Updated Press Any Key to Continue” appears on the display once subscription has been completed.

Listening to the SIRIUS® radio

1 Select "SIRIUS."

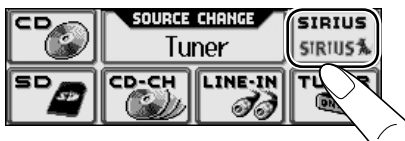
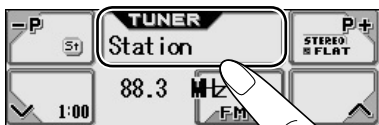

2 Select the band.

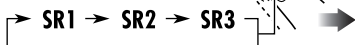
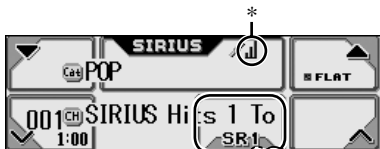

* Signal strength bar increases as the receiving signal improves. If no signal is received, it disappear.

3 Select a category.



You can tune in to all the channels of every category by selecting "ALL." Selecting a particular category (SPORTS, ENTERTAINMENT, etc.) allows you to enjoy only the channels from the selected category.

- Holding this button can display the category list (see page 38).

4 Select a channel for listening.

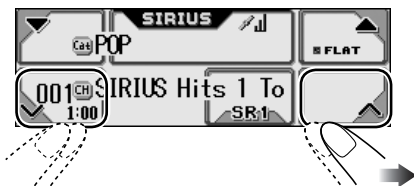

Holding this button changes the channels rapidly.

- When changing the category or channel, invalid and unsubscribed channels are skipped automatically.

Storing channels in memory

You can preset six channels for each band.
Ex.: Storing a channel into preset number 4.

1 While listening to a channel...

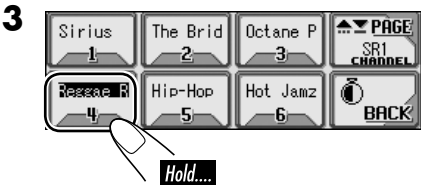
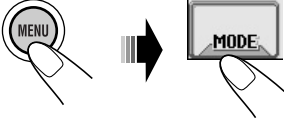

Listening to a user channel

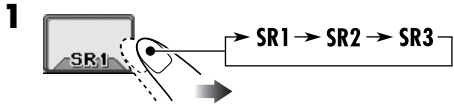

- If you hold the icon, the preset list will appear.

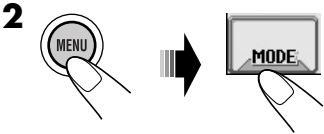

4 Select a preset number.



Selecting a category/channel on the list

1 While listening to a channel....

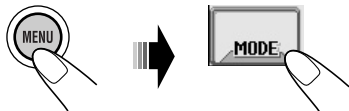

2 To select a category.



The first channel of the selected category is tuned in.

- If you select the current category (highlighted on the screen), its Channel List appears.
- Holding ▲ or ▼ can also show the category list while listening to a channel.

• To select a channel.



■ Selecting your favorite from the list

While displaying the channel list or preset list (see page 37 and left column)....

1 Enter the list information mode.



2 • If no operation is done within 5 seconds, list information mode is canceled.

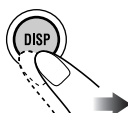

Channel list (Channel name)



Channel list (Artist name)



Channel list (Song title)

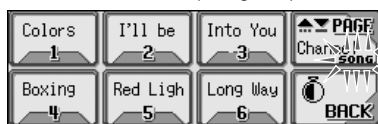

3 Select an item.

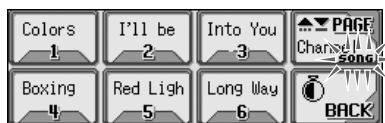

Ex.: To select a favorite song

* Press to go to the next list; hold to go to the previous list.

■ Skipping channels

While displaying the channel list (see page 38)....

Ex.: To skip listed item 6

* You cannot skip the preset channel, CH184.

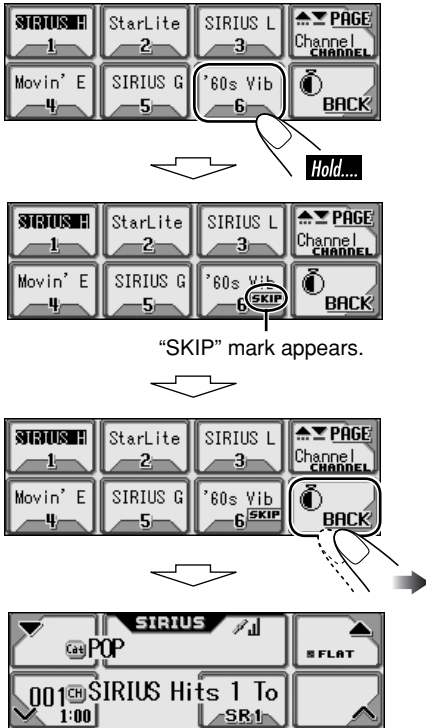

Listed item 6 will be skipped when you press ▲ / ▲ or ▼ / ▼ to search for a channel.

- The skipped channel (in this example, item 6) cannot be selected from the channel list.
- If all channels in a category are skipped, the category will also be skipped.

To add (restore) skipped channels, repeat the same procedure.

To add (restore) all skipped channel in a category, select “ALL” category before performing the above procedure.

To change the display information while listening to a channel

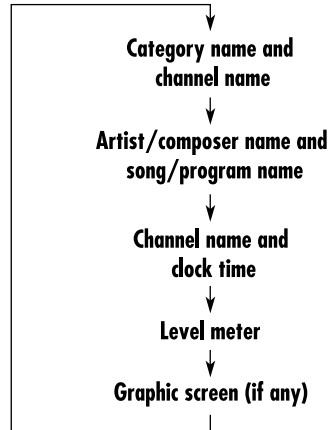
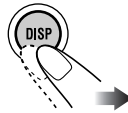

Maintenance

How to clean the touch panel

When removing stains or dust on the surface, turn off the power, then wipe with dry soft cloth.

- Be careful not to scratch the surface when wiping it.
- Do not use the following materials to clean the touch panel:
 - Wet cloth
 - Volatile substance such as benzine and thinner
 - Acid detergent, alkaline detergent, and detergent composed of organic substance
- When using chemically processed duster, read its precautions carefully.

How to clean the connectors

Frequent detachment will deteriorate the connectors.

To minimize this possibility, periodically wipe the connectors with a cotton swab or cloth moistened with alcohol, being careful not to damage the connectors.

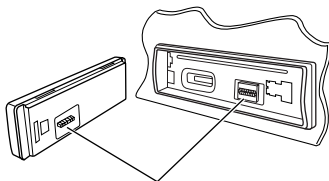

Connector

Moisture condensation

Moisture may condense on the lens inside the CD player in the following cases:

- After starting the heater in the car.
- If it becomes very humid inside the car.

Should this occur, the CD player may malfunction. In this case, eject the disc and leave the receiver turned on for a few hours until the moisture evaporates.

How to handle discs/SD cards

When removing a disc from its case, press down the center holder of the case and lift the disc out, holding it by the edges.

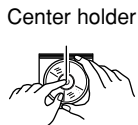

- Always hold the disc by the edges. Do not touch its recording surface.

When storing a disc into its case, gently insert the disc around the center holder (with the printed surface facing up).

- Make sure to store discs into the cases after use.

SD cards are precision products. DO NOT impact, bend, drop, or wet them.

To keep discs clean

A dirty disc may not play correctly. If a disc does become dirty, wipe it with a soft cloth in a straight line from center to edge.



- Do not use any solvent (for example, conventional record cleaner, spray, thinner, benzine, etc.) to clean discs.

To play new discs

New discs may have some rough spots around the inner and outer edges. If such a disc is used, this receiver may reject the disc.



To remove these rough spots, rub the edges with a pencil or ball-point pen, etc.

Do not use the following discs:

Warped disc



Sticker



Sticker residue

Disc



Stick-on label

More about this receiver

Basic operations

General

- The clock in the “BACK” icon on the screen works as the time countdown indicator. If no operation is done for a certain period of time, the current screen goes off, and the source operation screen resumes.

Selecting the source

- When no disc or SD card is loaded in the receiver, “CD” or “SD” cannot be selected.
- Without connecting to the CD changer, “CD-CH” cannot be selected.
- To select the “EXT-IN” for the playback source, set the “Ext Input” setting correctly (see page 29).

Turning off the power

- If you turn off the power while listening to a disc, disc play will start from where playback has been stopped previously, next time you turn on the power.

Tuner operations

Storing stations in memory

- During SSM search...
 - All previously stored stations are erased and stations are stored newly.
 - Received stations are preset in No. 1 (lowest frequency) to No. 6 (highest frequency).
 - When SSM is over, the station stored in No. 1 will be automatically tuned in.
- When storing a station manually, a previously preset station is erased when a new station is stored in the same preset number.

Disc/SD card operations

Caution for DualDisc playback

- The Non-DVD side of a “DualDisc” does not comply with the “Compact Disc Digital Audio” standard. Therefore, the use of Non-DVD side of a DualDisc on this product may not be recommended.

General

- This receiver has been designed to reproduce CDs/CD Texts, and CD-Rs (Recordable)/CD-RWs (Rewritable) in audio CD (CD-DA), MP3 and WMA format and MP3/WMA files recorded in an SD card.
- When a disc or an SD card has been loaded, selecting “CD” or “SD” for the playback source starts playback.
- When a track or folder whose number is greater than 99 is selected, the icon before the number (📁, 📁, 📁, 🎵) goes off (to show its assigned 3-digits number).

Inserting a disc

- When a disc is inserted upside down, the control panel moves down, and the disc automatically ejects from the loading slot.
- If you keep the control panel open for about 1 minute, the control panel returns to its previous position.
- Do not insert 8 cm (3-3/16") discs (single CD) and unusual shape discs (heart, flower, etc.) into the loading slot.

Playing a disc/SD card

- While playing an audio CD: If a title has been assigned to the audio CD (see page 32), it will be shown on the display.
- While fast-forwarding or reversing an MP3 or WMA track, you can only hear intermittent sounds.

To be continued....

- While playing an SD card, the playback order may differ from other SD players.
- This receiver may be unable to play back some SD cards due to their characteristics or recording conditions.
- This receiver cannot play back mini SD card and MMC.
- If the inserted SD card does not have the correct files, “SD” is skipped.

Playing a CD-R or CD-RW

- Use only “finalized” CD-Rs or CD-RWs.
- This receiver can play back only the files of the same type which is first detected if a disc includes both audio CD (CD-DA) files and MP3/WMA files.
- This receiver can play back multi-session discs; however, unclosed sessions will be skipped while playing.
- Some CD-Rs or CD-RWs may not play back on this receiver because of their disc characteristics, and for the following causes:
 - Discs are dirty or scratched.
 - Moisture condensation occurs on the lens inside the receiver.
 - The pickup lens inside the receiver is dirty.
 - CD-R/CD-RW on which the files are written with “Packet Write” method.
 - Improper recording conditions (missing data, etc.) or media conditions (stain, scratch, warp, etc.).
- CD-RWs may require a longer readout time since the reflectance of CD-RWs is lower than that of regular CDs.
- Do not use the following CD-Rs or CD-RWs:
 - Discs with stickers, labels, or protective seal stuck to the surface.
 - Discs on which labels can be directly printed by an ink jet printer.
 Using these discs under high temperatures or high humidities may cause malfunctions or damages to discs.

Playing an MP3/WMA track

- This receiver can play back MP3/WMA files with the extension code <.mp3> or <.wma> (regardless of the letter case—upper/lower).
- This receiver can show the names of albums, artists (performer), and ID3 Tag (Version 1.0, 1.1, 2.2, 2.3, or 2.4) for MP3 files and for WMA files.
- This receiver can display only one-byte characters. No other characters can be correctly displayed (see page 44).
- This receiver can play back MP3/WMA files meeting the conditions below:
 - Bit rate: 8 kbps — 320 kbps
 - Sampling frequency:
 - 48 kHz, 44.1 kHz, 32 kHz (for MPEG-1)
 - 24 kHz, 22.05 kHz, 16 kHz (for MPEG-2)
 - 48 kHz, 44.1 kHz, 32 kHz (for WMA)
 - Disc format: ISO 9660 Level 1/ Level 2, Romeo, Joliet, Windows long file name
- For MP3/WMA discs:
 - The maximum number of characters for file/folder names vary among the disc format used (includes 4 extension characters—<.mp3> or <.wma>).
 - ISO 9660 Level 1: up to 12 characters
 - ISO 9660 Level 2: up to 31 characters
 - Romeo*: up to 128 (72) characters
 - Joliet*: up to 64 (36) characters
 - Windows long file name*: up to 128 (72) characters
 - * *The parenthesis figure is the maximum number of characters for file/folder names in case the total number of files and folders is 313 or more.*
- For SD cards:
 - The maximum number of characters for folder name is 8 characters; file name is 12 characters.
 - The receiver cannot recognize folder with period (.) on the folder name.
- This receiver can recognize the total of 512 files, of 200 folders, and of 8 hierarchies of an MP3/WMA disc; 255 files and 63 folders of an SD card.

- This receiver can play back the files recorded in VBR (variable bit rate).
The files recorded in VBR have a discrepancy in elapsed time display, and do not show the actual elapsed time. Especially, after performing the search function, this difference becomes noticeable.
- This receiver cannot play back the following files:
 - MP3 files encoded with MP3i and MP3 PRO format.
 - MP3 files encoded in an unappropriated format.
 - MP3 files encoded with Layer 1/2.
 - WMA files encoded with lossless, professional, and voice format.
 - WMA files which are not based upon Windows Media® Audio.
 - WMA files copy-protected with DRM.
 - Files which have the data such as WAVE, ATRAC3, etc.
- The search function works but search speed is not constant.

Changing the source

- If you change the source, playback also stops (without ejecting the disc).
Next time you select “CD,” “SD,” or “CD-CH” for the playback source, playback starts from where it has been stopped previously.

ImageLink

- ImageLink will not work in the following cases:
 - If no <jll> file is included in an MP3/WMA folder.
 - If Intro Scan is activated.
 - If the source is changed to another from “CD” or “SD.”
 - If more than one <jll> file are included in a folder, a file with the youngest file number is used for the graphic screen.

Ejecting a disc

- If the ejected disc is not removed within 15 seconds, the disc is automatically inserted again into the loading slot to prevent it from dust. (Disc will not play this time.)

Sound adjustment

General

- Sound adjustments cannot affect the Voice Support System (VSS: see page 29) output. VSS sound always comes out of all speakers connected.
- If you are using a two-speaker system, set the fader level to “0.”
- Subwoofer out setting takes effect only when a subwoofer is connected.
- You cannot change the input level—Volume Adjustment—of the FM stations. If the source is FM, “Fix” will appear when you try to adjust it.

Storing your own sound modes

- If you do not want to store your current adjustment, but only to apply the adjustment to the current playback source, press “BACK” repeatedly to go back to the operation screen of the current source. Adjustment you made remains effective until you select a sound mode.

To be continued....

Graphic displays

Downloading (or deleting) files

- You can download a file only while selecting “CD” or “SD” for the playback source; on the other hand, you can delete a file while selecting any source.
- If you have already downloaded an animation for “OPENING,” “ENDING,” or “MOVIE,” downloading a new animation deletes the previously stored animation.
- It takes a long time to download an animation.
 - About 3 to 4 seconds for a still image (one frame).
 - About 1 to 2 minutes for an animation of 30 frames.
 - About 4 minutes for an animation of 90 frames.
- If a disc inserted does not include any <jll> and <jla> files, beeps sound when you try to operate the downloading procedure.
- If you try to store a 31st image for picture screen, “Picture Full” appears and you cannot start downloading. Delete unwanted files before downloading.
- If the total frame number of an animation downloaded exceeds the following number, the frames exceeding that numbers are ignored.
 - For “OPENING” and “ENDING”: 30
 - For “MOVIE”: 90

General settings—PSM

- “Auto Dimmer” may not work correctly on some vehicles, particularly on those having a control dial for dimming. In this case, change the “Dimmer” setting to any one other than “Auto.”
- If “LCD Type” is set to “Auto,” the display pattern will change to the “Positive” or “Negative” pattern depending on the “Dimmer” setting.

- If you change the “Amp Gain” setting from “High PWR” to “Low PWR” while the volume level is set higher than “Volume 30,” the receiver automatically changes the volume level to “Volume 30.”

Other main functions

Assigning titles to the sources

- If you try to assign a title to a 31st disc or a 31st station frequency, “Name Full” appears and you cannot enter the text entry mode. Delete unwanted titles before assignment.
- Titles assigned to discs in the CD changer can also be shown if you playback the disc from the receiver.

Available characters on the display

In addition to the Roman alphabets (A – Z, a – z), the following characters will be used.

- These characters are also used to show the various information on the display.

Upper case

Á	À	Â	Ã	Ä	Å	Æ	Ç	Ć	Ç	É	È	Ê
Ë	Ĝ	Í	Ì	Î	Ï	Ñ	Ó	Ò	Ô	Õ	Ø	Ř
Ŕ	Š	Ś	Ş	Ú	Û	Û	Ý	Ž	Ž	ß	þ	ð
Đ	Ʀ	Ł	ı	ı	đ	space						

Lower case

á	à	â	ã	ä	å	æ	ç	ć	ç	é	è	ê
ë	ĝ	í	ì	î	ï	ñ	ń	ó	ò	ô	õ	ø
ř	š	ś	ş	ú	û	û	ý	ž	ž	ß	þ	ð
đ	Ʀ	Ł	ı	ı	đ	space						

Numbers and symbols

0	1	2	3	4	5	6	7	8	9	!	”	#	\$
%	&	'	()	*	+	,	-	.	/	:	;	<
=	>	?	@	_	`	ı	ı	£	€	α	space		

Troubleshooting

What appears to be trouble is not always serious. Check the following points before calling a service center.

	Symptoms	Causes	Remedies
General	• Screen suddenly goes off.	There is a time limit for some operations.	Finish the operation within the time limit.
	• Sound cannot be heard from the speakers.	The volume level is set to the minimum level.	Adjust it to the optimum level.
		Connections are incorrect.	Check the cords and connections.
	• The receiver does not work at all.	The built-in microcomputer may have functioned incorrectly due to noise, etc.	Reset the receiver (see page 3).
	• “Connect Error” appears on the display.	The control panel is not attached correctly.	Remove the control panel, wipe the connector, then attach it again (see page 40).
• “Push Reset” appears on the display and the control panel movement is frozen.	Something is blocking the control panel movement.	Reset the receiver (see page 3). If this does not work, check the installation.	
FM/AM	• SSM automatic presetting does not work.	Signals are too weak.	Store stations manually.
	• Static noise while listening to the radio.	The antenna is not connected firmly.	Connect the antenna firmly.
Disc playback	• The receiver needs some time to start playback the audio CD.	The built-in shock-proof circuit is working.	_____
	• CD-R/CD-RW cannot be played back. • Tracks on the CD-R/CD-RW cannot be skipped.	CD-R/CD-RW is not finalized.	• Insert a finalized CD-R/CD-RW. • Finalize the CD-R/CD-RW with the component which you used for recording.
		• Disc cannot be ejected.	Disc is locked.
	• Disc cannot be recognized (“No Disc,” “Loading Error,” or “Eject Error” flashes).	The CD player may have functioned incorrectly.	Eject the disc forcibly (see page 2).
	• Disc sound is sometimes interrupted.	You are driving on rough roads.	Stop playback while driving on rough roads.
		Disc is scratched.	Change the disc.
Connections are incorrect.		Check the cords and connections.	

To be continued....

Symptoms	Causes	Remedies
<ul style="list-style-type: none"> • “No Files” appears on the display for a while. 	No MP3/WMA tracks are recorded.	Change the disc or the SD card.
	MP3/WMA tracks do not have the extension code <.mp3> or <.wma> in their file names.	Add the extension code <.mp3> or <.wma> to their file names.
	MP3/WMA tracks are not recorded in the format compliant with ISO 9660 Level 1, Level 2, Romeo, or Joliet.	Change the disc or the SD card. (Record MP3/WMA tracks using a compliant application.)
<ul style="list-style-type: none"> • Noise is generated. 	The track played back is not an MP3/WMA track (although it has the extension code <.mp3> or <.wma>).	Skip to another track or change the disc or the SD card. (Do not add the extension code <.mp3> or <.wma> to non-MP3 or WMA tracks.)
<ul style="list-style-type: none"> • Elapsed playing time is not correct. 	This sometimes occurs during play. This is caused by how the tracks are recorded.	_____
<ul style="list-style-type: none"> • “Not Support” appears on the display and track skips. 	<ul style="list-style-type: none"> • Tracks are not encoded in an appropriate format. • Copy-protected WMA tracks cannot be played back. 	Skip to the next track.
<ul style="list-style-type: none"> • “No Music” appears on the display. 	<ul style="list-style-type: none"> • No MP3/WMA tracks are recorded on the disc. • Only <jll> and/or <jla> files are recorded on the disc. 	Change the disc or the SD card.
<ul style="list-style-type: none"> • “SD Loading Error” appears on the display. 	SD card is not inserted correctly.	Detach the control panel and reinsert the SD card. The control panel goes back to ANGLE 1. (See pages 14 and 33.)
<ul style="list-style-type: none"> • “Read Failed” appears on the display. 	Tracks are not encoded in an appropriate format.	Use SD card formatted in FAT 12/16.
	The SD card or tracks cannot be played back.	Change the SD card.
<ul style="list-style-type: none"> • Correct characters are not displayed (ex. album name). 	This receiver can only display a limited number of special characters (see page 44).	_____

	Symptoms	Causes	Remedies
Graphics	<ul style="list-style-type: none"> Download does not seem to finish. 	It takes quite a long time to download an animation of many frames (see page 44).	_____
	<ul style="list-style-type: none"> Opening and ending animation does not appear. 	“KeyIn CFM” is set to “Off.”	Select “On” (see page 26).
	<ul style="list-style-type: none"> Animation does not move. 	Temperature inside the car is below 0°C (32°F)— LowTEMP appears on the display.	Wait until the operating temperature resumes.
	<ul style="list-style-type: none"> The entire animation has not been downloaded. 	“OPENING” and “ENDING” can only memorize 30 frames of the animation even it includes 90 frames.	_____
Preferred setting modes—PSM	<ul style="list-style-type: none"> “MOVIE” category settings do not take effect. 	Temperature inside the car is below 0°C (32°F)— LowTEMP appears on the display.	Wait until the operating temperature resumes.
	<ul style="list-style-type: none"> You cannot select an image for “UserPict.” (“-----” appears for the file name on the lower part of the display). 	No files are downloaded yet.	Select an image only after downloading the appropriate files in memory.
CD changer	<ul style="list-style-type: none"> “No Magazine” flashes on the display. 	No magazine is loaded in the CD changer.	Insert the magazine.
	<ul style="list-style-type: none"> “No Disc” flashes on the display. 	No disc is in the magazine.	Insert disc into the magazine.
		Disc is inserted upside down.	Insert disc correctly.
	<ul style="list-style-type: none"> “Reset 08” flashes on the display. 	This receiver is not connected to the CD changer correctly.	Connect this receiver and the CD changer correctly and press the reset button of the CD changer.
	<ul style="list-style-type: none"> “Reset 01” – “Reset 07” flashes on the display. 	The CD player may have functioned incorrectly.	Press the reset button of the CD changer.
<ul style="list-style-type: none"> The CD changer does not work at all. 	The built-in microcomputer may have functioned incorrectly due to noise, etc.	Reset the receiver (see page 3).	

To be continued....

	Symptoms	Causes	Remedies
SIRIUS	• “CALL 1-888-539-SIRIUS TO SUBSCRIBE” scrolls on the display.	Subscription has not been done.	Starts subscribing (see page 35).
	• “No Signal” appears on the display.	Signals are too weak.	Move to an area with stronger signals.
	• “No Antenna” appears on the display.	The antenna is not connected firmly.	Connect the antenna firmly.
	• “Invalid Channel” appears on the display for about 5 seconds, then returns to the previous display.	No broadcast on the selected channel.	Select another channel or continue listening to the previous channel.
	• “Skipped Channel” appears when presetting a channel.	The channel is set to be skipped.	Add the channel again (see page 39).
	• “No Name” appears or scrolls on the display.	No text information for the selected channel.	_____
	• No sound can be heard.	“Channels Updating XX%* Completed” appears on the display.	The receiver is updating the channel information and it takes a few minutes to complete.
	• SIRIUS radio does not work at all.	The built-in microcomputer may function incorrectly due to noise, etc.	Reconnect the SIRIUS radio after a few seconds.

* Changes every 20% of update is completed, (ex. 20%, 40%, 60%).

- Microsoft and Windows Media are either registered trademarks or trademarks of Microsoft Corporation in the United States and/or other countries.
- SD logo is a trademark.

Specifications

AUDIO AMPLIFIER SECTION

Power Output:

22 W RMS \times 4 Channels at 4 Ω
and \leq 1% THD+N

Signal to Noise Ratio:

80 dBa (reference: 1 W into 4 Ω)



Load Impedance: 4 Ω (4 Ω to 8 Ω allowance)

Equalizer Control Range:

Frequencies: 60 Hz, 150 Hz, 400 Hz, 1 kHz,
2.4 kHz, 6 kHz, 12 kHz

Level: \pm 10 dB

Frequency Response: 40 Hz to 20 000 Hz

Line-Out Level/Impedance:

5.0 V/20 k Ω load (full scale)

Output Impedance: 1 k Ω

Subwoofer-Out Level/Impedance:

5.0 V/20 k Ω load (full scale)

Other Terminals: LINE IN, CD changer,
Steering wheel remote input

TUNER SECTION

Frequency Range:

FM: 87.5 MHz to 107.9 MHz
(with channel interval set to 200 kHz)
87.5 MHz to 108.0 MHz
(with channel interval set to 50 kHz)

AM: 530 kHz to 1 710 kHz
(with channel interval set to 10 kHz)
531 kHz to 1 602 kHz
(with channel interval set to 9 kHz)

[FM Tuner]

Usable Sensitivity: 11.3 dBf (1.0 μ V/75 Ω)

50 dB Quieting Sensitivity:

16.3 dBf (1.8 μ V/75 Ω)

Alternate Channel Selectivity (400 kHz): 65 dB

Frequency Response: 40 Hz to 15 000 Hz

Stereo Separation: 35 dB

Capture Ratio: 1.5 dB

[AM Tuner]

Sensitivity: 20 μ V

Selectivity: 65 dB

CD/SD PLAYER SECTION

Type: Compact disc player

Signal Detection System: Non-contact optical
pickup (semiconductor laser)

Number of Channels: 2 channels (stereo)

Frequency Response: 5 Hz to 20 000 Hz

Dynamic Range: 98 dB

Signal-to-Noise Ratio: 102 dB

Wow and Flutter: Less than measurable limit

MP3 (MPEG Audio Layer 3):

Max. Bit Rate: 320 kbps

WMA (Windows Media[®] Audio):

Max. Bit Rate: 192 kbps

Playable SD Card: Format: Fat 12/16

Storage: Up to 512 MB

Playable Audio Format for SD Card:

MP3/WMA

GENERAL

Power Requirement:

Operating Voltage:

DC 14.4 V (11 V to 16 V allowance)

Grounding System: Negative ground

Allowable Operating Temperature:

0 $^{\circ}$ C to +40 $^{\circ}$ C (32 $^{\circ}$ F to 104 $^{\circ}$ F)

Dimensions (W \times H \times D):

Installation Size (approx.):

182 mm \times 52 mm \times 159 mm
(7-3/16" \times 2-1/16" \times 6-5/16")

Panel Size (approx.):

188 mm \times 58 mm \times 13 mm
(7-7/16" \times 2-5/16" \times 9/16")

Mass (approx.):

1.9 kg (4.2 lbs) (excluding accessories)

Design and specifications are subject to change without notice.

If a kit is necessary for your car, consult your telephone directory for the nearest car audio speciality shop.



Having TROUBLE with operation?

Please reset your unit

Refer to page of How to reset your unit

Still having trouble??

USA ONLY

Call 1-800-252-5722

<http://www.jvc.com>

We can help you!

JVC



EN, SP, FR

© 2004 Victor Company of Japan, Limited

1204DTSMDTJEIN

JVC KD-AR5500/KD-LHX550

Installation/Connection Manual Manual de instalación/conexión Manuel d'installation/raccordement

GET0282-002A
[J]

1204DTSMDTJEIN
EN, SP, FR

ENGLISH

ESPAÑOL

FRANÇAIS

This receiver is designed to operate on **12 V DC, NEGATIVE ground electrical systems**. If your vehicle does not have this system, a voltage inverter is required, which can be purchased at JVC car audio dealers.

Esta unidad está diseñada para funcionar con **12 V de CC, con sistemas eléctricos de masa NEGATIVA**. Si su vehículo no posee este sistema, será necesario un inversor de tensión, que puede ser adquirido en los concesionarios de JVC de equipos de audio para automóviles.

Cet appareil est conçu pour fonctionner sur des sources de courant continu de **12 V à masse NEGATIVE**. Si votre véhicule n'offre pas ce type d'alimentation, il vous faut un convertisseur de tension, que vous pouvez acheter chez un revendeur d'autoradios JVC.

Parts list for installation and connection

The following parts are provided for this receiver. After checking them, please set them correctly.

A / B
Hard case/Control panel
Estuche duro/Panel de control
Etui de transport/
Panneau de commande

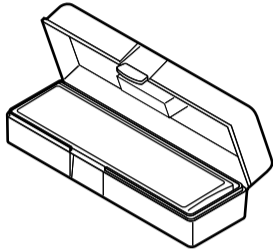

C
Sleeve
Cubierta
Manchon

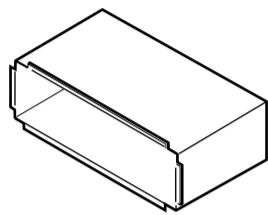

D
Trim plate
Placa de guarnición
Plaque d'assemblage

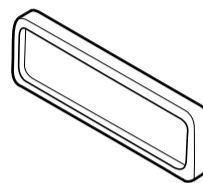

E
Power cord
Cordón de alimentación
Cordon d'alimentation

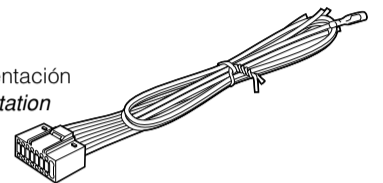

F
Washer (ø5)
Arandela (ø5)
Rondelle (ø5)



G
Lock nut (M5)
Tuerca de seguridad (M5)
Ecrou d'arrêt (M5)



H
Mounting bolt—
M5 x 20 mm (M5 x 13/16")
Perno de montaje—
M5 x 20 mm (M5 x 13/16 pulgada)
Boulon de montage—
M5 x 20 mm (M5 x 13/16 pouces)

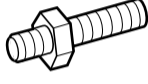

I
Rubber cushion
Cojín de goma
Amortisseur en caoutchouc



J
Handles
Manijas
Poignées



K
Remote controller
Control remoto
Télécommande

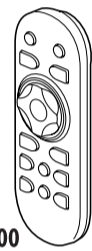

RM-RK300

L
Battery
Pila
Pile



M
CD-ROM
(Image Converter: Wide Ver 1.2)
CD-ROM
(Image Converter: Wide Ver 1.2)
CD-ROM
(Image Converter: Wide Ver 1.2)



Only for KD-AR5500 / Solo para KD-AR5500 /
Seulement pour KD-AR5500

- Refer to "USB READER/WRIter" user's guide for more details.
- Para más detalles, consulte la guía del usuario del "LECTOR/ ESCRITOR US".
- Pour plus de détails, référez-vous au guide d'utilisation de "L'ENREGISTREUR/LECTEUR USB".

N
USB reader/writer
Lector/escritor USB
Enregistreur/lecteur USB



O
USB cable
Cable USB
Câble USB

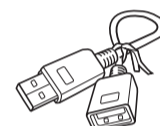

P
SD memory card (8 MB)
Tarjeta de memoria SD (8 MB)
Carte mémoire SD (8 Mo)



INSTALLATION (IN-DASH MOUNTING)

The following illustration shows a typical installation. If you have any questions or require information regarding installation kits, consult your JVC car audio dealer or a company supplying kits.

- If you are not sure how to install this receiver correctly, have it installed by a qualified technician.

INSTALACION (MONTAJE EN EL TABLERO DE INSTRUMENTOS)

La siguiente ilustración muestra una instalación típica. Si tiene alguna pregunta o necesita información acerca de las herramientas para instalación, consulte con su concesionario de JVC de equipos de audio para automóviles o a una compañía que suministra tales herramientas.

- Si usted no está seguro de cómo instalar correctamente la unidad, hágala instalar por un técnico cualificado.

INSTALLATION (MONTAGE DANS LE TABLEAU DE BORD)

L'illustration suivante est un exemple d'installation typique. Si vous avez des questions ou avez besoin d'information sur des kits d'installation, consulter votre revendeur d'autoradios JVC ou une compagnie d'approvisionnement.

- Si l'on n'est pas sûr de pouvoir installer correctement cet appareil, le faire installer par un technicien qualifié.

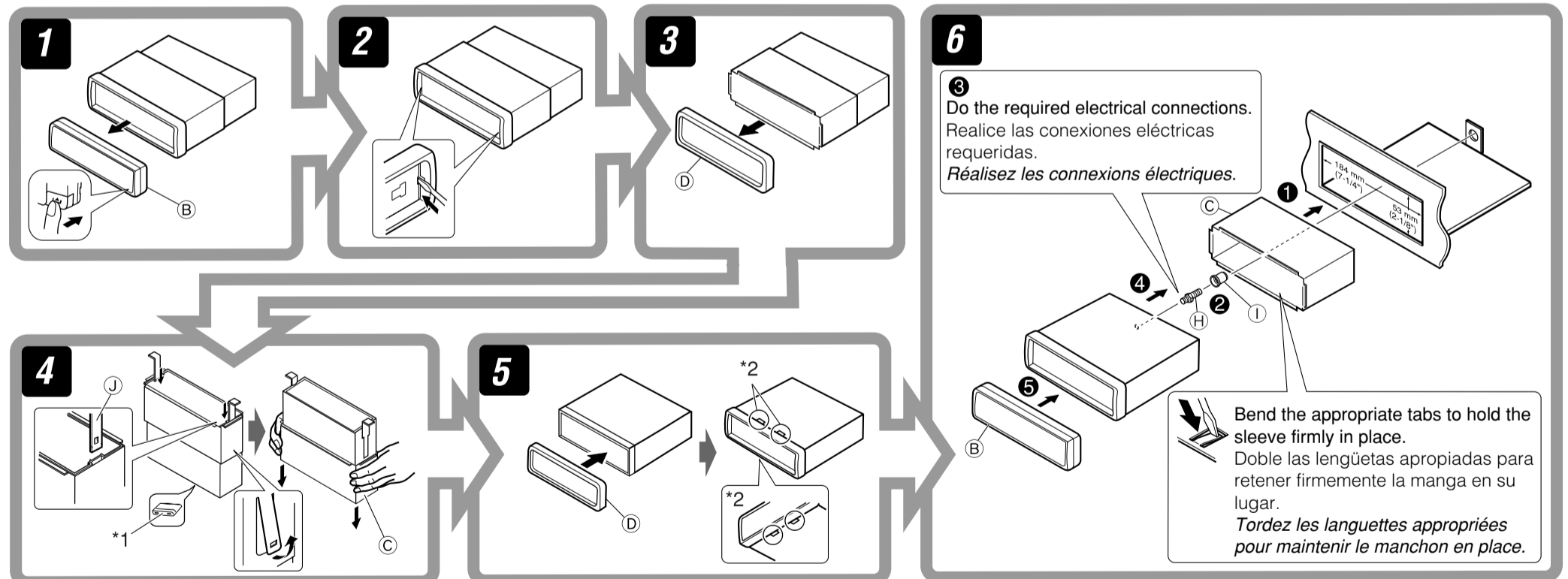

- *1 When you stand the receiver, be careful not to damage the fuse on the rear.
*1 Al poner la unidad vertical, tenga cuidado de no dañar el fusible provisto en la parte posterior.
*1 Lorsque vous mettez l'appareil à la verticale, faire attention de ne pas endommager le fusible situé sur l'arrière.

- *2 Fit the protrusions outside the receiver.
*2 Haga encajar los salientes del exterior de la unidad.
*2 Fixez les protubérances à l'extérieur de l'appareil.

Removing the receiver

Before removing the receiver, release the rear section.

Extracción de la unidad

Antes de extraer la unidad, libere la sección trasera.

Retrait de l'appareil

Avant de retirer l'appareil, libérer la section arrière.

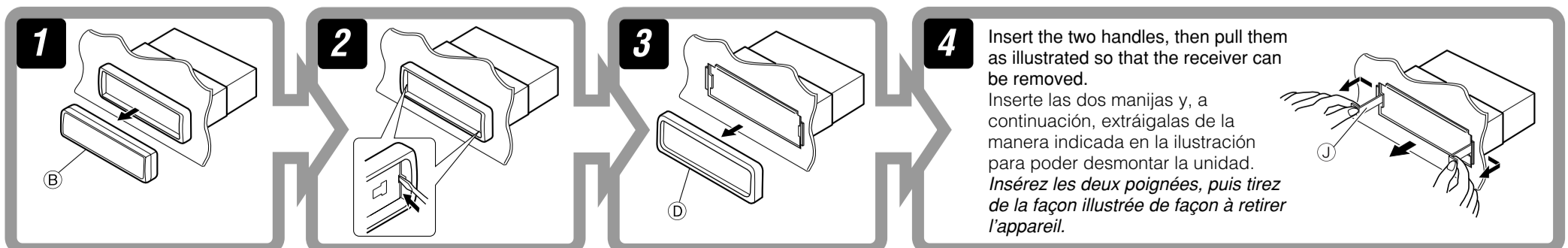

When using the optional stay / Cuando emplea un soporte opcional / Lors de l'utilisation du hauban en option

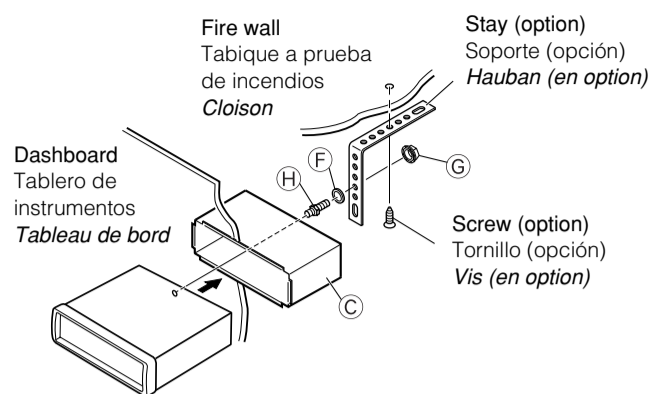

Install the receiver at an angle of less than 30°.
Instale la unidad a un ángulo de menos de 30°.
Installez l'appareil avec un angle de moins de 30°.

When installing the receiver without using the sleeve / Instalación de la unidad sin utilizar la cubierta / Lors de l'installation de l'appareil sans utiliser de manchon

In a Toyota for example, first remove the car radio and install the receiver in its place.
En un Toyota por ejemplo, primero retire la radio del automóvil y luego instale la unidad en su lugar.
Par exemple dans une Toyota, retirer d'abord l'autoradio et installer l'appareil à la place.

Flat type screws—M5 x 8 mm (M5 x 3/8") *3
Tornillos tipo plano—M5 x 8 mm (M5 x 3/8 pulgada) *3
Vis à tête plate—M5 x 8 mm (M5 x 3/8 pouces) *3

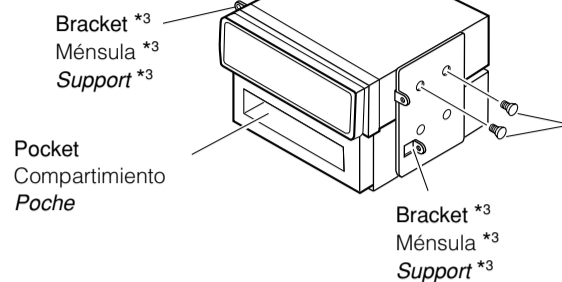

*3 Not included for this receiver.
*3 No suministrado con esta unidad.
*3 Non fourni avec cet appareil.

Flat type screws—M5 x 8 mm (M5 x 3/8") *3
Tornillos tipo plano—M5 x 8 mm (M5 x 3/8 pulgada) *3
Vis à tête plate—M5 x 8 mm (M5 x 3/8 pouces) *3

- Note** : When installing the receiver on the mounting bracket, make sure to use the 8 mm (3/8")-long screws. If longer screws are used, they could damage the receiver.
Nota : Cuando instala la unidad en la ménsula de montaje, asegúrese de utilizar los tornillos de 8 mm (3/8 pulgada) de longitud. Si se utilizan tornillos más largos, éstos pueden dañar la unidad.
Remarque : Lors de l'installation de l'appareil sur le support de montage, s'assurer d'utiliser des vis d'une longueur de 8 mm (3/8 pouces). Si des vis plus longues sont utilisées, elles peuvent endommager l'appareil.

Caution when installing / Precaución en la instalación / Précautions lors de l'installation:

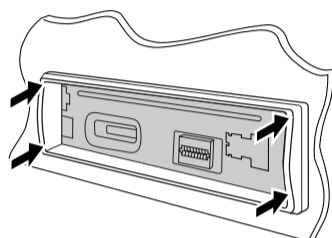

Fit the receiver into the mounting sleeve by using four corners of the trim plate.

- DO NOT press the panel (shaded in the illustration).
 - NO presione el panel (sombreado en la ilustración).
- Introduzca el receptor en la manga de montaje utilizando las cuatro esquinas de la placa decorativa.
Fixez l'autoradio sur le manchon de montage en utilisant les quatre coins de la plaque de garniture.
• NE PUSSEZ PAS sur le panneau (en gris sur l'illustration).

ELECTRICAL CONNECTIONS

To prevent short circuits, we recommend that you disconnect the battery's negative terminal and make all electrical connections before installing the receiver.

- Be sure to ground this receiver to the car's chassis again after installation.

Notes:

- Replace the fuse with one of the specified rating. If the fuse blows frequently, consult your JVC car audio dealer.
- It is recommended to connect to the speakers with maximum power of more than 52 W (both at the rear and at the front, with an impedance of 4 Ω to 8 Ω). If the maximum power is less than 52 W, change "Amp Gain" setting to prevent the speakers from being damaged (see page 29 of the INSTRUCTIONS).
- To prevent short-circuit, cover the terminals of the UNUSED leads with insulating tape.
- The heat sink becomes very hot after use. Be careful not to touch it when removing this receiver.

Heat sink
Sumidero térmico
Dissipateur de chaleur

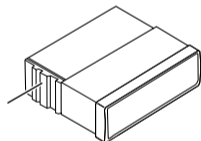

CONEXIONES ELECTRICAS

Para evitar cortocircuitos, recomendamos que desconecte el terminal negativo de la batería y que efectúe todas las conexiones eléctricas antes de instalar la unidad.

- Asegúrese de volver a conectar a masa esta unidad al chasis del automóvil después de la instalación.

Notas:

- Reemplace el fusible por uno con la corriente especificada. Si el fusible se quemase frecuentemente consulte con su concesionario de JVC de equipos de audio para automóviles.
- Se recomienda conectar los altavoces con una potencia máxima de más de 52 W (tanto atrás como adelante, con una impedancia de 4 Ω a 8 Ω). Si la potencia máxima es de menos de 52 W, cambie "Ganancia" para evitar daños en los altavoces (consulte la página 29 del MANUAL DE INSTRUCCIONES).
- Para evitar cortocircuitos, cubra los cables NO UTILIZADOS con cinta aislante.
- El sumidero térmico estará muy caliente después del uso. Asegúrese de no tocarlo al desmontar esta unidad.

RACCORDEMENTS ELECTRIQUES

Pour éviter tout court-circuit, nous vous recommandons de débrancher la borne négative de la batterie et d'effectuer tous les raccordements électriques avant d'installer l'appareil.

- Assurez-vous de raccorder de nouveau la mise à la masse de cet appareil au châssis de la voiture après l'installation.

Remarques:

- Remplacer le fusible par un de la valeur précisée. Si le fusible saute souvent, consulter votre revendeur d'autoradios JVC.
- Il est recommandé de connecter des enceintes avec une puissance de plus de 52 W (les enceintes arrière et les enceintes avant, avec une impédance comprise entre 4 Ω et 8 Ω). Si la puissance maximum est inférieure à 52 W, changez "Gain Amp" pour éviter d'endommager vos enceintes (voir page 29 du MANUAL D'INSTRUCTIONS).
- Pour éviter les court-circuits, couvrir les bornes des fils qui ne sont PAS UTILISÉS avec de la bande isolante.
- Le dissipateur de chaleur devient très chaud après usage. Faire attention de ne pas le toucher en retirant cet appareil.

PRECAUTIONS on power supply and speaker connections:

- DO NOT connect the speaker leads of the power cord to the car battery; otherwise, the receiver will be seriously damaged.
- BEFORE connecting the speaker leads of the power cord to the speakers, check the speaker wiring in your car.

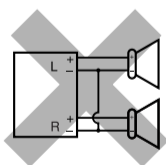

PRECAUCIONES sobre las conexiones de la fuente de alimentación y de los altavoces:

- NO conecte los conductores de altavoz del cable de alimentación a la batería de automóvil, pues podrían producirse graves daños en la unidad.
- ANTES de conectar a los altavoces los conductores de altavoz del cable de alimentación, verifique el conexionado de altavoz de su automóvil.

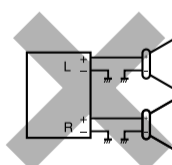

PRECAUTIONS sur l'alimentation et la connexion des enceintes:

- NE CONNECTEZ PAS les fils d'enceintes du cordon d'alimentation à la batterie; sinon, l'appareil serait sérieusement endommagé.
- AVANT de connecter les fils d'enceintes du cordon d'alimentation aux enceintes, vérifiez le câblage des enceintes de votre voiture.

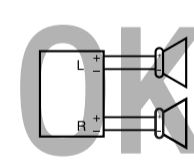

TROUBLESHOOTING

- **The fuse blows.**
* Are the red and black leads connected correctly?
- **Power cannot be turned on.**
* Is the yellow lead connected?
- **No sound from the speakers.**
* Is the speaker output lead short-circuited?
- **Sound is distorted.**
* Is the speaker output lead grounded?
* Are the "-" terminals of L and R speakers grounded in common?
- **Noise interfere with sounds.**
* Is the rear ground terminal connected to the car's chassis using shorter and thicker cords?
- **Receiver becomes hot.**
* Is the speaker output lead grounded?
* Are the "-" terminals of L and R speakers grounded in common?
- **This receiver does not work at all.**
* Have you reset your receiver?

LOCALIZACION DE AVERIAS

- **El fusible se quema.**
* ¿Están los conductores rojo y negro correctamente conectados?
- **No es posible conectar la alimentación.**
* ¿Está el cable amarillo conectado?
- **No sale sonido de los altavoces.**
* ¿Está el cable de salida del altavoz cortocircuitado?
- **El sonido presenta distorsión.**
* ¿Está el cable de salida del altavoz conectado a masa?
* ¿Están los terminales "-" de los altavoces L y R conectados a una masa común?
- **Perturbación de ruido.**
* ¿El terminal de tierra trasero está conectado al chasis del automóvil utilizando los cordones más corto y más grueso?
- **La unidad se calienta.**
* ¿Está el cable de salida del altavoz conectado a masa?
* ¿Están los terminales "-" de los altavoces L y R conectados a una masa común?
- **Este receptor no funciona en absoluto.**
* ¿Reinicializó el receptor?

EN CAS DE DIFFICULTES

- **Le fusible saute.**
* Les fils rouge et noir sont-ils raccordés correctement?
* L'appareil ne peut pas être mise sous tension.
* Le fil jaune est-elle raccordée?
- **Pas de son des enceintes.**
* Le fil de sortie d'enceinte est-il court-circuité?
- **Le son est déformé.**
* Le fil de sortie d'enceinte est-il à la masse?
* Les bornes "-" des enceintes gauche et droit sont-elles mises ensemble à la masse?
- **Interférence avec les sons.**
* La prise arrière de mise à la terre est-elle connectée au châssis de la voiture avec un cordon court et épais?
- **L'appareil devient chaud.**
* Le fil de sortie d'enceinte est-il à la masse?
* Les bornes "-" des enceintes gauche et droit sont-elles mises ensemble à la masse?
- **Cet appareil ne fonctionne pas du tout.**
* Avez-vous réinitialisé votre appareil?

A Typical Connections / Conexiones típicas / Raccordements typiques

Before connecting: Check the wiring in the vehicle carefully. Incorrect connection may cause serious damage to this receiver.
The leads of the power cord and those of the connector from the car body may be different in color.

- 1 Connect the colored leads of the power cord in the order specified in the illustration below.
- 2 Connect the antenna cord.
- 3 Finally connect the wiring harness to the receiver.

Antes de la conexión: Verifique atentamente el conexionado del vehículo. Una conexión incorrecta podría producir daños graves en la unidad.
Los cordones del cable de alimentación y los del conector procedentes de la carrocería del automóvil podrían ser de diferentes en color.

- 1 Conecte los conductores de color del cable de alimentación en el orden especificado en la ilustración de abajo.
- 2 Conecte el cable de antena.
- 3 Por último, conecte el cable de alimentación a la unidad.

Avant de commencer la connexion: Vérifiez attentivement le câblage du véhicule. Une connexion incorrecte peut endommager sérieusement l'appareil.
Le fil du cordon d'alimentation et ceux des connecteurs du châssis de la voiture peuvent être différents en couleur.

- 1 Connectez les fils colorés du cordon d'alimentation dans l'ordre spécifié sur l'illustration ci-dessous.
- 2 Connectez le cordon d'antenne.
- 3 Finalement, connectez le faisceau de fils à l'appareil.

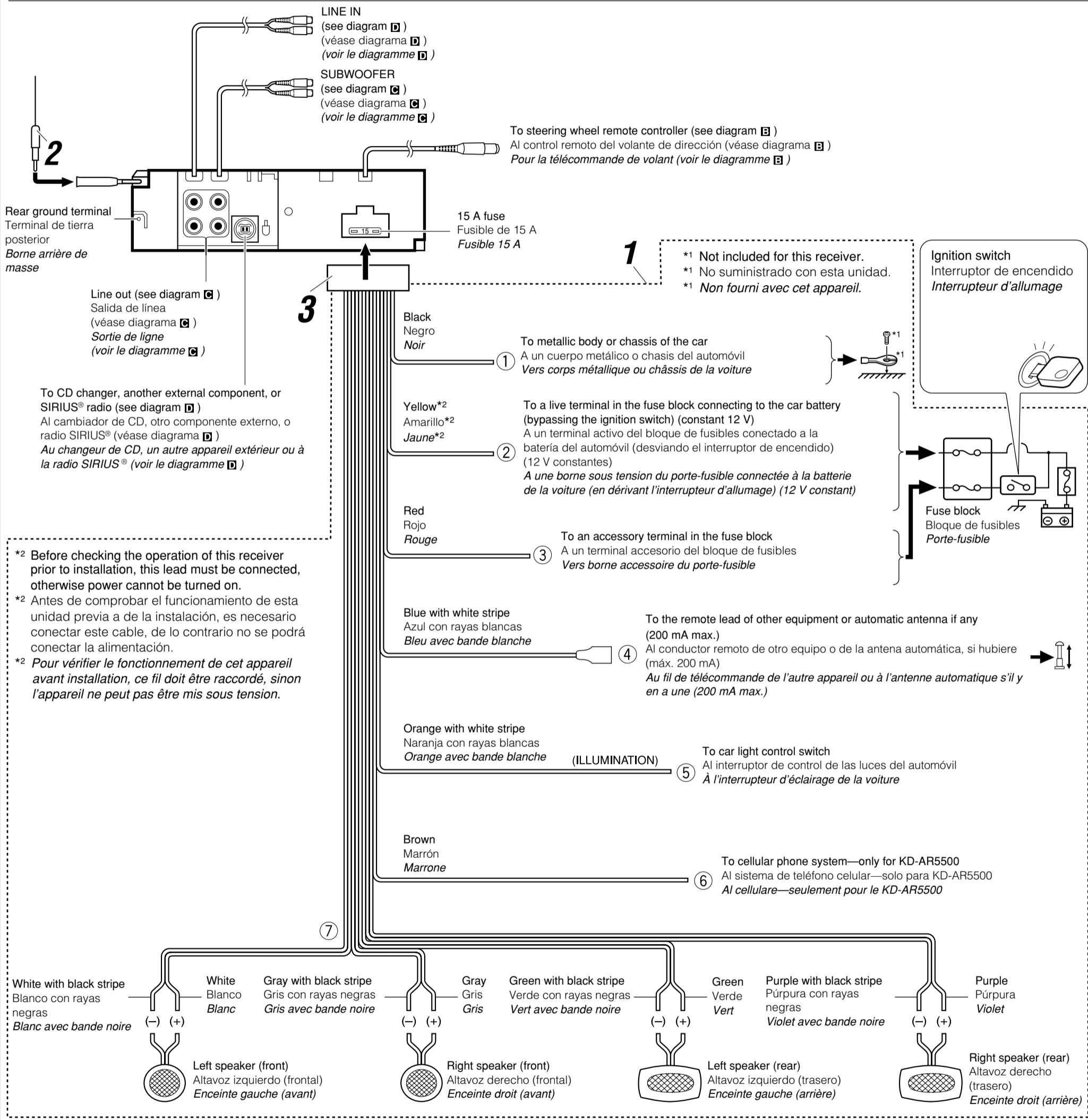

B Connecting to the steering wheel remote controller / Conexión al control remoto del volante de dirección / Connexion de la télécommande de volant

If your car is equipped with the steering wheel remote controller, you can operate this receiver using the controller. For connection, an exclusive remote adapter (not supplied) which matches your car is required. For details, consult the same car audio dealer as where the receiver is purchased.
Si su automóvil está equipado con control remoto en el volante de dirección, podrá controlar este receptor utilizando el control remoto. Para la conexión, se requiere un adaptador remoto exclusivo (no suministrado) que sea adecuado para su automóvil. Para los detalles, consulte con el concesionario car audio donde compró el receptor.
Si votre voiture est équipée d'une télécommande de volant, vous pouvez commander cet autoradio en utilisant cette télécommande. Pour la connexion, vous avez besoin d'un adaptateur de télécommande spécialisé (non fourni) correspondant à votre voiture. Pour en savoir plus, consultez le revendeur autoradio où vous avez acheté votre autoradio.

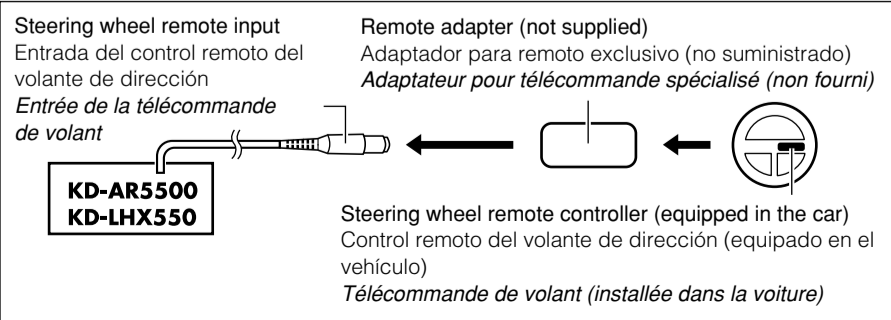

C Connecting the external amplifiers / Conexión a los amplificadores externos / Connexion d'amplificateurs extérieurs

You can connect amplifiers to upgrade your car stereo system.

- Connect the remote lead (blue with white stripe) to the remote lead of the other equipment so that it can be controlled through this receiver.
- **For amplifier only:**
 - Disconnect the speakers from this receiver, connect them to the amplifier. Leave the speaker leads of this receiver unused.
 - You can switch off the built-in amplifier and send the audio signals only to the external amplifier(s) to get clear sounds and to prevent internal heat built-up inside the receiver. See page 29 of the INSTRUCTIONS (separate volume).
 - The line output level of this receiver is kept high to maintain the hi-fi sounds reproduced from this receiver. When connecting an external amplifier to this receiver, turn down the gain control on the external amplifier to obtain the best performance from this receiver.

Usted podrá conectar amplificadores para mejorar el sistema estéreo de su automóvil.

- Conecte el conductor remoto (azul con rayas blancas) al conductor remoto del otro equipo para poderlo controlar a través de esta unidad.
- **Sólo para el amplificador:**
 - Desconecte los altavoces de esta unidad y conéctelos al amplificador. Los cables de los altavoces de esta unidad quedan sin usar.
 - Podrá desconectar el amplificador incorporado y enviar las señales de audio solamente al(los) amplificador(es) externo(s) para obtener sonidos nítidos y evitar que se caliente el interior de la unidad. Véase la página 29 de las MANUAL DE INSTRUCCIONES (volumen separado).
 - El nivel de salida de línea de esta unidad permanece alto para que corresponda con los sonidos de alta fidelidad reproducidos por esta unidad. Cuando conecte un amplificador externo a esta unidad, disminuya el control de ganancia del amplificador externo para obtener un óptimo rendimiento de esta unidad.

Vous pouvez connecter des amplificateurs pour améliorer votre système autoradio.

- Connectez le fil de commande à distance (bleu avec bande blanche) au fil de commande à distance de l'autre appareil de façon qu'il puisse être commandé via cet appareil.
- **Pour l'amplificateur seulement:**
 - Déconnectez les enceintes de cet appareil et connectez-les à l'amplificateur. Laissez les fils d'enceintes de cet appareil inutilisés.
 - Vous pouvez désactiver l'amplificateur intégré et envoyer les signaux audio uniquement à un ou plusieurs amplificateurs extérieurs afin d'obtenir un son clair et pour éviter un échauffement interne de l'appareil. Référez-vous à la page 29 du MANUEL D'INSTRUCTIONS (volume séparé).
 - Le niveau de sortie de ligne de cet appareil est maintenu à un niveau élevé pour maintenir une qualité Hi-Fi pour les sons reproduits par cet appareil. Lors de la connexion d'un amplificateur extérieur à cet appareil, diminuez le réglage du gain sur l'amplificateur extérieur pour obtenir les meilleures performances de cet appareil.

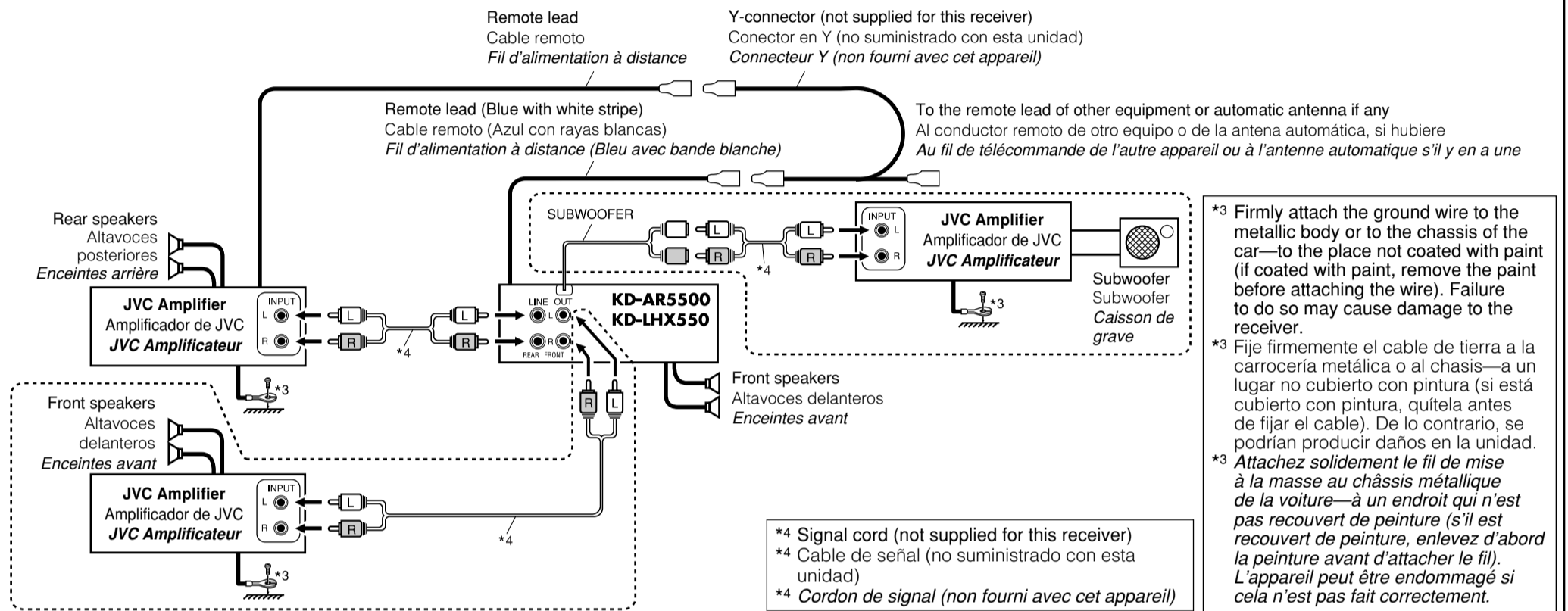

D Connecting other external components / Conexión de otros componentes externos / Connexion d'un autre appareil extérieur

JVC CD changer and DLP (Down Link Processor) / Cambiador de CD de JVC y DLP ("Down Link Processor") JVC / Changeur de CD JVC et Processeur DLP (Processeur de signaux satellite-terre) JVC

- Set "Ext Input" to "Changer" (See page 29 of the INSTRUCTIONS.) / Ajuste "Entrada" a "Changer" (Consulte la página 29 del MANUAL DE INSTRUCCIONES). / Réglez "SourceExt" sur "Changer" (Voir la page 29 du MANUEL D'INSTRUCTIONS.)
- You can connect both components in series as illustrated below.
- Podrá conectar ambos componentes en serie, tal como se observa en la ilustración de abajo.
- Vous pouvez connecter les deux appareils en série comme montré sur l'illustration.

CAUTION / PRECAUCION / PRECAUTION:

- Before connecting the CD changer and/or JVC DLP, make sure that the receiver is turned off.
- Antes de conectar el cambiador de CD y/o DLP JVC, asegúrese de que el receptor esté apagado.
- Avant de connecter votre changeur de CD et/ou votre processeur DLP JVC, assurez-vous que l'autoradio est hors tension.

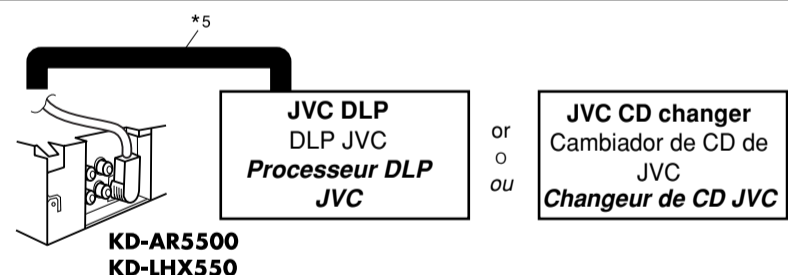
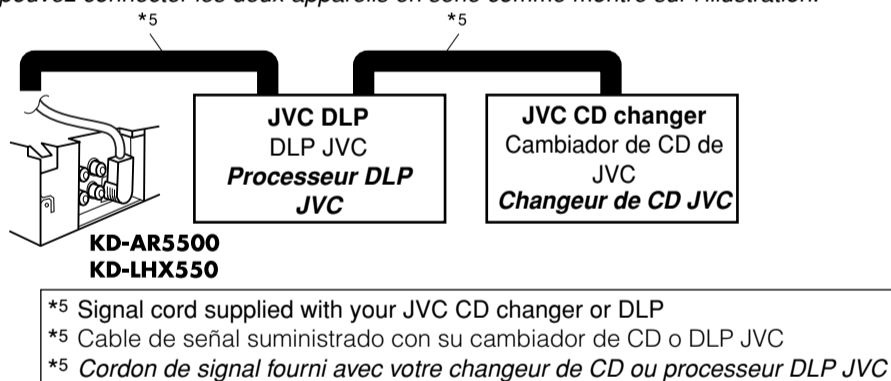

JVC PnP (Plug and Play) / PnP ("Plug and Play") JVC / PnP ("Plug and Play") JVC

- Set "Ext Input" to "Ext In" (See page 29 of the INSTRUCTIONS.) / Ajuste "Entrada" a "Ext In" (Consulte la página 29 del MANUAL DE INSTRUCCIONES). / Réglez "SourceExt" sur "Ext In" (Voir la page 29 du MANUEL D'INSTRUCTIONS.)

You can also connect JVC PnP through this receiver using JVC SIRIUS radio adapter, KS-U100K (not supplied).

- Turning on/off the receiver can also turn on/off the JVC PnP.
- También podrá conectar la PnP JVC a través de este receptor utilizando el adaptador para radio SIRIUS JVC, KS-U100K (no suministrado).
- Al encender/apagar el receptor también se enciende/apaga la PnP JVC.
- Vous pouvez aussi connecter le PnP JVC à cet autoradio en utilisant l'adaptateur de radio SIRIUS JVC KS-U100K (non fourni).
- Mettre sous/hors tension l'autoradio peut aussi mettre sous/hors tension le PnP JVC.

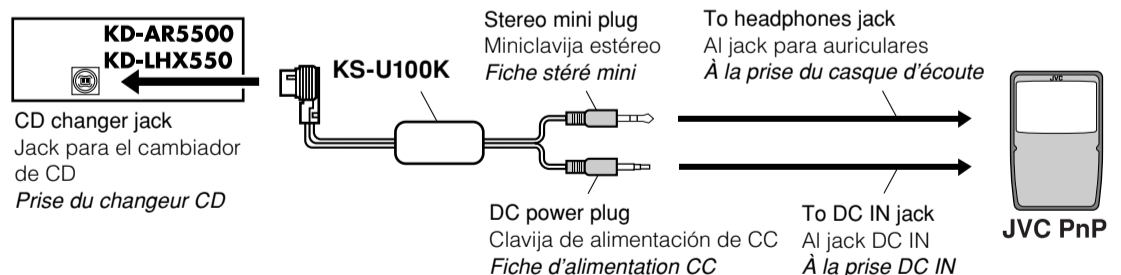

External component / Componente exterior / Appareil extérieur

- Set "Ext Input" to "Ext In" (See page 29 of the INSTRUCTIONS.) / Ajuste "Entrada" a "Ext In" (Consulte la página 29 del MANUAL DE INSTRUCCIONES). / Réglez "SourceExt" sur "Ext In" (Voir la page 29 du MANUEL D'INSTRUCTIONS.)

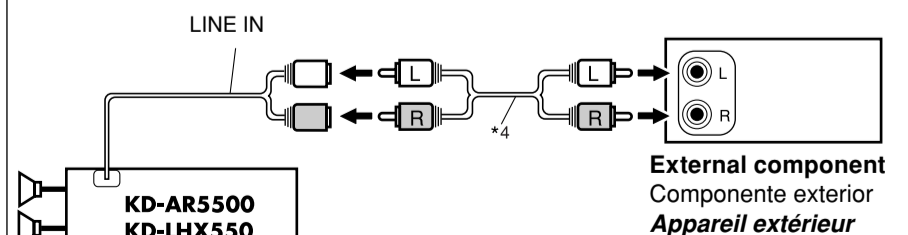
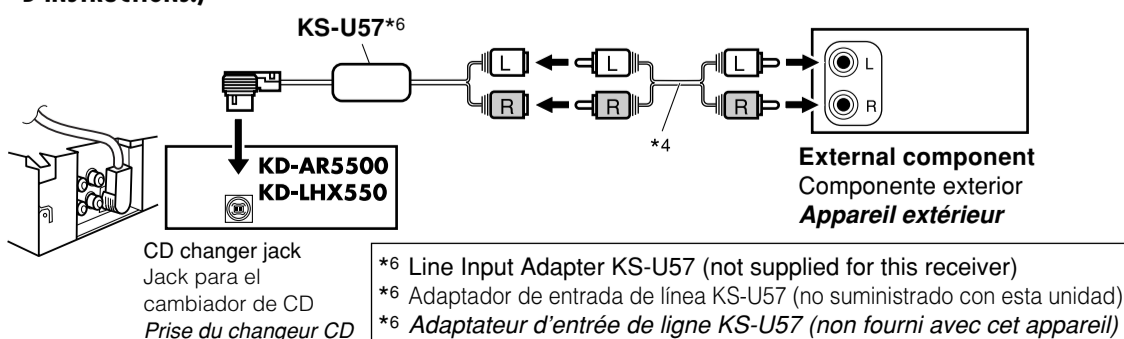

Free Manuals Download Website

<http://myh66.com>

<http://usermanuals.us>

<http://www.somanuals.com>

<http://www.4manuals.cc>

<http://www.manual-lib.com>

<http://www.404manual.com>

<http://www.luxmanual.com>

<http://aubethermostatmanual.com>

Golf course search by state

<http://golfingnear.com>

Email search by domain

<http://emailbydomain.com>

Auto manuals search

<http://auto.somanuals.com>

TV manuals search

<http://tv.somanuals.com>