

JVC

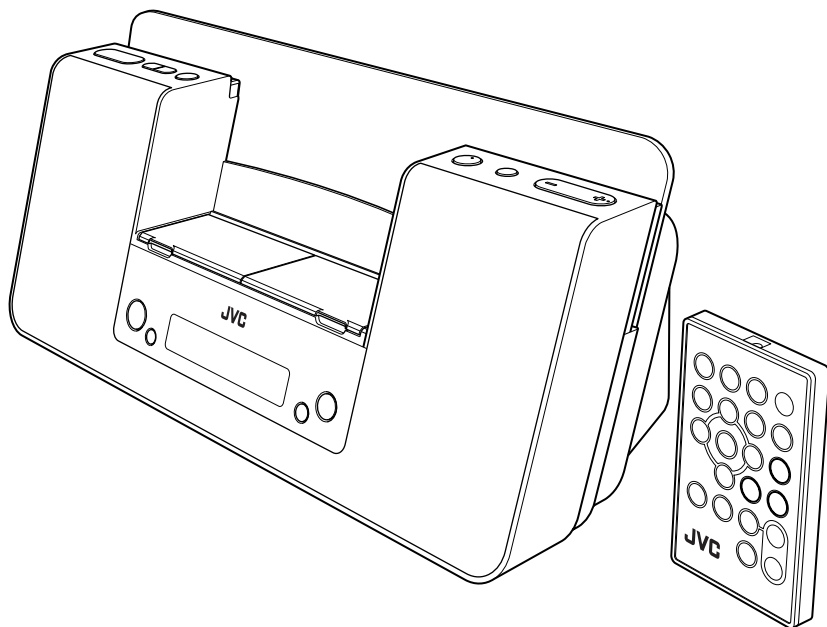

COMPACT COMPONENT SYSTEM

NX-PN10



For customer use:

Enter below the Model No. and Serial No. which are located either on the rear, bottom or side of the cabinet. Retain this information for future reference.

Model No. _____

Serial No. _____

INSTRUCTIONS

LVT2011-001A

[J]

Warnings, Cautions and Others

Mises en garde, précautions et indications diverses

CAUTION

The O/I button in any position does not disconnect the mains line.

Disconnect the mains plug to shut the power off completely (the STANDBY lamp goes off).

The MAINS plug or an appliance coupler is used as the disconnect device, the disconnect device shall remain readily operable.

- When the system is on standby, the STANDBY lamp lights red.
- When the system is turned on, the STANDBY lamp goes off.

The power can be remote controlled.

ATTENTION

La touche O/I , dans n'importe quelle position, ne déconnecte pas le système du secteur.

Déconnectez la fiche de secteur pour mettre l'appareil complètement hors tension (le témoin STANDBY s'éteint).

La fiche secteur ou un coupleur est utilisé comme dispositif de déconnexion de l'appareil, et l'appareil déconnecté doit être prêt à être utilisé.

- Quand le système est en attente, le témoin STANDBY est allumé en rouge.
- Quand le système est sous tension, le témoin STANDBY s'éteint.

L'alimentation peut être télécommandée.

CAUTION

To reduce the risk of electrical shocks, fire, etc.:

1. Do not remove screws, covers or cabinet.
2. Do not expose this appliance to rain or moisture.

ATTENTION

Afin d'éviter tout risque d'électrocution, d'incendie, etc.:

1. Ne pas enlever les vis ni les panneaux et ne pas ouvrir le coffret de l'appareil.
2. Ne pas exposer l'appareil à la pluie ni à l'humidité.

WARNING: TO REDUCE THE RISK OF FIRE OR ELECTRIC SHOCK, DO NOT EXPOSE THIS APPLIANCE TO RAIN OR MOISTURE.

For U.S.A.

This equipment has been tested and found to comply with the limits for a Class B digital device, pursuant to part 15 of the FCC Rules.

These limits are designed to provide reasonable protection against harmful interference in a residential installation.

This equipment generates, uses and can radiate radio frequency energy and, if not installed and used in accordance with the instructions, may cause harmful interference to radio communications. However, there is no guarantee that interference will not occur in a particular installation. If this equipment does cause harmful interference to radio or television reception, which can be determined by turning the equipment off and on, the user is encouraged to try to correct the interference by one or more of the following measures:

Reorient or relocate the receiving antenna. Increase the separation between the equipment and receiver.

Connect the equipment into an outlet on a circuit different from that to which the receiver is connected.

Consult the dealer or an experienced radio/TV technician for help.

CAUTION

Changes or modifications not approved by JVC could void the user's authority to operate the equipment.

For Canada/pour le Canada

THIS DIGITAL APPARATUS DOES NOT EXCEED THE CLASS B LIMITS FOR RADIO NOISE EMISSIONS FROM DIGITAL APPARATUS AS SET OUT IN THE INTERFERENCE-CAUSING EQUIPMENT STANDARD ENTITLED "DIGITAL APPARATUS," ICES-003 OF THE DEPARTMENT OF COMMUNICATIONS.

CET APPAREIL NUMERIQUE RESPECTE LES LIMITES DE BRUITS RADIOELECTRIQUES APPLICABLES AUX APPAREILS NUMIRIQUES DE CLASSE B PRESCRITES DANS LA NORME SUR LE MATERIEL BROUILLEUR; "APPAREILS NUMERIQUES", NMB-003 EDICTEE PAR LE MINISTRE DES COMMUNICATIONS.

CAUTION

Battery shall not be exposed to excessive heat such as sunshine, fire or the like.

ATTENTION

Les piles ne doivent en aucun cas être exposées à une chaleur excessive (lumière du soleil, feu, etc.).

CAUTION

- Do not block the ventilation openings or holes.
(If the ventilation openings or holes are blocked by a newspaper or cloth, etc., the heat may not be able to get out.)
- Do not place any naked flame sources, such as lighted candles, on the apparatus.
- When discarding batteries, environmental problems must be considered and local rules or laws governing the disposal of these batteries must be followed strictly.
- Do not expose this apparatus to rain, moisture, dripping or splashing and that no objects filled with liquids, such as vases, shall be placed on the apparatus.

ATTENTION

- Ne bloquez pas les orifices ou les trous de ventilation.
(Si les orifices ou les trous de ventilation sont bloqués par un journal un tissu, etc., la chaleur peut ne pas être évacuée correctement de l'appareil.)
- Ne placez aucune source de flamme nue, telle qu'une bougie, sur l'appareil.
- Lors de la mise au rebut des piles, veuillez prendre en considération les problèmes de l'environnement et suivre strictement les règles et les lois locales sur la mise au rebut des piles.
- N'exposez pas cet appareil à la pluie, à l'humidité, à un égouttement ou à des éclaboussures et ne placez pas des objets remplis de liquide, tels qu'un vase, sur l'appareil.

Caution: Proper Ventilation

To avoid risk of electric shock and fire, and to prevent damage, locate the apparatus as follows:

1. Front: No obstructions and open spacing.
2. Sides/Top/Back: No obstructions should be placed in the areas shown by the dimensions below.
3. Bottom: Place on the level surface. Maintain an adequate air path for ventilation by placing on a stand with a height of 10 cm (3-15/16") or more.

Attention: Aération correcte

Pour prévenir tout risque de décharge électrique ou d'incendie et éviter toute détérioration, installez l'appareil de la manière suivante:

1. Avant: Bien dégagé de tout objet.
2. Côtés/dessus/dessous: Assurez-vous que rien ne bloque les espaces indiqués sur le schéma ci-dessous.
3. Dessous: Posez l'appareil sur une surface plane et horizontale. Veillez à ce que sa ventilation correcte puisse se faire en le plaçant sur un support d'au moins dix centimètres de hauteur.

Front
Face

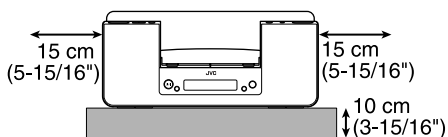

Side
Côté

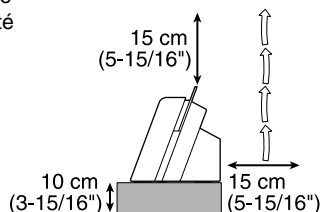

[European Union only]

[Union européenne seulement]

Contents

Introduction.....	2
Precautions	2
Getting Started	3
Connections	4
Canceling the Display Demonstration (Demo)	6
Turning on the Power Automatically (Motion Sensor)	6
Basic Operations	7
Main Unit	7
Remote Control	9
Playing Back from iPod Devices	12
Connecting iPod	13
Operations	14
Listening to FM Broadcasts	17
Basic Operations	17
Playing Back from Other Equipment	19
Connecting Other Equipment	19
Operations	19
Setting the Clock and Timer	20
Setting the Clock	20
Using Timer	20
Troubleshooting	23
Specifications	24

Introduction

Thank you for purchasing a JVC product.

Please read all instructions carefully before operation, to ensure your complete understanding and to obtain the best possible performance from the unit.

Precautions

● Installation

- Install in a place which is level, dry and neither too hot nor too cold—between 5°C and 35°C (41°F and 95°F).
- Install the unit in a location with adequate ventilation to prevent internal heat buildup inside the unit.



DO NOT install the unit in a location near heat sources, or in a place subject to direct sunlight, excessive dust or vibration.

- Leave sufficient distance between the unit and the TV.
- Keep the unit away from the TV to avoid interference with TV.

● Power Sources

- When unplugging the unit from the wall outlet, always pull on the plug, not the AC power cord.



DO NOT handle the AC power cord with wet hands.

● Internal Heat



For safety, observe the following carefully:

- Make sure there is good ventilation around the unit. Poor ventilation could overheat and damage the unit.
- DO NOT block the ventilation openings or holes. If they are blocked by a newspaper or cloth, etc., the heat may not be able to get out.

● Others

- Should any metallic object or liquid fall into the unit, unplug the AC power cord and consult your dealer before operating any further.



DO NOT disassemble the unit since there are no user serviceable parts inside.

- If you are not going to operate the unit for an extended period of time, unplug the AC power cord from the wall outlet.
If anything goes wrong, unplug the AC power cord and consult your dealer.

Getting Started

- In this manual, operations using the remote control are mainly explained; however, you can use the buttons and controls on the unit if they have the same (or similar) name and marks.
- In this manual, “iPod” means both iPod and iPhone devices. When iPhone device is especially mentioned, “iPhone” is used in this case.

Supplied Accessories

After unpacking, check to be sure that you have all the following items. The number in parentheses indicates the quantity of each piece supplied.

- Remote control (1)
- Lithium coin battery CR2025 (1) (The battery has been installed when shipped from the factory.)
- FM antenna (1)
- AC power cord (1)
- AC adaptor (1)

If anything is missing, consult your dealer immediately.

CAUTION:

To avoid risk of fire and to prevent damage.

- Do not use AC adaptors except the supplied AC adaptor.
- Do not use the supplied AC adaptor for other equipment.

Prepare the Remote Control

When you use the remote control for the first time, pull out the insulation sheet.

Front side

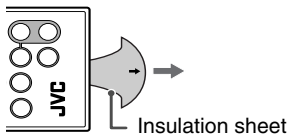

Replacing the battery in the remote control

Insert the battery into the remote control by matching the polarity (+ and -) correctly.

- If the range or effectiveness of the remote control decreases, replace the battery.

Rear side

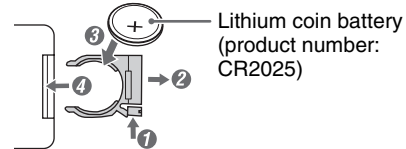

WARNINGS:

- Store the battery in a place where children cannot reach. If a child accidentally swallows the battery, consult a doctor immediately.
- Do not recharge, short, disassemble or heat the battery or dispose of it in a fire. Doing any of these things may cause the battery to give off heat, crack, or start a fire.
- Do not leave the battery with other metallic materials. Doing this may cause the battery to give off heat, crack, or start a fire.
- When throwing away or saving the battery, wrap it in tape and insulate; otherwise, the battery may start to give off heat, crack, or start a fire.
- Do not poke the battery with tweezers or similar tools. Doing this may cause the battery to give off heat, crack, or start a fire.
- Dispose of battery in the proper manner, according to federal, state, and local regulations.

CAUTION:

Danger of explosion if battery is incorrectly replaced.

Replace only with the same or equivalent type.

For USA-California only

This product contains a CR Coin Cell Lithium Battery which contains Perchlorate Material—special handling may apply.

See www.dtsc.ca.gov/hazardouswaste/perchlorate

Connections

Do not connect the AC power cord until all other connections have been made.

● Connecting the Antenna

FM antenna (supplied):

Extend it so that you can obtain the best reception.

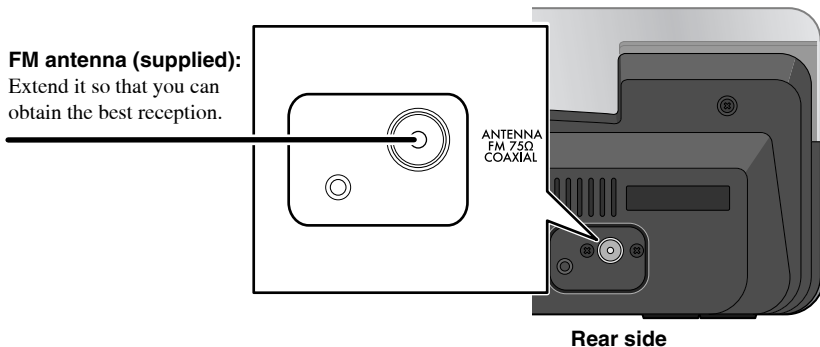

For better FM reception

Disconnect the supplied FM antenna and connect to an outdoor FM antenna using a 75 Ω wire with coaxial type connector.

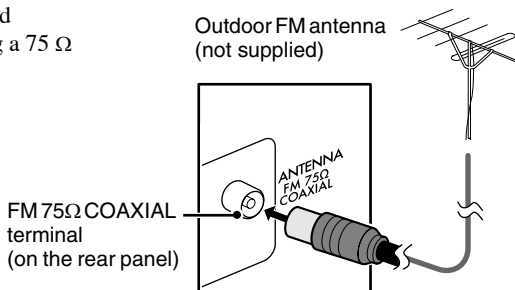

NOTES:

- Make sure the FM antenna does not touch any other terminals, connecting cords or the AC power cord. Also, keep the antenna away from metallic parts of the unit, connecting cords and the AC power cord. This could cause poor reception.

AM band is not received with this unit.

● Connecting the Video Cord to View a Video/Picture from iPod

When viewing a video/picture from iPod on your TV, use a composite video cord (not supplied) to connect the VIDEO OUT jack on the unit and the composite video input on your TV.

- After you have connected the unit, change the video input mode on your TV. For details, also refer to the instruction manual for your TV.

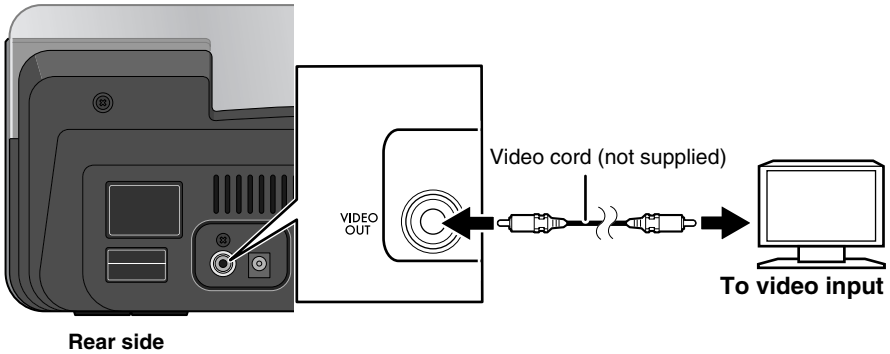

● Connecting the Power Cord

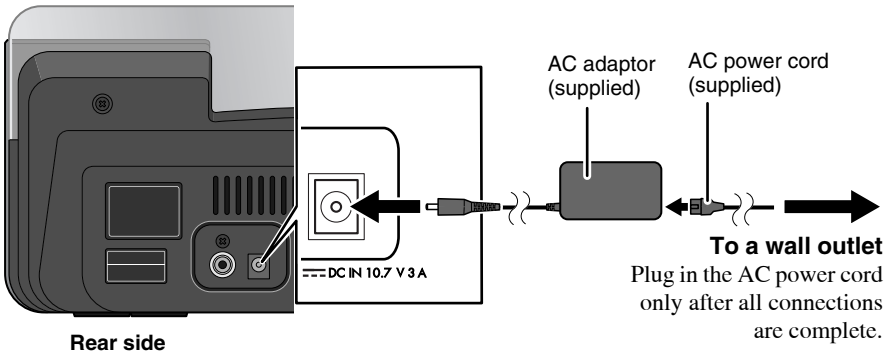

Canceling the Display Demonstration (Demo)

When you connect the AC power cord for the first time, the display demonstration starts automatically.

- When you operate the unit, the display demonstration stops temporarily. If no operation is done for about 2 minutes, the unit starts the display demonstration again.

Button	Operation
On the unit	
	Hold down until "DEMO OFF" appears on the display.

- To activate again, hold down DEMO until "DEMO ON" appears on the display.
- When ECO mode is activated (P.10), the display demonstration does not function.

Turning on the Power Automatically (Motion Sensor)

When you move your hand or an object closer to Motion sensor (P.7), the unit turns on automatically.

- iPod starts playback or an FM broadcast is received if you selected either of them last time.
- Motion Sensor works even if ECO mode is activated.

Button	Operation
On the unit	
	Press to activate Motion Sensor. " * M.S ON" appears on the display. <ul style="list-style-type: none">• When you select Clock as the display information or the unit is on standby, " * " is shown on the display (see page 10).

- To deactivate, press MOTION SENSOR. "M.S OFF" appears on the display.

NOTE:



- If the AC power cord is unplugged, Motion Sensor does not work.
- Deactivate Motion Sensor in the following cases to prevent the unit from turning on automatically:
 - when you do not use the unit for a long time
 - when you use Timer



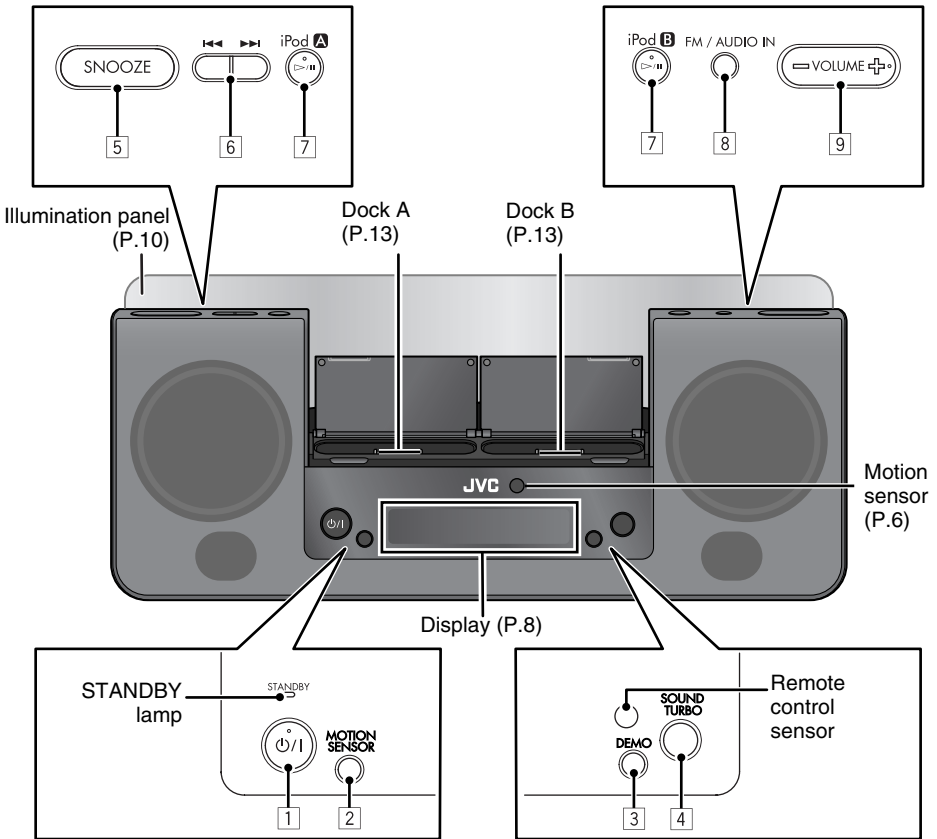





Basic Operations

Main Unit





● Operating on the Main Unit

Buttons		Operations
1		Turns on or off (standby) the power.
2		Activates or deactivates Motion Sensor (P.6).

Buttons		Operations
3		Activates or deactivates the display demonstration (P.6).
4		Adds the powerfulness to the sound (P.11).
5		Stops the timer sound and restarts it 5 minutes later (P.22).
6		<ul style="list-style-type: none"> iPod (P.14): Press: Reverse skip/forward skip. Hold down: Reverse search/forward search. FM (P.17): Tunes in to a station.
7		<ul style="list-style-type: none"> Changes the source to iPod A/iPod B (P.14). Starts playback and pauses for iPod (P.14).
8		Changes the source to FM (P.17) or AUDIO IN (P.19). 
9		Adjusts the volume level (VOL MIN/VOL 0 to VOL MAX/VOL 30).

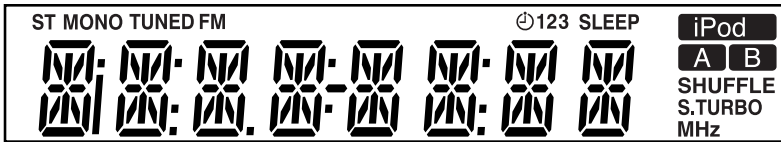
Display Information



Symbols	Description
	Lights up when iPod is connected to dock A.
	Lights up when iPod is connected to dock B.
SHUFFLE	Lights up when Shuffle Play applies to both iPod A and iPod B (P.15).
S.TURBO	Lights up when Sound Turbo is activated (P.11).
MHz	Lights up when FM frequency is indicated.

Symbols	Description
ST	Lights up when FM stereo broadcast is received.
MONO	Lights up when FM monaural reception mode is activated.
TUNED	Lights up when an FM station of sufficient signal strength is tuned in.
FM	Lights up when FM is selected as the source.
1/2/3	<ul style="list-style-type: none"> Lights up when Timer is set (P.21). 1/2/3 icon flashes while Timer is working.
SLEEP	Lights up when Sleep Timer is activated (P.11).



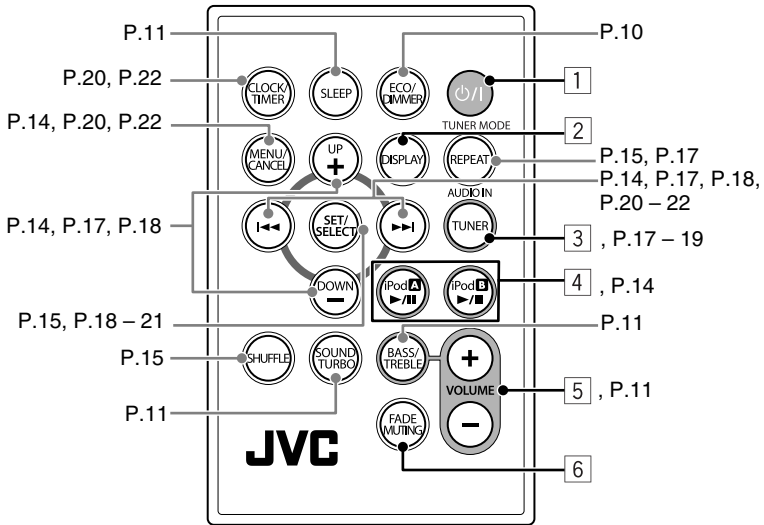

Remote Control



Operating on the Remote Control

Basic operations

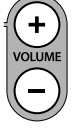
Buttons	Main operations
<div style="border: 1px solid black; padding: 2px; display: inline-block;">1</div>	Turns on or off (standby) the power.

Buttons		Main operations
2		<p>Changes the display information.</p> <ul style="list-style-type: none"> For iPod A/iPod B/AUDIO IN: <ul style="list-style-type: none"> Source name → Clock Day of the week ← When the unit is turned off: <ul style="list-style-type: none"> Clock ↔ Day of the week For FM: <ul style="list-style-type: none"> Frequency → Clock Day of the week ←
3		Changes the source to FM (P.17) or AUDIO IN (P.19).
4		<ul style="list-style-type: none"> Changes the source to iPod A/iPod B (P.14). Starts playback and pauses for iPod (P.14).
5		Adjusts the volume level (VOL MIN/VOL 0 to VOL MAX/VOL 30).
6		<p>Drops the volume in a moment.</p> <ul style="list-style-type: none"> To restore the volume, press again or adjust the volume level.

■ To dim the display and illumination panel—DIMMER

You can change the brightness of the display and illumination panel.

Press repeatedly.

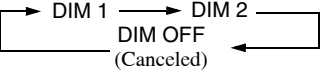



DIM 1: Dims the display and illumination panel.
DIM 2: Dims the display much more than “DIM 1” and turns off the illumination panel.

- Dimmer is canceled when you turn off the unit.

■ To activate ECO mode

Activating ECO mode allows you to reduce power consumption by turning off the display while on standby.



Press while the unit is on standby. “ECO ON” appears on the display for a while.

- The clock is not shown on the display when the unit is on standby.

- To cancel the mode, press ECO/DIMMER again. “ECO OFF” appears for a while then the clock is shown on the display.
- **The battery of iPod is not charged in ECO mode.**

■ To turn off the unit after a certain period of time—Sleep Timer

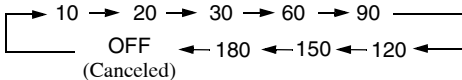
	Press repeatedly to specify the time (in minutes) as follows: 
--	--

- To check the time remaining before the shut-off time, press SLEEP once. If you press the button repeatedly, you can change the shut-off time.

■ To emphasize the sound—Sound Turbo



You can add the powerfulness to the sound.

	Press to activate Sound Turbo. ⇒ “S-TURBO” appears for a while and S.TURBO lights up on the display.
--	---

- To cancel, press SOUND TURBO again. “OFF” appears on the display.

■ To adjust the tone

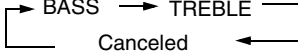
You can adjust the bass and treble levels.

1 	Select the item you want to adjust. 
2 	Adjust the bass or treble level (-5 to +5).

Playing Back from iPod Devices

You can connect 2 iPod devices to the unit and enjoy sound and video from them.

Compatible iPod Models:

iPod model	Audio	Video
iPod nano 1GB/2GB/4GB	√	—
iPod nano (2nd Generation) 2GB/4GB/8GB	√	—
iPod nano (3rd Generation) 4GB/8GB	√	√
iPod nano (4th Generation) 8GB/16GB	√	√
iPod mini 4GB	√	—
iPod mini (2nd Generation) 4GB/ 6GB	√	—
iPod (4th Generation) 20GB/40GB	√	—
iPod photo (4th Generation) 20GB/30GB/40GB/60GB	√	√*
iPod video (5th Generation) 30GB/60GB/80GB	√	√
iPod classic 80GB/120GB/160GB	√	√
iPod touch 8GB/16GB/32GB	√	√
iPod touch (2nd Generation) 8GB/16GB/32GB	√	√
iPhone 4GB/8GB/16GB	√	√
iPhone (3G) 4GB/8GB/16GB	√	√

* Only for still picture.

If iPod does not play correctly, update iPod software to the latest version.

• For details about updating iPod, check on the Apple web site <<http://www.apple.com>>.

• **JVC does not assure the compatibility of iPod released after April 2009 with this unit.**

- iPod is a trademark of Apple Inc., registered in the U.S. and other countries.
- iPhone is a trademark of Apple Inc.
- “Made for iPod” means that an electronic accessory has been designed to connect specifically to iPod and has been certified by the developer to meet Apple performance standards.
- “Works with iPhone” means that an electronic accessory has been designed to connect specifically to iPhone and has been certified by the developer to meet Apple performance standards.
- Apple is not responsible for the operation of this device or its compliance with safety and regulatory standards.

Connecting iPod

Connect iPod to dock A or B on the unit.

You can have 2 iPod devices connected at the same time.

- Make sure the unit is on standby when you connect iPod.

1.

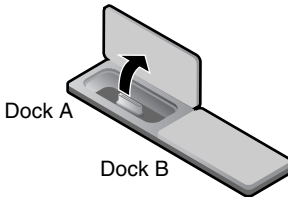

2.

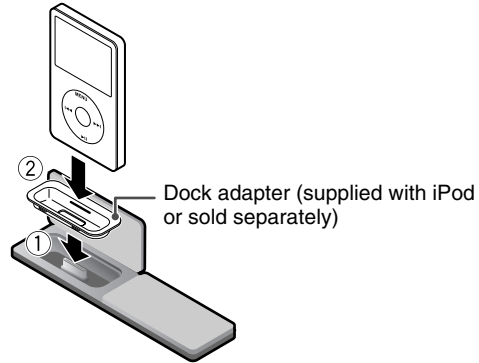

To detach the dock adapter from the dock:

Pull up the dock adapter with your fingernail or a sharp-pointed tool using the slot.

- Be careful not to injure your fingertips or damage the terminal of the dock.

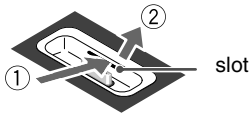

NOTES:

- Be careful not to damage the terminal on the dock when connecting/disconnecting iPod.
- Close the cover of the dock when you do not connect iPod to the unit.

About the battery charge of iPod

The battery of iPod is always charged through the unit except when the unit is in ECO mode (see page 10).











- When 2 iPod devices are connected, both batteries are charged at the same time.
- For details of the battery charging, see the instruction manual for iPod.

Operations

For details, also refer to the instruction manual for iPod.



NOTES:

- Before viewing a video/picture from iPod on your TV, make the appropriate video setting on iPod. For details of the setting, see the instruction manual for iPod.
- For iPhone and iPod touch
Operate iPhone or iPod touch itself in the following cases:
 - when operating the home button
 - when selecting application icons on the home screen
 - when dragging the slider

Buttons		Operations	Control of iPod
On the unit	On the remote		
		Press: – Selects iPod A /iPod B as the source and starts playback. – Starts playback/pauses. Hold down* ¹ : Puts iPod in sleep mode.	
		Press: Forward skip Hold down: Forward search	
		Press: Reverse skip/Return to the beginning of the current track. Hold down: Reverse search	
—		Goes back to the previous menu/screen.	MENU* ²
—		Selects an item on the menu/screen. – Press: Selects an item. – Hold down: Scrolls through a list. To stop scrolling, press either one of the buttons. <ul style="list-style-type: none"> • For iPhone and iPod touch: The buttons work after starting “Music” or “Videos” by tapping the corresponding application icon on the home screen of iPhone and iPod touch. • For iPod devices other than above: The buttons work in the same way as operating the click wheel of iPod counterclockwise/clockwise. 	Click wheel* ²

*¹ Not available for iPhone and iPod touch.

*² Not equipped with iPhone and iPod touch.

Buttons		Operations	Control of iPod
On the unit	On the remote		
—		Confirms an item on the menu/screen.	Center button*
—		<p>Press: Applies Shuffle Play to iPod A or iPod B selected as the source. Select the desired shuffle mode. ⇨ “SHUFFLE” appears for a while.</p> <ul style="list-style-type: none"> • The shuffle icon lights up on the display of iPod. • To cancel, press again until the shuffle icon disappears. <p>Hold down: Applies Shuffle Play to both iPod A and iPod B if connected. Select the desired shuffle mode. ⇨ “SHUFFLE” appears for a while and SHUFFLE lights up on the display.</p> <ul style="list-style-type: none"> • The shuffle icon lights up on the display of both iPod devices. • To cancel, press again until the shuffle icon disappears. 	—
—	TUNER MODE 	<p>Applies Repeat Play to iPod selected as the source. Select the desired repeat mode. ⇨ “REPEAT” appears on the display for a while.</p> <ul style="list-style-type: none"> • The repeat icon lights up on the display/screen of iPod. • To cancel, press again until the repeat icon disappears. 	—

* Not equipped with iPhone and iPod touch.











NOTES:

- **JVC is not responsible for any loss of or damage to iPod that might result from the use of this product.**
- Do not touch or hit the terminals of the dock and of iPod. It might cause damage to these terminals.
- When you connect iPod to the dock, make sure the terminal on the dock is fully inserted into iPod.
- Always set the volume to the minimum level when connecting or disconnecting iPod.
- Do not carry the unit with iPod connected. You might drop it down or it might cause damage to the connector part.
- Sound distortion may occur when playing back audio sources with a high recording level. When distortion occurs, it is recommended to turn off the equalizer of iPod. For information on operating iPod, see the instruction manual for iPod.
- Turn off the unit when disconnecting iPod.
- Remove iPod from the dock when you do not use it.
- When you cannot operate iPod connected through the unit or using the remote control, operate iPod itself.
- After connecting iPod, wait until the unit is ready for operation (about 3 seconds).

Listening to FM Broadcasts







Basic Operations

Buttons		Operations
On the unit	On the remote	
FM / AUDIO IN 	AUDIO IN TUNER 	Selects FM as the source.  When an FM program is broadcasted in stereo, ST (stereo) lights up on the display (only when the reception is good).
		Press: Changes the frequency. Hold down and release: The unit starts searching for stations and stops when a station of sufficient signal strength is found. • To stop searching, press again.
—	 	Tunes in to a preset station: Press repeatedly to select a preset station number. (For presetting stations, see page 18.)
—	TUNER MODE 	Changes the FM reception mode: When an FM stereo broadcast is hard to receive or noisy, press to improve reception. MONO (monaural) lights up on the display. Reception will improve though the stereo effect is lost. • To restore the stereo effect, press again.

AM band is not received with this unit.

● Presetting Stations

You can preset 30 FM stations.

1		Select FM as the source.
2	 	Tune in to the station you want to preset. • You can also store the monaural reception mode for FM preset stations if selected.
3		Activate the preset number entry mode. ⇨ “SET” flashes on the display for a few seconds. • Complete the following operations while the indication is flashing.
4	 	Select a preset number for the station you want to store.
5		Store the station. ⇨ “STORED” appears on the display for a while.

NOTES:

- When you unplug the AC power cord or if a power failure occurs, the preset stations will be erased in a few days.
- If you store a new station onto an occupied preset number, the station previously stored on that number will be erased.

Playing Back from Other Equipment

Connecting Other Equipment

By using a stereo mini plug cord (not supplied), you can connect other equipment with analog audio output jacks, such as a portable audio player, etc.

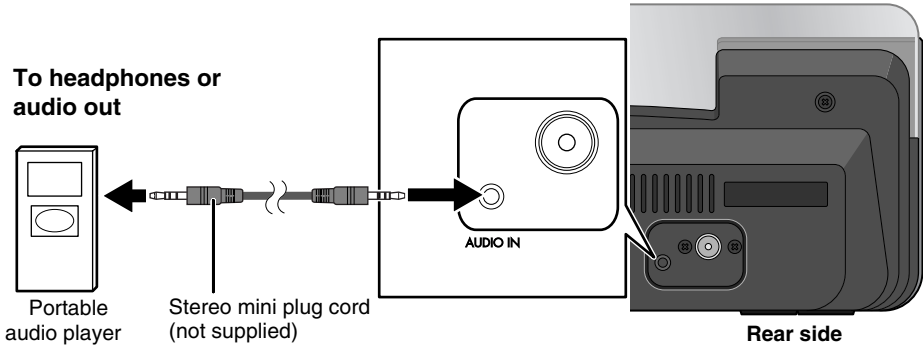



- Refer to the instruction manual supplied with the equipment.

NOTE:

Make sure the unit is on standby when connecting or disconnecting other equipment.



Operations

To Listen to Other Equipment

1	 Select AUDIO IN as the source.	
2	Start playing the equipment.	

To Adjust the Sound Input Level from the Equipment

You can adjust the sound input level from the connected equipment if the incoming signal is too weak or too strong.

1	 Select AUDIO IN as the source.	
2	 Hold down to adjust the sound input level.	
	LEVEL 1: Ordinary input level. LEVEL 2: Increases the input level. LEVEL 3: Increases the input level more than "LEVEL 2."	

Setting the Clock and Timer

Setting the Clock

Set the built-in clock before using Timer.

- You can set the clock when the unit is turned on or on standby.

1



Activate the clock setting mode.

⇒ “ADJCLOCK” appears then the hour digit of the time indication flashes on the display.

- If you have already set the clock before, press the button twice to activate the clock setting mode.

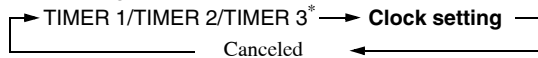

* See “Using Timer”.

2

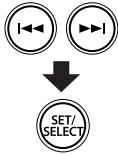

① Set the hour while the hour digits of the time indication flashes on the display.

② Set the minute while the minute digits of the time indication flashes on the display.

③ Select the day of the week.

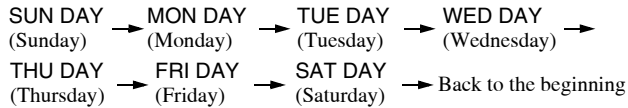

⇒ “CLOCK OK” appears and the built-in clock starts working.

- To exit from the clock setting, press CLOCK/TIMER as required.
- To correct a misentry during the process, press MENU/CANCEL. You can return to the previous step.
- If a power failure occurs, the clock loses the setting and is reset to “AM12:00.” You need to adjust the clock again.

Using Timer

Using Timer, you can wake up with music, etc.

- **Deactivate Motion Sensor when you use Timer (P.6) .**



- When using iPod or other equipment as the playback source, connect it to the unit beforehand. (P.13, P.19)
- You can set Timer when the unit is turned on or on standby.
- The unit is turned off automatically 2 hours after it is turned on by Timer.

1





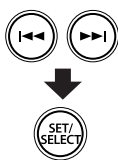
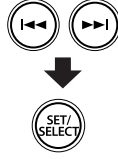
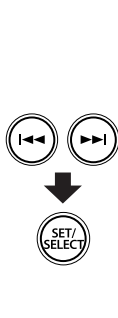
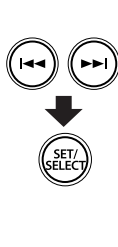

Activate the timer setting mode.

⇒ “TIMER 1,” “TIMER 2” or “TIMER 3” appears on the display.

<p>2</p> 	<p>Select Timer you want to set.</p> <p>TIMER 1 → TIMER 2 ← TIMER 3</p>
<p>3</p> 	<p>Select Timer type.</p> <p>WEEKLY ↔ ONCE</p> <p>WEEKLY: See step 4 below. ONCE: Timer works once on a selected day of the week.</p>
<p>4</p> 	<p>Select the desired day of the week.</p> <ul style="list-style-type: none"> When “WEEKLY” is selected in step 3: <ul style="list-style-type: none"> SUN DAY → MON DAY → TUE DAY → WED DAY → THU DAY → FRI DAY → SAT DAY → MON-FRI → MON-SAT → EVERYDAY → Back to the beginning SUN DAY to SAT DAY: Timer works every week on the selected day. MON-FRI: Timer works from Monday to Friday every week. MON-SAT: Timer works from Monday to Saturday every week. EVERYDAY: Timer works everyday. When “ONCE” is selected in step 3: <ul style="list-style-type: none"> SUN DAY → MON DAY → TUE DAY → WED DAY → THU DAY → FRI DAY → SAT DAY → Back to the beginning
<p>5</p> 	<p>① Adjust the hour then the minute for the on-time.</p> <p>② Select the playback source—“iPod A,” “iPod B,” “FM” or “AUDIO IN.”</p> <ul style="list-style-type: none"> When “FM” is selected, select the preset number of the station you want to listen to. When you select “FM — —” the preset station you last tuned in is set. (See “Listening to FM Broadcasts” on page 17.) <p>③ Select the volume level.</p> <p>⇨ “SET OK” appears followed by the setting information, then the  icon and the timer number indicator (1/2/3) light up on the display.</p>
<p>6</p> 	<p>Turn off the unit (on standby).</p>

- To exit from Timer setting, press CLOCK/TIMER as required.
- To correct a misentry during the process, press MENU/CANCEL. You can return to the previous step.

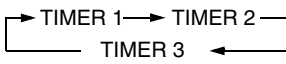
● To Cancel Timer

1  ↓  	Select Timer you want to cancel. 
2 	“CANCEL” flashes on the display. ⇒ The  icon and the timer number indicator (1/2/3) disappear.

NOTE:

The settings you have made are memorized though you cancel Timer.

● To Turn off the Timer Sound briefly—Snooze

Using Snooze, you can have the timer sound stop and restart it 5 minutes later.

1	Set Timer following the steps 1 to 6 on pages 20 and 21.
2 	When the timer sound starts, press SNOOZE. The unit turns off for 5 minutes to stop the timer sound. Timer remains activated. <ul style="list-style-type: none">• “SNOOZE” flashes on the display while the unit turns off.• 5 minutes later, the unit turns on and the timer sound restarts automatically.• To stop the timer sound again, press SNOOZE.• After stopping the timer sound 10 times by pressing SNOOZE, Snooze is canceled.

• When the timer sound starts:

- If you do not press SNOOZE within 3 minutes after the timer sound starts, Snooze does not work.
- When you turn off the unit by pressing , Snooze does not work.

Troubleshooting

If you have a problem with your unit, check this list for a possible solution before calling for service.

● General

Power does not come on.

- ⇒ The power plug is not inserted securely. Plug it in securely (P.5).

Power turns on even though you turned off.

- ⇒ Motion Sensor is activated (P.6).

Adjustments or settings are suddenly canceled before you finish.

- ⇒ There is a time limit. Repeat the procedure again.

Operations are disabled.

- ⇒ The built-in microprocessor may malfunction due to external electrical interference. Unplug the AC power cord and then plug it back in.

Cannot view a video/picture from iPod on the TV.

- ⇒ Connect a composite video cord securely to your TV (P.5).
- ⇒ Change the video input mode on your TV. For details, refer to the instruction manual for your TV.

Unable to operate the unit from the remote control.

- ⇒ The path between the remote control and the remote sensor on the unit is blocked.
- ⇒ Point it at the remote sensor on the front panel.
- ⇒ Signals cannot reach the remote sensor. Move closer to the unit.
- ⇒ The batteries are exhausted.
- ⇒ Pull out the insulation sheet (P.3).

The unit is suddenly turned off.

- ⇒ The unit is turned off automatically 2 hours after it is turned on by Timer (P.20).

● iPod Operations

iPod doesn't play though iPod /iPod lights up on the display.

- ⇒ The battery is empty. Leave it connected for more than 10 minutes.

The battery of iPod cannot be charged through the unit.

- ⇒ The unit is in ECO mode. Cancel the mode (P.10, P.13).

● Radio Operations

Hard to listen to broadcasts because of noise.

- ⇒ The FM antenna connection is incorrect or loose (P.4).
- ⇒ The FM antenna is not properly extended and positioned (P.4).

● Timer Operations

Timer does not work.

- ⇒ Timer starts working only when the unit is turned off (standby).
- ⇒ A power failure may have occurred. Set the clock first, then Timer again (P.20, P.21).

Timer sound starts working again.

- ⇒ Snooze is activated (P.22).

Snooze does not work.

- ⇒ If you do not press SNOOZE within 3 minutes after the timer sound starts, Snooze does not work (P.22).

Specifications



Accessories

See page 3.

Amplifier

Output Power

10 W (5W+5W) at 8 Ω (10% THD)

Terminals

AUDIO IN

Input Sensitivity/Impedance (1 kHz):

LEVEL 1: 500 mV/47 k Ω

LEVEL 2: 315 mV/47 k Ω

LEVEL 3: 125 mV/47 k Ω

Dock A and B for iPod/iPhone

Compatible iPod/iPhone models:

See page 12.

Output power (each iPod dock):

DC 5 V \equiv 500 mA

VIDEO OUT (For iPod/iPhone)

Composite

Tuner

FM tuning range:

87.5 MHz – 108.0 MHz

(100 kHz channel space)

Main Unit

Dimensions (W/H/D):

326 mm \times 135 mm \times 130 mm

(12-7/8 inches \times 5-3/8 inches \times 5-1/8 inches)

Mass:

Approx. 1.6 kg (3.6 lbs)

Speaker Specifications

Type:

Full range bass-reflex type

Speakers:

7 cm (2-13/16 inches) cone \times 2

Impedance:

8 Ω

Power Specifications

Power Source:

DC 10.7 V \equiv 3 A (EXTERNAL DC IN)

AC Adaptor (AA-R1001)

INPUT:

AC 110 – 240 V \sim , 50/60 Hz 1A

OUTPUT:

DC 10.7 V \equiv 3 A

Power Consumption:

18 W (power on mode)

1.5 W or less (in Standby mode)

0.8 W or less (in ECO mode)

10 W (in Standby mode, with two iPod devices connected.)

Design and specifications are subject to change without notice.

TO OUR VALUED CUSTOMER ———

THANK YOU FOR PURCHASING THIS JVC PRODUCT.
WE WANT TO HELP YOU ACHIEVE A PERFECT EXPERIENCE.

**NEED HELP ON HOW TO HOOK UP?
NEED ASSISTANCE ON HOW TO OPERATE?
NEED TO LOCATE A JVC SERVICE CENTER?
LIKE TO PURCHASE ACCESSORIES?**

JVC[®] IS HERE TO HELP!
TOLL FREE: 1(800)252-5722
<http://www.jvc.com>

Remember to retain your Bill of Sale for Warranty Service.

————— **Do not attempt to service the product yourself** —————

Caution

To prevent electrical shock, do not open the cabinet.
There are no user serviceable parts inside.
Please refer to qualified service personnel for repairs.



LIMITED WARRANTY

1-1 **USA ONLY**

ONLY FOR PRODUCT PURCHASED IN U.S.A.

JVC Americas Corp. (JVC) warrants this product and all parts thereof, except as set forth below ONLY TO THE ORIGINAL RETAIL PURCHASER to be FREE FROM DEFECTIVE MATERIALS AND WORKMANSHIP from the date of original purchase for the period shown below. ("The Warranty Period")

PARTS	1 YR	LABOR	1 YR
-------	-------------	-------	-------------

THIS LIMITED WARRANTY IS VALID ONLY IN THE FIFTY (50) UNITED STATES, THE DISTRICT OF COLUMBIA AND IN THE COMMONWEALTH OF PUERTO RICO.

WHAT WE WILL DO:

If this product is found to be defective within the warranty period, JVC will repair or replace defective parts with new or rebuilt equivalents at no charge to the original owner. Such repair and replacement services shall be rendered by JVC during normal business hours at JVC authorized service centers. Parts used for replacement are warranted only for the remainder of the Warranty Period. All products may be brought to a JVC authorized service center on a carry-in basis. Color televisions with a screen size of 37" class or greater qualify for in-home service. In such cases, a technician will come to your home and either repair the TV there or remove and return it if it cannot be repaired in your home.

WHAT YOU MUST DO FOR WARRANTY SERVICE:

Please do not return your product to the retailer

Instead, return your product to the JVC authorized service center nearest you. If shipping the product to the service center, please be sure to package it carefully, preferably in the original packaging, and include a brief description of the problem(s). Please call 1-800-252-5722 to locate the nearest JVC authorized service center. Service locations can also be obtained from our website <http://www.jvc.com>. If your product qualifies for in-home service, the service representative will require clear access to the product.

If you have any questions concerning your JVC Product, please contact our Customer Care Center at 800-252-5722

WHAT IS NOT COVERED:

This limited warranty provided by JVC does not cover:

- Products which have been subject to abuse, accident, alteration, modification, tampering, negligence, misuse, faulty installation, lack of reasonable care, or if repaired or serviced by anyone other than a service facility authorized by JVC to render such service, or if affixed to any attachment not provided with the products, or if the model or serial number has been altered, tampered with, defaced or removed;
- Initial installation, installation and removal from cabinets or mounting systems.
- Operational adjustments covered in the Owner's Manual, normal maintenance, video and audio head cleaning;
- Damage that occurs in shipment, due to act of God, and cosmetic damage;
- Signal reception problems and failures due to line power surge;
- User Removal Memory Devices/Video Pick-up Tubes/CCD Image Sensors are covered for 90 days from the date of purchase;
- Accessories;
- Batteries (except that Rechargeable Batteries are covered for 90 days from the date of purchase);
- Products used for commercial purposes, including, but not limited to rental.
- Loss of data resultant from malfunction of hard drive or other data storage device;

There are no express warranties except as listed above.

THE DURATION OF ANY IMPLIED WARRANTIES, INCLUDING THE IMPLIED WARRANTY OF MERCHANTABILITY, IS LIMITED TO THE DURATION OF THE EXPRESS WARRANTY HEREIN.

JVC SHALL NOT BE LIABLE FOR ANY LOSS OF USE OF THE PRODUCT, INCONVENIENCE, OR ANY OTHER DAMAGES, WHETHER DIRECT, INCIDENTAL OR CONSEQUENTIAL (INCLUDING, WITHOUT LIMITATION, DAMAGE TO TAPES, RECORDS OR DISCS) RESULTING FROM THE USE OF THIS PRODUCT, OR ARISING OUT OF ANY BREACH OF THIS WARRANTY. ALL EXPRESS AND IMPLIED WARRANTIES, INCLUDING THE WARRANTIES OF MERCHANTABILITY AND FITNESS FOR PARTICULAR PURPOSE, ARE LIMITED TO THE WARRANTY PERIOD SET FORTH ABOVE.

Some states do not allow the exclusion of incidental or consequential damages or limitations on how long an implied warranty lasts, so these limitations or exclusions may not apply to you. This warranty gives you specific legal rights and you may also have other rights which vary from state to state.

JVC AMERICAS CORP.

1700 Valley Road, Wayne, New Jersey 07470
<http://www.jvc.com>

REFURBISHED PRODUCTS CARRY A SEPARATE WARRANTY, THIS WARRANTY DOES NOT APPLY. FOR DETAIL OF REFURBISHED PRODUCT WARRANTY, PLEASE REFER TO THE REFURBISHED PRODUCT WARRANTY INFORMATION PACKAGED WITH EACH REFURBISHED PRODUCT.

For customer use:

Enter below the Model No. and Serial No. which is located either on the rear, bottom or side of the cabinet. Retain this information for future reference.

Model No. : _____

Serial No. : _____

Purchase date : _____

Name of dealer : _____

JVC

Free Manuals Download Website

<http://myh66.com>

<http://usermanuals.us>

<http://www.somanuals.com>

<http://www.4manuals.cc>

<http://www.manual-lib.com>

<http://www.404manual.com>

<http://www.luxmanual.com>

<http://aubethermostatmanual.com>

Golf course search by state

<http://golfingnear.com>

Email search by domain

<http://emailbydomain.com>

Auto manuals search

<http://auto.somanuals.com>

TV manuals search

<http://tv.somanuals.com>