

JVC

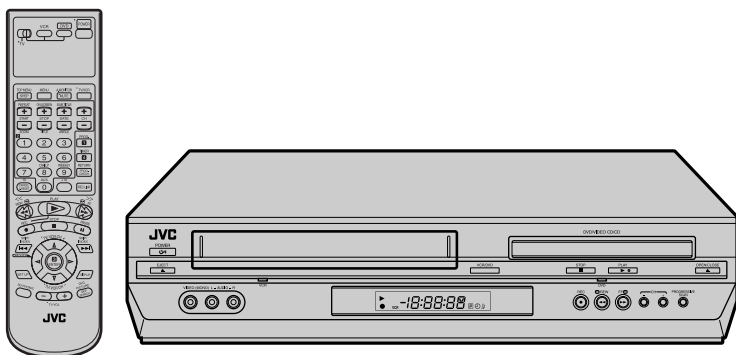

DVD PLAYER & VIDEO CASSETTE RECORDER

HR-XVC37U



Hi-Fi

VHS

SQPB

DVD
VIDEO

dtc
2.0+DIGITAL OUT

DOLBY
DIGITAL

COMPACT
disc
DIGITAL VIDEO

COMPACT
disc
DIGITAL AUDIO

COMPACT
disc
SUPER VIDEO

3D
3D-PHONIC

INSTRUCTIONS

For Customer Use:

Enter below the Model No. and
Serial No. which are located on the
rear of cabinet. Retain this
information for future reference.

Model No. _____



Serial No. _____

LPT0896-001B

Dear Customer,

Thank you for purchasing the JVC DVD player & VHS video cassette recorder. Before use, please read the safety information and precautions to ensure safe use of your new unit.

CAUTIONS

	CAUTION RISK OF ELECTRIC SHOCK DO NOT OPEN	
<p>CAUTION: TO REDUCE THE RISK OF ELECTRIC SHOCK, DO NOT REMOVE COVER (OR BACK). NO USER-SERVICEABLE PARTS INSIDE. REFER SERVICING TO QUALIFIED SERVICE PERSONNEL.</p>		



The lightning flash with arrowhead symbol, within an equilateral triangle, is intended to alert the user to the presence of uninsulated "dangerous voltage" within the product's enclosure that may be of sufficient magnitude to constitute a risk of electric shock to persons.



The exclamation point within an equilateral triangle is intended to alert the user to the presence of important operating and maintenance (servicing) instructions in the literature accompanying the appliance.

WARNING:

TO PREVENT FIRE OR SHOCK HAZARD, DO NOT EXPOSE THIS UNIT TO RAIN OR MOISTURE.

CAUTION:

This unit should be used with AC 120V~, 60Hz only. To prevent electric shocks and fire hazards, DO NOT use any other power source.

CAUTION:

TO PREVENT ELECTRIC SHOCK, MATCH WIDE BLADE OF PLUG TO WIDE SLOT, FULLY INSERT.

ATTENTION:

POUR ÉVITER LES CHOCS ÉLECTRIQUES, INTRODUIRE LA LAME LA PLUS LARGE DE LA FICHE DANS LA BORNE CORRESPONDANTE DE LA PRISE ET POUSSER JUSQU'AU FOND.

Note to CATV system installer:

This reminder is provided to call the CATV system installer's attention to Article 820-40 of the NEC that provides guidelines for proper grounding and, in particular, specifies that the cable ground shall be connected to the grounding system of the building, as close to the point of cable entry as practical.

CAUTION:

Changes or modifications not approved by JVC could void user's authority to operate the equipment.

CAUTION:

THIS PRODUCT USES A LASER SYSTEM. USE OF CONTROLS OR ADJUSTMENTS OR PERFORMANCE OF PROCEDURES OTHER THAN THOSE SPECIFIED HEREIN MAY RESULT IN HAZARDOUS RADIATION EXPOSURE. DO NOT OPEN COVERS AND DO NOT REPAIR YOURSELF. REFER SERVICING TO QUALIFIED PERSONNEL.

CLASS 1 LASER PRODUCT
REPRODUCTION OF LABELS
WARNING LABEL INSIDE OF THE UNIT

CAUTION	- VISIBLE OR INVISIBLE LASER RADIATION WHEN OPEN. DO NOT STARE INTO BEAM.
ATTENTION	- RAYONNEMENT LASER VISIBLE OU INVISIBLE EN CAS D'OUVERTURE. NE PAS REGARDER DANS LE FAISCEAU.
	LP41077-002A

Declaration of Conformity

Model Number: HR-XVC37U
Trade Name: JVC
Responsible Party: JVC Americas Corp.
Address: 1700 Valley Road Wayne, N.J. 07470
Telephone Number: 973-317-5000

This device complies with Part 15 of FCC Rules. Operation is subject to the following two conditions:

- (1) This device may not cause harmful interference, and (2) this device must accept any interference received, including interference that may cause undesired operation.

This equipment has been tested and found to comply with the limits for a Class B digital device, pursuant to Part 15 of the FCC Rules. These limits are designed to provide reasonable protection against harmful interference in a residential installation. This equipment generates, uses, and can radiate radio frequency energy and, if not installed and used in accordance with the instructions, may cause harmful interference to radio communications. However, there is no guarantee that interference will not occur in a particular installation. If this equipment does cause harmful interference to radio or television reception, which can be determined by turning the equipment off and on, the user is encouraged to try to correct the interference by one or more of the following measures:

- Reorient or relocate the receiving antenna.
- Increase the separation between the equipment and receiver.
- Connect the equipment into an outlet on a circuit different from that to which the receiver is connected.
- Consult the dealer or an experienced radio/TV technician for help.

IMPORTANT PRODUCT SAFETY INSTRUCTIONS

Electrical energy can perform many useful functions. But improper use can result in potential electrical shock or fire hazards. This product has been engineered and manufactured to assure your personal safety. In order not to defeat the built-in safeguards, observe the following basic rules for its installation, use and servicing.

ATTENTION

Follow and obey all warnings and instructions marked on your product and its operating instructions. For your safety, please read all the safety and operating instructions before you operate this product and keep this booklet for future reference.

INSTALLATION

1. Grounding or Polarization

(A) Your product may be equipped with a polarized alternating-current line plug (a plug having one blade wider than the other). This plug will fit into the power outlet only one way. This is a safety feature.

If you are unable to insert the plug fully into the outlet, try reversing the plug. If the plug should still fail to fit, contact your electrician to replace your obsolete outlet. Do not defeat the safety purpose of the polarized plug.

(B) Your product may be equipped with a 3-wire grounding-type plug, a plug having a third (grounding) pin. This plug will only fit into a grounding-type power outlet. This is a safety feature.

If you are unable to insert the plug into the outlet, contact your electrician to replace your obsolete outlet. Do not defeat the safety purpose of the grounding-type plug.

2. Power Sources

Operate your product only from the type of power source indicated on the marking label. If you are not sure of the type of power supply to your home, consult your product dealer or local power company. If your product is intended to operate from battery power, or other sources, refer to the operating instructions.

3. Overloading

Do not overload wall outlets, extension cords, or integral convenience receptacles as this can result in a risk of fire or electric shock.

4. Power Cord Protection

Power supply cords should be routed so that they are not likely to be walked on or pinched by items placed upon or against them, paying particular attention to cords at plugs, convenience receptacles, and the point where they exit from the product.

5. Ventilation

Slots and openings in the cabinet are provided for ventilation. To ensure reliable operation of the product and to protect it from overheating, these openings must not be blocked or covered.

- Do not block the openings by placing the product on a bed, sofa, rug or other similar surface.
- Do not place the product in a built-in installation such as a bookcase or rack unless proper ventilation is provided or the manufacturer's instructions have been adhered to.

6. Wall or Ceiling Mounting

The product should be mounted to a wall or ceiling only as recommended by the manufacturer.

ANTENNA INSTALLATION INSTRUCTIONS

1. Outdoor Antenna Grounding

If an outside antenna or cable system is connected to the product, be sure the antenna or cable system is grounded so as to provide some protection against voltage surges and built-up static charges. Article 810 of the National Electrical Code, ANSI/NFPA 70, provides information with regard to proper grounding of the mast and supporting structure, grounding of the lead-in wire to an antenna discharge unit, size of grounding connectors, location of antenna discharge unit, connection to grounding electrodes, and requirements for the grounding electrode.

2. Lightning

For added protection for this product during a lightning storm, or when it is left unattended and unused for long periods of time, unplug it from the wall outlet and disconnect the antenna or cable system. This will prevent damage to the product due to lightning and power-line surges.

3. Power Lines

An outside antenna system should not be located in the vicinity of overhead power lines or other electric light or power circuits, or where it can fall into such power lines or circuits. When installing an outside antenna system, extreme care should be taken to keep from touching such power lines or circuits as contact with them might be fatal.

EXAMPLE OF ANTENNA GROUNDING AS PER NATIONAL ELECTRICAL CODE, ANSI/NFPA 70

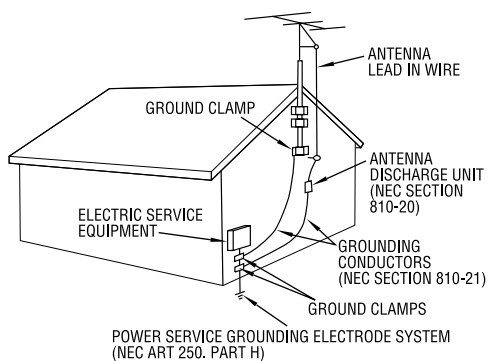

NEC – NATIONAL ELECTRICAL CODE

USE

1. Accessories

To avoid personal injury:

- Do not place this product on an unstable cart, stand, tripod, bracket, or table. It may fall, causing serious injury to a child or adult, and serious damage to the product.
- Use only with a cart, stand, tripod, bracket, or table recommended by the manufacturer or sold with the product.
- Use a mounting accessory recommended by the manufacturer and follow the manufacturer's instructions for any mounting of the product.
- Do not try to roll a cart with small casters across thresholds or deep-pile carpets.

2. Product and Cart Combination

A product and cart combination should be moved with care. Quick stops, excessive force, and uneven surfaces may cause the product and cart combination to overturn.

PORTABLE CART WARNING
(Symbol provided by RETAC)



3. Water and Moisture

Do not use this product near water—for example, near a bath tub, wash bowl, kitchen sink or laundry tub, in a wet basement, or near a swimming pool and the like.

4. Object and Liquid Entry

Never push objects of any kind into this product through openings as they may touch dangerous voltage points or short-out parts that could result in a fire or electric shock. Never spill liquid of any kind on the product.

5. Attachments

Do not use attachments not recommended by the manufacturer of this product as they may cause hazards.

6. Cleaning

Unplug this product from the wall outlet before cleaning. Do not use liquid cleaners or aerosol cleaners. Use a damp cloth for cleaning.

7. Heat

The product should be situated away from heat sources such as radiators, heat registers, stoves, or other products (including amplifiers) that produce heat.

SERVICING

1. Servicing

If your product is not operating correctly or exhibits a marked change in performance and you are unable to restore normal operation by following the detailed procedure in its operating instructions, do not attempt to service it yourself as opening or removing covers may expose you to dangerous voltage or other hazards. Refer all servicing to qualified service personnel.

2. Damage Requiring Service

Unplug this product from the wall outlet and refer servicing to qualified service personnel under the following conditions:

- When the power supply cord or plug is damaged.
- If liquid has been spilled, or objects have fallen into the product.
- If the product has been exposed to rain or water.
- If the product does not operate normally by following the operating instructions. Adjust only those controls that are covered by the operating instructions as an improper adjustment of other controls may result in damage and will often require extensive work by a qualified technician to restore the product to its normal operation.
- If the product has been dropped or damaged in any way.
- When the product exhibits a distinct change in performance—this indicates a need for service.

3. Replacement Parts

When replacement parts are required, be sure the service technician has used replacement parts specified by the manufacturer or which have the same characteristics as the original part. Unauthorized substitutions may result in fire, electric shock or other hazards.

4. Safety Check

Upon completion of any service or repairs to this product, ask the service technician to perform safety checks to determine that the product is in safe operating condition.

HOW TO USE THIS INSTRUCTION MANUAL

- All major sections and subsections are listed in the Table Of Contents on page 6. Use this when searching for information on a specific procedure or feature.
- The Index on pages 10 – 13 lists frequently-used terms, and the number of the page on which they are used or explained in the manual. This section also illustrates the controls and connections on the front and rear panel, the front display panel and the remote control.
- The  mark signals a reference to another page for instructions or related information.
- Operation buttons necessary for the various procedures are clearly indicated through the use of illustrations at the beginning of each major section.

BEFORE YOU INSTALL YOUR NEW UNIT . . .

. . . please read the sections/literature listed below.

- "CAUTIONS" on page 2
- "IMPORTANT PRODUCT SAFETY INSTRUCTIONS" on pages 3 – 4

DSS™ is an official trademark of DIRECTV, Inc., a unit of GM Hughes Electronics. DISH Network™ is a trademark of EchoStar Communications Corporation.



- Manufactured under license from Dolby Laboratories. “Dolby” and the double-D symbol are trademarks of Dolby Laboratories.
- “DTS” and “DTS 2.0 + Digital Out” are trademarks of Digital Theater Systems, Inc.
- Cassettes marked “VHS” (or “S-VHS”) can be used with this unit. However, S-VHS recording is not possible with this model.
- This model is equipped with SQPB (S-VHS QUASI PLAYBACK) that is protected by method claims of certain U.S. patents and other intellectual property rights owned by Macrovision Corporation and other rights owners. Use of this copyright protection technology must be authorized by Macrovision Corporation, and is intended for home and other limited viewing users only unless otherwise authorized by Macrovision Corporation. Reverse engineering or disassembly is prohibited.
- As an ENERGY STAR® Partner, JVC has determined that this product or product model meets the ENERGY STAR® guidelines for energy efficiency.

When the equipment is installed in a cabinet or a shelf, make sure that it has sufficient space on all sides to allow for ventilation (10 cm or more on both sides, on top and at the rear.)

When discarding batteries, environmental problems must be considered and the local rules or laws governing the disposal of these batteries must be followed strictly.

Failure to heed the following precautions may result in damage to the unit, Remote or video cassette.

1. **DO NOT** place the unit —
 - in an environment prone to extreme temperatures or humidity.
 - in direct sunlight.
 - in a dusty environment.
 - in an environment where strong magnetic fields are generated.
 - on a surface that is unstable or subject to vibration.
2. **DO NOT** block the unit's ventilation openings or holes.
(If the ventilation openings or holes are blocked by a newspaper or cloth, etc., the heat may not be able to get out.)
3. **DO NOT** place heavy objects on the unit or Remote.
4. **DO NOT** place anything which might spill on top of the unit or Remote.
(If water or liquid is allowed to enter this equipment, fire or electric shock may be caused.)
5. **DO NOT** expose the apparatus to dripping or splashing.
6. **DO NOT** use this equipment in a bathroom or places with water. Also **DO NOT** place any containers filled with water or liquids (such as cosmetics or medicines, flower vases, potted plants, cups, etc.) on top of this unit.
7. **DO NOT** place any naked flame sources, such as lighted candles, on the apparatus.
8. **AVOID** violent shocks to the unit during transport.

MOISTURE CONDENSATION

Moisture in the air will condense on the unit when you move it from a cold place to a warm place, or under extremely humid conditions—just as water droplets form in the surface of a glass filled with cold liquid. Moisture condensation on the head drum will cause damage to the tape. In conditions where condensation may occur, keep the unit turned on for a few hours to let the moisture dry.

ATTENTION

To mobile phone users:

Using a mobile phone in the vicinity of the unit may cause picture vibration on the TV screen or change the screen to a blue back display.

On placing the unit:







Some TVs or other appliances generates strong magnetic fields. Do not place such appliance on top of the unit as it may cause picture disturbance.

DISC INFORMATION	7	EDITING (VCR DECK)	68
About Discs	7	Edit From A Camcorder	68
INDEX	10	Edit To Or From Another Video Recorder	69
INSTALLING YOUR NEW UNIT	14	Dubbing (from DVD to VCR)	70
Basic Connections	14	EDITING (DVD DECK)	71
S-VIDEO Connection	15	Digital Audio Dubbing	71
Component Video Connection	16	REMOTE	72
INITIAL SETTINGS	17	Remote Control Functions	72
Plug & Play Set	17	Connecting To A Dolby Digital Decoder or An Amplifier With Built-in DTS (DVD deck only)	73
Monitor Set (DVD deck)	18	SUBSIDIARY SETTINGS	74
Language	20	Mode Set (VCR deck)	74
Clock Set	24	Mode Set (DVD deck)	78
Tuner Set	26	Child Lock	81
PROGRESSIVE SCAN MODE SET	28	Tray Lock	81
Progressive Scan Mode Set (VCR deck/DVD deck)	28	TROUBLESHOOTING	82
OPERATIONS ON VCR DECK	29	QUESTIONS AND ANSWERS	87
Basic Playback	29	SPECIFICATIONS	88
Playback Features	30	LIST OF TERMS	89
Basic Recording	34	WARRANTY (Only in U.S.A.)	91
Recording Features	35		
Express Timer Programing	37		
Satellite Auto Recording	41		
OPERATIONS ON DVD DECK	42		
Basic Playback	42		
Playback Features	43		
Using the on-screen bar	48		
Parental Lock	58		
About MP3 Disc	62		
MP3 Playback	63		
About JPEG Disc	65		
JPEG Playback	66		

About Discs

Playable Discs

You can use the discs with the following logos for playback only.

<p>DVD VIDEO (8 cm /12 cm disc)</p> 	<p>Video CD/Super Video CD (8 cm /12 cm disc)</p>  
<p>Audio CD (8 cm /12 cm disc)</p>  <p>CD-DA files</p>	 

- The following discs also can be played back.
 - DVD-R/RW discs recorded in DVD VIDEO format and finalized
 - CD-R/RW discs recorded in Super Video CD, Video CD or Audio CD format and finalized.
 - CD-R/RW discs recorded in MP3 format in accordance with the "ISO 9660" format. (See page 62 for details.)
 - CD-R/RW discs recorded in JPEG format in accordance with the "ISO 9660" format. (See page 65 for details.)
- Discs other than the above cannot be played back.
- Operation and audio quality of this unit are not guaranteed for discs that do not conform to the Compact Disc specification (CD-DA).
Before you play back a CD, check for the CD logo and read the notes on the package to confirm that it conforms to the Compact Disc specification.
- Depending on the intentions of the author of the software, recording conditions of DVD discs and Video CD discs may be restricted. Since this unit plays back discs according to the intentions of the author of the software as indicated on the disc, some functions may not operate as commanded.
- When switching from the first layer to the second layer of double-layered DVD VIDEO discs, the image and sound may be momentarily distorted. This is not a malfunction.

Unplayable Discs

The following types of discs cannot be played using this unit. Do not attempt to play back any kind of disc that is damaged (cracked, warped, or repaired with adhesive tape) or discs in unusual shapes (heart-shaped, octagonal, or other forms). If such discs are accidentally played back, it may cause noise that can lead to speaker damage.

- CD-ROM discs (including PHOTO-CD)
- DVD AUDIO discs
- Super Audio CDs (SACD)
- DVD-RW discs recorded in VR format
- DVD-RAM
- Discs which have a region number other than "1"







Region Number

The world is divided into 6 regions for DVD VIDEO discs. DVD VIDEO discs are assigned a region number to indicate which region they may be played back in. A disc cannot be played back on this unit unless the region number of the disc matches that of the unit. The region number for this unit is "1". Only discs whose region number includes "1" can be played back such as shown below.

Examples of DVD VIDEO labels which can be played back using this unit.









Marks of discs in this instruction manual

	Allows operation with a DVD VIDEO disc.		Allows operation with an Audio CD disc.
	Allows operation with a Video CD disc.		Allows operation with an SVCD disc.
	Allows operation with a disc including MP3 files.		Allows operation with a disc including JPEG files.



DVD VIDEO Marks

Sometimes marks are printed on a DVD disc and/or on its packaging to indicate information regarding the contents and functions of a disc. Check marks indicating the contents and functions of a disc. Note, however, that in some cases a disc may not include a mark even for a function it supports.

Marks related to video

Mark	Description
	Number of subtitles
	Number of angles
	Recorded under the standard 4:3 aspect ratio
	Screen includes black bands at top and bottom of image which has a standard 4:3 aspect ratio (letter box)
	Video playback is in Wide video mode (16:9) on wide televisions, but in letter box on televisions with standard 4:3 aspect ratio.
	Video playback is in Wide video mode (16:9) on wide televisions, but pan and scan is used on televisions with standard 4:3 aspect ratio (either the left or right side of the image is cut-out).

Marks related to audio

Mark	Description
	Number of audio tracks
	Dolby Digital mark Dolby Laboratories has developed a digital surround system for the home. This mark indicates that you may enjoy 5.1-channel audio (front left and right, center, rear left and right, and a channel for LFE (Low-Frequency Effects)).
	DTS (Digital Theater System) The DTS decoder on this unit enables you to enjoy DTS audio with the connected TV's speakers by converting 5.1 channel audio signals into 2 channel signals (DTS Down Mixing). The decoder also outputs the original DTS 5.1 channel audio signals from the DIGITAL AUDIO OUT connector on this unit.

File Structure of Discs

DVD VIDEO

Typically, DVD VIDEO discs are made up of larger units called "titles". Each title has a number (title number) that can be used to select desired titles. Titles are further divided into units called "chapters". Each chapter has a number (chapter number) that can also be used to select desired chapters. Note that some discs are not divided into titles and chapters.

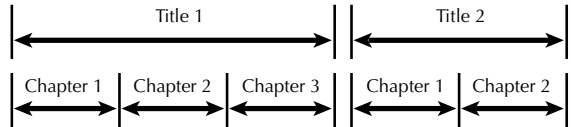

Audio CD/Video CD

Typically, Audio CD discs are divided into separate tracks each containing one song. Each track is assigned a number. For example, the third track is Track 3. The same is true for Video CD discs.

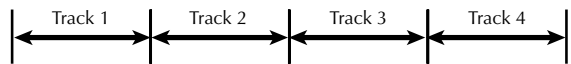

NOTE:

Video CD discs that support Playback Control (PBC)

The still image or motion image which follows a menu screen is called a "scene". Each scene has a scene number.

For more details, refer to "Locating a desired scene using the menu of the Video CD with PBC" (☞ pg. 43).

Placing a Disc

1 Open the disc tray.

Press **OPEN/CLOSE** (▲) on the DVD deck to open the disc tray.

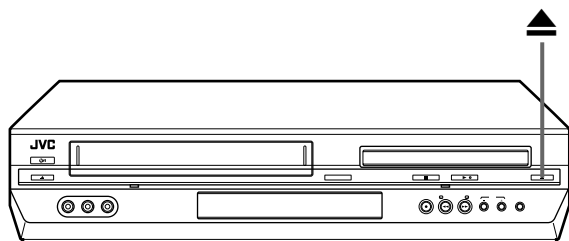

- Pressing the button again closes the disc tray.
- Do not block the disc tray with your hand while it is opening or closing as this may result in hardware failure.
- Do not place unplayable discs or any object other than a disc in the disc tray.
- Do not press down strongly on the disc tray or place any heavy objects on it.

2 Place the disc.

Place the disc in the disc tray with the label side facing up.

- Since disc size changes depending on the disc to be played back, be sure to correctly align the disc with the grooves for its size. If the disc is not in its groove, it may be scratched or otherwise damaged.
- To insert an 8 cm disc, place it according to the inner groove.

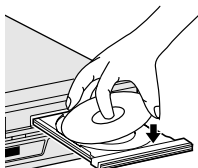

Care and Handling of Discs

How to handle discs

When handling a disc, do not touch the surface of the disc. Since discs are made of plastic, they are easily damaged. If a disc gets dirty, dusty, scratched or warped, the images and sound will not be picked up correctly, and such a disc may cause the unit to malfunction.

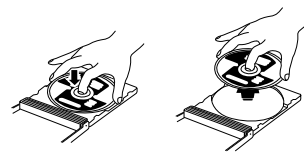

Label side

Do not damage the label side, stick paper to or use any adhesive on its surface.

Storage

Make sure that discs are kept in their cases. If discs are piled on top of one another without their protective cases, they can be damaged. Do not put discs in a location where they may be exposed to direct sunlight, or in a place where the humidity or temperature is high. Avoid leaving discs in your car!

Maintenance of discs

If there are fingerprints or other dirt adhering to a disc, wipe with a soft dry cloth, moving from the center outwards. If a disc is difficult to clean, wipe with a cloth moistened with water. Never use record cleaners, petrol, alcohol or any anti-static agents.



CAUTION

Sometimes during playback, noise or images may be garbled. This is sometimes due to the disc. (It may not be up to industry standards.)
These symptoms are caused by the discs, not by the malfunction of the unit.

FRONT VIEW

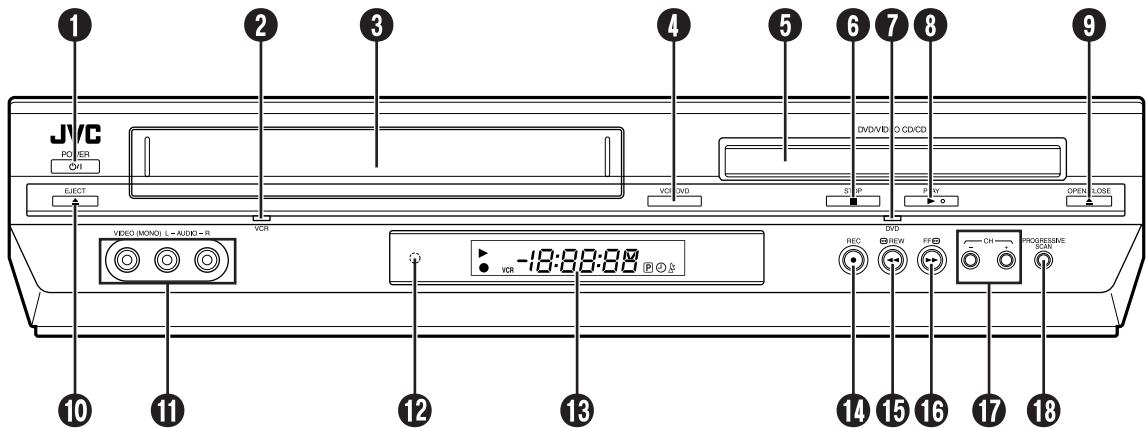

- ❶ Power Button (POWER (⏻/⏿)) ☞ pg. 18
- ❷ VCR Indicator ☞ pg. 29, 34
- ❸ VHS Cassette Loading Slot
- ❹ VCR/DVD Button ☞ pg. 29, 34, 42
- ❺ Disc Tray
- ❻ Stop Button (STOP (■)) ☞ pg. 29, 34, 42
- ❼ DVD Indicator ☞ pg. 42
- ❽ Play Button (PLAY (▶)) ☞ pg. 29, 42
- ❾ DVD Open/Close Button (OPEN/CLOSE (⏏)) ☞ pg. 42
- ❿ VHS Eject Button (EJECT (⏏)) ☞ pg. 29, 34
- ⓫ Video/Audio Input Connectors (VIDEO/AUDIO) ☞ pg. 68
- ⓬ Remote Sensor
- ⓭ Front Display Panel ☞ pg. 11
- ⓮ Record Button (REC (●)) ☞ pg. 34
- ⓯ Rewind Button (REW (◀◀)) ☞ pg. 29, 30, 44
- ⓰ Fast Forward Button (FF (▶▶)) ☞ pg. 29, 30, 44
- ⓱ Channel Button (CH +/-) ☞ pg. 34
- ⓲ Progressive Scan Button (PROGRESSIVE SCAN) ☞ pg. 28

REAR VIEW

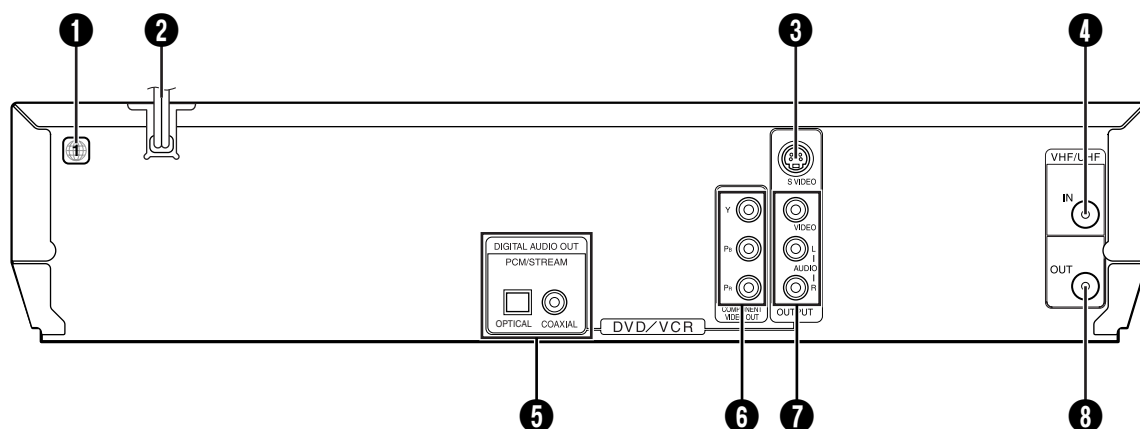

- ❶ Region Number Label [☞](#) pg. 7
- ❷ AC Power Cord [☞](#) pg. 14
- ❸ S-video Output Connector (S VIDEO OUTPUT) [☞](#) pg. 15
- ❹ Antenna Input Connector (VHF/UHF IN) [☞](#) pg. 14
- ❺ Digital Audio Output Connectors (DIGITAL AUDIO OUT (OPTICAL/COAXIAL)) [☞](#) pg. 71
- ❻ Component Video Output Connectors (COMPONENT VIDEO OUT) [☞](#) pg. 16
- ❼ Audio/Video Output Connectors (AUDIO/VIDEO OUTPUT) [☞](#) pg. 14, 15, 16, 69
- ❽ Antenna Output Connector (VHF/UHF OUT) [☞](#) pg. 14

FRONT DISPLAY PANEL

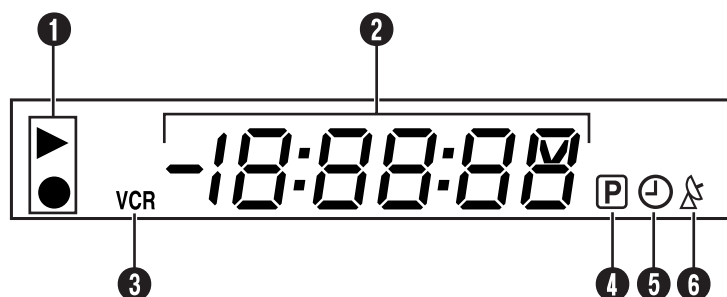

- ❶ Operation Mode Indicators
- ❷ Channel/Clock
Auxiliary Input Mode Display (F-1)
(VCR deck only)
Counter Display (VCR deck)
Tape Speed (SP/EP) (VCR deck only)
Multi-information window* (DVD deck)
- ❸ VCR Indicator [☞](#) pg. 35
- ❹ Progressive Mode Indicator [☞](#) pg. 28
- ❺ "Timer" Indicator (VCR deck only) [☞](#) pg. 38
- ❻ Satellite Auto Recording Indicator (⚡) (VCR deck only) [☞](#) pg. 41

* The current group/title/track/chapter number(s), time and status information.

ON-SCREEN DISPLAY (VCR deck)

If you press **ON SCREEN** on the Remote when "SUPERIMPOSE" is set to "ON" (☞ pg. 75), various operational indicators appear on the TV screen.

For On-screen display for DVD deck, refer to "Using the on-screen bar" (☞ pg. 48).

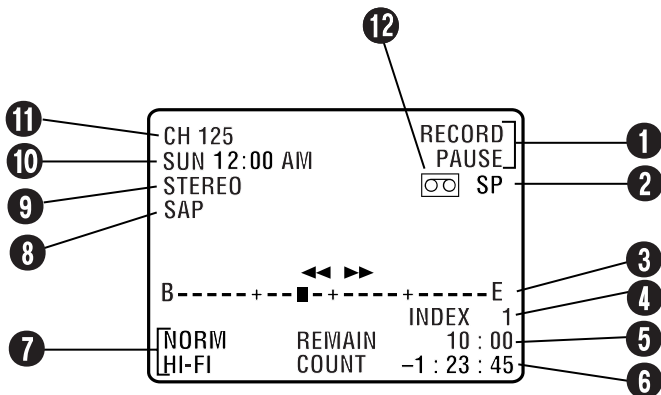

1 Operation Mode Indicators

2 Tape Speed (SP/EP)

3 Tape Position Indicator

The tape position indicator appears on the TV screen when you press **REW** (◀◀) or **FF** (▶▶) from the Stop mode or perform an Index Search. (☞ pg. 31) The position of "■" in relation to "B" (beginning) or "E" (end) shows you where you are on the tape.

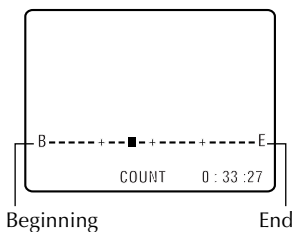

NOTE:

Depending on the type of tape being used, the tape position indicator may not appear correctly.

4 Index number ☞ pg. 31

5 Tape Remaining Time Indicator ☞ pg. 36

6 Counter Display

7 Audio Mode Display ☞ pg. 33

8 SAP Indicator ☞ pg. 36

9 Stereo Program Indicator ☞ pg. 36

10 Day/Clock Display

11 Channel Position Number/Auxiliary Input Indicator (F-1)

12 "Cassette Loaded" Mark

To recall an indication

1 Press **ON SCREEN**.

- All indications corresponding to the current status are displayed for 5 seconds. After that, the counter information and RECORD/PAUSE if in the Record Pause mode, remain on the screen.

2 Press **ON SCREEN** again to clear the display.

- The RECORD/PAUSE indication remains on the screen.

REMOTE

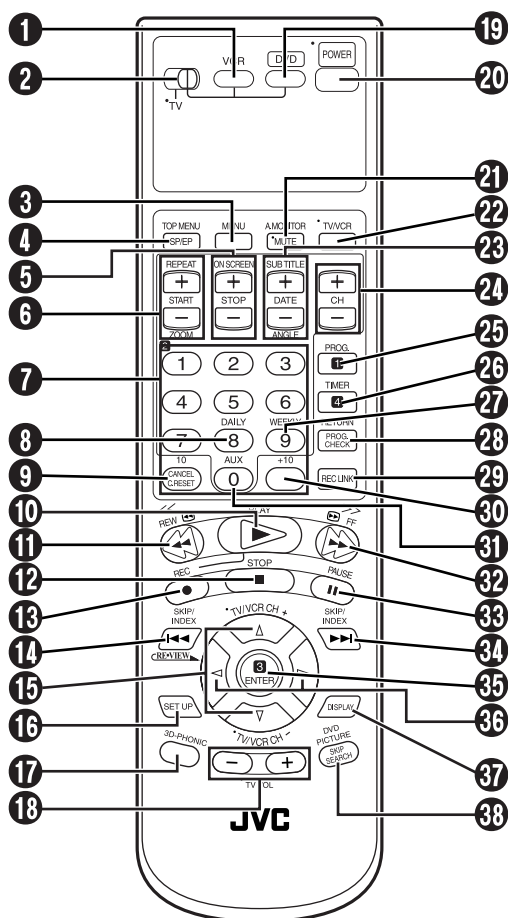

Buttons with a small dot on the left side of the name (**POWER** (⏻/⏻), **TV/VCR**, **TV/VCR CH +/-**, **TV VOL +/-**, **MUTE**) can also be used to operate a JVC's TV after setting the **TV/VCR/DVD** switch to the left.

- 1 VCR Button ☞ pg. 29, 34
- 2 TV/VCR/DVD switch ☞ pg. 18
- 3 Menu Button (MENU) ☞ pg. 43
- 4 SP/EP Button ☞ pg. 34
Top Menu Button (TOP MENU) ☞ pg. 43
- 5 Stop Time Button (STOP +/-) ☞ pg. 37
On-Screen Button (ON SCREEN) ☞ pg. 12, 48
- 6 Start Time Button (START +/-) ☞ pg. 37
Repeat Button (REPEAT) ☞ pg. 50, 64, 67
Zooming Button (ZOOM) ☞ pg. 45
- 7 Number Keys ☞ pg. 27, 34, 64
- 8 Daily Button (DAILY) ☞ pg. 38
- 9 Reset Button (C.RESET) ☞ pg. 36
Cancel Button (CANCEL) ☞ pg. 39
10 Button
- 10 Play Button (PLAY (▶)) ☞ pg. 29, 42
- 11 Rewind Button (REW (◀◀)) ☞ pg. 29, 30, 44

- 12 Stop Button (STOP (■)) ☞ pg. 29, 34, 42
- 13 Record Button (REC (●)) ☞ pg. 34
- 14 Reverse Skip/Index Button (SKIP/INDEX (◀◀)) ☞ pg. 31, 43
Review Button (◀REVIEW) ☞ pg. 31
- 15 △▽ Button ☞ pg. 18
TV/VCR Channel Button (TV/VCR CH +/-) ☞ See the left column
- 16 Set Up Button (SET UP) ☞ pg. 18
- 17 3D-Phonic Button (3D-PHONIC) ☞ pg. 46
- 18 TV Volume Button (TV VOL +/-) ☞ See the left column
- 19 DVD Button ☞ pg. 42
- 20 Power Button (POWER (⏻/⏻)) ☞ pg. 18, left column
- 21 TV Muting Button (MUTE) ☞ See the left column
Audio Monitor Button (A.MONITOR) ☞ pg. 33, 56, 57
- 22 TV/VCR Button ☞ pg. 35, left column
- 23 Date Button (DATE +/-) ☞ pg. 37
Subtitle Button (SUB TITLE) ☞ pg. 54
Angle Button (ANGLE) ☞ pg. 55
- 24 Channel Button (CH +/-) ☞ pg. 34
- 25 Programing Button (PROG.) ☞ pg. 37
- 26 Timer Button (TIMER) ☞ pg. 38
- 27 Weekly Button (WEEKLY) ☞ pg. 38
- 28 Program Check Button (PROG. CHECK) ☞ pg. 39
Return Button (RETURN) ☞ pg. 43
- 29 Satellite Auto Recording Button (REC LINK) ☞ pg. 41
- 30 +10 Button
- 31 Auxiliary Button (AUX) ☞ pg. 68
- 32 Fast Forward Button (FF (▶▶)) ☞ pg. 29, 30, 44
- 33 Pause Button (PAUSE (||)) ☞ pg. 30, 34
- 34 Forward Skip/Index Button (SKIP/INDEX (▶▶)) ☞ pg. 31, 43
- 35 ENTER Button ☞ pg. 18
- 36 ◀ ▶ Button ☞ pg. 18
- 37 Display Button (DISPLAY) ☞ pg. 36
- 38 Skip Search Button (SKIP SEARCH) ☞ pg. 31
DVD Picture Button (DVD PICTURE) ☞ pg. 47

How To Use

Before use, insert two AA size batteries into the Remote with the polarity (⊕ and ⊖) matched correctly as indicated on the battery compartment or on the lid.

The Remote can operate most of your unit's functions, as well as basic functions of TV sets of JVC. (☞ See the left column)

- Point the Remote toward the remote sensor.
- The maximum operating distance of the remote control is about 8 m.

NOTE:

If the Remote doesn't work properly, remove its batteries, wait a short time, replace the batteries and then try again.

Basic Connections

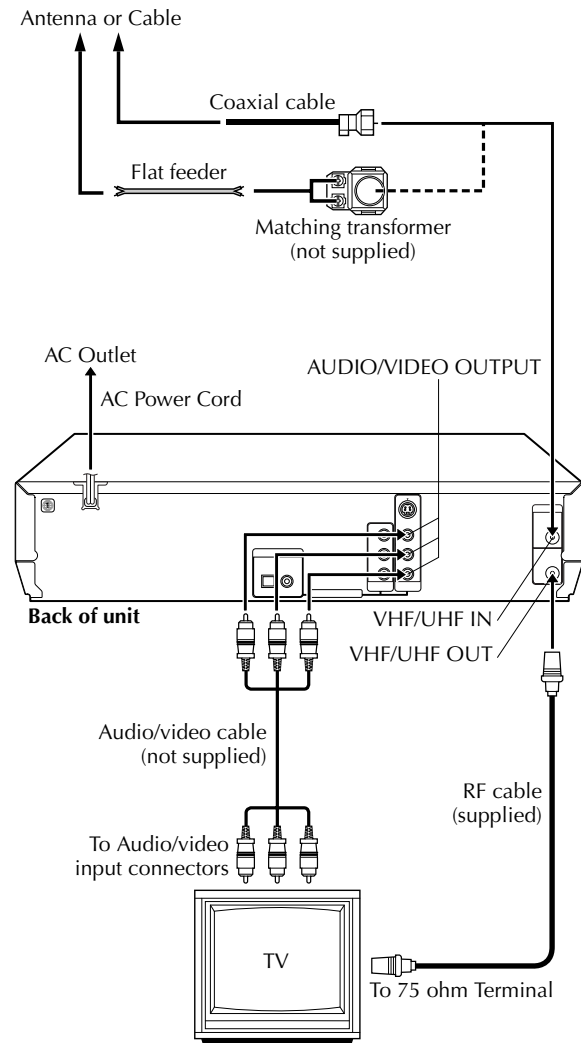

It's essential that your unit be properly connected.

THESE STEPS MUST BE COMPLETED BEFORE ANY VIDEO OPERATION CAN BE PERFORMED.

1 Check the contents.

Make sure the package contains all of the accessories listed in "SPECIFICATIONS" on page 88.

2 Situate the unit.

Place the unit on a stable, horizontal surface.

3 Connect the unit to TV.

The connection method you use depends on the type of TV you have.

RF Connection

- To connect to a TV with NO AV input connectors —
- 1 Disconnect the TV antenna from the TV.
- 2 Connect the TV antenna cable to the VHF/UHF IN connector on the rear panel of the unit.
- 3 Connect the supplied RF cable between the VHF/UHF OUT connector on the rear panel of the unit and the TV's antenna terminal.

AV Connection

- To connect to a TV with AV input connectors —
- 1 Connect the antenna, unit and TV as per "RF Connection".
- 2 Connect an optional audio/video cable between the AUDIO/VIDEO OUTPUT connectors on the rear panel of the unit and the TV's audio/video input connectors.
- Set your TV to AV mode.
- For switching the TV's mode, refer to the instruction manual of your television.
- To obtain high-quality pictures, you can also use the S-VIDEO connection or Component Video Connection. (DVD deck only) (ⓘ pg. 15, 16)

4 Connect the unit to power source.

- Plug the end of the AC power cord into an AC outlet. This unit performs Plug & Play Set automatically. (ⓘ pg. 17)
- The clock and tuner channels will automatically be set when the antenna is connected and when the AC power cord is first connected to an AC outlet. (If "AUTO" and the channel indicator are displayed on the front display panel before the unit is powered on, the clock and tuner channels are being set automatically. Wait for the time to be displayed on the front display panel before turning on the unit.)

5 Set the VCR channel.

The VCR channel is the channel on which you can watch the picture from the unit on the TV when only using RF connection.

With RF connection, set the VCR channel to "3 CH" or "4 CH".

- The VCR channel is preset to "3 CH". Set to "4 CH" if the Channel 3 is used for broadcasting in your area.
- With AV connection, set the VCR channel to "- CH" (off). To set the VCR channel, perform the following steps:

Before performing the following steps:

- Make sure there is no cassette inserted in the unit.
- Make sure the unit is turned on, then press **VCR/ DVD** on the unit or **VCR** on the Remote so that the VCR indicator lights up.

- 1 Press **POWER** (⏻) to turn off the unit, then press **STOP** (■) on the unit for more than 5 seconds. "3 CH" appears on the front display panel.
- 2 Press **CH +/-** on the Remote to select "3 CH", "4 CH" or "- CH" (off), then press **ENTER**.

S-VIDEO Connection

ATTENTION

Be sure to connect the unit's VIDEO OUTPUT (DVD/VCR) connector to the TV's VIDEO input connector.

■ To connect to a TV with S-VIDEO/AUDIO input connectors . . .

1 Connect the unit to TV.

- 1 Connect the antenna, unit and TV as per "AV Connection". (pg. 14)
- 2 Connect the unit's S VIDEO OUTPUT connector to the TV's S-VIDEO input connector.

2 Connect the unit to power source.

Plug the end of the AC power cord into an AC outlet. This unit performs Plug & Play Set automatically. (pg. 17)

- The clock and tuner channels will automatically be set when the antenna is connected and when the AC power cord is first connected to an AC outlet. (If "AUTO" and the channel indicator are displayed on the front display panel before the unit is powered on, the clock and tuner channels are being set automatically. Wait for the time to be displayed on the front display panel before turning on the unit.)

3 Set the VCR channel to off.

Before performing the following steps:

- Make sure there is no cassette inserted in the unit.
- Make sure the unit is turned on, then press **VCR/DVD** on the unit or **VCR** on the Remote so that the VCR indicator lights up.

- 1 Press **POWER** (⏻) to turn off the unit, then press **STOP** (■) on the unit for more than 5 seconds. "3 CH" appears on the front display panel.
- 2 Press **CH +/-** on the Remote to select "- CH" (off), then press **ENTER**.

NOTES:

- You can obtain high-quality S-VIDEO pictures.
- If your TV is not stereo-capable, use the unit's AUDIO OUTPUT connectors to connect to an audio amplifier for Hi-Fi stereo sound reproduction.
- To operate the unit with your TV using the S-VIDEO connection, set your TV to its AV mode. You can also use the **TV/VCR** button on the unit's Remote to set JVC TV to the AV mode.
- For switching the TV's mode, refer to the instruction manual of your television.

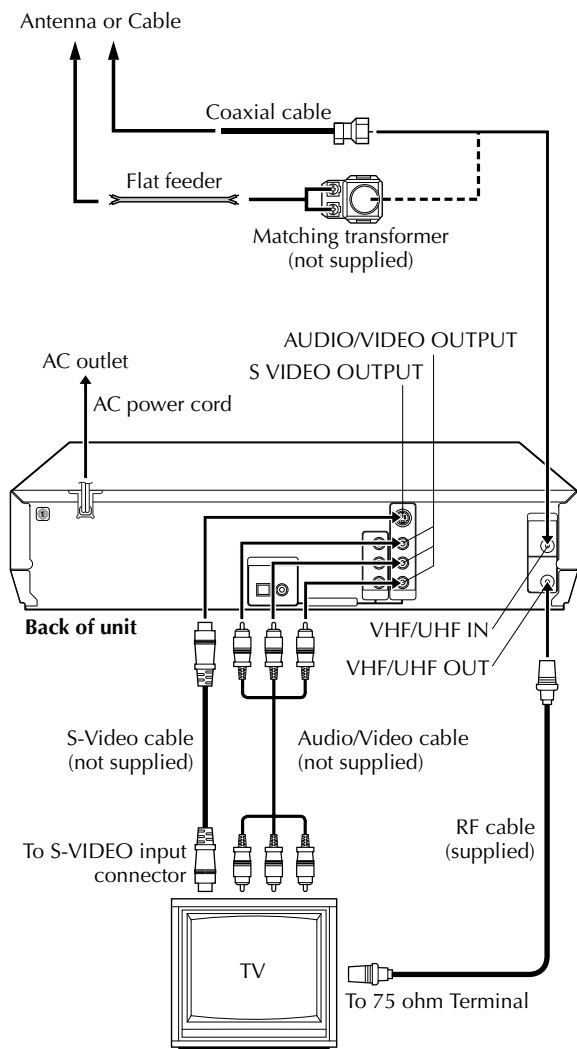

Component Video Connection

ATTENTION

Be sure to connect the unit's VIDEO OUTPUT (DVD/VCR) connector to the TV's VIDEO input connector.

- To connect to a TV with component video input connectors . . .

1 Connect the unit to TV.

- 1 Connect the aerial, unit and TV as per "AV Connection". (☞ pg. 14)
- 2 Connect the unit's COMPONENT VIDEO OUT connectors to the TV's component video input connectors.

2 Connect the unit to power source.

Plug the end of the AC power cord into an AC outlet. This unit performs Plug & Play Set automatically. (☞ pg. 17)

- The clock and tuner channels will automatically be set when the antenna is connected and when the AC power cord is first connected to an AC outlet. (If "AUTO" and the channel indicator are displayed on the front display panel before the unit is powered on, the clock and tuner channels are being set automatically. Wait for the time to be displayed on the front display panel before turning on the unit.)

3 Set the VCR channel to off.

Before performing the following steps:

- Make sure there is no cassette inserted in the unit.
- Make sure the unit is turned on, then press **VCR/DVD** on the unit or **VCR** on the Remote so that the VCR indicator lights up.

- 1 Press **POWER** (⏻) to turn off the unit, then press **STOP** (■) on the unit for more than 5 seconds. "3 CH" appears on the front display panel.
- 2 Press **CH +/-** on the Remote to select "- CH" (off), then press **ENTER**.

NOTES:

- You can obtain high-quality component video pictures.
- If your TV is not stereo-capable, use the unit's AUDIO OUTPUT connectors to connect to an audio amplifier for Hi-Fi stereo sound reproduction.
- To operate the unit with your TV using the Component Video connection, set your TV to its AV mode. You can also use the **TV/VCR** button on the unit's Remote to set JVC TV to the AV mode.
- For switching the TV's mode, refer to the instruction manual of your television.
- By using the component video connection, you can view the images in the progressive mode. For switching to the progressive mode, refer to "Progressive Scan Mode Set (VCR deck/DVD deck)" (☞ pg. 28).

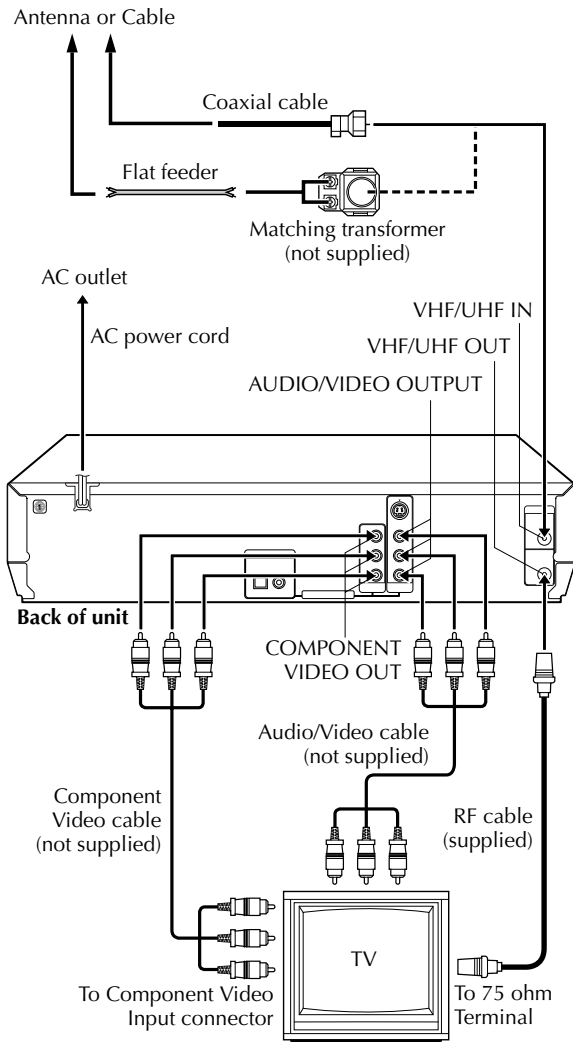

Plug & Play Set

Auto Clock Set/Auto Tuner Set

ATTENTION

- If you use a cable box, Plug&Play will not function; set the clock and tuner channels separately. (☞ pg. 24 – 27)
- Depending on areas or reception conditions, the unit may not receive the Auto clock setting data from the PBS channel. If this function is taking a considerable amount of time, it may be necessary to perform the Semiauto or Manual Clock Set procedure.

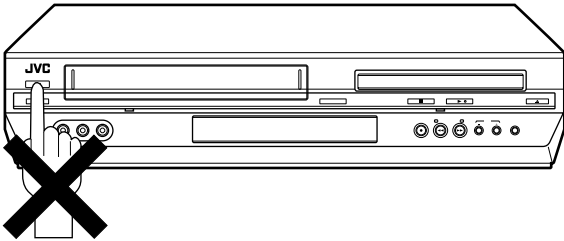

This unit sets the clock and tuner channels automatically when AC power cord is first connected to an AC outlet. The antenna cable must be connected for the Plug & Play setting.

The time and date can be set automatically by the clock setting data transmitted from one of the regular TV broadcast channels. We call this TV channel the “host channel” and it is a PBS channel in your area.

1 Perform Plug & Play setup.

Connect the antenna cable to the unit. (☞ pg. 14) Then connect the AC power cord to an AC outlet. Do not turn on the unit.

The clock and tuner channels will be set automatically.

NOTES:

- Auto Clock Set is performed first. “AUTO” blinks on the front display panel during Auto Clock Set.
- Auto Channel Set is performed next. Auto Channel Set scans all the channels that are receivable by your unit. During Auto Channel Set, the channel numbers are displayed as they are scanned and set.
- When Plug & Play setting has been complete successfully, the correct clock time is displayed. If you perform Plug & Play setting successfully, there is no need to perform “Clock Set” (☞ pg. 24) and “Tuner Set” (☞ pg. 26). If, however, you want to add or delete channels, refer to “Manual Channel Set” (☞ pg. 27).

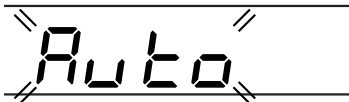

During Initial Auto Clock Set
“AUTO” blinks.



During Auto Channel Set
The channel numbers are displayed as they are scanned and set.



Plug&Play Completed
The current time is displayed.

* If an incorrect clock time or “--:--” appears on the front display panel, see “What to do if Plug & Play setting failed” below.

INFORMATION

- If “AUTO CLOCK” is set to “ON” (☞ pg. 25), the clock will be adjusted automatically by the host channel every hour (except 11:00 PM, midnight, 1:00 AM and 2:00 AM) using the incoming PBS channel clock setting data. (This automatic clock adjustment can only be performed when the unit is turned off. The clock will be adjusted just on these hours — on the time displayed on the front display panel, not on the actual real time.) The default setting of “AUTO CLOCK” is “ON”. (☞ pg. 25)
- If the memory backup fails, because a power outage occurs or because the AC power cord is unplugged, Plug & Play will be performed when power is restored to the unit.

What to do if Plug & Play setting failed

- If an incorrect time is displayed on the front display panel, you may be receiving the clock setting data of a PBS channel from an adjacent time zone, or an incorrect PBS channel from a cable TV system. In this case, perform “Semiauto Clock Set” (☞ pg. 25) or “Manual Clock Set” (☞ pg. 25).
- If “--:--” appears on the front display panel, your antenna cable may not be connected to the unit or there may not be a Host PBS signal available in your area. Ensure that the antenna cable is connected correctly. Then turn on and off the unit; the Plug & Play setting will be automatically reactivated. If Plug & Play setting is not performed though the antenna cable is connected correctly, perform “Manual Clock Set” (☞ pg. 25) and “Auto Channel Set” (☞ pg. 26) or “Manual Channel Set” (☞ pg. 27).

Monitor Set

(DVD deck)

You can select the monitor type depending the TV used when you play back DVD VIDEO discs recorded for wide-screen TVs.

- Turn on the TV and select the VCR channel (or AV mode).
- Slide the TV/VCR/DVD switch to the right.

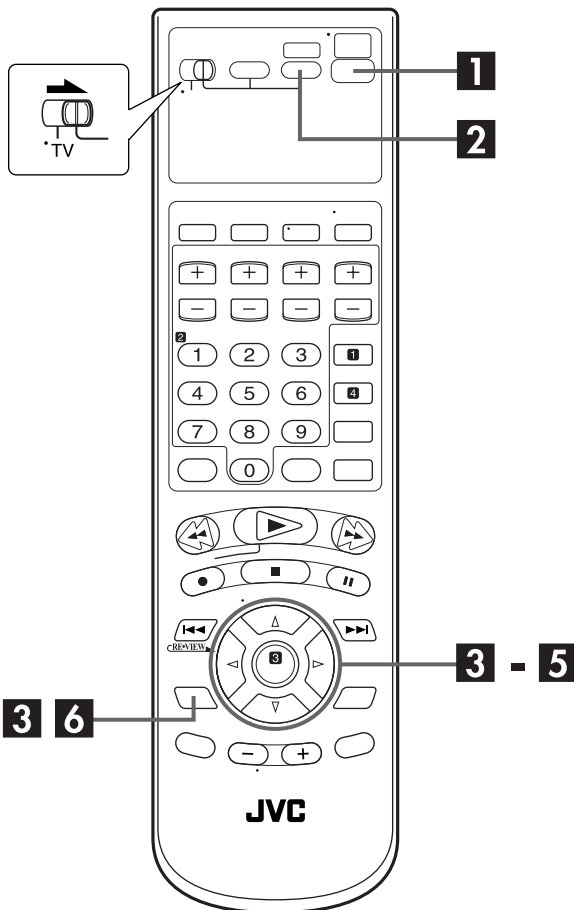

1 Turn on the unit.

Press **POWER** (⏻/⏻).

2 Select the DVD deck.

On the unit

Press **VCR/DVD** repeatedly so that the DVD indicator lights up.

On the Remote

Press **DVD** so that the DVD indicator lights up.

3 Access the DVD Set Up menu screen.

- 1 Press **SET UP**.
- 2 Press **◀ ▶** to select "PICTURE".

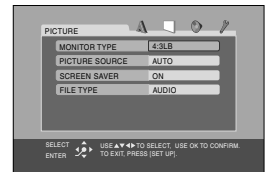

4 Select the mode.

Press **▲▼** to move the highlight to "MONITOR TYPE", then press **ENTER**.

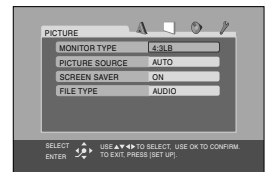

5 Select the mode setting.

Press **▲▼** to select the desired setting, then press **ENTER**.

6 Return to the normal screen.

Press **SET UP**.

NOTE:

DVD Set Up menu is displayed in STOP mode only.

* The default setting is **bold** in the table below.

■ MONITOR TYPE

16:9 (Wide television conversion):

Select this when the aspect ratio of your TV is fixed to 16:9 (wide TV). The unit automatically adjusts the screen width of the output signal correctly when playing back a picture whose aspect ratio is 4:3.

4:3 LB (Letter Box conversion):

Select this when the aspect ratio of your TV is 4:3 (conventional TV). While viewing a wide screen picture, the black bars appear on the top and the bottom of the screen.

4:3 PS (Pan&Scan):

Select this when the aspect ratio of your TV is 4:3 (conventional TV). While viewing a wide screen picture, the black bars do not appear; however, the left and right edges of the pictures will not be shown on the screen.

Pan&Scan/Letter Box

In general, DVD VIDEO disc are produced for a wide-screen TV with 16:9 aspect ratio.

Material with this ratio will not fit to a TV with 4:3 aspect ratio. There are two styles to display the image, "Pan&Scan" (PS) and "Letter Box" (LB).

Pan&Scan

The right and left side of the image are cut off. The image fills the screen.



Letter Box

Black bands appear at the top and bottom of the image. The image itself appears in 16:9 aspect ratio.



Language

- Turn on the TV and select the VCR channel (or AV mode).
- Slide the **TV/VCR/DVD** switch to the right.

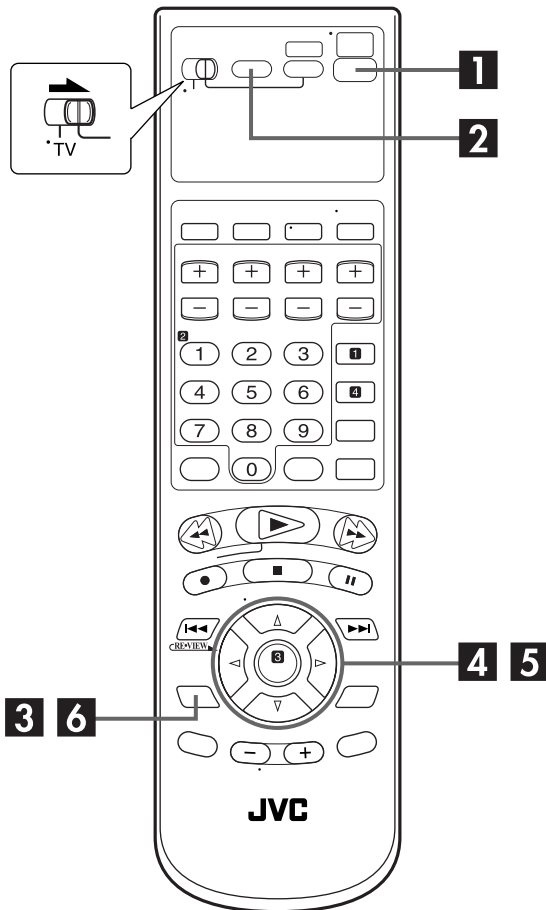

On-screen Language Set (VCR deck)

This VCR deck offers you the choice to view on-screen messages in 3 different languages.

1 Turn on the unit.

Press **POWER** (⏻/⏻).

2 Select the VCR deck.

On the unit

Press **VCR/DVD** repeatedly so that the VCR indicator lights up.

On the Remote

Press **VCR** so that the VCR indicator lights up.

3 Access the Main Menu screen.

Press **SET UP**.

4 Access the Initial Set screen.

Press Δ / ∇ to move the highlight bar (arrow) to "INITIAL SET", then press **ENTER** or \triangleright .

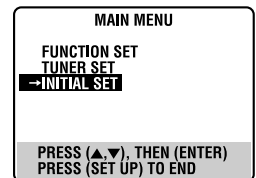

5 Select the language.

Press Δ / ∇ to move the highlight bar (arrow) to "LANGUAGE", then press **ENTER** or \triangleright repeatedly until the desired language is selected.

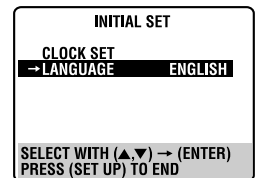

6 Return to the normal screen.

Press **SET UP**.

On-screen Language Set (DVD deck)

This DVD deck offers you the choice to view on-screen messages in 3 different languages. You can change the language setting manually as required.

1 Turn on the unit.

Press **POWER** (⏻/⏻).

2 Select the DVD deck.

On the unit

Press **VCR/DVD** repeatedly so that the DVD indicator lights up.

On the Remote

Press **DVD** so that the DVD indicator lights up.

3 Access the DVD Set Up menu screen.

- 1 Press **SET UP**.
- 2 Press **◀ ▶** to select "▲ LANGUAGE".

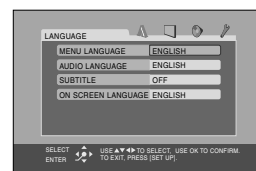

4 Select the mode.

Press **△▽** to move the highlight to "ON SCREEN LANGUAGE", then press **ENTER**.

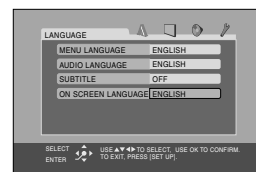

5 Select the mode setting.

Press **△▽** to select the desired setting, then press **ENTER**.

6 Return to the normal screen.

Press **SET UP**.

NOTE:

DVD Set Up menu is displayed in STOP mode only.

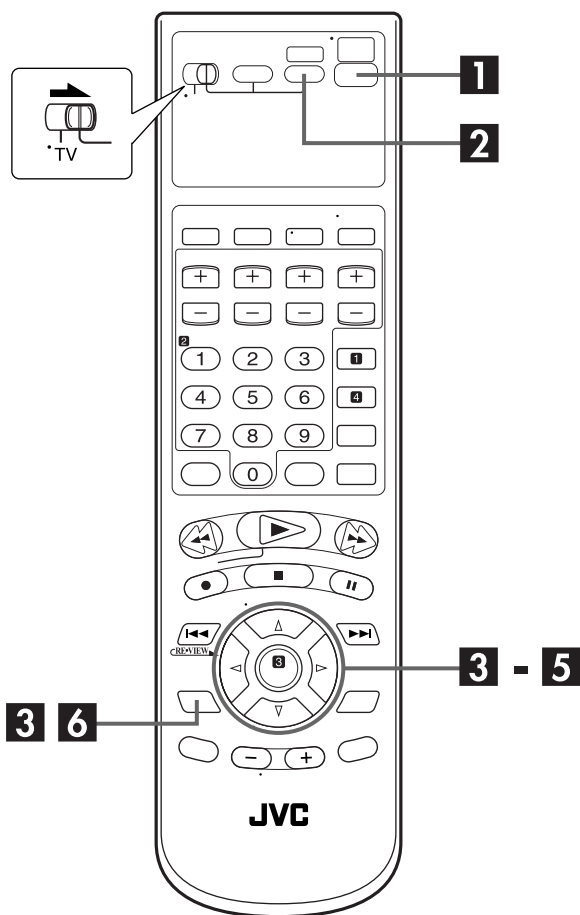

Menu/Audio/Subtitle Language Set (DVD deck only)

Some DVD discs contain the DVD menu display, audio, subtitle in the multiple languages. With these discs, you can set the default language as you like.

- The procedure shows how to set "MENU LANGUAGE" on the DVD Set Up menu screen as an example.

1 Turn on the unit.

Press **POWER** (⏻/⏻).

2 Select the DVD deck.

On the unit

Press **VCR/DVD** repeatedly so that the DVD indicator lights up.

On the Remote

Press **DVD** so that the DVD indicator lights up.

3 Access the DVD Set Up menu screen.

- 1 Press **SET UP**.
- 2 Press **◀ ▶** to select "▲ LANGUAGE".

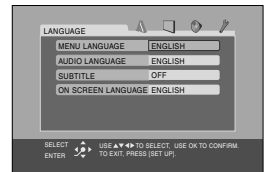

4 Select the mode.

Press **△▽** to move the highlight to "MENU LANGUAGE", then press **ENTER**.

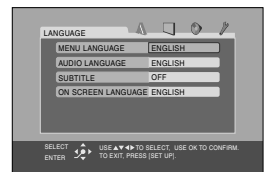

5 Select the mode setting.

Press **△▽** to select the desired setting, then press **ENTER**.

- See "Language Code List" (☞ pg. 23).

6 Return to the normal screen.

Press **SET UP**.

NOTES:

- When the selected language is not available on the disc, the disc's default menu language is played back.
- DVD Set Up menu is displayed in STOP mode only.

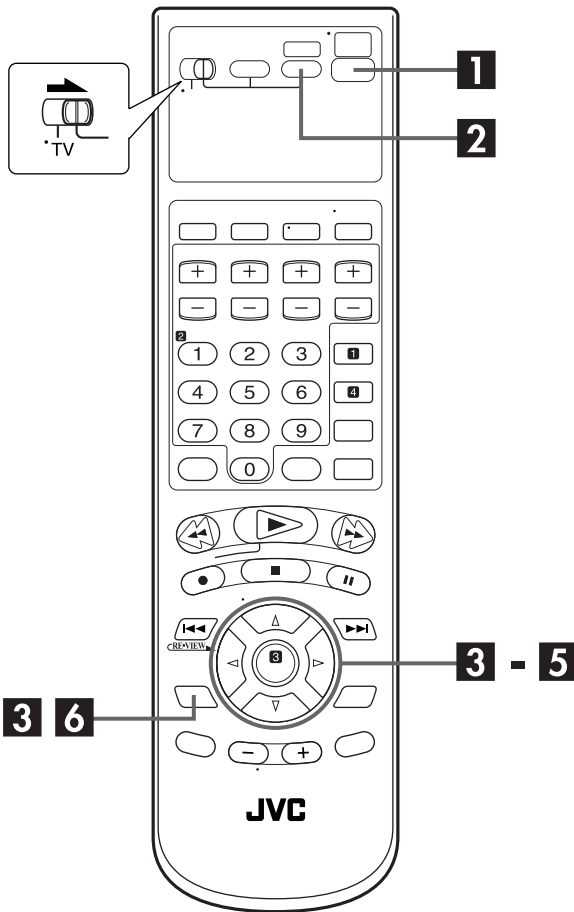

Language Code List

AA	Afar	IK	Inupiak	RN	Kirundi
AB	Abkhazian	IN	Indonesian	RO	Rumanian
AF	Afrikaans	IS	Icelandic	RU	Russian
AM	Ameharic	IW	Hebrew	RW	Kinyarwanda
AR	Arabic	JI	Yiddish	SA	Sanskrit
AS	Assamese	JW	Javanese	SD	Sindhi
AY	Aymara	KA	Georgian	SG	Sangho
AZ	Azerbaijani	KK	Kazakh	SH	Serbo-Croatian
BA	Bashkir	KL	Greenlandic	SI	Singhalese
BE	Byelorussian	KM	Cambodian	SK	Slovak
BG	Bulgarian	KN	Kannada	SL	Slovenian
BH	Bihari	KO	Korean (KOR)	SM	Samoaian
BI	Bislama	KS	Kashmiri	SN	Shona
BN	Bengali, Bangla	KU	Kurdish	SO	Somali
BO	Tibetan	KY	Kirghiz	SQ	Albanian
BR	Breton	LA	Latin	SR	Serbian
CA	Catalan	LN	Lingala	SS	Siswati
CO	Corsican	LO	Laothian	ST	Sesotho
CS	Czech	LT	Lithuanian	SU	Sundanese
CY	Welsh	LV	Latvian, Lettish	SV	Swedish
DA	Danish	MG	Malagasy	SW	Swahili
DZ	Bhutani	MI	Maori	TA	Tamil
EL	Greek	MK	Macedonian	TE	Telugu
EO	Esperanto	ML	Malayalam	TG	Tajik
ET	Estonian	MN	Mongolian	TH	Thai
EU	Basque	MO	Moldavian	TI	Tigrinya
FA	Persian	MR	Marathi	TK	Turkmen
FI	Finnish	MS	Malay (MAY)	TL	Tagalog
FJ	Fiji	MT	Maltese	TN	Setswana
FO	Faroese	MY	Burmese	TO	Tonga
FY	Frisian	NA	Nauru	TR	Turkish
GA	Irish	NE	Nepali	TS	Tsonga
GD	Scots Gaelic	NL	Dutch	TT	Tatar
GL	Galician	NO	Norwegian	TW	Twi
GN	Guarani	OC	Occitan	UK	Ukrainian
GU	Gujarati	OM	(Afan) Oromo	UR	Urdu
HA	Hausa	OR	Oriya	UZ	Uzbek
HI	Hindi	PA	Panjabi	VI	Vietnamese
HR	Croatian	PL	Polish	VO	Volapuk
HU	Hungarian	PS	Pashto, Pushto	WO	Wolof
HY	Armenian	PT	Portuguese	XH	Xhosa
IA	Interlingua	QU	Quechua	YO	Yoruba
IE	Interlingue	RM	Rhaeto-Romance	ZU	Zulu

Clock Set

- Turn on the TV and select the VCR channel (or AV mode).
- Slide the TV/VCR/DVD switch to the right.

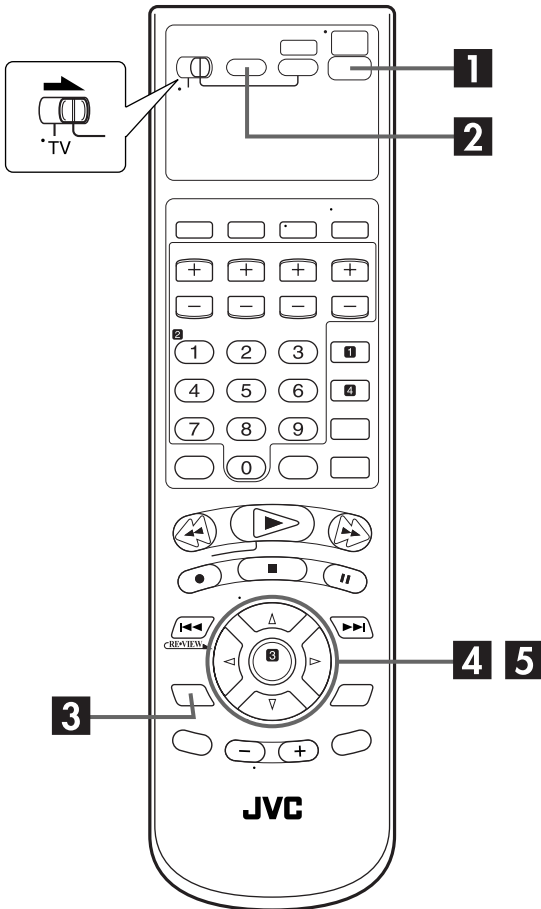

Perform clock setting only if the clock has not been set correctly by the Plug&Play setting.

Preparations

1 Turn on the unit.

Press **POWER** (⏻).

2 Select the VCR deck.

On the unit

Press **VCR/DVD** repeatedly so that the VCR indicator lights up.

On the Remote

Press **VCR** so that the VCR indicator lights up.

3 Access the Main Menu screen.

Press **SET UP**.

4 Access the Initial Set screen.

Press Δ / ∇ to move the highlight bar (arrow) to "INITIAL SET", then press **ENTER** or \triangleright .

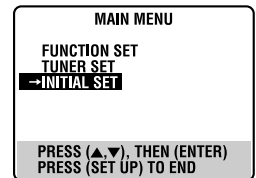

5 Access the Clock Set screen.

Press Δ / ∇ to move the highlight bar (arrow) to "CLOCK SET", then press **ENTER** or \triangleright .

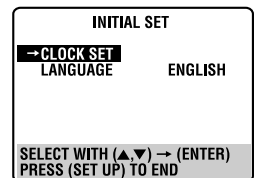

Semiauto Clock Set

You can change the host channel/D.S.T. (Daylight Saving Time)/time zone setting manually. First follow steps **1** to **5** in "Preparations" (☞ pg. 24), then go to the following steps.

NOTE:

The time set previously will be erased when "AUTO CLOCK", "HOST CH", "D.S.T." or "TIME ZONE" setting is changed.

1 Set "AUTO CLOCK" to "ON".

Press **ENTER** or **▷** repeatedly to move the highlight bar to "AUTO CLOCK", then press **△▽** so that "ON" is selected.

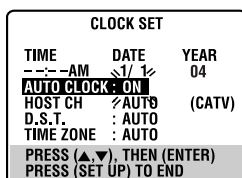

2 Select the host channel.

You can either select "AUTO" or enter a PBS channel number.

Press **ENTER** or **▷** to move the highlight bar to "HOST CH", then press **△▽** repeatedly until "AUTO" or the desired PBS channel number is selected.

NOTE:

Some PBS channels do not transmit clock setting data.

3 Select the D.S.T. mode.

Press **ENTER** or **▷** to move the highlight bar to "D.S.T.", then press **△▽** repeatedly until the desired setting is selected.

AUTO: Select if you want to adjust your VCR's clock automatically by the incoming signal from the host channel. Be sure to select the correct time zone manually in step **4**.

ON: Adjustment will be made by the built-in clock itself.

OFF: Select when Daylight Saving Time does not apply to you.

4 Select the time zone.

Press **ENTER** or **▷** to move the highlight bar to "TIME ZONE", then press **△▽** repeatedly until "AUTO" or the desired time zone is selected. Each time you press the button, the time zone changes as follows:

↔AUTO↔ATLANTIC↔EASTERN↔CENTRAL↔
MOUNTAIN↔PACIFIC↔ALASKA↔HAWAII↔
(back to the beginning)

NOTE:

If an incorrect time is displayed by the Plug & Play function, you may be receiving the clock setting data of a PBS channel from an adjacent time zone or from an incorrect PBS channel from a cable TV system. If you selected "AUTO" for the host channel in step **2**, be sure to select the correct time zone manually.

5 Complete the Semiauto Clock Set.

Press **SET UP** to return to normal screen.

IMPORTANT

Turn off the unit after performing Semiauto Clock. "AUTO" will appear on the front display panel while the clock is being set. The current clock time will appear automatically when the clock setting is complete.

AUTO DAYLIGHT SAVING TIME

This function enables automatic adjustment of the unit's clock at the start and end of Daylight Saving Time.

With Auto DST activated, —

- on the first Sunday of April at 2:00 AM, the clock is adjusted to 3:00 AM.
- on the last Sunday of October at 2:00 AM, the clock is adjusted to 1:00 AM.

Manual Clock Set

First follow steps **1** to **5** in "Preparations" (☞ pg. 24), then go to the following steps.

1 Set time, date and year.

Press **△▽** until the desired time appears, then press **ENTER** or **▷**. Set the date and year in the same way.

- Holding **△▽** changes the time in 30-minute intervals, or changes the date in 15-day intervals.

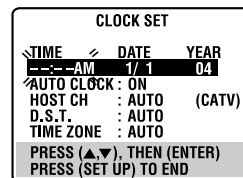

2 Select D.S.T. mode.

Press **ENTER** or **▷** to move the highlight bar to "D.S.T.", then press **△▽** to select the desired setting.

ON: Adjustment will be made by the built-in clock itself.

OFF: Select when Daylight Saving Time does not apply to you.

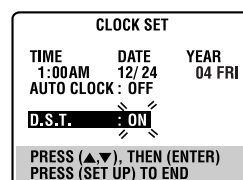

3 Start clock.

Press **SET UP** and normal screen appears.

To make corrections any time during the process

Press **ENTER** or **▷** repeatedly until the item you want to change blinks, then press **△▽**.

Tuner Set

- Turn on the TV and select the VCR channel (or AV mode).
- Slide the TV/VCR/DVD switch to the right.

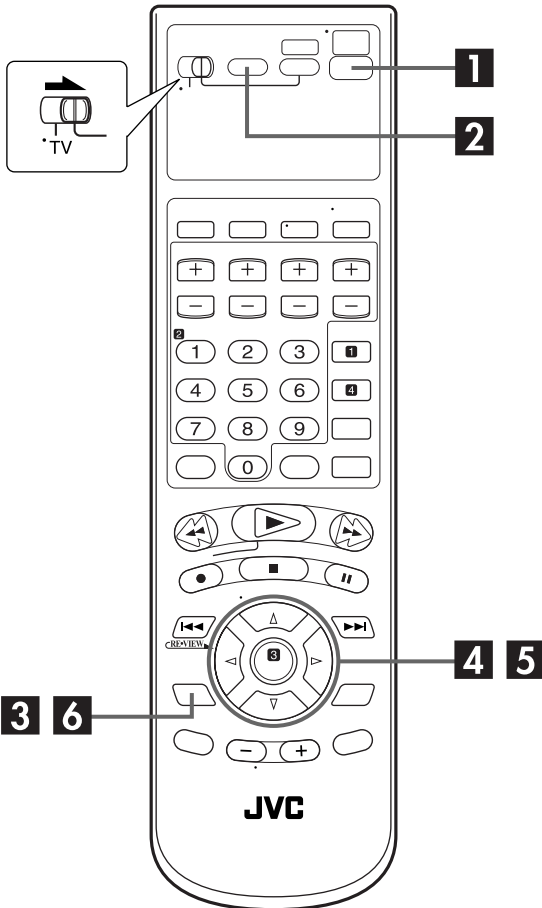

INFORMATION

The unit selects the correct band (TV or CATV) automatically during Auto Channel Set. The selected band will be displayed on the right side of "BAND" on the Tuner Set screen.

Auto Channel Set

Perform Auto Channel Set only if channels have not been set correctly by the Plug&Play setting.

1 Turn on the unit.

Press **POWER** (⏻).

2 Select the VCR deck.

On the unit

Press **VCR/DVD** repeatedly so that the VCR indicator lights up.

On the Remote

Press **VCR** so that the VCR indicator lights up.

3 Access the Main Menu screen.

Press **SET UP**.

4 Access the Tuner Set screen.

Press Δ / ∇ to move the highlight bar (arrow) to "TUNER SET", then press **ENTER** or \triangleright .

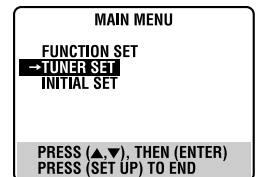

5 Perform Auto Channel Set.

Press Δ / ∇ to move the highlight bar (arrow) to "AUTO CHANNEL SET", then press **ENTER** or \triangleright . You can automatically set the receivable channels in your area in the order of their frequencies.

- When Auto Channel Set is complete, "SCAN COMPLETED" appears on the TV screen.
- If the scan was unsuccessful, "SCAN COMPLETED-NO SIGNAL-" appears on screen. Check the connections and start again.

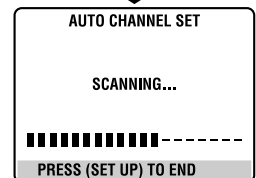
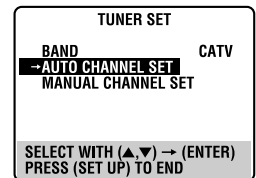

6 Return to the normal screen.

Press **SET UP**.

Manual Channel Set

You can add the channels you want or delete the channels you do not want manually.

1 Turn on the unit.

Press **POWER** (⏻/⏻).

2 Select the VCR deck.

On the unit

Press **VCR/DVD** repeatedly so that the VCR indicator lights up.

On the Remote

Press **VCR** so that the VCR indicator lights up.

3 Access the Main Menu screen.

Press **SET UP**.

4 Access the Tuner Set screen.

Press Δ / ∇ to move the highlight bar (arrow) to "TUNER SET", then press **ENTER** or \triangleright .

5 Access the Manual Channel Set screen.

Press Δ / ∇ to move the highlight bar (arrow) to "MANUAL CHANNEL SET", then press **ENTER** or \triangleright .

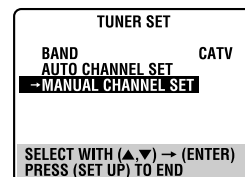

6 Add or skip the desired channels.

To add channels

- 1 Press the **number keys** to input a channel number you want to add.
- 2 Press **ENTER** or \triangleright to set to "ADD".
- 3 Repeat 1 to 2 to add other channels.

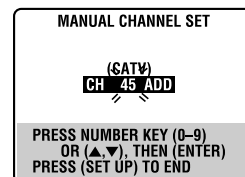

To skip channels

- 1 Press Δ / ∇ or the **number keys** to select a channel number you want to skip.
- 2 Press **ENTER** or \triangleright to set to "SKIP".
- 3 Repeat 1 and 2 to skip other channels.

7 Return to the normal screen.

Press **SET UP**.

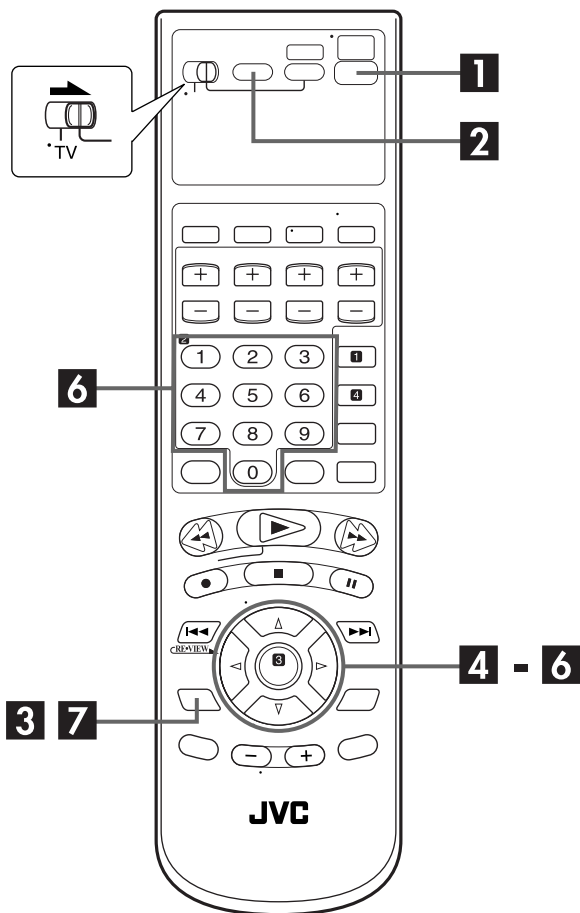

Progressive Scan Mode Set

(VCR deck/DVD deck)

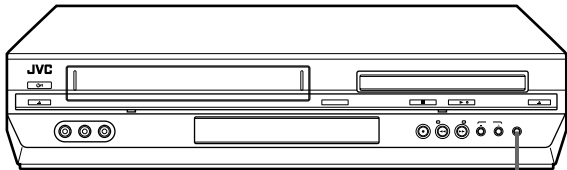

PROGRESSIVE SCAN

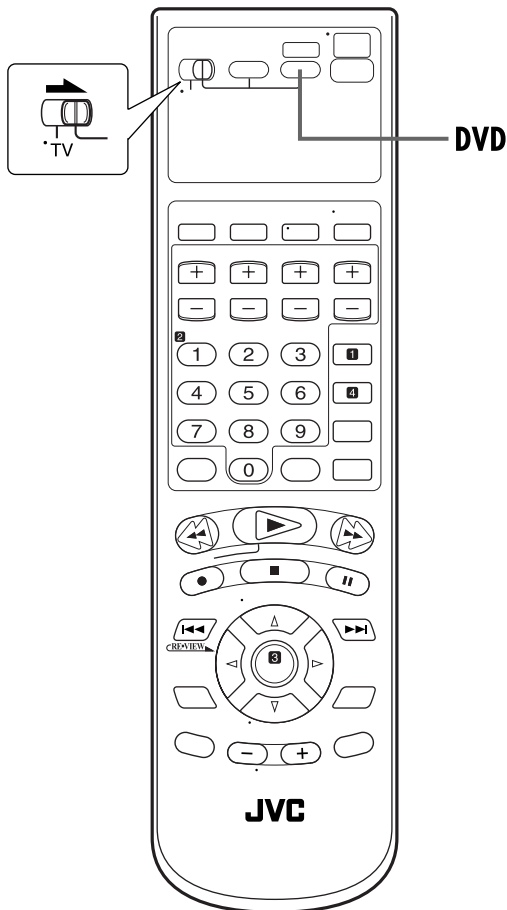

This unit supports the progressive scan system (eg. 480p*) as well as the conventional interlaced scan system (eg. 480i*).

If your TV equipped with component video connectors supports the progressive video input, you can enjoy a high quality picture by setting the progressive scan mode to active on both the VCR deck and the DVD deck.

- Turn on the TV and select the VCR channel (or AV mode).
- Set the TV to the component input mode.
- Slide the **TV/VCR/DVD** switch to the right.

1 Switch the mode.

Press and hold **PROGRESSIVE SCAN** on the unit for more than 3 seconds to change the scan mode between Progressive and Interlace mode, so that the Progressive mode indicator (P) lights up on the front display panel.

- The scan mode can also be changed by pressing **DVD** on the Remote. However, if **DVD** on the Remote is pressed when the VCR deck is selected, the DVD indicator on the unit lights up and the DVD deck is selected. In such a case, watch VHS Progressive pictures by pressing **VCR/DVD** on the unit to switch to the VCR deck.

- Refer also to the instruction manuals supplied with your TV.
- If your TV equipped with component video connectors does not support the progressive video input, do not change the scan mode to the "PROGRESSIVE".

* 480p and 480i indicate the number of scanning lines and scanning format of an image signal.

- 480p indicates 480 scanning lines with progressive format.
- 480i indicates 480 scanning lines with interlaced format.

Basic Playback

- Turn on the TV and select the VCR channel (or AV mode).
- Slide the TV/VCR/DVD switch to the right.

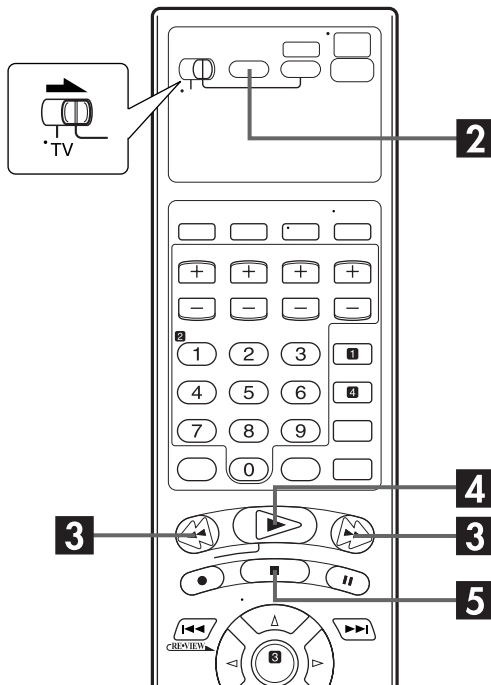
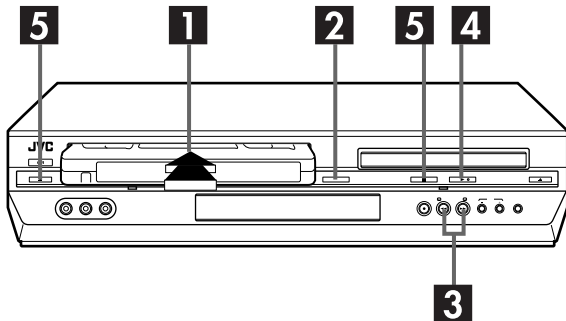

Clean the video heads using a dry cleaning cassette — TOL-3F — when:

- Rough, poor picture appears while a tape is played back.
- The picture is unclear or no picture appears.
- "USE CLEANING CASSETTE" appears on the screen (only with "SUPERIMPOSE" set to "ON"). (ⓘ pg. 75)

NOTE:

The heads get dirty in the following cases:

- in an environment prone to extreme temperature or humidity
- in a dusty environment
- flaw, dirt or mold on video tapes
- continuous usage for a long time

1 Load a cassette.

Make sure the window side is up, the rear label side is facing you and the arrow on the front of the cassette is pointed toward the unit.

- Do not apply too much pressure when inserting.
- The unit's power comes on automatically and the counter is reset to 0:00:00.
- While the DVD deck is selected, the VCR deck is not selected automatically even if a cassette with its record safety tab removed is loaded.

2 Select the VCR deck.

On the unit

Press **VCR/DVD** repeatedly so that the VCR indicator lights up.

On the Remote

Press **VCR** so that the VCR indicator lights up.

3 Find the program start point.

If the tape is advanced past the start point, press **REW** (◀◀). To go forward, press **FF** (▶▶).

4 Start playback.

Press **PLAY** (▶).

5 Stop playback.

Press **STOP** (■). Then press **EJECT** (▲) on the VCR deck to remove the cassette.

Usable cassettes

Full-Size VHS

T-30 (ST-30**)
T-60 (ST-60**)
T90
T-120 (ST-120**)
T-160 (ST-160**)
ST-210**

Compact VHS*

TC-20 (ST-C20**)
TC-30 (ST-C30**)
TC-40 (ST-C40**)

* Compact VHS camcorder recordings can be played on this unit. Simply place the recorded cassette into a VHS Cassette Adapter and it can be used just like any full-sized VHS cassette.

** This unit can record on regular VHS and Super VHS cassettes. However, it will record regular VHS signals only.

- S-VHS recording is not possible with this unit.
- This unit is equipped with SQPB (S-VHS QUASI PLAYBACK) that lets you watch tapes recorded in the S-VHS format and the SP mode with regular VHS resolution.
- SQPB does not deliver Super VHS resolution.

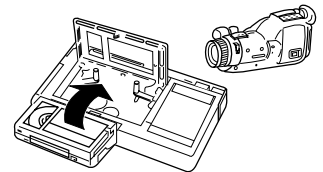

NOTE:

When picture distortion occurs, try Manual Tracking (ⓘ pg. 33) or Video Stabilizer (ⓘ pg. 76). However, these functions might have no effect, depending on the recording condition of the tape.

Playback Features

- Turn on the TV and select the VCR channel (or AV mode).
- Slide the TV/VCR/DVD switch to the right.

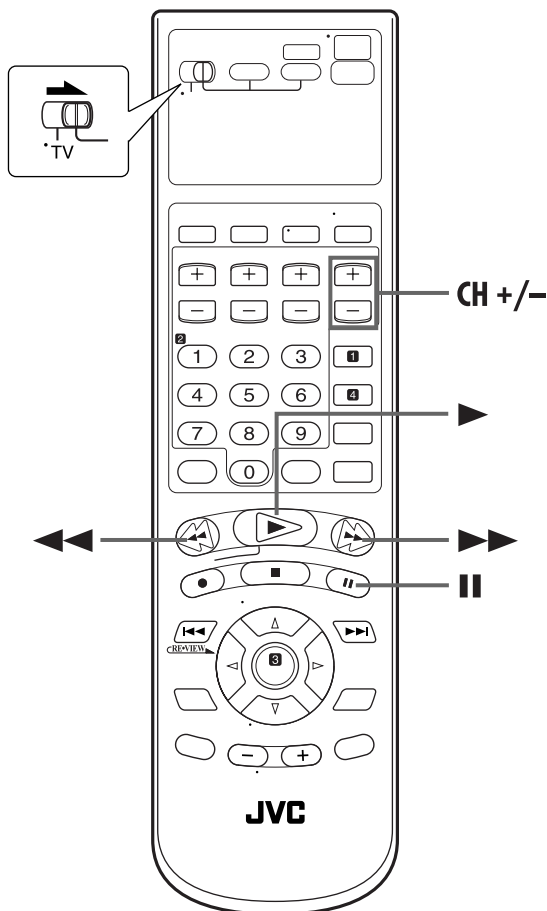
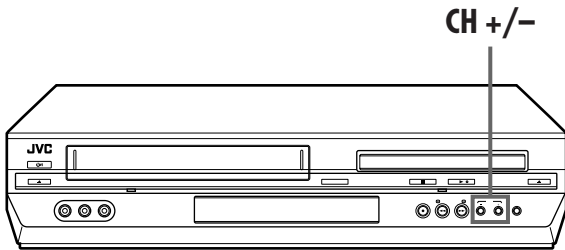

ATTENTION

In the search, still, slow-motion or frame-by-frame playback mode,

- the picture will be distorted.
- the noise bars will appear.
- there may be a loss of color.
- you cannot hear the sound.

Still Picture/Frame-By-Frame Playback

1 Pause during playback.

Press **PAUSE (II)**.

- If there is vertical jitter, press **CH +/-** on the Remote or on the unit to correct the picture.

2 Activate frame-by-frame playback.

Press **PAUSE (II)** to advance a still picture.

Slow Motion

1 Pause during playback.

Press **PAUSE (II)**.

2 Activate slow motion playback.

Press and hold **PAUSE (II)** for 2 seconds, then release. Press **PAUSE (II)** and release again to return to still picture.

NOTE:

During slow motion playback, some noise may appear on the TV screen. Press **CH +** or **-** on the Remote or on the unit to eliminate the noises.

Variable Speed Search

During playback, press **FF (▶▶)** for forward variable speed search, or **REW (◀◀)** for reverse variable speed search.

- The speed changes for each direction by pressing **REW (◀◀)** and **FF (▶▶)** repeatedly.

When pressing **FF (▶▶)**:

(SP): +5x ↔ +7x

(EP): +11x ↔ +21x

When pressing **REW (◀◀)**:

Once **REW (◀◀)** is pressed, reverse search starts in -1x

normal playback speed. After this process, each press of **REW (◀◀)** changes the search speed between -5x and -7x in SP

mode, -11x and -21x in EP mode.

(SP): -1x ↔ -5x ↔ -7x

(EP): -1x ↔ -11x ↔ -21x

To resume normal playback, press **PLAY (▶)**.

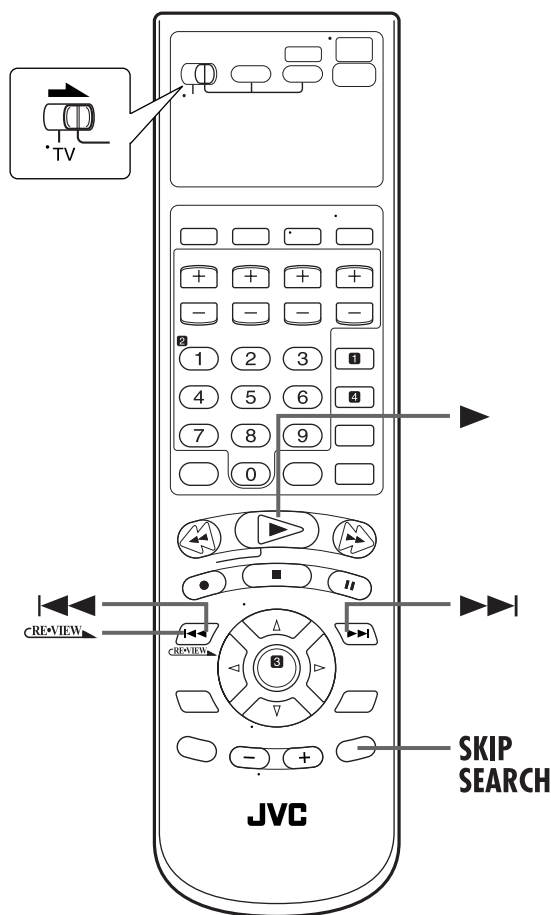

Skip Search

During playback, press **SKIP SEARCH** 1 to 6 times to skip over unwanted sections. Each press initiates a 30-second period of fast-motion playback. Normal playback resumes automatically.

To resume normal playback during a Skip Search, press **PLAY** (▶).

Index Search

Your unit automatically marks index codes at the beginning of each recording. This function gives you quick access to any one of 9 index codes in either direction.

NOTE:

Before starting, make sure the unit is in the Stop mode.

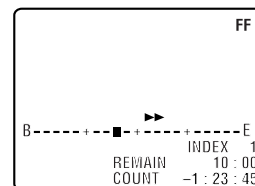

Activate Index Search.

Press **INDEX** (◀◀) or **INDEX** (▶▶). "INDEX -1" or "INDEX 1" is displayed on the TV screen and search begins in the corresponding direction.

- To access index codes 2 through 9, press **INDEX** (◀◀) or **INDEX** (▶▶) repeatedly until the correct index number is displayed.

Example:

To locate the beginning of B from the current position, press **INDEX** (◀◀) twice.

To locate the beginning of D from the current position, press **INDEX** (▶▶) once.

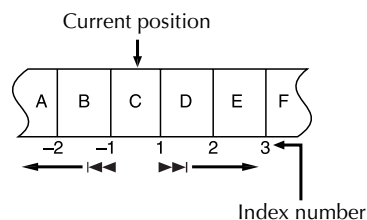

- When the specified index code is located, playback begins automatically.

Instant ReView

Simply by pressing a single button, the unit power comes on, rewinds, and begins playback of the last timer-recorded program. If you have several programs recorded, you can easily access any of them.

NOTE:

Before starting, make sure that the unit is off and that the Timer mode is disengaged.

Activate Instant ReView.

Press **REVIEW**. The unit power comes on and the unit searches for the index code indicating the start of the last timer-recorded program. Once it's found, playback begins automatically.

- To watch the first of the 3 programs, press **REVIEW** three times. The unit searches and begins playback automatically. You can access a program as far as 9 index codes away from the current tape position.

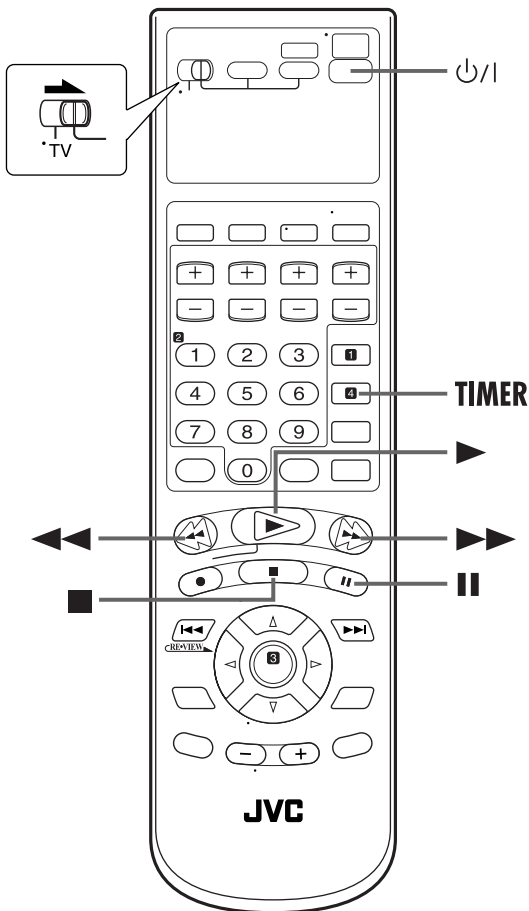
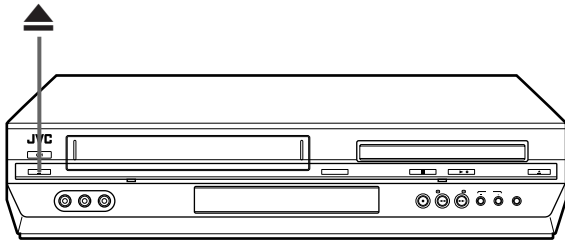

Next Function Memory

The Next Function Memory "tells" the unit what to do after rewinding. Before continuing, make sure the unit is in the Stop mode.

- a- For Automatic Start Of Playback
Press **REW** (◀◀), then press **PLAY** (▶) within 2 seconds.
- b- For Automatic Power Off
Press **REW** (◀◀), then press **POWER** (⏻/⏿) within 2 seconds.
- c- For Automatic Timer Standby
Press **REW** (◀◀), then press **TIMER** within 2 seconds.
- d- For Automatic Cassette Ejection After Tape Rewind
Press **REW** (◀◀), then press **EJECT** (▲) within 2 seconds.

Repeat Playback

Your unit can automatically play back the whole tape 100 times repeatedly.

1 Start playback.

Press **PLAY** (▶).

2 Activate Repeat Playback.

Press **PLAY** (▶) and hold for over 5 seconds, then release.

- The Play indicator (▷) on the front display panel blinks slowly.
- After playing back a tape 100 times, the unit stops automatically.

3 Stop Repeat Playback.

Press **STOP** (■) at any time.

- Pressing **PLAY** (▶), **REW** (◀◀), **FF** (▶▶) or **PAUSE** (||) also stops Repeat Playback.

Manual Tracking

Your unit is equipped with automatic tracking control. During playback, you can override this and adjust the tracking manually by pressing the **CH** buttons.

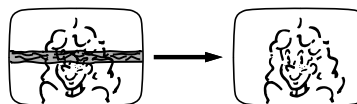

1 Override automatic tracking.

During playback, press **SP/EP** on the Remote.

2 Adjust the tracking manually.

Press **CH +** or **-** on the Remote or on the unit.

- Press **SP/EP** again to return to automatic tracking.

NOTE:

When a new tape is inserted, the unit enters the automatic tracking mode automatically.

Soundtrack Selection

Your unit is capable of recording three soundtracks (HI-FI L, HI-FI R and NORM) and will play back the one you select.

During Playback

Pressing **A.MONITOR** changes the soundtrack as follows:

- You can also select the soundtrack on the Function Set screen. (☞ pg. 77)

TRACK	USE
On-Screen Display	
HI-FI	Hi-Fi sound is played back
HI-FI L	Sound on the left Hi-Fi channel is played back
HI-FI R	Sound on the right Hi-Fi channel is played back
NORM	Sound on the normal track is played back
NORM HI-FI	Both sounds on the Hi-Fi track and normal track are mixed and played back

NOTES:

- "HIFI" should normally be selected. In this mode, Hi-Fi stereo tapes are played back in stereo, and the normal audio track is played back automatically for tapes with only normal audio.
- "SUPERIMPOSE" must be set to "ON" or the on-screen displays will not appear. (☞ pg. 75)

CH +/-

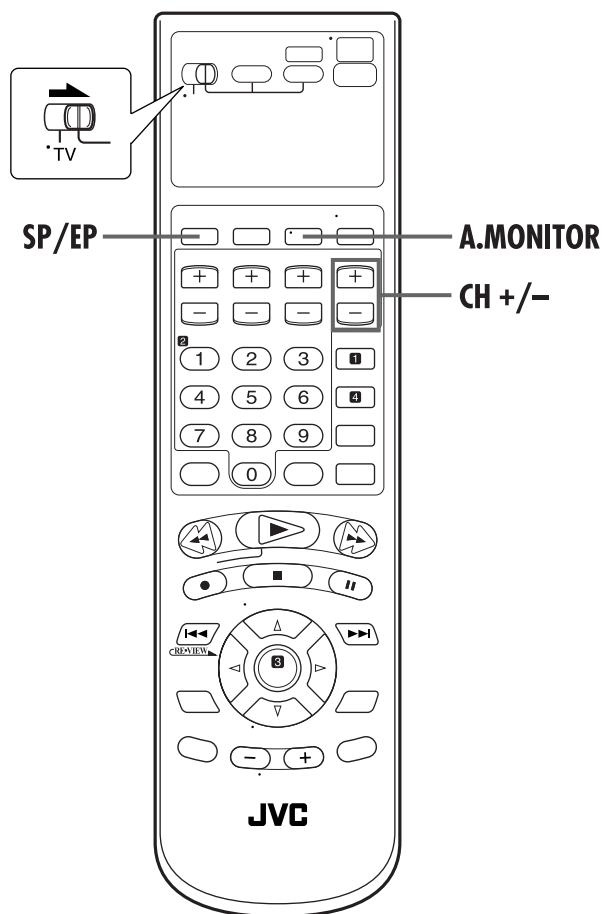
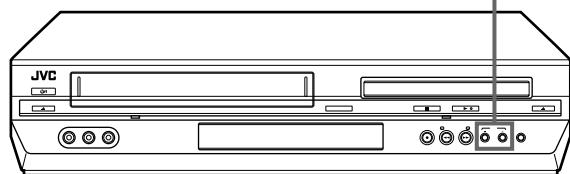

Basic Recording

- Turn on the TV and select the VCR channel (or AV mode).
- Slide the TV/VCR/DVD switch to the right.

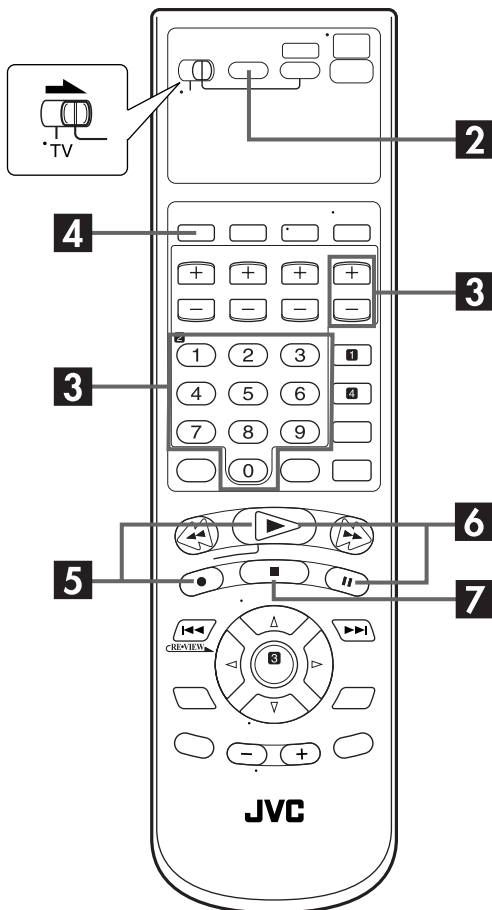
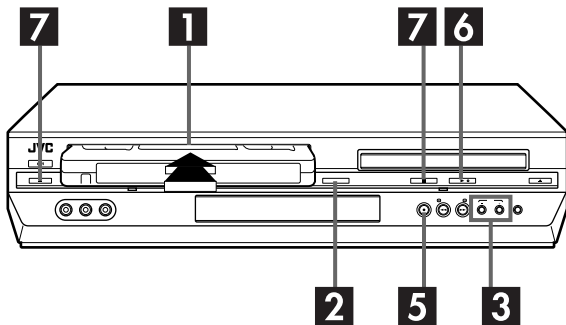

Recording Resume Function

If there is a power outage during recording, Instant Timer Recording or timer recording (see pg. 34, 35, 37), the recording will resume automatically when power is restored to the unit unless the unit's memory backup has expired.

1 Load a cassette.

Insert a cassette with the record safety tab intact.

- The unit's power comes on automatically and the counter is reset to 0:00:00.

2 Select the VCR deck.

On the unit

Press **VCR/DVD** repeatedly so that the VCR indicator lights up.

On the Remote

Press **VCR** so that the VCR indicator lights up.

3 Choose a program.

Press **CH +/-** or the **number keys** to select the channel you wish to record.

4 Set the tape speed.

Press **SP/EP**. The current setting appears on the front display panel or TV screen. Press **SP/EP** again to change the setting while the tape speed is displayed on the TV screen.

5 Start recording.

Press and hold **REC** (●) and press **PLAY** (▶) on the Remote, or press **REC** (●) on the unit.

6 Pause/Resume recording.

Press **PAUSE** (||). Press **PLAY** (▶) to resume recording.

- You can select channel during the Record Pause mode.

7 Stop recording.

Press **STOP** (■). Then press **EJECT** (▲) on the VCR deck to remove the cassette.

Recording Features

- Turn on the TV and select the VCR channel (or AV mode).
- Slide the **TV/VCR/DVD** switch to the right.

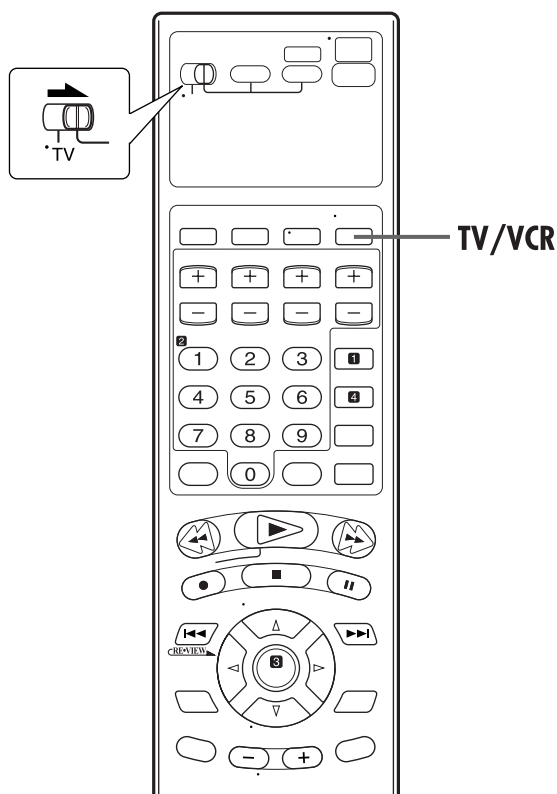
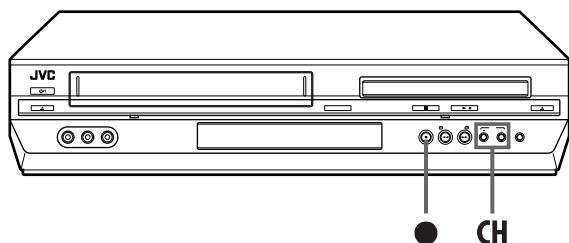

Record One Program While Watching Another

If your unit is connected to the TV via the AV connection, press **TV/VCR**. The VCR indicator on the front display panel and the TV broadcast being recorded disappear. Once recording is in progress, all you need to do is to set the channel controls on the TV for the station you wish to view.

- The program selected with the TV's channel controls appears on the TV screen, while the one selected with the unit's **CH** buttons is recorded on the tape.

NOTE:

You can also use the DVD deck in the following cases. Before use, be sure to turn on the unit and select the DVD deck.

- During recording
- During timer recording
- During timer standby mode

Instant Timer Recording (ITR)

This easy method lets you record for from 30 minutes to 6 hours (selectable in 30-min. increments), and shuts the unit off after recording is finished.

1 Start recording.

Press **REC** (●) on the unit.

2 Engage the ITR mode.

Press **REC** (●) again. "○" blinks and "0:30" appears on the front display panel.

3 Set the recording duration.

If you want to record for more than 30 minutes, press **REC** (●) to extend the time. Each press extends recording time by 30 minutes.

NOTES:

- You can only perform ITR using the **REC** (●) button on the unit's front panel.
- Still picture playback stops automatically after 5 minutes to protect the heads.
- When the end of the tape is reached during timer recording, the unit stops and "○" and "▷" blink on the front display panel.
- When the end of the tape is reached during timer recording or Instant Timer Recording, the unit is turned off and "○" and "▷" blink on the front display panel.
- During Instant Timer Recording, any other timer programmed recording won't start even if their start time has come. In such a case, the timer programmed recording starts (if the end time of the timer programmed recording is set after the end of Instant Timer Recording) after the Instant Timer Recording finishes.

Accidental erasure prevention

To prevent accidental recording on a recorded cassette, remove its safety tab. To record on it later, cover the hole with adhesive tape.

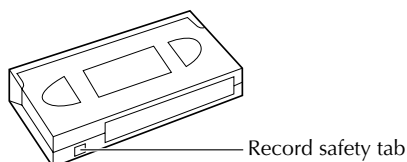

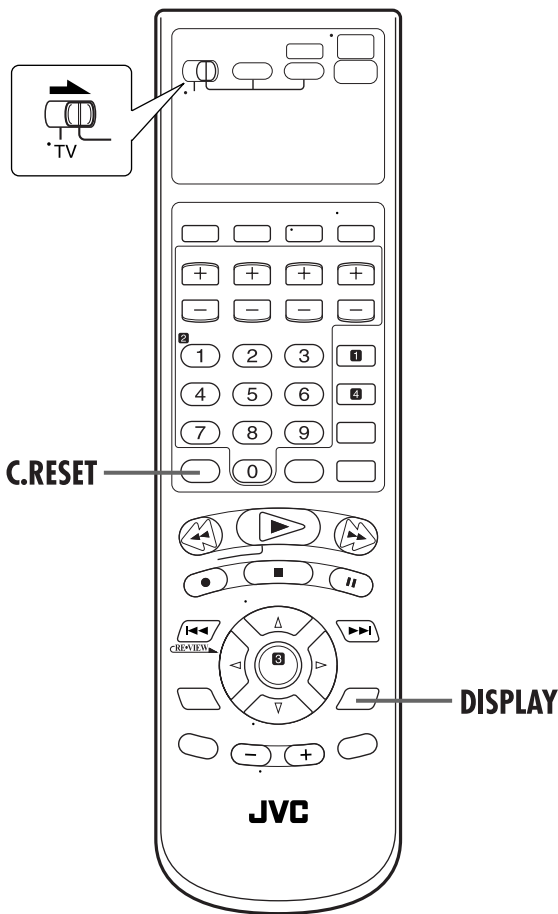

Elapsed Recording Time Indication

1 Set the counter display.

Press **DISPLAY** until a counter reading appears on the front display panel.

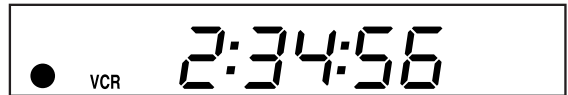

2 Reset the counter.

Press **C.RESET** before starting recording or playback.

- The counter is reset to "0:00:00" and shows the exact elapsed time as the tape runs. You can check the exact time of a recording or playback.

Tape Remaining Time

Press **DISPLAY** until the time remaining on the tape appears.

- The front display panel shows the tape remaining time with ":" blinking.



- By pressing the **DISPLAY** button, you can change display to show the channel position*, clock time, counter reading or tape remaining time.

* Channel position is not displayed during playback.

NOTES:

- When you press **ON SCREEN**, the on-screen display appears on the TV screen for 5 seconds, then the displays other than the counter disappears. To clear the counter display, press **ON SCREEN**.
- Depending on the type of tape being used, the tape remaining time reading may not appear right away, or is not correct. "--:--" may sometimes appear with ":" blinking, or the display may blink on occasion.

Second Audio Recording

This unit's built-in MTS decoder enables reception of Multichannel TV Sound broadcast. To record a SAP program received, set "2ND AUDIO RECORD" to "ON". (pg. 77)

NOTE:

When the channel is changed on the unit;

- The "STEREO" indicator appears on the screen for about 5 seconds if the program is a stereo broadcast.
- The "SAP" indicator appears on the screen for about 5 seconds if the program is a SAP broadcast.
- Both indicators appear when a stereo program is accompanied by SAP sound.

Express Timer Programming

Before performing Express Timer Programming:

- Make sure that the unit's built-in clock is set properly.
- Insert a cassette with the safety tab in place. The unit will come on automatically.
- Turn on the TV and select the VCR channel (or AV mode).
- Slide the TV/VCR/DVD switch to the right.

Example: To timer-record the program from 8:00 PM to 10:00 PM on 24th December, on channel 12.

1 Select the VCR deck.

On the unit

Press **VCR/DVD** repeatedly so that the VCR indicator lights up.

On the Remote

Press **VCR** so that the VCR indicator lights up.

2 Access the Program screen.

Press **PROG.** (If you're just starting out, "PROGRAM 1" appears.)

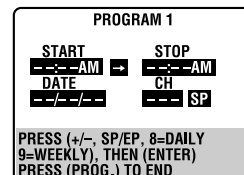

3 Enter the program start time.

Press **START +/-** to enter the time you want recording to start.

- Press and hold **START +/-** to move in 30-minute increments, or press and release repeatedly to move 1 minute at a time.

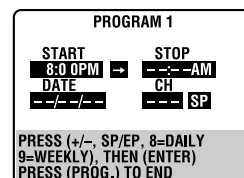

4 Enter the program stop time.

Press **STOP +/-** to enter the time you want recording to stop.

- Press and hold **STOP +/-** to move in 30-minute increments, or press and release repeatedly to move 1 minute at a time.

5 Enter the program date.

Press **DATE +/-**.

- The current date appears on the TV screen. The date you enter appears in its place.

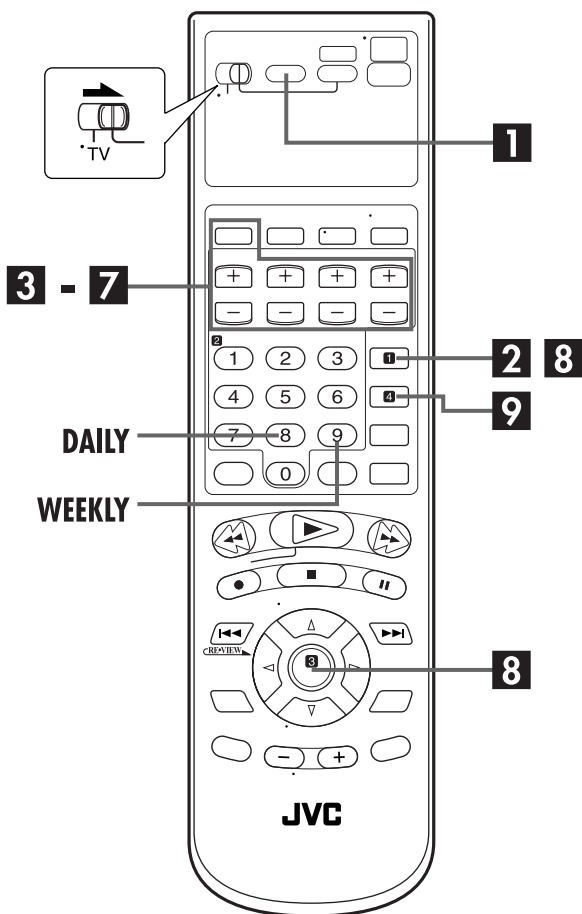

6 Enter the channel position.

Press CH +/-.

7 Set the tape speed.

Press SP/EP.

8 Return to the normal screen.

Press **PROG.** or **ENTER**. "PROGRAM COMPLETED" appears on the TV screen for about 5 seconds, then the normal screen appears. If "PROGRAM NOT COMPLETED PROGRAM OVERLAP" appears on the TV screen, see page 40.

- Repeat steps **2** – **8** for each additional program.

9 Engage the unit's timer mode.

Press **TIMER**. The unit turns off automatically and "⊕" appears on the front display panel.

- To disengage the timer mode, press **TIMER** again.

To Timer-Record Weekly Or Daily Serials:

— anytime during steps **3** through **7**, press **WEEKLY** (number key "9") for weekly serials or **DAILY** (number key "8") for daily serials (Monday – Friday). Either "WEEKLY" or "DAILY" appears on the TV screen. Pressing the button again makes the corresponding indication disappear.

NOTES:

- You can program this unit to timer-record as many as 8 programs. If you try to program the unit to record a ninth, "PROGRAM FULL" appears on the TV screen. To record the extra program, you must first cancel any unnecessary programs. (☞ pg. 39)
- Programs that start after midnight must have the next day's date.

Cable Box or DBS Receiver Users

To timer-record a satellite broadcast using Express Timer Programming:

- 1 Perform steps **1** – **9**. Enter "F-1" for the channel position in step **6**.
- 2 Set the DBS receiver to the appropriate channel before the selected program begins.
- 3 Leave the DBS receiver's power on.

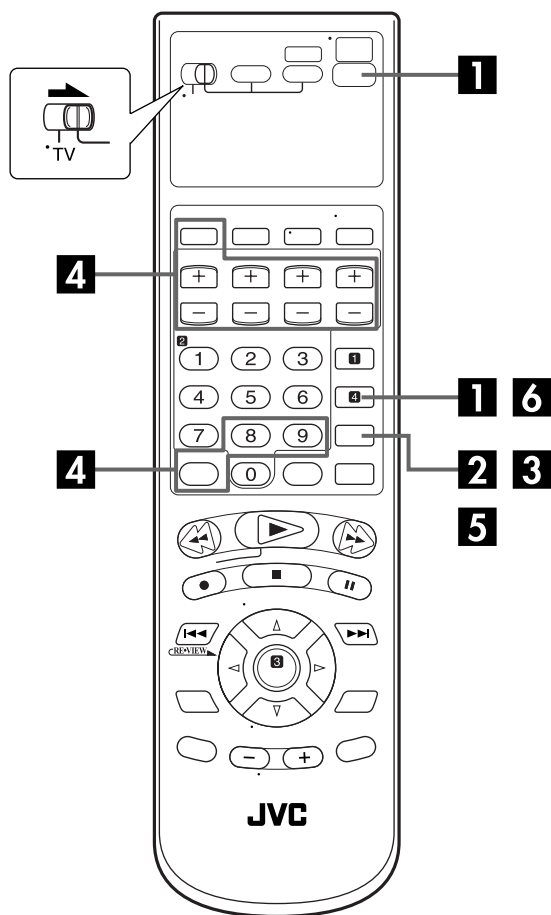

Check, cancel and change programs

1 Disengage the timer mode.

Press **TIMER**, then press **POWER** (⏻/⏻).

2 Access the Program Check screen.

Press **PROG. CHECK**.

PR	START	STOP	CH	DATE
1	8:00P	10:00	12	12/24
2	10:00A	10:45	40	12/25
3	11:30P	1:00	125	12/25
4				
5				
6				
7				
8				

PRESS (CHECK) TO NEXT

3 Access the Program screen.

Press **PROG. CHECK** again to check more information. Each time you press **PROG. CHECK**, the next program's information appears.

PROGRAM 1			
START	STOP	DATE	CH
8:00AM	10:00AM	12/24/03	12 SP
WED	TV		

PRESS (CANCEL) TO CANCEL
PRESS (CHECK) TO NEXT

To cancel or change a program

4 Cancel or change a program.

Press **CANCEL** to cancel a program. To change program settings, press the appropriate button: **START** +/-, **STOP** +/-, **DATE** +/-, **CH** +/-, **DAILY** (number key "8"), **WEEKLY** (number key "9") and/or **SP/EP**.

5 Return to the normal screen.

Press **PROG. CHECK** as many times as necessary. If there are still some programs remaining, go on to step **6**.

6 Return to the timer mode.

Press **TIMER**.

When programs overlap each other

If "PROGRAM NOT COMPLETED PROGRAM OVERLAP" appears, you have another program overlapping the program you have just made.

The Program Check screen appears and conflicting programs will start blinking.

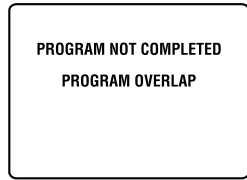
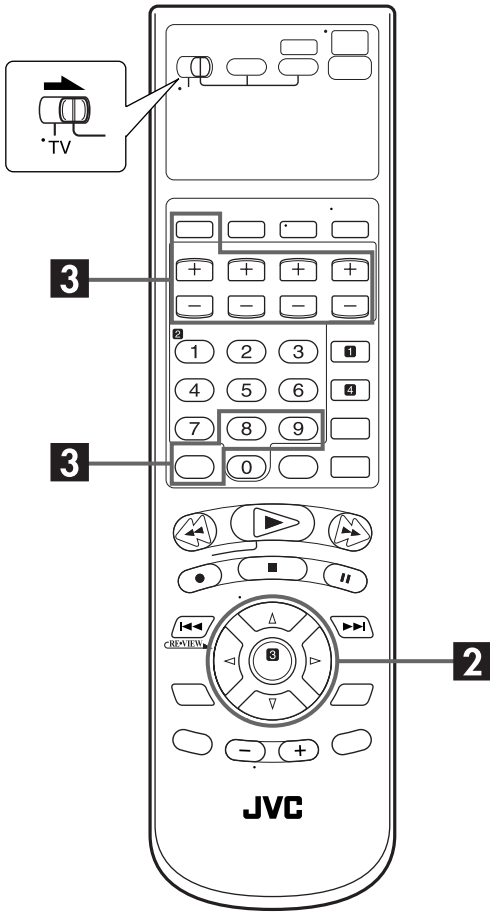

PR	START	STOP	CH	DATE
1	8:00P	10:00	12	12/24
2	10:00A	10:45	40	12/25
3	11:30P	1:00	125	12/25
4	9:00P	10:00	10	12/24
5				
6				
7				
8				

(▲,▼), THEN (▶) (PROG.): END

Example: Program 1 (you have just made) and Program 4 overlap each other.

1 Confirm the overlapping programs.

Overlapping programs blink on the TV screen.

2 Select the program to modify.

Press Δ / ∇ , then press **ENTER** or \triangleright .

- You can only select one of the overlapping programs.

NOTE:

If you do not mind this overlap, press **PROG.** to finish the timer program setting. The program with the lower program number will be recorded and the other will not be recorded correctly. If no changes are made for approximately 1 minute, the unit will return to the normal screen.

3 Cancel or change program setting.

To cancel a program, press **CANCEL** when the Program screen you do not want is shown. "PROGRAM COMPLETED" appears on the TV screen for about 5 seconds, then the normal screen appears.

To change a program, press the appropriate button: **START +/-**, **STOP +/-**, **DATE +/-**, **CH +/-**, **DAILY** (number key "8"), **WEEKLY** (number key "9") and/or **SP/EP** when the Program screen on which you want to make changes is shown, then press **ENTER**. "PROGRAM COMPLETED" appears on the TV screen for about 5 seconds, then the normal screen appears.

NOTE:

If the overlap is not yet solved, or another overlap occurs with the timer program setting after making the last correction on a program, the conflicting programs will be shown on the Program Check screen again. Repeat the above steps again until the overlap is solved.

ATTENTION

If there is a conflict in the timer schedule and one program overlaps with another, only the parts shown below in gray will be recorded.

Pattern 1: The program with the lower program number will be recorded.

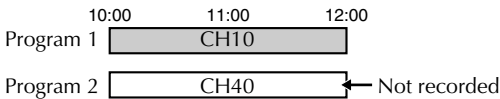

Pattern 2: The program starting earlier will be recorded.

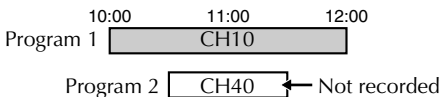

Pattern 3: The program starting earlier will be recorded, followed by the remaining portion of the other program.

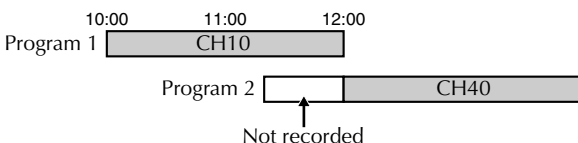

Satellite Auto Recording

This function allows you to automatically record a satellite program which is timer-programed on your external DBS receiver. Connect a DBS receiver to the unit's AUDIO/VIDEO input (F-1) connector and program the timer on the DBS receiver. The unit starts or stops recording by the signals input from the DBS receiver. After recording, the unit's power shuts off automatically.

- You can also connect the cable box if it has a timer.

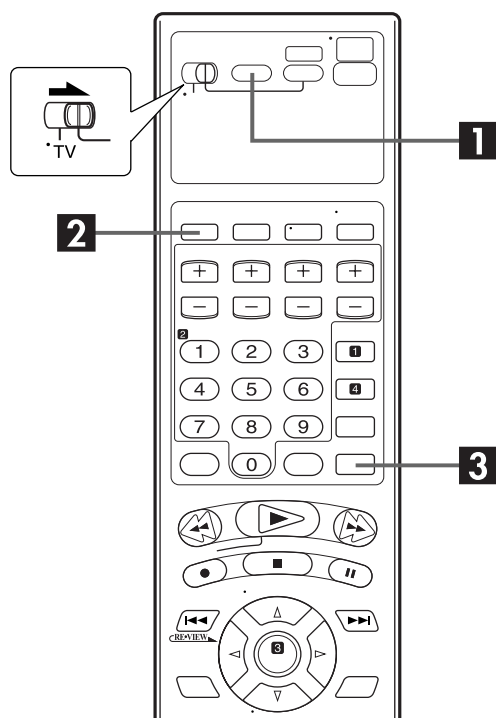

ATTENTION

- Be sure not to turn on the DBS receiver before the program is executed; otherwise, the unit will start recording when the DBS receiver's power is turned on.
- If you have connected another appliance other than a DBS receiver to the AUDIO/VIDEO input (F-1) connector, be sure not to engage the Satellite Auto Recording mode; otherwise, the unit will start recording when the connected appliance's power is turned on.
- Satellite Auto Recording and timer-recording cannot be done at the same time.

Before performing the following steps:

- Make sure the DBS receiver is connected to the unit's AUDIO/VIDEO input (F-1) connector.
- Program the timer on the DBS receiver.
- Insert a cassette with the safety tab in place.
- Slide the TV/VCR/DVD switch to the right.

1 Select the VCR deck.

On the unit

Press **VCR/DVD** repeatedly so that the VCR indicator lights up.

On the Remote

Press **VCR** so that the VCR indicator lights up.

2 Set the tape speed.

Press **SP/EP**.

3 Engage the Satellite Auto Recording mode.

Press and hold **REC LINK** for about 2 seconds. The "⏸" and "⊕" indicators light up and the unit turns off automatically.



NOTES:

- Operation on the DVD deck are not possible when the Automatic Satellite Program Recording mode is engaged, or timer recording is in progress.
- To disengage the Satellite Auto Recording mode, press **REC LINK**. The "⏸" indicator goes off.
- If the unit's power is off, it is not possible to engage the Satellite Auto Recording mode.
- In step 3, if the "⏸" indicator does not light but instead blinks quickly even though your DBS receiver's power is off, Satellite Auto Recording will not work properly with that DBS receiver*. If this is the case, perform "Express Timer Programming" (pg. 37) to timer-record a satellite program.
* Some DBS receivers output signals even if the power is off. Satellite Auto Recording is not possible with those DBS receivers.
- The "⏸" indicator blinks while Satellite Auto Recording is in progress.
- For timer programming of the DBS receiver, refer to the instruction manual of the DBS receiver.
- Satellite Auto Recording is not possible if your DBS receiver does not have a timer.
- Pressing the unit's **POWER** (⏻) button while Satellite Auto Recording is in progress turns off the unit's power and disengages the Satellite Auto Recording mode.
- If there are more than one satellite programs you wish to record with Satellite Auto Recording, it is not possible to set different tape speeds for each program.
- Depending on the type of DBS receiver, the unit may not record a slight portion of the beginning of the program or may record slightly longer than the actual length of the program.
- If you engage the Satellite Auto Recording mode when the DBS receiver's power is on, the unit will not start Satellite Auto Recording even though the "⏸" and "⊕" indicators blink. When the DBS receiver shuts off once and is turned back on again, the unit starts recording.
- You can also record a program from your cable system in the same way if the system has a timer.

Basic Playback



- Turn on the TV and select the VCR channel (or AV mode).
- Slide the **TV/VCR/DVD** switch to the right.

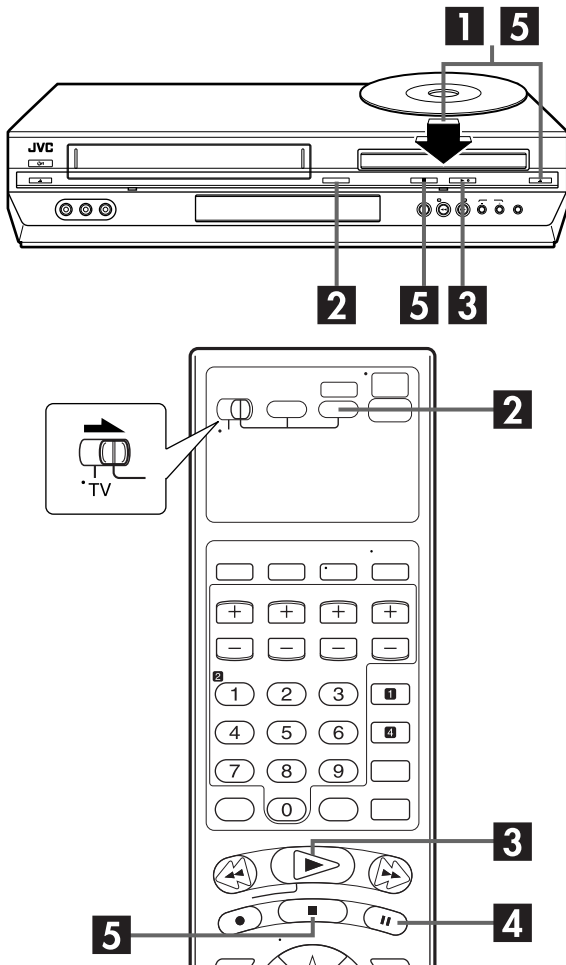

ATTENTION

- You can not use the DVD deck when the VCR deck is in the Automatic Satellite Recording standby and recording mode.
- You can use the DVD deck when the VCR deck is in the timer standby mode.

To play back a MP3/JPEG disc, see pages 62 – 67.

1 Load the disc.

- 1 Press **OPEN/CLOSE** (▲) on the DVD deck to open the disc tray.
 - The unit's power comes on automatically.
 - The DVD opening screen will automatically appear approximately 5 seconds after the unit's power has come on.
- 2 Place the disc in the disc tray.
 - For details, refer to "Placing a Disc" (☞ pg. 9).

- 3 Press **OPEN/CLOSE** (▲) on the DVD deck to close the disc tray.
 - Pressing **PLAY** (▶) also closes the disc tray.
 - While the VCR deck is selected, playback does not begin automatically even if the auto-playback DVD disc is loaded.
 - "no dc" appears on the front display panel when there is no disc present on the disc tray.

2 Select the DVD deck.

On the unit

Press **VCR/DVD** repeatedly so that the DVD indicator lights up.

On the Remote

Press **DVD** so that the DVD indicator lights up.

3 Start playback.

Press **PLAY** (▶).

Example: DVD VIDEO

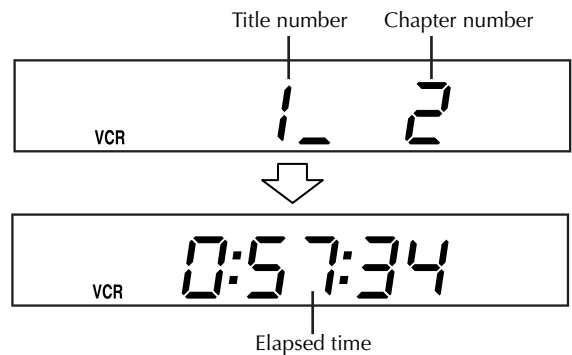

- You can switch the display on the front display panel between the title number/chapter number and the elapsed time by pressing **DISPLAY**.
- It may take a few seconds to start playback.
- If you load a DVD disc whose region code does not match the DVD deck, "REGION CODE ERROR!" appears on the TV screen. For details, refer to "Region Number" (☞ pg. 7).
- With Video CD discs with PBC control or some DVD discs, the menu display may appear on the TV screen after starting playback. In this case, select an item which you want to play back from the menu. Otherwise, the playback cannot go forward. Refer to "Locating a desired scene using the menu of the Video CD with PBC" (☞ pg. 43) or "Locating a desired scene using the DVD menu" (☞ pg. 43).

4 Pause playback.

Press **PAUSE** (⏸).

- To resume normal playback, press **PLAY** (▶).

5 Stop playback.

Press **STOP** (■). Press **OPEN/CLOSE** (▲) on the DVD deck to open the disc tray, then remove the disc.

- Pressing **PLAY** (▶) resume playback from the position where you stop playback. For details, see "Resume Function" on page 45.

NOTE:

When you press **OPEN/CLOSE** (▲) while the unit is turned off, the unit's power comes on and the disc tray opens automatically.

Playback Features

- Turn on the TV and select the VCR channel (or AV mode).
- Slide the TV/VCR/DVD switch to the right.

ATTENTION

When the unit is switched to the VCR deck during playback mode on the DVD deck, the unit enters Resume Stop mode on the DVD deck. (☞ pg. 45)

Playback Control (PBC) Function — Locating a desired scene using the menu of the Video CD with PBC



Some Video CD discs supports the PBC function. PBC is an abbreviation of "PlayBack Control." A Video CD disc recorded with PBC has its own menus, such as a list of the songs of the disc. You can locate a specific scene by using the menu.

1 Access the PBC menu.

In stop mode

Press **PLAY** (▶).

- Depending on a disc, PBC menu may automatically appear on the TV screen by simply loading a disc on the unit. "Pbc" appears on the front display panel.

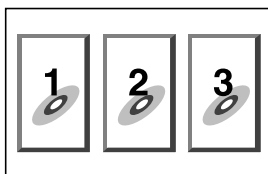

Example:



2 Start playback.

Press the appropriate **number keys**.

- The unit starts playback of the selected item.
- When "NEXT" or "PREVIOUS" appears on the TV screen: Pressing **SKIP** (▶▶) advances to the next page. Pressing **SKIP** (◀◀) returns to the previous page.
- You can return to the menu by pressing **RETURN**.
- The method of the operation is different depending on the disc.

NOTES:

- If you want to playback a PBC-compatible Video CD disc without activating the PBC function, start playback by using the **number keys** instead of the **PLAY** (▶) button.
- To activate the PBC function when a PBC-compatible Video CD disc is being played back without the PBC function, press **TOP MENU** or **MENU**, or press **STOP** (■) (press twice when "RESUME" is set to "ON") then press **PLAY** (▶).

Locating a desired scene using the DVD menu



DVD VIDEO discs may have two types of the menus; top menu and disc menu.

Top menu

DVD discs generally have their own menus which show the disc contents. These menus contain various items such as titles of a movie, names of songs, or artist information. You can locate a desired scene by using the top menu displayed on the TV screen. Press **TOP MENU** to access the top menu.

Disc menu

DVD discs have the disc menu to select subtitle and audio language etc. for each title. Press **MENU** to access the disc menu.

1 Access the DVD menu.

Press **TOP MENU** or **MENU**.

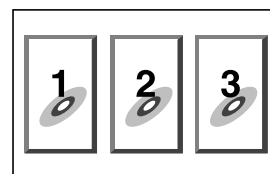

Example:

2 Start playback.

Press **△▽◀▶** to select a desired item, then press **ENTER**.

- It may be possible to select the desired item using the **number keys** depending on the disc.

NOTES:

- When "⊙" appears on the TV screen in step 1, the disc does not have a top menu or disc menu.
- Top menu or disc menu may not appear depending on the discs even if it is recorded in DVD VIDEO format and finalized. In that case, press **STOP** (■) to display the total number of titles on a disc, then press the appropriate **number keys** to select the desired title.
- If the VCR deck is selected during playback, the unit enters Resume Stop mode. When "RESUME" is set to "OFF", the unit starts playback from the beginning of the disc.
- When switched to the VCR deck, it takes approximately 10 seconds to display the VCR screen.

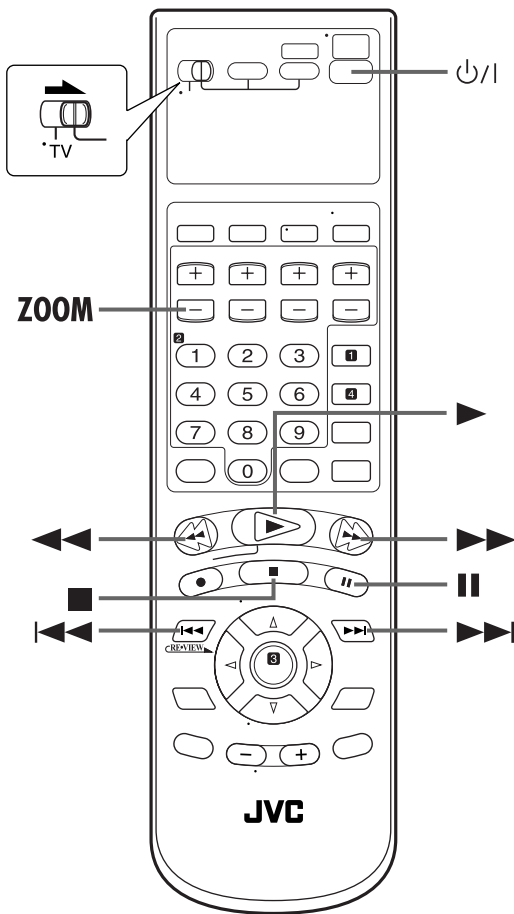

Locating the start point of the item or skip the item



Press **SKIP** (◀◀) or **SKIP** (▶▶) during playback.

Example:

To locate the beginning of item B from the current position, press **SKIP** (◀◀) twice.

To locate the beginning of item D from the current position, press **SKIP** (▶▶) once.

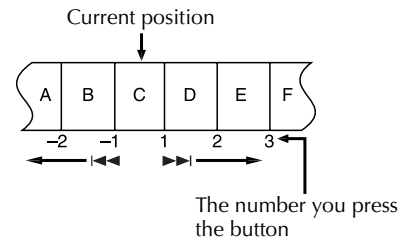

- When the specified item is located, playback begins automatically.

NOTE:

When you press **SKIP** (◀◀) or **SKIP** (▶▶), the counter display may appear instead of title number/chapter number depending on the discs.

Variable Speed Search



During playback, press **FF** (▶▶) for forward variable speed search, or **REW** (◀◀) for reverse variable speed search.

- The more times you press, the faster the playback picture moves.
- To resume normal playback, press **PLAY** (▶).

OR

During playback, press and hold **SKIP** (▶▶) for forward search, or press and hold **SKIP** (◀◀) for reverse search.

- While you press and hold the button, the image is played back at 5x speed.
- To resume normal playback, release **SKIP** (◀◀) or **SKIP** (▶▶).

NOTES:

- Actual speed may be different from that displayed on the TV screen depending on the discs.
- Playback sound is not heard in any variable speed search mode.

Still Picture/Frame-By-Frame Playback



1 Pause during playback.

Press **PAUSE** (II).

2 Activate frame-by-frame playback.

Press **PAUSE** (II) to advance a still picture.

- To resume normal playback, press **PLAY** (▶).

Slow Motion



During playback, press **PAUSE** (II), then press **REW** (◀◀) for reverse slow motion playback, or **FF** (▶▶) for forward slow motion playback.

- Each press of **FF** (▶▶) changes the playback speed as follows: 1/32→1/16→1/8→1/4→1/2
- Each press of **REW** (◀◀) changes the playback speed as follows (only for DVD VIDEO discs): -1/32→-1/16→-1/8→-1/4→-1/2
- To resume normal playback, press **PLAY** (▶).

NOTES:

- Reverse slow motion playback is possible only with the DVD VIDEO discs.
- This function may not work for some Video CD or SVCD.

Resume Function



It is possible to memorize positions where you stop playback and resume playback from that position.

- Be sure to set "RESUME" to "ON". (ⓘ pg. 81)

1 Memorize the resume point.

Press **STOP** (■) during playback.

- "rESuM" appears on the front display panel.



- The unit enters Resume Stop mode and memorizes the position where you stop playback as the resume point.
- To clear the resume point:
 - Press **STOP** (■) in stop mode.
 - Press **POWER** (⏻) to turn off the unit.
 - Eject the disc.
 - Set "RESUME" to "OFF". (ⓘ pg. 81)

2 Resume playback.

Press **PLAY** (▶). The unit starts playback from the resume point.

NOTES:

- Resume Function does not work on the Audio CD. It also may not work depending on the discs.
- If you stop the playback of a disc for which a resume point has already been memorized, the memory will be updated with the new resume point.
- When the unit memorizes a resume point, it also remembers audio language, subtitle and angle settings.
- This function may not work for some Video CD or SVCD.
- If the VCR deck is selected during playback, the unit enters Resume Stop mode. When "RESUME" is set to "OFF", the unit starts playback from the beginning of the disc.

Zooming



Press **ZOOM** during playback or while paused.

- Each press of **ZOOM** changes the magnification in the following steps:
ZOOM OFF → ZOOM 1 → ZOOM 2 → ZOOM 3 → ZOOM 4 → ZOOM 5 → ZOOM 6 → (Back to the beginning)
- When a 16:9 aspect picture source is displayed on a 4:3 aspect TV (conventional TV) in Letter Box conversion mode, the margins in black shown on top and bottom of the TV screen will be cropped and both left and right side parts of the picture will also be cropped. You may not move up or down the zoomed-in scene depending on the zooming magnification.
- While zoomed, the picture may look coarse or distorted.

Current magnification

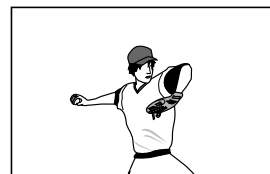

Zoomed-in area

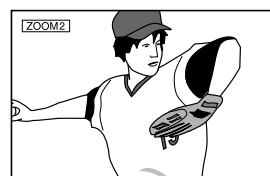

Press **△▽◀▶** to move the zoomed-in scene.

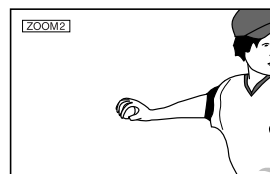

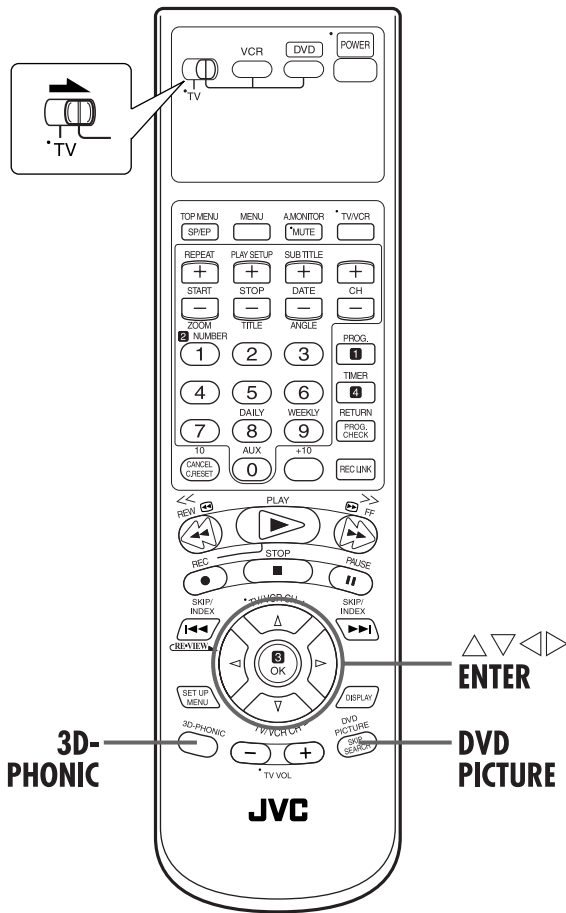

3D Phonic



3D Phonic function allows you to get a simulated surround effect from your stereo system. You can enjoy the vertical surround sound with your 2-channel stereo system.

1 Access the selection menu.

Press **3D-PHONIC** during playback.

- The current setting appears on the right bottom corner of the TV screen.

2 Select the mode.

Press **3D-PHONIC** repeatedly.

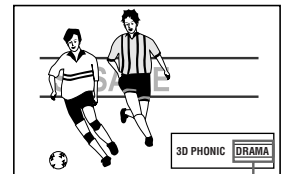

Selected mode

- Each time you press **3D-PHONIC**, the setting changes as follows:
OFF → ACTION → DRAMA → THEATER → (Back to the beginning)

OFF:	No effect
ACTION:	Suitable for action movies and sports programs in which sounds dynamically move.
DRAMA:	Provides the natural and warm sound. You can enjoy movies in a relaxed mood.
THEATER:	You can enjoy sound effects like in a major theater.

- The selection menu disappears automatically if you do not change the selection for 5 seconds.

NOTES:

- The 3D Phonic function works correctly only when playing back a DVD VIDEO disc recorded in the multi channel Digital format. With other sources, you cannot get any effect if you activate 3D Phonic function.
- When playing back a DVD VIDEO disc recorded with the Dolby Digital that does not contain the rear signal, you cannot get a correct 3D Phonic sound even if you activate 3D Phonic function.
- The 3D Phonic function does not affect the Digital bitstream signal from the DIGITAL AUDIO OUT connector.
- When 3D Phonic function is activated, Down Mix and D. Range Compression functions are disabled. (☞ pg. 80)

VFP function

— Adjusting the picture quality



The VFP (Video Fine Processor) function enables you to adjust the picture character according to the type of programing, picture tone or personal preference.

NOTE:

Before you start operation;
The VFP setting screen disappears if no operations are done for more than about 10 seconds. If the setting screen disappears before you finish, start from step 1 again.

1 Access the VFP setting menu.

Press **DVD PICTURE** during playback.

- The current setting appears on the TV screen.

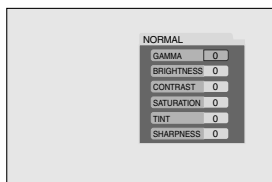

2 Select the VFP mode.

Press $\triangleleft \triangleright$ repeatedly.

- Each time you press $\triangleleft \triangleright$, the VFP mode changes as follows:
NORMAL → CINEMA → USER 1 → USER 2 → (Back to the beginning)

NORMAL:	Select this normally.
CINEMA:	Suitable for movie.
USER 1/ USER 2:	You can adjust parameters that affect picture appearance and store settings. Go to step 3.

NOTE:

You cannot adjust the parameters of "NORMAL" and "CINEMA".

To adjust picture appearance manually

3 Access USER menu.

Press $\triangleleft \triangleright$ repeatedly to select "USER 1" or "USER 2".

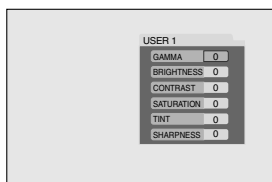

4 Select the parameter.

Press $\triangle \nabla$ repeatedly to select a parameter you want to adjust, then press **ENTER**.

- Adjust gradually and confirm picture appearance results are as preferred.

GAMMA (-3 to +3):	Controls brightness of neutral tints while maintaining brightness of dark and bright portions.
BRIGHTNESS (-8 to +8):	Controls screen brightness.
CONTRAST (-7 to +7):	Controls screen contrast.
SATURATION (-7 to +7):	Controls screen color depth.
TINT (-7 to +7):	Controls screen tint.
SHARPNESS (-8 to +8):	Controls screen sharpness.

- VFP menu disappears and the following pop-up window appears on the TV screen.

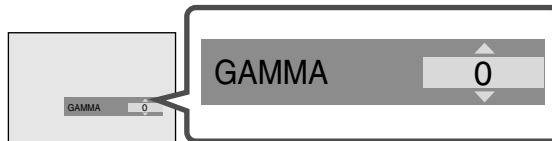

- The selection menu disappears automatically if you do not change the selection for 10 seconds.

5 Adjust the parameter.

Press $\triangle \nabla$ repeatedly to change the setting, then press **ENTER**.

- The current VFP settings appear again.

6 Adjust the other parameters.

Repeat steps 4 and 5 to adjust other parameters.

To return to the normal screen

Press **DVD PICTURE**.

To activate your setting

Press **DVD PICTURE**, then press $\triangleleft \triangleright$ repeatedly to select "USER 1" or "USER 2" that you have changed the parameters.

Using the on-screen bar



You can check disc information while the disc is loaded and you can use some functions using the on-screen bar. The on-screen bar allows you the various playback operations.

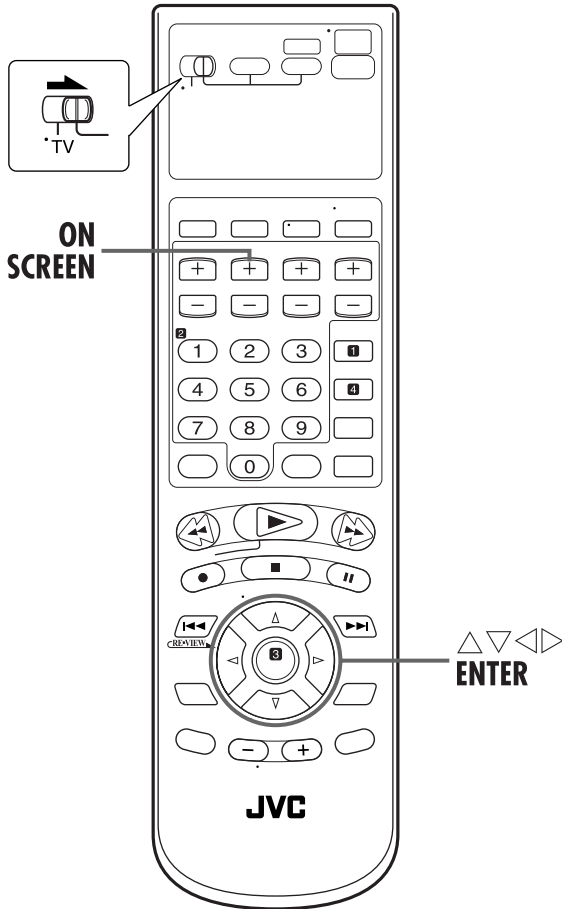

How to Access the on-screen bar

Press **ON SCREEN** twice whenever a disc is loaded.

Example: During DVD VIDEO playback



Example: During Video CD playback



Contents of the on-screen bar during playback

DVD

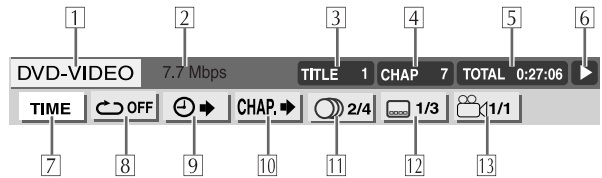

Video CD

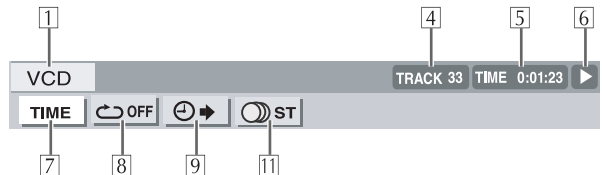

- 1 Disc type
- 2 Current transfer rate (Megabits per second)
- 3 Current title (for DVD)
- 4 Current chapter number (for DVD) or track number (for other type of discs)
- 5 Time information (☞ pg. 49)
- 6 Playback status
 - ▶: appears during playback.
 - ▶▶ / ◀◀: appears during fast forward/reverse.
 - ▶◀ / ◀▶: appears during playback in forward slow-motion/reverse slow-motion.
 - ⏸: appears when paused.
 - : appears when stopped.
- 7 Select this to change time information. (See 5 in the illustration above) (☞ pg. 49)
- 8 Select this for Repeat Playback. (☞ pg. 50)
- 9 Select this for time search function. (☞ pg. 52)
- 10 Select this for chapter search function. (☞ pg. 53)
- 11 Select this to change audio language or channel. (☞ pg. 56, 57)
- 12 Select this to change subtitle language. (☞ pg. 54)
- 13 Select this to change view angle. (☞ pg. 55)

Basic operation on the on-screen bar

Example: When selecting the Repeat mode of DVD

During playback

1 Access the on-screen bar.

Press **ON SCREEN** twice. The on-screen bar appears on the TV screen.

- The currently selected item is highlighted.



2 Select menu item.

Press ◀▶ to move the highlight to **TIME**, then press **ENTER**. The pop-up window appears under the selected item.

- The current setting appears.



3 Select the option.

Press ▲▼ to select the desired option, then press **ENTER**.

- Each time you press ▲▼, the options change.

To clear the on-screen bar

Press **ON SCREEN**.

NOTE:

See the corresponding pages for details on each function.

Change the time information



You can change the time information in the on-screen bar on the TV screen and the front display panel of the unit.

During playback or while stopped

1 Access the on-screen bar.

Press **ON SCREEN** twice. The on-screen bar appears on the TV screen.

2 Select menu item.

Press ◀▶ to move the highlight to **TIME**, then press **ENTER**.

- Each time you press **ENTER**, the time information changes as follows;

Example: During DVD playback

⇒ **TIME 0:25:58** ⇒ **REM 0:18:14** ⇒ **TOTAL 1:25:58**

⇒ **T.REM 0:45:41** ⇒ (Back to the beginning)

TIME:	Elapsed playing time of current chapter/track
REM:	Remaining time of current chapter/track
TOTAL:	Elapsed time of title/disc
T. REM:	Remaining time of title/disc

To clear the on-screen bar

Press **ON SCREEN**.

NOTE:

While a DVD is stopped, “- : - : - -” appears in the time information display.

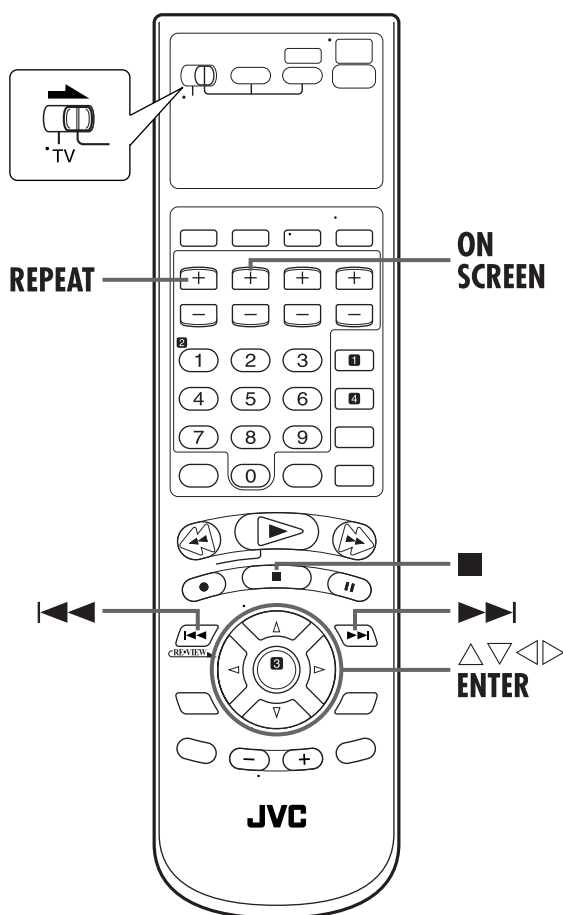

Repeat Playback



You can repeat playback as you like according to the type of disc.

- DVD VIDEO: during playback
- Audio CD: during playback or in stop mode
- Video CD/SVCD: in stop mode or during playback with PBC deactivated

When using the on-screen bar

1 Access the on-screen bar.

Press **ON SCREEN** twice. The on-screen bar appears on the TV screen.

2 Select menu item.

Press \triangleleft \triangleright to move the highlight to REPEAT , then press **ENTER**.

- The following pop-up window appears under the selected item.



3 Select the repeat mode.

Press \triangle ∇ repeatedly to select the Repeat mode, then press **ENTER**.

- The mode changes as follows:

DVD VIDEO

CHAPTER \rightarrow TITLE \rightarrow A-B \rightarrow OFF \rightarrow (Back to the beginning)

CHAPTER:	The current chapter is played back repeatedly.
TITLE:	The current title is played back repeatedly.
A-B:	The desired part is played back repeatedly. (pg. 51)
OFF:	Each title and chapter is played back once.

Video CD/SVCD/CD

TRACK \rightarrow ALL \rightarrow A-B \rightarrow OFF \rightarrow (Back to the beginning)

TRACK:	The current track is played back repeatedly.
ALL:	All tracks are played back repeatedly.
A-B:	The desired part is played back repeatedly. (pg. 51)
OFF:	Each track is played back once.

- "A-B" cannot be selected while stopped.

To clear the on-screen bar

Press **ON SCREEN**.

To cancel Repeat Playback

Repeat from step **1**, select "OFF" in step **3**, then press **ENTER**.

When using the REPEAT button:

1 Access the repeat mode.

Press **REPEAT** during playback of the item you want to repeat.

- Repeat mode is displayed on the TV.

2 Select the repeat mode.

Press **REPEAT** repeatedly to select the desired repeat mode.

- To stop Repeat Playback, press **STOP** (■).
- To cancel Repeat Playback, press **REPEAT** repeatedly until "OFF" appears on the TV screen.
- The pop-up window disappears if no operation is done for about 5 seconds.

NOTES:

- Repeat Playback is not possible with a Video CD and SVCD with PBC function.
- Repeat Playback may not work properly depending on the type of disc being used.
- You cannot select A-B Repeat Playback by pressing **REPEAT**.

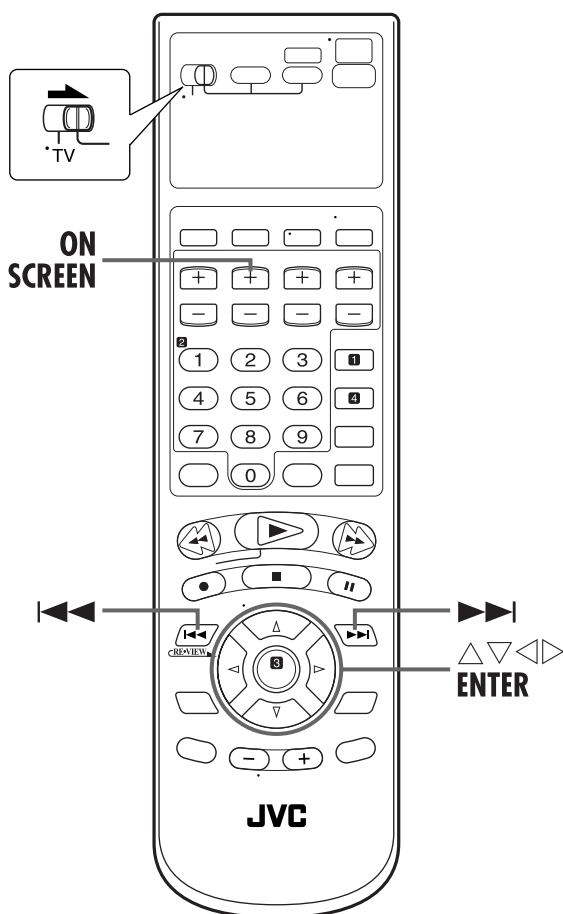

A-B Repeat Playback



You can repeat the desired part.

1 Access the on-screen bar.

Press **ON SCREEN** twice. The on-screen bar appears on the TV screen.

2 Select menu item.

Press ◀▶ to move the highlight to , then press **ENTER**.

- The following pop-up window appears under the selected item.



3 Select the repeat mode.

Press ▲▼ repeatedly to select "A-B".

4 Select the start point.

Press **ENTER** at the beginning of the part you want to repeat (point A).

- The following display appears in the on-screen bar.



5 Select the end point

Press **ENTER** at the end of the part you want to repeat (point B).

- A-B Repeat Playback starts. The selected part of the disc (between point A and B) is played repeatedly.

To cancel A-B Repeat Playback

Repeat from step **1**, select "OFF" in step **3**, then press **ENTER**.

- You can also cancel Repeat Playback by pressing **SKIP** (◀◀) or **SKIP** (▶▶).

To clear the on-screen bar

Press **ON SCREEN**.

NOTES:

- A-B Repeat Playback may not work properly depending on the type of disc being used.
- The subtitles recorded around A-B point may not appear.
- The end of the item will be set as "B" point if the end of the item reached before you set the "B" point.
- When playing back a DVD, A-B Repeat Playback is possible only within the same title.
- "A-B" cannot be selected while stopped.

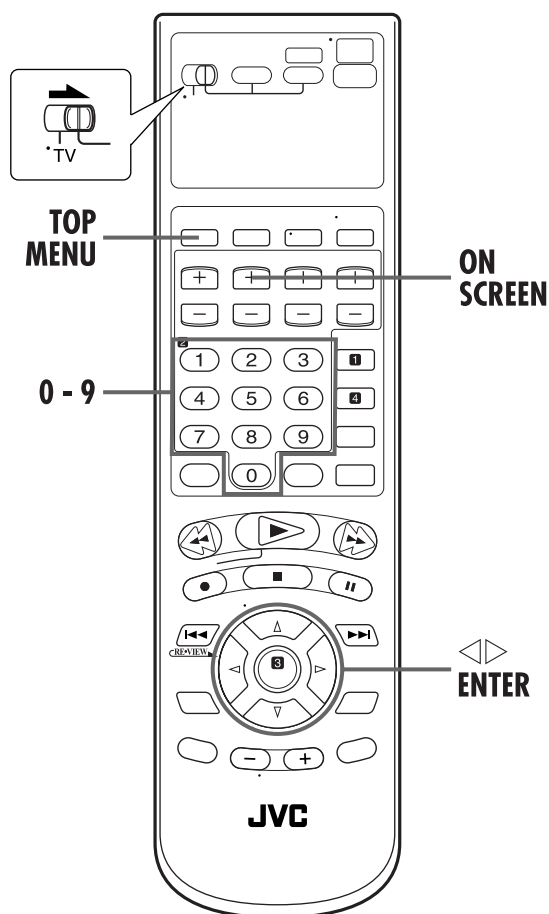

Time Search



You can play back a disc from the desired point by specifying the elapsed time from the beginning of the current title (for DVD VIDEO) or the disc (for Audio CD/Video CD) using the Time Search.

When a PBC-compatible Video CD is played back, be sure to inactivate PBC function before you perform Time search by pressing the **number keys** instead of the **PLAY** (▶) button when you start playback.

1 Access the on-screen bar.

Press **ON SCREEN** twice. The on-screen bar appears on the TV screen.

2 Select menu item.

Press ◀▶ to move the highlight to ⌚▶, then press **ENTER**.

- The following pop-up window appears under the selected item.



3 Select the time.

Press the **number keys** (0-9) to enter the time, then press **ENTER**.

Example:

To play back from a point 2 (hours): 34 (minutes): 08 (seconds) elapsed

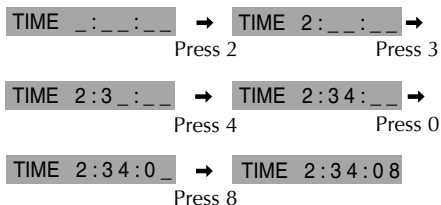

If you have specified a wrong selection,

Press ◀ repeatedly until the wrong number is erased, then press **number keys** to enter the correct numbers.

- The unit starts playback from the specified time.

To clear the on-screen bar

Press **ON SCREEN**.

NOTES:

- When "⊙" is displayed on the TV screen in step 3, you have selected a point that exceeds the recording time of the disc.
- Some DVD VIDEO discs do not contain time information, and it is no possible to use the Time Search function. In such a case, "⊙" is displayed on the TV screen as well.
- Time Search does not work while you play back the Video CD or SVCD with the PBC Function.

Reactivate the Playback Control (PBC) Function

You can reactivate the PBC function when you play back a PBC-compatible Video CD disc without PBC function.

- Press **TOP MENU** during playback.

Chapter Search



You can start playback the desired chapter using the on-screen bar.

1 Access the on-screen bar.

Press **ON SCREEN** twice. The on-screen bar appears on the TV screen.

2 Select menu item.

Press ◀ ▶ to move the highlight to **CHAP. ▶**, then press **ENTER**.

- The following pop-up window appears under the selected item.



3 Select the chapter.

Press the **number keys** (0-9) to enter the desired chapter number, then press **ENTER**.

- The unit starts playback from the selected chapter.

Examples:

To select track 5, press the **number key "5"**.

To select track 15, press the **number key "1"** and **"5"**.

To select track 25, press **number key "2"** and **"5"**.

- It is not possible to use the **number key "+10"** and **"-10"**.

If you have specified a wrong selection

Enter the appropriate **number keys** again.

To clear the on-screen bar

Press **ON SCREEN**.

NOTES:

- When "⊗" is displayed on the TV screen in step **3**, the chapter you have selected is not contained in the disc, or chapter search does not work on the disc.
- Chapter Search starts automatically when you select the desired chapter in step **3** depending on the disc.

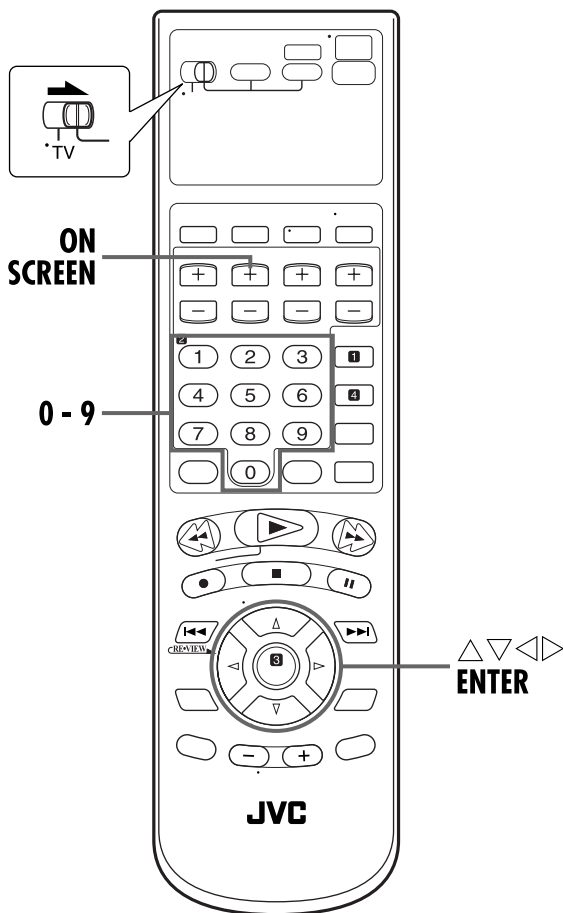

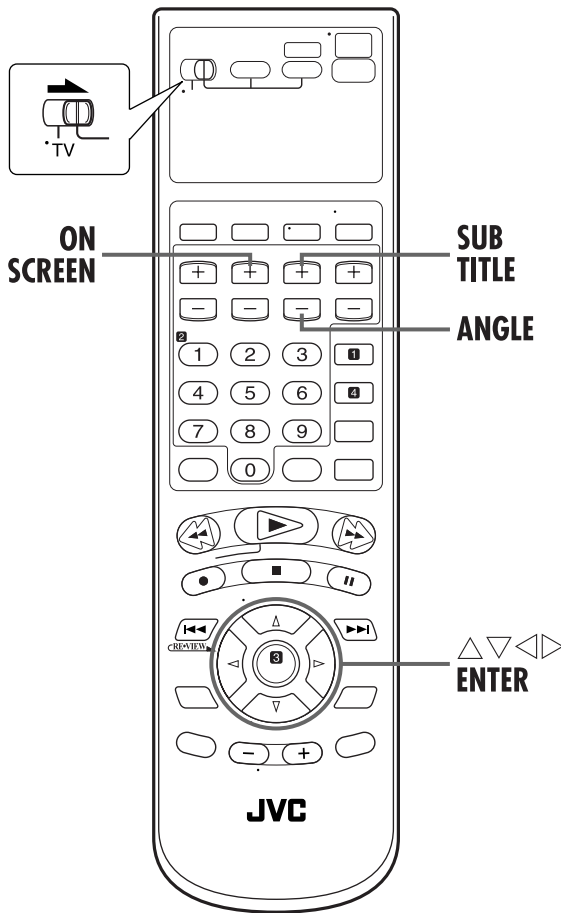

Subtitle Selection



You can select subtitle language.

- During playback

When using the on-screen bar

1 Access the on-screen bar.

Press **ON SCREEN** twice. The on-screen bar appears on the TV screen.

2 Select menu item.

Press ◀▶ to move the highlight to , then press **ENTER**.

- The following pop-up window appears under the selected item.

Example (DVD): “ENGLISH” is selected out of 3 subtitle languages recorded.



3 Select the subtitle language.

Press Δ ▼ repeatedly to select the desired subtitle language, then press **ENTER**.

- Each time you press the button, the subtitle language changes.

To clear the on-screen bar

Press **ON SCREEN**.

NOTES:

- It is impossible to select “OFF” when using the on-screen bar. To select “OFF”, press **ON SCREEN** to clear the on-screen bar, then press **SUB TITLE** repeatedly until “OFF” is selected.
- For DVD VIDEO
Some subtitle languages are abbreviated in the pop-up window. See “Language Code List” (pg. 23).
- For SVCD
SVCD can contain up to four subtitles. Pressing **SUB TITLE** changes the subtitles regardless of whether the subtitles are recorded or not. (Subtitles will not change if no subtitle is recorded.)
- When “” appears on the TV screen in step 3, subtitle language is not recorded.

When using the SUB TITLE button:

1 Access the menu.

Press **SUB TITLE**.

- The following pop-up window appears on the TV screen.

Example (DVD): “ENGLISH” is selected out of 3 subtitle languages recorded.

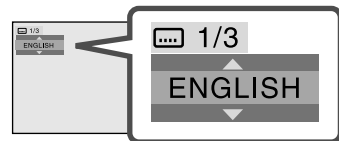

2 Select the subtitle language.

Press Δ ▼ repeatedly to select the desired subtitle language. To select “OFF”, press **SUB TITLE** repeatedly until “OFF” is selected.

- Each time you press the button, the subtitle language changes.
- The pop-up window disappears if no operation is done for about 5 seconds.

NOTE:

When “” appears on the TV screen in step 2, subtitle language is not recorded.

Angle Selection



You can enjoy a variety of scene angles if the DVD VIDEO disc contains "multi-angle" parts, where multiple cameras were used to shoot the same scene from different angles.

If the disc contains "multi-angle" parts, "1/3" appears on the TV screen at the beginning of the "multi-angle" part when "ON SCREEN GUIDE" is set to "ON".

- During playback

When using the on-screen bar

1 Access the on-screen bar.

Press **ON SCREEN** twice. The on-screen bar appears on the TV screen.

2 Select menu item.

Press $\triangleleft \triangleright$ to move the highlight to , then press **ENTER**.

- The following pop-up window appears under the selected item.

Example: The first view angle is selected out of 3 view angles recorded.



3 Select the view angle.

Press $\triangle \nabla$ repeatedly to select the desired view angle, then press **ENTER**.

- Each time you press the button, the angle of the scene changes.

To clear the on-screen bar

Press **ON SCREEN**.

NOTE:

When "0" appears on the TV screen in step 3, the current scene is not recorded from multiple angles.

When using the ANGLE button:

1 Access the menu.

Press **ANGLE**.

- The following pop-up window appears on the TV screen.

Example: The first view angle is selected out of 3 view angles recorded.

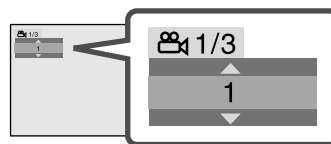

2 Select the view angle.

Press $\triangle \nabla$ or **ANGLE** repeatedly to select the desired view angle.

- Each time you press the button, the angle of the scene changes.
- The pop-up window disappears if no operation is done for about 5 seconds.

Example:

1/3 → 2/3 → 3/3 → (Back to the beginning)

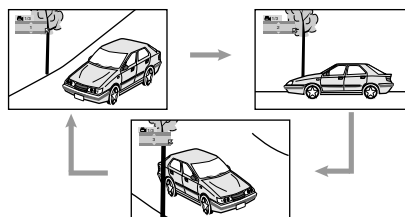

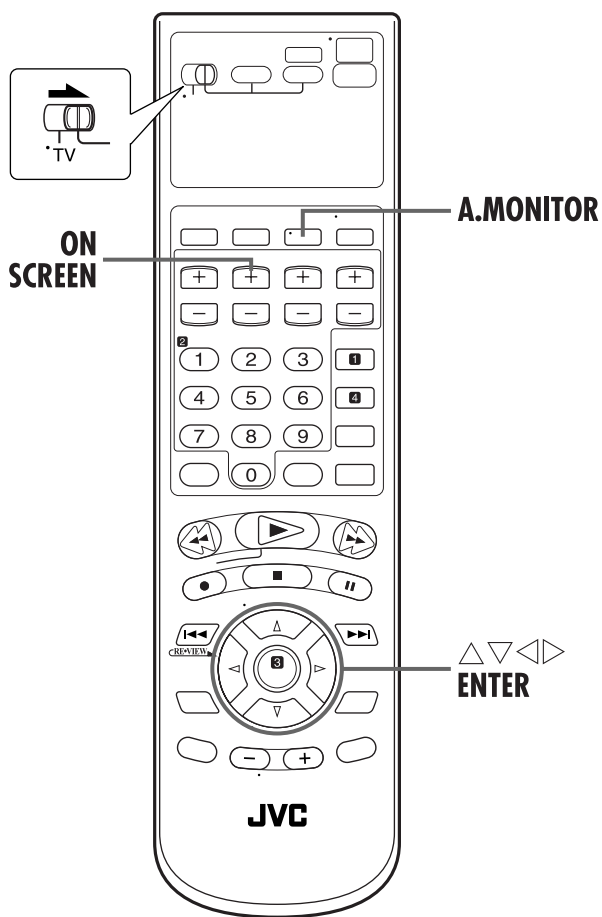

Audio Language Selection



Some DVD discs contain the multiple audio.
You can select the audio language of movies (DVD VIDEO).

- During playback

When using the on-screen bar

1 Access the on-screen bar.

Press **ON SCREEN** twice. The on-screen bar appears on the TV screen.

2 Select menu item.

Press ◀▶ to move the highlight to , then press **ENTER**.

- The following pop-up window appears under the selected item.

Example: "ENGLISH" is selected out of 4 audio languages recorded.

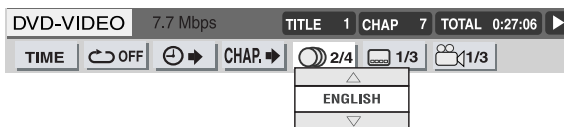

3 Select the audio language.

Press ▲▼ repeatedly to select the desired audio language, then press **ENTER**.

- Each time you press the button, the audio language changes.

To clear the on-screen bar

Press **ON SCREEN**.

NOTES:

- Some audio languages are abbreviated in the pop-up window. See "Language Code List" (☞ pg. 23).
- If "Ⓞ" appears on the TV, the current scene does not contain plural audio languages.

When using the A.MONITOR button:

1 Access the menu.

Press **A.MONITOR**.

- The following pop-up window appears on the TV screen.

Example: "ENGLISH" is selected out of 3 audio languages recorded.

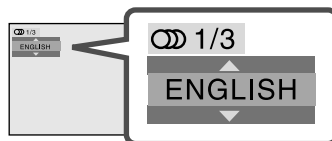

2 Select the audio language.

Press ▲▼ or **A.MONITOR** repeatedly to select the desired audio language.

- Each time you press the button, the audio language changes.
- The pop-up window disappears if no operation is done for about 5 seconds.

NOTE:

Some audio languages are abbreviated in the pop-up window. See "Language Code List" (☞ pg. 23).

Audio Channel Selection



When you play certain karaoke (Video CD/SVCD), you can enjoy karaoke by selecting the audio channel to play.

- The sound of each audio channel depends on the contents of the disc.
- During playback

When using the on-screen bar

1 Access the on-screen bar.

Press **ON SCREEN** twice. The on-screen bar appears on the TV screen.

2 Select menu item.

Press $\triangleleft \triangleright$ to move the highlight to , then press **ENTER**.

- The following pop-up window appears under the selected item.

Example: "ST" (stereo) is selected.

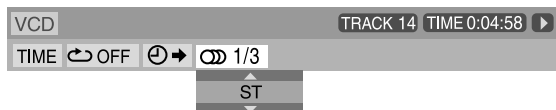

3 Select the audio channel.

Press $\triangle \nabla$ repeatedly to select the desired audio channel, then press **ENTER**.

- Each time you press the button, the audio channel changes.

To clear the on-screen bar

Press **ON SCREEN**.

When using the **A.MONITOR** button:

1 Access the menu.

Press **A.MONITOR**.

- The following pop-up window appears on the TV screen.
Example: "ST" (stereo) is selected out of 3 audio channels recorded.

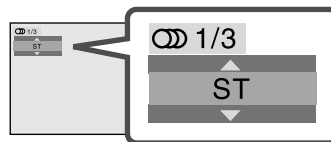

2 Select the audio channel.

Press $\triangle \nabla$ or **A.MONITOR** repeatedly to select the desired audio channel.

- Each time you press the button, the audio channel changes.
- The pop-up window disappears if no operation is done for about 5 seconds.

For Video CD

ST \rightarrow L \rightarrow R \rightarrow (Back to the beginning)

ST:	To listen to normal stereo playback.
L:	To listen to L (left) audio channel only.
R:	To listen to R (right) audio channel only.

For SVCD

ST 1 \rightarrow ST 2 \rightarrow L 1 \rightarrow R 1 \rightarrow L 2 \rightarrow R 2 \rightarrow (Back to the beginning)

ST 1/ST 2:	To listen to normal stereo playback of ST 1 or ST 2 channel.
L 1/L 2:	To listen to the L (left) 1 or 2 audio channel.
R 1/R 2:	To listen to the R (right) 1 or 2 audio channel.

Parental Lock

This function restricts playback of DVD VIDEO discs which contain violent (and other) scenes according to the level set by the user. For example, if a movie which includes violent scenes supports the parental lock feature, such scenes which you do not want to let children view can be cut or replaced with other scenes.

- Turn on the TV and select the VCR channel (or AV mode).
- Slide the TV/VCR/DVD switch to the right.

NOTE:

DVD Set Up menu is displayed in STOP mode only.

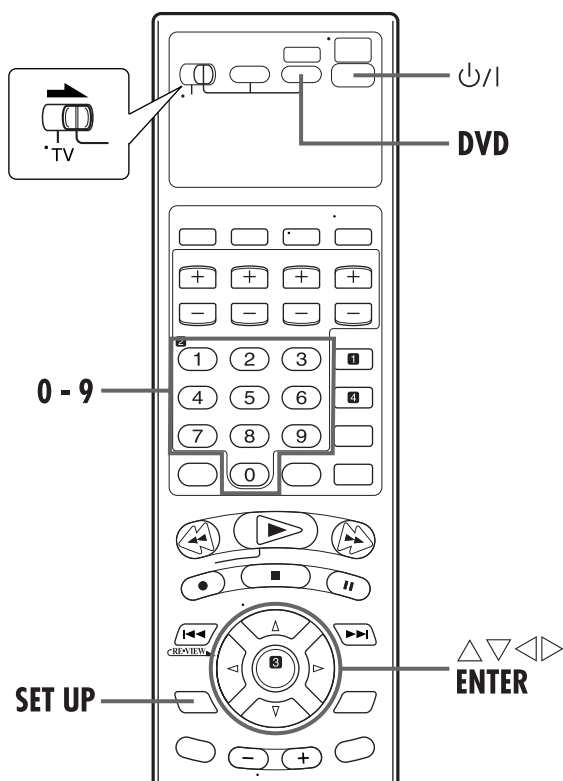

To set Parental Lock for the first time

1 Turn on the unit.

Press **POWER** (⏻).

2 Select the DVD deck.

On the unit

Press **VCR/DVD** repeatedly so that the DVD indicator lights up.

On the Remote

Press **DVD** so that the DVD indicator lights up.

3 Access the DVD Set Up menu.

- 1 Press **SET UP**.
- 2 Press **◀▶** to select "OTHERS".

4 Access the "PARENTAL LOCK" menu.

Press **△▽** repeatedly to move the highlight to "PARENTAL LOCK", then press **ENTER**.

- The "PARENTAL LOCK" sub-menu appears on the TV screen.
- It is possible to access the "PARENTAL LOCK" menu only in the stop mode when a DVD disc is loaded on the unit.

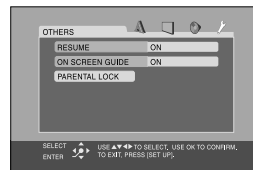

5 Access the country code menu.

Press **ENTER**, then press **△▽** repeatedly to move the highlight to "COUNTRY CODE", then press **ENTER**.

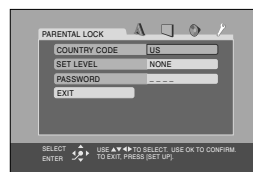

6 Select the country code.

Press **△▽** repeatedly to move the highlight to select the country code, then press **ENTER**.

- See "Country/Area Code List for Parental Lock" (pg. 60).
- The highlight moves to "SET LEVEL".

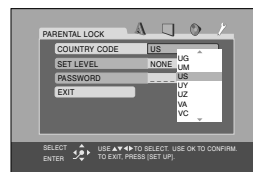

7 Select the Level.

Press **ENTER**, then press **△▽** repeatedly to move the highlight to select the level of restriction, then press **ENTER**.

- The highlight moves to "PASSWORD".
- The smaller the value of level is, the more restrictive the Parental Lock level is.
- Select "NONE" to cancel this function.

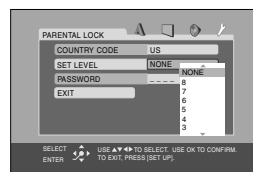

8 Enter the password.

Press the **number keys** to enter a four-digit number as your password, then press **ENTER**.

- The highlight moves to "EXIT".

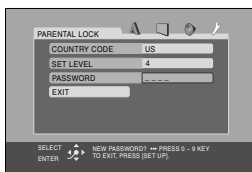

9 Return to the OTHERS menu screen.

Press **ENTER**.

- The "OTHERS" menu resumes.

To return to the normal screen

Press **SET UP**.

NOTE:

Remember your password, or make a note of it.

To change the settings

You can change the Parental lock settings later.

1 Access the Parental Lock screen.

- 1 Press **SET UP**.
 - 2 Press $\triangleleft \triangleright$ to select "OTHERS".
 - 3 Press $\triangle \nabla$ repeatedly to move the highlight to "PARENTAL LOCK", then press **ENTER**.
- The "PARENTAL LOCK" sub-menu appears on the TV screen.
 - You can only move the highlight to "PASSWORD" or "EXIT" before you enter your password.

2 Enter the password.

Press the appropriate **number keys** to enter 4-digit password, then press **ENTER**. If you enter the wrong password, "WRONG! RETRY..." appears at the bottom of the TV screen. Enter the correct password.

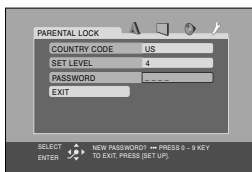

3 Change the country code.

Press $\triangle \nabla$ to select the country code, then press **ENTER**.

- See "Country/Area Code List for Parental Lock" (pg. 60).
- When you change the country code, you must select the level.

4 Change the level.

Press $\triangle \nabla$ to select the desired level, then press **ENTER**.

5 Enter your new password.

Press the appropriate **number keys** to enter 4-digit password, then press **ENTER**.

- The password entered in the this step becomes the new password. If you do not change the password, enter the same password as in the step 2.
- Even if you want to change only the country code and/or level, do not forget to enter the password after changing the country code and/or the level. Otherwise, the new country code and/or the level will not become effective.

6 Return to the normal screen.

Press **SET UP**.

NOTES:

- When you enter the wrong password more than 3 times in step 2 on the left column, the highlight moves to "EXIT" automatically and $\triangle \nabla$ does not work.
- If you forget your password, enter "8888" in step 2.

To temporarily release the Parental Lock

When you set the parental level strictly, some discs may not be played back at all. When you insert such a disc and try to play back it, the following Parental Lock screen appears on the TV screen, asking you whether you want the Parental Lock to be temporarily released or not.

1 Access the password screen.

- 1 Place the disc in the disc tray.
 - 2 Press $\triangle \nabla$ to move the highlight to "TEMPORARY RELEASE", then press **ENTER**.
- If the disc rated higher than the selected level, the following screen appears.
 - If you select "NOT RELEASE", you cannot play back that disc.

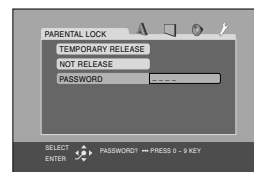

2 Enter the password.

Press the appropriate **number keys** to enter 4-digit password, then press **ENTER**.

- If you enter the wrong password, "WRONG! RETRY..." appears on the TV screen. Enter the correct password.
- If you enter the correct password, the Parental lock is released and the unit starts playback.

NOTES:

- When you enter the wrong password more than 3 times in step 2 above, the highlight moves to "NOT RELEASE" automatically and $\triangle \nabla$ do not work. In such a case, press **ENTER**, then press **OPEN/CLOSE** (\blacktriangle) to remove the disc.
- If you forget your password, enter "8888" in step 2.

Country/Area Code List for Parental Lock

AD	Andorra	ES	Spain
AE	United Arab Emirates	ET	Ethiopia
AF	Afghanistan	FI	Finland
AG	Antigua and Barbuda	FJ	Fiji
AI	Anguilla	FK	Falkland Islands (Malvinas)
AL	Albania	FM	Micronesia (Federated States of)
AM	Armenia	FO	Faroe Islands
AN	Netherlands Antilles	FR	France
AO	Angola	FX	France, Metropolitan
AQ	Antarctica	GA	Gabon
AR	Argentina	GB	United Kingdom
AS	American Samoa	GD	Grenada
AT	Austria	GE	Georgia
AU	Australia	GF	French Guiana
AW	Aruba	GH	Ghana
AZ	Azerbaijan	GI	Gibraltar
BA	Bosnia and Herzegovina	GL	Greenland
BB	Barbados	GM	Gambia
BD	Bangladesh	GN	Guinea
BE	Belgium	GP	Guadeloupe
BF	Burkina Faso	GQ	Equatorial Guinea
BG	Bulgaria	GR	Greece
BH	Bahrain	GS	South Georgia and the South Sandwich Islands
BI	Burundi	GT	Guatemala
BJ	Benin	GU	Guam
BM	Bermuda	GW	Guinea-Bissau
BN	Brunei Darussalam	GY	Guyana
BO	Bolivia	HK	Hong Kong
BR	Brazil	HM	Heard Island and McDonald Islands
BS	Bahamas	HN	Honduras
BT	Bhutan	HR	Croatia
BV	Bouvet Island	HT	Haiti
BW	Botswana	HU	Hungary
BY	Belarus	ID	Indonesia
BZ	Belize	IE	Ireland
CA	Canada	IL	Israel
CC	Cocos (Keeling) Islands	IN	India
CF	Central African Republic	IO	British Indian Ocean Territory
CG	Congo	IQ	Iraq
CH	Switzerland	IR	Iran (Islamic Republic of)
CI	Côte d'Ivoire	IS	Iceland
CK	Cook Islands	IT	Italy
CL	Chile	JM	Jamaica
CM	Cameroon	JO	Jordan
CN	China	JP	Japan
CO	Colombia	KE	Kenya
CR	Costa Rica	KG	Kyrgyzstan
CU	Cuba	KH	Cambodia
CV	Cape Verde	KI	Kiribati
CX	Christmas Island	KM	Comoros
CY	Cyprus	KN	Saint Kitts and Nevis
CZ	Czech Republic	KP	Korea, Democratic People's Republic of
DE	Germany	KR	Korea, Republic of
DJ	Djibouti	KW	Kuwait
DK	Denmark	KY	Cayman Islands
DM	Dominica	KZ	Kazakhstan
DO	Dominican Republic	LA	Lao People's Democratic Republic
DZ	Algeria	LB	Lebanon
EC	Ecuador		
EE	Estonia		
EG	Egypt		
EH	Western Sahara		
ER	Eritrea		

LC	Saint Lucia
LI	Liechtenstein
LK	Sri Lanka
LR	Liberia
LS	Lesotho
LT	Lithuania
LU	Luxembourg
LV	Latvia
LY	Libyan Arab Jamahiriya
MA	Morocco
MC	Monaco
MD	Moldova, Republic of
MG	Madagascar
MH	Marshall Islands
ML	Mali
MM	Myanmar
MN	Mongolia
MO	Macau
MP	Northern Mariana Islands
MQ	Martinique
MR	Mauritania
MS	Montserrat
MT	Malta
MU	Mauritius
MV	Maldives
MW	Malawi
MX	Mexico
MY	Malaysia
MZ	Mozambique
NA	Namibia
NC	New Caledonia
NE	Niger
NF	Norfolk Island
NG	Nigeria
NI	Nicaragua
NL	Netherlands
NO	Norway
NP	Nepal
NR	Nauru
NU	Niue
NZ	New Zealand
OM	Oman
PA	Panama
PE	Peru
PF	French Polynesia
PG	Papua New Guinea
PH	Philippines
PK	Pakistan
PL	Poland
PM	Saint Pierre and Miquelon
PN	Pitcairn
PR	Puerto Rico
PT	Portugal
PW	Palau
PY	Paraguay
QA	Qatar
RE	Réunion
RO	Romania
RU	Russian Federation
RW	Rwanda

SA	Saudi Arabia
SB	Solomon Islands
SC	Seychelles
SD	Sudan
SE	Sweden
SG	Singapore
SH	Saint Helena
SI	Slovenia
SJ	Svalbard and Jan Mayen
SK	Slovakia
SL	Sierra Leone
SM	San Marino
SN	Senegal
SO	Somalia
SR	Suriname
ST	Sao Tome and Principe
SV	El Salvador
SY	Syrian Arab Republic
SZ	Swaziland
TC	Turks and Caicos Islands
TD	Chad
TF	French Southern Territories
TG	Togo
TH	Thailand
TJ	Tajikistan
TK	Tokelau
TM	Turkmenistan
TN	Tunisia
TO	Tonga
TP	East Timor
TR	Turkey
TT	Trinidad and Tobago
TV	Tuvalu
TW	Taiwan
TZ	Tanzania, United Republic of
UA	Ukraine
UG	Uganda
UM	United States Minor Outlying Islands
US	United States
UY	Uruguay
UZ	Uzbekistan
VA	Vatican City State (Holy See)
VC	Saint Vincent and the Grenadines
VE	Venezuela
VG	Virgin Islands (British)
VI	Virgin Islands (U.S.)
VN	Viet Nam
VU	Vanuatu
WF	Wallis and Futuna Islands
WS	Samoa
YE	Yemen
YT	Mayotte
YU	Yugoslavia
ZA	South Africa
ZM	Zambia
ZR	Zaire
ZW	Zimbabwe

About MP3 Disc

This unit can playback CD discs recorded by the MP3 format (we refer to those discs as MP3 discs in this manual).

Operations for MP3 discs are similar to those for Audio CD discs, though there are some restrictions and differences.

What is MP3?

MP3 is the abbreviation of "MPEG1 Audio Layer 3." MPEG Audio is a compression specification that compresses the audio portion only. This image compression method is used in DVD or Video CD, etc. The audio data has been compressed into about 1/10.

On an MP3 disc, each material (song) is recorded on each Track (file), which usually belongs to a Group (folder).

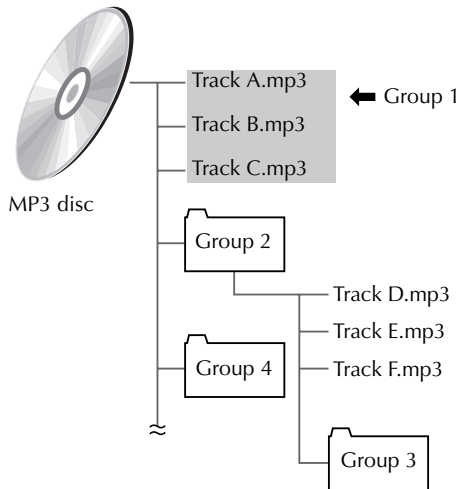

This unit can recognize up to 99 Groups and up to 150 Tracks per Group. If a disc includes more than the Tracks above limit, the unit stops detecting Tracks when the number of detected Tracks reaches the limit and ignores the subsequent Tracks. The unit also ignores any non-MP3 file in the disc.

NOTES for making a private MP3 disc using a CD-R/CD-RW disc:

- Select "ISO9660" as the disc format.
- Finalize the disc.

NOTES:

- Because of the disc characteristics or recording condition, some discs may not be played back or it takes time to start playback.
- The unit does not support "packet writing" discs.
- If there are any Tracks (files) which are stored on a disc directly and do not belong to any Group (directory), the unit recognized them as belonging to an independent Group.
- The unit plays back Groups/Tracks on an MP3 disc in the alphabetical order. For example, if there are three title Groups [one], [two] and [three] on a disc, the playback order is [one], [three] then [two]. Tracks in a Group are played back in the same way. Therefore, an MP3 disc on the market may be played back in the different order from the order printed on its sleeve.

MP3 control display

The MP3 control display appears on the TV screen and playback starts when an MP3 disc is loaded.

Total group number on disc Current track number Total track number in current group

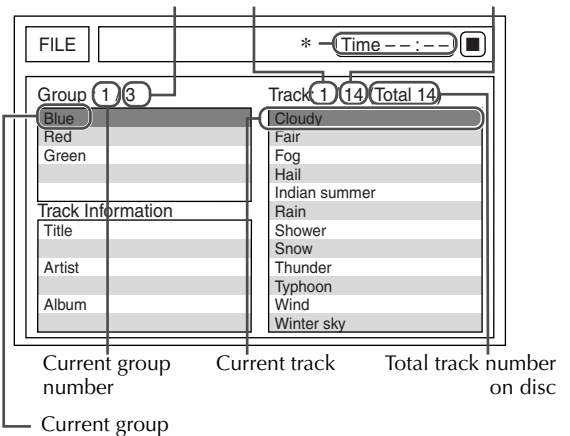

* Elapsed playing time of current track
Elapsed playing time is only shown during playback.

MP3 Playback

MP3

You can search and play back desired groups and tracks using the MP3 control display.

- Turn on the TV and select the VCR channel (or AV mode).
- Slide the **TV/VCR/DVD** switch to the right.

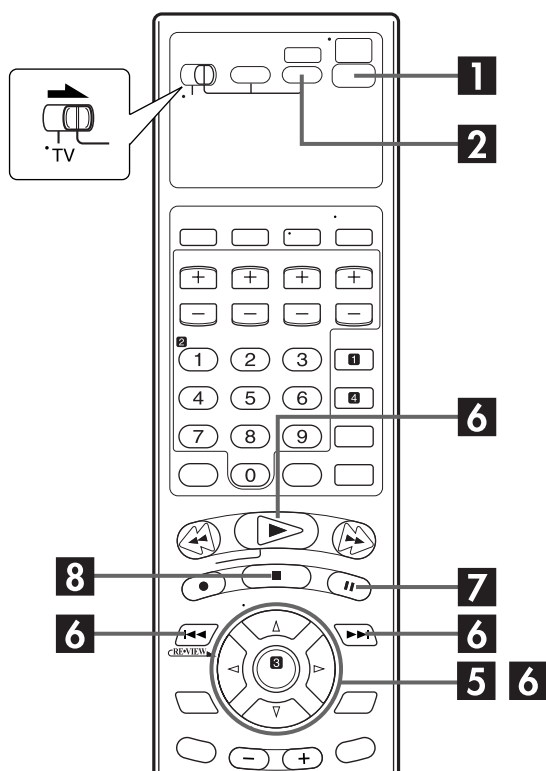
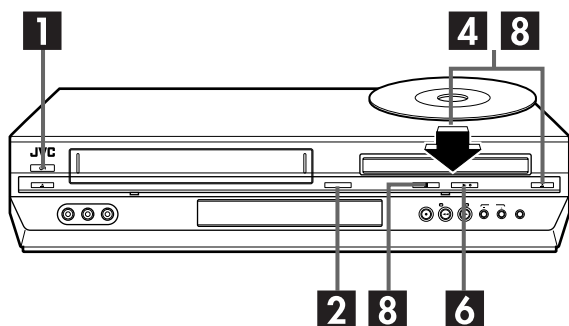

NOTES:

- **PLAY** (▶), **STOP** (■), **PAUSE** (⏸), **SKIP** (◀◀) and **SKIP** (▶▶) buttons function the same as with Audio CD discs, however, **REW** (◀◀) and **FF** (▶▶) buttons do not function for MP3 playback.
- Resume playback also does not function for MP3 playback.

Using the MP3 control display

1 Turn on the unit.

Press **POWER** (⏻/⏻).

2 Select the DVD deck.

On the unit

Press **VCR/DVD** repeatedly so that the DVD indicator lights up.

On the Remote

Press **DVD** so that the DVD indicator lights up.

3 Select the mode.

Be sure to set "FILE TYPE" to "AUDIO" before loading a disc. (☞ pg. 79)

4 Load the disc.

- 1 Press **OPEN/CLOSE** (▲) on the DVD deck to open the disc tray.
- 2 Place the MP3 disc in the disc tray.
 - For details, refer to "Placing a Disc" (☞ pg. 9).
- 3 Press **OPEN/CLOSE** (▲) on the DVD deck to close the disc tray.
 - The MP3 control display appears on the TV screen when an MP3 disc is loaded. (☞ pg. 62)

5 Select the group.

Press **△▽** to select the desired group, then press **▷**.

6 Start playback.

Press **△▽** to select the desired track, then press **ENTER** or **PLAY** (▶).

- You can skip a track across a group. Press **SKIP** (▶▶) to skip to the first track of the next group when the last track of the current group is selected.

7 Pause playback.

Press **PAUSE** (⏸).

- To resume normal playback, press **PLAY** (▶).

8 Stop playback.

Press **STOP** (■). Press **OPEN/CLOSE** (▲) on the DVD deck to open the disc tray, then remove the disc.

Track selection

To start playback by specifying the track number

1 Press the number keys (0-10, +10) to enter the track number.

- The entered number appears in the track number indication and playback starts from the track you have specified.

Example:

To select 3: Press 3.

To select 14: Press +10, then 4.

To select 20: Press +10, then 10.

Or press +10 twice, then 0.

To select 24: Press +10, +10, then 4.

To select 110: Press +10 ten times, then 10.

To select 150: Press +10 fourteen times, then press 10 once.

NOTE:

You cannot select 150 even if you press +10 fifteen times, then press 0 once.

Repeat Playback

You can repeat playback of the current group, track or all groups.

- While MP3 control display is on the TV:

1 Select the mode.

Press **REPEAT** to select the desired repeat mode.

- Each time you press **REPEAT**, the mode changes as follows: TRACK→GROUP→ALL→OFF (No indication)→(Back to the beginning)

TRACK:	The current track is played back repeatedly.
GROUP:	All tracks of the current group are played back repeatedly.
ALL:	All tracks are played back repeatedly.
OFF (no indication):	Each track is played back once.

- To stop Repeat Playback, press **STOP** (■).
- To cancel Repeat Playback, press **REPEAT** repeatedly until the repeat mode display disappears on the TV screen.
- You can also quit Repeat Playback in the following cases:
 - Press **OPEN/CLOSE** (▲) to open the disc tray.
 - Turn off the unit.

To return to the MP3 control display

Press **STOP** (■).

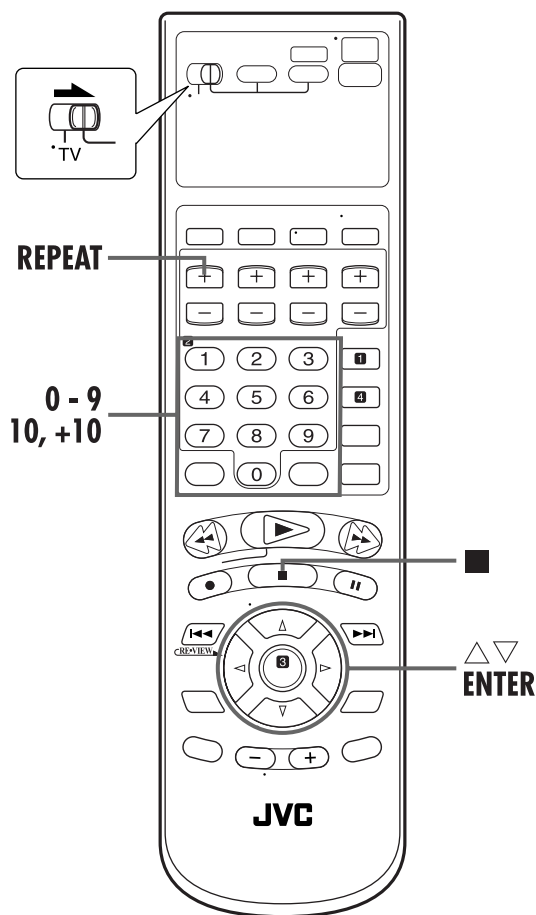

About JPEG Disc

This unit can playback CD discs recorded by the JPEG format (we refer to those discs as JPEG discs in this manual). Operations for JPEG discs are similar to those for Audio CD discs, though there are some restrictions and differences.

What is JPEG?

JPEG is the abbreviation of "Joint Photographic Expert Group." JPEG is a still-picture data compression system.

On a JPEG disc, each still picture is recorded as a file, which usually belongs to a Group (folder).

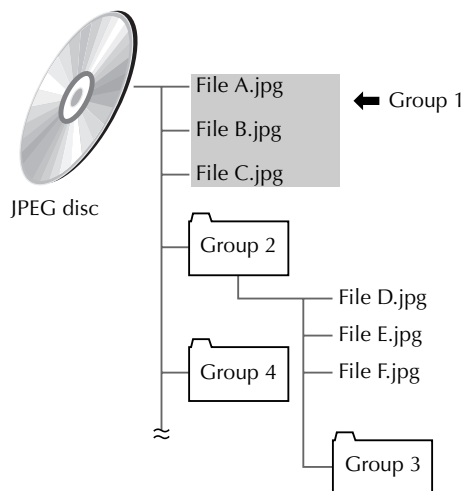

This unit can recognize up to 99 Groups and up to 150 Files per Group.

If a disc includes more than the Files above limit, the unit stops detecting Files when the number of detected Files reaches the limit and ignores the subsequent Files. The unit also ignores any non-JPEG file in the disc.

NOTES for making a private JPEG disc using a CD-R/CD-RW disc:

- Select "ISO9660" as the disc format.
- Finalize the disc.

NOTES:

- We recommend to record a file at 640 x 480 resolution. (If a file has been recorded at a resolution of more than 640 x 480, it will take a longer time to be displayed.)
- This unit supports the JPEG files whose resolution is 32 to 8192 pixel in width and 32 to 7680 pixel in height.
- This unit can only play back baseline JPEG files*. Progressive JPEG files* or lossless JPEG files* cannot be played back.
 - * Baseline JPEG format: Used for digital cameras, web, etc.
 - Progressive JPEG format: Used for web.
 - Lossless JPEG format: An old type and rarely used now.
- Some files on a JPEG disc may be played back distortedly.
- Because of the disc characteristics or recording condition, some discs may not be played back or it takes time to start playback.
- The unit does not support "packet writing" discs.
- If there are any Files which are stored on a disc directly and do not belong to any Group (directory), the unit recognized them as belonging to an independent Group.
- The unit plays back Groups/Files on a JPEG disc in the alphabetical order.
- For example, if there are three title Groups [one], [two] and [three] on a disc, the playback order is [one], [three] then [two]. Files in a Group are played back in the same way.
- Therefore, a JPEG disc on the market may be played back in the different order from the order printed on its sleeve.

JPEG control display

The JPEG control display appears on the TV screen and playback starts when a JPEG disc is loaded.

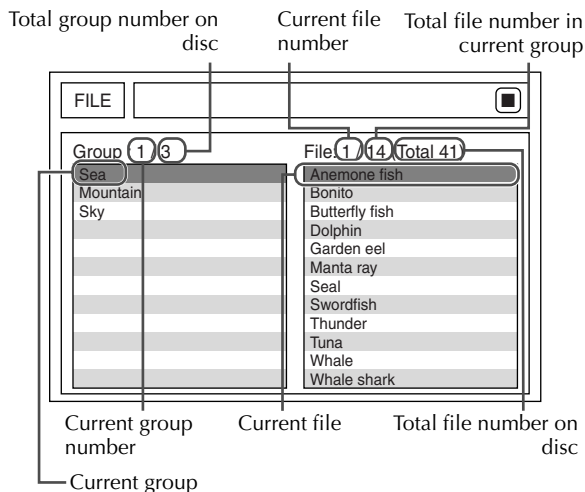

JPEG Playback

JPEG

You can search and play back desired groups and files using the JPEG control display.

- Turn on the TV and select the VCR channel (or AV mode).
- Slide the **TV/VCR/DVD** switch to the right.

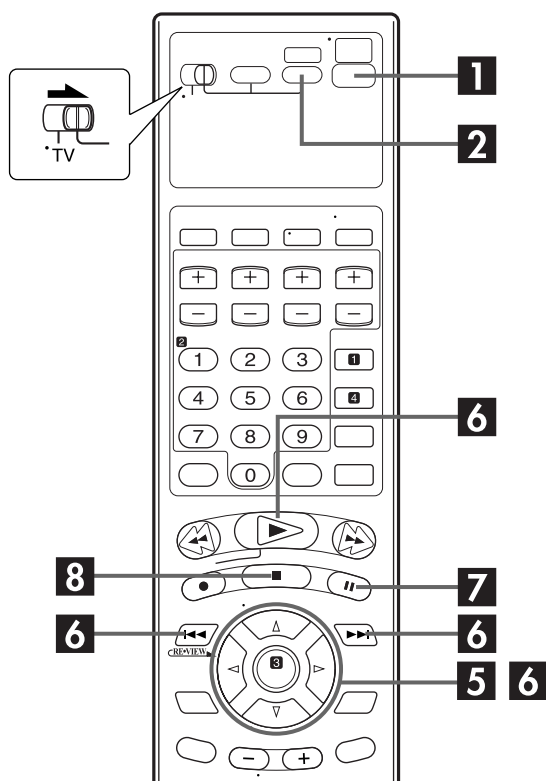
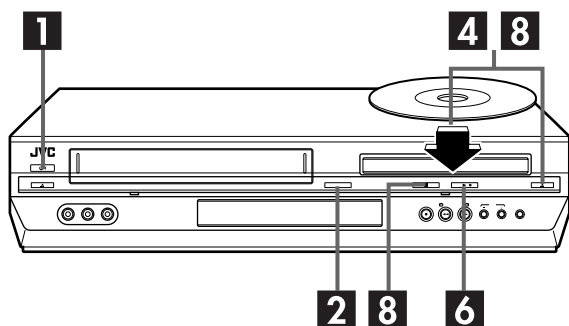

NOTES:

- **PLAY** (▶), **STOP** (■), **PAUSE** (⏸), **SKIP** (◀◀) and **SKIP** (▶▶) buttons function the same as with Audio CD discs, however, **REW** (◀◀) and **FF** (▶▶) buttons do not function for JPEG playback.
- Resume playback also does not function for JPEG playback.

Using the JPEG control display

1 Turn on the unit.

Press **POWER** (⏻).

2 Select the DVD deck.

On the unit

Press **VCR/DVD** repeatedly so that the DVD indicator lights up.

On the Remote

Press **DVD** so that the DVD indicator lights up.

3 Select the mode.

Be sure to set "FILE TYPE" to "STILL PICTURE" before loading a disc. (☞ pg. 79)

4 Load the disc.

- 1 Press **OPEN/CLOSE** (▲) on the DVD deck to open the disc tray.
- 2 Place the JPEG disc in the disc tray.
 - For details, refer to "Placing a Disc" (☞ pg. 9).
- 3 Press **OPEN/CLOSE** (▲) on the DVD deck to close the disc tray.
 - The JPEG control display appears on the TV screen when a JPEG disc is loaded. (☞ pg. 65)

5 Select the group.

Press **Δ**/**∇** to select the desired group, then press **▷**.

6 Start playback.

Press **Δ**/**∇** to select the desired file, then press **ENTER** or **PLAY** (▶).

- You can skip a file across a group. Press **SKIP** (▶▶) to skip to the first file of the next group when the last file of the current group is selected.

The slide-show playback starts from the selected file.

- After selecting a file, press **PLAY** (▶) to start slide-show playback from the selected file, or press **ENTER** to show the selected file.
- The playback interval time of slide-show depends on the file size.

7 Pause playback.

Press **PAUSE** (⏸).

- To resume normal playback, press **PLAY** (▶).

8 Stop playback.

Press **STOP** (■). Press **OPEN/CLOSE** (▲) on the DVD deck to open the disc tray, then remove the disc.

File selection

To start slide-show playback by specifying the file number

1 Press the number keys (0-10, +10) to enter the file number.

- The slide-show playback starts from the file you have specified.
- To display only the selected file, then press **ENTER**. To start slide-show playback from that file, press **ENTER** again.

Example:

To select 3: Press 3.

To select 14: Press +10, then 4.

To select 20: Press +10, then 10.

Or press +10 twice, then 0.

To select 24: Press +10, +10, then 4.

To select 110: Press +10 ten times, then 10.

To select 150: Press +10 fourteen times, then press 10 once.

NOTE:

You cannot select 150 even if you press +10 fifteen times, then press 0 once.

Repeat Playback

You can repeat playback of the current group, file or all groups.

- While JPEG control display is on the TV:

1 Select the mode.

Press **REPEAT** to select the desired repeat mode.

- Each time you press **REPEAT**, the mode changes as follows: GROUP→ALL→OFF (No indication)→(Back to the beginning)

GROUP:	All files of the current group are played back repeatedly.
ALL:	All files are played back repeatedly.
OFF (No indication):	Each file is played back once.

2 Start playback.

Press **PLAY** (▶).

- To stop Repeat Playback, press **STOP** (■).
- To cancel Repeat Playback, press **REPEAT** repeatedly until the repeat mode display disappears on the TV screen.
- You can also quit Repeat Playback in the following cases:
 - Press **OPEN/CLOSE** (▲) to open the disc tray.
 - Turn off the unit.

To return to the JPEG control display

Press **STOP** (■).

Zooming

Press **ZOOM** during playback.

- When you want to zoom the picture during slide-show playback, first press **PAUSE** (||), then press **ZOOM**.
- Each press of **ZOOM** changes the magnification in the following steps:
ZOOM OFF → ZOOM 1 → ZOOM 2 → (Back to the beginning)
- To resume normal playback, press **ENTER**.

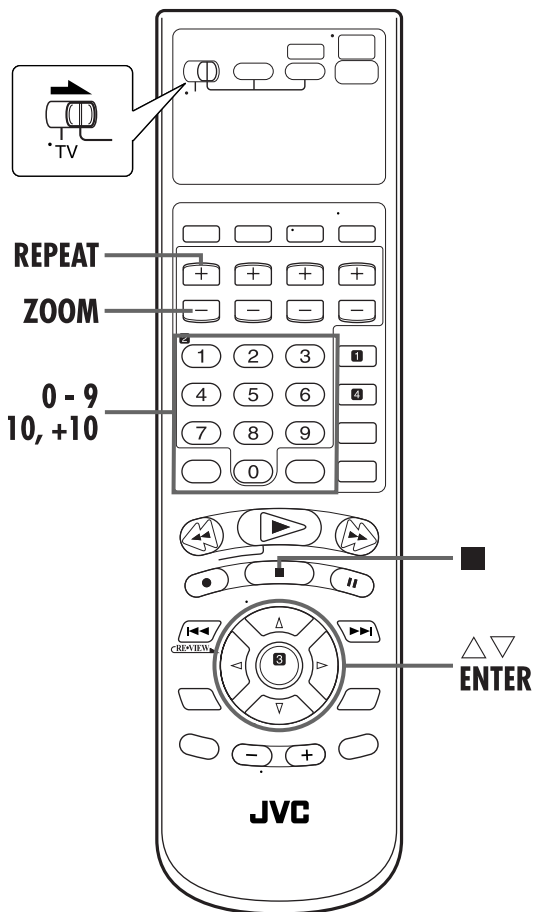

Edit From A Camcorder

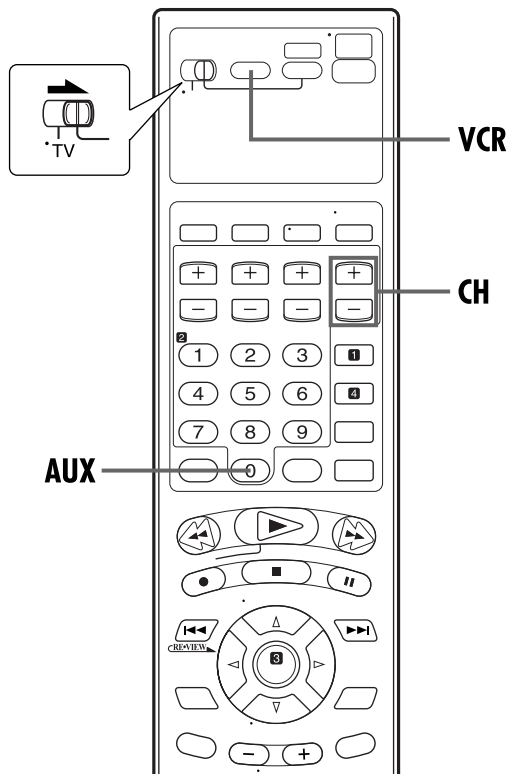

You can use a camcorder as the source player and your unit as the recording deck.

Slide the **TV/VCR/DVD** switch to the right.

1 Make connections.

Connect the camcorder's **AUDIO OUT** and **VIDEO OUT** connectors to the unit's front panel **AUDIO** and **VIDEO** input connectors.

- When using a monaural camcorder, connect its **AUDIO OUT** connector to the **AUDIO L** input connector on your unit.

2 Select the VCR deck.

On the unit

Press **VCR/DVD** repeatedly so that the **VCR** indicator lights up.

On the Remote

Press **VCR** so that the **VCR** indicator lights up.

3 Set the unit's input mode.

Press **AUX** (number key "0") and/or **CH** to select "F-1".

4 Set the edit mode.

See "PICTURE CONTROL" on page 75.

5 Engage the Record Pause mode.

Use **PLAY** (▶), **REW** (◀◀), or **FF** (▶▶) to locate the point where you start recording, then press and hold **PAUSE** (⏸) and press **REC** (●) to engage the Record Pause mode.

6 Start the camcorder.

Engage the Play mode of the camcorder.

7 Start the unit.

Press **PLAY** (▶) to engage the Record mode of the unit.

NOTES:

- All necessary cables can be obtained from your dealer.
- When you select "EDIT" to dub tapes in step 4, be sure to select "NORM" after you finish dubbing the tapes.

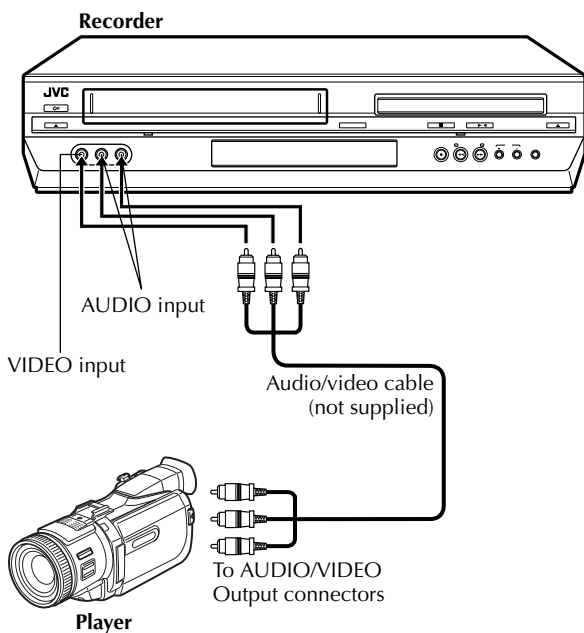

Edit To Or From Another Video Recorder

You can use your unit as the source player or as the recording deck.

Slide the **TV/VCR/DVD** switch to the right.

1 Make connections.

- 1 When using your unit as the source player ...
... connect its **AUDIO/VIDEO OUTPUT** connectors to the audio/video input connectors on another recorder.
- 2 When using your unit as the recording deck ...
... connect its **AUDIO/VIDEO INPUT** connectors to the audio/video output connectors on another recorder.

2 Select the VCR deck.

On the unit

Press **VCR/DVD** repeatedly so that the VCR indicator lights up.

On the Remote

Press **VCR** so that the VCR indicator lights up.

3 Set the input mode of recording deck.

With this video unit, press **AUX** (number key "0") and/or **CH** to select "F-1".

- When using another recorder as the recording deck, refer to its instruction manual.

4 Set the edit mode.

See "PICTURE CONTROL" on page 75.

5 Engage the Record Pause mode of the recording deck.

Locate the point where you start recording, then engage the Record Pause mode.

6 Start the source player.

Engage the Play mode of the source player.

7 Start the recording deck.

Engage the Record mode of the recording deck.

NOTES:

- All necessary cables can be obtained from your dealer.
- When you select "EDIT" to dub tapes in step 4, be sure to select "NORM" after you finish dubbing the tapes.
- When you use this unit as the source player for editing, be sure to set "SUPERIMPOSE" to "OFF" before starting. (pg. 75)

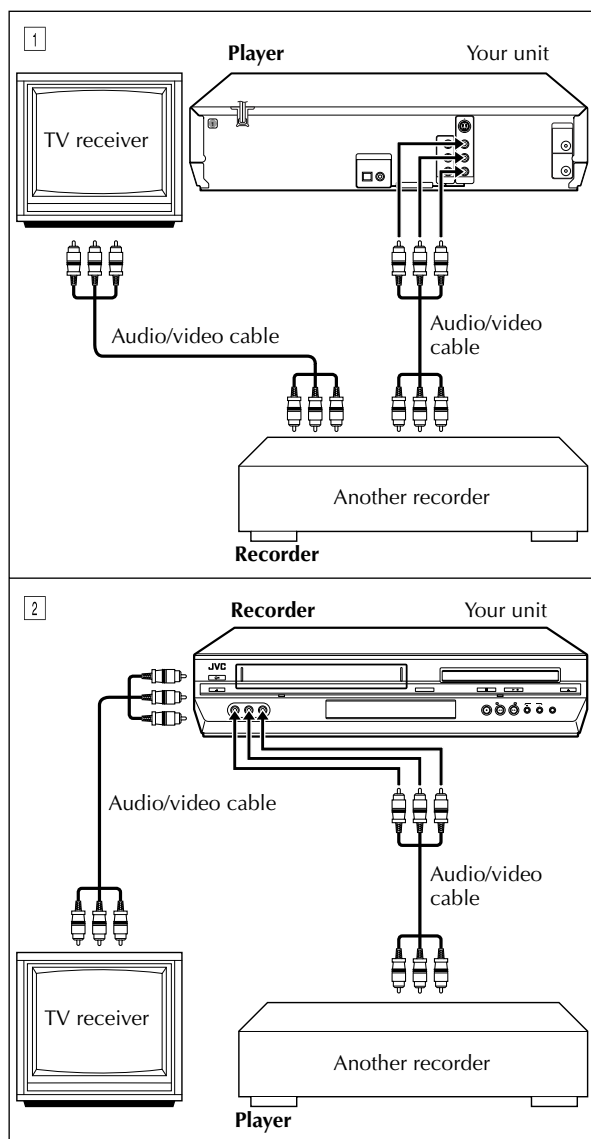

Dubbing

(from DVD to VCR)

- Turn on the TV and select the VCR channel (or AV mode).
- Slide the TV/VCR/DVD switch to the right.

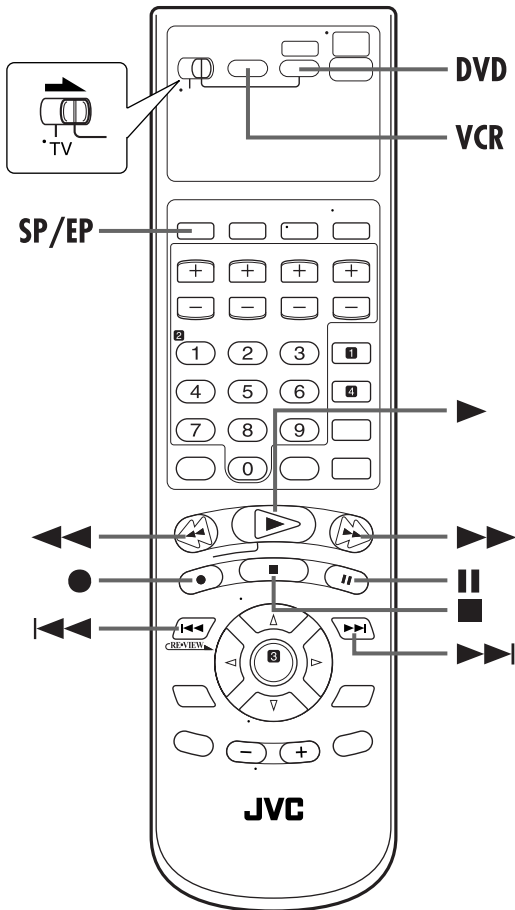

You can dub selected scenes from the DVD disc to a cassette, starting and stopping wherever you wish. However, it is not possible to dub the copy-protected disc. In such case, "ERROR" appears on the front display panel.

1 Load a cassette and place a disc.

For the VCR deck

Insert a cassette with the record safety tab intact.

For the DVD deck

- 1 Press **OPEN/CLOSE** (▲) on the DVD deck to open the disc tray.
- 2 Place the disc in the disc tray.
- 3 Press **OPEN/CLOSE** (▲) on the DVD deck to close the disc tray.

2 Prepare the VCR deck for dubbing.

- 1 Press **VCR**.
- 2 Press **SP/EP** to select recording speed.
- 3 Search for the point where you want to start dubbing by pressing **PLAY** (▶), **FF** (▶▶) or **REW** (◀◀) then press **STOP** (■).

3 Prepare the DVD deck for dubbing.

- 1 Press **DVD**.
- 2 Search for the point where you want to start dubbing by pressing **PLAY** (▶), **FF** (▶▶), **REW** (◀◀), ▶▶ or ◀◀.
- 3 Press **PAUSE** (||) to pause playback a little before the start point.

4 Start dubbing.

Press and hold **REC** (●), then press **PLAY** (▶) on the Remote.

- "dub" lights on the front display panel.



5 End dubbing.

Press **STOP** (■).

- Be sure to press **STOP** (■) while the VCR indicator lights up on the unit.

NOTES:

- You can dub from DVD to VCR regardless of the scan mode setting. (☞ pg. 28) However, the progressive signals will be converted to the interlace signals when dubbing.
- Set "ON SCREEN GUIDE" to "OFF" (☞ pg. 81) if you do not want to record the on-screen display for DVD discs during dubbing.
- There may be a discrepancy of several seconds between where you intend editing to start, and where it actually starts.
- The superimposed indication will not appear during dubbing.
- Set "PICTURE CONTROL" to "EDIT". (☞ pg. 75)

Digital Audio Dubbing

- Turn on the TV and select the VCR channel (or AV mode).
- Slide the TV/VCR/DVD switch to the right.

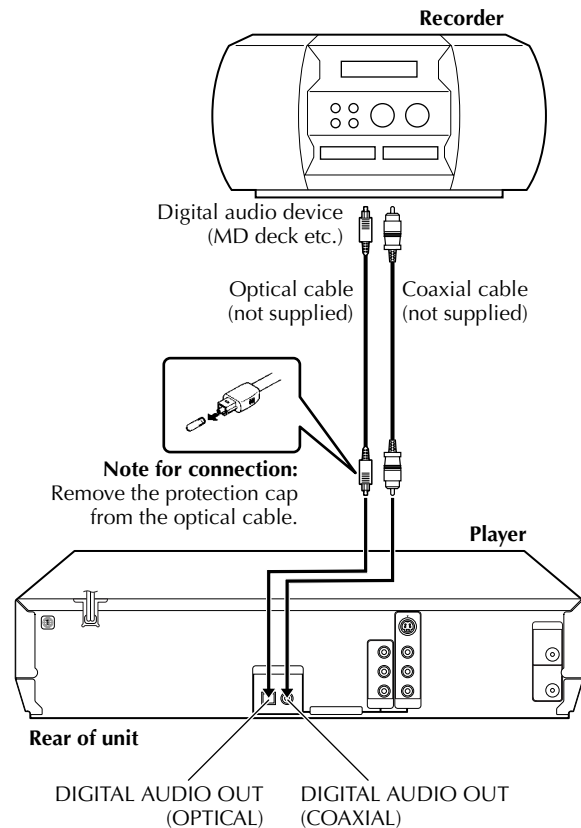

You can dub selected audio from the unit to a digital audio device.

However, it is not possible to dub copy-protected discs.

Example: Dubbing to an MD

1 Make connections.

Connect the unit and a digital audio device using either an optional optical cable or an optional coaxial cable.

2 Prepare the unit for dubbing.

- 1 Load a disc or a cassette.
- 2 Press **DVD** or **VCR** and select the audio to be dubbed.
- 3 Search for the point where you want to start dubbing by pressing **PLAY** (▶), **FF** (▶▶) or **REW** (◀◀) then press **STOP** (■).
- 4 Press **REW** (◀◀) a little, then press **PLAY** (▶) to start playback.
- 5 Press **PAUSE** (⏸) to pause playback a little before the start point.

3 Prepare the digital audio device for dubbing.

- 1 Insert an MD.
- 2 Select the input mode.

4 Start dubbing.

- 1 Press **PLAY** (▶) to start playback on the unit.
- 2 Start recording on the audio device.

5 End dubbing.

Stop recording on the audio device. Then press **STOP** (■) to stop playback on the unit.

NOTES:

- There may be a discrepancy of several seconds between where you intend editing to start, and where it actually starts.
- You can also dub a Video CD or SVCD. Set "DIGITAL AUDIO OUTPUT" to "PCM ONLY". (ⓘ pg. 79)
- Do not switch between the DVD deck and the VCR deck during dubbing.

Remote Control Functions

Remote A/B/C/D Code Switching

The Remote is capable of controlling four JVC video units independently. Each of units can respond to one of four codes (A, B, C or D). The remote control is preset to send A code signals because your unit is initially set to respond to A code signals. You can easily modify your unit to respond to B, C or D code signals.

Before performing the following steps:
Slide the TV/VCR/DVD switch to the right.

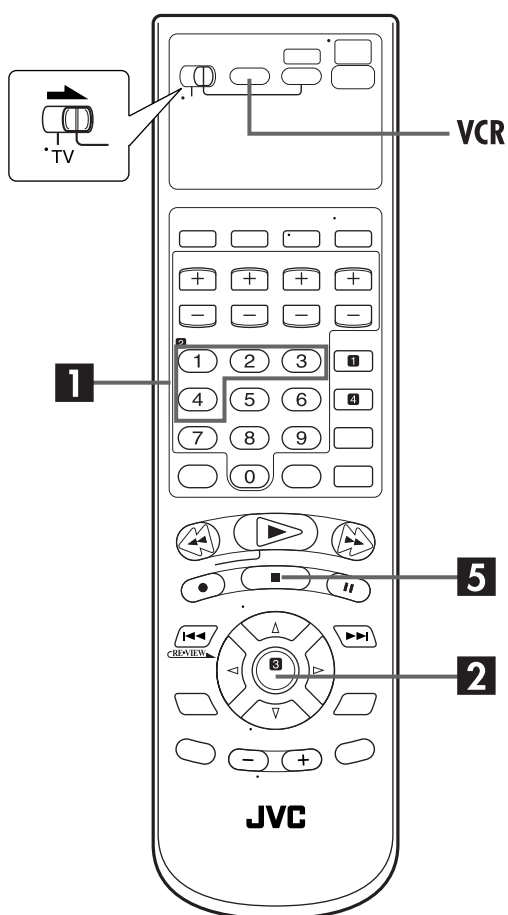

On the Remote

Keep pressing **VCR** down during steps **1** – **2**.

1 Change the remote control code.

Press the **number key "1"** for A, **"2"** for B, **"3"** for C or **"4"** for D.

2 Set the remote control code.

Press **ENTER** to set the code.

NOTE:

Once the batteries are removed, the remote control code is back to A.

On the unit

3 Turn off the unit.

Press **POWER** (⏻/⏻).

4 Display the code.

Press **PLAY** (▶) on the unit for over 5 seconds while the unit is turned off. The code currently set appears on the front display panel.

- If the code displayed on the front display panel is different from the code set on the Remote, go to step **5**.

5 Change the unit's code.

Press **STOP** (■) on the Remote. The code currently set on the Remote will be applied to the unit.

NOTE:

Even if you unplug the end of the mains power cord from the mains, the code currently set remains.

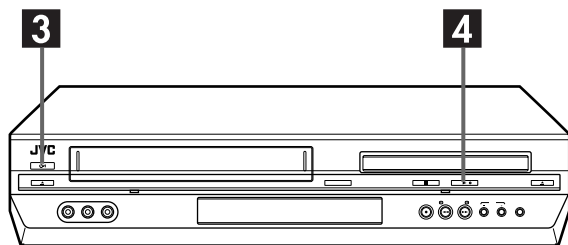

Connecting To A Dolby Digital Decoder or An Amplifier With Built-in DTS

(DVD deck only)

These instructions enable you to connect your unit to a Dolby Digital Decoder or an amplifier with built-in DTS.

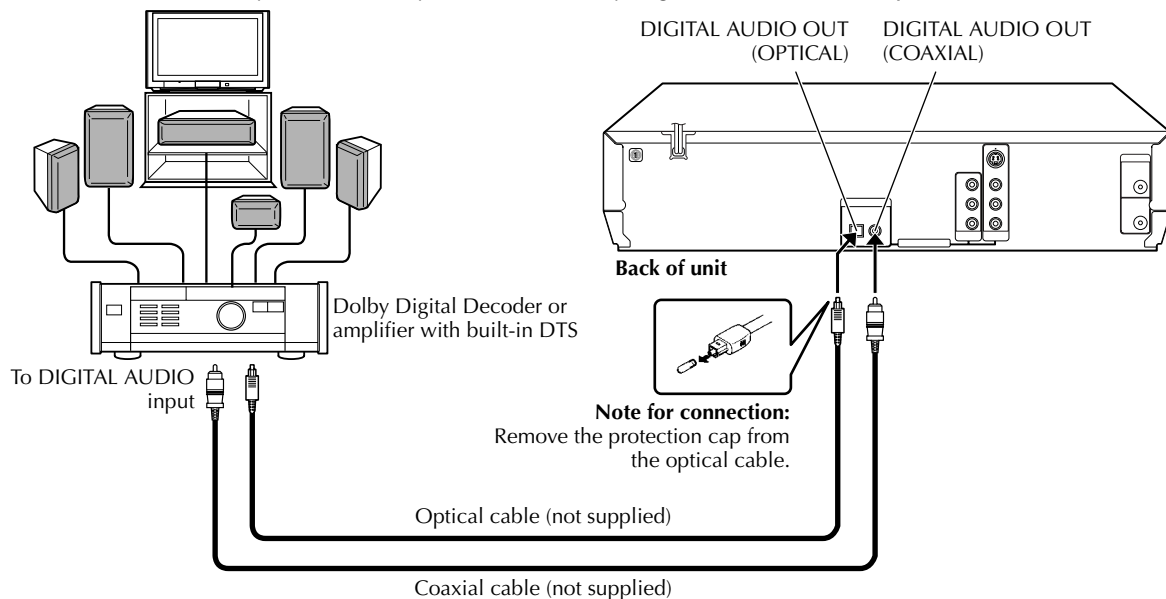

Make connections.

Connect the unit and a Dolby Digital Decoder or an amplifier with built-in DTS using either an optional optical cable or an optional coaxial cable.

NOTES:

- For Dolby digital sound, set "DIGITAL AUDIO OUTPUT" to "DOLBY DIGITAL/PCM". (☞ pg. 79)
- For DTS sound, set "DIGITAL AUDIO OUTPUT" to "STREAM/PCM". (☞ pg. 79)

CAUTIONS:

- This unit has a dynamic range of more than 80 dB with regards to its Hi-Fi audio capability. It is recommended that you check the maximum level if you are going to listen to the Hi-Fi audio signals through a stereo amplifier. A sudden surge in the input level to the speakers may damage them.
- Some speakers and televisions are specially shielded to prevent television interference. If both are of the non-shielded type, do not place the speakers adjacent to the TV set as this can adversely affect the video playback picture.

Mode Set

(VCR deck)

- Turn on the TV and select the VCR channel (or AV mode).
- Slide the TV/VCR/DVD switch to the right.

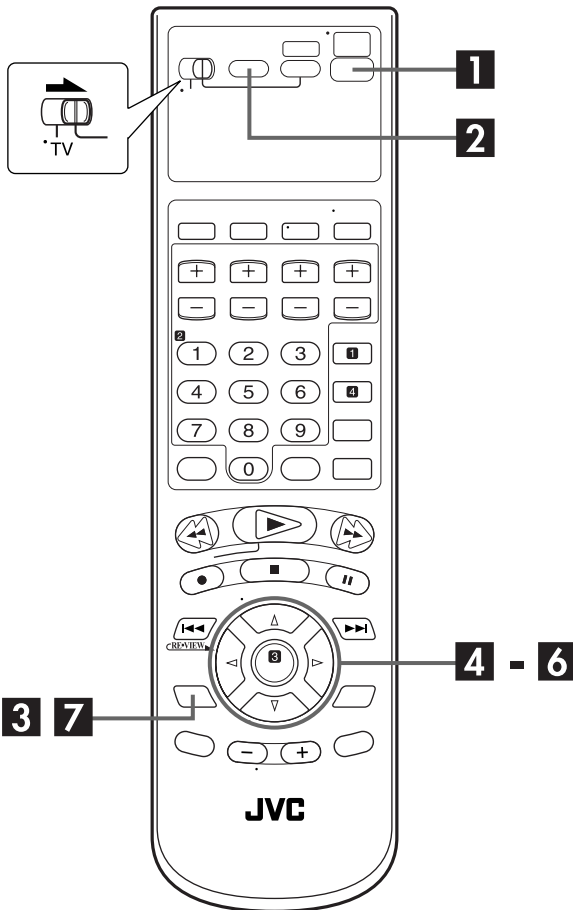

You can change various mode settings on the Function Set screen by following the procedure described below.

- For each mode setting, see pages 75 to 77.

1 Turn on the unit.

Press **POWER** (⏻/⏻).

2 Select the VCR deck.

On the unit

Press **VCR/DVD** repeatedly so that the VCR indicator lights up.

On the Remote

Press **VCR** so that the VCR indicator lights up.

3 Access the Main Menu screen.

Press **SET UP**.

4 Access the Function Set screen.

Press Δ / ∇ to move the highlight bar (arrow) to "FUNCTION SET", then press **ENTER** or \triangleright .

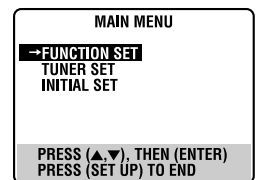

5 Select the mode.

Press Δ / ∇ to move the highlight bar (arrow) to the item you want to change.

FUNCTION		
→ PICTURE CONTROL	NORM	
3DNR	ON (PLAY)	
SUPERIMPOSE	ON	
AUTO SP-EP TIMER	OFF	
VIDEO STABILIZER	OFF	
BLUE BACK	ON	
NEXT PAGE		
SELECT WITH (▲,▼) → (ENTER)		
PRESS (SET UP) TO END		



PREVIOUS PAGE		
→ 2ND AUDIO RECORD	OFF	
AUDIO MONITOR	HI-FI	
AUTO POWER OFF	OFF	
SELECT WITH (▲,▼) → (ENTER)		
PRESS (SET UP) TO END		

6 Select the mode setting.

Press **ENTER** or \triangleright .

7 Return to the normal screen.

Press **SET UP**.

* The default setting is **bold** in the table below.

<p>■ PICTURE CONTROL NORM EDIT SOFT SHARP</p>	<p>This feature helps you to adjust the playback picture quality according to your preference. Normally select "NORM".</p> <p>NORM: Picture quality is adjusted automatically.</p> <p>EDIT: Minimizes picture degradation during editing (recording and playback).</p> <p>SOFT: Reduces image coarseness when viewing overplayed tapes containing a lot of noise.</p> <p>SHARP Clearer, sharper-edged picture when viewing images with lots of flat, same-colored surfaces such as cartoons.</p> <p>NOTES:</p> <ul style="list-style-type: none"> • When you select "EDIT", "SOFT" or "SHARP", the selected mode will not change until you select another mode. • When you select "EDIT" to dub tapes, be sure to select "NORM" after you finish dubbing the tapes.
<p>■ 3DNR ON ON (PLAY) OFF</p>	<p>The 3DNR picture system applies the noise reduction to reduce small noise, enabling clear picture with less roughness.</p> <p>ON: The 3DNR picture system is activated to reduce noise appearing on playback picture of a VHS cassette, on-air picture of the tuner, and picture from the external source connected to the unit (through the AUDIO/VIDEO input (F-1) connector). However, this feature does not affect recording signals. This mode is preferable when small noise and roughness are obvious on on-air picture of the channel to be recorded.</p> <p>ON (PLAY): The 3DNR picture system is activated only for playback picture of a VHS cassette. On-air picture of the channel to be recorded and picture from the external source connected to the unit (through the AUDIO/VIDEO input (F-1) connector) will not be affected.</p> <p>OFF: The 3DNR picture system is not activated for playback picture of a VHS cassette.</p> <p>NOTES:</p> <ul style="list-style-type: none"> • Signals to be recorded onto a tape are not affected even when "3DNR" is set to "ON" or "ON (PLAY)". • Normally it is recommended to keep "3DNR" set to "ON (PLAY)". • Depending on the type of tape being used, picture quality may be better with "3DNR" set to "OFF". • If you use the VCR as the source player for editing, be sure to set "3DNR" to "OFF" before starting.
<p>■ SUPERIMPOSE ON OFF</p>	<p>When this function is set to "ON", various operational indicators appear on the TV screen. Messages appear in the selected language. (☞ pg. 20)</p> <p>NOTES:</p> <ul style="list-style-type: none"> • When you use this unit as the source player for editing, be sure to set "SUPERIMPOSE" to "OFF" before starting. • During playback, the operation mode indicators may be disturbed depending on the type of tape being used.

* The default setting is **bold** in the table below.

<p>■ AUTO SP→EP TIMER ON OFF</p>	<p>When this function is set to “ON”, the unit automatically switches to EP mode to allow complete recording if there is not enough tape to record the entire program while timer-recording in SP mode.</p> <p>For Example: Recording a program of 140 minutes in length onto a 120-minute tape</p> <table border="1" style="margin-left: auto; margin-right: auto;"> <tr> <td style="text-align: center;">Approximately 110 minutes</td> <td style="text-align: center;">Approximately 30 minutes</td> </tr> <tr> <td style="text-align: center;">SP mode</td> <td style="text-align: center;">EP mode</td> </tr> </table> <p style="text-align: center;">Total 140 minutes</p> <p>Make sure you set this function to “ON”, before the timer-recording starts.</p> <p>NOTES:</p> <ul style="list-style-type: none"> ● If you have programmed the unit to timer-record 2 or more programs, the second program and those thereafter may not fit on the tape if you set “AUTO SP→EP TIMER” to “ON”. In this case, make sure the mode is not engaged, then set the tape speed manually during timer programming. ● In order to ensure that the recording fits on the tape, this feature may leave a slight non-recorded section at the end of the tape. ● There may be some noise and sound disturbance at the point on the tape where the unit switches from SP to EP mode. ● The Auto SP→EP Timer feature is not available during ITR (Instant Timer Recording), and the feature will not work properly on the following tapes: T(ST)-30, T(ST)-60, T(ST)-90, and T(ST)-120 	Approximately 110 minutes	Approximately 30 minutes	SP mode	EP mode
Approximately 110 minutes	Approximately 30 minutes				
SP mode	EP mode				
<p>■ VIDEO STABILIZER ON OFF</p>	<p>When this function is set to “ON”, you can automatically correct vertical vibration in the picture when playing back unstable recordings made on another recorder. If the vertical vibration does not improve, regardless of this setting, try Manual Tracking (⏮ pg. 33). However, this function might have no effect, depending on the recording condition of the tape.</p> <p>NOTES:</p> <ul style="list-style-type: none"> ● When you finish viewing a tape, be sure to set this function to “OFF”. ● Regardless of the setting, this function has no effect during recording and during special effects playback. ● The on-screen display may jitter vertically when this function is set to “ON”. 				
<p>■ BLUE BACK ON OFF</p>	<p>When this function is set to “ON”, the TV screen becomes all blue when receiving a channel not in use.</p> <p>NOTE: When you want to receive an unstable channel with poor signals, set this function to “OFF”.</p>				

* The default setting is **bold** in the table below.

<p>■ 2ND AUDIO RECORD ON OFF</p>	<ul style="list-style-type: none"> ● When this function is set to “ON”; If a SAP program is received, the SAP audio is recorded on both the normal and Hi-Fi tracks. The main audio is not recorded. If a non-SAP program is received, the main audio is recorded on both the Hi-Fi and normal tracks. ● When this function is set to “OFF”, the SAP audio cannot be recorded. <p>NOTES: When the channel is changed on the unit;</p> <ul style="list-style-type: none"> ● The “STEREO” indicator appears on the screen for about 5 seconds if the program is a stereo broadcast. ● The “SAP” indicator appears on the screen for about 5 seconds if the program is a SAP broadcast. ● Both indicators appear when a stereo program is accompanied by SAP sound.
<p>■ AUDIO MONITOR HI-FI HI-FI L HI-FI R NORM MIX</p>	<p>This unit can record two sound tracks simultaneously (normal and Hi-Fi) on a Hi-Fi stereo tape. You can select the sound track(s) to listen to while playing back a Hi-Fi stereo tape. In addition, when playing back a prerecorded tape containing two separate audio programs on the Hi-Fi tracks, you can choose either one by selecting either “HI-FI L” or “HI-FI R”.</p> <p>HI-FI: Normally select this. Hi-Fi sound is played back. HI-FI L: Sound on the left Hi-Fi channel is played back. HI-FI R: Sound on the right Hi-Fi channel is played back. NORM: Sound on the normal track is played back. MIX: Both sounds on the Hi-Fi track and normal track are mixed and played back.</p> <p>NOTES:</p> <ul style="list-style-type: none"> ● While playing back a monaural tape, sounds on the normal track will be heard regardless of this setting. ● You can also use the A.MONITOR button on the Remote to select the desired monitor sound. (☞ pg. 33)
<p>■ AUTO POWER OFF 3H OFF</p>	<p>When this function is set to “3H”, the unit is turned off automatically if no operation is done within 3 hours. “AUTO POWER OFF IN 3 MIN” appears on the screen 3 minutes before the unit is turned off.</p>

Mode Set

(DVD deck)

- Turn on the TV and select the VCR channel (or AV mode).
- Slide the TV/VCR/DVD switch to the right.

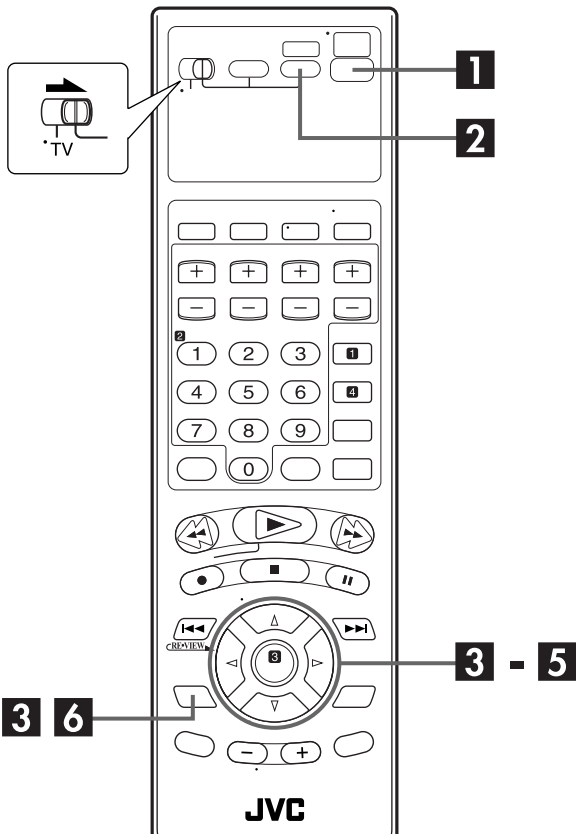

You can change various mode settings on the Mode Set screen by following the procedure described below.

- For each mode setting, see pages 79 to 81.

LANGUAGE	MENU LANGUAGE (pg. 22) AUDIO LANGUAGE (pg. 22) SUBTITLE (pg. 22) ON SCREEN LANGUAGE (pg. 21)
PICTURE	MONITOR TYPE (pg. 18, 79) PICTURE SOURCE (pg. 79) SCREEN SAVER (pg. 79) FILE TYPE (pg. 79)
AUDIO	DIGITAL AUDIO OUTPUT (pg. 79) DOWN MIX (pg. 80) D. RANGE COMPRESSION (pg. 80)
OTHERS	RESUME (pg. 81) ON SCREEN GUIDE (pg. 81) PARENTAL LOCK (pg. 58)

- The procedure shows how to set "RESUME" to "ON" on the DVD Set Up menu screen as an example.

1 Turn on the unit.

Press **POWER** (⏻).

2 Select the DVD deck.

On the unit

Press **VCR/DVD** repeatedly so that the DVD indicator lights up.

On the Remote

Press **DVD** so that the DVD indicator lights up.

3 Access the DVD Set Up menu screen.

- 1 Press **SET UP**.
- 2 Press **◀ ▶** to select "OTHERS".

- Each time you press the button, the setup menus change as follows;

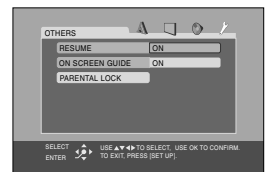

LANGUAGE → **PICTURE** → **AUDIO** → **OTHERS**
→ (Back to the beginning)

4 Select the mode.

Press **△ ▽** to move the highlight to "RESUME", then press **ENTER**.

5 Select the mode setting.

Press **△ ▽** to select "ON", then press **ENTER**.

6 Return to the normal screen.

Press **SET UP**.

NOTE:

DVD Set Up menu is displayed in STOP mode only.

Picture Settings

* The default setting is **bold** in the table below.

<p>■ MONITOR TYPE 16:9 4:3 LB 4:3 PS</p>	<p>You can select the monitor type depending the TV used when you play back DVD VIDEO discs recorded for wide-screen TVs. For more details, refer to "Monitor Set (DVD deck)" (pg. 18).</p>
<p>■ PICTURE SOURCE AUTO FILM VIDEO</p>	<p>You can obtain optimal picture quality by selecting whether the content on the disc is processed by field (video source) or by frame (film source). Normally set to "AUTO".</p> <p>AUTO: Used to play back a disc containing both video and film source materials. This unit recognizes the picture type (film or video source) of the current disc according to the disc information.</p> <p>FILM: Suitable for playing back a film or progressive source disc.</p> <p>VIDEO: Suitable for playing back a video source disc with relatively a few moments.</p> <p>● If the playback picture is unclear or noisy, or the oblique lines of the picture are rough, try to change to other modes.</p>
<p>■ SCREEN SAVER ON OFF</p>	<p>The TV screen may be burned out if a static picture is displayed for a long time. When this function is set to "ON", the unit automatically activates the screen saver function and the TV screen will be darkened if a static picture, such as an on-screen display or menu is displayed for over 5 minutes.</p>
<p>■ FILE TYPE AUDIO STILL PICTURE</p>	<p>You can select files to play back, when both MP3 files and JPEG files are recorded on a disc.</p> <p>AUDIO: Select this to play back MP3 files.</p> <p>STILL PICTURE: Select this to play back JPEG files.</p> <p>NOTE: Be sure to open and close the disc tray after changing the setting. The unit reads the disc again and the selected file type can be recognized.</p>

Audio Settings

* The default setting is **bold** in the table below.

<p>■ DIGITAL AUDIO OUTPUT PCM ONLY DOLBY DIGITAL/PCM STREAM/PCM</p>	<p>Set to the appropriate mode according to the type of the device connected to DIGITAL AUDIO OUT connector on the rear of unit. It is not necessary to set this mode when you connect no device to DIGITAL AUDIO OUT connector.</p> <p>PCM ONLY: Select this when you connect the unit's DIGITAL AUDIO OUT connector to the linear PCM digital input connector of other audio device.</p> <p>DOLBY DIGITAL/PCM: Select this when you connect the unit's DIGITAL AUDIO OUT connector to the digital input connector of a Dolby Digital Decoder or an amplifier with a built-in Dolby Digital Decoder.</p> <p>STREAM/PCM: Select this when you connect the unit's DIGITAL AUDIO OUT connector to the digital input connector of an amplifier with a built-in DTS, Dolby Digital, or MPEG multichannel decoder.</p>
---	--

<p>■ DOWN MIX DOLBY SURROUND STEREO</p>	<p>Set to the appropriate mode according to your audio system when you play back a DVD VIDEO disc recorded with surround multichannel audio. This setting affects only the analog audio output signal from the AUDIO OUTPUT connectors (DVD) when playing back a DVD VIDEO disc recorded with surround multichannel audio.</p> <p>DOLBY SURROUND:</p> <p>Select this when you enjoy multichannel surround audio by connecting the unit's analog AUDIO OUTPUT connector (DVD) to a surround decoder or an internal amplifier.</p> <p>STEREO:</p> <p>Select this when you enjoy conventional 2-channel stereo audio by connecting the unit's analog AUDIO OUTPUT connectors (DVD) to a stereo amplifier/receiver or TV, or when you dub audio of a DVD VIDEO disc recorded with surround audio to your MD, cassette, etc.</p> <p>NOTE: The "DOWN MIX" function does not work when the 3D Phonic function is activated. (☞ pg. 46)</p>
<p>■ D. RANGE COMPRESSION AUTO ON</p>	<p>You can compress the dynamic range (the difference between the loudest and quietest audio signals) of the sound when listening to the sound at a low volume or at night.</p> <p>This function is available with DVD VIDEO discs recorded with the Dolby Digital format. Set to the appropriate mode according to the number of channels recorded.</p> <p>AUTO: Audio is played back with channels other than Dolby Digital channel 1 or 2 compressed.</p> <p>ON: Audio is played back with all channel compressed.</p> <p>NOTES:</p> <ul style="list-style-type: none"> • This function works only when playing back a disc recorded with Dolby Digital format. The setting is not effective for other discs. • This function does not work when the 3D Phonic function is activated. (☞ pg. 46)

Playback discs	Output		
	STREAM/PCM	DOLBY DIGITAL/PCM	PCM ONLY
DVD VIDEO with 48 kHz, 16/20/24 bit linear PCM	48 kHz, 16 bit linear PCM		
DVD VIDEO with DTS	DTS bitstream	44.1 kHz, 16 bit stereo linear PCM	
DVD VIDEO with Dolby Digital	Dolby Digital bitstream		48 kHz, 16 bit stereo linear PCM
Audio CD/Video CD	44.1 kHz, 16 bit stereo linear PCM		
Audio CD with DTS	DTS bitstream	44.1 kHz, 16 bit stereo linear PCM	
MP3 disc	Linear PCM		

NOTES:

- The unit is not equipped with the DTS 5.1 channel decoding function.
- When you play back a DVD VIDEO or Audio CD disc with DTS, use a DTS decoder to get correct signals from your speakers. Never use the unit's analog output connectors, which output incorrect signals that may damage your speakers.
- If you connect the analog outputs and digital outputs simultaneously, be sure to select the source of the amplifier correctly, or set the level control of the amplifier connected to the analog outputs to minimum.

Others Settings

* The default setting is **bold** in the table below.

<p>■ RESUME ON OFF</p>	<p>When this function is set to “ON”, you can use the resume function. (☞ pg. 45)</p> <p>ON: You can start playback from the resume point of the placed disc.</p> <p>OFF: You cannot use the resume function.</p> <p>NOTE: This function is not available for Audio CDs and MP3 discs.</p>
<p>■ ON SCREEN GUIDE ON OFF</p>	<p>When this function is set to “ON”, the unit can display “on-screen guide” icons or characters which shows the conditions of the unit or disc.</p>

Child Lock

- Turn on the TV and select the VCR channel (or AV mode).
- Slide the **TV/VCR/DVD** switch to the right.

You can disable the unit’s operation.

1 Set the Child Lock.

Press and hold **POWER** (⏻/⏻) on the Remote for more than 10 seconds while the unit is turned on. The unit turns off, and “CL” appears on the front display panel.



- To release the child lock, press and hold **POWER** (⏻/⏻) on the Remote until the unit turns on.

NOTES:

- When the child lock function is in use, keep the Remote out of the children’s reach.
- Timer recording programs will be performed even if the child lock function activated.

Tray Lock

- Turn on the TV and select the VCR channel (or AV mode).
- Slide the **TV/VCR/DVD** switch to the right.

You can lock the disc tray to prohibit the unwanted disc ejection by children.

1 Lock the disc tray.

While the unit is turned off, press and hold **STOP** (■), then press **OPEN/CLOSE** (▲) on the unit. “Loc” appears on the front display panel and the disc tray is locked.

2 Unlock the tray.

While the unit is turned off, press and hold **STOP** (■), then press **OPEN/CLOSE** (▲) on the unit. “UnLoc” appears on the display panel.

Before requesting service for a problem, use this chart and see if you can repair the trouble yourself. Small problems are often easily corrected, and this can save you the trouble of sending your unit off for repair.

POWER

SYMPTOM	POSSIBLE CAUSE	CORRECTIVE ACTION
1. No power is supplied to the unit.	• The AC power cord is disconnected.	Connect the AC power cord.
2. The Remote won't function.	• The batteries are discharged.	Replace the dead batteries with new ones.

TAPE TRANSPORT (VCR deck)

SYMPTOM	POSSIBLE CAUSE	CORRECTIVE ACTION
1. During recording, the tape does not run. The counter display blinks on the front display panel.	• The unit is in the Record Pause mode.	Press PLAY (▶) to resume recording.
2. The tape will not rewind or fast-forward.	• The tape is already fully rewound or fast-forwarded.	Check the cassette.

PLAYBACK (VCR deck)

SYMPTOM	POSSIBLE CAUSE	CORRECTIVE ACTION
1. The VCR deck can not be operated.	• The VCR deck is not selected.	On the unit Press VCR/DVD repeatedly so that the VCR indicator lights up. On the Remote Press VCR so that the VCR indicator lights up.
2. The playback picture does not appear while the tape is running.	• If you are using the RF connection, — the TV receiver's channel selector is not set to the VCR channel. — the unit's VCR channel has not been correctly set. • If you are using the AV, S-VIDEO or Component Video connection, the TV receiver is not set to the AV mode.	If you are using the RF connection, — set the TV receiver to the VCR channel. — perform "Set the VCR channel." (☞ pg. 14). If you are using the AV or S-VIDEO, Component Video connection, set the TV to its AV mode.
3. Noise appears during visual search.	• This is normal.	
4. Noise appears during normal playback.	• The automatic tracking mode is engaged.	Try manual tracking. (☞ pg. 33)
5. The playback picture is blurred or interrupted while TV broadcasts are clear or "USE CLEANING CASSETTE" message appears on the screen.	• The video heads may be dirty.	Use a dry cleaning cassette ECL-3F, or consult your JVC dealer.
6. Breaks are noticeable in Hi-Fi soundtrack.	• The automatic tracking mode is engaged.	Try manual tracking. (☞ pg. 33)

PLAYBACK (DVD deck)

SYMPTOM	POSSIBLE CAUSE	CORRECTIVE ACTION
1. The button do not work.	<ul style="list-style-type: none"> The operation is prohibited on the placed disc. 	—
2. The DVD deck can not be operated.	<ul style="list-style-type: none"> The DVD deck is not selected. 	<p>On the unit Press VCR/DVD repeatedly so that the DVD indicator lights up.</p> <p>On the Remote Press DVD so that the DVD indicator lights up.</p>
3. "⊗" appears on the TV screen.	<ul style="list-style-type: none"> The operation is prohibited on the placed disc. 	—
4. "REGION CODE ERROR!" appears on the TV screen.	<ul style="list-style-type: none"> The disc's region number does not match that of the unit. 	Use the discs whose region number includes "ALL" or "1". (☞ pg. 7)
5. The disc cannot be played back.	<ul style="list-style-type: none"> The disc's region number does not match that of the unit. This type of the disc cannot be played back. The disc is not placed properly. The Parental Lock is engaged, and the placed disc is rated higher than the set level. 	<p>Use the discs whose region number includes "ALL" or "1". (☞ pg. 7)</p> <p>See "Unplayable Discs" (☞ pg. 7).</p> <p>Remove the disc, then place the disc properly in the disc tray. (☞ pg. 9, "Placing a Disc")</p> <p>Release the Parental Lock temporarily (☞ pg. 59), or change the set level (☞ pg. 59).</p>
6. The language is not played back as you set.	<ul style="list-style-type: none"> The disc does not contain the language you set. 	—
7. Changing audio/subtitle language is not possible.	<ul style="list-style-type: none"> The disc does not contain the audio/subtitle in the multiple languages. 	With some discs, the language should be set on the top menu. (☞ pg. 43)
8. The subtitles do not appears on the TV screen.	<ul style="list-style-type: none"> The disc does not contain the subtitles. The subtitle display is set to off. A-B Repeat Playback is in progress. (☞ pg. 51) 	<p>—</p> <p>Set the subtitles display to on. (☞ pg. 54)</p> <p>The subtitles recorded around A-B point may not appear.</p>
9. Angle cannot be changed.	<ul style="list-style-type: none"> The scene is not recorded from the multiple angles. 	—

MP3 Playback (DVD deck)

SYMPTOM	POSSIBLE CAUSE	CORRECTIVE ACTION
1. A disc cannot be played.	<ul style="list-style-type: none"> No MP3 files are recorded to the disc. MP3 files do not have the correct file extension in their file names. MP3 files are not recorded in a format compliant with ISO 9660 Level 1 or 2. The different types of files are recorded to the disc. 	<p>Replace the disc.</p> <p>Add correct file extension (.mp3, .MP3 or any uppercase and lowercase combination such as ".Mp3") to their file names.</p> <p>Replace the disc. (Record MP3 files using a compliant application.)</p> <p>The disc which contains the different types of files may not be played because of its disc characteristics or recording conditions.</p>
2. Not MP3 files but JPEG files are played.	<ul style="list-style-type: none"> The FILE TYPE setting is set to "STILL PICTURE". 	<p>When both MP3 files and JPEG files are recorded to a disc, set "FILE TYPE" to "AUDIO" to play MP3 files. (☞ pg. 79)</p>
3. The MP3 control display appears on the TV screen, but no operation can be performed.	<ul style="list-style-type: none"> No MP3 files or JPEG files are recorded to the disc, or the disc is an unplayable disc (such as CD-ROM). 	<p>Replace the disc. (☞ pg. 9)</p>

JPEG Playback (DVD deck)

SYMPTOM	POSSIBLE CAUSE	CORRECTIVE ACTION
1. A disc cannot be played.	<ul style="list-style-type: none"> No JPEG files are recorded to the disc. JPEG files do not have the correct file extension in their file names. JPEG files are not recorded in a format compliant with ISO 9660 Level 1 or 2. 	<p>Replace the disc.</p> <p>Add correct file extension (.jpg, .jpeg, .JPG, .JPEG or any uppercase and lowercase combination such as ".Jpg") to their file names.</p> <p>Replace the disc. (Record JPEG files using a compliant application.)</p>
2. Not JPEG files but MP3 files are played back.	<ul style="list-style-type: none"> The FILE TYPE setting is set to "AUDIO". 	<p>When both MP3 files and JPEG files are recorded to a disc, set "FILE TYPE" to "STILL PICTURE" to play JPEG files. (☞ pg. 79)</p>

RECORDING (VCR deck)

SYMPTOM	POSSIBLE CAUSE	CORRECTIVE ACTION
1. Recording cannot be started.	<ul style="list-style-type: none"> There is no cassette loaded, or the cassette loaded has had its record safety tab removed. 	<p>Insert a cassette, or using adhesive tape, cover the hole where the tab was removed.</p>
2. TV broadcasts cannot be recorded.	<ul style="list-style-type: none"> "F-1" has been selected as the input mode. 	<p>Set to the desired channel.</p>
3. Tape-to-tape editing is not possible.	<ul style="list-style-type: none"> The source (another video recorder, camcorder) has not been properly connected. All necessary power switches have not been turned on. The input mode is not correct. 	<p>Confirm that the source is properly connected.</p> <p>Confirm that all units' power switches are turned on.</p> <p>Set the input mode to "F-1".</p>
4. Camcorder recording is not possible.	<ul style="list-style-type: none"> The camcorder has not been properly connected. The input mode is not correct. 	<p>Confirm that the camcorder is properly connected.</p> <p>Set the input mode to "F-1".</p>
5. "○" and "▷" on the front display panel won't stop blinking.	<ul style="list-style-type: none"> The end of the tape was reached during recording. 	<p>The program may not have been recorded in its entirety. Next time make sure you have enough time on the tape to record the entire program.</p>

TIMER RECORDING (VCR deck)

SYMPTOM	POSSIBLE CAUSE	CORRECTIVE ACTION
1. Timer recording won't work.	<ul style="list-style-type: none"> • The clock and/or the timer have been set incorrectly. • The timer is not engaged. 	<p>Re-perform the clock and/or timer settings.</p> <p>Press TIMER and confirm that "⊖" is displayed on the front display panel.</p>
2. Timer programming is not possible.	<ul style="list-style-type: none"> • Timer recording is in progress. 	<p>Timer programming can't be performed while a timer recording is in progress. Wait until it finishes.</p>
3. "⊖" on the front display panel won't stop blinking.	<ul style="list-style-type: none"> • The timer is engaged but there's no cassette loaded. • The loaded cassette has had its record safety tab removed. 	<p>Load a cassette with the record safety tab intact.</p> <p>Remove the cassette and cover the hole with adhesive tape, or insert a cassette with the record safety tab intact.</p>
4. "⊖", "○" and "▷" on the front display panel won't stop blinking.	<ul style="list-style-type: none"> • The end of the tape was reached during timer recording. 	<p>The program may not have been recorded in its entirety. Next time make sure you have enough time on the tape to record the entire program.</p>
5. "⊖" blinks for 10 seconds and the Timer mode is disengaged.	<ul style="list-style-type: none"> • TIMER has been pressed when there are no programs in memory, or the timer record information has been programmed incorrectly. 	<p>Check the programmed data and re-program as necessary, then press TIMER again.</p>
6. "○" and "▷" on the front display panel won't stop blinking.	<ul style="list-style-type: none"> • The end of the tape was reached during Instant Timer Recording. 	<p>The program may not have been recorded in its entirety. Next time make sure you have enough time on the tape to record the entire program.</p>
7. "⊖", "○" and "▷" on the front display panel won't stop blinking.	<ul style="list-style-type: none"> • The Satellite Auto Recording mode is engaged but there is no cassette loaded. • The loaded cassette has had its record safety tab removed. • The end of the tape was reached during Satellite Auto Recording. 	<p>Load a cassette with the record safety tab intact.</p> <p>Remove the cassette and cover the hole with adhesive tape, or insert a cassette with the record safety tab intact.</p> <p>The program may not have been recorded in its entirety. Next time make sure you have enough time on the tape to record the entire program.</p>

OTHER PROBLEMS

SYMPTOM	POSSIBLE CAUSE	CORRECTIVE ACTION
1. The image of TV broadcast appears distorted on the TV screen.	<ul style="list-style-type: none"> The unit leaves turned on and the DVD deck is selected. 	Turn off the unit, or press VCR to select the VCR deck, then press TV/VCR so that the VCR indicator disappears from the front display panel.
2. Whistling or howling is heard from the TV during camcorder recording.	<ul style="list-style-type: none"> The camcorder's microphone is too close to the TV. The TV's volume is too high. 	Position the camcorder so its microphone is away from the TV. Turn the TV's volume down.
3. When scanning channels, some of them are skipped over.	<ul style="list-style-type: none"> Those channels have been designated to be skipped. 	If you need the skipped channels, restore them. (☞ pg. 27)
4. The channel cannot be changed.	<ul style="list-style-type: none"> Recording is in progress. 	Press PAUSE (II) to pause the recording, change channels, then press PLAY (▶) to resume recording.
5. Channel settings that were made manually seem to have changed or disappeared.	<ul style="list-style-type: none"> After the manual settings were made, Auto Channel Set was performed. 	Perform manual setting again.
6. Even though Auto or Semiauto Clock Set has been performed, the clock is incorrect.	<ul style="list-style-type: none"> The clock setting data received from the host channel is incorrect. 	Select a different host channel during "Semiauto Clock Set" (☞ pg. 25), or perform "Manual Clock Set" (☞ pg. 25).

ATTENTION

This unit contains microcomputers. External electronic noise or interference could cause malfunctioning. In such cases, switch the unit off and unplug the AC power cord. Then plug it in again and turn the unit on. Take out the cassette. After checking the cassette, operate the unit as usual.

PLAYBACK

Q. What happens if the end of the tape is reached during playback or search?

A. The tape is automatically rewound to the beginning.

Q. During search, slow, still and frame-by-frame playback, I can't hear any audio. What's the problem?

A. This is normal.

Q. Can the unit indefinitely remain in the still mode?

A. No. It stops automatically after 5 minutes to protect the heads.

Q. When returning from search to normal playback, the picture is disturbed. Should I be concerned about this?

A. No, it is normal.

Q. Noise bar appear during search. What's the problem?

A. This is normal.

Q. Sometimes, during Index Search, the unit can't find the program I want to see. Why not?

A. There may be index codes too close together.

RECORDING

Q. When I pause and then resume a recording, the end of the recording before the pause is overlapped by the beginning of the continuation of recording. Why does this happen?

A. This is normal. It reduces distortion at the pause and resume points.

Q. Can the unit indefinitely remain in the Record-Pause mode?

A. No. The unit goes to its Stop mode automatically after 5 minutes to protect the heads.

Q. What happens if the tape runs out during recording?

A. The unit stops recording, and "○" and "▷" on the front display panel won't stop blinking.

TIMER RECORDING

Q. "○" and "⊖" remain lit on the front display panel. Is there a problem?

A. No. This is a normal condition for a timer recording in progress.

Q. Can I program the timer while I'm watching a tape or a TV broadcast?

A. You won't see the picture as it is replaced by the on-screen menu, but the audio from the program or tape you're viewing can be heard.

GENERAL

Power requirement : AC 120 V~, 60 Hz
 Power consumption
 Power on : 26 W
 Power off : 2.0 W
 Temperature
 Operating : 5°C to 40°C (41°F to 104°F)
 Storage : -20°C to 60°C (-4°F to 140°F)
 Operating position : Horizontal only
 Dimensions (WxHxD)
 : 435 mm x 93 mm x 272 mm
 (17.12 in x 3.66 in x 10.71 in)
 Weight : 4.1 kg (9.041 lb)
 Format : VHS NTSC standard
 Maximum recording time
 (SP) : 210 min. with ST-210 video cassette
 (EP) : 630 min. with ST-210 video cassette

VIDEO/AUDIO (VCR deck)

Signal system : NTSC color signal and EIA
 monochrome signal, 525 lines/
 60 fields
 Recording system : DA4 (Double Azimuth) head helical
 scan system
 Signal-to-noise ratio: 45 dB
 Horizontal resolution
 : 230 lines
 Frequency range : 70 Hz to 10,000 Hz (Normal audio)
 20 Hz to 20,000 Hz (Hi-Fi audio)

VIDEO/AUDIO (DVD deck)

Signal system : NTSC
 Applicable disc : DVD (12 cm, 8 cm)
 CD (12 cm, 8 cm)
 Audio characteristics
 DVD : 4 Hz – 22 KHz
 Frequency response
 CD : 4 Hz – 20 KHz
 S/N Ratio : 90 dB
 Harmonic distortion
 : 0.1 %
 Wow and flutter : Below Measurable Level
 Dynamic range : 90 dB

CONNECTORS (VCR deck/DVD deck)

Input/Output : RCA connectors IN x 1, OUT x 1
 S-video Output connector OUT x 1
 Component Video Out connector
 (Y, P_B, P_R) x 1
 Digital Audio (optical, coaxial) x 1

TUNER

Tuning system : Frequency synthesized tuner
 Channel coverage
 VHF : Channels 2 – 13
 UHF : Channels 14 – 69
 CATV : 113 Channels
 RF output : Channel 3 or 4 (switchable; preset
 to Channel 3 when shipped)
 75 ohms, unbalanced

TIMER

Clock reference : Quartz
 Program capacity : 1-year programmable timer/
 8 programs
 Memory backup time : Approx. 5 seconds

ACCESSORIES

Provided accessories
 : RF cable,
 Infrared remote control unit,
 "AA" battery x 2

Specifications shown are for SP mode unless otherwise
 specified.
 E.& O.E. Design and specifications subject to change without
 notice.

A		J	
A-B Repeat Playback	51	JPEG control display	65
About Discs		L	
JPEG	65	Language	20
MP3	62	Language Code List	23
Placing a Disc	9	Menu/Audio/Subtitle Language Set (DVD deck only)	22
Playable Discs	7	On-screen Language Set (DVD deck)	21
Region Number	7	On-screen Language Set (VCR deck)	20
Unplayable Discs	7	Letter Box	19
Angle Selection	55	Locating the start point of the item or skip the item	44
Audio Channel Selection	57	M	
Audio Language Selection	56	Manual Channel Set	27
Auto Channel Set	26	Manual Clock Set	25
C		Manual Tracking	33
Chapter Search	53	Mode Set (DVD deck)	
Check, cancel and change programs	39	AUDIO LANGUAGE	22
Child Lock	81	D. RANGE COMPRESSION	80
Clock Set	24	DIGITAL AUDIO OUT	79
Component Video Connection	16	DOWN MIX	80
Connecting To A Dolby Digital Decoder or An Amplifier With Built-in DTS (DVD deck only)	73	FILE TYPE	79
D		MENU LANGUAGE	22
Digital Audio Dubbing	71	MONITOR TYPE	19, 79
Disc menu	43	ON SCREEN GUIDE	81
Dubbing (from DVD to VCR)	70	ON SCREEN LANGUAGE	21
E		PICTURE SOURCE	79
EDITING (DVD DECK)		RESUME	81
Digital Audio Dubbing	71	SCREEN SAVER	79
EDITING (VCR DECK)		SUBTITLE	22
Dubbing (from DVD to VCR)	70	Mode Set (VCR deck)	
Edit From A Camcorder	68	2ND AUDIO RECORD	77
Edit To Or From Another Video Recorder	69	3DNR	75
Elapsed Recording Time Indication	36	AUDIO MONITOR	77
Express Timer Programming	37	AUTO POWER OFF	77
G		AUTO SP→EP TIMER	76
Group/file selection	67	BLUE BACK	76
Group/track selection	64	PICTURE CONTROL	75
I		SUPERIMPOSE	75
INDEX	10	VIDEO STABILIZER	76
Index Search	31	MP3 control display	62
Instant ReView	31		
Instant Timer Recording (ITR)	35		

N		S	
Next Function Memory	32	Satellite Auto Recording	41
O		Second Audio Recording	36
OPERATIONS ON DVD DECK	42 – 67	Semiauto Clock Set	25
OPERATIONS ON VCR DECK	29 – 41	Skip Search	31
P		Slow Motion	30, 45
Pan&Scan	19	Soundtrack Selection	33
Parental Lock		Still Picture/Frame-By-Frame Playback	30, 45
Country/Area Code List	60	Subtitle Selection	54
To change the settings	59	S-VIDEO Connection	15
To set Parental Lock for the first time	58	T	
To temporarily release the Parental Lock	59	Tape Position Indicator	12
Playback (DVD deck)	42 – 61	Tape Remaining Time	36
Playback (JPEG)	66 – 67	Time Search	52
Playback (MP3)	63 – 64	Timer Recording	37 – 41
Playback (VCR deck)	29 – 33	Top menu	43
Playback Control (PBC) Function	43, 52	Tuner Set	26
Plug & Play Set	17	V	
Progressive Scan Mode Set (VCR deck/DVD deck)	28	Variable Speed Search	30, 44
R		VFP function	47
Record One Program While Watching Another	35	W	
Recording	34 – 36	When programs overlap each other	40
Recording Resume Function	34	Z	
Region Number	7	Zooming	45, 67
Remote Control Functions	72		
Repeat Playback	32, 50, 64, 67		
Resume Function	45	3D Phonic	46



LIMITED WARRANTY

USA ONLY

ONLY FOR PRODUCT PURCHASED IN U.S.A.

CONSUMER VIDEO 1-90

JVC COMPANY OF AMERICA warrants this product and all parts thereof, except as set forth below ONLY TO THE ORIGINAL PURCHASER AT RETAIL to be FREE FROM DEFECTIVE MATERIALS AND WORKMANSHIP from the date of original retail purchase for the period as shown below. ("The Warranty Period")

PARTS	1 YR	LABOR	90 DAYS
-------	------	-------	---------

THIS LIMITED WARRANTY IS VALID ONLY IN THE FIFTY (50) UNITED STATES, THE DISTRICT OF COLUMBIA AND IN COMMONWEALTH OF PUERTO RICO.

WHAT WE WILL DO:

If this product is found to be defective, JVC will repair or replace defective parts at no charge to the original owner. Such repair and replacement services shall be rendered by JVC during normal business hours at JVC authorized service centers. Parts used for replacement are warranted only for the remainder of the Warranty Period. All products and parts thereof may be brought to a JVC authorized service center on a carry-in basis except for Television sets having a screen size 25 inches and above which are covered on an in-home basis.

WHAT YOU MUST DO FOR WARRANTY SERVICE:

Return your product to a JVC authorized service center with a copy of your bill of sale. For your nearest JVC authorized service center, please call toll free: (800) 252-5722.

If service is not available locally, box the product carefully, preferably in the original carton, and ship, insured, with a copy of your bill of sale plus a letter of explanation of the problem to the nearest JVC Factory Service Center, the name and location of which will be given to you by the toll-free number.

If you have any questions concerning your JVC Product, please contact our Customer Relations Department.

WHAT IS NOT COVERED:

This limited warranty provided by JVC does not cover:

1. Products which have been subject to abuse, accident, alteration, modification, tampering, negligence, misuse, faulty installation, lack of reasonable care, or if repaired or serviced by anyone other than a service facility authorized by JVC to render such service, or if affixed to any attachment not provided with the products, or if the model number or serial number has been altered, tampered with, defaced or removed;
2. Initial installation and installation and removal for repair;
3. Operational adjustments covered in the Owner's Manual, normal maintenance, video and audio head cleaning;
4. Damage that occurs in shipment, due to act of God, and cosmetic damage;
5. Signal reception problems and failures due to line power surge;
6. Video Pick-up Tubes/CCD Image Sensor, Cartridge, Stylus (Needle) are covered for 90 days from the date of purchase;
7. Accessories;
8. Batteries (except that Rechargeable Batteries are covered for 90 days from the date of purchase);

There are no express warranties except as listed above.

THE DURATION OF ANY IMPLIED WARRANTIES, INCLUDING THE IMPLIED WARRANTY OF MERCHANTABILITY, IS LIMITED TO THE DURATION OF THE EXPRESS WARRANTY HEREIN.

JVC SHALL NOT BE LIABLE FOR ANY LOSS OF USE OF THE PRODUCT, INCONVENIENCE, LOSS OR ANY OTHER DAMAGES, WHETHER DIRECT, INCIDENTAL OR CONSEQUENTIAL (INCLUDING, WITHOUT LIMITATION, DAMAGE TO TAPES, RECORDS OR DISCS) RESULTING FROM THE USE OF THIS PRODUCT, OR ARISING OUT OF ANY BREACH OF THIS WARRANTY. ALL EXPRESS AND IMPLIED WARRANTIES, INCLUDING THE WARRANTIES OF MERCHANTABILITY AND FITNESS FOR PARTICULAR PURPOSE, ARE LIMITED TO THE WARRANTY PERIOD SET FORTH ABOVE.

Some states do not allow the exclusion of incidental or consequential damages or limitations on how long an implied warranty lasts, so these limitations or exclusions may not apply to you. This warranty gives you specific legal rights and you may also have other rights which vary from state to state.

JVC COMPANY OF AMERICA
DIVISION OF JVC AMERICAS CORP.

1700 Valley Road
Wayne, NJ 07470

REFURBISHED PRODUCTS CARRY A SEPARATE WARRANTY, THIS WARRANTY DOES NOT APPLY. FOR DETAILS OF REFURBISHED PRODUCT WARRANTY, PLEASE REFER TO THE REFURBISHED PRODUCT WARRANTY INFORMATION PACKAGED WITH EACH REFURBISHED PRODUCT.

For customer use:
Enter below the Model No. which is located either on the rear, bottom or side of the cabinet. Retain this information for future reference.

Model No. : _____ Serial No. : _____

Purchase date : _____ Name of dealer : _____

TO OUR VALUED CUSTOMER _____

THANK YOU FOR PURCHASING THIS JVC PRODUCT.
WE WANT TO HELP YOU ACHIEVE A PERFECT EXPERIENCE.

**NEED HELP ON HOW TO HOOK UP?
NEED ASSISTANCE ON HOW TO OPERATE?
NEED TO LOCATE A JVC SERVICE CENTER?
LIKE TO PURCHASE ACCESSORIES?**

JVC[®] IS HERE TO HELP!

**TOLL FREE: 1 (800) 252-5722
<http://www.jvc.com>**

Remember to retain your Bill of Sale for Warranty Service.

_____ Do not attempt to service the product yourself _____

Caution

To prevent electrical shock, do not open the cabinet.
There are no user serviceable parts inside.
Please refer to qualified service personnel for repairs.

JVC

VICTOR COMPANY OF JAPAN, LIMITED

Free Manuals Download Website

<http://myh66.com>

<http://usermanuals.us>

<http://www.somanuals.com>

<http://www.4manuals.cc>

<http://www.manual-lib.com>

<http://www.404manual.com>

<http://www.luxmanual.com>

<http://aubethermostatmanual.com>

Golf course search by state

<http://golfingnear.com>

Email search by domain

<http://emailbydomain.com>

Auto manuals search

<http://auto.somanuals.com>

TV manuals search

<http://tv.somanuals.com>