

# JVC

## PORTABLE AUDIO SYSTEM

### RA-P10

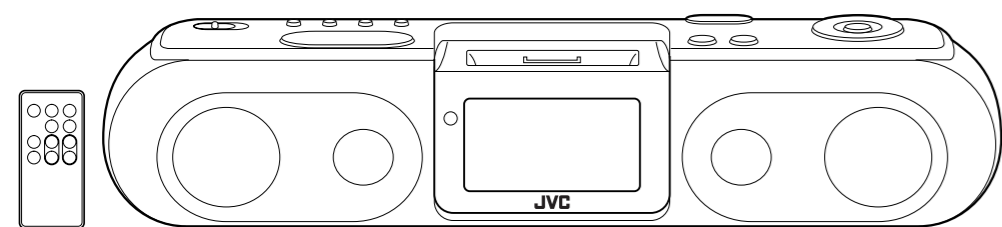

# JVC

## INSTRUCTIONS

LVT1634-002B [C]

EN

©2006 Victor Company of Japan, Limited

0906NSMCREBET

## Warnings, Cautions and Others / Mises en garde, précautions et indications diverses

(For U.S.A)

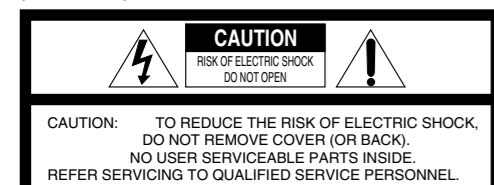

The lightning flash with arrowhead symbol, within an equilateral triangle is intended to alert the user to the presence of uninsulated "dangerous voltage" within the product's enclosure that may be of sufficient magnitude to constitute a risk of electric shock to persons.

The exclamation point within an equilateral triangle is intended to alert the user to the presence of important operating and maintenance (servicing) instructions in the literature accompanying the appliance.

(For U.S.A)

**WARNING: TO REDUCE THE RISK OF FIRE OR ELECTRIC SHOCK, DO NOT EXPOSE THIS APPLIANCE TO RAIN OR MOISTURE.**

**CAUTION**  
To reduce the risk of electrical shocks, fire, etc.:

- 1 Do not remove screws, covers or cabinet.
- 2 Do not expose this appliance to rain or moisture.

**ATTENTION**  
Afin d'éviter tout risque d'électrocution, d'incendie, etc.:

- 1 Ne pas enlever les vis ni les panneaux et ne pas ouvrir le coffret de l'appareil.
- 2 Ne pas exposer l'appareil à la pluie ni à l'humidité.

• Rating label is placed on the exterior of the bottom.

**CAUTION— ⚡/ switch!**  
Disconnect the mains plug to shut the power off completely. When installing the product ensure that the plug is easily accessible. The ⚡ switch in any position does not disconnect the mains line.

**ATTENTION— Interrupteur ⚡/!**  
Déconnectez la fiche secteur pour mettre l'appareil complètement hors tension. Lors de l'installation de l'appareil, assurez-vous que la fiche soit facilement accessible. L'interrupteur ⚡/ dans n'importe quelle position ne déconnecte pas l'appareil du secteur.

(For U.S.A)

This equipment has been tested and found to comply with the limits for a Class B digital device, pursuant to part 15 of the FCC Rules. These limits are designed to provide reasonable protection against harmful interference in a residential installation. This equipment generates, uses and can radiate radio frequency energy and, if not installed and used in accordance with the instructions, may cause harmful interference to radio communications. However, there is no guarantee that interference will not occur in a particular installation. If this equipment does cause harmful interference to radio or television reception, which can be determined by turning the equipment off and on, the user is encouraged to try to correct the interference by one or more of the following measures:  
Reorient or relocate the receiving antenna.  
Increase the separation between the equipment and receiver.  
Connect the equipment into an outlet on a circuit different from that to which the receiver is connected.  
Consult the dealer or an experienced radio/TV technician for help.

(For U.S.A)

**CAUTION**  
Changes or modifications not approved by JVC could void the user's authority to operate the equipment.

**For Canada/pour le Canada**

THIS DIGITAL APPARATUS DOES NOT EXCEED THE CLASS B LIMITS FOR RADIO NOISE EMISSIONS FROM DIGITAL APPARATUS AS SET OUT IN THE INTERFERENCE-CAUSING EQUIPMENT STANDARD ENTITLED "DIGITAL APPARATUS," ICES-003 OF THE DEPARTMENT OF COMMUNICATIONS.

CET APPAREIL NUMERIQUE RESPECTE LES LIMITES DE BRUITS RADIOELECTRIQUES APPLICABLES AUX APPAREILS NUMERIQUES DE CLASSE B PRESCRITES DANS LA NORME SUR LE MATERIEL BROUILLEUR: "APPAREILS NUMERIQUES", NMB-003 EDICTEE PAR LE MINISTRE DES COMMUNICATIONS.

**Precautions**

- Install in a place which is level, dry and neither too hot nor too cold—between 5°C and 35°C.
- Install the System in a location with adequate ventilation to prevent internal heat buildup inside the System.

**STOP!** DO NOT install the System in a location near heat sources, or in a place subject to direct sunlight, excessive dust or vibration.

- Leave sufficient distance between the System and the TV.
- Keep the speakers away from the TV to avoid interference with TV.

**Caution: Proper Ventilation**

To avoid risk of electric shock and fire, and to prevent damage, locate the apparatus as follows:  
Front: No obstructions and open spacing.  
Sides/ Top/ Back: No obstructions should be placed in the areas shown by the dimensions below.  
Bottom: Place on the level surface. Maintain an adequate air path for ventilation by placing on a stand with a height of 10 cm or more.

**Attention: Aeration correcte**  
Pour prévenir tout risque de décharge électrique ou d'incendie et éviter toute détérioration, installez l'appareil de la manière suivante:  
Avant: Bien dégagé de tout objet.  
Cotes/dessus/dessous: Assurez-vous que rien ne bloque les espaces indiqués sur le schéma ci-dessous.  
Dessous: Posez l'appareil sur une surface plane et horizontale. Veillez à ce que sa ventilation correcte puisse se faire en le plaçant sur un support d'au moins dix centimètres de hauteur.

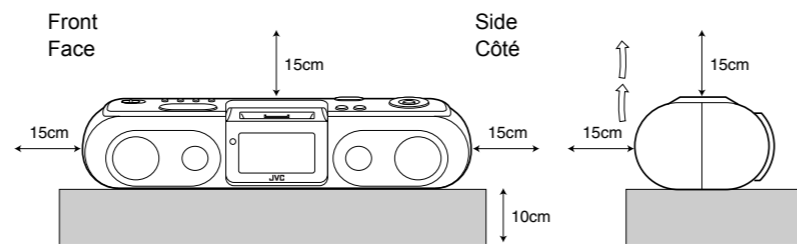

(European Union only)  
(Union européenne seulement)

## Getting Started

● **Supplied Accessories**

After unpacking, check to be sure that you have all the following items.

- Remote control
  - AC adaptor
  - Attachments (6 types)
  - Rubber pads (A type×2, B type×2)
  - CR2025 (×2) lithium coin batteries
- One is loaded on the remote control at the factory.

● **Prepare the Remote Control**

- When you use the remote control for the first time, pull out the insulation sheet.

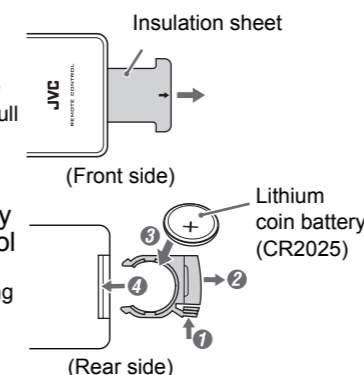

**Replacing the Battery in the Remote Control**

- Insert the battery into the remote control by matching the polarity (+ and -) correctly.

● **Preparation of the Unit**

◆ **Loading batteries for the Unit (The battery power supply)**

Insert three batteries to each compartment (six batteries total). Be sure to match the poles (+/-) correctly. While the AC adaptor is connected to the wall outlet, the unit works without batteries.

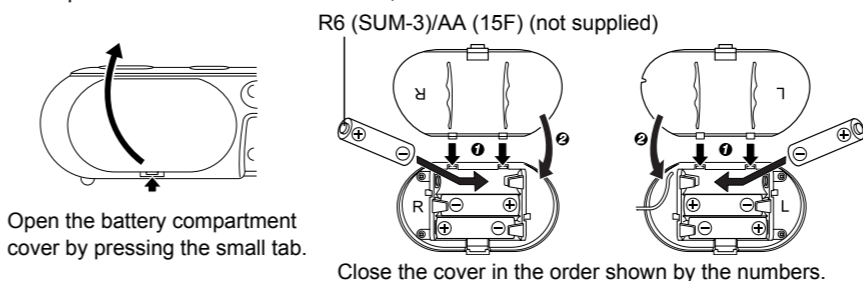

◆ **Loading batteries for the Clock**

Be sure to match the poles (+/-) correctly.

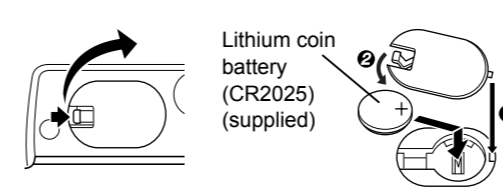

◆ **Connecting the AC adaptor**

To a wall outlet  
Plug the AC adaptor only after all connections are completed.

AC adaptor: AA-R9028 (supplied)

**CAUTION:**  
To avoid risk of fire, and to prevent damage.

- Do not use AC adaptors except for the supplied AC adaptor.
- Do not use the supplied AC adaptor for other equipment.

## Warning

- Store the battery in a place where children cannot reach. If a child accidentally swallows the battery, consult a doctor immediately.
- Do not recharge, short, disassemble or heat the battery or dispose of it in a fire. Doing any of these things may cause the battery to give off heat, crack, or start a fire.
- Do not leave the battery with other metallic materials. Doing this may cause the battery to give off heat, crack, or start a fire.
- When throwing away or saving the battery, wrap it in tape and insulate; otherwise, the battery may start to give off heat, crack, or start a fire.
- Do not poke the battery with tweezers or similar tools. Doing this may cause the battery to give off heat, crack, or start a fire.
- Dispose of battery in the proper manner, according to federal, state, and local regulations.
- The batteries (battery pack or batteries installed) shall not be exposed to excessive heat source such as sunshine, fire or the like.

**CAUTION:**  
Danger of explosion if battery is incorrectly replaced. Replace only with the same or equivalent type.

## Operating on the Remote Control

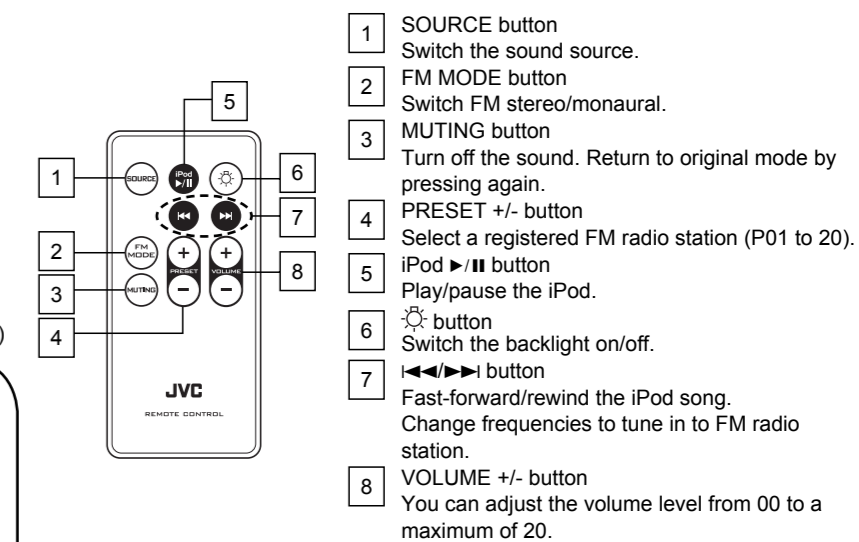

### NOTES

- Point the remote control at the remote control sensor on the front panel.
- The remote control sensor is designed to receive signals from up to approximately 7 m distance when the remote control is pointed directly. If the remote control is pointed with an angle, the distance may become shorter.

## Troubleshooting

If you are having a problem with your System, check this list for a possible solution before calling for service.

In These Cases	Check the following points
Power does not come on.	• AC adaptor is not inserted securely. Plug in securely. • The batteries are exhausted.
No longer works.	Press the "RESET" button (see "Resetting the unit").
Cannot set the iPod.	• Is the selected attachment compatible to your iPod? Confirm the compatibility of iPod and attachments in "iPod Compatibility Chart". • Is the attachment properly mounted on the unit? Make sure to mount the attachment properly.
Cannot operate iPod.	• Is the iPod firmly connected to the connector plug of the unit? • Is the iPod properly functioning? Test the iPod functions in stand alone condition.
iPod cannot be charged.	• Is the iPod firmly connected to the connector plug of the unit? • Is the AC adaptor connected? The iPod cannot be charged while the Unit is operated on batteries. • For iPod 3rd Generation, set the "CHARGING SWITCH" to "FIREWIRE" (see "Charging the iPod").
Hard to listen to broadcasts because of noise.	The FM antenna is not properly extended and positioned.
Unable to operate the System from the remote control.	• The path between the remote control and the remote sensor on the System is blocked. • The batteries are exhausted.
When the volume level is manually set higher than "08", the unit automatically lowers the level to "08".	The unit's battery runs low (The "----" (Low battery) appears on the display). Replace the batteries with new ones.

● **Resetting the unit**

If "Troubleshooting" does not eliminate malfunctioning (failure to operate or display properly, etc.), press the "RESET" button on the rear of the unit with something having a sharp point, while the unit is turned on. After pressing "RESET" button, unplug the AC adaptor and wait a while before plugging it again.

- When using "RESET" button, make sure the lithium coin battery is loaded.
- While resetting the unit, the clock is also reset. Adjust the clock after resetting the unit.

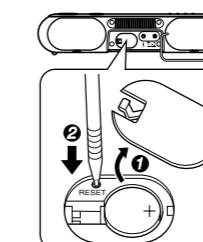

## Specifications

Model	RA-P10	
Type	Portable audio system	
Amplifier	Power Output	4W x 2
		1kHz 10% THD, 6Ω
Input Sensitivity/ Impedance	AUX Input	250mV/47kΩ
	Tuning Range	87.5MHz - 108.0MHz
FM Tuner	Frequency Step	100kHz
	Preset Stations	20
Speaker	1way full range, diameter 35mm x2	
Input Terminal	External DC IN ( for AC adaptor)	
	AUX IN (mini jack)	
Power Source	DC9V ≡ 1.5A (EXTERNAL DC IN)	
	DC9V ≡ (SIZE R6, AA BATTERY OR EQUIVALENT x6)	
AC adaptor	Input : AC 110-240V~, 50/60Hz	
	Output : DC 9V ≡ 1.5A	
Dimensions (W x H x D)	(W) 331 mm x (H) 71 mm x (D) 98 mm	
Weight (Without batteries)	0.7kg	
Accessory	See Supplied Accessories	

Specifications and appearance are subject to change without prior notice.

## Basic and Common Operations

Press	Functions
	<ul style="list-style-type: none"> <li>Light the display screen for 5 seconds when the power is turned off.</li> <li>Temporarily stop the alarm sound when the alarm is ringing (SNOOZE). (see "Stopping alarm sound")</li> </ul>

Press	Functions
	Switch the temperature display between Celsius/Fahrenheit.

Press	Functions
	Turn on or off the power

When the power is turned off at volume level "15" or higher, the unit automatically sets the volume level to "14" the next time it is turned on.

Press	Functions
	Adjust the volume level from 00 to a maximum of 20. -: Turn down the volume. +: Turn up the volume.

Press	Functions
	<ul style="list-style-type: none"> <li>Switch on/off the backlight when the button is held down.</li> <li>Switch FM stereo/monaural when FM is selected.</li> </ul>
	(see "Playing back from iPod" and "Listening to FM Broadcasts")

Press	Functions
	Select a source iPod → FM → AUX

See "How to set the time and use the alarm" Remote control sensor

### Display Information

Date	MONTH DATE 18/88	ALARM (( ))	Current time/ alarm time
Day of the week	DAY Mon Tue Wed Thu Fri Sat Sun	AM PM 20:00	
Temperature	TEMP °C 188	AUX FM 188.85 MHz	STEREO MONO

Sound source indicator	iPod/FM/AUX (blinks while muted)
When adjusting the volume	00 - 20
When FM radio is selected	P01 - P20 (channel) / 87.5 - 108.0 MHz (frequency)
When the source is set to iPod and the alarm is set to TIMER PLAY	iPod (slow blinking)
When the source is set to FM radio and the alarm is set to TIMER PLAY	87.5 - 108.0 MHz ↔ P01-P20
When battery power is low	---
When trying to set alarm to TIMER PLAY while selecting AUX	Err

STEREO "STEREO" is displayed when an FM stereo broadcast is received.  
MONO "MONO" is displayed when the monaural is selected. (see "Listening to FM Broadcasts")

- Current time: Blinking / Other Clock Display: Lighting

◆ Explanation of Icons

**ALARM** Off: current time / On: alarm time

(( )) Off: alarm off / On: alarm on / Blinking: alarm sounding (When "TIMER PLAY" is set)

Z<sup>Z</sup> Blinks while snoozing (the alarm is paused)

## How to set the time and use the alarm

Switch/Press	Functions
	Switch the alarm on/off. OFF: turn off the alarm (BUZZER/TIMER PLAY). BUZZER: alarm on (buzzer sound) TIMER PLAY: alarm on (iPod/FM radio)
	<ul style="list-style-type: none"> <li>Switch between current time and alarm time.</li> <li>Press and hold this button to select the current time/alarm time setting mode.</li> </ul>
	Change the values for the time setting.

### Setting the Clock

- Switch to current time display with the "SET" button.
- Press and hold the "SET" button. → The year display starts flashing.
- While flashing, set each item with the "DOWN"/"UP" buttons.
- Press the SET button.

• When the "SET" button is pressed, the flashing items will change in the following order.

Year → Month → Day → 12/24-hour time → Hour → Min. → time display

• The time is set when switching to time display from Minutes.

### NOTES

- The time can be set both when the power is on and off.
- To modify the setting, start again from step 1.

### Setting the alarm (ALARM-BUZZER)

- Switch to alarm time display with the "SET" button. → "ALARM" icon appears on the display.
- Press and hold the "SET" button. → The hour display starts flashing.
- While flashing, set each item with the "DOWN"/"UP" buttons.

• When the "SET" button is pressed, the flashing items will change in the following order.

Hour → Min. → TIMER PLAY time (10 to 30) → time display

• It is not necessary to set the "TIMER PLAY" time at this point.

## Playing back from other equipment

### Connecting other equipment

Connect an external device to the AUX jack on the rear of the unit using a stereo mini plug cord (not supplied).

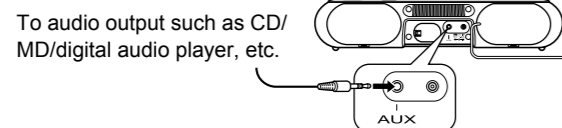

### NOTE

- Always set volume to the minimum level when connecting or disconnecting the other equipment.

### Listening to external devices

- Turn the unit power on.
- Select "AUX" with the "SOURCE" button.
- Start playback on the external device.
- Adjust the volume.

## Playing back from iPod

### Setting the iPod on the unit

- Select the attachment compatible to your iPod (see "iPod Compatibility Chart").

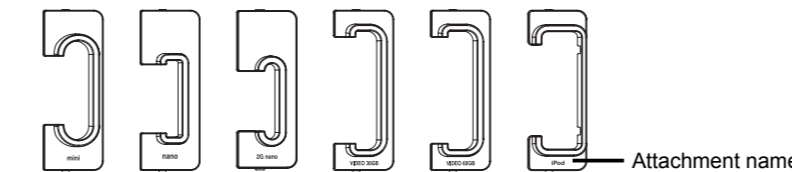

- Match the attachment tab to the hole in the unit, and insert the attachment to the unit.

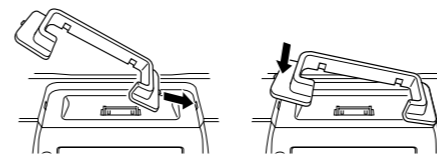

- Connect the iPod to the connector plug of the unit.

- Always set volume to the minimum level when connecting or disconnecting iPod.
- When you connect your iPod to the unit, make sure you insert it all the way.
- When disconnecting the iPod, make sure that the System is turned off.

### Listening to the iPod

- Connect the iPod to the unit.
- Turn the unit power on.
- Select "iPod" with the "SOURCE" button.  
When iPod is selected as sound source, it automatically starts playback.

Press		Functions
Unit	Remote control	
		Playback/Pause Press and hold this button to switch the iPod to sleep mode.
		Next song / fast forward (press and hold)
		Previous song (Press this button during playback to jump back to the beginning of the track.) / fast rewind (press and hold)

### Charging the iPod

- The iPod is charged while it is set on the unit when the Unit power is on.
- Connect the AC adaptor to the Unit. The iPod battery is not charged while the Unit is operated on the battery power supply.
  - The iPod is charged regardless of the sound source selected on the Unit.
  - See the iPod instruction manual about charging times.
  - The "CHARGING SWITCH" is located inside of battery compartment on the rear of the Unit.  
Set the "CHARGING SWITCH" to "FIREWIRE" for 10GB/15GB/20GB/30GB/40GB iPod 3rd Generation. For all other models, you can set the switch to either "FIREWIRE" or "USB" to charge the iPod.

### CHARGING SWITCH

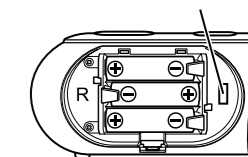

### iPod Compatibility Chart

iPod model	4 GB mini 1st Generation	iPod nano	iPod nano 2nd Generation	iPod video 5th Generation	iPod video 5th Generation
	4 GB mini 2nd Generation	1GB/2GB/4GB	2GB/4GB/8GB	30GB	60GB/80GB
	6 GB mini 2nd Generation				
Attachment names	mini	nano	2G nano	VIDEO 30GB	VIDEO 60GB

iPod model	iPod 3rd Generation 10GB/15GB/20GB	iPod 3rd Generation 30GB/40GB
	iPod 4th Generation 20GB	iPod 4th Generation 40GB
	iPod photo 4th Generation 20GB/30GB	iPod photo 4th Generation 40GB/60GB
Rubber pad	A type (Large)	
	B type (Small)	
Attachment name	iPod	
	Combine this attachment with the rubber pads. Select the rubber pad size which matches your iPod model.	

- Select the appropriate attachment for your iPod model.

### How to combine the rubber pads with the attachment

There are two types of rubber pad: "A type (Large)" and "B type (Small)". Select the appropriate rubber pads for your iPod model.

A type (Large) B type (Small)

Insert the rubber pads narrow-end first.

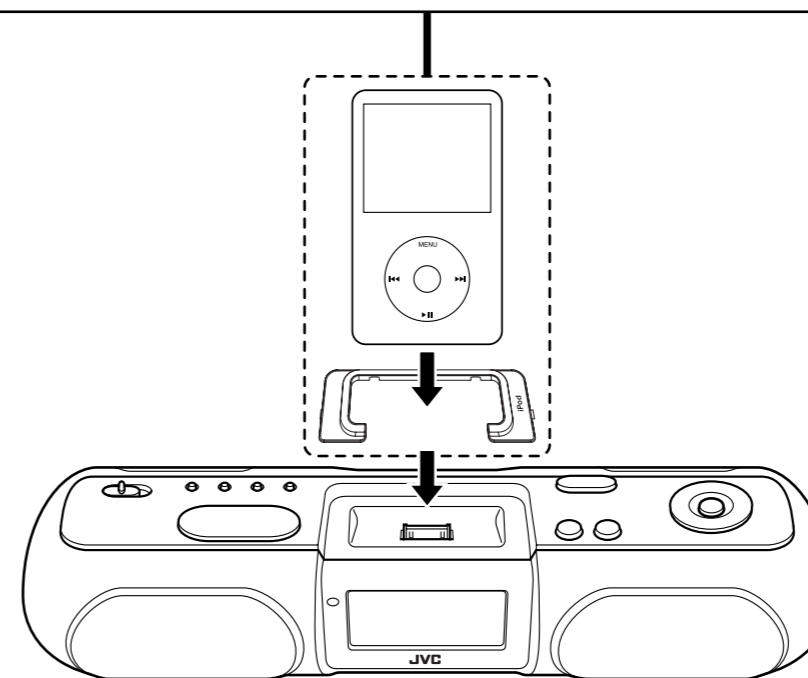
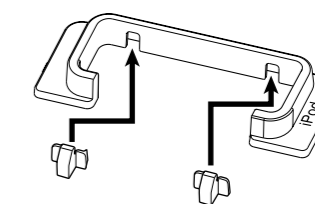

### NOTES

- The connector plug is protected with a cover when it is first purchased. Please remove the cover before operating the unit.
- Do not carry the System with iPod connected. You might drop it down or it might cause damages to the connector part.
- Do not touch or hit the iPod terminal pins or the connector pins directly. It might cause damages to the connector part.
- If the iPod does not play correctly, please update your iPod software to the latest version. - For details about updating your iPod, check on the Apple web site <http://www.apple.com>.
- iPod is a trademark of Apple Computer, Inc., registered in the U.S. and other countries.
- JVC is not responsible for any loss of or damage to iPod that might result from the use of this product.
- Sound distortion may occur when playing back audio sources with high recording levels. When distortion occurs, it is recommended to turn off the equalizer of the iPod. For information on operating the iPod, see the iPod instruction manual.

## Listening to FM Broadcasts

Press		Functions								
Unit	Remote control									
FM MODE		Switch FM stereo/monaural. When there is too much static in an FM stereo broadcast, you can reduce the static by switching to monaural reception. Press again to switch back to stereo reception. If the broadcast is not FM stereo, the sound becomes monaural, even if FM stereo is selected.								
	—	<ul style="list-style-type: none"> <li>Switch channel display / frequency display. Channel display is automatically switched to frequency display after approx. 3 seconds.</li> </ul>								
		<table border="1"> <tr> <td>FM 87.5 MHz</td> <td>STEREO</td> <td>FM P01 MHz</td> <td>STEREO</td> </tr> <tr> <td colspan="2">Frequency display</td> <td colspan="2">Channel display</td> </tr> </table> <ul style="list-style-type: none"> <li>To register a channel, press and hold this button. (see "Presetting Stations")</li> </ul>	FM 87.5 MHz	STEREO	FM P01 MHz	STEREO	Frequency display		Channel display	
FM 87.5 MHz	STEREO	FM P01 MHz	STEREO							
Frequency display		Channel display								
		Select a channel from P01 to P20. (The unit button can be used when channel display is selected.)								
		Change frequencies to tune in to FM radio station. (The unit button can be used when frequency display is selected.) • Press and hold to search broadcast stations automatically. The search is finished when the signal is received. Press again while searching to quit search.								

### Listening to FM radio

Stretch out the wire antenna located on the rear of the unit before using.

- Turn the Unit power on.
- Select "FM" with the "SOURCE" button.
- Select a station with the "◀/▶" button.

### Presetting Stations

- Select "FM" with the "SOURCE" button, and switch to channel display with "▶/⏸" button.
- Use the "◀/▶" button to select the channel number (P01 to P20) to be registered.
- Press and hold the "▶/⏸" button. → The channel number starts flashing.



- Use the "◀/▶" button to select the frequency (87.5 MHz to 108.0 MHz) of the station that you wish to register.
- Press the "▶/⏸" button → The selected frequency will be registered.

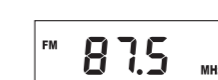

- To confirm registration, select the registered channel number (P01 to P20), and press "▶/⏸" button to display frequency.

## Free Manuals Download Website

<http://myh66.com>

<http://usermanuals.us>

<http://www.somanuals.com>

<http://www.4manuals.cc>

<http://www.manual-lib.com>

<http://www.404manual.com>

<http://www.luxmanual.com>

<http://aubethermostatmanual.com>

Golf course search by state

<http://golfingnear.com>

Email search by domain

<http://emailbydomain.com>

Auto manuals search

<http://auto.somanuals.com>

TV manuals search

<http://tv.somanuals.com>