

# JVC

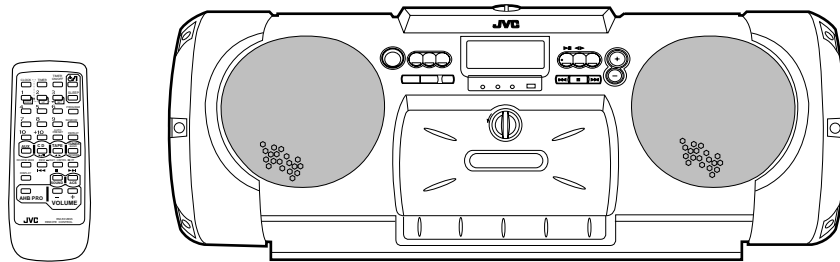

CD PORTABLE SYSTEM

# RV-B550 BU/RD



COMPACT  
**disc**  
DIGITAL AUDIO

## INSTRUCTIONS

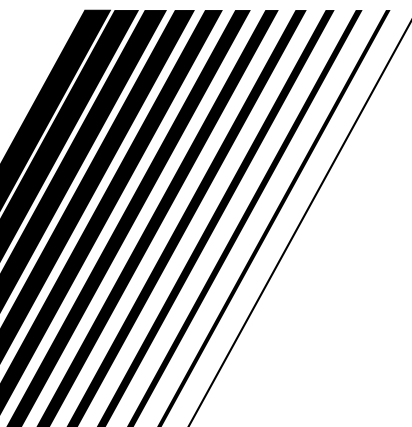

Thank you for purchasing this JVC product. Please read these instructions carefully before starting operation to be sure to obtain optimum performance and a longer service life from the unit.

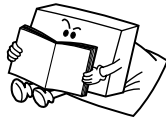

CONTENTS

Features ..... 4  
 Safety precautions ..... 4  
 Handling precautions ..... 5  
 Shoulder strap attachment/detachment ..... 5  
 Connections ..... 6  
 Power supply ..... 6  
 Names of parts and their functions ..... 8  
 Remote control unit ..... 10  
 Switching the power on/off ..... 11  
 Volume, sound mode and other controls ..... 12  
 Handling CDs..... 13  
 Playing CDs ..... 14  
 Handling cassette tapes ..... 16  
 Cassette playback ..... 17  
 Using with another audio unit ..... 17  
 Radio reception ..... 18  
 Recording ..... 20  
 Clock adjustment ..... 22  
 Timer operations ..... 23  
 Maintenance ..... 26  
 Troubleshooting ..... 27  
 Specifications ..... 27

Warnings, Cautions and Others

IMPORTANT FOR LASER PRODUCTS

REPRODUCTION OF LABELS

1 CLASSIFICATION LABEL, PLACED ON EXTERIOR SURFACE

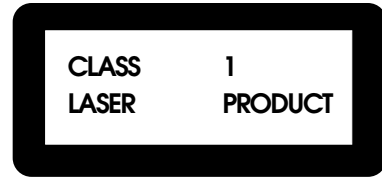

2 WARNING LABEL, PLACED INSIDE THE UNIT

<b>DANGER:</b> Invisible laser radiation when open and interlock failed or defeated. AVOID DIRECT EXPOSURE TO BEAM. (e)	<b>ADVARSEL:</b> Usynlig laserstråling ved åbning, når sikkerhedsafbrydere er ude af funktion. Undgå udsættelse for stråling. (d)	<b>WARNING:</b> Osynlig laserstråling när denna del är öppnad och spärran är urkopplad. Betrakta ej strålen. (s)	<b>VARO:</b> Avattaessa ja suojalukitus ohitettaessa olet alttiina näkymättömälle lasersäteilylle. Älä katso säteeseen. (f)
---	---	--	---

1. CLASS 1 LASER PRODUCT

- DANGER:** Invisible laser radiation when open and interlock failed or defeated. Avoid direct exposure to beam.
- CAUTION:** Do not open the top cover. There are no user serviceable parts inside the unit; leave all servicing to qualified service personnel.

**CAUTION — switch!**

Disconnect the mains plug to shut the power off completely. The switch in any position does not disconnect the mains line. The power can be remote controlled.

**CAUTION**

- To reduce the risk of electrical shocks, fire, etc.:
- Do not remove screws, covers or cabinet.
  - Do not expose this appliance to rain or moisture.

## IMPORTANT for the U.K.

**DO NOT** cut off the mains plug from this equipment. If the plug fitted is not suitable for the power points in your home or the cable is too short to reach a power point, then obtain an appropriate safety approved extension lead or consult your dealer.

**BE SURE** to replace the fuse only with an identical approved type, as originally fitted.

If nonetheless the mains plug is cut off ensure to remove the fuse and dispose of the plug immediately, to avoid a possible shock hazard by inadvertent connection to the mains supply.

If this product is not supplied fitted with a mains plug then follow the instructions given below:

### IMPORTANT:

**DO NOT** make any connection to the terminal which is marked with the letter E or by the safety earth symbol or coloured green or green-and-yellow.

The wires in the mains lead on this product are coloured in accordance with the following code:

Blue: Neutral  
Brown: Live

As these colours may not correspond with the coloured markings identifying the terminals in your plug proceed as follows:

The wire which is coloured blue must be connected to the terminal which is marked with the letter N or coloured black.

The wire which is coloured brown must be connected to the terminal which is marked with the letter L or coloured red.

IF IN DOUBT – CONSULT A COMPETENT ELECTRICIAN.

## SAFETY INSTRUCTIONS

### “SOME DO’S AND DON’TS ON THE SAFE USE OF EQUIPMENT”

**This equipment has been designed and manufactured to meet international safety standards but, like any electrical equipment, care must be taken if you are to obtain the best results and safety is to be assured.**

\*\*\*\*\*

**DO** read the operating instructions before you attempt to use the equipment.

**DO** ensure that all electrical connections (including the mains plug, extension leads and interconnections between pieces of equipment) are properly made and in accordance with the manufacturer’s instructions. Switch off and withdraw the mains plug when making or changing connections.

**DO** consult your dealer if you are ever in doubt about the installation, operation or safety of your equipment.

\*\*\*\*\*

**DO** be careful with glass panels or doors on equipment.

**DON’T** continue to operate the equipment if you are in any doubt about it working normally, or if it is damaged in any way — switch off, withdraw the mains plug and consult your dealer.

**DON’T** remove any fixed cover as this may expose dangerous voltages.

**DON’T** leave equipment switched on when it is unattended unless it is specifically stated that it is designed for unattended operation or has a standby mode. Switch off using the switch on the equipment and make sure that your family knows how to do this. Special arrangements may need to be made for infirm or handicapped people.

**DON’T** use equipment such as personal stereos or radios so that you are distracted from the requirements of road safety. It is illegal to watch television whilst driving.

**DON’T** listen to headphones at high volume, as such use can permanently damage your hearing.

**DON’T** obstruct the ventilation of the equipment, for example with curtains or soft furnishings. Overheating will cause damage and shorten the life of the equipment.

**DON’T** use makeshift stands and NEVER fix legs with wood screws — to ensure complete safety always fit the manufacturer’s approved stand or legs with the fixings provided according to the instructions.

**DON’T** allow electrical equipment to be exposed to rain or moisture.

### ABOVE ALL

— NEVER let anyone especially children push anything into holes, slots or any other opening in the case

— this could result in a fatal electrical shock;

— NEVER guess or take chances with electrical equipment of any kind

— it is better to be safe than sorry!

## FEATURES

- Active Hyper-Bass (AHB) Pro circuit for low-frequency sound reproduction
- Active Clear Sound (ACS) circuit for enhanced sound reproduction
- Speaker illumination
- Sound mode control
- One-touch operation (COMPU PLAY)
- 34-key remote control unit operates all CD, cassette deck and tuner functions
- Skip Play/Search Play/Repeat Play/Random Play
- Programmed play of up to 20 tracks
- Full-logic cassette mechanism
- Auto reverse
- Auto tape select mechanism
- Metal (type IV) and CrO<sub>2</sub> (type II) tape can be played back for superior tone quality

- CrO<sub>2</sub> (type II) tape recording capability
- 2-band digital synthesizer tuner with 45-station (30 FM and 15 AM (MW/LW)) preset capability
- Seek/manual tuning
- Auto preset tuning
- Timer/Clock function
- Timer on/off with preset volume function
- Sleep timer can be set for up to 120 minutes
- Shoulder strap
- DC IN 12 V jack for car battery

## SAFETY PRECAUTIONS

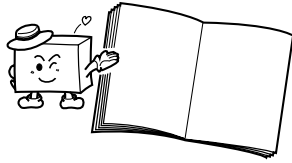

### Prevention of Electric Shocks, Fire Hazards and Damage

1. Even when the  button is set to STANDBY, a very small current will flow. To save power and for safety when not using the unit for an extended period of time, disconnect the power cord from the household AC outlet.
2. Do not handle the power cord with wet hands.
3. When unplugging from the wall outlet, always grasp and pull the plug, not the power cord.
4. Consult your nearest dealer when damage, disconnection, or contact failure affects the cord.
5. Do not bend the cord severely, or pull or twist it.
6. Do not modify the power cord in any manner.
7. To avoid accidents, do not remove screws to disassemble the unit and do not touch anything inside the unit.
8. Unplug the power cord when there is a possibility of lightning.
9. If water gets inside the unit, unplug the power cord from the outlet and consult your dealer.
10. Do not block the unit's ventilation holes that allow heat to escape. Do not install the unit in a badly ventilated place.

### button

When the power cord is connected to a household AC wall outlet, the power indicator lights in red indicating the STANDBY mode (only when AC power is used). When the  button is pressed, the power indicator goes out and the display window lights (when using DC power, it lights for only 5 seconds).

When this unit is plugged into an AC wall outlet, it consumes a small current to operate the remote control and timer, or to back up the memory of the microprocessor, even when the  button is set to STANDBY.

### Caution: Proper Ventilation

To avoid risk of electric shock and fire, and to prevent damage, locate the apparatus as follows:

1. Front:  
No obstructions and open spacing.
2. Sides/Top/Back:  
No obstructions should be placed in the areas shown by the dimensions below.
3. Bottom:  
Place on a level surface. Maintain an adequate air path for ventilation by placing on a table with a height of 10 cm or more.

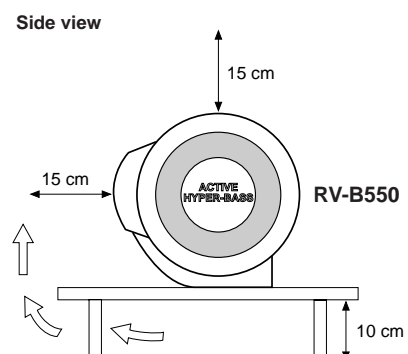
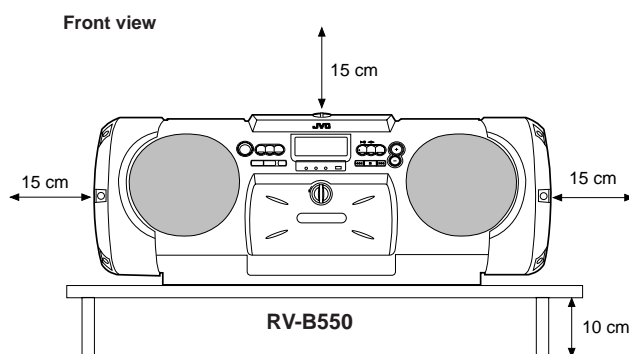

## HANDLING PRECAUTIONS

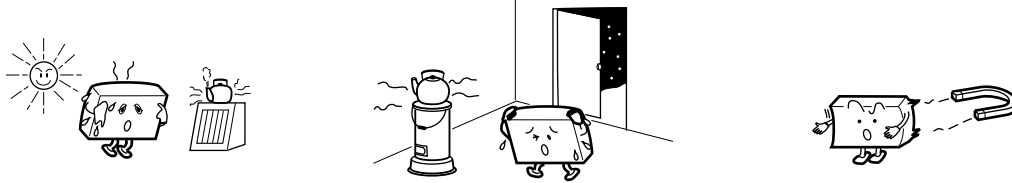

Do not use this unit in direct sunlight where it would be exposed to high temperatures above 40°C (104°F).

### ● When abnormal operation occurs

\* Unplug the AC power cord from the AC wall outlet and remove all the batteries. Then reload the batteries after a few minutes, reconnect the AC power cord and switch the power ON.

### 1. Avoid installing in the following places

- Where it could be subject to vibrations.
- Where it is excessively humid, such as in a bathroom.
- Where it could be magnetized by a magnet or speaker.

### 2. Pay attention to dust

Be sure to close the CD door so that dust does not collect on the lens.

### 3. Condensation

In the following cases, condensation may occur in the unit, in which case the unit may not operate correctly.

- In a room where a heater has just been switched on.
  - In a place where there is smoke or high humidity.
  - When the unit is moved directly from a cold to a warm room.
- In these cases, set the button to STANDBY and wait 1 or 2 hours before use.

### 4. Volume setting

CDs produce very little noise compared with analog sources. If the volume level is adjusted for these sources, the speakers may be damaged by the sudden increase of output level. Therefore, lower the volume before operation and adjust it as required during play.

### 5. Safety mechanism

This unit incorporates a safety interlock mechanism which switches the laser beam on and off, so that when the CD door is open, the laser beam stops automatically.

### 6. Do not place cassette tapes, etc. near the speakers

Since there are magnets in the speakers, do not place tapes or magnetic cards on them as recorded data could be erased.

### 7. Keep this unit away from your TV

When this unit is used near a TV, the TV picture could be distorted. If this happens, move this unit away from the TV. If this does not correct the situation, avoid using this unit when the TV is turned on.

### 8. Cleaning the cabinet

If the cabinet gets dirty, wipe it with a soft, dry cloth. Never use benzine or thinner as these could damage the surface finish.

### 9. When listening with headphones

- Do not listen at high volumes as this could damage your hearing.
- For safety, do not drive while listening to this unit.

### 10. Pay attention to the following

- Do not place the unit on an inclination.
- Do not apply shock to the unit.
- For safety, retract the antenna so that it doesn't get hooked or broken during transport.

## SHOULDER STRAP ATTACHMENT/DETACHMENT

### ● ATTACHMENT

As shown in the illustration below, press in the metal fitting at ① and hook over ②.

### ● DETACHMENT

Press in the metal fitting at ① and unhook.

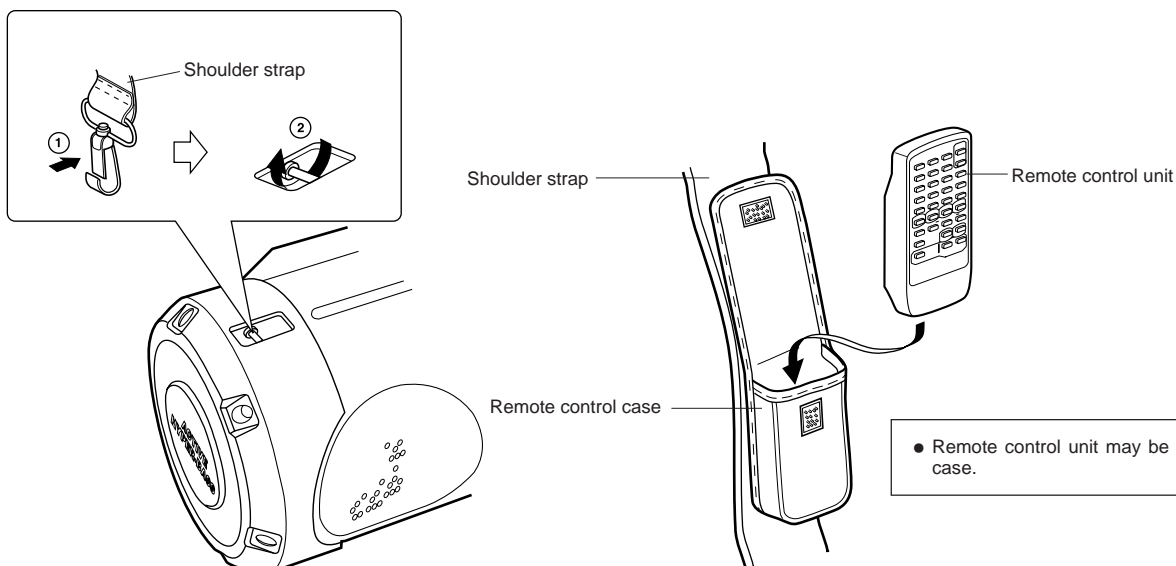

## CONNECTIONS

- Do not switch the power on until all connections are completed.

### Connection of external audio units

- Connection with a turntable or MD player, etc.

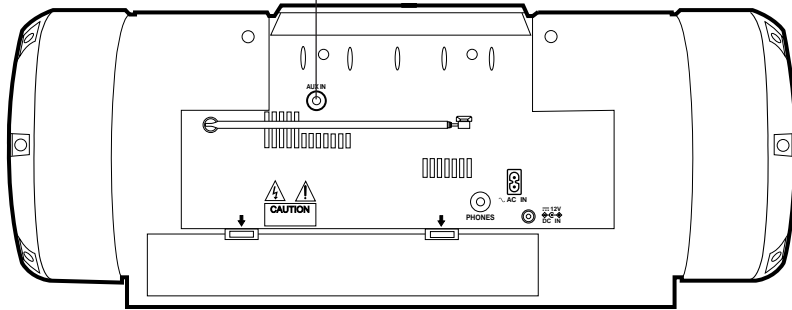
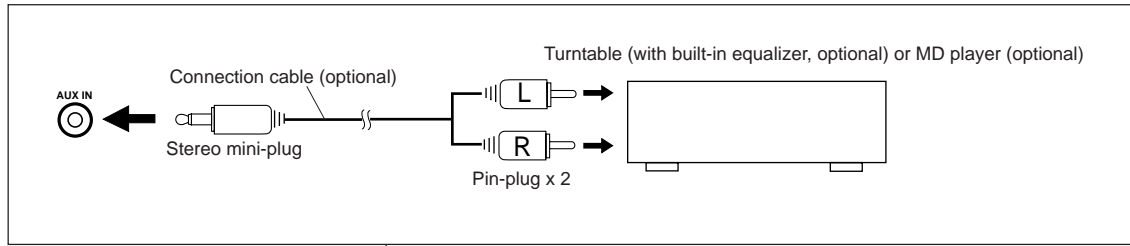

#### Note:

- Do not install the unit near a TV, otherwise the TV picture color will become distorted. If this occurs, move the TV away from the unit, then turn off the TV and turn it on again after 15 to 30 minutes. The TV's automatic degaussing circuit will correct the picture.

## POWER SUPPLY

### A. Operation on household AC

- Connect the AC power cord after all other connections have been made.

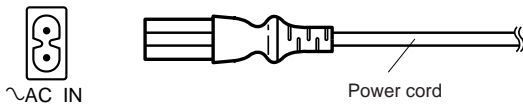

#### CAUTIONS:

- ONLY USE WITH JVC POWER CORD PROVIDED WITH THIS UNIT TO AVOID MALFUNCTION OR DAMAGE TO THE UNIT.
- BE SURE TO UNPLUG THE POWER CORD FROM THE OUTLET WHEN GOING OUT OR WHEN THE UNIT IS NOT IN USE FOR AN EXTENDED PERIOD OF TIME.

### B. Batteries for memory back-up system

It is recommended that batteries are loaded to prevent the preset station memory and timer, etc. from being erased when there is a power failure, or when the AC power cord is disconnected.

#### Loading batteries

Load three "R6/AA (15F)" size batteries (optional) into the battery compartment.

#### Notes:

- The three "R6/AA (15F)" size batteries supply the power to the memory back-up system which prevents the contents of the memory being lost when there is a power failure, or the power cord is disconnected. Battery power is not consumed when the power cord is connected to the household AC wall outlet. (When the memory backup function is activated, the time is not displayed to reduce power consumption.)
- When the power cord is not connected or the "R20/D (13F)" size batteries are not loaded, the batteries should be replaced with new ones approximately every 12 months. (Connect the AC power cord when replacing batteries in order to back-up the memory.)

- Open the battery cover by pulling it toward you while pressing the sections marked with arrows.

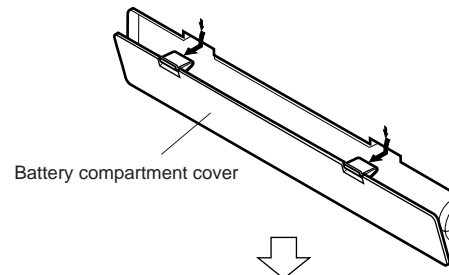

- Insert batteries with ⊖ end first in the order shown.

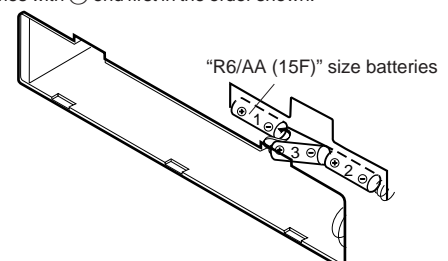

- When removing the batteries, remove battery number 3 first.

### C. Operation on batteries

#### ● Loading batteries

1. Open the battery cover by pulling it toward you while pressing the sections marked by the arrows.
2. Insert 8 "R20/D (13F)" size batteries (optional) as shown in the diagram.  
\* Be careful to insert the batteries with the ⊕ and ⊖ terminals positioned correctly.
3. Replace the cover.

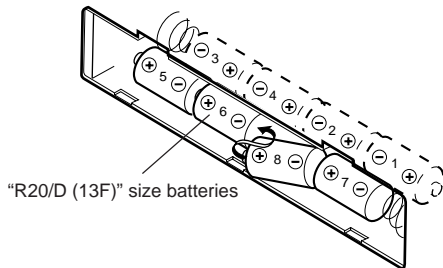

#### Battery replacement

When the batteries are nearly exhausted, the following symptoms may appear. In this case, replace the batteries with the fresh ones. (Do not use fresh ones and old ones together.)

##### For the main unit

Mistracking occurs during CD playback or sound is distorted intermittently during TAPE playback.

##### For the memory back-up

When the AC power cord is unplugged, the stored memory (timer/clock setting/preset tuning) is erased.

It is recommended that the AC power cord be used when recording important material or listening to a CD.

##### ● For better battery usage

Continuous operation of the unit causes the battery power to be consumed quicker than noncontinuous operation.

Operation of the unit in a cold place causes the battery power to be consumed more quickly than in a warm place.

##### ● For power supply

The use of household AC is recommended when continuous operation of the unit is required over a longer period of time.

#### CAUTIONS:

- WHEN NOT USING THE UNIT FOR A LONG TIME (MORE THAN TWO WEEKS) OR WHEN ALWAYS USING HOUSEHOLD AC, REMOVE THE BATTERIES TO AVOID A MALFUNCTION OR DAMAGE TO THE UNIT.
- WHEN THE JVC POWER CORD PROVIDED WITH THIS UNIT IS CONNECTED, THE POWER IS AUTOMATICALLY SWITCHED FROM THE BATTERIES TO THE HOUSEHOLD AC EVEN WHEN THE BATTERIES ARE LOADED. HOWEVER, REMOVE THE BATTERIES WHEN USING THE POWER CORD.

#### CAUTIONS WHEN USING BATTERIES

When batteries are used incorrectly, it may result in the leakage of chemicals from the batteries or they may explode. The following care should be taken:

- Check that the positive ⊕ and negative ⊖ terminals of the batteries are positioned correctly and load them as shown in the diagram.
- Do not mix new and old batteries together, or mix different types of batteries.
- Do not try to recharge non-rechargeable batteries.
- Remove the batteries when the unit is not to be used for an extended period of time.

If chemicals from the batteries come in contact with your skin, wash them off immediately with water. If chemicals leak onto the unit, clean the unit completely.

### D. Operation on car battery (DC 12 V)

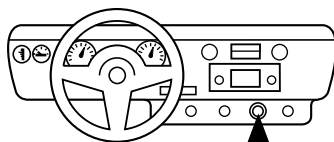

To car's cigarette lighter socket (12 V)



Optional exclusive car adapter (JVC model CA-R120E)

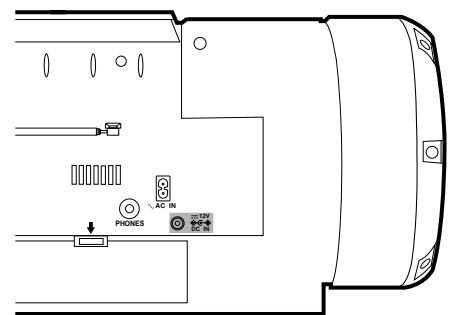

12V  
DC IN

- First connect the car adapter to the DC IN 12 V jack, not the cigarette lighter socket, because shorting of a plug on the car may cause the fuse to blow out. In addition, be careful not to make a short-circuit between the plugs.

#### CAUTIONS WHEN USING THIS UNIT IN A CAR

- When using a car battery, be sure to use the specified car adapter (JVC model CA-R120E) to prevent mishaps or damage resulting from different polarity design.
- For safety, stop the car before performing operations.
- Be sure to start the engine when you use the car adapter, otherwise the car battery will be exhausted.
- During transport, stabilize the unit in a box, etc.
- This unit is not waterproof or dustproof. To prevent malfunctions, do not leave the unit in a car for long periods.
- Unplug the power cord from the AC IN jack when using the unit with a car adapter.

## NAMES OF PARTS AND THEIR FUNCTIONS

### CD player/General section

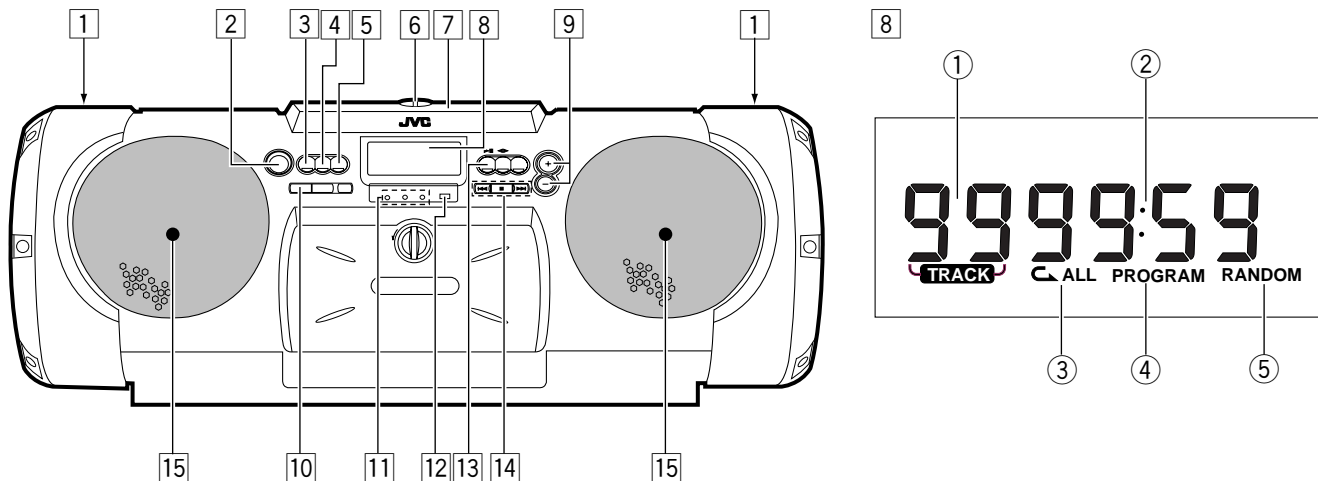

- |  |   |
|--|---|
| <p>1 Shoulder strap hook</p> <p>2  button</p> <p>3 AHB (Active Hyper Bass) PRO button</p> <p>4 SPEAKER ILLUMINATION/ACS (Active Clear Sound) button</p> <p>5 SOUND button</p> <p>6 OPEN knob<br/>Turn the OPEN knob to the left to open the CD door.<br/>To close the CD door, press it down until it clicks shut.</p> <p>7 CD door</p> <p>8 Display window</p> <p>① Function/Track number display</p> <p>② Play time display</p> <p>③ Repeat play indicator (/ALL)</p> <p>④ Program mode indicator (PROGRAM)</p> <p>⑤ Random play indicator (RANDOM)</p> <p>● See page 22 for clock adjustment display.</p> | <p>9 Volume control buttons (+/-)</p> <p>10 AUX button</p> <p>11 STANDBY indicator<br/>AHB PRO indicator<br/>ACS indicator</p> <p>12 Remote sensor section<br/>Remote control signals are received here.</p> <p>13 CD  button<br/>Press to select the CD mode.<br/>Press to play/pause.<br/>Press to turn the power on.</p> <p>14 MULTI CONTROL buttons<br/>(When the mode is set to CD)</p> <p>: Press to locate the beginning of a track during skip play.<br/>Press to fast-forward/rewind during search play.</p> <p>: Press to stop.<br/>Press to cancel program play.</p> <p>15 Speaker illumination<br/>A light in each speaker flashes when SPEAKER ILLUMINATION is on.</p> |
|--|---|



## Tuner/Deck section

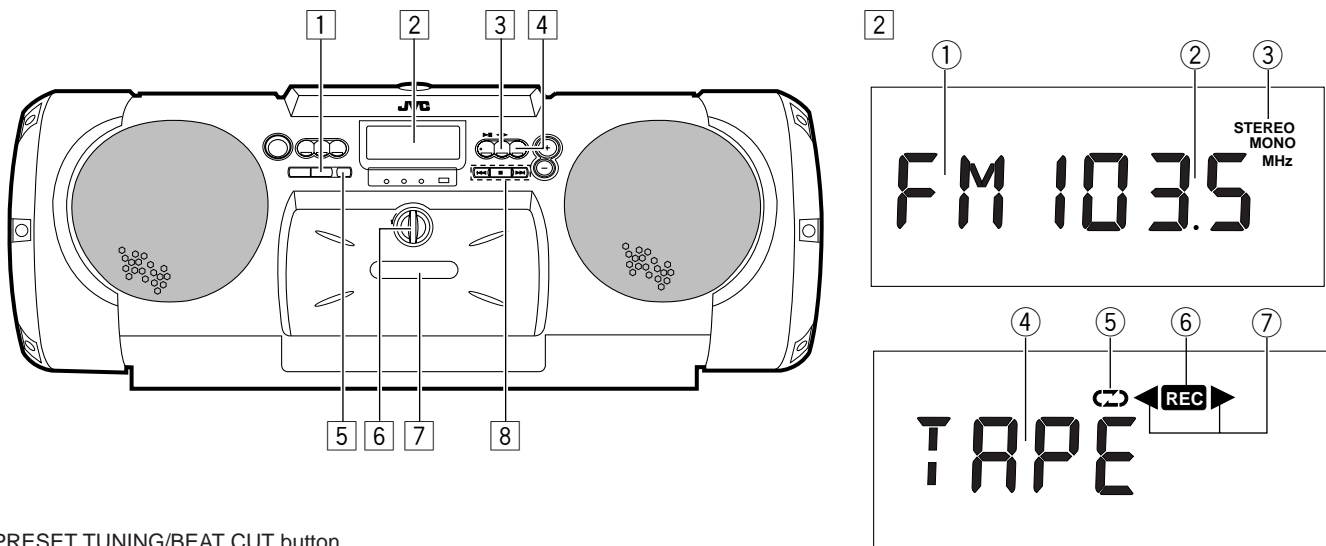

1 PRESET TUNING/BEAT CUT button

2 Display window

① Band display

② Radio frequency display

③ Mode display during FM broadcast (STEREO/MONO)

④ Tape (TAPE) display

⑤ Reverse mode indicator (Z/Z/C)

⑥ Recording indicator (REC)

⑦ Tape direction indicators (◀▶)

3 TAPE ◀▶ button

Press to select the tape mode.

Press to select the tape direction.

Press to turn the power on.

4 TUNER BAND button

Press to select the tuner mode.

Press to select the band.

Press to turn the power on.

5 ONE TOUCH REC button

6 OPEN knob

Turn the OPEN knob to the left to open the cassette holder. To close the cassette holder, press it until it clicks shut.

7 Cassette holder

8 MULTI CONTROL buttons

(When the mode is set to TAPE)

◀◀ REW : Press to rewind the tape.

■ STOP : Press to stop the tape.

▶▶ FF : Press to fast-forward the tape.

(When the mode is set to TUNER)

◀◀/▶▶ : Auto tuning/Manual tuning

## Rear panel

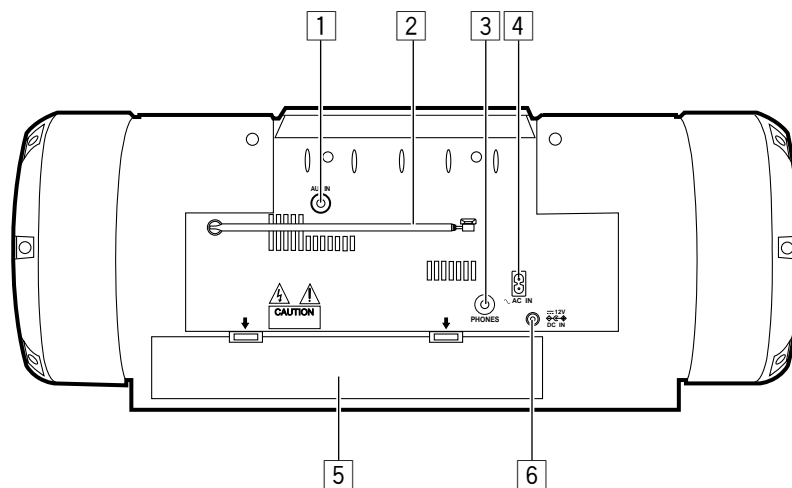

1 AUX IN (AUX input) jack

2 Telescopic antenna

3 Headphone jack (PHONES)

4 AC IN (AC input) jack

5 Battery compartment cover

6 DC IN 12 V jack (⊕-⊖)

## REMOTE CONTROL UNIT

### Preparation before use

#### ● Installing batteries in the remote control unit

1. Remove the battery cover from the back of the remote control unit.
2. Insert two "R6/AA (15F)" size batteries.
  - Insert the batteries with the ⊕ and ⊖ terminals matching the indication inside the battery compartment.
3. Replace the cover.

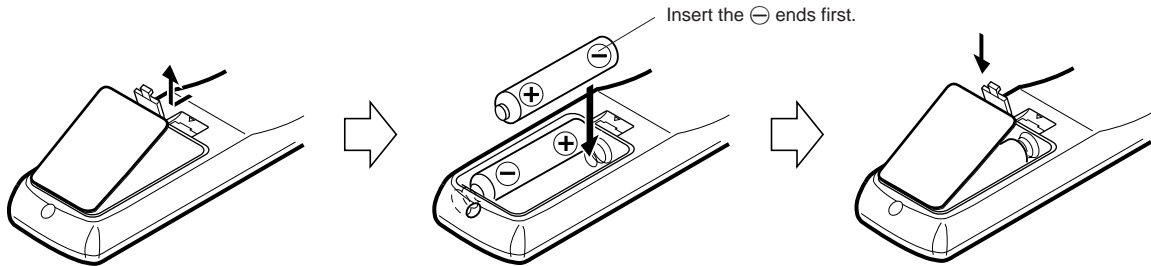

#### ● Battery replacement

When the remote control operation becomes unstable or the distance from which remote control is possible decreases, replace the batteries.

#### Using the remote control unit

- Point at the remote sensor and operate within about 7 m (approx. 23 ft).
- The remote control range is less when the unit is used at an angle.
- Do not expose the remote sensor to strong direct sunlight or artificial lighting.
- Make sure that there are no obstacles between the remote sensor and the unit.
- If the radio reception is noisy, move the remote control unit away from the main unit.

The following operations can be performed using the remote control unit.

- Check the operation button functions carefully and operate them correctly.

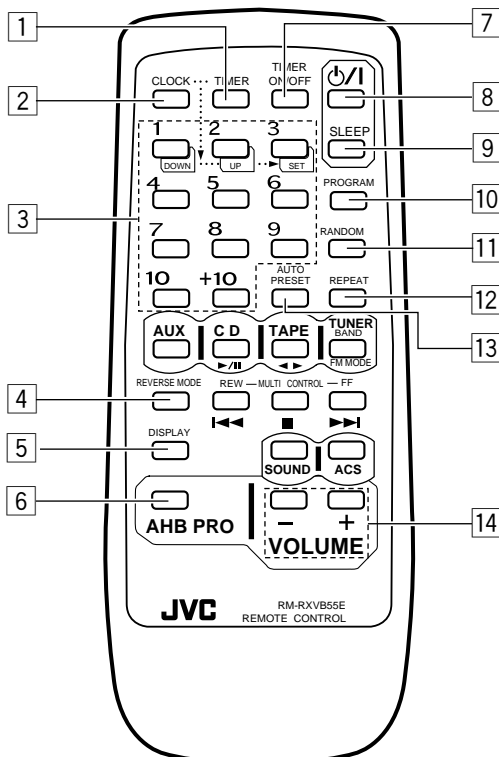

- 1 TIMER button  
Press to change the mode to TIMER.
- 2 CLOCK button  
Press to adjust the clock.
- 3 Number buttons (1-10, +10)  
(When the mode is set to CD)  
Press to play specific tracks or to program tracks.  
(When the mode is set to TUNER)  
Press to select preset stations.  
● Buttons 1-3 are also used for clock adjustment and timer operation (see page 22).
- 4 REVERSE MODE button
- 5 DISPLAY button
- 6 AHB PRO button
- 7 TIMER ON/OFF button  
Press to cancel or reset the TIMER.
- 8 Power button  
When the main unit power is supplied from batteries, pressing this button will not turn on the main unit power. (In this case, press the Power button on the main unit.)
- 9 SLEEP button
- 10 PROGRAM button  
Press to select the program play mode.
- 11 RANDOM button
- 12 REPEAT button
- 13 AUTO PRESET button
- 14 VOLUME buttons (+/-)

- Buttons not mentioned here have the same functions as those on the main unit.

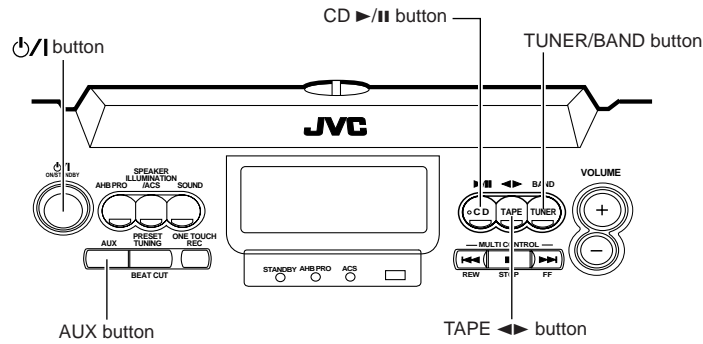

**Switching the power on/off**

● Switching on:

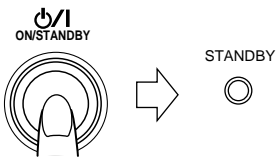

The STANDBY indicator goes out.

- The display window lights. (when using DC power, it lights for only 5 seconds)

● Switching off:

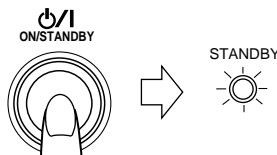

The STANDBY indicator lights.

- The display window light goes off and only the clock time is displayed.

**One touch operation (COMPU PLAY)  
(only when AC power is used)**

Even when the power is set to STANDBY, pressing the button shown below switches on the power and selects the source.

	Function mode	Operations
	CD	When this button is pressed with a CD loaded, CD playback begins.
	TAPE	When this button is pressed with a tape loaded, tape playback begins.
	TUNER	When this button is pressed, the tuner is engaged.
	AUX	A sound source connected to the AUX IN terminal can be engaged.

**Notes:**

- COMPU PLAY doesn't function when the unit is used with batteries or a car adapter. Press the ON/STANDBY button to turn on. To avoid battery exhaustion, the display window normally doesn't light. However, when the ON/STANDBY button is pressed to turn on or an operation button is pressed, the display window lights for 5 seconds.
- When switching off the power, be sure to press the ON/STANDBY button.
- The COMPU PLAY function on the remote control has the same function as that on the main unit.

## VOLUME buttons

+ : Use to increase the volume.  
 - : Use to decrease the volume.  
 (Control range from VOL 0 to VOL 50.)

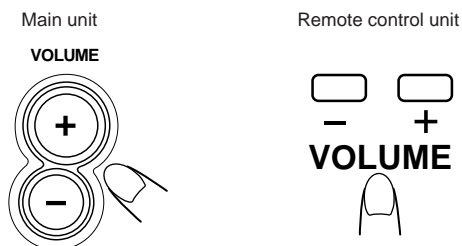

## AHB (Active Hyper Bass\*) PRO button

**BASS 1:** The AHB PRO indicator lights up, and a mild bass boost is added to the sound.

**BASS 2:** The AHB PRO indicator lights up, and a stronger bass boost is added to the sound.

**OFF :** The AHB PRO indicator goes out. Set to this position when Active Hyper Bass Pro sound is not required.

### \* Active Hyper Bass (AHB) Pro

The Active Hyper Bass Pro circuit reinforces the bass sound to maintain rich, full bass at low volumes (playback only).

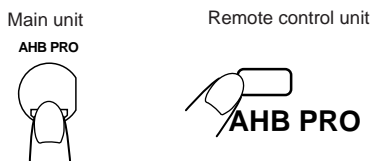

AHB PRO



AHB PRO indicator lights in red when AHB PRO is set to BASS 1/BASS 2.

## SPEAKER ILLUMINATION/ACS (Active Clear Sound\*) button

Press this button to turn enhanced sound reproduction ON/OFF. When on, a light in each speaker flashes.

### \* Active Clear Sound (ACS)

The Active Clear Sound (ACS) circuit emphasizes high-frequency sound without lowering the signal-noise ratio, while adjusting its output according to the input signal level. This results in a better balance between the high-frequency sound and the low-frequency heavy bass sound.

### Note:

This function has no effect with monaural sound sources.

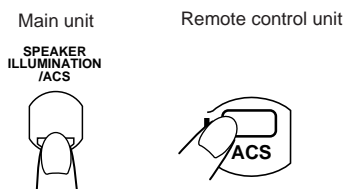

ACS



Lights in green when the ACS is ON.

## Sound mode button

Sound modes can be selected to enhance the type of music being played.

- Press the SOUND button to select the sound mode.
- Each time the SOUND button is pressed the sound mode changes as follows:

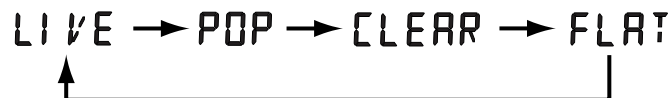
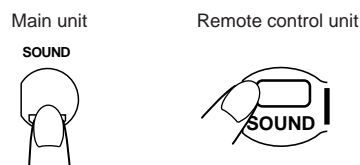

- The factory-preset is "FLAT". Each time the SOUND button is pressed, the display changes as shown.

## Sound mode selection

### LIVE:

Set to this position for heavy metal or rock music.

### POP:

Set to this position for light music including popular and vocal music.

### CLEAR:

Set to this position for crisp and clear sounding music with transparent highs.

### FLAT (No sound effect (flat characteristics)):

Set to this position when listening to classical music.

### Note:

The selected modes only affect the sound output from the speakers or headphones. They do not affect the sound when recording.

## HANDLING CDs

Since dirty, damaged and warped CDs may damage the unit, take care regarding the following:

### 1. Usable CDs

Use CDs with the Compact Disc mark shown below.

### 2. Notes on handling CDs

- Do not touch the reflective recorded surface.
- Do not stick or write anything on the label side.
- Do not bend CDs.

### 3. Storage

- After removing a CD from the unit, be sure to put it back in its case.
- Do not expose CDs to direct sunlight, high temperatures (such as from a heater), high humidity, or dust.

### 4. Cleaning CDs

- Before loading a CD, wipe off any dust, dirt or fingerprints with a soft cloth. CDs should be cleaned by wiping radially from the center to the edge.

- **Never use thinner, benzine, record cleaner or antistatic spray.**

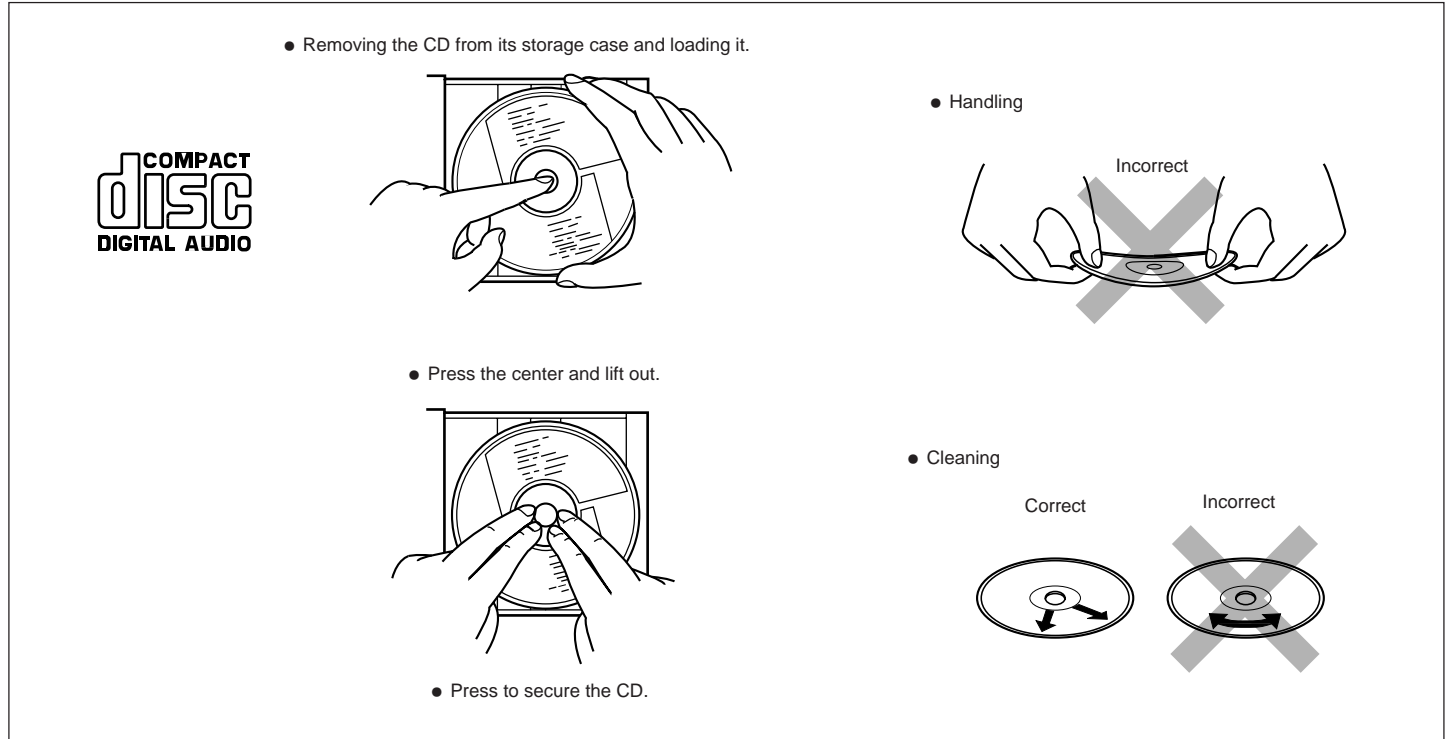

#### Note:

CDs shaped like a heart, flower, etc. (specially-shaped CDs) cannot be used with this unit. If this type of CD is loaded, it may cause a malfunction to occur.



## Playing an entire CD

The following example of playing an entire CD assumes a CD with 12 tracks and a total playing time of 48 minutes 57 seconds.

### Operate in the order shown

- When AC power is used  
(When battery power is used, switch on the button first, then perform operation):

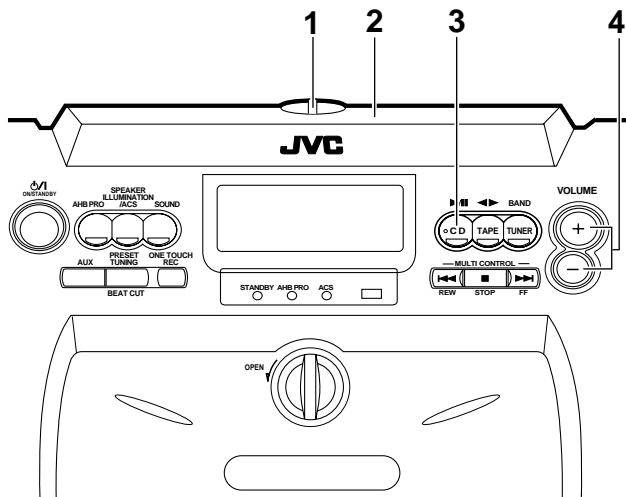

- Turn the OPEN knob to the left to open the CD door.
- Load a CD with the label side facing up and close the CD door. Press the CD door down.
- Press to start play.



- Adjust the volume.

- 8-cm (3") CDs can be used in this unit without an adapter.

### To stop in the middle of a CD

During play, press the STOP button to stop play.



- The total number of tracks and total playback time are displayed.

## Skip play

- During play, it is possible to skip forward to the beginning of the next track or back to the beginning of the track being played or the previous track; when the beginning of the required track has been located, play starts automatically.

### To listen to the next track...

Press the button once to skip to the beginning of the next track.

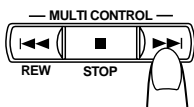

### To listen to the previous track...

Press the button to skip to the beginning of the track being played. Press twice quickly to skip to the beginning of the previous track.

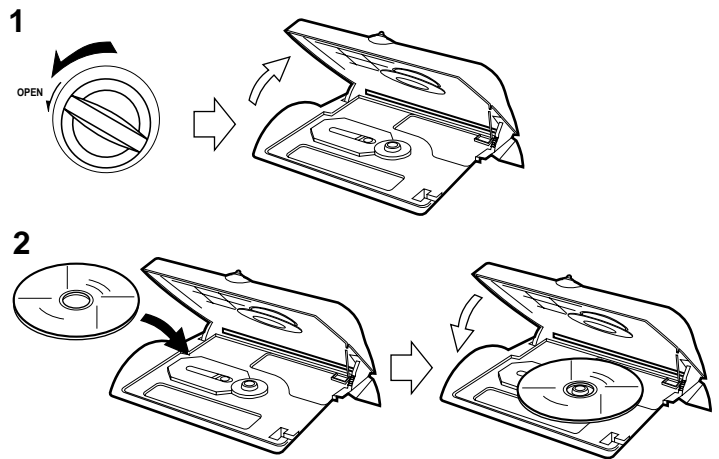
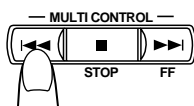

### To stop a CD temporarily

Press the CD button to stop play temporarily (the play time display blinks).

When pressed again, play resumes from the point where it was paused.

### Note:

- The following indication may appear when a CD is dirty or scratched, or when the CD is loaded upside down. In such a case, check the CD and insert again after cleaning the CD or turning it over.

000000 or nod 15C

- Do not use the unit at excessively high or low temperatures. The recommended temperature range is from 5°C (41°F) to 35°C (95°F).

- After playback, unload the CD and close the CD door.
- If mistracking occurs during play, lower the volume.
- Take the disc out of the unit before transporting it.
- Do not place anything other than a CD in the CD player, as this may cause damage to the unit.
- Do not apply shock to the unit or use the unit in an unstable position, otherwise mistracking may occur.

## Search play (to locate the required position on the CD)

- The required position can be located using fast-forward or reverse search while playing a CD.

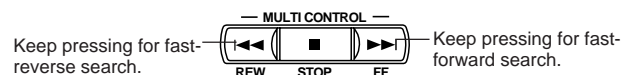

- Hold down the button; search play starts slowly and then gradually increases in speed.
- Since low-volume sound (at about one quarter of the normal level) can be heard in the search mode, monitor the sound and release the button when the required position is located.

## Direct access play (using the remote control unit)

- Pressing any of the track number buttons will start play from the beginning of the designated track. (This function cannot be used during programmed play.)

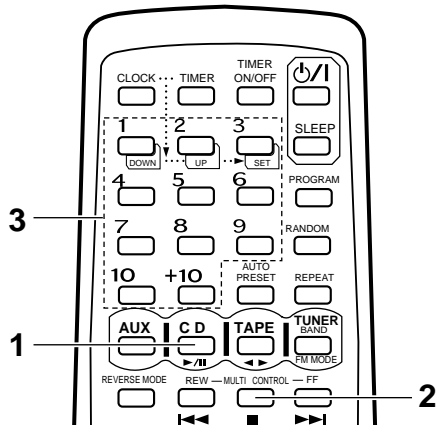

- Press the CD ►/|| button to set to the CD mode.
  - Press the ■ button.
  - Designate the required track using the track number buttons.
    - To designate track numbers 1 to 10, press the track number button corresponding to the track number.
    - To designate track number 11 or higher, press the +10 button\* the required number of times, then a track number button.
- Example:  
 (To designate the 20th track)  
 Press the +10 button once, then press track number button 10.  
 (To designate the 25th track)  
 Press the +10 button twice, then press track number button 5.
- \* +10 button:  
 Each time this button is pressed, the number increases by 10. First press this button to set the 10's digit, then press the track number button to set the 1's digit.

### To skip to another track during play

When the required track number button is pressed, the display shows the designated track number and play starts from the beginning of the designated track.

## Programmed play (using the remote control unit)

- Up to 20 tracks can be programmed to be played in any required order. The total playing time of programmed tracks is displayed (up to 99 minutes, 59 seconds).

(Example: When programming the 2nd track to be played first, and the 6th track next, then the 12th track, etc.)

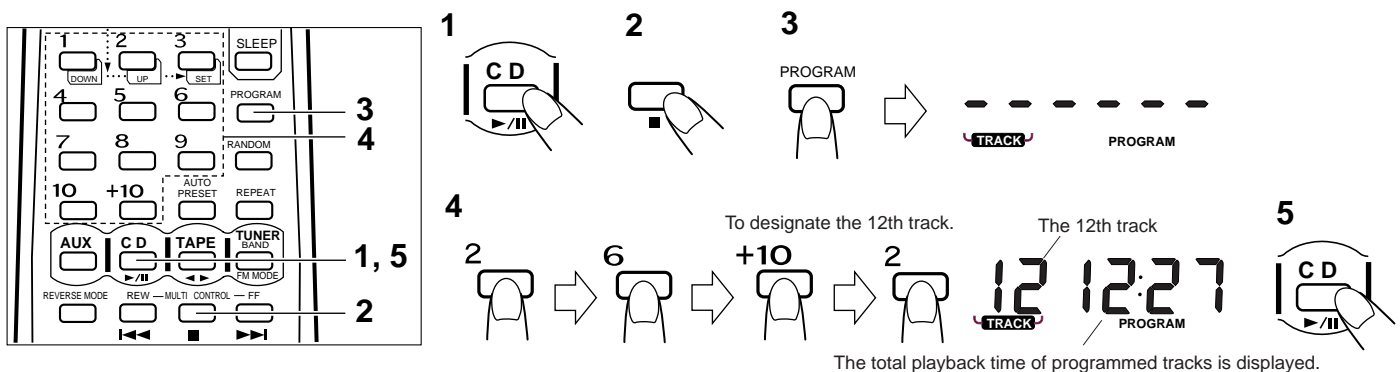

- Press the CD ►/|| button to set to the CD mode.
- Press the ■ button.
- Press the PROGRAM button to set to the programming mode.
- Press to designate the required track number. Designate the remaining tracks by pressing the track number buttons.
- Press the CD ►/|| button when programming is completed. Programmed play starts.

### To confirm the details of a program...

Press the PROGRAM button; the tracks making up the program will be displayed in programmed order.



### To clear the programmed tracks...

Press the ■ button before playing a CD. During programmed play, press this button twice. When the CD door is opened, programmed tracks are cleared automatically.

### Notes:

- If the total playing time of the programmed tracks exceeds 99 minutes 59 seconds, the total playing time indication will go out.
- No more than 21 tracks can be programmed for playback.
- When programming tracks to be recorded, the previous step 5 is not needed. Press the ONE TOUCH REC button instead of the CD ►/|| button.
- If the wrong track number is accidentally pressed, press the ■ button to cancel it and perform the same operation from step 3.
- If the power is set to STANDBY, the program is erased.

### Repeat play (using the remote control unit)

Press the REPEAT button before or during play. A single track or all the tracks can be repeated.

Whether a single track or all tracks are to be repeated can be specified. Each time the REPEAT button is pressed, the mode will change from single track (⏮), to all tracks (⏮ ALL), to clear mode, in this order.

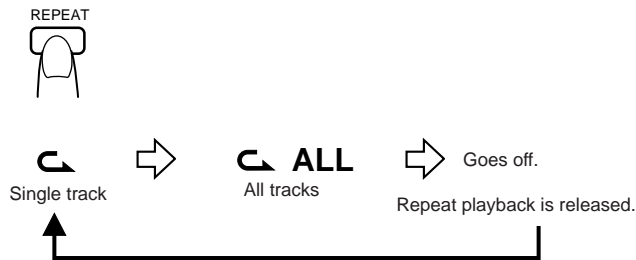

- **Single track repeat (⏮)**

The current or specified track will be played repeatedly.

- **All tracks repeat (⏮ ALL)**

All tracks or the programmed tracks of a CD will be played repeatedly.

### Random play (using the remote control unit)

Press the RANDOM button. "RANDOM" appears in the display window. After all tracks are played back once in random order, playback stops and random play is released.



**Note:**

Move the unit as far away possible from a TV or other radio set. Otherwise, the CD playback sound will be degraded or the TV picture may be distorted.

## HANDLING CASSETTE TAPES

### Cassette tapes

1. Loose tape may cause trouble. Using a pencil or similar object, gently tighten the tape as shown.
2. To prevent recordings from being erased accidentally, remove the tab(s) with a screwdriver, etc. Reseal the slots with adhesive tape to erase and re-record after the tabs have been removed.
3. C-120 cassettes are not recommended because they are prone to malfunction.

### Cassette loading

1. Turn the OPEN knob to the left to open the cassette holder.
2. Insert a cassette tape as shown on the next page.
3. Close the cassette holder.

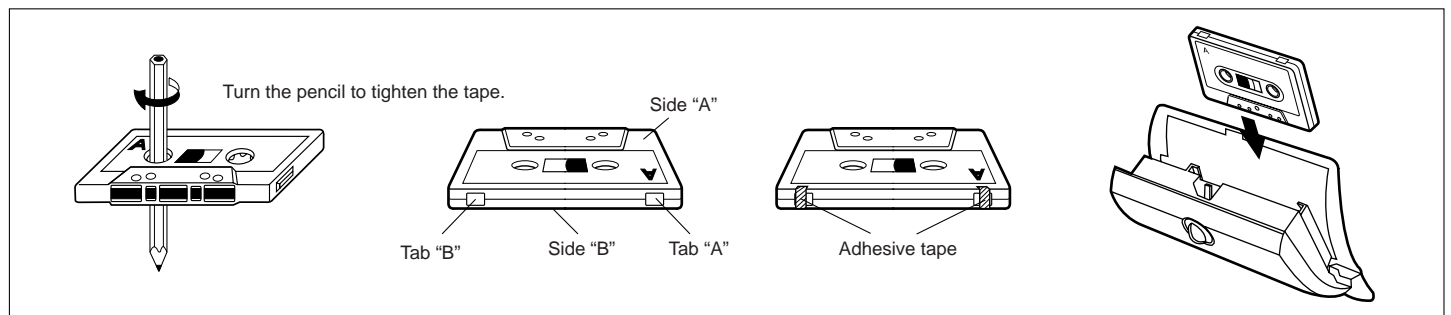

**Note:**

If the power is switched off while a tape is running, it may be impossible to remove the cassette. If this happens, switch the power on again before attempting to remove the cassette.

### Auto tape select mechanism

This unit has an Auto Tape Select mechanism which distinguishes between different types of tape using detection holes in the cassette. After the type of tape has been detected, bias and equalization suitable for the tape are set.

- Cassettes with detection holes:
  - Metal tape (EQ: 70 μs) ..... Type IV
  - CrO<sub>2</sub> (chrome) tape (EQ: 70 μs) ..... Type II
- Cassettes without detection holes:
  - Normal tape (EQ: 120 μs) ..... Type I

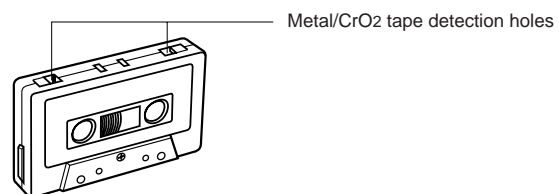



## CASSETTE PLAYBACK



### Operate in the order shown

- When AC power is used  
(When battery power is used, switch on the button first, then perform operation):

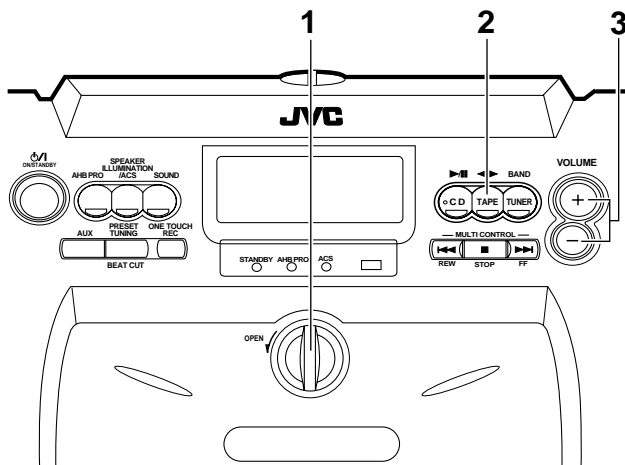

- 1 Load a cassette tape with side A facing out.
- 2 Press to start playback. (The power is switched on and the TAPE mode is engaged to start tape playback.)
- 3 Adjust the volume.

- After loading a cassette tape, simply press the TAPE button. The power is switched on and the tape starts playback. (To select the playback direction, press the TAPE button. The change in direction can be checked with the tape direction indicator ( or ).
- When the tape plays back with the reverse mode set to (single side play) or (both sides play) mode, the tape stops automatically at the end of the tape after playing one or both sides. When the reverse mode is set to the (continuous play) mode, the tape continuously plays one side after the other until you stop operation.

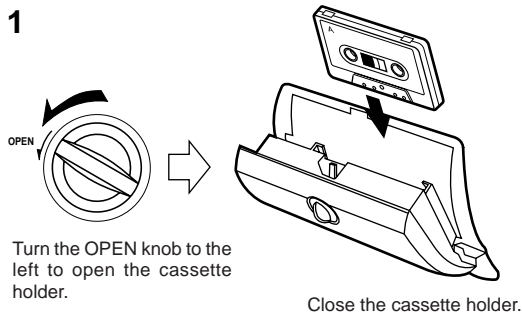

### Notes:

- Place the unit on a level surface, otherwise the cassette holder may not open when you turn the OPEN knob.
- Do not turn the OPEN knob until the tape mechanism has stopped moving.
- When no tape is loaded in the deck, its tape playback direction cannot be switched over.

### How to fast-wind tapes

1. Press the TAPE button (to set to TAPE mode).
2. Press the (REW) or (FF) button.

## USING WITH ANOTHER AUDIO UNIT

### Operate in the order shown

- When AC power is used  
(When battery power is used, switch on the button first, then perform operation):

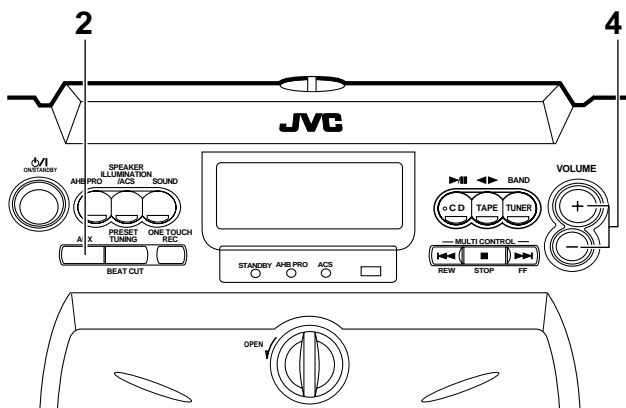

- 1 Connect the audio unit, turntable, MD player, etc. to the AUX IN jack (see page 6).
- 2 Press the AUX button. (The power is switched on and the AUX mode is engaged.)
- 3 Start playback on the connected audio unit.  
(For more details, refer to the instruction manual of the connected audio unit.)
- 4 Adjust the volume.  
(The volume level is displayed in the display window.)

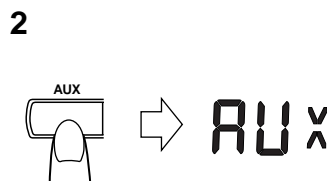



## Operate in the order shown

- When AC power is used (When battery power is used, switch on the  button first, then perform operation):

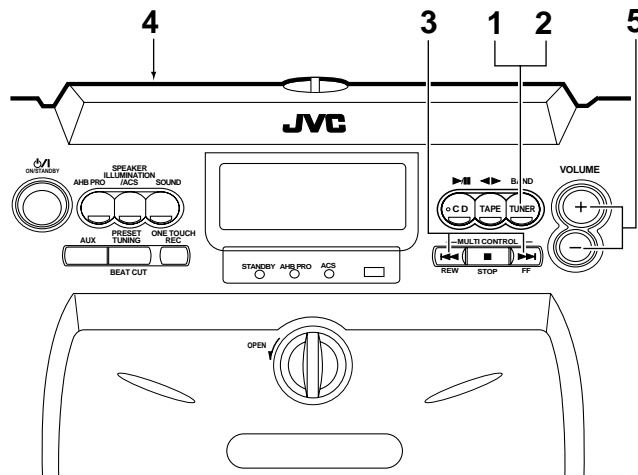

- 1 Press the TUNER BAND button.
  - The power is switched on.
- 2 Select the band by pressing the TUNER BAND button.
  - Pressing this button switches between FM stereo, FM mono and AM.
- 3 Tune to the required station.
  - Seek tuning (auto tuning) and manual tuning are available (see "Seek tuning (auto tuning)" and "Manual tuning" on this page for details).
- 4 Adjust the antenna (see page 19).
- 5 Adjust the volume.

## To listen to an FM stereo broadcast

### FM stereo

Set to this position by pressing the TUNER BAND button when listening to or recording an FM broadcast. If an FM stereo broadcast is received, the "STEREO" indicator is lit in the display window, and the FM broadcast can be heard in stereo.

### FM mono



Set to this position by pressing the TUNER BAND button if FM stereo reception is noisy. The "MONO" indicator is lit and the sound becomes monaural, but the reception will be improved.

When another station is tuned to in this mode, the "MONO" indicator goes off and the unit returns to FM stereo automatically.



### Note:

AM broadcasts are monaural.

## Seek tuning (auto tuning)



Press the  or  button for one second or more. The unit enters the seek tuning mode to tune in the nearest station automatically, so the broadcast can be heard. In AM operation, the frequency moves continuously from the MW to the LW band and vice versa.

## Manual tuning

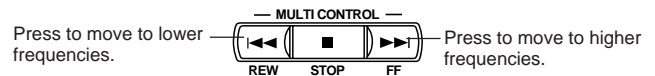
Each time the  or  button is pressed, the unit steps through the current frequency band. Tuning is done in steps of 50 kHz for FM and 9 kHz for AM (MW/LW). In AM operation, the tuned frequency moves continuously from the MW (522-1,629 kHz) to the LW (144-288 kHz) band and vice versa.



### Notes:

- When seek tuning to the required station is not possible because the broadcast signal is too weak, press the  or  button momentarily to perform manual tuning.
- When the power is set to STANDBY, or another mode (TAPE or CD) is selected, the last tuned frequency is stored in memory. When the power is switched on again and TUNER BAND button is pressed, the same station will be tuned to.

## Auto preset tuning

This function scans the current band, detecting frequencies used to broadcast signals, and stores the first 30 FM frequencies and 15 AM (MW/LW) frequencies in memory automatically.

### (Using the main unit)

Press the PRESET TUNING button for more than 2 seconds.

### (Using the remote control unit)

Press the AUTO PRESET button.

The frequencies of stations' broadcasting signals are stored in memory automatically in the order of increasing frequency. (30 stations in FM band and 15 stations in AM (MW/LW) band.)

## Presetting the desired stations (using the remote control unit)

30 stations in the FM band and 15 stations in the AM (MW/LW) band can be preset as follows:

- Example: (Presetting an FM station broadcasting at 103.5 MHz to preset button "15")

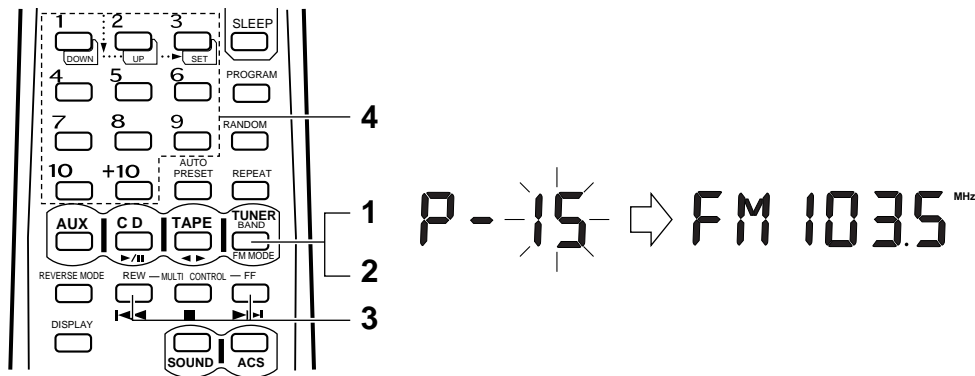

- 1 Press the TUNER BAND/FM MODE button.
- 2 Select the FM band using the TUNER BAND/FM MODE button.
- 3 Tune to the required station.
- 4 Press preset button "+10", then "5" for more than 2 sec. (When "15" blinks in the preset station display, the station has been stored.)

- Repeat the previous procedure for each of the other stations, using a different preset button each time.
- Repeat the previous procedure for the other band.

### ● To change preset stations

Perform step 4 after tuning to the required station.

### Notes:

- The previously stored station is erased when a new station is stored, because the new station's frequency replaces the previous frequency in memory.
- When listening to an AM (MW/LW) broadcast, noise may be heard if the remote control unit is used.

To prevent the preset stations from being erased because of a power failure, etc., install memory back-up batteries in the unit (see page 6).

## Preset station tuning

### (Receiving the preset stations)

- The stations must be preset before this operation can be performed.

### (Using the main unit)

- 1 Press the TUNER BAND button.
- 2 Select the band using the TUNER BAND button.
- 3 Each time the PRESET TUNING button is pressed, the next preset station is selected.

### (Using the remote control unit)

- 1 Press the TUNER BAND/FM MODE button.
  - 2 Select the band using the TUNER BAND/FM MODE button.
  - 3 Press the required preset station buttons (No. 1 – No. 10 and +10).
- The preset station number and frequency corresponding to the button pressed are shown.

## Using the antennas

FM

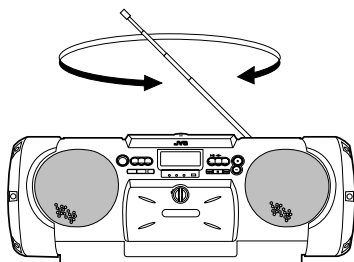

AM (MW/LW)

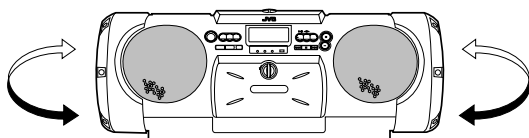

**FM:** Adjust the telescopic antenna's length, angle and direction until optimum reception is received.

**AM (MW/LW):** Install the unit where suitable reception is possible (beside a window, etc.) or change the direction of the unit.

### Note:

The built-in ferrite core antenna can pick up interference from television receivers in the neighborhood and thereby disturb AM (MW/LW) reception.

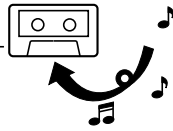

- During recording, the ALC (Automatic Level Control) circuit automatically optimizes the recording level, so manual recording level adjustment is unnecessary.
- Check that the safety tab on the cassette tape is not broken off.

**Note:**

This unit has recording characteristics suitable for normal and CrO<sub>2</sub> tapes. Normal and CrO<sub>2</sub> tapes have different characteristics from metal tapes.

**Synchronized recording with the CD player**

- In this system, the CD player starts play when the cassette deck enters the recording mode.

**Operate in the order shown**

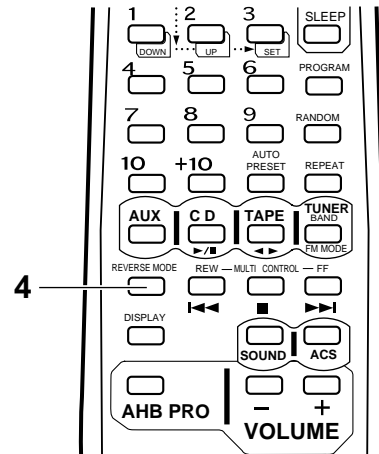
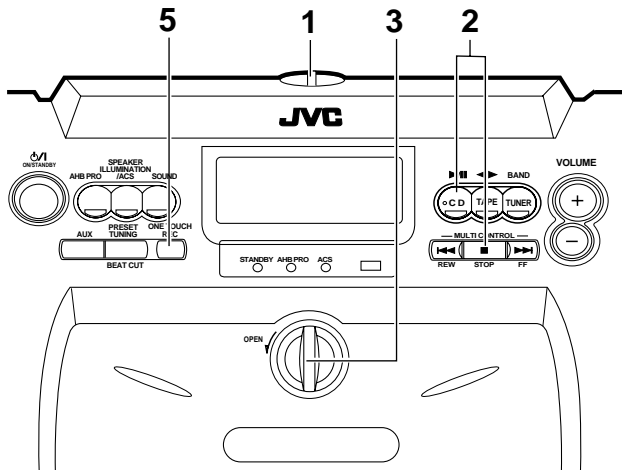

- 1 Load a CD and close the CD door.
- 2 Press the CD ►/|| button to engage the CD mode, then press the ■ STOP button to enter the stop mode.
- 3 Load a cassette with side A facing out. (Wind past the tape leader before starting recording.)
  - Make sure the tape direction is set to ► (forward direction).
- 4 Select the required reverse mode (◄ or ►) using the remote control unit.
  - When programmed play is required, program the required tracks using the remote control. (See page 15.)
  - Select tracks with a total playing time which does not exceed the tape length (refer to the liner notes).
- 5 Press the ONE TOUCH REC button; synchronized recording will start.
  - Recording starts in the forward direction and CD play starts automatically.
  - The forward direction indicator (►) blinks and the REC indicator lights up in the display window.

- Non-recorded sections of approx. 4 seconds are automatically left between tunes.
- When the CD player stops, the tape deck stops automatically.
- To stop recording in the middle, press the ■ STOP button. The cassette deck also stops after 4 seconds.

**Notes:**

- During CD synchro recording, the CD ►/|| and (◄, ►) buttons do not function.
- If a recording is completed in the reverse direction (◄), it is possible to continue recording without changing the direction to forward (►), until the tape ends.
- If continuous play (◄) is selected, a recording in the reverse direction (◄) automatically stops at the end of the tape. The ► indicator appears in the display window during recording.

**● CD complete recording function (Synchro recording mode only)**

If the tape is reversed while a CD is being played, recording will be done on the reverse side of the tape as follows:

- \* When less than 10 seconds of the last tune on the forward side of the tape have been recorded, recording on the other side of the tape will start from the beginning of the previous track.
- \* When more than 10 seconds of the last tune on the forward side of the tape have been recorded, recording on the other side of the tape will start from the beginning of the current track.

**Useful functions for recording**

**When the tape direction is set to ◄ (reverse direction) after a cassette tape is inserted...**

- 1 Press the TAPE ◄► button twice to change the tape direction to ► (forward direction).
- 2 Press the ■ STOP button.
- 3 Change the mode to CD by pressing the CD ►/|| button. (If a non-recorded tape with side A facing out is recorded in the reverse direction (◄), the recording is stopped immediately.)

**When non-recorded sections between tunes are not required...**

- 1 Press the CD ►/|| button twice. The CD player enters the pause mode.
- 2 Press the ONE TOUCH REC button to start recording.

**Note:**

- Depending on the CD used, non-recorded sections of different lengths may be left between tunes.

**To record one track...**

Play the track to be recorded. Then, press the ONE TOUCH REC button to locate the beginning of the track and enter the one track recording mode. After the recording is finished, the CD player and cassette deck both stop.

**To record only on side B or in the middle of a tape...**

- 1 Load the cassette with the required side facing out.
- 2 Set the reverse mode to ◄ with the remote control unit.
- 3 Press the ONE TOUCH REC button on the main unit. Synchronized recording starts and the cassette deck stops automatically when CD playback is completed.

**How to rewind a tape**

- 1 Press the TAPE ◄► button (to set to TAPE mode).
- 2 Press the ■ STOP button.
- 3 Press the ◄◄ (REW) button.

## Recording from the radio or an external source connected to the AUX IN terminals

Operate in the order shown

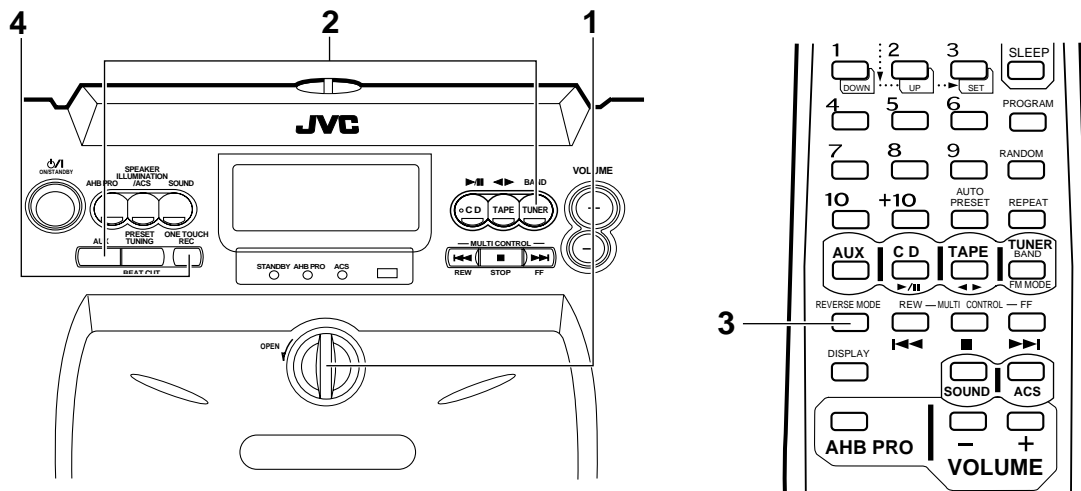

- 1 Load a cassette with side A facing out.  
(Wind past the tape leader before starting recording.)
  - Make sure the tape direction is set to ► (forward direction).
- 2 Select the source to be recorded.  
TUNER: Press the TUNER BAND/FM MODE button.  
Tune to the required station.  
AUX: Press the AUX button.
- 3 Select the desired reverse mode.
- 4 Press the ONE TOUCH REC button.
  - The recording starts from the beginning of side A.

### BEAT CUT button

When recording an AM broadcast, beats may be produced which are not heard when listening to the broadcast. In such case, set this button after setting the deck to the record mode so that the beats are eliminated. Normally set this button to "CUT-1".

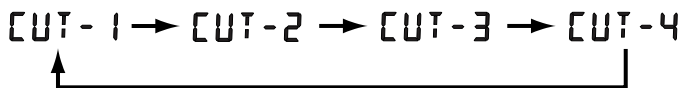
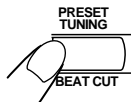

### Erasing

A recorded tape can be erased by recording new material over the previous material.

#### To erase a tape without making a new recording.....

1. Press the TAPE ◀▶ button to set to the TAPE mode.
2. Insert the cassette to be erased facing out.
3. Press the ONE TOUCH REC button.

It should be noted that it may be unlawful to re-record pre-recorded tapes, records, or discs without the consent of the owner of copyright in the sound or video recording, broadcast or cable program and in any literary, dramatic, musical, or artistic work embodied therein.

## CLOCK ADJUSTMENT (USING THE REMOTE CONTROL UNIT)

Names of parts in the clock/timer section, and their functions:

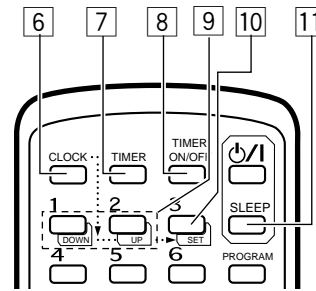
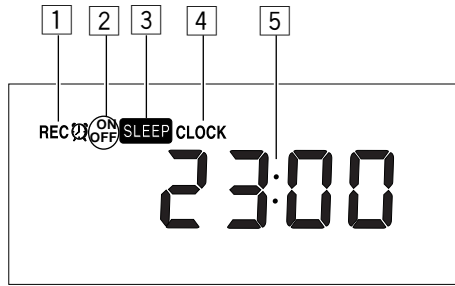

- 1 Timer mode indicator
- 2 Timer indicator (ON/OFF)
- 3 SLEEP indicator
- 4 CLOCK indicator
- 5 Time display

- 6 CLOCK button
- 7 TIMER button
- 8 TIMER ON/OFF button
- 9 DOWN/UP buttons
- 10 SET button
- 11 SLEEP button

### Setting the current time (when this unit is used for the first time)

(Example: To set the clock to 13:15.)

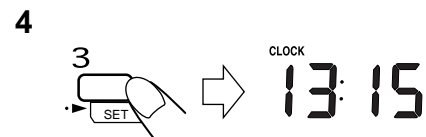
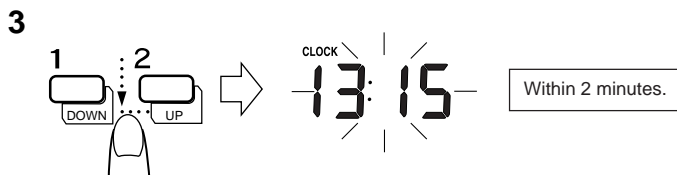

- 1 Set the button to ON.
  - 2 Press the CLOCK button; "0:00" will blink in the display.
  - 3 Set to 13:15 by pressing the DOWN/UP buttons.  
(When the button is kept pressed, the minute/hour indication changes continuously.)
  - 4 Press the SET button; the time will light in the display.
- To set to the nearest second...  
Press the SET button when you hear the time signal from a TV or radio.

- **To confirm the time while listening to a CD or radio broadcast**  
Press the DISPLAY button briefly on the remote control unit. Press it again to return to the previous display.

#### Notes:

- Before performing timer recording or playback, it is necessary to set the current time.
- If memory back-up batteries are exhausted or not installed, and the power cord is plugged in again after being disconnected, or power is restored after a power failure, "CLOCK" will blink in the display. Set the current time again.

## TIMER OPERATIONS (USING THE REMOTE CONTROL UNIT)

### Setting the timer

- The current time must be set before the timer can be used.

1 Set the  button to ON.

2 Press the TIMER button.



3 Set the start time.  
(Example: To set the timer to 12:15.)

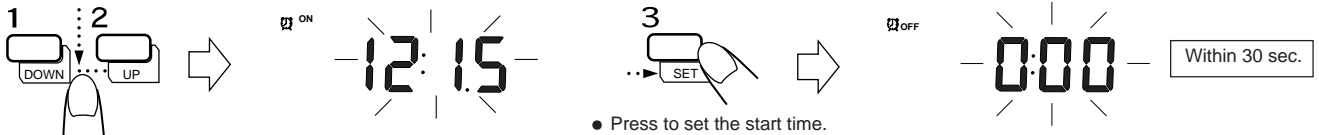

4 Set the stop time.  
(Example: To set the timer stop time to 13:15.)

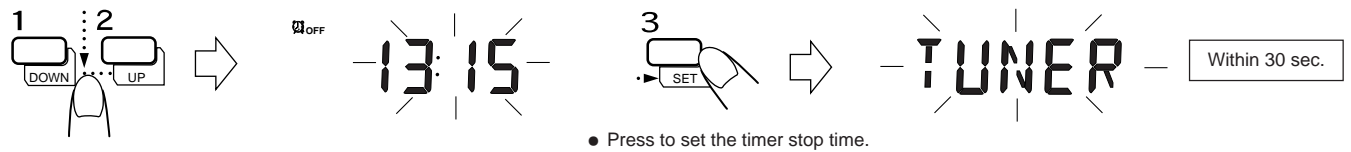

5 Select the TIMER mode.  
• The selected timer mode is shown in the display.

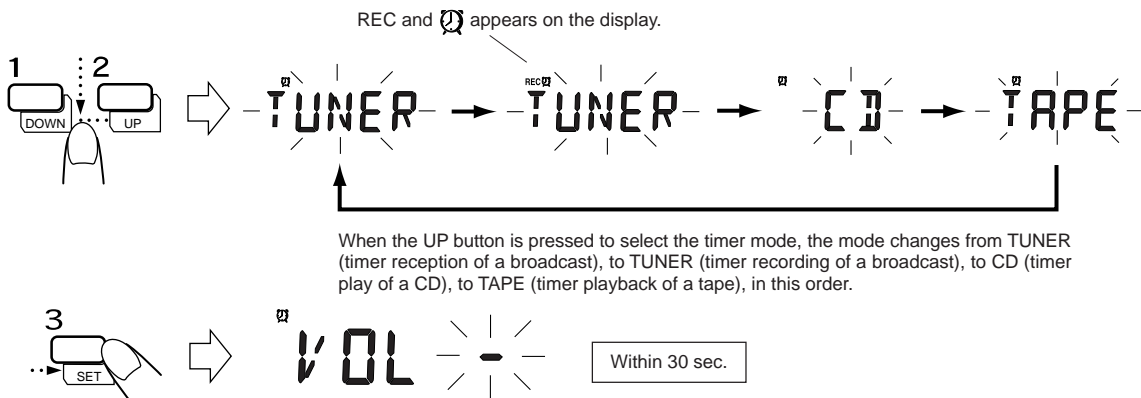

6 Set the volume.

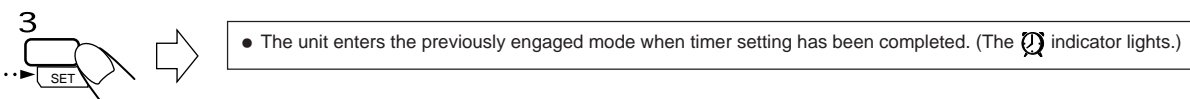
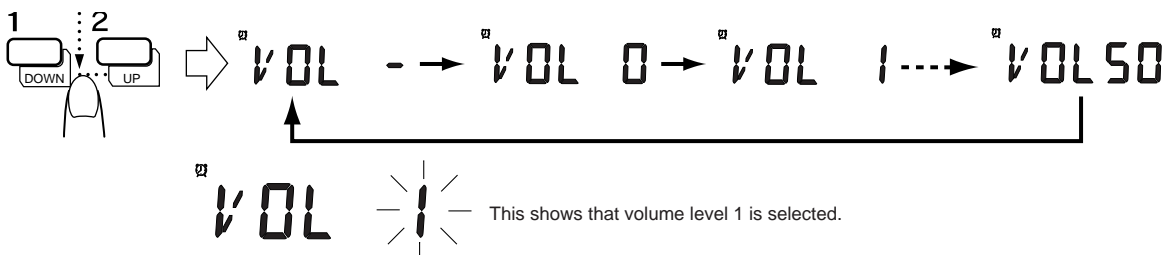

- When the volume setting is set to "VOL -" (volume level is not specified), the timer playback volume is at the level used before setting the timer.

#### • To confirm the timer setting

1. Press the SET button after pressing the TIMER button. Each time the SET button is pressed, the timer setting can be confirmed.
2. When the previously engaged mode is displayed, timer setting has been completed.

#### Note:

- When the timer is set incorrectly or the correct mode is not selected, perform "Setting the timer" from the beginning.

## Timer recording of broadcast

- The current time must be set before the timer can be used.
- Make sure that the safety tabs of the cassette have not been broken off.

## Operations

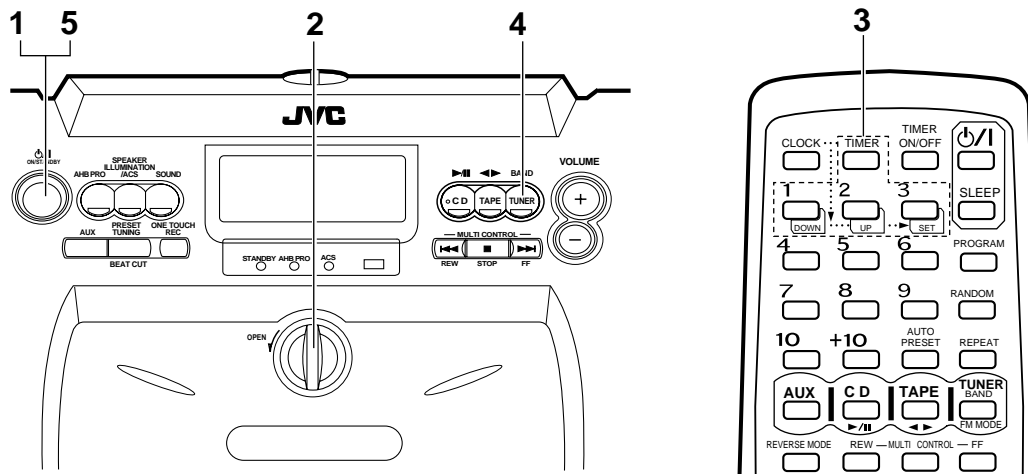

- 1 Set the button to ON.
  - 2 Load a cassette.
    - Insert the cassette with the side to be recorded facing out.
    - Select the required reverse mode ( or ).
    - Set the tape direction to (forward) by pressing the TAPE button.
  - 3 Set the timer. (Refer to "Setting the timer" on page 23.)
    - Set the timer about a minute before the broadcast to be recorded is scheduled to start.
  - 4 Tune to the station to be recorded. (Refer to page 18.)
  - 5 Set the button to standby.
    - Confirm that the timer mode indicator (REC ) is displayed in the display window.
- **Timer recording will start at timer start time and the power will be switched off at timer stop time.** (The timer mode is then released.)
  - **To repeat timer recording every day**  
Press the TIMER ON/OFF button to display the timer mode indicator (REC ) in the display window.

### • To cancel timer operation

Press the TIMER ON/OFF button so that the timer mode indicator (REC ) goes out.  
If you do this, timer recording will not start at the timer start time.

### Notes:

- Once the timer has been set, the start and stop times, etc., are stored in memory. When timer recording or playback is required at different times, the timer must be set again.
- After setting the timer start and stop times, check that the tuner is tuned to the required frequency.
  - If memory back-up batteries are exhausted or not installed, and the power cord is disconnected or there is a power failure, timer settings will be erased from memory. If this happens, set the current time and perform the timer setting again.



## Timer playback

- Timer playback of tapes, broadcasts and CDs is possible.

### Operations

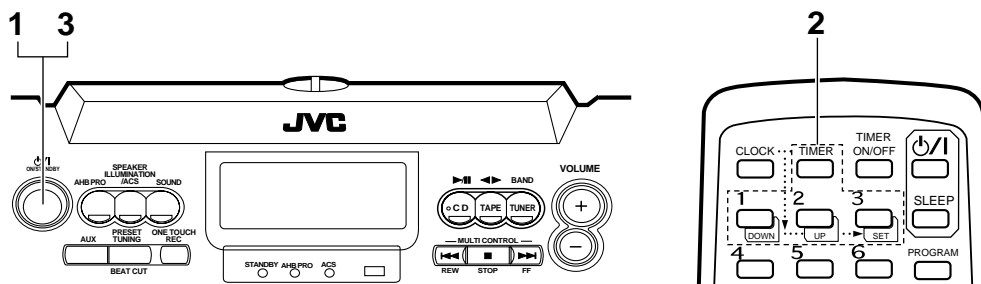

- 1 Set the  $\text{O/I}$  button to ON.
- 2 Set the timer. (Refer to "Setting the timer" on page 23.)

Source sound	Timer mode	Operations
CD play	CD	Load a disc.
Tape playback	TAPE	Load a cassette tape.
Broadcast	TUNER	Tune to the required station.

- 3 Set the  $\text{O/I}$  button to STANDBY.

- Timer playback will start at the timer start time and the power will be switched off at the timer stop time. The unit remains in the same timer mode even after the power is switched off. The same timer mode will repeat at the same time on the following day.
- When the timer mode is activated, the "Ⓚ" indicator blinks.
- When the power is switched on, the sound is faded up from volume level 0 (zero) to the preset volume.

#### • To cancel timer operation

Press the TIMER ON/OFF button so that the timer mode indicator (Ⓚ) goes out.

#### Notes:

- When the volume setting is set to "VOL -" (volume level is not specified), the timer playback volume is at the level used before setting the timer. (In this case, the fade-in mode does not function.)
- To stop during timer playback, press the  $\text{O/I}$  button to switch the unit off.

## Sleep timer operations (using the remote control unit)

### A. Use this when you want to fall asleep while listening to a tape, broadcast or CD.

- 1 Set to the required source and tune in a broadcast or play back a CD or tape.
- 2 Press the SLEEP button to set the sleep time.

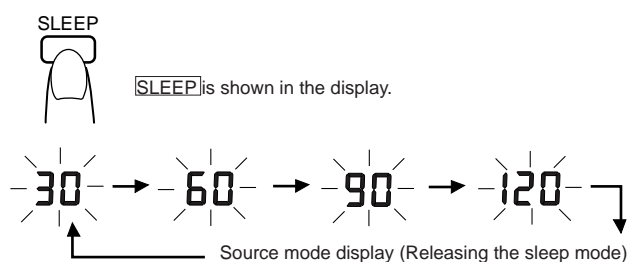

- Sleep time settings of 30, 60, 90 or 120 minutes can be set. When you release the SLEEP button, the source is displayed after 5 sec.

- The sleep timer operation will start and the power will be switched off after the specified time.
- **Checking the sleep time**  
When the SLEEP button is pressed, the remaining sleep time is displayed. If it is pressed again, a new sleep time can be set.
- **To cancel the sleep timer operation**  
Press the  $\text{O/I}$  button to switch the power off or press the SLEEP button until the sleep time indicator disappears.

### B. To fall asleep while listening to a tape, broadcast or CD and to perform timer playback the following morning

- 1 Set the timer. (Refer to "Setting the timer" on page 23.)
- 2 Set to the required source (tape, broadcast or CD).
- 3 Press the SLEEP button to set the sleep time.

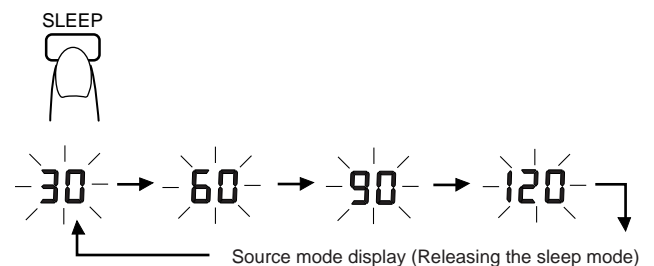

- Any source can be selected for sleep timer operation and timer playback. For example;
  - CD play for sleep timer operation and broadcast reception for timer playback.
  - Tuner play for sleep timer operation and CD play for timer playback.

However, when broadcast reception is selected for both sleep timer operation and timer playback, the station you heard at night will be tuned to the following morning.

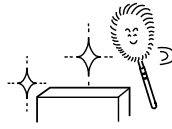

**Cleaning is important!**

When the tape is running, magnetic powder and dust naturally accumulate on the heads, capstan and pinch roller. When they become too dirty...

- Sound quality deteriorates.
- The output sound level drops.
- Previously recorded tape is not completely erased.
- Recording is not performed satisfactorily.

Therefore, you should clean the heads, etc. after every 10 hours of use for optimal recording conditions.

**Cleaning the heads, capstan and pinch roller**

Open the cassette holder.

Clean the heads, pinch roller and capstan.

For effective cleaning, use a cleaning kit available from an audio store. After cleaning, be sure that the cleaning fluid has dried completely before loading a cassette.

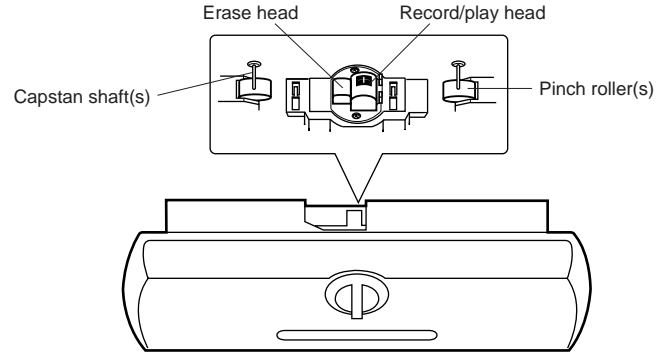

**Cautions:**

1. Keep magnets and metallic objects away from the head.  
If the head becomes magnetized, noise will increase and the sound will deteriorate. Demagnetize the head every 20-30 hours of use with a head eraser (available from an audio store). (When demagnetizing the head, the button should be set to STANDBY.)
2. Do not use anything other than alcohol for cleaning.  
Thinner and benzine will damage the rubber pinch roller.

**Cleaning the lens**

If the lens in the CD pickup is dirty, dropout, etc., could degrade sound. Open the CD door and clean the lens as shown.

- Use a blower (available from a camera store) to blow dust off the lens.
- If there are fingerprints, etc. on the lens, gently wipe clean with a cotton swab.

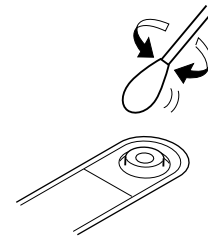
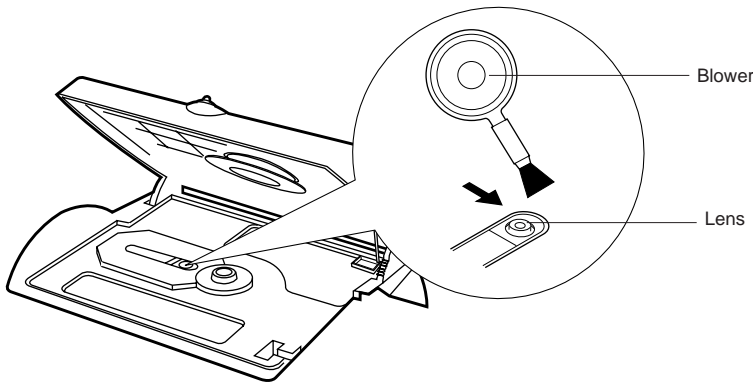



**What appears to be trouble is not always serious. First make sure....**

- **Power cannot be turned on.**
  - \* Is the power cord unplugged?
- **No sound from the speakers.**
  - \* Are headphones connected?
- **Clock time is blinking in the display.**
  - \* Was there a power failure?
  - \* Was the power cord unplugged while the memory back-up batteries were not installed?

(CD Player Section)

- **The CD player does not play.**
  - \* Is the CD upside down?
  - \* Is the CD dirty?
  - \* Is there condensation on the lens? (See "Cleaning the lens" on page 26.)
- **A certain portion of the CD does not play correctly.**
  - \* Is the CD scratched?
  - \* Is there condensation on the lens?
- **Operation stops.**
  - \* Switch to STANDBY and then to ON again.

(Cassette Deck Section)

- **Playback sound is at a very low level.**
  - \* Is the head dirty?
- **The ONE TOUCH REC button does not function.**
  - \* Have the safety tabs of the cassette been broken off?

(Tuner Section)

- **Reception is noisy.**
  - \* Try adjusting the antenna.
  - \* Is there a TV set or computer device near the unit?

(Timer Section)

- **Timer operation does not start.**
  - \* Is the current time set correctly?
  - \* Is the timer mode indicator (⌚) displayed?

(Remote Control)

- **Remote control is impossible.**
  - \* Are the batteries in the remote control exhausted?
  - \* Is the remote sensor section exposed to bright light (direct sunlight, etc.)?

**Notes:**

- **When the above remedies do not help**  
Many operations of this unit are performed by the control of a microprocessor. If none of the buttons function, unplug the power cord and remove all the batteries, wait for a while, then load the batteries again and plug it back in. Reset the correct values for the clock and timer.
- Before making an important recording, be sure to make a test recording first to check that the deck, etc. is working correctly.

SPECIFICATIONS

**CD player section**

- Type : Compact disc player
- Signal detection system : Non-contact optical pickup
- Number of channels : 2 channels
- Frequency response : 20 Hz - 20,000 Hz
- Signal-to-noise ratio : 90 dB
- Wow & flutter : Less than measurable limit

**Radio section**

- Frequency range : FM 87.5 - 108 MHz  
AM: (MW) 522 - 1,629 kHz  
(LW) 144-288 kHz
- Antennas : Telescopic antenna for FM  
Ferrite core antenna for AM (MW/LW)

**Tape deck section**

- Track system : 4-track 2-channel stereo
- Motor : Electronic governor DC motor for capstan
- Heads : Hard permalloy head for recording/playback, 2 gap ferrite head for erasure (Combination head)
- Frequency response : 60 - 14,000 Hz  
(with CrO<sub>2</sub> tape)
- Wow & flutter : 0.15% (WRMS)
- Fast wind time : Approx. 150 sec (C-60 cassette)

**General**

- Speakers (Impedance) : Full range: 10 cm x 2 (4 Ω)
- Power output : (Max.)  
26 W (13 W +13 W) at 4 Ω  
(10% THD)  
20 W (10 W + 10 W) at 4 Ω
- Input terminals : AUX IN (300 mV/47 kΩ)
- Output terminals : PHONES (Output level: 0 - 12 mW/ch, 32 Ω, Matching impedance: 16 Ω - 1 kΩ)
- Power requirements : AC 230 V, 50 Hz  
DC 12 V ("R20/D (13F)" batteries x 8)  
Ext. DC 12 V (car battery via optional CA-R120E car adapter)
- Power consumption : 27 W (with ⏻/I SW ON)  
3.0 W (with ⏻/I SW STANDBY)
- Dimensions : 541 (W) x 215 (H) x 259 (D) mm, including knobs
- Mass : 6.3 kg (without batteries)  
7.2 kg (with batteries)
- Accessories provided : AC power cord x 1  
Remote control unit (RM-RXVB55E) x 1  
R6/AA (15F) batteries x 2  
Shoulder strap x 1

Design and specifications are subject to change without notice.



## Free Manuals Download Website

<http://myh66.com>

<http://usermanuals.us>

<http://www.somanuals.com>

<http://www.4manuals.cc>

<http://www.manual-lib.com>

<http://www.404manual.com>

<http://www.luxmanual.com>

<http://aubethermostatmanual.com>

Golf course search by state

<http://golfingnear.com>

Email search by domain

<http://emailbydomain.com>

Auto manuals search

<http://auto.somanuals.com>

TV manuals search

<http://tv.somanuals.com>