

# JVC



## MICRO COMPONENT SYSTEM

**UX-J60** — Consists of CA-UXJ60 and SP-UXJ60

**UX-J50** — Consists of CA-UXJ50 and SP-UXJ50

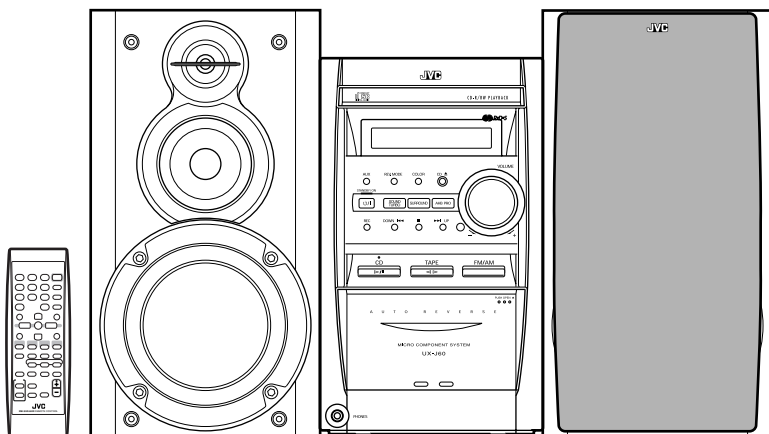

SP-UXJ60

CA-UXJ60

SP-UXJ60

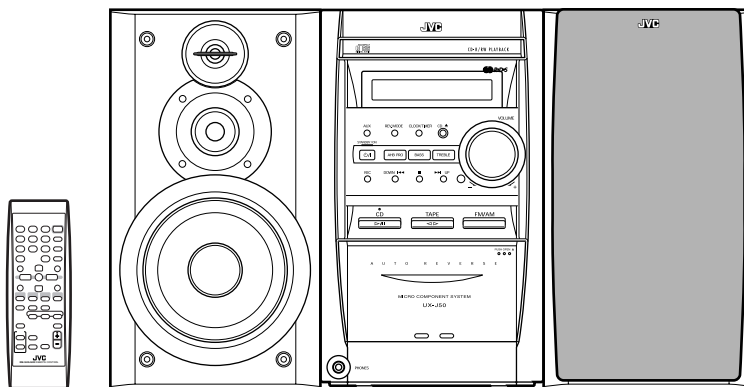

SP-UXJ50

CA-UXJ50

SP-UXJ50

COMPACT  
**disc**  
DIGITAL AUDIO

**CO R-D-S**

## INSTRUCTIONS

**For Customer Use:**

Enter below the Model No. and Serial No. which are located either on the rear, bottom or side of the cabinet. Retain this information for future reference.

Model No. \_\_\_\_\_

Serial No. \_\_\_\_\_

GVT0102-008A

[B]

# Warnings, Cautions and Others

## IMPORTANT for the U.K.

**DO NOT** cut off the mains plug from this equipment. If the plug fitted is not suitable for the power points in your home or the cable is too short to reach a power point, then obtain an appropriate safety approved extension lead or consult your dealer.

**BE SURE** to replace the fuse only with an identical approved type, as originally fitted.

If nonetheless the mains plug is cut off ensure to remove the fuse and dispose of the plug immediately, to avoid a possible shock hazard by inadvertent connection to the mains supply.

If this product is not supplied fitted with a mains plug then follow the instructions given below:

## IMPORTANT:

**DO NOT** make any connection to the terminal which is marked with the letter E or by the safety earth symbol or coloured green or green-and-yellow.

The wires in the mains lead on this product are coloured in accordance with the following code:

Blue : Neutral  
Brown : Live

As these colours may not correspond with the coloured markings identifying the terminals in your plug proceed as follows:

The wire which is coloured blue must be connected to the terminal which is marked with the letter N or coloured black.

The wire which is coloured brown must be connected to the terminal which is marked with the letter L or coloured red.

**IF IN DOUBT—CONSULT A COMPETENT ELECTRICIAN.**

## CAUTION—STANDBY/ON $\odot$ /I button!

Disconnect the mains plug to shut the power off completely (the STANDBY/ON lamp goes off). The STANDBY/ON  $\odot$ /I button in any position does not disconnect the mains line.

- When the unit is on standby, the STANDBY/ON lamp lights red.
- When the unit is turned on, the STANDBY/ON lamp lights green.

The power can be remote controlled.

## IMPORTANT FOR LASER PRODUCTS

### REPRODUCTION OF LABELS

- ① CLASSIFICATION LABEL ON EXTERIOR SURFACE

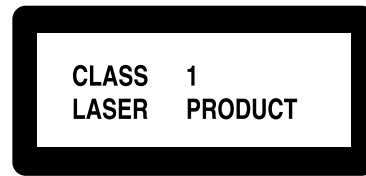

- ② WARNING LABEL INSIDE THE UNIT

**CAUTION:** Invisible laser radiation when open and interlock failed or defeated. AVOID DIRECT EXPOSURE TO BEAM. (e)

**ADVARSEL:** Usynlig laserstråling ved åbning, når sikkerhedsafbrydere er ude af funktion. Undgå udsættelse for stråling. (d)

**WARNING:** Osynlig laserstråling når denna del är öppnad och spårren är urkopplad. Beträkta ej strålen. (s)

**VARO:** Avattaessa ja suojalukitus ohitettaessa olet alttiina näkymättömälle lasersäteilylle. Älä katso säteeseen. (f)

1. CLASS 1 LASER PRODUCT
2. **CAUTION:** Invisible laser radiation when open and interlock failed or defeated. Avoid direct exposure to beam.
3. **CAUTION:** Do not open the top cover. There are no user serviceable parts inside the unit; leave all servicing to qualified service personnel.

## CAUTION

To reduce the risk of electrical shocks, fire, etc.:

1. Do not remove screws, covers or cabinet.
2. Do not expose this appliance to rain or moisture.

## CAUTION

- Do not block the ventilation openings or holes. (If the ventilation openings or holes are blocked by a newspaper or cloth, etc., the heat may not be able to get out.)
- Do not place any naked flame sources, such as lighted candles, on the apparatus.
- When discarding batteries, environmental problems must be considered and local rules or laws governing the disposal of these batteries must be followed strictly.
- Do not expose this apparatus to rain, moisture, dripping or splashing and that no objects filled with liquids, such as vases, shall be placed on the apparatus.

## CAUTION: Proper Ventilation

To avoid risk of electric shock and fire, and to prevent damage, locate the apparatus as follows:

- 1 Front: No obstructions and open spacing.
- 2 Sides/ Top/ Back: No obstructions should be placed in the areas shown by the dimensions below.
- 3 Bottom: Place on a level surface. Maintain an adequate air path for ventilation by placing on a stand with a height of 10 cm or more.

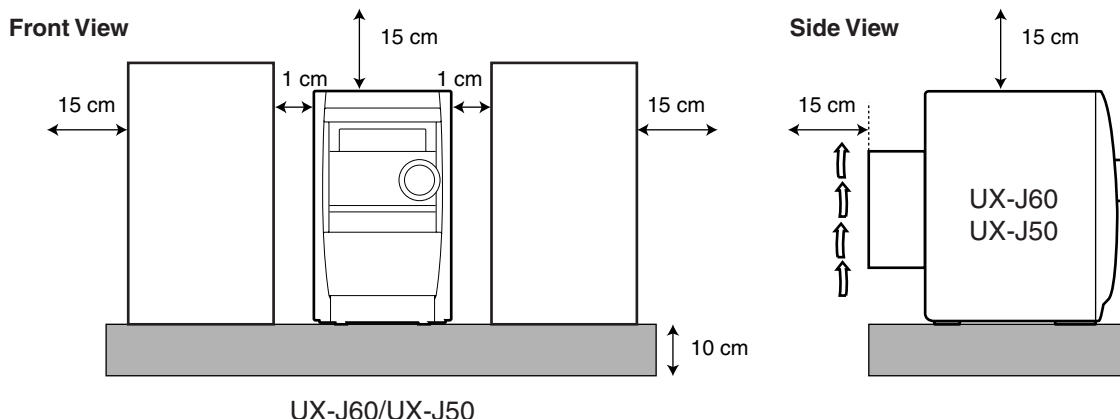

# SAFETY INSTRUCTIONS

## “SOME DOS AND DON'TS ON THE SAFE USE OF EQUIPMENT”

This equipment has been designed and manufactured to meet international safety standards, but like any electrical equipment, care must be taken if you are to obtain the best results and safety is to be assured.

\*\*\*\*\*

Do read the operating instructions before you attempt to use the equipment.

Do ensure that all electrical connections (including the mains plug, extension leads and interconnections between pieces of equipment) are properly made and in accordance with the manufacturer's instructions. Switch off and withdraw the mains plug when making or changing connections.

Do consult your dealer if you are ever in doubt about the installation, operation or safety of your equipment.

Do be careful with glass panels or doors on equipment.

\*\*\*\*\*

DON'T continue to operate the equipment if you are in any doubt about it working normally, or if it is damaged in any way—switch off, withdraw the mains plug and consult your dealer.

DON'T remove any fixed cover as this may expose dangerous voltages.

DON'T leave equipment switched on when it is unattended unless it is specifically stated that it is designed for unattended operation or has a standby mode.

Switch off using the switch on the equipment and make sure that your family know how to do this.

Special arrangements may need to be made for infirm or handicapped people.

DON'T use equipment such as personal stereos or radios so that you are distracted from the requirements of traffic safety. It is illegal to watch television whilst driving.

DON'T listen to headphones at high volume as such use can permanently damage your hearing.

DON'T obstruct the ventilation of the equipment, for example with curtains or soft furnishings.

Overheating will cause damage and shorten the life of the equipment.

DON'T use makeshift stands and NEVER fix legs with wood screws—to ensure complete safety always fit the manufacturer's approved stand or legs with the fixings provided according to the instructions.

DON'T allow electrical equipment to be exposed to rain or moisture.

### ABOVE ALL

- NEVER let anyone, especially children, push anything into holes, slots or any other opening in the case—this could result in a fatal electrical shock.
- NEVER guess or take chances with electrical equipment of any kind—it is better to be safe than sorry!

# Introduction

---

We would like to thank you for purchasing one of our JVC products. Before operating this unit, read this manual carefully and thoroughly to obtain the best possible performance from your unit, and retain this manual for future reference.

## About This Manual

---

This manual is organized as follows:

- **The manual mainly explains operations using the buttons on the remote control.**  
You can use the buttons both on the remote control and on the main unit for the same operations if they have the same or similar names (or marks), unless mentioned otherwise.  
**The illustrations used in this manual are of UX-J60 unless mentioned otherwise.**
- Basic and common information that is the same for many functions is grouped in one place, and is not repeated for each procedure. For instance, we do not repeat the information about turning on/off the unit, setting the volume, changing the sound effects, and others, which are explained in the section “Common Operations” on pages 9 to 11.
- The following symbols are used in this manual:



Gives you warning and caution to prevent damage or risk of fire/electric shock. Furthermore, it gives you information about what is not good for obtaining the best possible performance from the unit.



Gives you information and hints you should know.

## Precautions

---

### Installation

- Install in a place which is level, dry and neither too hot nor too cold—between 5°C and 35°C.
- Install the unit in a location with adequate ventilation to prevent internal heat buildup in the unit.
- Leave sufficient distance between the unit and the TV.
- Keep the speakers away from the TV to avoid interference with TV.



DO NOT install the unit in a location near heat sources, or in a place subject to direct sunlight, excessive dust or vibration.

### Power sources

- When unplugging the unit from the wall outlet, always pull on the plug, not the AC power cord.



DO NOT handle the AC power cord with wet hands.

### Moisture condensation

Moisture may condense on the lens inside the unit in the following cases:

- After starting heating in the room
  - In a damp room
  - If the unit is brought directly from a cold to a warm place
- Should condensation occur, the unit may malfunction. In this case, leave the unit turned on for a few hours until the moisture evaporates, unplug the AC power cord, then plug it in again.

### Others

- Should any metallic object or liquid fall into the unit, unplug the power cord and consult your dealer before operating any further.
- If you are not going to operate the unit for an extended period of time, unplug the AC power cord from the wall outlet.



DO NOT disassemble the unit since there are no user serviceable parts inside.

If anything goes wrong, unplug the AC power cord and consult your dealer.

# Contents

---

<b>Location of the Buttons and Control .....</b>	<b>3</b>
Front Panel .....	3
Remote Control .....	5
<b>Getting Started .....</b>	<b>6</b>
Supplied Accessories .....	6
Putting the Batteries into the Remote Control .....	6
Connecting Antennas .....	6
Connecting Speakers .....	7
Connecting Other Equipment .....	8
<b>Common Operations .....</b>	<b>9</b>
Setting the Clock .....	9
Turning On the Power .....	9
Adjusting the Volume .....	10
Enjoying Sound Effects .....	10
Selecting the Illumination Brightness .....	11
Selecting the Display Color (ONLY FOR UX-J60) .....	11
<b>Listening to FM and AM (MW) Broadcasts .....</b>	<b>12</b>
Tuning in to a Station .....	12
Presetting Stations .....	12
Tuning in to a Preset Station .....	13
Receiving FM Stations with RDS .....	13
Changing the RDS Information .....	14
Searching for Programs by PTY Codes (PTY Search) .....	14
Switching Temporarily to a Program Type of Your Choice .....	15
<b>Playing Back Discs .....</b>	<b>16</b>
Playing Back the Entire Disc—Normal Play .....	16
Basic Disc Operations .....	17
Programming the Playing Order of the Tracks —Program Play .....	17
Playing at Random—Random Play .....	18
Repeating Tracks—Repeat Play .....	18
Prohibiting Disc Ejection—Tray Lock .....	18
<b>Playing Back Tapes .....</b>	<b>19</b>
Playing Back a Tape .....	19
<b>Recording .....</b>	<b>20</b>
Recording on a Tape .....	20
Disc Direct Recording .....	21
One Track Recording .....	21
<b>Using the Timers .....</b>	<b>22</b>
Using Daily Timer and Recording Timer .....	22
Using Sleep Timer .....	23
<b>Maintenance .....</b>	<b>24</b>
<b>Troubleshooting .....</b>	<b>24</b>
<b>Additional Information .....</b>	<b>25</b>
<b>Specifications .....</b>	<b>26</b>

# Location of the Buttons and Control

Become familiar with the buttons and control on your unit.



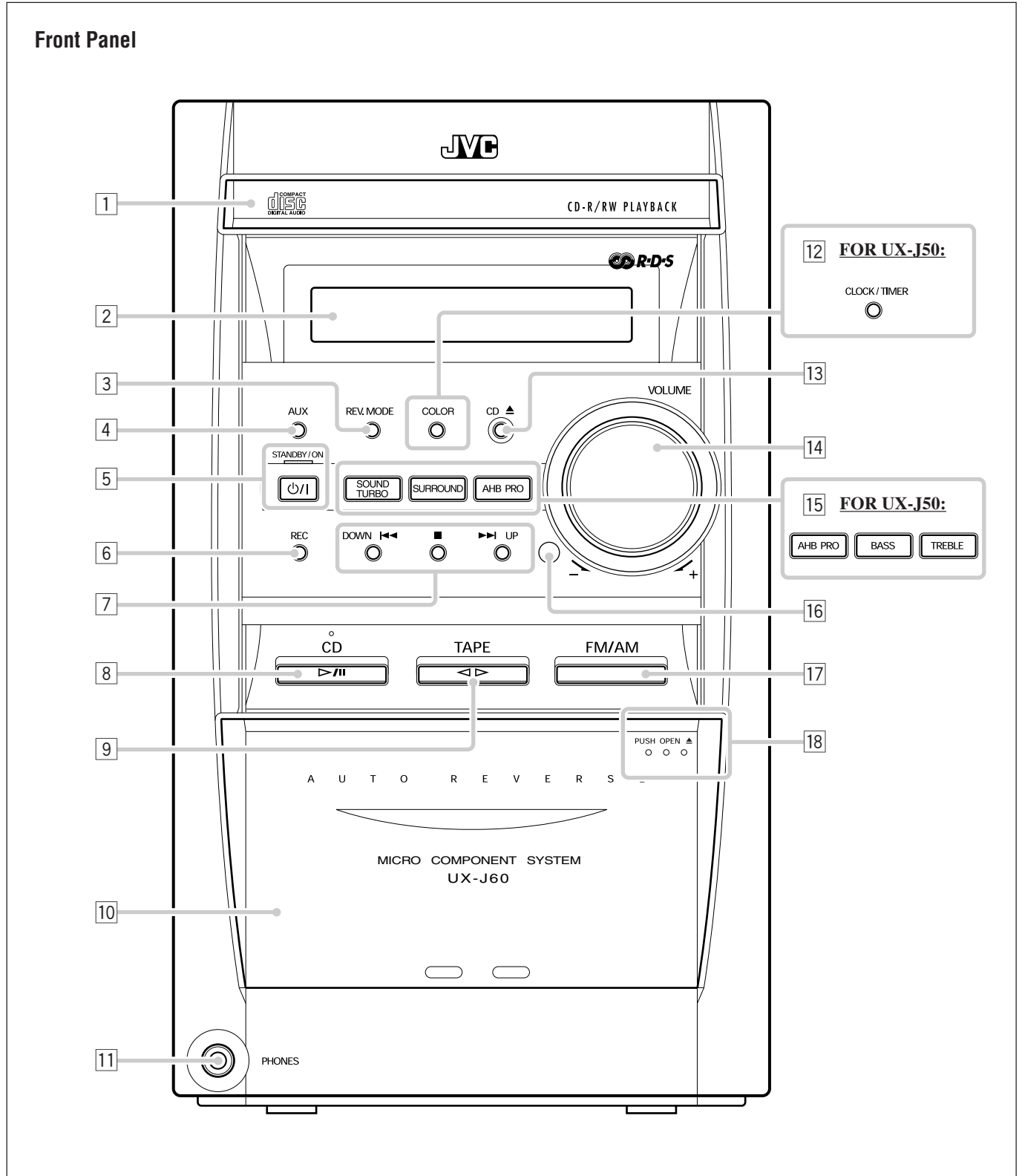

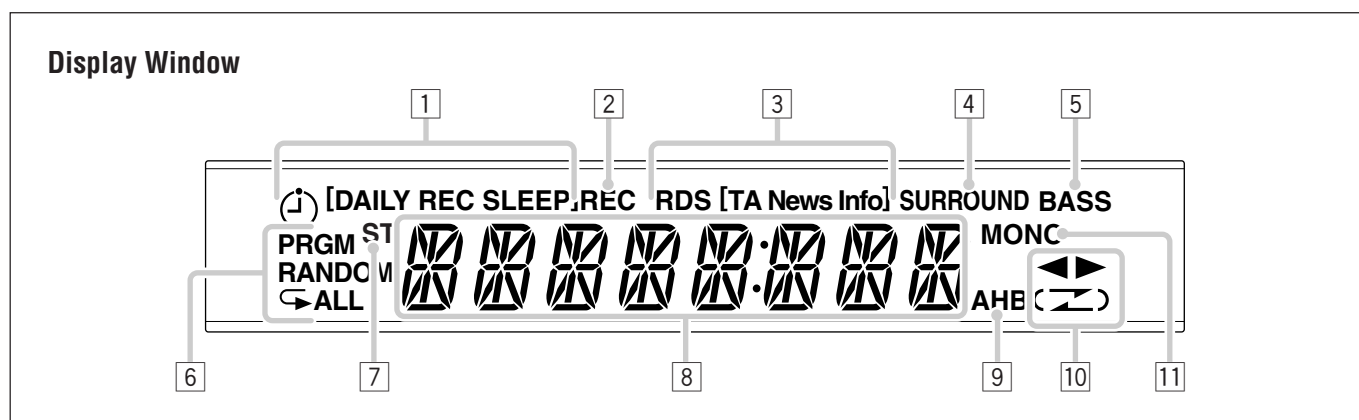



## Front Panel









See the pages in parentheses for details.

### Front Panel

- 1 Disc tray
- 2 Display window
- 3 REV.MODE (reverse mode) button (19 – 21)
- 4 AUX button (9)  
*Pressing this button also turns on the unit.*
- 5 STANDBY/ON  button and STANDBY/ON lamp (9, 23)
- 6 REC (recording) button (20, 21)
- 7 Multi operation buttons
  - DOWN/ (reverse skip),  (stop)
  - and /UP
- 8 CD  (play/pause) button (9, 16 – 18)  
*Pressing this button also turns on the unit.*
- 9 TAPE   button (9, 19)  
*Pressing this button also turns on the unit.*
- 10 Cassette holder
- 11 PHONES jack (10)
- 12 FOR UX-J60:  
COLOR button (11)
- FOR UX-J50:  
CLOCK/TIMER button (9, 22, 23)
- 13 CD  (disc tray open/close) button (16)  
*Pressing this button also turns on the unit.*
- 14 VOLUME + / - control (10)
- 15 FOR UX-J60:  
SOUND TURBO button (11)  
SURROUND button (11)  
AHB (Active Hyper Bass) PRO button (10)
- FOR UX-J50:  
AHB (Active Hyper Bass) PRO button (10)  
BASS button (10)  
TREBLE button (10)
- 16 Remote sensor
- 17 FM/AM button (9, 12, 13)  
*Pressing this button also turns on the unit.*
- 18 PUSH OPEN  (cassette holder open) portion (19 – 21)

### Display Window

- 1 Timer indicators
  -  (timer), DAILY, REC (recording timer), and SLEEP
- 2 REC (recording) indicator
- 3 RDS operation indicators
  - RDS and TA/News/Info
- 4 ONLY FOR UX-J60:  
SURROUND indicator
- 5 ONLY FOR UX-J60:  
BASS indicator
- 6 Disc play mode indicators
  - PRGM (program), RANDOM, and  ALL (repeat)
- 7 ST (stereo) indicator
- 8 Main display
  - Shows the source name, frequency, etc.
- 9 AHB (Active Hyper Bass pro) indicator
- 10 Tape operation indicators
  -   (tape direction) and  (reverse mode)
- 11 MONO indicator

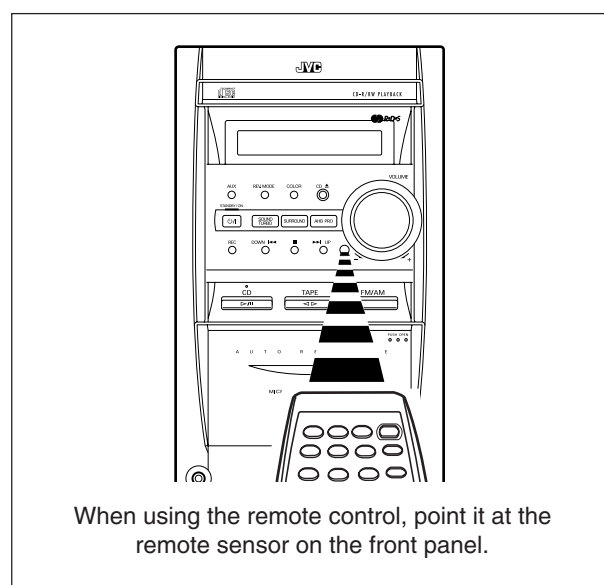

## Remote Control

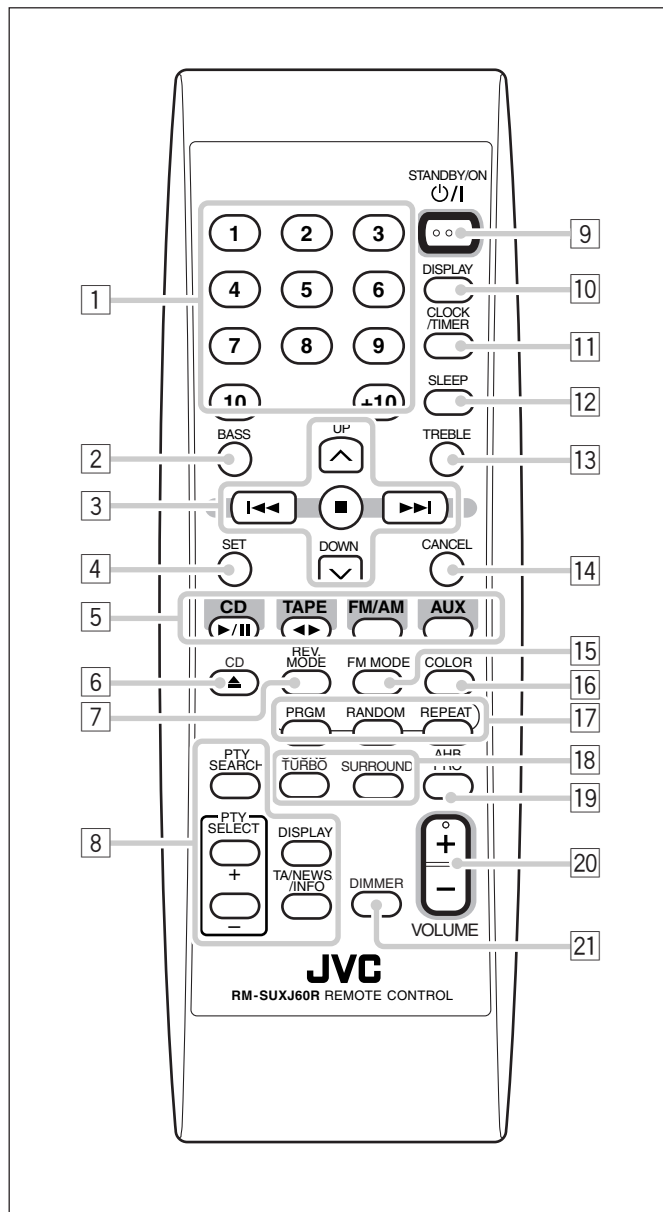

See the pages in parentheses for details.

- 1 Number buttons
- 2 BASS button (10)
- 3 Multi operation buttons
  - UP, **◀◀** (reverse skip), **■** (stop), **▶▶** (forward skip), and DOWN
- 4 SET button (17)
- 5 Source buttons
  - CD **▶/||**, TAPE **◀▶**, FM/AM, and AUX
  - Pressing one of these buttons also turns on the unit.*
- 6 CD **▲** (disc tray open/close) button (16)
  - Pressing this button also turns on the unit.*
- 7 REV.MODE (reverse mode) button (19 – 21)
- 8 RDS operation buttons (14, 15)
  - PTY SEARCH, PTY SELECT + / -, DISPLAY, and TA/NEWS/INFO
- 9 STANDBY/ON **⏻/⏻** button (9, 23)
- 10 DISPLAY button (9)
- 11 CLOCK/TIMER button (9, 22, 23)
- 12 SLEEP button (23)
- 13 TREBLE button (10)
- 14 CANCEL button (18)
- 15 FM MODE button (12)
- 16 ONLY FOR UX-J60: COLOR button (11)
- 17 Disc play mode buttons (17, 18)
  - PRGM (program), RANDOM, and REPEAT
- 18 ONLY FOR UX-J60: SOUND TURBO button (11) and SURROUND button (11)
- 19 AHB (Active Hyper Bass) PRO button (10)
- 20 VOLUME + / - button (10)
- 21 DIMMER button (11)



## Supplied Accessories

Make sure that you have all the following items. The number in parentheses indicates the quantity of each piece supplied.

- AM loop antenna (1)
- FM antenna (1)
- Remote control (1)
- Batteries (2)
- Speaker cords (ONLY FOR UX-J60) (4)

If anything is missing, consult your dealer immediately.

## Putting the Batteries into the Remote Control

Insert the batteries—R6(SUM-3)/AA(15F)—into the remote control, by matching the polarity (+ and –) on the batteries with the + and – markings on the battery compartment.

When the remote control can no longer operate the unit, replace both batteries at the same time.

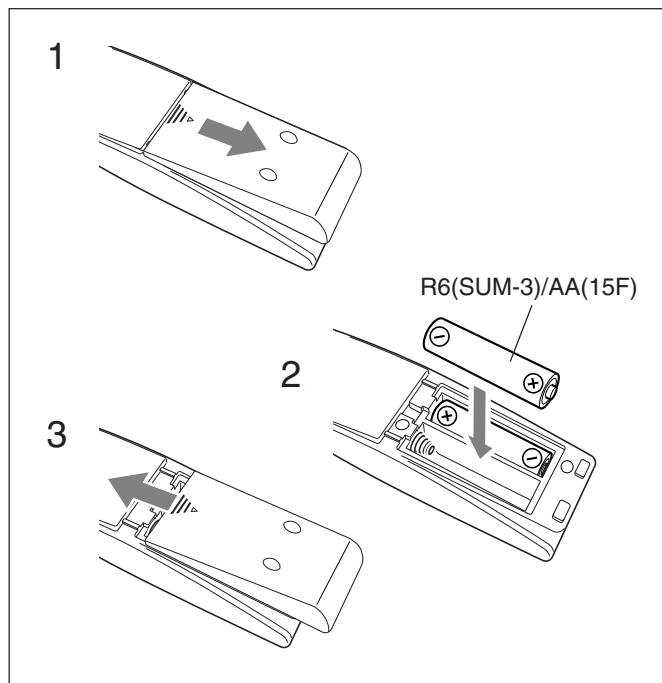

- DO NOT use an old battery together with a new one.
- DO NOT use different types of batteries together.
- DO NOT expose batteries to heat or flame.
- DO NOT leave the batteries in the battery compartment when you are not going to use the remote control for an extended period of time. Otherwise, the remote control will be damaged from battery leakage.

## Connecting Antennas

### FM antenna

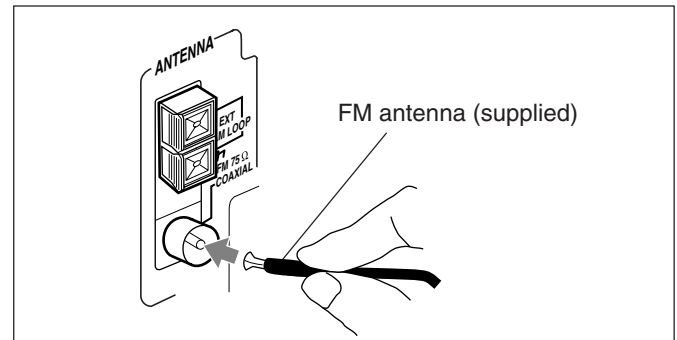

- 1 Attach the FM antenna to the FM 75 Ω COAXIAL terminal.
- 2 Extend the FM antenna.
- 3 Fasten it up in the position which gives you the best reception, then fix it on the wall, etc.



#### About the supplied FM antenna

The FM antenna supplied with this unit can be used as temporary measure. If reception is poor, you can connect an outdoor FM antenna.

#### To connect an outdoor FM antenna

Before connecting the antenna, disconnect the supplied FM antenna.

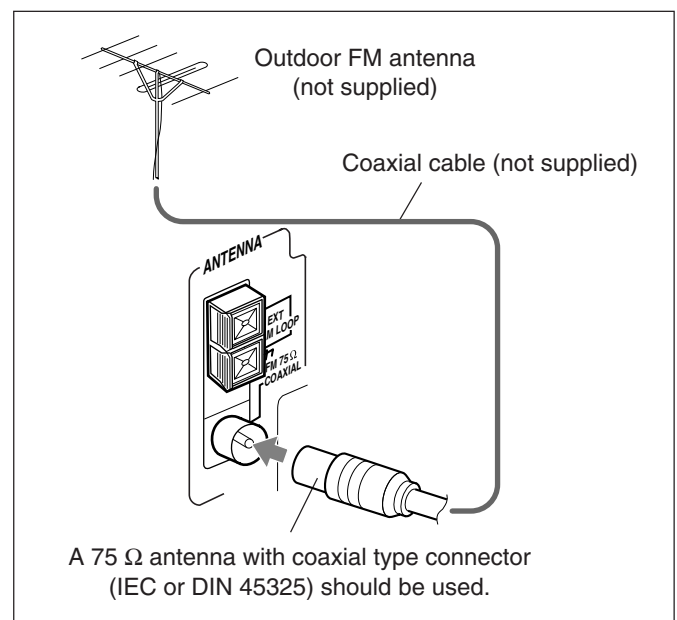

## AM (MW) antenna

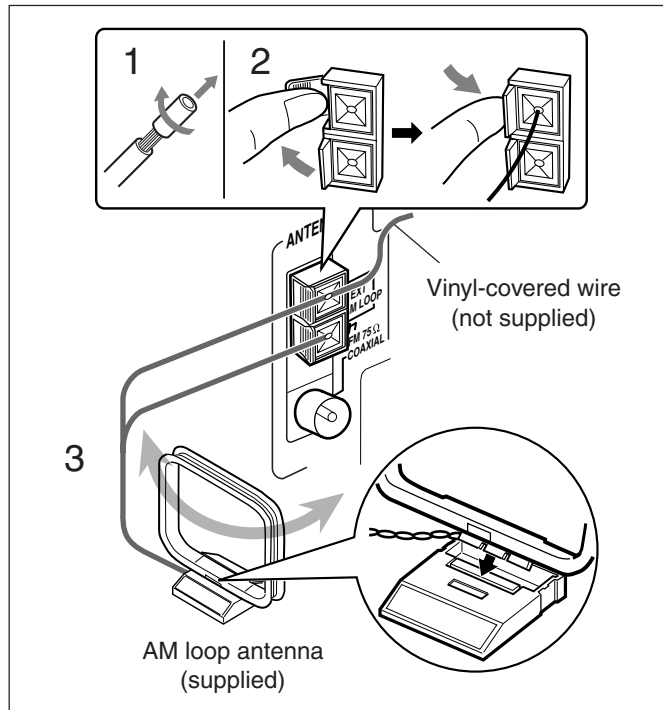

- 1 If the cords are covered with insulation, remove a short section of insulation at the end of each cord by twisting and pulling it off.
- 2 Connect the AM loop antenna to the AM LOOP terminals as illustrated.
- 3 Turn the AM loop antenna until you have the best reception.

### To connect an outdoor AM (MW) antenna

When reception is poor, connect a single vinyl-covered wire to the AM EXT terminal and extend it horizontally. The AM LOOP antenna must remain connected.



#### For better reception of both FM and AM (MW)

- Make sure the antenna conductors do not touch any other terminals and connecting cords.
- Keep the antennas away from metallic parts of the unit, connecting cords, and the AC power cord.

## Connecting Speakers

### FOR UX-J60:

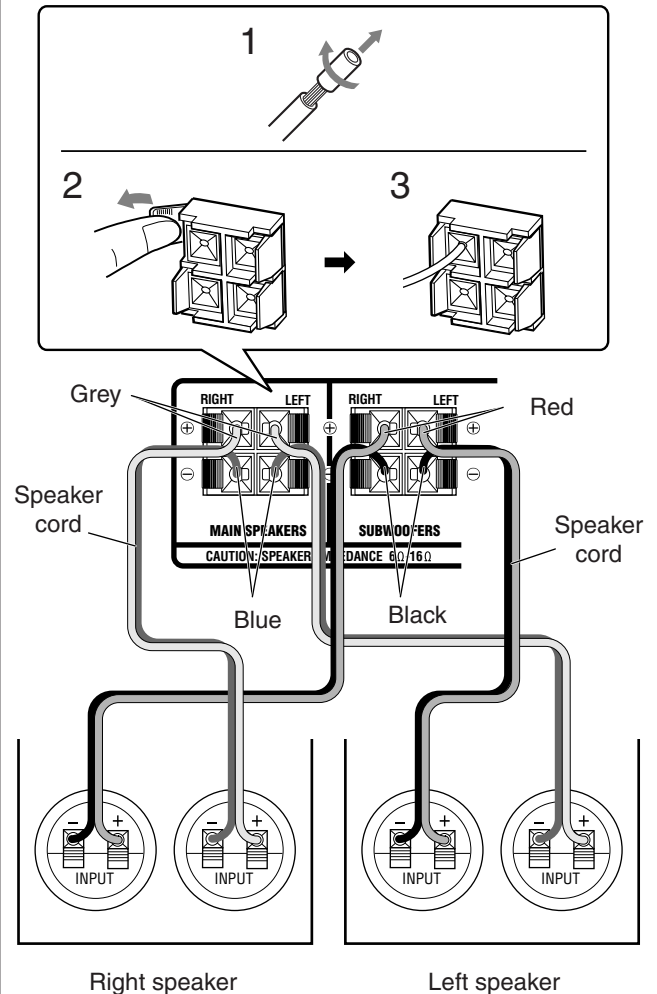

### FOR UX-J50:

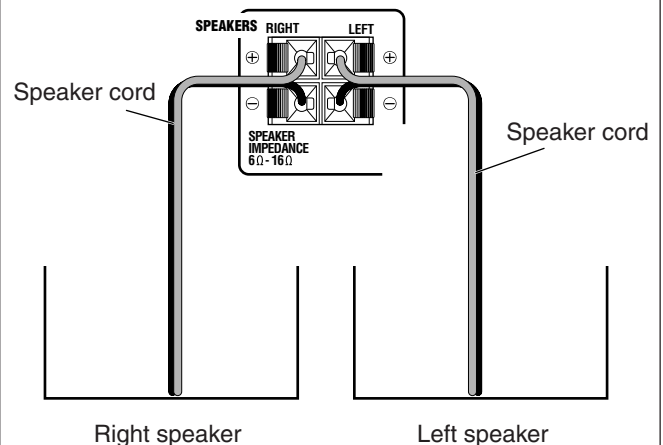

- 1 **If the cords are covered with insulation, remove a short section of insulation at the end of each cord by twisting and pulling it off.**
- 2 **Press and hold the clamp of the speaker terminal as illustrated.**
- 3 **Insert the end of the speaker cord into the terminal.**  
Match the polarity between the unit and the speaker terminals:  $\oplus$  to  $\oplus$  and  $\ominus$  to  $\ominus$ .
- 4 **Release your finger from the clamp.**



- DO NOT connect speakers while the power is on.
- DO NOT connect more than one speaker to each speaker terminal.

**IMPORTANT:** Use only speakers with the same speaker impedance as shown on the speaker terminals on the rear of the unit.

### To remove the speaker grilles

The speaker grilles are removable.

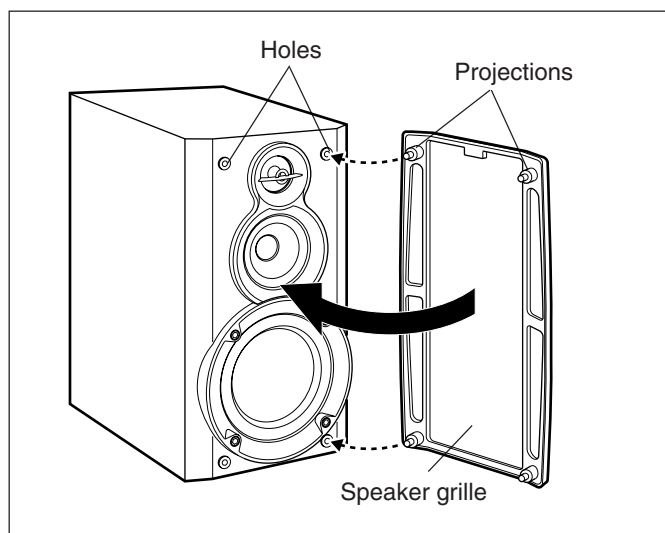

**To remove the speaker grille,** insert your fingers at the top of the speaker grille, pull towards you. Then pull the bottom towards you.

**To attach the speaker grille,** put the projections of the speaker grille into the holes of the speaker.

## Connecting Other Equipment

### To connect an audio equipment

You can connect audio equipment—used only as a playback device.



- DO NOT connect any equipment while the power is on.
- DO NOT plug in any equipment until all connections are complete.

Be sure that the plugs of the audio cords are colored: White plugs and jacks are for left audio signals, and red ones for right audio signals.

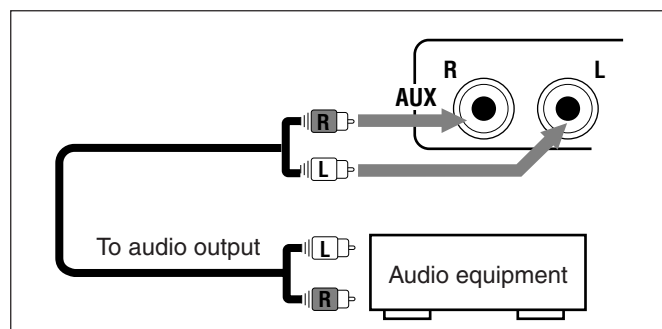

**For playing other equipment through this unit,** connect between the audio output jacks on the other equipment and AUX jacks by using audio cords (not supplied).

**Now, you are ready to plug in the unit and any other connected equipment.**

**IMPORTANT:** Be sure to check all connections to be done before plugging the AC power cord into a wall outlet.

# Common Operations

## Setting the Clock

Before operating the unit any further, first set the unit's clock. When you plug the AC power cord into the wall outlet, "0:00" starts flashing on the display.

You can set the clock whether the unit is on or off.

- There is a time limit in doing the following steps. If the setting is canceled before you finish, start over from step 1.
- For UX-J60 only, you can also use CLOCK/TIMER on the unit for this operation.

### 1 Press CLOCK/TIMER.

The hour digits start flashing on the display.



### 2 Press UP or DOWN to adjust the hour, then press CLOCK/TIMER.

The minute digits start flashing.

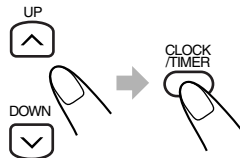

### 3 Press UP or DOWN to adjust the minute, then press CLOCK/TIMER.

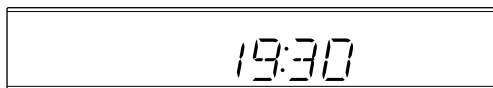

## To check the clock time during play

### On the remote control ONLY:

Press DISPLAY (grey-colored).

- Each time you press the button, the source indication and the clock time alternate on the display.

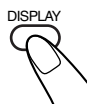

- **When you unplug the AC power cord or if a power failure occurs**  
The clock is reset to "0:00" right away. If this happens, set the clock again.
- **The clock may gain or lose 1 to 2 minutes per month**  
If this happens, reset the clock.

## To change the clock



- 1 **Make sure the ☉ (timer) indicator is not lit on the display.**
  - If it is lit, press and hold CLOCK/TIMER until it goes off.
- 2 **Press CLOCK/TIMER repeatedly until the unit enters the clock setting mode (the hour digits start flashing on the display).**  
First time you press CLOCK/TIMER, the unit enters the timer setting mode. (See page 22.)
- 3 **Repeat steps 2 and 3 of the procedure of "Setting the Clock."**
- 4 **Press and hold CLOCK/TIMER again so that the ☉ (timer) indicator goes off.**

## Turning On the Power

To turn on the unit, press STANDBY/ON .

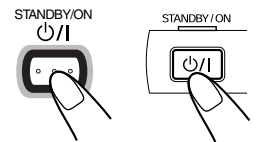
The STANDBY/ON lamp lights green and "HELLO" appears on the display.



- When you press the source button—CD , TAPE , FM/AM, and AUX, the unit automatically turns on and starts playback if the source is ready.

To turn off the unit (standby), press STANDBY/ON  again.

The STANDBY/ON lamp lights red and "GOOD BYE" appears on the display.

- "0:00" flashes on the display until you set the built-in clock. After setting the clock, the clock time will appear on the display while the unit is on standby.

The illumination and display brighten only for 4 seconds by pressing DIMMER.

- A little power is always consumed even while the unit is on standby.

To switch off the power supply completely, unplug the AC power cord from the AC outlet.



**When you unplug the AC power cord or if a power failure occurs**

The clock is reset to "0:00" right away, while the tuner preset stations (see page 12) will be erased in a few days.

## Adjusting the Volume

You can adjust the volume level only while the unit is turned on. The volume level can be adjusted between “VOL MIN” and “VOLUME 1” – “VOLUME 40 (VOL MAX).”

### On the remote control:

Press VOLUME + to increase the volume or press VOLUME – to decrease it.



### On the unit:

Turn VOLUME + / – control clockwise (+) to increase the volume or counterclockwise (–) to decrease it.

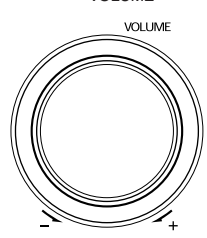

### For private listening

Connect headphones to the PHONES jack. No sound comes out of the speakers. Be sure to turn down the volume before connecting or putting on headphones.



DO NOT turn the unit off (standby) with the volume set to an extremely high level; otherwise, the sudden blast of sound can damage your hearing, speakers and/or headphones when you turn on the unit or start playing any source next time. REMEMBER you cannot adjust the volume level while the unit is on standby.

## To reinforce the bass sound

You can reinforce the bass sound to maintain rich, full bass at low volume—Active Hyper Bass Pro.

### For UX-J60:

#### Press AHB PRO.

- Each time you press the button, the Active Hyper Bass Pro is turned on (AHB ON) and off (AHB OFF) alternately. When it is turned on, the AHB indicator lights up on the display.

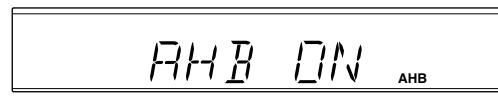

### For UX-J50:

#### Press AHB PRO until “AHB 1” or “AHB 2” appears on the display.

The AHB indicator also lights up on the display.

- Each time you press the button, the bass reinforcement changes as follows:

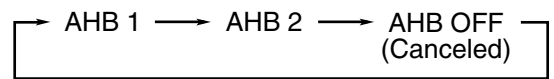

- “AHB 2” has much more bass reinforcement effect than “AHB 1.”

**To cancel the effect,** press AHB PRO until “AHB OFF” appears on the display and the AHB indicator goes off.

## Enjoying Sound Effects

You can adjust the sound by using various sound effect functions.

- These functions only affect the playback sound, and do not affect your recording.

### To adjust the tone (Bass/Treble)

You can adjust the bass level (low frequency range) and the treble level (high frequency range) within a range of –5 to +5. When shipped, the bass level set to “BASS +2” and the treble level set to “TREBLE +2.”

- There is a time limit in doing the following steps. If the setting is canceled before you finish, start over from step 1.
- For UX-J50 only, you can also use BASS and TREBLE on the unit for this operation.

#### 1 Press BASS to adjust the bass level or press TREBLE to adjust the treble level.

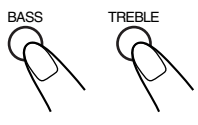

- Each time you press the button, “BASS” and “TREBLE” appears in the display alternately.

#### 2 Press UP to increase the level or press DOWN to decrease it.

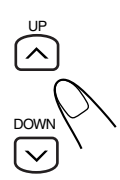

### To enjoy the heavy sound (ONLY FOR UX-J60)

You can enjoy the heavy sound. The function boosts low and high frequency sounds—Sound Turbo.

#### Press SOUND TURBO.

- Each time you press the button, the Sound Turbo is turned on and off alternately. When it is turned on, the BASS indicator lights up on the display.



When the Sound Turbo is on, the bass and the treble levels are set to +2 (see page 10). After the Sound Turbo is canceled, these levels restored to the previous levels.

### To reinforce the surround effect (ONLY FOR UX-J60)

You can reinforce the surround effect.

- This function does not affect your recording and playback sound of monaural sources.

**To get the effect**, press SURROUND so that the SURROUND indicator lights up on the display.



**To cancel the effect**, press SURROUND again so that the SURROUND indicator goes off.

### Selecting the Display Color (ONLY FOR UX-J60)

You can select the display color (COLOR 1 – COLOR 5 and AUTO mode).

- AUTO mode changes the color (COLOR 1 to COLOR 5) gradually.

**To select the color**, press COLOR.

- Each time you press the button, the color changes as follows:

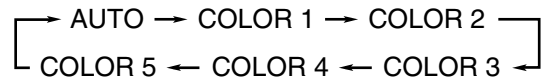
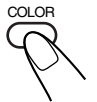

### Selecting the Illumination Brightness

You can change the illumination and display brightness only while the unit is turned on.

#### On the remote control ONLY:

**To change the brightness**, press DIMMER.

- Each time you press the button, the illumination and display dim (DIM ON) and brighten (DIM OFF) alternately.



## Tuning in to a Station

### 1 Press FM/AM to select the band.

The unit automatically turns on and tunes in to the previously received station—either FM or AM (MW).

- Each time you press the button, the band alternates between FM and AM (MW).

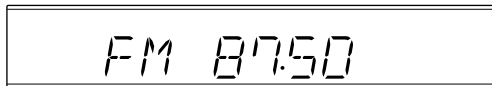

### 2 Press and hold or for more than 1 second.

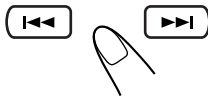

The unit starts searching for stations and stops when a station of sufficient signal strength is tuned in.

- If a program is broadcast in stereo, the ST (stereo) indicator lights up.



To stop searching, press  or .



When you press  or  briefly and repeatedly the frequency changes step by step.

## To change the FM reception mode

### On the remote control ONLY:

When an FM stereo broadcast is hard to receive or noisy, press FM MODE so that the MONO indicator lights up on the display. Reception will improve.



To restore the stereo effect, press FM MODE again so that the MONO indicator goes off. In stereo mode, you can hear stereo sound when a stereo program is broadcast.

## Presetting Stations

You can preset 30 FM and 15 AM (MW) stations.

In some cases, test frequencies have been already memorized for the tuner since the factory examined the tuner preset function before shipment. This is not a malfunction.

You need to preset stations separately for the FM and AM (MW) bands.

- There is a time limit in doing the following steps. If the setting is canceled before you finish, start over from step 2.

### On the remote control ONLY:

### 1 Tune in to the station you want to preset.

- See “Tuning in to a Station.”

### 2 Press SET.

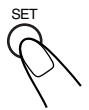

### 3 Press UP or DOWN to select a preset number.

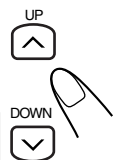

### 4 Press SET again.



The tuned station in step 1 is stored in the preset number selected in step 3.

- Storing a new station on a used number erases the previously stored one.



When you unplug the AC power cord or if a power failure occurs

The tuner preset stations will be erased in a few days. If this happens, preset the stations again.



---

## Tuning in to a Preset Station

---

### On the remote control ONLY:

#### 1 Press FM/AM to select the band.

The unit automatically turns on and tunes in to the previously received station—either FM or AM (MW).

- Each time you press the button, the band alternates between FM and AM (MW).

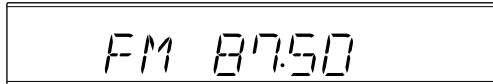
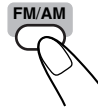

#### 2 Press UP or DOWN to select a preset number.

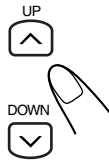

### To tune in to a preset station directly using the number buttons

#### On the remote control ONLY:

Pressing the number button(s) allows you to select the preset number you want.

- Ex.: For preset number 5, press 5.  
For preset number 15, press +10, then 5.  
For preset number 20, press +10, then 10.  
For preset number 30, press +10, +10, then 10.

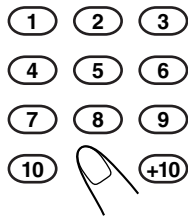

---

## Receiving FM Stations with RDS

---

RDS (Radio Data System) allows FM stations to send an additional signal along with their regular program signals. For example, the stations send their station names, as well as information about what type of program they broadcast, such as sports or music, etc.

When tuned in to an FM station which provides the RDS service, the RDS indicator lights up on the display. With the unit, you can receive the following types of RDS signals.

#### PS (Program Service):

Shows commonly known station names.

#### PTY (Program Type):

Shows types of broadcast programs.

#### RT (Radio Text):

Shows text messages the station sends.

#### Enhanced Other Networks:

Provides information about the types of the programs sent by other RDS stations.



#### More about RDS

- Some FM stations do not provide RDS signals.
- RDS services vary among FM RDS stations. For details on RDS services in your area, check with local radio stations.
- RDS may not work correctly if the received station is not transmitting the signals properly or if the signal strength is weak.



## Changing the RDS Information

You can see RDS information on the display while listening to an FM station.

### On the remote control ONLY:

#### Press DISPLAY (orange-colored).

- Each time you press the button, the display changes to show the following information:

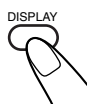
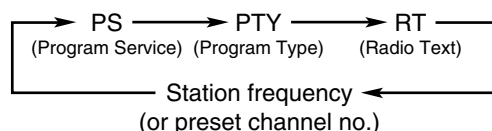

- If no PS, PTY, or RT signals are sent by a station “NO PS,” “NO PTY,” or “NO RT” appears on the display.

#### On the characters displayed

When the display shows PS, PTY or RT signals:

- The display shows upper case letters only.
- The display cannot show accented letters; for example, “A” may represent accented “A’s” like “Á, Â, Ã, Ä, Å and Å.”

## Searching for Programs by PTY Codes (PTY Search)

One of the advantages of RDS is that you can locate a particular kind of program by specifying the PTY codes.

- For details on the PTY codes, see “Additional Information” on page 25.

### To search for a program using the PTY codes

REMEMBER you must preset FM RDS stations to use the PTY codes. If not yet done, see page 12.

- There is a time limit in doing the following steps. If the setting is canceled before you finish, start over from step 1.

### On the remote control ONLY:

#### 1 Press PTY SEARCH.

“PTY” and “SELECT” appear on the display alternately.



#### 2 Press PTY SELECT + or PTY SELECT – until the PTY code you want appears on the display.

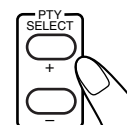

- Each time you press the buttons, the PTY codes change as follows:

NONE ↔ NEWS ↔ AFFAIRS ↔ INFO ↔  
 SPORT ↔ EDUCATE ↔ DRAMA ↔  
 CULTURE ↔ SCIENCE ↔ VARIED ↔  
 POP M ↔ ROCK M ↔ EASY M ↔  
 LIGHT M ↔ CLASSICS ↔ OTHER M ↔  
 WEATHER ↔ FINANCE ↔ CHILDREN ↔  
 SOCIAL ↔ RELIGION ↔ PHONE IN ↔  
 TRAVEL ↔ LEISURE ↔ JAZZ ↔  
 COUNTRY ↔ NATION M ↔ OLDIES ↔  
 FOLK M ↔ DOCUMENT ↔ TEST ↔  
 ALARM ↔ (back to the beginning)

#### 3 Press PTY SEARCH once again.

While searching, “SEARCH” and the selected PTY code alternately appear on the display.

The unit searches 30 preset FM stations, stops when it finds the one you have selected (“FOUND” and the selected PTY code appear), and tunes in that station.

- If no program is found, “NOTFOUND” appears on the display and the unit returns to the last received station.

To stop searching any time during the process, press PTY SEARCH while searching.



If you preset a station while PTY Search is being carried out

PTY Search may not stop. If this happens, press PTY SEARCH to stop searching manually.

## Switching Temporarily to a Program Type of Your Choice

The Enhanced Other Networks function allows the unit to switch temporarily to a broadcast program of your choice (TA, NEWS, and INFO) from a different station.

- The function only works when you are listening to a preset FM RDS stations providing the data.

### To activate the Enhanced Other Networks function

**REMEMBER** you must preset FM RDS stations to use the function. If not yet done, see page 12.

- There is a time limit in doing the following steps. If the setting is canceled before you finish, start over from step 1.

### On the remote control ONLY:

- 1 Press TA/NEWS/INFO until the data type you want appears on the display.



- Each time you press the button, the data type indication changes as follows:

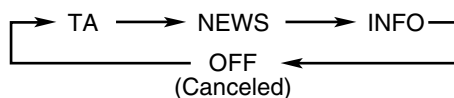

The selected data type indicator (TA, News, and Info) also flashes.

**TA:** Traffic announcement

**NEWS:** News

**INFO:** Program the purpose of which is to impart advice in the widest sense.

**OFF:** The function is canceled. The data type indicator (TA, News, and Info) goes off.

- 2 Wait for about 3 seconds after specifying the data type.

The data type indicator stops flashing and remains lit. Now, the function is activated. See “How the Enhanced Other Networks function actually works.”

## How the Enhanced Other Networks function actually works:

### CASE 1

#### If there is no station broadcasting the program you have selected

The unit continues tuning in to the current station.



When a station starts broadcasting the program you have selected, the unit automatically switches to the station. The indicator of received PTY code starts flashing.



When the program is over, the unit goes back to the previously tuned station, but the function still remains activated.

### CASE 2

#### If there is a station broadcasting the program you have selected

The unit tunes in to the program. The indicator of received PTY code starts flashing.



When the program is over, the unit goes back to the previously tuned station, but the function still remains activated.

### CASE 3

#### If the FM station you are listening to is broadcasting the program you have selected

The unit continues to receive the station but the indicator of received PTY code starts flashing.



When the program is over, the indicator of received PTY code stops flashing and remains lit, but the function still remains activated.



### More about the Enhanced Other Networks function

- The data sent from some stations may not be compatible with this unit and also some stations may not include Enhanced Other Networks data. In this case, the function may not work correctly.
- While listening to a program tuned into by the function, the station does not change even if another network station starts broadcasting a program of the same data.
- The function is canceled when you change the source to CD, TAPE or AUX, while it is temporarily canceled when you change the source to AM (MW).
- This function is also canceled when you turn off the unit.

# Playing Back Discs

Continued 

This unit has been designed to play back the following discs—CD, CD-R, and CD-RW.

## When playing a CD-R or CD-RW

User-edited CD-Rs (CD-Recordable) and CD-RWs (CD-ReWritable) can be played only if they are already “finalized.”

- Usually you can play back your original CD-Rs or CD-RWs recorded in music CD format. However, sometimes they may not play depending on their characteristics or recording conditions.
- Before playing CD-Rs or CD-RWs, read their instructions or cautions carefully.
- Some CD-Rs or CD-RWs may not play on this unit because of their disc characteristics, damage or stain on them, or if the player’s lens is dirty.
- CD-RWs may require a longer readout time. This is because the reflectance of CD-RWs is lower than for regular discs.

## General notes

In general, you will have the best performance by keeping your discs and the mechanism clean.

- Store discs in their cases, and keep them in cabinets or on shelves.
- Keep the unit’s disc tray closed when not in use.

Continued use of irregular shape discs (heart-shape, octagonal, etc.) can damage the unit.

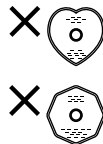

## Handling discs

- Remove the disc from its case by holding it at the edge while pressing the center hole lightly.
- Do not touch the shiny surface of the disc, or bend the disc.
- Put the disc back in its case after use to prevent warping.
- Be careful not to scratch the surface of the disc when placing it back in its case.
- Avoid exposure to direct sunlight, temperature extremes, and moisture.

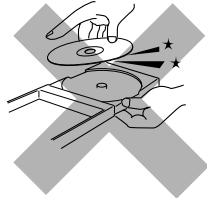

## To clean the disc

Wipe the disc with a soft cloth in a straight line from center to edge.



DO NOT use any solvent—such as conventional record cleaner, spray, thinner, or benzine—to clean the disc.

## Playing Back the Entire Disc—Normal Play

### 1 Press CD .

The unit automatically turns on and the disc tray comes out.



### 2 Place a disc correctly on the circle of the disc tray, with its label side up.

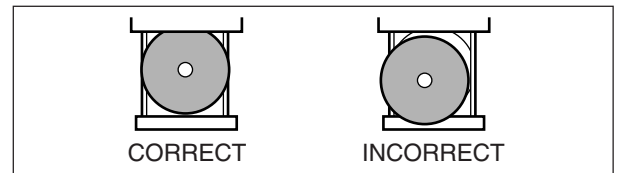

- When using a CD single (8 cm), place it on the inner circle of the disc tray.

### 3 Press CD .

The disc tray automatically closes and the first track of the disc starts playing.

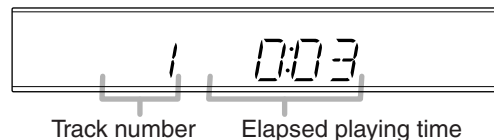

- The disc automatically stops when the last track has finished playing.

To stop playing, press .

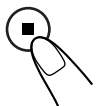
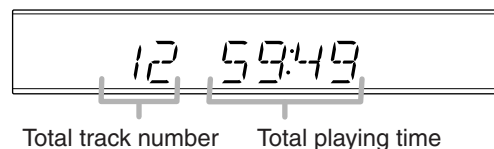

To remove the disc, press CD .



- If the disc cannot be read correctly (because it is scratched, for example) or an unreadable CD-R or CD-RW is inserted Playback will not start.
- If no disc is inserted “NO DISC” appears on the display.
- If the loaded disc has more than 21 tracks and you select 21st track or above “--:--” appears on the display instead of the playing time.



DO NOT try to open or close the disc tray by hand as it will be damaged.

## Basic Disc Operations

While playing a disc, you can do the following operations.

### To stop playing for a moment

During play, press CD ►/||.

While pausing, the elapsed playing time flashes on the display.



To resume playing, press CD ►/|| again.

### To go to another track

Before or during play, press ►►| or |◀◀ repeatedly.

- ►►|: Skips to the beginning of the next or succeeding tracks.
- |◀◀: Goes back to the beginning of the current or previous tracks.

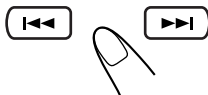

### To go to another track directly using the number buttons

**On the remote control ONLY:**

Pressing the number button(s) before or during play allows you to start playing the track number you want.

Ex.: For track number 5, press 5.

For track number 15, press +10, then 5.

For track number 20, press +10, then 10.

For track number 32, press +10, +10, +10, then 2.

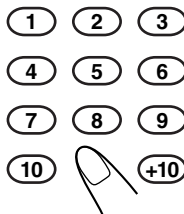

### To locate a particular point in a track

During play, press and hold ►►| or |◀◀.

- ►►|: Fast-forwards the tracks.
- |◀◀: Fast-reverses the tracks.



## Programming the Playing Order of the Tracks —Program Play

You can arrange the order in which tracks play before you start playing. **You can program up to 20 tracks.**

**On the remote control ONLY:**

### 1 Load a disc.

- If the current playing source is not the CD player, press CD ►/||, then ■ before going to the next step.

### 2 Press PRGM (program).

The PRGM (program) indicator lights up on the display.

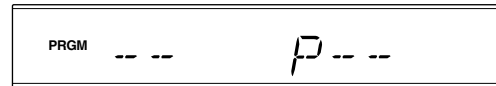
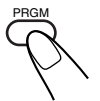

- If a program has been stored in memory, the program is called up.

### 3 Press UP or DOWN to select the track number, then press SET.

- You can select the track number directly using the number button(s). (See “To go to another track directly using the number buttons.”)

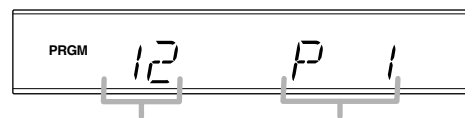
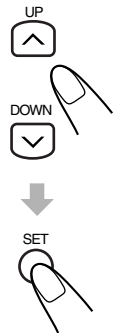

Track number      Program step number

### 4 Repeat step 3 to program other tracks you want.

### 5 Press CD ►/||.

The tracks are played in the order you have programmed.



**If you try to program a 21st track** “FULL” will appear on the display.

To stop playing, press ■.

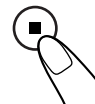

To exit from Program Play, press PRGM (program) before or after playing.

- The PRGM (program) indicator goes off.
- The Program remains even when you select another play mode (Normal or Random Play).

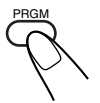

**Play mode setting (Normal, Program, and Random Play) will not change even if you do the following operations;**

- Changing the source—selecting the CD player as the source restores the previous play mode.
- Turning off the unit—turning on the unit restores the previous play mode.

### To check the program contents

You can check the program contents by pressing ►►| or |◀◀ before or after playback.



- ►►|: To check the contents in the programmed order.
- |◀◀: To check the contents in the reverse order.

## To modify the program

### On the remote control ONLY:

Before or after playing, you can erase the last programmed track by pressing CANCEL.

- Each time you press the button, the last programmed track is erased from the program.

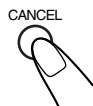

To add tracks in the program before playing, simply select the track numbers you want to add by following step 3 of the programming procedure.

To erase the program, press ■ before or after playing.

- Disc ejection also erases the program.

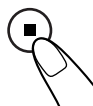

## Playing at Random—Random Play

The tracks will play in no particular order when you use this mode.

### On the remote control ONLY:

#### 1 Load a disc.

- If the current playing source is not the CD player, press CD ►/||, then ■ before going to the next step.

#### 2 Press RANDOM.

The RANDOM indicator lights up on the display.



#### 3 Press CD ►/||.

The tracks are randomly played. Random Play ends when all the tracks are played once.



To skip the current track, press ►►.

- You cannot go back to the previous track by pressing ◀◀.



To stop playing, press ■.

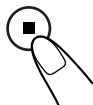

To exit from Random Play, press RANDOM before or after playing.

Random Play is canceled and Normal Play resumes.

- The RANDOM indicator goes off.

 **Play mode setting (Normal, Program, and Random Play) will not change even if you do the following operations;**

- Changing the source—selecting the CD player as the source restores the previous play mode.
- Turning off the unit—turning on the unit restores the previous play mode.

## Repeating Tracks—Repeat Play

You can have all the tracks, the program or individual track currently playing, repeat as many times as you like.

### On the remote control ONLY:

To repeat playing, press REPEAT before or during play.

- Each time you press the button, Repeat Play changes as follows, and the following repeat indicator lights up on the display:

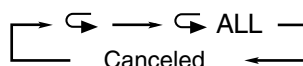

- ◀ : Repeats one track.
- ▶ ALL : In Normal Play, repeats all the tracks. In Program Play, repeats all the tracks in the program. In Random Play, repeats all the tracks in random order.

To cancel Repeat Play, press REPEAT repeatedly until the repeat indicator goes off.

- Repeat Play remains in effect even when you select another play mode (Normal, Program or Random Play).
- In Random Play, ▶ cannot be selected. If ▶ has been selected when you press RANDOM, it is canceled.

## Prohibiting Disc Ejection—Tray Lock

You can lock the disc tray and prohibit ejecting the disc whether the unit is on or off.

### On the unit ONLY:

To prohibit disc ejection, press CD ▷/|| while holding ■.

- If the disc tray is opened, close it first.

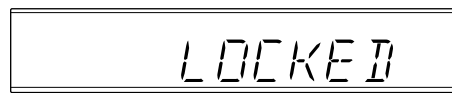
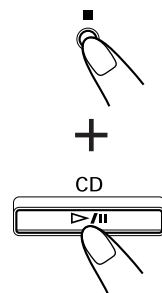

To cancel the prohibition and unlock the disc, press CD ▷/|| while holding ■.

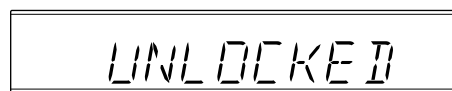

If you try to eject the disc while Tray Lock is in use “LOCKED” appears to inform you that the disc tray is locked.

# Playing Back Tapes

You can play back type I tapes.

## Playing Back a Tape

### 1 Press PUSH OPEN ▲ on the unit.

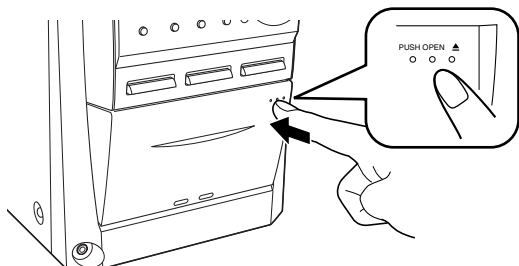

### 2 Put a cassette in with the exposed part of the tape down.

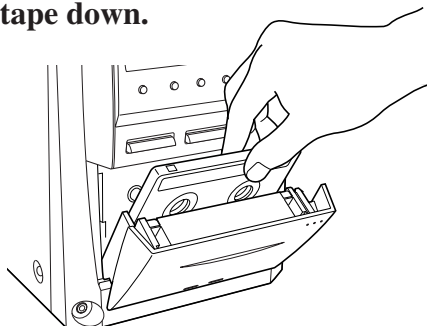

### 3 Press PUSH OPEN ▲ again to close the cassette holder.

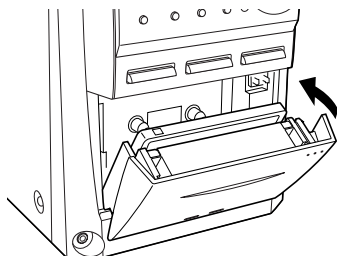



### 4 Press TAPE ◀▶.

The unit automatically turns on and the tape starts playing. The tape direction indicator (▶ or ◀) flashes slowly on the display.

- Each time you press the button, the tape direction changes:
  - ▶ : plays the front side.
  - ◀ : plays the reverse side.



When the tape plays to the end, the deck automatically stops if the Reverse Mode is set to  or . (See “To play both sides—Reverse Mode.”)



If no cassette is inserted when you press TAPE ◀▶ “NO TAPE” appears on the display.

To stop playing, press ■.

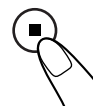

To fast-wind to the left or to the right, press ◀◀ or ▶▶ while the tape is not running.



The tape direction indicator (▶ or ◀) starts flashing rapidly on the display.

To remove the cassette, press PUSH OPEN ▲ on the unit.

- If the tape is playing, stop it first.

### To play both sides—Reverse Mode

You can set the deck to play just one side of a tape, both sides once, or both sides continuously.

Press REV.MODE (reverse mode).

- Each time you press the button, the Reverse Mode changes as follows:

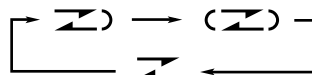

 : The deck automatically stops after playing both sides of the tape. Stops when playback in the ◀ direction is finished.

 : The deck continues to play both sides of the tape until ■ is pressed.

 : The deck automatically stops after playing one side of the tape.



- DO NOT open the cassette holder when the tape is running.
- The use of C-120 or thinner tape is not recommended, since characteristic deterioration may occur and this tape easily jams in the pinch-rollers and the capstans.



## IMPORTANT:

- It should be noted that it may be unlawful to re-record pre-recorded tapes, records, or discs without the consent of the owner of copyright in the sound or video recording, broadcast or cable program and in any literary, dramatic, musical, or artistic embodied therein.
- The recording level is automatically set correctly, so it is not affected by the other sound settings. Thus, during recording you can adjust the sound you are actually listening to without affecting the recording level.
- If recordings you have made have excessive noise or static, the unit may be too close to a TV. Increase the distance between the TV and the unit.
- You can use type I tape for recording.

### To protect your recording

Cassettes have two small tabs on the back to protect from unexpected erasure or re-recording.

To protect your recording, remove these tabs.

To re-record on a protected tape, cover the holes with adhesive tape.

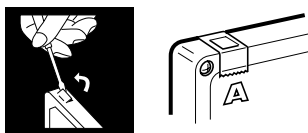

### To keep the best recording and playback sound quality

If the heads, capstans, and pinch rollers of the cassette deck become dirty, the following will occur:

- Impaired sound quality
- Discontinuous sound
- Fading
- Incomplete erasure
- Difficulty in recording

### To clean the heads, capstans, and pinch rollers

Use a cotton swab moistened with alcohol.

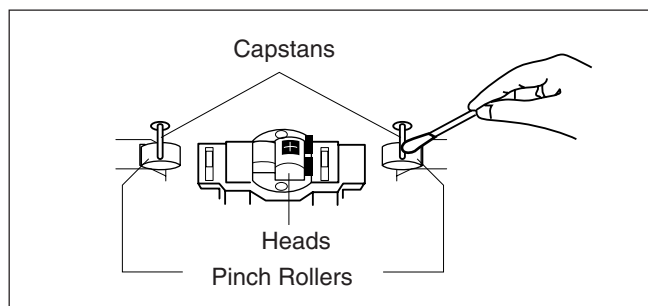

### To demagnetize the heads

Turn off the unit, and use a head demagnetizer (available at electronics and audio shops).



#### At the start and end of cassette tapes

There is leader tape which cannot be recorded onto. Thus, when recording discs or radio broadcasts, wind the leader tape first to ensure that the recording will be made without any loss.

## Recording on a Tape

### On the unit ONLY:

- 1 Put a recordable cassette in with the exposed part of the tape down.

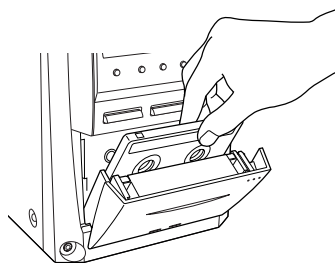

- 2 Close the cassette holder gently and check the recording direction for the tape.

- If the tape direction is not correct, press TAPE ◀▶ twice then ■ to change the tape direction.
- If you want to record on both sides of a tape, see “To record on both sides—Reverse Mode.”

- 3 Start playing the source—FM, AM (MW) or auxiliary equipment connected to AUX jacks.

- When the source is the CD player, see “Disc Direct Recording” on page 21.

- 4 Press REC (recording).

The REC (recording) indicator lights up on the display and recording starts.

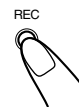

- If no cassette is inserted when you press REC “NO REC” appears on the display.
- If a protected tape is inserted when you press REC “NO REC” appears on the display.

To stop while recording, press ■.

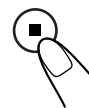

To remove the cassette, press PUSH OPEN ▲ on the unit.

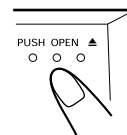



- If the tape is recording, stop it first.



DO NOT open the cassette holder when the tape is running.

### To record on both sides—Reverse Mode

Press REV.MODE (reverse mode) repeatedly until  or  is lit.

- When using the Reverse Mode for recording,  lights up and start recording in the forward (▶) direction first. Otherwise, recording will stop when recording is done only on one side (reverse) of the tape.



## Disc Direct Recording

Everything on the disc goes onto the tape in the order it is on the disc, or according to the order you have set in Program Play.

### On the unit ONLY:

- 1 Put a recordable cassette in with the exposed part of the tape down.**
- 2 Load a disc.**
  - If the current playing source is not the CD player, press CD ►/||, then ■ before going to the next step.  
— If you do not want pauses of about 4 seconds recorded between selections, press CD ►/|| twice. Otherwise, a non-recorded pause will be automatically inserted between selections.
  - If you want to record on both sides of a tape, see “To record on both sides—Reverse Mode.”

- 3 Press REC (recording).**

The REC (recording) indicator lights up on the display and recording starts. After recording, the CD player and cassette deck automatically stop.



**To stop while recording, press ■.**  
The tape stops after 4 seconds.

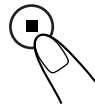

**To remove the cassette, press PUSH OPEN ▲**  
on the unit.

- If the tape is recording, stop it first.

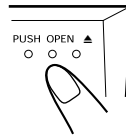

DO NOT open the cassette holder when the tape is running.

## One Track Recording

This recording method is convenient when you record tracks while playing the disc. You can record just your favorite songs on the tape.

### On the unit ONLY:

- 1 Put a recordable cassette in with the exposed part of the tape down.**
- 2 Play the track on the disc you wish to record.**
- 3 Press REC (recording).**

The CD player returns to the beginning of that track and the track is recorded on the tape. After recording, the CD player and cassette deck automatically stop.
- 4 Repeat steps 2 and 3 to record other tracks you want.**



**To stop while recording, press ■.**  
The tape stops after 4 seconds.

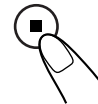

**To remove the cassette, press PUSH OPEN ▲**  
on the unit.

- If the tape is recording, stop it first.

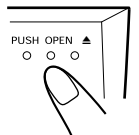

DO NOT open the cassette holder when the tape is running.

## To record on both sides—Reverse Mode

Press REV.MODE (reverse mode) repeatedly until or is lit.

- When using the Reverse Mode for Disc Direct Recording, lights up and start recording in the forward (►) direction first. When the tape reaches its end while recording a song in the forward direction (►), the last song will be re-recorded at the beginning of the reverse side (◄).
- If you start recording on the reverse side (◄), recording will stop when recording is done only on one side (reverse) of the tape.



### When making Sleep Timer settings while doing Disc Direct Recording

Set enough time to allow for the disc to finish playing; otherwise, the power will go off before recording is completed.



There are three timers available—Daily Timer, Recording Timer, and Sleep Timer. Before using the timers, you need to set the unit's clock (see page 9).

## Using Daily Timer and Recording Timer

You can set the timer whether the unit is on or off.

### How the timer actually works

When the on-time comes, the unit automatically turns on (the  [timer] and the selected timer mode [DAILY or REC] indicators flash just before the on-time, and continue flashing while the timer is operating). Then, when the off-time comes, the unit automatically turns off (standby).

The timer setting remains in memory until you change it.

- When the DAILY indicator is lit on the display, the timer acts as the Daily Timer. Once the timer has been set, it will be activated at the same time everyday until the timer is turned off.
- When the REC indicator is lit on the display, the timer acts as the Recording Timer. After the timer-recording finishes, the details of the setting remain stored but the timer is turned off.

### Before you start...

When using "TUNER" as the source to play, make sure to select the desired station before turning off the power.

- There is a time limit in doing the following steps. If the setting is canceled before you finish, start over from step 1.
- For UX-J60 only, you can also use CLOCK/TIMER on the unit for this operation.

## 1 Press CLOCK/TIMER.

The  (timer) indicator lights up and the timer mode (DAILY or REC) indicator flashes on the display.

The unit enters on-time setting mode.



## 2 Set the on-time when you want the unit to turn on.

- 1) Press UP or DOWN to set the hour, then press CLOCK/TIMER.
- 2) Press UP or DOWN to set the minute, then press CLOCK/TIMER.

The unit enters off-time setting mode.

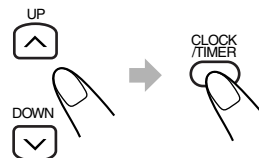

## 3 Set the off-time when you want the unit to turn off (standby).

- 1) Press UP or DOWN to set the hour, then press CLOCK/TIMER.
- 2) Press UP or DOWN to set the minute, then press CLOCK/TIMER.

The unit enters the timer selecting mode.

## 4 Press UP or DOWN to select the timer (Daily Timer or Recording Timer) with the source to play, then press CLOCK/TIMER.

- Each time you press UP or DOWN, the timer mode and the source change as follows:

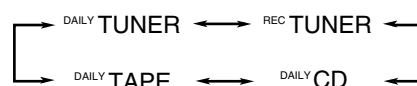

**DAILY TUNER:** tunes in to the last station you were listening to. (Daily Timer)

**REC TUNER:** records the last station you were listening to. (Recording Timer)

- Put a recordable cassette into the deck.

**DAILY CD:** plays a disc. (Daily Timer)

- Load a disc.

**DAILY TAPE:** plays a tape. (Daily Timer)

- Make sure that a tape is in the cassette deck.
- Make sure that the tape direction is correct.

The unit enters the volume level setting mode.

## 5 Press UP or DOWN to set the volume level, then press CLOCK/TIMER.

- You can select the volume level (“VOLUME –” and “VOLUME 0” to “VOLUME 40”).

If you select “VOLUME –,” the volume is set to the previous level when the unit was turned off.

- To turn off the volume while the Recording Timer (REC TUNER) is working, set the volume level “VOLUME 0.”

The unit enters the clock setting mode.

## 6 Adjust the clock if you need.

- See “Setting the Clock” on page 9.

## 7 Press STANDBY/ON to turn off the unit (standby) if you have set the timer with the unit turned on.

- When the timer turns on the unit, the  (timer) and the selected timer mode indicators (DAILY or REC) start flashing.



To deactivate the timer temporarily, press and hold CLOCK/TIMER until the  (timer) indicator on the display goes off.



To activate or change the timer (with the previous setting), follow steps 1 to 7 on pages 22 and 23.

- If you want to change the timer setting after the Daily Timer be used, first deactivate the timer.



- If the unit is turned on when the timer on-time comes**  
Timer does not work.
- When you unplug the AC power cord or if a power failure occurs**  
The timer will be canceled. You need to set the clock first, then the timer again.

## Using Sleep Timer

With the Sleep Timer, you can fall asleep to music. You can set the Sleep Timer when the unit is turned on.

### How the Sleep Timer actually works

The unit automatically turns off after the specified time length passes.

#### On the remote control ONLY:

### 1 Press SLEEP.

The time length until the shut-off time appears and the SLEEP indicator lights up on the display.



- Each time you press the button, the time length changes as follows:

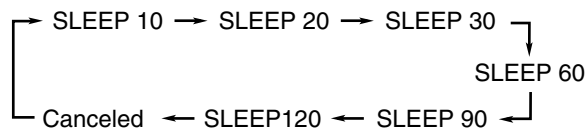

### 2 Wait for about 5 seconds after specifying the time length.

The illumination and display dim.

To check the remaining time until the shut-off time, press SLEEP once so that the remaining time until the shut-off time appears for about 5 seconds.

- The illumination and display brighten during this period.

To change the shut-off time, press SLEEP repeatedly until the desired time length appears on the display.

To cancel the setting, press SLEEP repeatedly until the SLEEP indicator goes off.

- The Sleep Timer is also canceled when you turn off the unit.



- If you set the Sleep Timer after the Daily Timer starts playing the selected source**  
The Daily Timer is canceled. When the Sleep Timer shut-off time comes, the unit will be turned off.
- If you set the Sleep Timer after the Recording Timer starts recording**  
The Recording Timer is canceled, but recording continues until the Sleep Timer shuts off the power.

# Maintenance

To get the best performance from the unit, keep your discs, tapes, and mechanism clean.

## Cleaning the unit

### • Stains on the unit

Should be wiped off with a soft cloth. If the unit is heavily stained, wipe it with a cloth soaked in water-diluted neutral detergent and wrung well, then wipe clean with a dry cloth.

### • Since the unit may deteriorate in quality, become damaged or have its paint peel, be careful about the following.

- DO NOT wipe it with a rough cloth.
- DO NOT wipe it strongly.
- DO NOT wipe it with thinner or benzine.
- DO NOT apply any volatile substances such as insecticides to it.
- DO NOT allow any rubber or plastic to remain in contact with it for a long time.

## Handling cassette tapes

- If the tape is loose in its cassette, take up the slack by inserting a pencil in one of the reels and rotating.
- If the tape is loose, it may get stretched, cut, or caught in the cassette.
- Be careful not to touch the tape surface.
- Avoid storing tapes in the following places:
  - In dusty places
  - In direct sunlight or heat
  - In moist areas
  - On a TV or speaker
  - Near a magnet

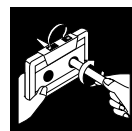

# Troubleshooting

If you are having a problem with your unit, check this list for a possible solution before calling for service.

If you cannot solve the problem from the hints given here, or the unit has been physically damaged, call a qualified person, such as your dealer, for service.

Symptom	Cause	Action
No sound is heard.	<ul style="list-style-type: none"> <li>• Connections are incorrect or loose.</li> <li>• Headphones are connected.</li> </ul>	<ul style="list-style-type: none"> <li>• Check all connections and make corrections. (See pages 6 – 8.)</li> <li>• Disconnect the headphones.</li> </ul>
Hard to listen to broadcasts because of noise.	<ul style="list-style-type: none"> <li>• Antennas are disconnected.</li> <li>• The AM loop antenna is too close to the unit.</li> <li>• The FM antenna is not properly extended and positioned.</li> </ul>	<ul style="list-style-type: none"> <li>• Reconnect the antennas correctly and securely.</li> <li>• Change the position and direction of the AM loop antenna.</li> <li>• Extend the FM antenna to the best position.</li> </ul>
The disc tray does not open or close.	The AC power cord is not plugged in.	Plug the AC power cord.
The disc does not play.	The disc is placed upside down.	Place the disc with the label side up.
The disc sound is discontinuous.	The disc is scratched or dirty.	Clean or replace the disc. (See page 16.)
The cassette holder cannot be opened.	Power from the AC power cord has been cut off while the tape was running.	Plug in the AC power cord, then turn on the unit.
Impossible to record.	Small tabs on the back of the cassette are removed.	Cover the holes with adhesive tape.
Operations are disabled.	The built-in microprocessor may malfunction due to external electrical interference.	Unplug the AC power cord and then plug it back in.
Unable to operate the unit from the remote control.	<ul style="list-style-type: none"> <li>• The path between the remote control and the remote sensor on the unit is blocked.</li> <li>• The batteries are exhausted.</li> </ul>	<ul style="list-style-type: none"> <li>• Remove the obstruction.</li> <li>• Replace the batteries.</li> </ul>

# Additional Information

## Description of the PTY codes:

<b>NEWS:</b>	News.
<b>AFFAIRS:</b>	Topical program expanding or enlarging upon the news—debate, or analysis.
<b>INFO:</b>	Program the purpose of which is to impart advice in the widest sense.
<b>SPORT:</b>	Program concerned with any aspect of sports.
<b>EDUCATE:</b>	Educational programs.
<b>DRAMA:</b>	All radio plays and serials.
<b>CULTURE:</b>	Programs concerning any aspect of national or regional culture, including language, theater, etc.
<b>SCIENCE:</b>	Programs about natural sciences and technology.
<b>VARIED:</b>	Used for mainly speech-based programs such as quizzes, panel games and personality interviews.
<b>POP M:</b>	Commercial music of current popular appeal.
<b>ROCK M:</b>	Rock music.
<b>EASY M:</b>	Current contemporary music considered to be “easy-listening.”
<b>LIGHT M:</b>	Instrumental music, and vocal or choral works.
<b>CLASSICS:</b>	Performances of major orchestral works, symphonies, chamber music, etc.
<b>OTHER M:</b>	Music not fitting into any of the other categories.
<b>WEATHER:</b>	Weather reports and forecasts.
<b>FINANCE:</b>	Stock Market reports, commerce, trading etc.
<b>CHILDREN:</b>	Programs targeted at a young audience.
<b>SOCIAL:</b>	Programs about sociology, history, geography, psychology and society.
<b>RELIGION:</b>	Religious programs.
<b>PHONE IN:</b>	Involving members of the public expressing their views either by phone or at a public forum.
<b>TRAVEL:</b>	Travel information.
<b>LEISURE:</b>	Programs about recreational activities.
<b>JAZZ:</b>	Jazz music.
<b>COUNTRY:</b>	Songs which originate from, or continue the musical tradition of the American Southern States.
<b>NATION M:</b>	Current popular music of the nation or region in that country’s language.
<b>OLDIES:</b>	Music from the so-called “golden age” of popular music.
<b>FOLK M:</b>	Music which has its roots in the musical culture of a particular nation.
<b>DOCUMENT:</b>	Program concerning factual matters, presented in an investigative style.
<b>TEST:</b>	Broadcasts for testing emergency broadcast equipment or receiver.
<b>ALARM:</b>	Emergency announcement.

**Classification of the PTY codes for some FM stations may be different from the above list on this page.**

### Alarm function

If an “ALARM” (Emergency) signal is received from a station while listening to the radio, the unit automatically switches to the station broadcasting the “ALARM” signal, except when you are listening to non-RDS stations—all AM (MW) and some FM stations.

### Test function

The “TEST” signal is used for testing the “ALARM” signal.

Therefore, it makes the unit work in the same way as the “ALARM” signal does.

If a “TEST” signal is received from a station while listening to the radio, the unit automatically switches to the station broadcasting the “TEST” signal, except when you are listening to non-RDS stations—all AM (MW) and some FM stations.

# Specifications

Design and specifications are subject to change without notice.

## UX-J60 (CA-UXJ60 and SP-UXJ60)

### **Amplifier**

Output Power:

SUBWOOFERS:

90 W (45 W + 45 W) at 6  $\Omega$  (10% THD)

MAIN SPEAKERS:

30 W (15 W + 15 W) at 6  $\Omega$  (10% THD)

Audio input sensitivity/Impedance (at 1 kHz)

AUX: 400 mV/48 k $\Omega$

Speakers/Impedance: 6  $\Omega$  – 16  $\Omega$

### **Tuner**

FM tuning range: 87.50 MHz – 108.00 MHz

AM tuning range:

MW: 522 kHz – 1 629 kHz

### **CD player**

Dynamic range: 85 dB

Signal-to-noise ratio: 90 dB

Wow and flutter: Immeasurable

### **Cassette deck**

Frequency response:

Normal (type I): 60 Hz – 14 000 Hz

Wow and flutter: 0.15% (WRMS)

### **Speaker—SP-UXJ60**

Speaker units: Subwoofer: 13.5 cm cone x 1

Woofers: 8.0 cm cone x 1

Tweeter: 4.0 cm cone x 1

Impedance: Subwoofer: 6  $\Omega$

Main speaker: 6  $\Omega$

Dimensions (approx.):

175 mm x 320 mm x 241 mm (W/H/D)

Mass (approx.): 3.7 kg each

### **Supplied Accessories**

See page 6.

### **General**

Power requirement: AC 230 V  $\sim$ , 50 Hz

Power consumption: 130 W (at operation)

1.4 W (on standby)

Dimensions (approx.):

520 mm x 320 mm x 323.3 mm (W/H/D)

Mass (approx.): 12.9 kg

## UX-J50 (CA-UXJ50 and SP-UXJ50)

### **Amplifier**

Output Power:

120 W (60 W + 60 W) at 6  $\Omega$  (10% THD)

Audio input sensitivity/Impedance (at 1 kHz)

AUX: 400 mV/48 k $\Omega$

Speakers/Impedance: 6  $\Omega$  – 16  $\Omega$

### **Tuner**

FM tuning range: 87.50 MHz – 108.00 MHz

AM tuning range:

MW: 522 kHz – 1 629 kHz

### **CD player**

Dynamic range: 85 dB

Signal-to-noise ratio: 90 dB

Wow and flutter: Immeasurable

### **Cassette deck**

Frequency response:

Normal (type I): 60 Hz – 14 000 Hz

Wow and flutter: 0.15% (WRMS)

### **Speaker—SP-UXJ50**

Speaker units: Woofer: 12.0 cm cone x 1

Midrange: 4.0 cm cone x 1

Tweeter: 2.0 cm dome x 1

Impedance: 6  $\Omega$

Dimensions (approx.):

160 mm x 285 mm x 181.5 mm (W/H/D)

Mass (approx.): 2.4 kg each

### **Supplied Accessories**

See page 6.

### **General**

Power requirement: AC 230 V  $\sim$ , 50 Hz

Power consumption: 120 W (at operation)

1.3 W (on standby)

Dimensions (approx.):

490 mm x 286 mm x 323.3 mm (W/H/D)

Mass (approx.): 10.3 kg

# MEMO

---

A series of horizontal dashed lines for writing.

# MEMO

---

A series of horizontal dashed lines for writing.





## Free Manuals Download Website

<http://myh66.com>

<http://usermanuals.us>

<http://www.somanuals.com>

<http://www.4manuals.cc>

<http://www.manual-lib.com>

<http://www.404manual.com>

<http://www.luxmanual.com>

<http://aubethermostatmanual.com>

Golf course search by state

<http://golfingnear.com>

Email search by domain

<http://emailbydomain.com>

Auto manuals search

<http://auto.somanuals.com>

TV manuals search

<http://tv.somanuals.com>