

JVC

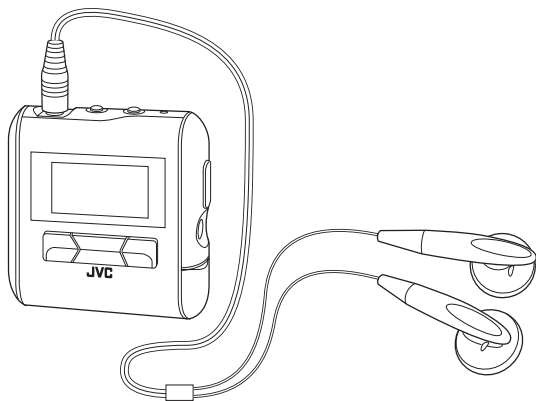

DIGITAL AUDIO PLAYER

XA-MP51A/W/S XA-MP101B/W



INSTRUCTIONS

Thank you for purchasing this JVC product.

Please read these instructions carefully before starting operation to be sure to obtain optimum performance and a longer service life from the unit.

LVT1431-002B [J, C, B, US]

CAUTIONS

Listening precautions

- Do not play your Headphones at a high volume.
- Hearing experts advise against continuous extended play.
- If you experience a ringing in your ears, reduce volume or discontinue use.
- Do not use while operating a motorized vehicle. It may create traffic hazard and is illegal in many areas.
- You should use extreme caution or temporarily discontinue use in potentially hazardous situations.
- Even if your Headphones are an open-air type designed to let you hear outside sounds, do not turn up the volume so high that you cannot hear what is around you.
- Once you have established a comfortable sound level, leave the level there.

Dry cell batteries

To prevent damage to the batteries and electrolyte leakage, heed the following points.

- Align the ⊕ and ⊖ polarities properly when inserting the battery.
- Remove the battery if you do not plan to use the player for a long period of time.
- Do not throw batteries into a fire, and do not short-circuit, disassemble or subject them to excessive heat.
- Do not attempt to recharge dry cell batteries.

For U.S.A

This equipment has been tested and found to comply with the limits for a Class B digital device, pursuant to part 15 of the FCC Rules.

These limits are designed to provide reasonable protection against harmful interference in a residential installation.

This equipment generates, uses and can radiate radio frequency energy and, if not installed and used in accordance with the instructions, may cause harmful interference to radio communications. However, there is no guarantee that interference will not occur in a particular installation. If this equipment does cause harmful interference to radio or television reception, which can be determined by turning the equipment off and on, the user is encouraged to try to correct the interference by one or more of the following measures:

Reorient or relocate the receiving antenna.

Increase the separation between the equipment and receiver.

Connect the equipment into an outlet on a circuit different from that to which the receiver is connected.

Consult the dealer or an experienced radio/TV technician for help.

For the main unit:

Declaration of Conformity

Model Number: XA-MP51A/W
XA-MP101B

Trade Name: JVC

Responsible Party: JVC Americas Corp.

Address: 1700 Valley Road, Wayne
New Jersey 07470

Telephone Number: 973-317-5000

This device complies with Part 15 of FCC Rules. Operation is subject to the following two conditions: (1) This device may not cause harmful interference, and (2) this device must accept any interference received, including interference that may cause undesired operation.

Carrying dry cell batteries around

When putting dry cell batteries in a pocket or bag, ensure that no other metal objects such as a necklace are placed together with them. Contact with any metal may cause short-circuiting which may cause a fire.

Player**• No altering or remodeling**

This can cause malfunctioning.

• No dropping or strong impacts

This may damage the player.

• Locations to be avoided

Avoid using the player in the following locations since they can cause malfunctioning.

1. Bathrooms and other moisture-prone places
2. Warehouses and other dusty places
3. Very hot places near heating appliances, etc.

CAUTIONS

Do not leave the player exposed to direct sunlight for long periods of time

This may deform or discolor the player and may also cause malfunctioning.

CAUTION:

- Do not place any naked flame sources, such as lighted candles, on the apparatus.
- When discarding batteries, environmental problems must be considered and local rules or laws governing the disposal of these batteries must be followed strictly.
- Do not expose this apparatus to rain, moisture, dripping or splashing.

For Canada Only:

This Class B digital apparatus complies with Canadian ICES-003.

Cet appareil numérique de la classe B est conforme à la norme NMB-003 du Canada.

For Canada Only:

INFORMATION

This digital apparatus does not exceed the Class B limits for radio noise emissions from digital apparatus as set out in the interference-causing equipment standard entitled "Digital Apparatus", ICES-003 of the Department of Communications.

- **We have no responsibility for any improper recording or playback incurred by equipment malfunction.**
- **It is recommended to store backup copy of your important data in your PC or the like.**

TABLE OF CONTENTS

CAUTIONS	1
TABLE OF CONTENTS	4
GETTING STARTED	5
INSTALLING BATTERY	5
INSTALLING USB DRIVER (FOR WINDOWS 98SE ONLY)	6
CONNECTING TO PC	7
CONNECTING EXTERNAL AUDIO EQUIPMENT	8
PARTS OF THE DIGITAL AUDIO PLAYER	9
TURNING POWER ON/OFF	10
DISPLAY OVERVIEW	11
BASIC OPERATIONS	12
USING THE MAIN MENU	12
PLAYING MUSIC	13
RECORDING VOICE MESSAGES	14
PLAYING MESSAGES	15
LISTENING TO FM BROADCASTS	16
RECORDING FM BROADCASTS	18
DELETING FILES	19
ADVANCED FEATURES	20
SET MENU ITEMS	20
EQUALIZER	21
PLAYMODE	23
SLEEP TIMER	24
AUTO POWER OFF	25
BACKLIGHT	26
CONTRAST	27
MENU LANGUAGES	28
FONTS	29
ABOUT	30
RESETTING THE UNIT	31
NAVIGATE	32
LOCKING BUTTONS (HOLD)	34
TROUBLESHOOTING	35
SPECIFICATIONS	36
ACCESSORIES	37

GETTING STARTED

INSTALLING BATTERY

Remove the battery compartment cover and insert one LR03 (AAA) alkaline battery (not supplied) matching the polarities (+ and -) indicated on the rear side of the player, then replace the compartment cover.

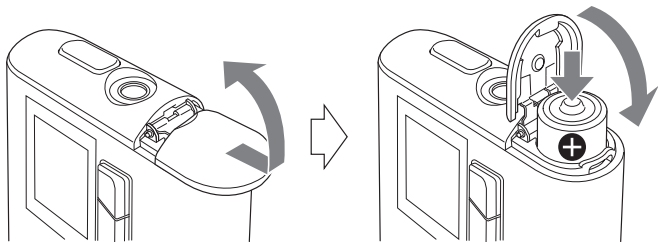

Battery indicator

The battery indicator shows the remaining battery level. When the battery level becomes low, "Low Battery" appears on the display. In this case, you need to replace the battery with a new one.

Low Battery

Important Battery Information

- Dispose of batteries in the proper manner, according to federal, state, and local regulations.
- Discard leaky batteries immediately. They can cause skin burn or other personal injury.
- Use only alkaline batteries. Do not use manganese dioxide batteries or a charger since the battery life becomes extremely short or the player may malfunction.

INSTALLING USB DRIVER (FOR WINDOWS 98SE ONLY)

Follow these instructions to load software that enables a computer to recognize the Digital Audio Player.

Make sure that no programs, such as games or anti-virus software, are running on the PC. If programs are open, close and exit from the programs before proceeding.

1. Insert the CD-ROM into the CD-ROM drive of your PC.
2. Turn off the Digital Audio Player and connect it to your PC with the USB connector.
3. Follow the on-screen instructions to install the driver from the CD-ROM.
On a screen to search for the location of the Digital Audio Player's driver, click the [Browse] button and select the XA-MP51-101 folder from the CD-ROM drive (If drive is "D", the folder path will be "D:_XA-MP51-101") and then proceed to the next screen:
4. Be sure that the installation completion screen appears.
5. Reboot the PC.

CONNECTING TO PC

You can transfer MP3 and WMA format music files from the PC to your Digital Audio Player through USB port. USB2.0 (480Mbps speed is not supported.)

For Windows 98SE user:

Before connecting your player to the computer for the first time, you need to install the USB driver from the supplied CD-ROM into your computer. For details, see "INSTALLING USB DRIVER" on page 6.

Connecting Digital Audio Player to PC

1. Open the rubber cap of the USB connector.
2. Connect the player to the USB port on your PC using USB cable.

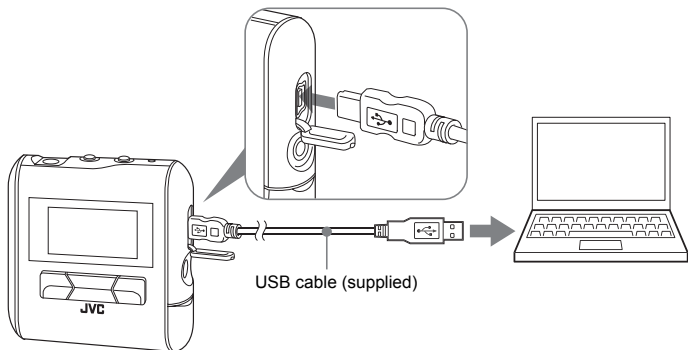

Transferring music files from PC to Digital Audio Player

1. Open the player's folder (removable disk or device) from My Computer or Explorer.
2. Copy and paste or drag and drop the music files from the PC to the player's folder. During copying files, "WRITING" appears on the player's display. After completion, "READY" continuously appears.

NOTE

- When you transfer a WMA-DRM file from the PC, use Windows Media© Player 9 or later. If you transfer it by drag and drop, it cannot be played with the player.

Disconnecting from PC**For Windows 2000/Me/XP users:**

Left-click the  icon in the task bar, and follow the on-screen instructions.

For Windows 98SE users

Open “My Computer” and select “Removable Disk”, then right-click to select “EJECT”.

- Microsoft, Windows and Windows Media are either trademarks or registered trademarks of Microsoft Corporation in the United States and other countries.
- Other names of systems and products mentioned in these instructions are usually registered trademarks of the manufacturers who developed the system or product concerned.

NOTES

- The player supports MP3 ID3 V1.0, 1.1 tags, ID3 V2.3 tags and WMA tags. ID3 tags and WMA tags are the data including music names and artist names recorded in MP3 files and WMA files.
- When the player is connected to the PC, it is recognized as an external USB memory (removal disk) and shown on the PC. You can treat the player as an external USB memory.

CONNECTING EXTERNAL AUDIO EQUIPMENT

You can listen to the music output from the player with external audio equipment. Before listening, connect an audio cable with stereo mini jack (not supplied) between the Line output jack of the player and the external audio equipment.

NOTES

- For operation of the external audio equipment, refer to its Instructions.
- When you connect an audio cable to the Line output jack of the player, no sound will come out of the earphones.

PARTS OF THE DIGITAL AUDIO PLAYER

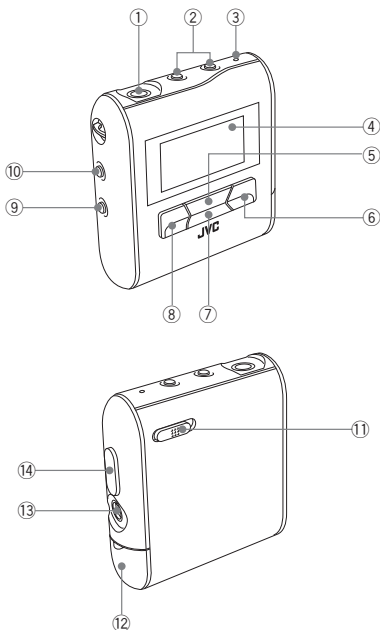

- | | |
|----------------------------------|-----------------------------|
| ① Headphone jack | ⑧ ◀◀ (Reverse) button |
| ② VOL+/- (Volume) buttons | ⑨ REC button |
| ③ MIC | ⑩ MENU button |
| ④ Display | ⑪ Hold switch |
| ⑤ ▶/ (Play/Pause) button | ⑫ Battery compartment cover |
| ⑥ ▶▶ (Forward) button | ⑬ Line output jack |
| ⑦ ■ (Stop) button | ⑭ USB connector |

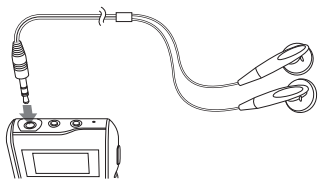

Connect the headphones to the  (headphones) jack on the player.

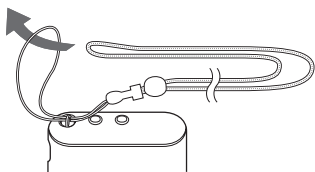

You can use the neck strap for easy carrying.

TURNING POWER ON/OFF

To turn power ON

Press and hold  button till "welcome" appears. After a while, the following screen appears.

DIGITAL
AUDIO
PLAYER

To turn power OFF

Press and hold  (Stop) button.

SEE YOU

NOTES

- When the player is turned on, it resumes the mode it was in when it was last turned off.
- The settings you have made and preset FM stations are stored in the player when you turn off the player. (If you remove the battery before turning off the player, these settings are not stored.) It is recommended to turn off the player once when you change the setting or preset FM stations.

DISPLAY OVERVIEW

MUSIC mode/ VOICE mode

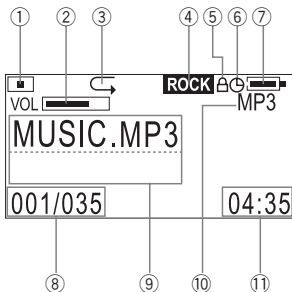

- ① Play indicator
- ② Volume level
- ③ Play mode indicator
- ④ EQ (sound mode)
- ⑤ Lock icon
- ⑥ Sleep Timer icon
- ⑦ Battery indicator
- ⑧ Track number/Total number of tracks
- ⑨ File information*
- ⑩ Mode indicator
- ⑪ Track time
- ⑫ FM mode indicator
- ⑬ Antenna icon
- ⑭ Mono/Stereo indicator
- ⑮ Preset number
- ⑯ Current status of the FM mode
- ⑰ Frequency

FM mode



* If the file information is long and displayed over two lines, it scrolls. During scrolling, the file name may not be correctly displayed.

BASIC OPERATIONS

USING THE MAIN MENU

There are number of modes you can operate using MAIN MENU.



Types of modes



MUSIC mode

Select to play music. (See page 13.)



VOICE mode

Select to record and play messages and recorded FM broadcast. (See pages 14, 15 and 18.)



FM mode

Select to listen to and record FM broadcast. (See pages 16 to 18.)



SET mode

Select to set advanced settings. (See pages 20 to 29.)



DELETE mode

Select to delete files. (See page 19.)



ABOUT mode

Select to display about the player. (See page 30.)



RESET mode

Select to reset the settings you have made. (See page 31.)



NAVIGATE mode

Select to easily search for the desired music. (See page 32.)

PLAYING MUSIC

You can play the music files.

Before playing music, adjust the volume level with the volume +/- buttons.

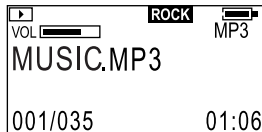

Track time (in stop mode)
Playback time (during playing)

To play music

1. After turning on the player, press **MENU** button and **▶▶| / |◀◀** button to select **MUSIC** mode from Main Menu, and then press **▶/||** button to enter that mode.
2. Press **▶/||** button
To stop: Press **■** button.
To pause: Press **▶/||** button.

To select track:

During playback or in stop mode, press **▶▶| / |◀◀** button.

To fast-forward/reverse track:

During playback, press and hold **▶▶| / |◀◀** button.

To exit MUSIC mode: Press **MENU** button.

NOTES

- If no audio files are stored, "NO FILES" appears.
- When the player is turned off in stop mode or during playback and then turned on again, it will resume playback from the beginning of the track lastly played when you start playback.
- The menu mode returns to the previous display before this menu is displayed if no operation is made for approx. 10 seconds.

RECORDING VOICE MESSAGES

You can store your voice as voice files by talking into built-in microphone.

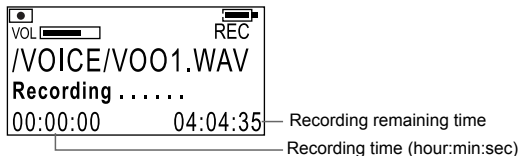

To record voice messages

1. After turning on the player, press **MENU** button and **▶▶|/|◀◀** button to select **VOICE** mode from Main Menu, and then press **▶/||** button to enter that mode.
2. Press and hold **REC** button until "Recording" appears.
To pause : Press **▶/||** button.
To stop : Press **■** button.

To playback recorded messages:

Refer to see "PLAYING MESSAGES" on page 15.

To exit VOICE mode: Press **MENU** button.

NOTES

- The recorded voice track is converted into monaural WAV files. (The "VOICE" folder is automatically generated and the files are stored in it.)
- If "Low Battery" appears when you press and hold **REC** button, it is recommended to replace the battery with new one.
- During playback, the recorded files are sorted and treated as the FM files and voice files.
- During recording, volume button operation is disabled.
- The recorded files can be copied to the PC by accessing from the PC through USB.

PLAYING MESSAGES

You can play the recorded messages (voice files and recorded FM broadcasts).

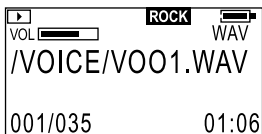

(Voice message)

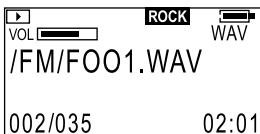

(FM broadcast program)

To play messages

1. After turning on the player, press **MENU** button and **▶▶/◀◀** button to select **VOICE** mode from Main Menu, and then press **▶/||** button to enter that mode.
2. Press **▶/||** button.
To stop: Press **■** button.
To pause: Press **▶/||** button.

To select messages:

Press **▶▶/◀◀** button.

To fast-forward/reverse message: Press and hold **▶▶/◀◀** button.

To exit VOICE mode: Press **MENU** button.

NOTES

- When the player is turned off in stop mode or during playback and then turned on again, it will resume playback from the beginning of the track lastly played when you start playback.
- If no voice files are stored, "NO FILES" appears.

LISTENING TO FM BROADCASTS

You can listen to a preset (registered) FM station after presetting FM stations. The following two operation modes are available:

Scan mode: Used to tune in to a station. A.Scan, M.Scan and S.Scan modes are available for tuning and then presetting.

Radio mode: Used to listen to a preset (registered) FM station. ("Radio" appears.)



91.50MHz for England and Singapore

Automatic presetting (Scan mode: A.Scan)

Using A.Scan (Automatic Scan) function, you can automatically preset all detected stations (up to 20) to preset Nos. P01 to P20.

1. After turning on the player, press **MENU** button and **▶▶/◀◀** button to select **FM** mode from Main Menu, and then press **▶/||** button to enter that mode.
2. Press **■** button to enter scan mode. ("Scan" appears.)
3. Press and hold **▶/||** button and then release it.
"A.Scan" appears and automatic scanning starts. After completion, the player enters radio mode.

To exit scan mode: Press **MENU** button.

To switch between scan mode and radio mode:

Press **■** button while "Radio" or "Scan" is displayed.

To tune and preset station (Scan mode: M.Scan, S.Scan):

You can listen to the desired station using M.Scan (Manual Scan) or S.Scan (Search Scan) functions. After tuning, you can preset the station to the desired preset No., as required.

1. After turning on the player, press **MENU** button and **▶▶| / |◀◀** button to select **FM** mode from Main Menu, and then press **▶/||** button to enter that mode. ("Radio" appears.)
2. Press **■** button to enter scan mode. ("Scan" appears.)
3. To manually scan: Press **▶▶| / |◀◀** button.
("M.Scan" appears. Then, each time the button is pressed, the frequency increases or decreases step by step.)
To search for a station: Press and hold **▶▶| / |◀◀** button.
("S.Scan" appears and an available station is automatically detected.)
 - You cannot use M.Scan and S.Scan functions at a time.
4. When you use M.Scan, press **▶/||** button. When you use S.Scan, press **■** button. ("Store" and preset No. appear.)
To cancel store, press **■** button to return to scan mode.
5. Press **▶▶| / |◀◀** button to select the desired preset No. you want to store.
6. Press **▶/||** button to store the station.
The player enters radio mode. ("Radio" appears.)
7. Repeat Steps 2 to 7 to continue preset operation.

To tune to preset station (Radio mode):

You can listen to up to 20 preset stations. Before use, you need to preset stations in scan mode.

1. After turning on the player, press **MENU** button and **▶▶| / |◀◀** button to select **FM** mode from Main Menu, and then press **▶/||** button to enter that mode. ("Radio" and Preset No. appear.)
2. Press **▶▶| / |◀◀** button to select the desired preset No. (P01 to P20).
To switch between Stereo and Mono, press **▶/||** button.

To delete preset station (Radio mode):

In radio mode, select the desired preset No. and then press and hold **▶/||** button until "Delete" appears.

The preset No. temporarily disappears and the default station is set.

To exit radio mode: Press **MENU** button.

RECORDING FM BROADCASTS



To record FM broadcasts

1. After turning on the player, tune to the desired FM station for recording, referring to "LISTENING TO FM RADIO BROADCASTS" on page 16.
2. Press and hold **REC** button until "Recording" appears.
 - To pause:** Press ►/|| button.
 - To stop:** Press ■ button.

To playback recorded FM broadcast station:

Refer to see "PLAYING MESSAGES" on page 15.

To exit FM mode: Press **MENU** button.

NOTES

- The recorded music from FM broadcast station is converted into stereo WAV files. (The "FM" folder is automatically generated and the files are stored in it.)
- If "Low Battery" appears when you press and hold **REC** button, it is recommended to replace the battery with new one.
- During playback, the recorded files are sorted and treated as the FM files and voice files.
- During recording, volume button operation is disabled.
- The recorded files can be copied to the PC by accessing from the PC through USB.

DELETING FILES



(DELETE submenu)



(File deletion)

To delete files

1. After turning on the player, press **MENU** button and **▶▶|/|◀◀** button to select **DELETE** mode from Main Menu, and then press **▶/||** button to enter that mode.
2. Press **▶▶|/|◀◀** button to select types of files you want to delete from the DELETE menu.
3. Press **▶/||** button.
4. Press **▶▶|/|◀◀** button to select a file you want to delete.
5. Press **■** button to select "YES".
To cancel the operation, select "NO".
6. Press **▶/||** button to delete the file.
"File Deleted" appears. If you try to delete a read-only file, "Operation Failed" appears.
(Each time you press **■** button, the status switches between "YES" and "NO".)

To return to DELETE menu: Press **MENU** button once.

To exit DELETE mode:

Press **MENU** button again (or select "EXIT" and press **▶/||** button in DELETE submenu).

NOTE

- When all files in a folder are deleted, the folder disappears from the player. However, it is not erased and remains in the player. You can erase this folder by PC through USB.

ADVANCED FEATURES

SET MENU ITEMS

In **SET** mode, you can set the following SET MENU items:
EQ SET (Equalization Set), PLAYMODE, SLEEP TIMER, A.POWER OFF (Auto Power OFF), BACKLIGHT, CONTRAST, MENU LANG (Menu Language) and FONTS

To set each item, see the relevant later page.

EQUALIZER

You can select from one of 6 different preset sound modes or one customized sound mode.

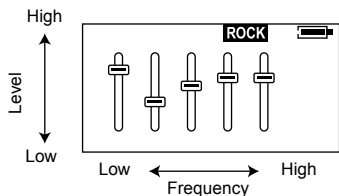

Types of sound modes

NORM

NORMAL

No sound effect applies.

CLASS

CLASSICAL

Good for classical music

JAZZ

JAZZ

Good for jazz music

ROCK

ROCK

Boosts low and high frequency.

POP

POP

Good for vocal music

BASS

BASS

Empowers bass sound.

CUST

CUSTOMIZED

You can create your own sound mode.

To select sound mode

1. After turning on the player, press **MENU** button and ►►| / |◀◀ button to select **SET** mode from Main Menu, and then press ►/|| button to enter that mode.
2. Press ►►| / |◀◀ button to select "EQ SET".
3. Press ►/|| button.
4. Press ►►| / |◀◀ button to select the sound mode.
5. Press ►/|| button to return to SET MENU.

To create sound mode (CUST)

1. After turning on the player, press **MENU** button and ►►| / |◀◀ button to select **SET** mode from Main Menu, and then press ►/|| button to enter that mode.
2. Press ►►| / |◀◀ button to select "EQ SET".
3. Press ►/|| button.
4. Press ►►| / |◀◀ button to select "CUST".
5. Press **MENU** button briefly to start editing.
The indicator of the lowest frequency is highlighted.
6. Press ►►| / |◀◀ button to select the frequency you want to edit.
7. Press ►/|| button.
The indicator starts to blink.
8. Press ►►| / |◀◀ button to set the level up or down and then press ►/|| button to store it.
9. Repeat Steps 6 through 8 to edit for other frequencies.
10. Press **MENU** button briefly. The highlight disappears and the setting is completed.
11. Press ►/|| button to return to SET MENU.

To exit SET mode:

Press **MENU** button (or select "EXIT" and press ►/|| button) in the SET MENU.

PLAYMODE

You can select various play modes. However, for voice file playback, only NORMAL, REPEAT ONE and REPEAT ALL are selectable.

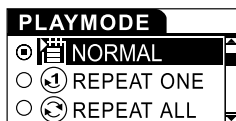

Types of playback modes



NORMAL

Normal play



REPEAT ONE

Repeats one track.



REPEAT ALL

Repeats all tracks.



RANDOM

Plays all tracks in random order.



RANDOM RPT

Repeats all tracks in random order.



INTRO

Plays first 10 seconds for each tracks.

To select play mode

1. After turning on the player, press **MENU** button and **▶▶▶ / ◀◀◀** button to select **SET** mode from Main Menu, and then press **▶/||** button to enter that mode.
2. Press **▶▶▶ / ◀◀◀** button to select "PLAYMODE".
3. Press **▶/||** button.
4. Press **▶▶▶ / ◀◀◀** button to select the play mode.
5. Press **▶/||** button to return to SET MENU.

To exit SET mode:

Press **MENU** button (or select "EXIT" and press **▶/||** button) in the SET MENU.

SLEEP TIMER

Use the sleep timer to turn off the player after a certain period of time during playback. You can set the period of time to 15, 30, 45, 60 minutes, or OFF (default). The sleep timer works temporarily. Once it has worked, it is canceled. When the sleep timer is set, the sleep timer icon () appears on the upper right of the display.

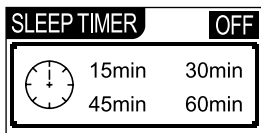

To set sleep timer

1. After turning on the player, press **MENU** button and **▶▶/◀◀** button to select **SET** mode from Main Menu, and then press **▶/||** button to enter that mode.
2. Press **▶▶/◀◀** button to select "SLEEP TIMER".
3. Press **▶/||** button.
4. Press **▶▶/◀◀** button to select the time.
5. Press **▶/||** button to return to SET MENU.

To exit SET mode:

Press **MENU** button (or select "EXIT" and press **▶/||** button) in the SET MENU.

AUTO POWER OFF

Use the auto power off to turn off the player after a certain period of time when no operation is made. You can set the period of time to 2, 5, or 10 minutes, or OFF (default).

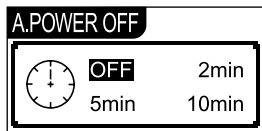

To set auto power off

1. After turning on the player, press **MENU** button and **▶▶/|◀◀** button to select **SET** mode from Main Menu, and then press **▶/||** button to enter that mode.
2. Press **▶▶/|◀◀** button to select "A.POWER OFF".
3. Press **▶/||** button.
4. Press **▶▶/|◀◀** button to select the time.
5. Press **▶/||** button to return to SET MENU.

To exit SET mode:

Press **MENU** button (or select "EXIT" and press **▶/||** button) in the SET MENU.

BACKLIGHT

Use to adjust the backlighting extension time (0 to Max) after finishing the last operation. (Default: 5 seconds) When "Max" is set, the backlighting remains on for approx. two hours.

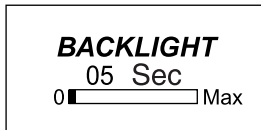

To set back light

1. After turning on the player, press **MENU** button and **▶▶| / |◀◀** button to select **SET** mode from Main Menu, and then press **▶/||** button to enter that mode.
2. Press **▶▶| / |◀◀** button to select "BACKLIGHT".
3. Press **▶/||** button.
4. Press **▶▶| / |◀◀** button to select the time.
5. Press **▶/||** button to return to SET MENU.

To exit SET mode:

Press **MENU** button (or select "EXIT" and press **▶/||** button) in the SET MENU.

NOTE

- When "Low Battery" appears, backlighting goes out and, after that, it does not light again.

CONTRAST

Use to adjust the contrast of the display.



To set contrast

1. After turning on the player, press **MENU** button and **▶▶|/|◀◀** button to select **SET** mode from Main Menu, and then press **▶/||** button to enter that mode.
2. Press **▶▶|/|◀◀** button to select "CONTRAST".
3. Press **▶/||** button.
4. Press **▶▶|/|◀◀** button to select the level.
5. Press **▶/||** button to return to SET MENU.

To exit SET mode:

Press **MENU** button (or select "EXIT" and press **▶/||** button) in the SET MENU.

MENU LANGUAGES

Use to set the language for the menu. You can select English (default), simplified Chinese or traditional Chinese.



To set menu language

1. After turning on the player, press **MENU** button and **▶▶| / |◀◀** button to select **SET** mode from Main Menu, and then press **▶/||** button to enter that mode.
2. Press **▶▶| / |◀◀** button to select "MENU LANG".
3. Press **▶/||** button.
4. Press **▶▶| / |◀◀** button to select the language.
5. Press **▶/||** button to return to SET MENU.

To exit SET mode:

Press **MENU** button (or select "EXIT" and press **▶/||** button) in the SET MENU.

FONTS

Use to set the language for the file name and ID3 tags. You can select one of 27 languages (default: English).



To set fonts

1. After turning on the player, press **MENU** button and **▶▶|/|◀◀** button to select **SET** mode from Main Menu, and then press **▶/||** button to enter that mode.
2. Press **▶▶|/|◀◀** button to select "FONTS".
3. Press **▶/||** button.
4. Press **▶▶|/|◀◀** button to select the fonts.
5. Press **▶/||** button to return to SET MENU.

To exit SET mode:

Press **MENU** button (or select "EXIT" and press **▶/||** button) in the SET MENU.

NOTE

- For details of ID3 tags, see page 8.

ABOUT

Use to display firmware version and status of the player.

About

VER: X.XXXX

INT: 1 GB

FREE: 52 MB

Amount of memory installed

Available memory space to store further music files

To display:

After turning on the player, press **MENU** button and **▶▶| / |◀◀** button to select **ABOUT** mode from Main Menu, and then press **▶/||** button to enter that mode.

To exit ABOUT mode: Press **MENU** button.

Upgrading firmware version:

To upgrade the firmware of your player, please visit our website.

RESETTING THE UNIT

Use to reset all the settings you have made to default.

RESET?

Menu:Cancel Play:sure

To reset the unit

1. After turning on the player, press **MENU** button and **▶▶/|◀◀** button to select **RESET** mode from Main Menu, and then press **▶/||** button to enter that mode.
2. Press **▶/||** button to reset the unit.
All the settings are reset and "RESET OK!" appears.

To cancel and exit RESET mode: Press **MENU** button.

Default value of each SET MENU item:

EQ SET	Normal
PLAYMODE	Normal
SLEEP TIMER	OFF
A.POWER OFF	OFF
BACKLIGHT	5 Sec
CONTRAST	Factory-set level
MENU LANG	ENGLISH
FONTS	ENGLISH

NAVIGATE

Use to display the hierarchical tree structure of music folders and files (🎵). From this tree structure, you can easily locate a desired music file and play it back.

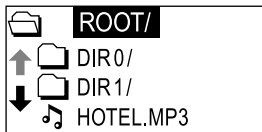

To locate a music file

1. After turning on the player, press **MENU** button and **▶▶| / |◀◀** button to select **NAVIGATE** mode from Main Menu, and then press **▶/||** button to enter that mode.
2. Press **▶▶| / |◀◀**, **▶/|| / ■** buttons to locate the desired file.
 - ▶▶| / |◀◀**: Moves the cursor (highlight) vertically. The cursor scrolls through the files and folders in the selected folder.
 - ▶/|| / ■**: 1) Move the cursor to the desired folder and press **▶/||** button to open it. Then, the files in the folder can be selected.
2) When the cursor is inside the folder, press **■** button to close the folder. Then, the hierarchical structure appears including that folder.
3. Press **▶/||** button to play it back.
(Press **▶/||** button to pause and **■** button to stop.)

To exit NAVIGATE mode: Press **MENU** button.

Music file playing order in Music mode:

From the hierarchical tree structure, you can easily understand the playing order of music files when you normally play them in Music mode. You will see that the music files are played back in the order from the higher hierarchy to the lower one.

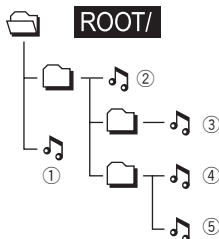

NOTES

- Maximum number of folders that can be recognized by the player is 50.
- Maximum number of hierarchies that can be recognized by the player is 8, including the highest-order folders.
- You can change the playback order of music files by adding numbers at the head of folder names or file names on PC.
(For example, add numbers like 01xxxx, 02yyyy, ...)
- The maximum number of files (WMA, MP3 and WAV files) that can be displayed or operated is 550. On a file exceeding 550, its operation is not guaranteed.

LOCKING BUTTONS (HOLD)

Slide the HOLD switch to the right to lock all controls.

When the hold function is activated, the  appears in the upper right of the display.



To unlock: Slide the HOLD switch to the left.

NOTE

- When the player is turned on with the HOLD switch set to ON position, "HOLD" appears after the initial message "DIGITAL AUDIO PLAYER". Then, the player automatically shuts off. To use the player, set the HOLD switch to OFF position and turn on the player again.

TROUBLESHOOTING

Problem	Solution
The player does not function.	<ul style="list-style-type: none">• Make sure the HOLD switch is off.• This player provides versatile operations under microcomputer control. If the player cannot be properly operated by pressing any button, remove the battery and insert it again after a while.• Battery may be drained. Replace the battery.
There is no sound or a lot of noise.	<ul style="list-style-type: none">• Make sure the Headphone is correctly connected to the player.• Wipe the Headphone plug with a clean cloth.• Keep the player away from other equipment, such as mobile phones or televisions.• Turn the volume up.
The player suddenly stops working.	<ul style="list-style-type: none">• Take the battery out for about 10 seconds and re-insert it.
The display is too dark or too bright.	<ul style="list-style-type: none">• Adjust the contrast.
The player automatically shuts off.	<ul style="list-style-type: none">• Auto power off function is set in effect. See page 25. (This is not a malfunction.)
Your computer does not recognize the player.	<ul style="list-style-type: none">• If your operating system is Windows 98SE, be sure to install the USB driver from the supplied CD-ROM in your computer.

SPECIFICATIONS

Model Name	XA-MP101	XA-MP51
Type	Digital audio player	
Built-in memory size	1 GB	512 MB
Display	LCD with backlighting (4-line display)	
FM radio	FM reception frequency: 87.5 MHz to 108.0 MHz (Wide band) Frequency step: 0.1 MHz (for USA and Canada), 50 kHz (for England and Singapore) FM recording: ADPCM system	
Voice recording	ADPCM system, with built-in monaural microphone	
Music playback format	MP3/WMA/WMA-DRM*1	
Bit rate	MP3: 8 kbps to 320 kbps, WMA: 32 kbps to 192 kbps	
Maximum number of tracks*2	Approx. 500	Approx. 250
Frequency response	60 Hz to 20 kHz, +0 dB to -3 dB (Audio)	
Output terminal	Headphone/Line output (stereo mini jack)	
Line output	330 mV/100 ohms	
Power supply	DC 1.5V "LR03" or "AAA" size battery × 1	
Continuous playback time	Approx. 17 hours (Audio playback)*3	
Dimensions (Approx.)	50 (L) × 15 (W) × 50 (H) mm (excluding protruding parts)	
Mass (Approx.)	30 g (without battery), 42 g (with battery)	

*1 WMA-DRM: A WMA file with reproduction restriction for copyright protection of digital data.

*2 Condition: WMA: 64 kbps, 1 track: 4 minutes.

*3 Condition: MP3 (128 kbs, fs=44.1 kHz) file playback, backlighting OFF, Equalization: normal

Design and specifications are subject to change without notice.

■ OS supported: Microsoft® Windows® XP (Home Edition/Professional), Windows® Me, Windows® 2000 Professional, Windows® 98SE*
(* Installation of USB driver is necessary using CD-ROM supplied)

ACCESSORIES

Headphones

USB CABLE

CD-ROM (USB Driver for Windows 98SE)

NECK STRAP

Information for Users on Disposal of Old Equipment

[European Union]



This symbol indicates that the electrical and electronic equipment should not be disposed as general household waste at its end-of-life. Instead, the product should be handed over to the applicable collection point for the recycling of electrical and electronic equipment for proper treatment, recovery and recycling in accordance with your national legislation.

Attention:

This symbol is only valid in the European Union.

By disposing of this product correctly, you will help to conserve natural resources and will help prevent potential negative effects on the environment and human health which could otherwise be caused by inappropriate waste handling of this product. For more information about collection point and recycling of this product, please contact your local municipal office, your household waste disposal service or the shop where you purchased the product.

Penalties may be applicable for incorrect disposal of this waste, in accordance with national legislation.

(Business users)

If you wish to dispose of this product, please visit our web page www.jvc-europe.com to obtain information about the take-back of the product.

[Other Countries outside the European Union]

If you wish to dispose of this product, please do so in accordance with applicable national legislation or other rules in your country for the treatment of old electrical and electronic equipment.

JVC



EN

© 2005 Vicotr Company of Japan, Limited

0705KMMCREBET

Download from [Www.Somanuals.com](http://www.somanuals.com). All Manuals Search And Download.

Free Manuals Download Website

<http://myh66.com>

<http://usermanuals.us>

<http://www.somanuals.com>

<http://www.4manuals.cc>

<http://www.manual-lib.com>

<http://www.404manual.com>

<http://www.luxmanual.com>

<http://aubethermostatmanual.com>

Golf course search by state

<http://golfingnear.com>

Email search by domain

<http://emailbydomain.com>

Auto manuals search

<http://auto.somanuals.com>

TV manuals search

<http://tv.somanuals.com>