

JVC



Main Features

PORTABLE CD PLAYER XL-PM1

MP3/CD-R/CD-RW Playback



Instruction Manual

MP3 COMPACT DISC DIGITAL AUDIO



MP3 Playback on CD-R/CD-RW

This unit is incorporated with an MP3 decoder. You can play back MP3 files (tracks) recorded on CD-Rs, CD-RWs, and CD-ROMs.



Electronic anti-Shock Protection (ESP)

Even if the player is knocked or jolted while listening to a disc, playback will not be interrupted but will continue without any interruption.

What is MP3?

MP3 is an abbreviation of Motion Picture Experts Group (or MPEG) Audio Layer 3. MP3 is simply a file format with a data compression ratio of 1:10 (128 Kbps*). That means, by using MP3 format, one CD-R or CD-RW can contain 10 times as much data volume as a regular CD can.

* Bit rate is the average number of bits that one second of audio data will consume. The unit used is Kbps (1000 bits per second).

To get a better audio quality, choose a higher bit rate. The most popular bit rate for encoding (recording) is 128 Kbps.

MP3 File Compatibility

- This player can only read MP3 files that are recorded in the format that is compliant with ISO 9660 Level 1 or Level 2.
- The player can read or play an MP3 file only with the extension code —“.mp3”.
- ID3* tags cannot be shown on the display.

* An MP3 file can contain file information called “ID3 Tag” where its album name, performer, track title, etc. are recorded. There are two versions—ID3v1 (ID3 Tag version 1) and ID3v2 (ID3 Tag version 2).

For customer Use:

Enter below the Model No. and Serial No. which are located on the top or bottom of the cabinet. Retain this information for future reference.

Model No. _____
Serial No. _____

Printed in China
0601KSMMDWSAM

LVT0788-001A
[J/C]



Precautions

Safety

Do not handle the AC adaptor with wet hands.

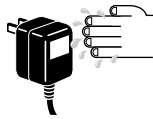

Do not route the cord of the AC adaptor in a way it will be walked on or be pinched.



When unplugging your player, always pull the plug, not the cord.



When not in use, disconnect the AC adaptor from the AC outlet.



Handling

Do not leave your player in direct sunlight or near a heat source.



Do not allow dust or other contaminants to come into contact with or to penetrate into your player.



Do not place any object on the top of your player.

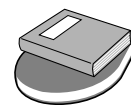

Do not insert anything other than a CD (CD-R or CD-RW) inside your player.



Do not use your player on uneven or unstable surfaces.



Do not touch the lens with your finger or scratch it.



Do not place your player in a steamy or humid location.



Do not attempt to take apart, repair or modify your player.



Do not place your player near equipment generating strong magnetic fields.



WARNING:

TO REDUCE THE RISK OF FIRE OR ELECTRIC SHOCK, DO NOT EXPOSE THIS APPLIANCE TO RAIN OR MOISTURE.

CAUTION!

THIS PRODUCT UTILIZES A LASER.
USE OF CONTROLS OR ADJUSTMENTS OR PERFORMANCE OF PROCEDURES OTHER THAN THOSE SPECIFIED HEREIN MAY RESULT IN HAZARDOUS RADIATION EXPOSURE.
DO NOT OPEN COVERS AND DO NOT REPAIR YOURSELF.
REFER SERVICING TO QUALIFIED PERSONNEL.

THE FOLLOWING NOTICES ARE APPLIED ONLY FOR U.S.A.:

This device complies with Part 15 of the FCC Rules. Operation is subject to the following two conditions: (1) This device may not cause harmful interference, and (2) this device must accept any interference received, including interference that may cause undesired operation.

**POWERED BY NICKEL-CADMIUM BATTERY.
MUST BE RECYCLED OR DISPOSED OF PROPERLY.**

ATTENTION:

The product that you have purchased is powered by a rechargeable battery. The battery is recyclable. At the end of its useful life, under various state and local laws, it may be illegal to dispose of this battery into the municipal waste stream. Check with your local solid waste officials for details in your area for recycling options or proper disposal.



Ni-Cd

**Listening precautions**

Do not play your headphones or earphones at a high volume. Hearing experts advise against continuous extended play.

If you experience a ringing in your ears, reduce volume or discontinue use.

Do not use while operating a motorized vehicle. It may create a traffic hazard and is illegal in many areas.

You should use extreme caution or temporarily discontinue use in potentially hazardous situations.

Even if your headphones or earphones are an open-air type designed to let you hear outside sounds, don't turn up the volume so high that you can't hear what's around you.

Sound can be deceiving. Over time your hearing "comfort level" adapts to higher volumes of sound. So what sounds "normal" can actually be loud and harmful to your hearing.

Guard against this by setting your equipment at a safe level BEFORE your hearing adapts.

To establish a safe level:

- Start your volume control at a low setting.
- Slowly increase the sound until you can hear it comfortably and clearly, and without distortion.

Once you have established a comfortable sound level:

- Set the dial and leave it there.

CAUTION!

This equipment has been tested and found to comply with the limits for a Class B digital device, pursuant to Part 15 of the FCC Rules.

These limits are designed to provide reasonable protection against harmful interference in a residential installation.

This equipment generates, uses and can radiate radio frequency energy and, if not installed and used in accordance with the instructions, may cause harmful interference to radio communications. However, there is no guarantee that interference will not occur in a particular installation. If this equipment does cause harmful interference to radio or television reception, which can be determined by turning the equipment off and on, the user is encouraged to try to correct the interference by one of the following measures:

- Reorient or relocate the receiving antenna.
- Increase the separation between the equipment and receiver.
- Connect the equipment into an outlet on a circuit different from that to which the receiver is connected.
- Consult the dealer or an experienced radio/TV technician for help.

Any unauthorized changes or modifications to this equipment would void the user's authority to operate this device.

INFORMATION (For Canada)

This digital apparatus does not exceed the Class B limits for radio noise emissions from digital apparatus as set out in the interference-causing equipment standard entitled "Digital Apparatus", ICES-003 of the Department of Communications.

Usable Discs

This unit has been designed to play back the following discs:

- **Audio CD**
- **CD Recordable (CD-R)**
- **CD ReWritable (CD-RW)**

In addition to the above discs, this unit can play back audio data recorded on CD-Text, CD-G (CD Graphics) and CD-Extra.

Notes on playing a CD-R or CD-RW:

- The player can play back only **finalized** CD-Rs/CD-RWs.
- The player can play back CD-Rs or CD-RWs recorded on a personal computer only if it has been recorded in the CD audio format or recorded in MP3 format.
- Some CD-Rs and CD-RWs may not be played back because of their disc characteristics, damage or stains.
- CD-RWs may require a longer readout time. This is caused by the fact that the reflectance of CD-RWs is lower than for regular CDs.
- MP3 discs (either CD-R or CD-RW) require a longer readout time. (It differs due to the complexity of the group/file configuration.)
- When both audio CD format tracks and MP3 files are recorded on a CD-R or CD-RW, this player plays back only one of them which is recognized first.

Buttons and Controls

Main Unit

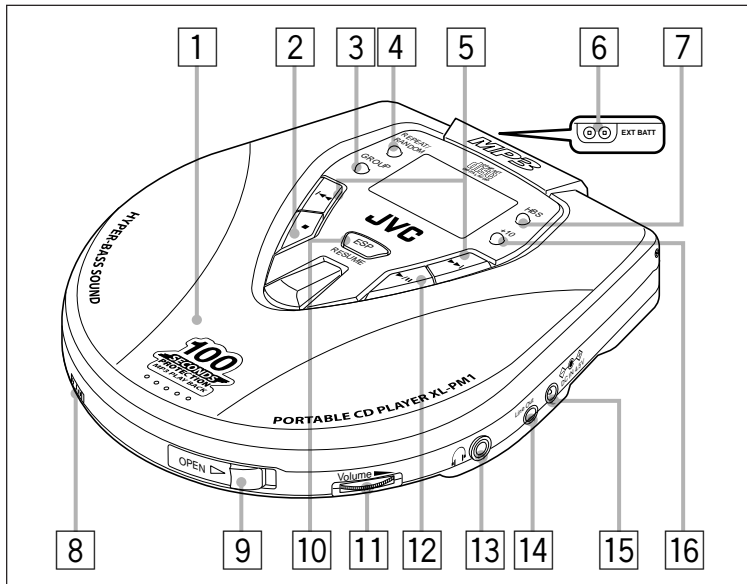

- 1 Lid**
By sliding the OPEN switch to the right, you can open the lid and load a disc.
- 2 ■ (stop) button**
Press this button to stop playback.
– Pressing this button while in stop mode shuts off the power (“OFF” appears on the display).
- 3 GROUP button**
 - Press this button to skip groups while playing an MP3 disc.
 - Press and hold this button to turn on or off Group play while playing an MP3 disc.
- 4 REPEAT/RANDOM button**
 - Press this button to select Repeat play.
 - Press and hold this button to turn on or off Random play.
- 5 ◀◀ / ▶▶ (reverse skip/forward skip) button**
 - Press this button to skip tracks (files) in the reverse way.
 - Press and hold this button to search for a particular point on a track (file) in the reverse way.
- 6 EXT BATT (external battery) connectors**
- 7 HBS button**
Press this button to reinforce the bass sounds.
- 8 HOLD switch**
By sliding this switch to the right, you can prohibit button operations.
- 9 OPEN switch**
By sliding this switch to the right, you can open the lid and place a disc.
- 10 ESP/RESUME button**
 - Press this button to turn on or off ESP (Electronic anti-Shock Protection) while loading an audio CD.
 - Press this button to turn on or off Resume play while loading an MP3 disc.
- 11 Volume control**
- 12 ▶/|| (play/pause) button**
Press this button to (re)start or pause playback.
– Pressing this button while the power is off turns on the player.
- 13 🎧 (Headphones) jack**
- 14 Line Out jack**
- 15 DC Input jack (DC IN 4.5V ⚡)**
- 16 +10 button**
Press this button to skip 10 tracks (files) at a time.

Display

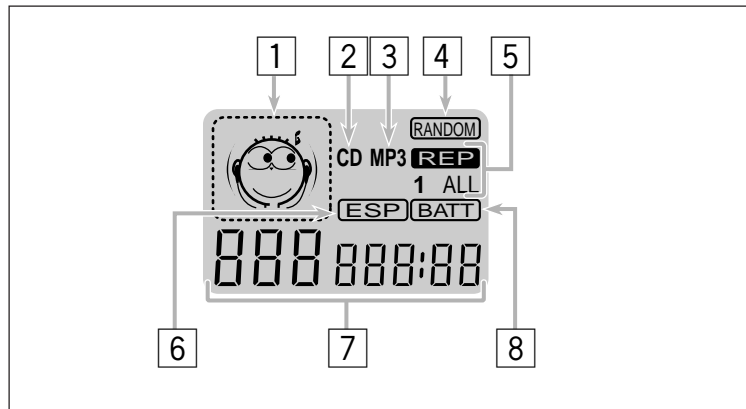

- 1 Operation indicator**
- 2 CD indicator**
Lights up while loading an audio CD format disc.
- 3 MP3 indicator**
Lights up while loading an MP3 disc.
- 4 RANDOM indicator**
Lights up during Random play (tracks are played at random).
- 5 REPEAT 1/ALL indicator**
Lights up during Repeat play.
 - REPEAT 1: Select to play a track repeatedly.
 - REPEAT ALL: Select to play all tracks on a disc repeatedly.
- 6 ESP indicator**
Lights up while Electronic anti-Shock Protection is in use. (Without this indicator lit, ESP is always active for MP3 playback.)
- 7 Main display**
Group number, track number, playing time, etc. appear while operating the player.
- 8 BATT indicator**
 - Always lights up when the power is on.
 - Flashes when the batteries are discharged.

Specifications

Portable CD player

Type:	Compact disc player
Signal detection system:	Non-Contact optical pick up (semiconductor laser)
Number of channels:	2 channels (stereo)
Frequency range:	20 Hz to 20,000 Hz
Output:	
🎧 (Headphones):	3.5 mm dia. stereo x 1 5.5 mW, per channel, at 16 Ω impedance
Line Out:	(3.5 mm dia. stereo x 1) 670 mV/47 kΩ
Power requirements :	DC 3 V (LR03, “AAA” size battery x 2) DC 2.4 V (rechargeable battery x 2) EXT BATT: DC 3 V (LR6, “AA” size battery x 2) DC IN 4.5 V
Dimensions (W x H x D):	Excluding buttons and controls 130 mm X 30 mm X 143 mm (5-1/8 in. x 1-3/16 in. x 5-11/16 in.)
Mass (without batteries) :	Approx. 242 g (0.54 lbs)
AC adaptor	
Input power source:	AC 120 V ~, 60 Hz
Output voltage:	DC 4.5 V, 500 mA

Accessories

Headphones (1), External battery case (1), AC adaptor (1)

Troubleshooting Guide

Problem	Check
Unit has no power.	<ul style="list-style-type: none"> • Are the batteries inserted correctly? • Is the battery exhausted? • Is the AC adaptor connected correctly? • Is the lid closed?
Playback does not start.	<ul style="list-style-type: none"> • Is the disc inserted correctly? • Is the disc damaged or deformed? • Has the player been locked with the HOLD switch? • Has the player been moved from a cold place to a hot place? Abrupt change of temperature may cause condensation to form on the lens. Keep your player in a warm place until the condensation on the lens has vaporized.
No sound through headphones.	<ul style="list-style-type: none"> • Is the volume control at the minimum setting? • Are the headphones connected correctly?
A sound or tracks is skipped.	<ul style="list-style-type: none"> • Was the unit jolted or knocked? • Are there dust, fingerprints or scratches on the disc?
Disc cannot be played back.	<ul style="list-style-type: none"> • Are no MP3 files recorded on the disc? • Do MP3 files have the extension code—.mp3? • Are MP3 files recorded in the format compliant with ISO 9660 Level 1 or Level 2?
Noise is generated.	<ul style="list-style-type: none"> • Are you playing a compatible disc? While playing a non-MP3 file, you will hear a noise. (Note it may not be an MP3 file although it has the extension code—.mp3.)
"Sorry" appears on the display.	<ul style="list-style-type: none"> • Have you inserted an incompatible MP3 disc? Some MP3 discs may not be played back because of their disc characteristics, damage or stains.

When purchasing rechargeable batteries

For safety, JVC's portable CD players have been designed not to allow you to charge dry cell batteries.

It is recommended to use the rechargeable Ni-Cd batteries —**P-4SPA/2B** (in USA) or **P-4SPC/2B** (in Canada)—two batteries included in the package.

- If the recommended batteries are not available, purchase the equivalent.

Charging procedure:

1 ONLY when using the rechargeable battery —P-4SPA or P-4SPC:

Strip the sheath covering the terminals of the rechargeable battery before inserting into the battery compartment.

- As shown in the illustration, with a knife carefully strip the sheath of the negative (-) terminal by 6 mm.
- If the sheath is not stripped, charging will not start.

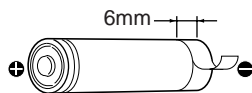

2 Insert rechargeable batteries (not supplied), by matching the polarity (+ and -).

- For details, see "When using the player outdoors" on the reverse page.

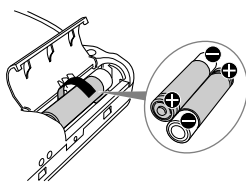

3 Connect the AC adaptor to the DC Input jack (DC IN 4.5V ⚡).

4 Connect the plug of the AC adaptor to an AC outlet.

Battery charging starts (and completes in 6 hours).

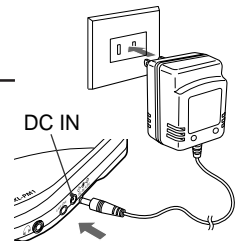

5 When battery charging is completed, unplug the AC adaptor from the power outlet and the DC Input jack (DC IN 4.5V ⚡).

To be continued on the right column

Preparations

How to Supply the Power

You can select the best power source for your own needs.

When using the player indoors

Use the AC adaptor supplied with your player.

- 1 Connect the AC adaptor to the DC Input jack (DC IN 4.5V \diamond \blacklozenge \blacklozenge).
- 2 Connect the plug of the AC adaptor to an AC outlet.

When not in use, disconnect the AC adaptor from the AC outlet.

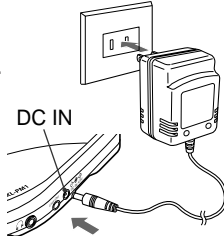

To enjoy the player's sounds through your audio system

Using a stereo connection cable—one end with stereo mini-plug, the other end with two pin plugs (not supplied), you can listen to the playback sound of this player through your audio system.

- Connect the cable to amplifier after turning it off.
- Do not connect the cable to the PHONO jacks on the amplifier.
- Adjust the volume level on the amplifier.

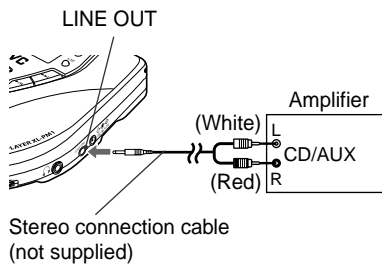

When using the player outdoors

Use two "AAA" (LR03) alkaline 1.5 V dry-cell batteries or rechargeable batteries (both not supplied).

- **When using dry-cell batteries:** It is recommended to use Alkaline batteries (longer battery life than Manganese batteries).
- **When using rechargeable batteries:** See also "When purchasing rechargeable batteries" on the reverse page.

- 1 Open the battery compartment lid.

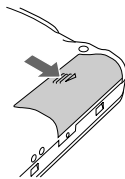

- 2 Insert two batteries, by matching the polarity (+ and -) on the batteries with the + and - markings indicated on the player.

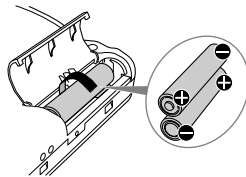

- 3 Replace the lid.

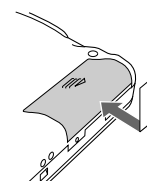

When removing the batteries, open the battery compartment lid, then pull the strap so that the batteries come out.

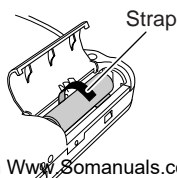

To use the player for much longer hours

By connecting the external battery case (supplied), you can extend the use time of this player.

- Use two "AA" (LR6) alkaline 1.5 V dry-cell batteries (not supplied).

- 1 Open the battery compartment lid of the external battery case.

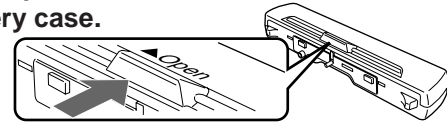

- 2 Insert two batteries, by matching the polarity (+ and -) on the batteries with the + and - markings on the battery compartment.

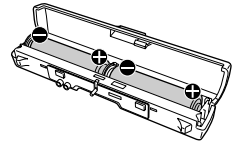

- 3 Close the lid.

- 4 Insert the fixing screw and the external battery case connectors on the external battery case into the rear of the player.

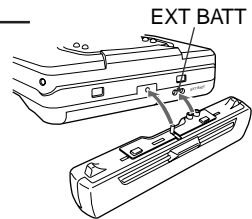

- 5 Turn the LOCK knob in the direction of the arrow to secure external battery case tightly in position.



Battery Life (Using alkaline batteries)

Disc played	Main unit	External battery case	Main unit & External battery case
Audio CD	6 hours	16 hours	22 hours
MP3 disc	4 hours	11 hours	15 hours



Cautions on handling batteries

- Do not charge dry-cell batteries.
- Do not mix the new batteries with the old ones.
- Do not expose batteries to heat or flame.
- Remove the batteries if they are not in use for a long time.
- Remove dry-cell batteries when connecting the AC adaptor.

When using the player in a car

When purchasing a car audio cassette adaptor (not supplied), check whether it can be used for your car audio system.

- 1 Connect a car audio cassette adaptor (not supplied) to the headphones jack (🎧) on the player.

Car audio system Cigar lighter

- 2 Insert the car audio cassette adaptor into your car audio system as in the figure.

- Adjust the Volume control on this player properly.

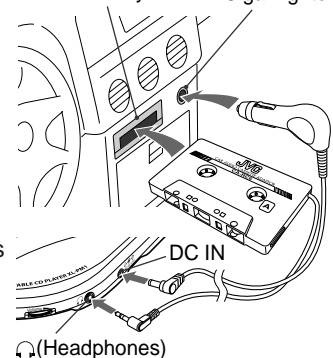

If your car audio system has an line input jack, connect to the Line Out jack on the unit using a cord with stereo mini-plug—3.5 mm diameter (not supplied).

Do not operate the player while driving.

Disc Playback

Before starting play...

- Turn the Volume control to the minimum (to the right).
- Connect the headphones to the Headphones jack (🎧).

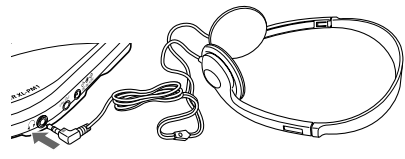

- Slide the OPEN switch in the direction of the arrow to open the lid.**
- Place a disc.**
 - When placing a disc, press down the portions around the center hole until the disc is fixed in place correctly as in the figure.
- Push the lid to close it.**
- Press ▶/⏸ (play/pause).**

Once the disc type (CD or MP3) is recognized, playback starts.

Track number Playing time

EX.: When playing an audio CD

To stop playback for a moment

Press ▶/⏸ (play/pause) during play.

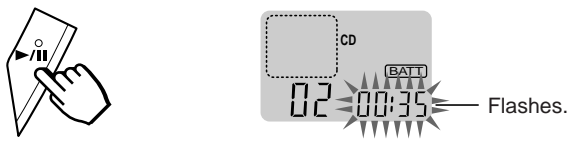

To resume play, press ▶/⏸ (play/pause) again.

To stop playback, press ■ (stop).

• When you stop playback during MP3 playback, see “Resuming Playback—Only for MP3.”

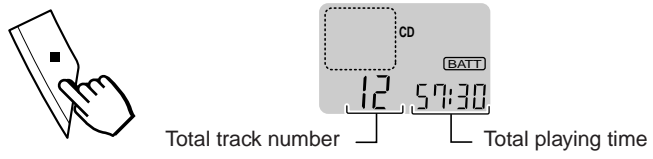

To turn off the power, press ■ (stop) again.

• When you turn off the player during MP3 playback, see “Resuming Playback—Only for MP3.”



If the player is left in stop mode for 10 seconds, it automatically turns off—Auto power off.

- To remove the disc,** slide the OPEN switch in the direction of the arrow to open the lid, then remove the disc.
- Hold the disc as illustrated when removing it from the player.
 - When you open then close the lid while the power is on, the player automatically turns off.
-

DO NOT open the lid during play.

MP3 group/file configuration

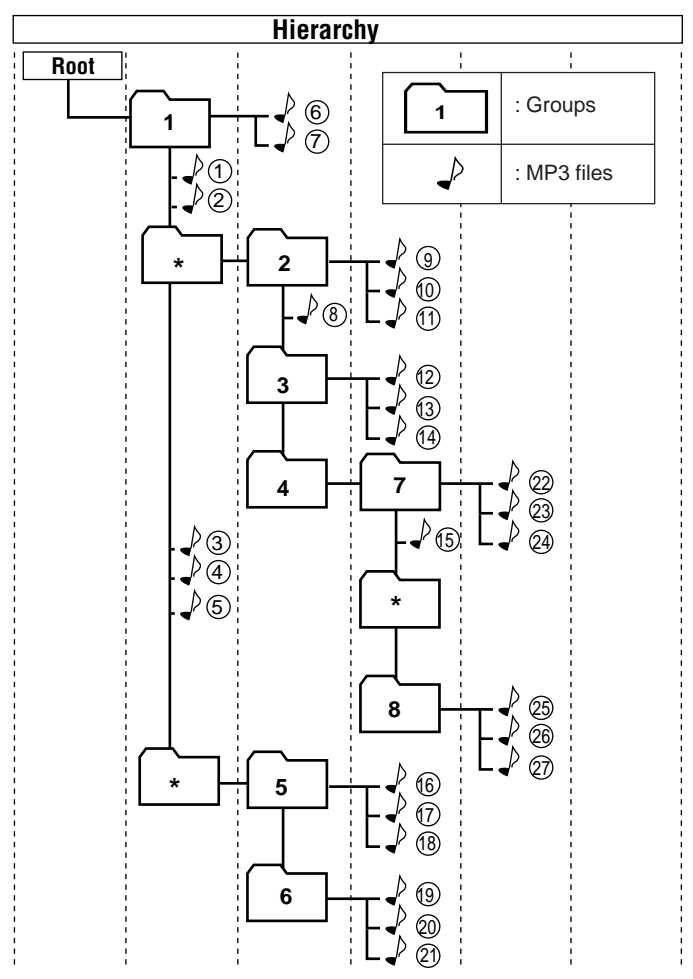

How are MP3 files recorded and played back?

MP3 “files (tracks)” can be recorded in “group” —folders or directories, in PC terminology.

During recording, the files and groups can be arranged in a way similar to arranging files and folders/directories of computer data. “Root” is similar to the root of a tree. Every file and group can be linked to the root.

In compliance with ISO 9660, the maximum allowable depth of nested directories—so-called “hierarchy”—is eight (inclusive of the root).

Playback order, file search order, and group search order of the MP3 files recorded on a disc are determined by the writing (or encoding) application; therefore, playback order may be different from the one you have intended while recording the groups and the files.

The illustration above shows an ordinary example of how MP3 files are recorded on a CD-R or CD-RW, how they are played back, and how they are searched on this player.

- The numbers in circles next to the MP3 files (🎵) indicate the playback order and search order of the MP3 files. Normally this player plays back MP3 files in the recorded order.
- The numbers inside the groups indicate the playback order and search order of the groups on an MP3 disc. Normally this unit plays back MP3 files in the groups in the recorded order. The group marked with asterisk (*) will be skipped since they are not including any MP3 files.

Disc Playback (Continued)

Locating a Particular Point

You can locate a particular point in a track or file during play—Search. Press and hold **▶▶|** or **|◀◀**.

- **▶▶|**: Fast-forwards the tracks (or files).
- **|◀◀**: Fast-reverses the tracks (or files).

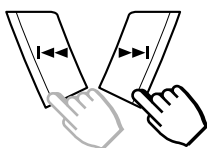

Skipping Tracks or Files

To go to another track (or file)—Skip

Press **▶▶|** or **|◀◀** repeatedly.

- **▶▶|**: Skips to the beginning of the next or succeeding tracks (or files).
- **|◀◀**: Goes back to the beginning of the current or previous tracks (or files).

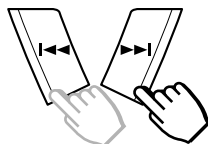

To skip 10 tracks or files at a time

Press **+10** while playing back a disc.

Example: To select track (or file) number 43, while playing back track (or file) number 15.

15 → 20 → 30 → 40 → 41 → 42 → 43

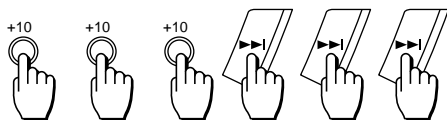

The **+10** button works only if a disc (or a group—during Group play) includes more than 10 tracks (files).

Playing Repeatedly

You can play back a track(s) or file(s) or entire disc repeatedly—Repeat play.

Press REPEAT/RANDOM briefly.

- Each time you press the button, Repeat play changes and the following indicator lights up on the display:

REPEAT/
RANDOM



REP 1: To repeat the current track or file.

REP ALL: To repeat playback of all tracks or files.

To cancel Repeat play, press REPEAT/RANDOM so that the **REP** indicator goes off.

Playing at Random

You can play back all track(s) and file(s) at random—Random play.

Press and hold REPEAT/RANDOM so that the **RANDOM indicator lights up on the display.**

Random play ends when all tracks or files are played once.

- Each time you press and hold the button, the **RANDOM** indicator lights up or goes off alternately.

REPEAT/
RANDOM

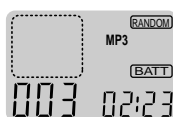

To cancel Random play, press and hold REPEAT/RANDOM again so that the **RANDOM** indicator goes off.



You cannot use Repeat play and Random play at the same time.

Playing a Group—For Only MP3

While playing back an MP3 disc, you can select a group—Group play.

To turn on or off Group play

Press and hold GROUP while loading an MP3 disc.

- Each time you press and hold the button, Group play turns on (“On group”) or off (“Off group”) alternately.

GROUP

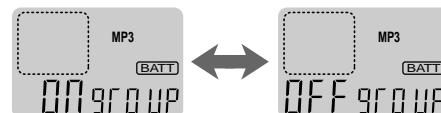

To cancel Group play, press and hold GROUP again so that “Off group” appears on the display.

- **When Group play is turned on (“On group”)**, you can select a group and play back files in a group by pressing GROUP (then move to another group).

Indications on the display

■ Before playback

Total file number **123-008-** Total group number

■ During playback

The current file number in the group and the group number alternate (scroll). **001 00:05** Playing time

- **When Group play is turned off (“Off group”)**, you can select and play back files in the same way as you select tracks for an audio CD. (Indications are also the same as while playing an audio CD.)

To skip groups during Group play

Press GROUP repeatedly while loading an MP3 disc.

- Each time you press the button, the next group is selected, and the first file in that group starts playing.

GROUP



Group play cannot be possible on MP3 discs without groups (folders) recorded.

Resuming Playback—Only for MP3

When you start playing an MP3 disc, Resume play is automatically activated.

Resume play works as follows:

- **When you stop or turn off the player during MP3 playback**, this player will start the last file you have listened to, next time you start playback.

To cancel Resume play, press ESP/RESUME while loading an MP3 file.

- Each time you press the button, Resume play turns on (“On RESU”) or off (“Off RESU”) alternately.

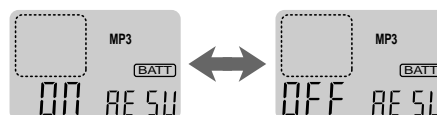

To cancel Resume play, press ESP/RESUME again so that “Off RESU” appears on the display.

Other Functions

Reinforcing the Bass

You can reinforce the bass sound—HBS (Hyper-Bass Sound).

Press HBS.

- Each time you press the button, Group play turns on (“On Hbs”) or off (“Off Hbs”) alternately.

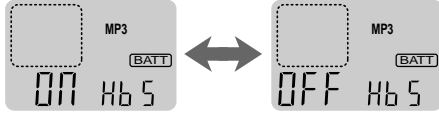

To cancel Hyper-Bass Sound, press HBS again so that “Off Hbs” appears on the display.

Using Electronic Anti-Shock Protection

With Electronic anti-Shock Protection (ESP) turned on, playback will not be interrupted but will continue normally if the player is knocked or jolted while listening to a disc.

- This function minimizes sound interruption caused by vibrations, by utilizing audio data stored in the buffer before being reproduced as sounds.
- While playing an MP3 disc, ESP is always activated though the **ESP** indicator is not lit. (You cannot cancel it).

Press ESP/RESUME, while loading an audio CD disc, so that the **ESP** indicator lights up on the display.

- Each time you press the button, the **ESP** indicator lights up or goes off alternately.



- When **ESP** is turned on, the data is stored—:
 - For audio CD format discs: Up to 45-second signals
 - For MP3 discs: Up to 100-seconds signals

To cancel **ESP**, press ESP/RESUME again so that the **ESP** indicator goes off.



ESP is automatically canceled when the voltage power drops (below 1.7 V).

Preventing Unintended Operations

You can prevent unintended operations while carrying the player, etc.

Slide the **HOLD** switch to the right (in the direction of the arrow) to lock the buttons.

- When the **HOLD** switch is set to the right position, no button can work. If you press a button, “HOLD” will appear on the display.

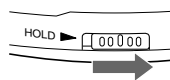

To unlock the button operations, slide the **HOLD** switch back to the left position.

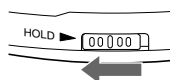

Maintenance

Discs

Handling your discs

Carefully pick up the disc by its edge without touching the disc’s surface.

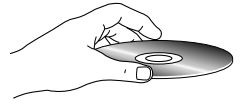

Cleaning your discs

Wash the disc with a neutral detergent diluted in water, and then wipe gently with a soft dry cloth from the center of the disc to the outside.

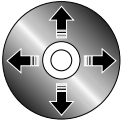

Deformed discs

Place a heavy book (4 kg – 5 kg) on the disc for at least one day.

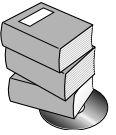

Irregular-shape discs (heart-shape, octagonal, etc.)

Continued use of such shape discs can damage the unit.

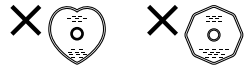

The unit

- Wipe the unit with a soft cloth.
- When removing stubborn dirt, use a cloth which has been dipped in water or soapy water and wrung out, then wipe the unit again with a dry cloth.
- If you intend to use a chemically treated cleaning cloth, read its instruction manual first.
- Do not use alcohol or paint thinner.

The lens

Open the lid and clean the lens as shown in the figure. Use a cotton swab to gently wipe off any fingerprints.

- If moisture has formed on the lens, you need to wait about one hour for the moisture to evaporate.

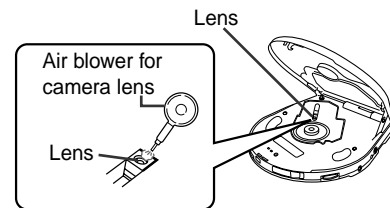

Service

Damage Requiring Service—The unit should be serviced by qualified service personnel when:

- The AC adaptor is damaged; or
- Objects have fallen or liquid has been spilled into the unit; or
- The unit has been exposed to rain; or
- The unit does not appear to operate normally or exhibits a marked change in performance; or
- The unit has been dropped, or the enclosure damaged.

Free Manuals Download Website

<http://myh66.com>

<http://usermanuals.us>

<http://www.somanuals.com>

<http://www.4manuals.cc>

<http://www.manual-lib.com>

<http://www.404manual.com>

<http://www.luxmanual.com>

<http://aubethermostatmanual.com>

Golf course search by state

<http://golfingnear.com>

Email search by domain

<http://emailbydomain.com>

Auto manuals search

<http://auto.somanuals.com>

TV manuals search

<http://tv.somanuals.com>