

**JVC®**



**HD VIDEO CASSETTE RECORDER**

**BR-HD50 INSTRUCTION MANUAL**

**HDV DV Mini DV**

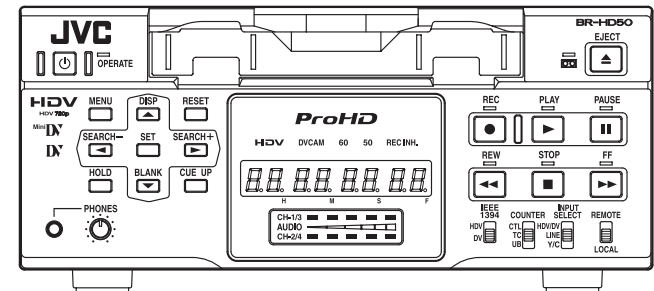

**JVC®**

This instruction manual is made from 100% recycled paper.

Thank you for purchasing this JVC product. Before operating this unit, please read the instructions carefully to ensure the best possible performance.

**For Customer Use:**

Enter below the Serial No. which is located on the rear of cabinet. Retain this information for future reference.

Model No. BR-HD50U

Serial No. \_\_\_\_\_

JVC® is a registered trademark owned by Victor Company of Japan, Limited.  
 JVC® is a registered trademark in Japan, the U.S.A., the U.K. and many other countries.  
 ©2005 Victor Company of Japan, Limited

Printed in Japan  
 LLT0088-001A

LLT0088-001A

## IMPORTANT SAFEGUARDS

1. Read all of these instructions.
2. Save these instructions for later use.
3. All warnings on the product and in the operating instructions should be adhered to.
4. Unplug this appliance system from the wall outlet before cleaning. Do not use liquid cleaners or aerosol cleaners. Use a damp cloth for cleaning.
5. Do not use attachments not recommended by the appliance manufacturer as they may cause hazards.
6. Do not use this appliance near water - for example, near a bathtub, washbowl, kitchen sink, or laundry tub, in a wet basement, or near a swimming pool, etc.
7. Do not place this appliance on an unstable cart, stand, or table. The appliance may fall, causing serious injury to a child or adult, and serious damage to the appliance. Use only with a cart or stand recommended by the manufacturer, or sold with the appliance.  
Wall or shelf mounting should follow the manufacturer's instructions, and should use a mounting kit approved by the manufacturer.  
An appliance and cart combination should be moved with care. Quick stops, excessive force, and uneven surfaces may cause the appliance and cart combination to overturn.
8. Slots and openings in the cabinet and the back or bottom are provided for ventilation, and to insure reliable operation of the appliance and to protect it from overheating, these openings must not be blocked or covered. The openings should never be blocked by placing the appliance on a bed, sofa, rug, or other similar surface. This appliance should never be placed near or over a radiator or heat register. This appliance should not be placed in a built-in installation such as a bookcase unless proper ventilation is provided.
9. This appliance should be operated only from the type of power source indicated on the marking label. If you are not sure of the type of power supplied to your home, consult your dealer or local power company. For appliance designed to operate from battery power, refer to the operating instructions.
10. This appliance system is equipped with a 3-wire grounding type plug (a plug having a third (grounding pin)). This plug will only fit into a grounding-type power outlet. This is a safety feature. If you are unable to insert the plug into the outlet, contact your electrician to replace your obsolete outlet. Do not defeat the safety purpose of the grounding plug.
11. For added protection for this product during a lightning storm, or when it is left unattended and unused for long periods of time, unplug it from the wall outlet and disconnect the antenna or cable system. This will prevent damage to the product due to lightning and power-line surges.
12. Do not allow anything to rest on the power cord. Do not locate this appliance where the cord will be abused by persons walking on it.
13. Follow all warnings and instructions marked on the appliance.
14. Do not overload wall outlets and extension cords as this can result in fire or electric shock.
15. Never push objects of any kind into this appliance through cabinet slots as they may touch dangerous voltage points or short out parts that could result in a fire or electric shock. Never spill liquid of any kind on the appliance.
16. Do not attempt to service this appliance yourself as opening or removing covers may expose you to dangerous voltage or other hazards. Refer all servicing to qualified service personnel.
17. Unplug this appliance from the wall outlet and refer servicing to qualified service personnel under the following conditions:
  - a. When the power cord or plug is damaged or frayed.
  - b. If liquid has been spilled into the appliance.
  - c. If the appliance has been exposed to rain or water.
  - d. If the appliance does not operate normally by following the operating instructions. Adjust only those controls that are covered by the operating instructions as improper adjustment of other controls may result in damage and will often require extensive work by a qualified technician to restore the appliance to normal operation.
  - e. If the appliance has been dropped or the cabinet has been damaged.
  - f. When the appliance exhibits a distinct change in performance - this indicates a need for service.
18. When replacement parts are required, be sure the service technician has used replacement parts specified by the manufacturer that have the same characteristics as the original part. Unauthorized substitutions may result in fire, electric shock, or other hazards.
19. Upon completion of any service or repairs to this appliance, ask the service technician to perform routine safety checks to determine that the appliance is in safe operating condition.

PORTABLE CART WARNING  
(symbol provided by RETAC)



S3125A

## SAFETY PRECAUTIONS (For USA & Canada)

**CAUTION**

RISK OF ELECTRIC SHOCK DO NOT OPEN

CAUTION: TO REDUCE THE RISK OF ELECTRIC SHOCK, DO NOT REMOVE COVER (OR BACK). NO USER-SERVICEABLE PARTS INSIDE. REFER SERVICING TO QUALIFIED SERVICE PERSONNEL

The lightning flash with arrowhead symbol, within an equilateral triangle, is intended to alert the user to the presence of uninsulated "dangerous voltage" within the product's enclosure that may be of sufficient magnitude to constitute a risk of electric shock to persons.

The exclamation point within an equilateral triangle is intended to alert the user to the presence of important operating and maintenance (servicing) instructions in the literature accompanying the appliance.

**WARNING:**  
TO REDUCE THE RISK OF FIRE OR ELECTRIC SHOCK, DO NOT EXPOSE THIS APPLIANCE TO RAIN OR MOISTURE.

This unit should be used with 120 V AC only.

**CAUTION:**  
To prevent electric shocks and fire hazards, DO NOT use any other power source.

**NOTE:**  
The rating plate (serial number plate) is on the rear of the unit.

**INFORMATION**

This equipment has been tested and found to comply with the limits for a Class B digital device, pursuant to Part 15 of the FCC Rules. These limits are designed to provide reasonable protection against harmful interference in a residential installation. This equipment generates, uses, and can radiate radio frequency energy and, if not installed and used in accordance with the instructions, may cause harmful interference to radio communications. However, there is no guarantee that interference will not occur in a particular installation. If this equipment does cause harmful interference to radio or television reception, which can be determined by turning the equipment off and on, the user is encouraged to try to correct the interference by one or more of the following measures:

- Reorient or relocate the receiving antenna.
- Increase the separation between the equipment and receiver.
- Connect the equipment into an outlet on a circuit different from that to which the receiver is connected.
- Consult the dealer or an experienced radio/TV technician for help.

**CAUTION**

CHANGES OR MODIFICATIONS NOT APPROVED BY JVC COULD VOID USER'S AUTHORITY TO OPERATE THE EQUIPMENT.

THIS DEVICE COMPLIES WITH PART 15 OF THE FCC RULES. OPERATION IS SUBJECT TO THE FOLLOWING TWO CONDITIONS: (1) THIS DEVICE MAY NOT CAUSE HARMFUL INTERFERENCE, AND (2) THIS DEVICE MUST ACCEPT ANY INTERFERENCE RECEIVED, INCLUDING INTERFERENCE THAT MAY CAUSE UNDESIRE OPERATION.

**ATTENTION**

RISQUE D'ELECTROCUTION NE PAS OUVRIR

ATTENTION: POUR EVITER TOUT RISQUE D'ELECTROCUTION NE PAS OUVRIR LE BOITIER. AUCUNE PIECE INTERIEURE N'EST A REGLER PAR L'UTILISATEUR. SE REFERER A UN AGENT QUALIFIE EN CAS DE PROBLEME.

Le symbole de l'éclair à l'intérieur d'un triangle équilatéral est destiné à alerter l'utilisateur sur la présence d'une "tension dangereuse" non isolée dans le boîtier du produit. Cette tension est suffisante pour provoquer l'électrocution de personnes.

Le point d'exclamation à l'intérieur d'un triangle équilatéral est destiné à alerter l'utilisateur sur la présence d'opérations d'entretien importantes au sujet desquelles des renseignements se trouvent dans le manuel d'instructions.

\* Ces symboles ne sont utilisés qu'aux Etats-Unis.

**AVERTISSEMENT:**  
POUR EVITER LES RISQUES D'INCENDIE OU D'ELECTROCUTION, NE PAS EXPOSER L'APPAREIL A L'HUMIDITE OU A LA PLUIE.

**AVERTISSEMENT:**  
Ce magnétoscope ne doit être utilisé que sur du courant alternatif en 120 V.

**AVERTISSEMENT:**  
Afin d'éviter tout risque d'incendie ou d'électrocution, ne pas utiliser d'autres sources d'alimentation électrique.

**REMARQUE:**  
La plaque d'identification (numéro de série) se trouve sur le panneau arrière de l'appareil.

**WARNING:**  
The battery used in the BR-HD50 must be replaced by a JVC authorized service dealer only.

**INFORMATION (FOR CANADA)**  
**RENSEIGNEMENT (POUR CANADA)**

This Class B digital apparatus complies with Canadian ICES-003.

Cet appareil numérique de la Class B est conforme à la norme NMB-003 du Canada.

## Supplement

This equipment is in conformity with the provisions and protection requirements of the corresponding European Directives. This equipment is designed for professional video appliances and can be used in the following environments:

- Residential (including both of the location type class 1 and 2 found in IEC 1000-2-5)
- Commercial and light industrial (including, for example, theatres)
- Urban outdoors (based on the definition of location type class 6 in IEC 1000-2-5)

In order to keep the best performance and furthermore for electromagnetic compatibility we recommend to use cables not exceeding the following lengths:

Port	Cable	Length
AUDIO	SHIELDED CABLE	10 meters
LINE	COAXIAL CABLE	10 meters
COMPONENT	COAXIAL CABLE	10 meters
Y/C	COAXIAL CABLE	10 meters
IEEE1394	SHIELDED TWIST PAIR CABLE	4.5 meters
HDMI	SHIELDED TWIST PAIR CABLE	5 meters
REMOTE	SHIELDED TWIST PAIR CABLE	5 meters

The inrush current of this apparatus is 9.0 amperes.

### Caution:

- Where there are strong electromagnetic waves or magnetism, for example near a radio or TV transmitter, transformer, motor, etc., the picture and sound may be disturbed. In such a case, please keep the apparatus away from the sources of the disturbance.

## Information for Users on Disposal of Old Equipment



**Attention:**  
This symbol is only valid in the European Union.

### [European Union]

This symbol indicates that the electrical and electronic equipment should not be disposed as general household waste at its end-of-life. Instead, the product should be handed over to the applicable collection point for the recycling of electrical and electronic equipment for proper treatment, recovery and recycling in accordance with your national legislation.

By disposing of this product correctly, you will help to conserve natural resources and will help prevent potential negative effects on the environment and human health which could otherwise be caused by inappropriate waste handling of this product. For more information about collection point and recycling of this product, please contact your local municipal office, your household waste disposal service or the shop where you purchased the product.

Penalties may be applicable for incorrect disposal of this waste, in accordance with national legislation.

### (Business users)

If you wish to dispose of this product, please visit our web page [www.jvc-europe.com](http://www.jvc-europe.com) to obtain information about the take-back of the product.

### [Other Countries outside the European Union]

If you wish to dispose of this product, please do so in accordance with applicable national legislation or other rules in your country for the treatment of old electrical and electronic equipment.

## SAFETY PRECAUTIONS (For Europe)

### Warning Notice FOR YOUR SAFETY (Australia)

1. Insert this plug into effectively earthed three-pin power outlet.
2. If any doubt exists regarding the earthing, consult a qualified electrician.
3. Extension cord, if used, must be three-core correctly wired.

### IMPORTANT (In the United Kingdom) Mains Supply (AC 230 V ~) WARNING - THIS APPARATUS MUST BE EARTHED

The wires in this mains lead are coloured in accordance with the following code:

GREEN-and-YELLOW : EARTH  
BLUE : NEUTRAL  
BROWN : LIVE

As the colours of the wires in the mains lead of this apparatus may not correspond with the coloured markings identifying the terminals in your plug, proceed as follows.

The wire which is coloured GREEN-AND-YELLOW must be connected to the terminal in the plug which is marked with the letter E or by the safety earth symbol  or coloured GREEN or GREEN-AND-YELLOW. The wire which is coloured BLUE must be connected to the terminal which is marked with the letter N or which is coloured BLACK. The wire which is coloured BROWN must be connected to the terminal which is marked with the letter L or coloured RED.

### POWER SYSTEM

#### Connection to the mains supply

This unit operates on voltage of 220 V to 240 V AC, 50 Hz/60 Hz.

**WARNING:**  
TO REDUCE THE RISK OF FIRE OR ELECTRIC SHOCK, DO NOT EXPOSE THIS APPLIANCE TO RAIN OR MOISTURE.

### CAUTION

To prevent electric shock, do not open the cabinet. No user serviceable parts inside. Refer servicing to qualified service personnel.

### Note:

The rating plate and the safety caution are on the rear of the unit.

The OPERATE button does not completely shut off mains power from the unit, but switches operating current on and off.

### WARNING

It should be noted that it may be unlawful to re-record pre-recorded tapes, records, or discs without the consent of the owner of copyright in the sound or video recording, broadcast, or cable programme and in any literary, dramatic, musical or artistic work embodied therein.

### Caution for AC Mains Lead

#### FOR YOUR SAFETY PLEASE READ THE FOLLOWING TEXT CAREFULLY.

This product is equipped with 2 types of AC cable. One is for continental Europe, etc. and the other one is only for U.K. Appropriate mains cable must be used in each local area, since the other type of mains cable is not suitable.

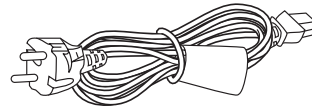
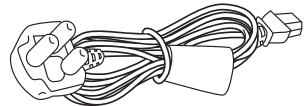
FOR CONTINENTAL EUROPE, ETC.	FOR U.K. ONLY
Not to be used in the U.K.	If the plug supplied is not suitable for your socket outlet, it should be cut off and appropriate one fitted.
	

## Thank you for purchasing our HD Video

### Cassette Recorder BR-HD50

This instruction manual was made for the BR-HD50U and the BR-HD50E.

Items only applicable to BR-HD50U are labeled "U model only" or "U only".

Items only applicable to BR-HD50E are labeled "E model only" or "E only".

This is an HDV/DV format video cassette recorder. Video cassettes with the **HDV** or **DV** logo can be used with it. DVCAM cassettes can be recorded in the HDV/DV format.

## MAIN FEATURES

### ● HDV 720p format

Records and plays back HD (High-Definition) video with 720 effective scanlines (progressive scan).

This unit records 720/24p/25p/30p, 480/60p, and 576/50p HDV signals from an IEEE1394 terminal. 24p video has the same frame count as movie film.

### ● Compatible with DV format

Compatible with DV format for digitally recording SD (Standard-Definition) video.

### ● Compatible mechanism for standard/mini DV cassettes

Records and plays back HDV or DV format on standard and mini size DV cassettes.

(SP mode only)

DVCAM cassettes can be recorded in HDV or DV format.

Tapes recorded in the DVCAM format can only be played.

### ● Equipped with IEEE1394 terminal

Inputs and outputs HDV signals, DV signals, and digital audio. Capable of exchanging digital signals with IEEE1394 compatible equipment.

### ● Compatible with 60Hz/50Hz HD signal format

Compatible with both 60Hz and 50Hz HD signal formats. Select this on the Menu screen.

### ● Equipped with HDMI terminal

Outputs digital video and digital audio.

View HD video on monitors with an HDMI terminal.

### ● Equipped with COMPONENT OUT terminal

Outputs HD/SD analog video.

View HD video on HD-compatible monitors with a COMPONENT input terminal.

### ● Outputs cross-converted video

During HDV/DV signal input or playback, format converted video can be output from the HDMI terminal or COMPONENT OUT terminal. Select the output video on the Menu screen.

### ● Equipped with composite and Y/C input/output terminals

Inputs and outputs analog video. Analog video is recorded in the DV format.

### ● RS-422A compatible

Connect this unit with the RS-422A compatible RM-G820 edit controller, and use this unit as a player.

This can also be connected to RS-422A compatible non-linear editing machines.

### ● Equipped with SERIAL REMOTE terminal

Connect to a wired remote controller for remote operation of this unit. Or, connect with a foot switch used for recording operations.

### ● Recording and playback of time codes

#### ● Backup recording function

With the combined use of other DV machines, long-time continuous recording is possible.

#### ● Multi-cue up

Up to 5 points of the tape position can be registered and cued up.

#### ● Index/blank search function

It can search for positions where index signals are recorded and unrecorded parts.

#### ● Repeat play function

There are 3 types of repeat function. (INDEX/ V.END/ TAPE END)

HDV and **HDV** are trademarks of the Sony Corporation and the Victor Company of Japan, Limited.  
DVCAM is a trademark of the Sony Corporation.

## Table of Contents

### INTRODUCTION

Remarks of usage.....	4
Cassette tape.....	5
HDV and DV format.....	6
Regular maintenance.....	8
Cleaning tape.....	9
Condensation.....	9

### NAMES AND FUNCTIONS OF PARTS

Front panel.....	10
Rear panel.....	16

### ON-SCREEN DISPLAY

On-screen display.....	20
Status display.....	21
Event/Alarm display.....	24

### CONNECTION

Connecting video signals.....	26
Connecting audio signals.....	28
Attaching the supplied ferrite core.....	29
Connecting with SERIAL REMOTE terminals.....	30
Connecting the AC adapter.....	31

### RECORDING/OUTPUT SIGNAL FORMAT

Inputting analog signal.....	32
Inputting digital signal.....	33
Playback.....	34

### PREPARATION

Turning on/off the power.....	35
Operation method (main unit/remote controller) and OPERATION LOCK mode.....	36
Loading/Ejecting cassette.....	37
Setting/Displaying date and time.....	38
Selecting HD signal format.....	40

### RECORDING

Settings for analog signal input.....	41
Settings for digital signal input.....	42
Adjusting audio recording level.....	44
Recording procedure.....	46
Backup recording function.....	47
Recording with SERIAL REMOTE terminals.....	48

### PLAYBACK

Playback settings.....	49
Basic playback procedure.....	51
Special playback functions.....	52
Search function.....	54
Repeat playback.....	55
Multi cue-up.....	56

### TIME CODE

Displaying the time code.....	58
Presetting the time code.....	59
Recording the time code.....	60
Playing back the time code.....	62

### EDIT

Using a non-linear editing system.....	63
--	----

### MENU SCREENS

Setting the menus.....	64
Structure of the Menu screens.....	66
Description of the Menu screens.....	67

### OTHERS

Warning display.....	79
Troubleshooting.....	81
Checking the hour meter.....	83
Specifications.....	84
Supplement.....	86

## INTRODUCTION

### Remarks of usage

#### ■ Place of storage and use

Avoid storing or using this VCR in the following places:

- Excessively hot or cold places beyond the allowable temperature for operation (5°C – 40°C).
- Humid or dry places beyond the allowable humidity range for operation (30% – 80% RH).
- Dusty or sandy places.
- Places exposed to oil, smoke or steam, such as the kitchen vicinity.
- Intensely vibrating or unstable places.
- Places prone to condensation.
- Places that generate strong magnetic fields, e.g., near a transformer or motor.
- Places near devices that generate electric waves, e.g., a transceiver or mobile phone.
- Places that generate X-ray radiation or corrosive gases.

Also do not leave the unit for long hours in a parked car under direct sunlight or near room heating equipment.

#### ■ Handling the unit

- Do not place heavy objects on the unit, like a monitor or TV.
- Do not insert foreign objects into the cassette slot.
- Mind your finger when loading a cassette tape.  
Be careful not to get your fingers clamped when loading the cassette to prevent injury.
- Place this unit out of reach of young children to prevent injury as fingers may get clamped while a cassette tape is being loaded.
- Do not block the ventilation openings on the rear panel.
- Avoid strong impact to the unit. Do not drop the unit.
- Remove the cassette tape from the cassette slot when transporting the unit.
- Remove the AC adapter to save energy when the unit is not in use.

#### ■ Maintaining the unit (Turn off the power before performing maintenance work.)

Wipe the unit with a soft cloth.

Do not wipe it with thinner or benzene as it may melt or tarnish the unit surface.

For stubborn stains, use water-diluted neutral detergent and then wipe it dry.

#### ■ Always use the supplied AC adapter.

Failure to do so can cause mechanical breakdown or electric shock.

#### ■ Use the supplied power cord.

Using a different type or damaged cord may cause fire or electric shock.

#### ■ Do not use the supplied power cord for other models.

- When making an important recording, do not record within the two or three minutes at the beginning or end of the tape.
- Recorded video (sound) is meant for personal entertainment only and must not be used for other purposes without the prior consent of the copyright owner.
- JVC shall not guarantee the quality of recording and playback should BR-HD50 fail to function normally due to defects, either of the unit itself or the video cassette tapes.

### Cassette tape

BR-HD50 can record onto and playback standard DV and mini DV cassette tapes (for SP mode only).

Use the following JVC cassettes with the **DV** or **Mini DV** the logo.

#### ● Standard DV cassettes

LA-DV276  
LA-DV186  
LA-DV124

#### ● Mini DV cassettes

M-DV63PRO  
M-DV63HD

#### — Memo

- DVCAM cassette can be recorded in the HDV or DV format.
- Tapes recorded in the DVCAM format can be played (SP Mode).
- M-DV80 cassettes (mini DV 80min tape) cannot be used with this unit.

#### ■ Erasure prevention

DV cassettes have a safety slide at the back to prevent accidental erasure.

- To prevent accidental erasure of important records, push the slide to the "SAVE" position.
- To record, push the slide to the "REC" position.

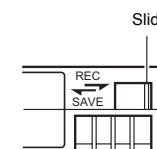

#### Remarks on the use of tape

- Do not load the videotape in the wrong direction.
- Store the tape only after it has been fully rewound, so as to avoid damaging the tape.
- Store the cassette in places low in humidity, well-ventilated and fungus-proof.
- When a cassette tape is used repeatedly, noise may increase due to e.g., dropout, etc. hence affecting its performance. Do not use dirty or damaged tapes as they will shorten the life span of the rotation head.

#### ■ For recording and storing videotapes in the best condition

Observe the following instructions for the best recording and storage of videotapes.

- Take care of the conditions of handling videotapes.

It is recommended that you record and store videotapes in the environment below.

	Recording	Storage	
		Short period (Up to 10 years)	Long period (Over 10 years)
Temperature	17°C to 25°C	15°C to 23°C	15°C to 19°C
Humidity	30% to 70%	40% to 55%	25% to 35%
Hourly temperature change	Less than 10°C	-	-
Hourly humidity change	Less than 10%	-	-

- Do not leave the videotapes neglected for a long period.  
If videotapes are left wound for a long period of time, it may result in distortion of the tape. Also it may cause tape-to-tape adhesion (known as blocking). It is recommended that videotapes be unspooled and rewound once a year for refreshing.
- When tapes are not in use, store them in cases and on end.  
Storage cases protect videotapes from humidity, dust and ultraviolet. Keep tapes in cases and do not store them lying flat. When housed in a horizontal position, pressure from other tapes can cause distortions and deformations of the tape edges.

# INTRODUCTION

## HDV and DV format

This unit records in HDV or DV format.

DV format is a standard for recording SD (Standard-Definition) video onto DV cassettes or mini DV cassettes.

HDV format is a standard for recording HD (High-Definition) video onto DV cassettes or mini DV cassettes.

The two HDV recording formats are HDV 720p and HDV 1080i.

HDV 720p : 720p (720 effective scanlines, progressive scan)

HDV 1080i : 1080i (1080 effective scanlines, interlace scan)

This unit supports the HDV 720p format.

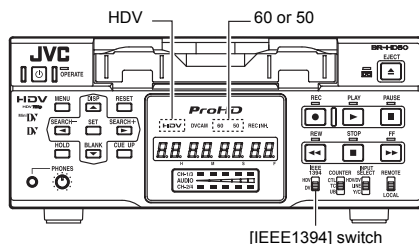

### HDV and DV signal input/output

HDV signals and DV signals are input/output from the IEEE1394 terminal.

HDV signals from the IEEE1394 terminal are recorded in HDV format.

DV signals from the IEEE1394 terminal are recorded in DV format.

Recorded HDV signals or DV signals are output from the IEEE1394 terminal during playback.

Digital audio is also input/output from the IEEE1394 terminal, together with HDV signals or DV signals.

The front panel IEEE1394 switch must be set on the front panel, according to whether the input/output signal from the IEEE1394 terminal is in HDV format or DV format.

When the input signal or playback signal is in HDV format, the front panel HDV display is lit.

Analog signal input is digitally converted and recorded in DV format.

### HD signal format

This unit is compatible with both 60Hz and 50Hz HD signal formats. The HDV signal format must be set on this unit, according to whether the input/playback HD signal format is 60Hz or 50Hz.

(Set this using 60/50 SEL in the SYSTEM [2/2] Menu screen.)

Menu settings on this unit can be checked by whether the front panel 60 or 50 indicator light is lit.

The field frequency for DV signals and analog signals is fixed by region.

[U model: 60Hz (NTSC), E model: 50Hz (PAL)]

### HDV (720p) and DV format

	HDV 720p format	DV format
Video signal *1	60Hz:720/30p, 720/24p, 480/60p 50Hz:720/25p, 576/50p	U (NTSC) : 480/60i E (PAL) : 576/50i
Pixel count	1280 × 720 720 × 480 (480/60p) 720 × 576 (576/50p)	U (NTSC) : 720 × 480 E (PAL) : 720 × 576
Aspect ratio	16:9	4:3 (16:9)
Video compression format	MPEG-2 Video (Profile & level: MP@H-14)	DV
Bit rate after compression	About 19 Mbps	About 25 Mbps
Audio compression format	MPEG1 Audio Layer II	Linear PCM
Audio channels	2CH (48 kHz, 16 bit)	2CH (48 kHz, 16 bit) 4CH (32 kHz, 12 bit) *2

\*1 : For HDV/DV signals, the unit records the same signals as the input signals.

\*2 : During analog audio input, only CH1/CH2 are recorded.

### Viewing video signal display (Example)

720/30p: 720 effective scanlines, 30-frame progressive scan

480/60i: 480 effective scanlines, 60-field interlace scan

### Recording time

The recording/playback speed for HDV format is SP mode only.

Though DV format recording and playback speed has SP and LP modes, this unit supports SP mode only.

The cassette recording time is the same for HDV and DV format.

Standard DV cassettes	Recording time
LA-DV276	About 276 minutes
LA-DV186	About 186 minutes
LA-DV124	About 124 minutes

Mini DV cassettes	Recording time
M-DV63PRO	About 63 minutes
M-DV63HD	About 63 minutes

### HD video output

HD video is output from the HDMI OUT terminal and the COMPONENT OUT terminal.

HDMI OUT terminal : Outputs HD/SD digital video and digital audio.

This is connected to a monitor with an HDMI terminal.  
(HDMI : High Definition Multimedia Interface)

COMPONENT OUT terminal: Outputs HD/SD analog video. Does not output audio.

This is connected to an HD-compatible monitor with COMPONENT input terminal.

- The video format to output from the HDMI OUT terminal and the COMPONENT OUT terminal can be selected using OUT FORMAT [60]/OUT FORMAT [50] in the VIDEO Menu screen.

# INTRODUCTION

## Regular maintenance

This unit uses consumables or components that will wear off. If a worn-out or deteriorated component continues to be used, it may cause the unit to break down. To prevent this, perform routine maintenance using the head-cleaning tape. With the head-cleaning tape alone, however, the entire tape-winding mechanism cannot be completely cleaned.

Perform regular maintenance of the components as shown below.

### Regular maintenance

The tasks of maintenance involved are similar to that of replacing the engine oil or tire of a car. Depending on the number of usage hours, inspect or replace the components as follows:

Number of hours	500H	1000H	1500H	2000H	
Drum assembly (including head)	○	☆	☆	●	○ : Cleaning, inspection and adjustment
Tape guide, roller	○	☆	☆	●	☆ : Cleaning and inspection; Replacement if necessary
Belt gears	—	☆	☆	●	● : Replacement
Drive system parts	—	—	☆	●	<b>Work and frequency of maintenance depend on the environment and usage. The above information serves only as a guide.</b>

### Usage Time

: You can check the drum usage time with the hour meter display. For details, refer to page 83, "Checking the hour meter".

### Maintenance consultation

: For details on the maintenance plan and fee, consult with your JVC-authorized service agent.

### Head cleaning

- Recording or playing back with a dirty head will result in block noise or disrupted sound. Perform regular head cleaning to maintain superior image and sound quality.
- If the head is dusty, "HEAD CLEANING REQUIRED!" will be displayed on the monitor when this unit plays a tape.



Block Noise

- For information on how to use the head cleaning tape and the relevant remarks, refer to page 9, "Cleaning tape".

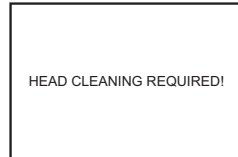

## Cleaning tape

Use a JVC cleaning tape.

Follow the instructions below for using the cleaning tape.

- Run the tape for 10 seconds in the PLAY mode. (Thereafter, it stops automatically and enters the STOP mode.)
  - After loading the cleaning tape, press the PLAY button.
- For a single cleaning session, it can be repeated up to 4 times.
- Refer to the following table as a guide for cleaning.

### Note

- Under low humidity conditions, (10% RH to 30% RH), perform head cleaning at intervals of half of the periods stated in the table.
- If an M-DV80 tape is used immediately after cleaning, the message, "HEAD CLEANING REQUIRED!" may not disappear. It does only after the tape has run for some time.
- Use the cleaning tape at room temperature (10°C to 35°C).
- Instructions for using the cleaning tape stated on a sheet inside its storage case may be different in part from those stated here. Follow the instructions in this manual.

Operating environment	Low temperature 5°C to 10°C	Room temperature 10°C to 35°C	High temperature 35°C to 40°C
Frequency of cleaning	1 to 2 times every 5 hours	1 to 2 times every 20 to 30 hours	1 to 2 times every 5 hours

## Condensation

- When this unit is moved from a cold to a warm place abruptly, the vapor in the warm air will come into contact with the head drum or the tape guides, which are not warmed enough. When chilled, the vapor turns into droplets of water. This state is known as condensation. When condensation occurs, the videotape adheres to the head drum or the tape guides and will be damaged.
- Condensation occurs on this unit in the following circumstances:
  - It is moved abruptly from a cold place to a warm place.
  - It is used in a place immediately after the heater has been turned on, or when cold breeze from an air-conditioner blows onto it.
  - It is used at a place of high humidity.
- When condensation occurs, the monitor displays the following warning:
 

CONDENSATION ON DRUM
- Prevention of condensation
  - When transporting BR-HD50 from a cold to a warmer place abruptly, first remove the cassette tape. Then place BR-HD50 in a plastic bag and seal it before transporting. Take out BR-HD50 from the sealed plastic bag only after it has the same temperature as the surroundings.

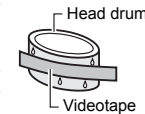

When a cassette tape is loaded, do not transport e.g., from a cold outdoor place to a warm room thus subjecting the unit to drastic temperature changes. After moving the unit, do not use it until the inner mechanism stabilizes.

# NAMES AND FUNCTIONS OF PARTS

## Front panel

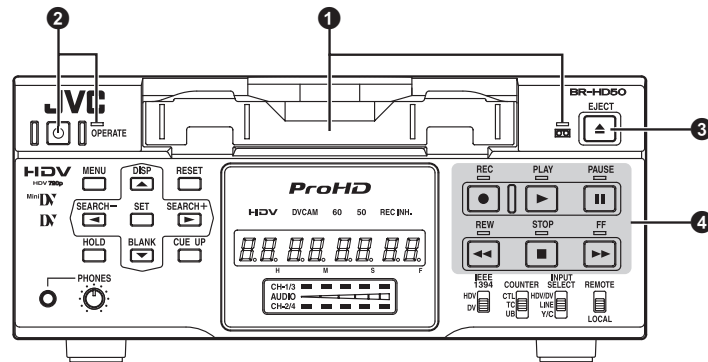

### 1 [Cassette loading slot]/LED

- For loading a cassette into or unloading it from the slot.  
Insert a standard DV cassette or a mini DV cassette. (Page 37)
- When BR-HD50 is in the OPERATE OFF state and a cassette is loaded, it changes to the OPERATE ON state.
- With a cassette loaded, the LED lights up in green.  
When a cassette is being loaded or ejected, the LED flashes.

### 2 [OPERATE] button/LED

- Press this button to turn on the power and BR-HD50 becomes ready for operation. (OPERATE ON)  
Press this button again when BR-HD50 is already on to turn off the power. (OPERATE OFF)
- OPERATE LED lights up as follows.  
OPERATE ON : the green LED lights up  
OPERATE OFF : the red LED lights up  
VCR error : the red LED blinks

### — Memo

- If DC IN MODE in the SYSTEM [2/2] Menu screen is set to "OPE ON", and power is supplied to the DC IN terminal on the rear panel, power is turned on and the unit enters OPERATE ON mode without pressing this button.
- Even after the power is turned off with this button, BR-HD50 is live with a small amount of electricity.  
Therefore, if BR-HD50 is not to be used for a long period of time, please remove the AC adapter to save energy.

### 3 [EJECT] button

- Press this button to eject the cassette.

### — Memo

- It takes about 6 seconds for the cassette to be ejected.
- The cassette can be ejected even when BR-HD50 is in the OPERATE OFF mode. After the eject action is completed, BR-HD50 returns to the OPERATE OFF mode.

### 4 [Operation buttons]

#### ■ [REC] button/LED

- Hold down this button and press the PLAY button to start recording. During recording, the red LED lights up.
- Hold down this button and press the PAUSE button to pause recording.
- If this button is pressed during recording, an index signal is recorded on the tape (when INDEX WRITE in the SYSTEM [2/2] Menu screen is set to ON).
- When this button is pressed in the STOP mode, the time code generator value can be checked while the button is being held down. If TC DUPLI.: DV Menu is set to AUTO, the time code, date and time of the IEEE1394 terminal can be checked. (In DV mode only)

#### ■ [PLAY] button/LED

- Press this button to start playing back a tape. During playback, the green LED lights up.
- When recording is paused, press this button to resume recording.

#### ■ [PAUSE] button/LED

- During recording, press this button to pause it.
- In the PLAYBACK or STOP mode, press this button to enter the STILL mode. In the RECORDING PAUSE or STILL mode, the green LED lights up.
- When BR-HD50 is in the STILL mode, press this button for frame advance playback. (In DV mode only)

### — Memo

Still images or images in frame advance can be selected with STL/F.ADV: DV of the SYSTEM [1/2] Menu screen.

#### ■ [FF] button/LED

- When BR-HD50 enters the STOP mode, press this button to fast-forward the tape.
- When BR-HD50 is in the PLAYBACK or STILL mode, press this button for fast-forward playback. The fast forward playback speed can be changed by pressing the SEARCH+/▶ button (B) or the SEARCH-/◀ button (when "◀, ▶" KEY FUNC. in the SYSTEM [1/2] Menu screen is set to VAR/REC.V. (Page 53 "Slow playback and Search mode")
- During fast-forwarding or fast-forward playback, the LED lights up in green.

#### ■ [STOP] button/LED

- Press this button to stop operation.
- When BR-HD50 is in the STANDBY-OFF mode, press this button to enter the STANDBY-ON mode.
- While stopped, the LED lights green.

### — Memo

There are two stop modes.

- STANDBY-OFF: For protecting the tape and the drum, the drum does not rotate.
- STANDBY-ON: The drum rotates so that it starts up faster after BR-HD50 moves into another mode.

#### ■ [REW] button/LED

- When BR-HD50 enters the STOP mode, press this button to rewind the tape.
- When BR-HD50 is in the PLAYBACK or STILL mode, press this button for reverse playback. The rewind playback speed can be changed by pressing the SEARCH+/▶ button (B) or the SEARCH-/◀ button (when "◀, ▶" KEY FUNC. in the SYSTEM [1/2] Menu screen is set to VAR/REC.V. (Page 53 "Slow playback and Search mode")
- During rewinding or rewind playback, the LED lights up in green.



## NAMES AND FUNCTIONS OF PARTS

### Front panel (continued)

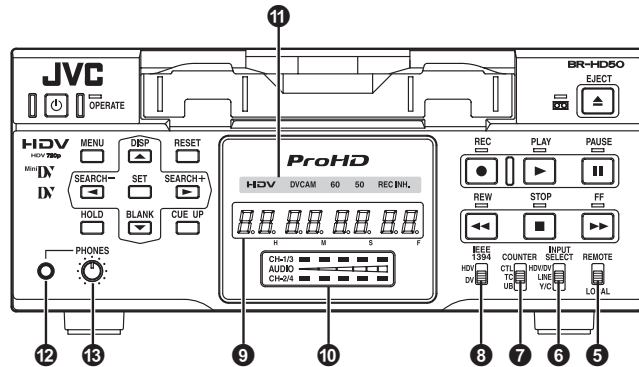

#### 5 [REMOTE/LOCAL] switch

This switch is used to select how BR-HD50 is to be operated.

**LOCAL** : Use this setting if BR-HD50 is to be controlled with the key operation of the unit.

**REMOTE** : Use this setting to control this unit using the REMOTE terminal, SERIAL REMOTE terminal, or IEEE1394 terminal.

#### — Memo

- Select to enable/disable operation with the REMOTE terminal, using REMOTE SEL 9P on the REMOTE [1/2] Menu screen.
- To control BR-HD50 with the SERIAL REMOTE terminal or IEEE1394 terminal, this switch setting can be set up with REMOTE SEL SERIAL or REM SEL HDV/DV in the REMOTE [1/2] Menu screen. (Page 70)
- If it is set to REMOTE, the buttons that can be operated from the unit are selectable from LOCAL FUNCTION in the REMOTE [1/2] Menu screen.

#### 6 [INPUT SELECT] switch

This switch is used to select input signals.

**HDV/DV** : Inputs IEEE1394 terminal HDV signals or DV signals.

The 8 IEEE1394 switch needs to be set, according to whether the video format is HDV or DV.

**LINE** : For inputting the composite images of the LINE IN terminal and analog audio signals.

**Y/C** : For inputting the Y/C separate video signal of the Y/C IN terminal and analog audio signals.

#### — Note

- Switching is invalid during recording.
- Switching this switch during playback may briefly cut off the audio.

#### 7 [COUNTER] switch

Switches the displayed information on the 9 counter display and the monitor counter display.

**CTL** : It displays the counter in hour, minute, second and frame based on CTL (control signal).

**TC** : It displays the time code data.

**UB** : It displays the user's bit (UB).

#### 8 [IEEE1394] IEEE1394 terminal switch

Set this switch according to the video format of the IEEE1394 input signal and playback signal. When the video format is HDV, 11 HDV indicator is lit.

**HDV** : Use this setting when the video format is HDV (HDV indicator is lit).

**DV** : Use this setting when the video format is DV (HDV indicator is off).

#### — Note

- Video and audio recording and playback using the IEEE1394 terminal are unavailable when the switch setting differs from the video format.
- When the IEEE1394 terminal is used to input/output video or audio signals with a non-linear editing system, and the format is changed by switching this switch, either reconnect the IEEE1394 cable, or use the OPERATE button to reset the power.

#### 9 Counter display

Displays the counter, menu settings, and operation mode. (8 digits)

- Counter display
  - The displayed contents can be selected using the 7 COUNTER switch.
  - For menu settings, menu code numbers are displayed.

#### 10 Audio level indicator

Displays the audio level for CH-1/3 and CH-2/4.

In RECORDING mode, audio recording level is displayed. In PLAY mode, audio playback level is displayed.

Only the audio recording level during analog input can be adjusted.

#### 11 Indicator lights

##### ■ [HDV] indicator light

Lights when the video format for the IEEE1394 terminal input signal or playback signal is HDV. When this indicator is lit, set the 8 IEEE1394 switch to HDV.

When this indicator is off, set the 8 IEEE1394 switch to DV.

##### ■ [DVCAM] indicator light

Lights when playing a tape recorded in DVCAM format.

Only tapes recorded in SP mode can be played.

##### ■ [60] indicator light

Lights when 60/50 SEL in the SYSTEM [2/2] Menu screen is set to 60.

The HD signal format on this unit is set to 60Hz.

##### ■ [50] indicator light

Lights when 60/50 SEL in the SYSTEM [2/2] Menu screen is set to 50.

The HD signal format on this unit is set to 50Hz.

#### — Memo

The field frequency for DV signals and analog signals are fixed by region.

(U model: 60Hz, E model: 50Hz)

##### ■ [REC INH] indicator light

Lights upon loading a cassette that cannot be recorded.

#### 12 [PHONES] terminal

This is the mini jack terminal for connecting to the headphone. (Stereo ø3.5)

- When playing back tapes recorded in 32kHz mode, the audio channel output from this terminal is selected using A.OUTPUT: DV on the AUDIO Menu screen.

#### 13 [PHONES] Headphone volume

Use this switch to adjust the output level of the PHONES terminal.

Both channels are adjusted at the same time.

## NAMES AND FUNCTIONS OF PARTS

### Front panel (continued)

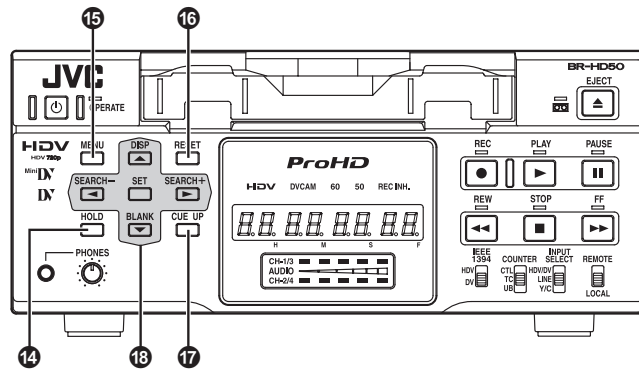

#### 14 [HOLD] button

Pressing this button while stopped will engage the time code and user's bit PRESET mode. (When TCG SELECT in the TC/UB/CLOCK [1/2] Menu screen is set to PRESET) In time code PRESET mode, press this button to return to the normal display. (Page 59 "Presetting the time code")

#### 15 [MENU] button

If this button is pressed in the STOP/STILL mode or when no cassette is loaded, the menu is displayed on the monitor connected to the video output terminal (LINE OUT, Y/C OUT, COMPONENT OUT, or HDMI OUT terminal). The counter display shows menu code numbers.

When the menu is displayed, press this button to return to the normal display. (Page 64 "Setting the menus")

#### 16 [RESET] button

- To reset the CTL counter display to "00", press this button.
- If this button is pressed when the time code preset screen is displayed, all the digits of the time code or the user's bit are reset to "00".
- When the Multi Cue-up screen is displayed, press this button to clear the registered cue-up points.

#### 17 [CUE UP] button

When the 7 COUNTER switch is set to TC, press this button to display the Multi Cue-up screen on the monitor.

When the Multi-Cue-up screen is displayed, press this button to start searching the selected tape position.

(Page 56 "Multi cue-up")

#### 18 Special functions/Setting buttons

The following buttons have different functions depending on whether the normal screen or the setting screen is displayed.

##### Setting screens:

Menu, Date/Time setting, Time code preset and Multi Cue-up

#### ■ [DISP/▲] button

- Press this button during PLAY mode to display the video output format on the counter display.
- During the STOP or REC mode, the audio recording level is increased. (Pressing simultaneously with ◀ or ▶ button) (When ◀, ▶ KEY FUNC. in the SYSTEM [1/2] Menu screen is set to VAR/RECV) (Page 44 "Adjusting audio recording level")
- When the setting screen is displayed, this button is used to select the items or setting.

#### ■ [BLANK/▼] button

- When BR-HD50 is in the STOP mode, press this button to start blank search. It searches the unrecorded part of the tape and goes into the still mode. (Page 54 "Blank search")
- During the STOP or REC mode, the audio recording level is decreased. (Pressing simultaneously with ◀ or ▶ button) (When ◀, ▶ KEY FUNC. in the SYSTEM [1/2] Menu screen is set to VAR/RECV) (Page 44 "Adjusting audio recording level")
- When the setting screen is displayed, this button is used to select the items or setting.

#### ■ [SEARCH+/▶] button

- During normal display, the function of this button can be selected using ◀, ▶ KEY FUNC. in the SYSTEM [1/2] Menu screen. If it is set to VAR/RECV, the searching speed increases if this button is pressed during a search operation. (Page 53 "Slow playback and Search mode")
- If it is set to INDEX, press this button to start forward index search. This function is not effective during recording or recording pause. (Page 54 "Index search")
- During the STOP or REC mode, CH2 is selected as the channel for adjusting the audio recording level. (When ◀, ▶ KEY FUNC. in the SYSTEM [1/2] Menu screen is set to VAR/RECV) (Page 44 "Adjusting audio recording level")
- When the setting screen is displayed, this button is used to select items or setting digits.

#### ■ [SEARCH-/◀] button

- During normal display, the function of this button can be selected using ◀, ▶ KEY FUNC. in the SYSTEM [1/2] Menu screen. If it is set to VAR/RECV, the searching speed decreases if this button is pressed during a search operation. (Page 53 "Slow playback and Search mode")
  - If it is set to INDEX, press this button to start reverse index search. This function is not effective during recording or recording pause. (Page 54 "Index search")
  - During the STOP or REC mode, CH1 is selected as the channel for adjusting the audio recording level. (When ◀, ▶ KEY FUNC. in the SYSTEM [1/2] Menu screen is set to VAR/RECV) (Page 44 "Adjusting audio recording level")
  - When the setting screen is displayed, this button is used to return to the previous menu or select setting digits.
- #### ■ [SET] button
- When the Menu screen, Date/Time setting screen or the Multi Cue-up screen is displayed, press this button to confirm the setting.
  - In time code PRESET mode, press this button to preset the set time codes or user's bit to the time code generator.

## NAMES AND FUNCTIONS OF PARTS

### Rear panel

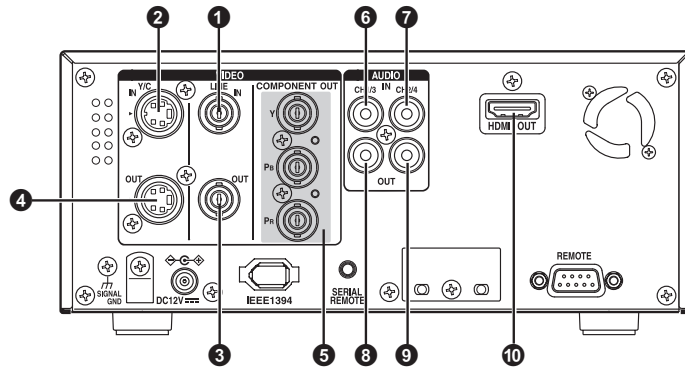

#### 1 [VIDEO LINE IN] terminal (BNC)

This is the input terminal for composite video signals.

- To input video via this terminal, set the INPUT SELECT switch located on the front panel to "LINE".

#### 2 [VIDEO Y/C IN] terminal (4-PIN)

This is the input terminal for Y/C separate video signals.

- To input video via this terminal, set the INPUT SELECT switch located on the front panel to "Y/C".
- When wide-screen ID signals are input, the wide-screen ID signal is recorded.

#### 3 [VIDEO LINE OUT] terminal (BNC)

This is the output terminal for composite video signals.

- It displays the Menu setting screen, Date/Time setting screen and warning information.
- If DISPLAY in the DISPLAY Menu screen is set to "ON" or "AUTO", information will be displayed on-screen, e.g., the operation mode, date/time and counter. (☞ Page 20)
- When the input signal or playback signal is in HDV format, this terminal outputs video that is converted down to 480i or 576i. Select the style for displaying down-converted video on a monitor screen with a 4:3 aspect ratio, using DOWN CONV. MODE on the VIDEO Menu screen. (☞ Page 74)

#### 4 [VIDEO Y/C OUT] terminal (4-PIN)

This is the output terminal for Y/C separate video signals.

- It displays the Menu setting screen, Date/Time setting screen and warning information.
- If DISPLAY in the DISPLAY Menu screen is set to "ON" or "AUTO", information will be displayed on-screen, e.g., the operation mode, date/time and counter. (☞ Page 20)
- When the input signal or playback signal is in HDV format, this terminal outputs video that is converted down to 480i or 576i. Select the style for displaying down-converted video on a monitor screen with a 4:3 aspect ratio, using DOWN CONV. MODE on the VIDEO Menu screen. (☞ Page 74)
- When tapes that have recorded wide-screen signals are played back, the wide-screen ID signal is output. When playing back an HDV recorded tape, wide-screen ID signals are output according to the mode set using DOWN CONV. MODE in the VIDEO Menu screen.

#### — Memo

Whether or not to enable SET UP for analog signals (composite, Y/C separate and component signals) can be selected with SET UP [60]: DV in the VIDEO Menu screen (for U model only).

#### 5 [COMPONENT OUT] Component signal output terminal (BNC×3)

Output terminal for component video signals (Y/Pb/Pr). Outputs analog HD/SD video. Connect this to an HD-compatible monitor with a COMPONENT IN terminal.

- The video format to output from this terminal can be selected using OUT FORMAT [60]/[50] in the VIDEO Menu screen. (☞ Page 73, 74)
- It displays the Menu setting screen, Date/Time setting screen and warning information.
- If DISPLAY in the DISPLAY Menu screen is set to "ON" or "AUTO", information will be displayed on-screen, e.g., the operation mode, date/time and counter. (☞ Page 20)

#### 6 [CH1 AUDIO IN] terminal (RCA)

Use this terminal to input analog audio signals.

To enable audio input via this terminal, set the INPUT SELECT switch located on the front panel to "LINE" or "Y/C".

Analog signals are recorded on CH1.

#### 7 [CH2 AUDIO IN] terminal (RCA)

Use this terminal to input analog audio signals.

To enable audio input via this terminal, set the INPUT SELECT switch located on the front panel to "LINE" or "Y/C".

Analog signals are recorded on CH2.

#### 8 [CH1/3 AUDIO OUT] terminal (RCA)

Use this terminal to output analog audio signals.

- In the 48kHz audio mode, it outputs the sound of CH1.
- The output audio channel during playback of tapes recorded in 32kHz audio mode, or the EE audio channel during DV signal input in 32kHz audio mode, can be selected using A.OUTPUT: DV in the AUDIO Menu screen. (☞ Page 72)

#### 9 [CH2/4 AUDIO OUT] terminal (RCA)

Use this terminal to output analog audio signals.

- In the 48kHz audio mode, it outputs the sound of CH2.
- The output audio channel during playback of tapes recorded in 32kHz audio mode, or the EE audio channel during DV signal input in 32kHz audio mode, can be selected using A.OUTPUT: DV in the AUDIO Menu screen. (☞ Page 72)

#### 10 [HDMI OUT] HDMI signal output terminal

Outputs HDMI signals. (HDMI : High Definition Multimedia Interface)

Outputs digital HD/SD video and digital audio.

This is connected to a monitor with an HDMI terminal.

- The video format to output from this terminal can be selected using OUT FORMAT [60]/[50] and MONITOR SELECT in the VIDEO Menu screen. (☞ Page 73, 74)

It displays the Menu setting screen, Date/Time setting screen and warning information.

- If DISPLAY in the DISPLAY Menu screen is set to "ON" or "AUTO", information will be displayed on-screen, e.g., the operation mode, date/time and counter. (☞ Page 20)

#### — Memo

- Video is not displayed when the connected monitor does not support the video format selected using OUT FORMAT [60]/[50] in the VIDEO Menu screen. If this occurs, set MONITOR SELECT to HDMI[A].
- If the monitor has a DVI-D terminal that supports HDCP, you can watch digital video by connecting an HDMI↔DVI-D cable.
- When the video format of the IEEE1394 input signal differs from the IEEE1394 switch, or INPUT SELECT switch is set to HDV/DV and a signal is not input into the IEEE1394 terminal, no signal is output from the HDMI OUT terminal. ("no 1394" is displayed on the counter display.) Similarly, no signal is output from the HDMI OUT terminal when a blank cassette tape is played. ("-----" is displayed on the counter display.)

## NAMES AND FUNCTIONS OF PARTS

### Rear panel (continued)

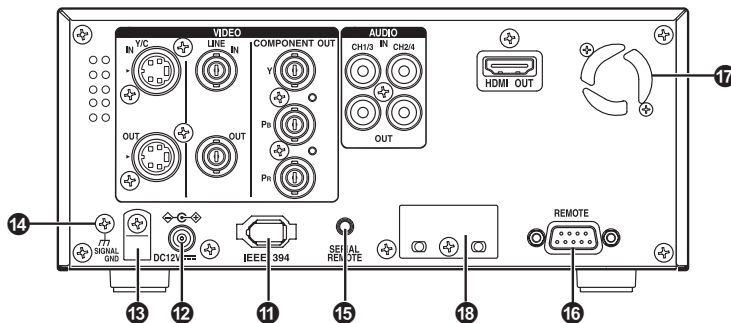

#### 11 [IEEE1394] IEEE1394 terminal (6P)

This is the input/output terminal for IEEE1394-compliant digital signals.

Inputs HDV signals or DV signals when recording. Digital audio is input simultaneously.

During playback, it outputs HDV signals, DV signals, and digital audio on the playback tape. Upon analog signal input, EE images and EE audio are output. EE images are DV format signals (480i or 576i) (Only when IEEE1394 switch is set to DV).

- This unit records and plays 720p format HDV signals. 720p HDV signals and DV signals from this terminal are recorded as is, without format conversion.
- To enable signal input via this terminal, set the INPUT SELECT switch located on the front panel to "HDV/DV".
- The IEEE1394 switch located on the front panel must be set to "HDV" or "DV", according to the input signal to this terminal or the video format of the playback tape.
- The audio mode (48kHz or 32kHz) cannot be changed for the input audio signal via this terminal. It will be recorded using the input signal audio mode. 4-channel recording is possible in the 32kHz audio mode.
- Power cannot be supplied via this terminal.

- To record a time code via this terminal, set TC DUPLI.: DV in the TC/UB/CLOCK [1/2] Menu screen to AUTO or NONDROP. (In DV mode only)
- To control this unit via this terminal, set REM SEL HDV/DV in the REMOTE [1/2] Menu screen to ON or LOC/REM.

#### — Note

If HDV/DV signals are not input/output when the IEEE1394 cable is connected, check whether the signal format matches the IEEE1394 switch setting on the front panel. If the settings match, either reconnect the IEEE1394 cable, or reset the power to the unit.

#### 12 DC power input terminal

This terminal is for inputting DC 12 V. Connect the DC power cord of the supplied AC adapter.

#### — Memo

- When power is supplied to this terminal, the OPERATE indicator located on the front panel lights up. (The indicator turns red when BR-HD50 is in the OPERATE OFF state)
- Whether to set BR-HD50 to enter the OPERATE ON mode or OPERATE OFF mode when power is supplied to the terminal can be selected with DC IN MODE in the SYSTEM [2/2] Menu screen.

#### 13 DC power cord clamp

Use this clamp to fasten the DC power cord.

#### 14 [SIGNAL GND] terminal

This is the grounding terminal for signals.

#### 15 [SERIAL REMOTE] terminal (mini jack)

This terminal is for connecting to the serial remote controller.

To operate BR-HD50 with this terminal, perform the following settings.

- Set REMOTE SEL SER in the REMOTE [1/2] Menu screen to "ON" or "LOC+REM".

**ON** : When the 5 REMOTE/LOCAL switch on the front panel is set to "REMOTE", this terminal becomes effective.

**LOC+REM** : This terminal is effective regardless of the setting of the 5 REMOTE/LOCAL switch on the front panel.

#### — Memo

To use this terminal as the foot switch input, set FOOT SW in the REMOTE [2/2] Menu screen. (Page 71)

#### 16 [REMOTE] RS-422A terminal (D-SUB 9P)

This terminal is for connecting to an RS-422A serial interface-compatible editing remote controller (e.g. RM-G820).

With this terminal, BR-HD50 can be used as a player of an editing system.

To operate BR-HD50 with RS-422A, perform the following settings.

- Set REMOTE SEL 9P in the REMOTE [1/2] Menu screen to "ON".
- Set the 5 REMOTE/LOCAL switch on the front panel to "REMOTE".

#### — Memo

Screws for securing connectors differ by region.

U model : inch screws

E model : metric screws

#### 17 Fan

This is a ventilation port for the fan motor.

Do not place objects in this area.

#### 18 Slot cover for servicing

This is used for servicing the unit.

## ON-SCREEN DISPLAY

### On-screen display

Besides E-E images and playback images, the monitor connected to the VIDEO OUTPUT terminals (VIDEO LINE OUT, Y/C OUT, COMPONENT OUT and HDMI OUT) provides the following on-screen information.

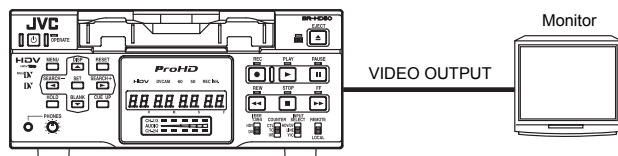

On-screen display	Description	Operation
<b>Status display</b>	Displays the setting status of the VCR operation mode, date/time, counter.	Settings can be performed with DISPLAY in the DISPLAY Menu screen.
<b>Event display</b>	Displays the operating status of blank search, index recording/search.	<b>ON</b> : Always display. According to each event or error, the event and alarm displays are shown for about 3 seconds. <b>AUTO</b> : It displays for about 4 seconds during mode changes. <b>OFF</b> : No on-screen display. The alarm display is shown according to errors, which occurred.
<b>Alarm display</b>	Displays error/alarm messages for incorrect operation or improper condition of BR-HD50.	
<b>Warning display</b>	When an error occurred with the VCR, it displays warnings with the relevant error codes. (Page 80)	It is displayed automatically when an error with the VCR occurred.
<b>Menu display</b>	Displays the menu setting screen. (Page 64)	When BR-HD50 enters the STOP/STILL mode or no cassette tape is loaded, the menu is displayed when the MENU button is pressed.
<b>Multi Cue-up screen</b>	Displays the Multi Cue-up screen for registering or selecting cue-up (searching) point. (Page 56)	When BR-HD50 enters the STOP, STILL or PLAY mode, press the Cue-up button to display the Multi Cue-up screen.

## ON-SCREEN DISPLAY

### Status display

■ **Status display**: It displays the current settings and operating status.

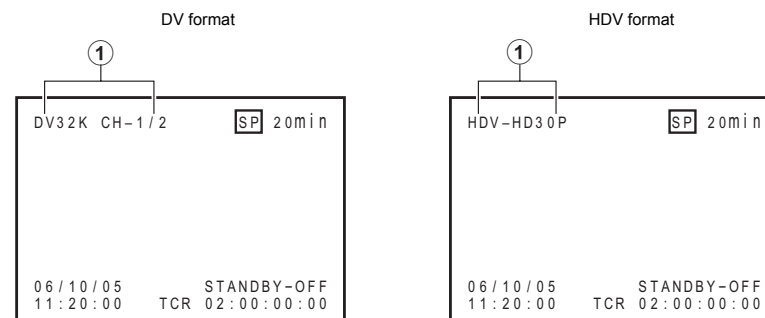

No.	Item	Description
①	The ① display contents differs between DV format and HDV format. <b>■ DV format</b> <b>Sampling frequency/audio output CH</b> <b>— Memo —</b> If the counter display position is set to the upper left, this item will be displayed on the lower right.	<ul style="list-style-type: none"> <li>DV Displayed when recording or playing back a tape with video in DV format.</li> <li>Sampling frequency While recording an analog audio signal, the setting value of AUDIO MODE: DV in the AUDIO Menu screen is displayed (32kHz or 48kHz). During playback, the sampling frequency of the sound recorded on the tape is displayed (32kHz, 48kHz, 44.1kHz). During HDV/DV signal input, the sampling frequency of the sound input is displayed.</li> <li>A.LOCK Lights up when the video and audio sampling clocks (at 48kHz) are synchronized in the PLAYBACK mode. Always lights up in the RECORDING mode and EE mode.</li> <li>Audio output channel The audio channel output from the AUDIO OUT terminal is displayed (CH-1/2, CH-3/4, MIX). (only in 32kHz mode)</li> <li>With A/V INFO. in the DISPLAY Menu screen, whether to display this item can be selected.</li> </ul>
	<b>■ HDV format</b> <b>HDV format display</b>	Displayed when recording or playing back a tape with video in HDV format. HDV format details are displayed. HDV-HD30P: 720/30p signal HDV-HD25P: 720/25p signal HDV-HD24P: 720/24p signal HDV-SD60P: 480/60p signal HDV-SD50P: 576/50p signal <b>— Note —</b> Does not support tapes in 576/26p mode from the GR-PD1 camera. Displays HDV-SD50p when playing back the tape.

# ON-SCREEN DISPLAY

## Status display (continued)

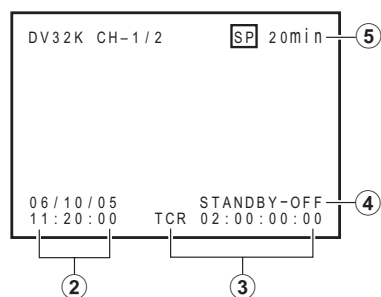

No.	Item	Description
②	<b>Date/time</b> <b>— Memo —</b> If the display position of the counter is set to the lower left, this item will be displayed on the lower right.	<ul style="list-style-type: none"> <li>It displays the date and time (HR:MM:SS).</li> <li>When the unit is in the Analog/HDV Signal RECORDING or STOP mode, it displays the data of the built-in clock.</li> <li>During playback, fast-forwarding or rewinding, the data recorded on the tape is displayed.</li> <li>During DV signal recording, the data from the IEEE1394 terminal is displayed. If the REC button is pressed in the STOP mode, the input data from the IEEE1394 terminal will be displayed.</li> <li>The style for displaying the date and time can be selected with DATE STYLE and TIME STYLE in the DISPLAY Menu screen. When TIME STYLE is set to 12H, the display symbols of the hours, minutes, and days change as follows for AM and PM. AM = dot (.) PM = colon (:)</li> <li>Whether to display date/time and the type of display can be selected with TIME/DATE in the DISPLAY Menu screen.</li> <li>When the data/time is not set or when a tape is played with no date/time data recorded, “- -” will be displayed.</li> </ul>

No.	Item	Description
③	<b>Counter display</b>	Displays the CTR counter, time code or user's bit. The displayed contents can be selected using the COUNTER switch. <ul style="list-style-type: none"> <li>CTL counter: It will be displayed if the COUNTER switch is set to CTL. The counter shows a 7-digit number (hour, minute, second and frame) with + or - and “CTL” at the beginning, e.g., CTL-9:30:20:10</li> <li>Time code : It will be displayed if the COUNTER switch is set to TC. The time code shows an 8-digit number (hour, minute, second and frame). At playback, the time codes recorded on the tape are displayed. The prefix indicates the time code mode. TCG : Time code generator data TCR : Time code reader data DTCG: Time code data received from the IEEE1394 terminal (In DV mode) Depending on the framing mode, the symbols for the seconds and frames are different (only for NTSC).   <pre> 00 : 00 : 00[00]                        ----- Dot (.) for the drop frame mode            ----- Colon (:) for the non-drop frame mode                     </pre> </li> <li>User's bit : it will be displayed if the COUNTER switch is set to UB. The user's bit is an 8-digit number (each digit is a number or character from 0 - F). The prefix indicates the user's bit mode. UBG : User's bit generator data UBR : User's bit reader data DUBG: User's bit reader data received from the IEEE1394 terminal (In DV mode)</li> </ul> <b>— Memo —</b> <ul style="list-style-type: none"> <li>The position of the counter display can be changed with COUNTER POSI in the DISPLAY Menu screen.</li> <li>The counter display can be turned on/off with TIME CODE in the DISPLAY Menu screen.</li> </ul>
④	<b>VCR operation mode</b>	Displays the VCR operation mode, including: PLAY, EJECT, FF, REW, STANDBY-ON, STANDBY-OFF, STILL, REC, REC PAUSE, SHTL (shuttle search), JOG, BLANK SRH (blank search), NO CASSETTE (cassette tape not loaded), OPERATE OFF. For SHTL and JOG, the speed is also displayed. <ul style="list-style-type: none"> <li>The display can be turned on/off with VTR MODE in the DISPLAY Menu screen.</li> </ul>
⑤	<b>Remaining tape</b> <b>— Memo —</b> If the counter display position is set to the upper right, this item will be displayed on the lower right.	Displays the remaining time of tape (minutes). Not displayed when the remaining time is being confirmed. <ul style="list-style-type: none"> <li>The display can be turned on/off with TAPE REMAIN in the DISPLAY Menu screen.</li> <li>The SP display disappears when a DVCAM cassette tape is being played back.</li> <li>This remaining tape time display is only for reference.</li> </ul>

## ON-SCREEN DISPLAY

### Event/Alarm display

- **Event display** : When certain functions are in use, it is displayed at the following positions (with the DISPLAY mode ON or AUTO).

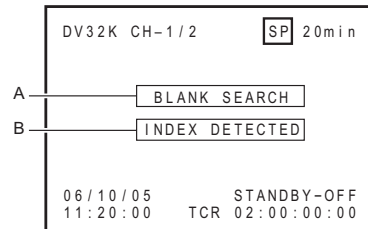

- **“A” display: displayed during operation**

Display	Description
BLANK SEARCH	Blank search in progress.
INDEX +1	Index search in progress. The number indicates the index search position.
INDEX MARK	When an index has been specified on the tape during recording.

- **“B” display: displayed for about 3 seconds**

Display	Description
INDEX DETECTED	An index has been detected during index repeat operation.
VIDEO END DETECTED	The video end has been detected during end repeat operation.

- **Alarm display** : An alarm message is displayed at the following positions when there has been an operation error or when BR-HD50 is not in good condition, e.g., dirty head.

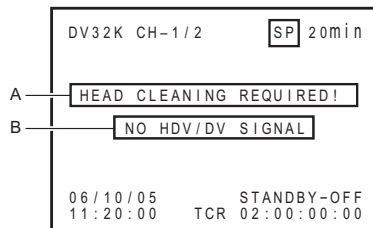

- **“A” display**: The state of BR-HD50 is displayed. It continues to be displayed until the error state is corrected. This display is not affected by the setting of the display mode.

Display	Description
LOW VOLTAGE	The voltage of the DC power source is low. If the operation continues, it enters the OPERATE OFF mode.
HEAD CLEANING REQUIRED!	The video head is dirty. Clean it with the head-cleaning tape exclusively for BR-HD50. (Page 9) If the head is clogged, it is detected in the PLAYBACK mode and this message is displayed.
OVERHEATING!	The temperature inside BR-HD50 has exceeded the stated value. Disconnect the power and place it at a cool place. If this message is displayed again, BR-HD50 could be defective. Consult your JVC-authorized service agent.

- **“B” display**: Messages for incorrect operation are displayed for about 3 seconds. They are displayed when the DISPLAY mode is ON or AUTO.

Display	Description
INVALID TAPE!	Data tape for PCs or DVC PRO tape is used. The cassette tape will be automatically ejected.
LP TAPE!	The user attempted to play back a tape recorded in the LP mode. BR-HD50 cannot record or play in the LP mode.
NO HDV/DV SIGNAL	The user attempted to record without HDV or DV signal input.
COPY INHIBIT	The user attempted to record copy-guarded signals.
REC INHIBIT	The user attempted to record on a tape that is not ready for recording (the rear switch is set to SAVE).
OPERATION LOCK	This message is displayed when an operation button is pressed with OPERATION LOCK enabled. To enable OPERATION LOCK, set OPERATION LOCK in the SYSTEM [2/2] Menu screen to ON.
PB INHIBIT [60/50]	This message is displayed when the HD/SD signal format setting differs during playback of a tape recorded in HDV/DV format.
REC INHIBIT [60/50]	<ul style="list-style-type: none"> <li>• (for U model) This message is displayed when the unit is recorded in PAL mode.</li> <li>• (for E model) This message is displayed when the unit is recorded in NTSC mode.</li> </ul>
50/25 INHIBIT	<ul style="list-style-type: none"> <li>• When 60/50 SEL in the SYSTEM [2/2] Menu screen is set to 60, this message is displayed when HDV signal format is not 60Hz.</li> <li>• This message is displayed when the DV signal from the IEEE1394 terminal is not NTSC.</li> </ul>
60/30 INHIBIT	<ul style="list-style-type: none"> <li>• When 60/50 SEL in the SYSTEM [2/2] Menu screen is set to 50, this message is displayed when HDV signal format is not 50Hz.</li> <li>• This message is displayed when the DV signal from the IEEE1394 terminal is not PAL.</li> </ul>

# CONNECTION

## Connecting video signals

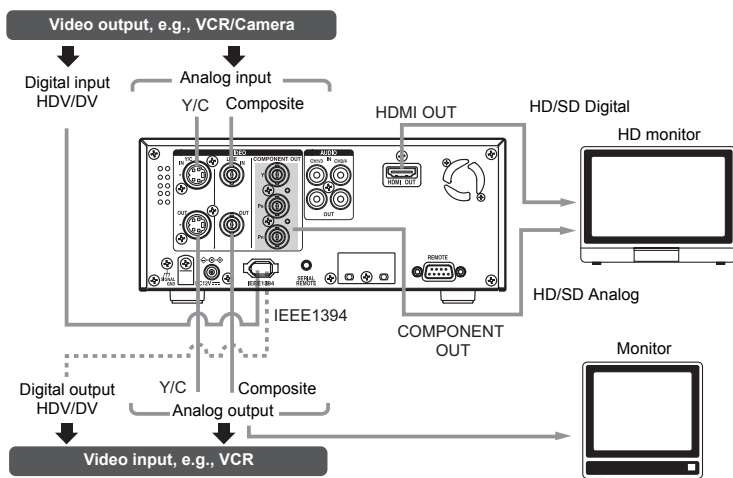

Turn off the power before making connections.

### Input signal

The input video signal is selected with the INPUT SELECT switch on the front panel.

#### To input analog video signals

Use the LINE IN terminal or Y/C IN terminal.

- **LINE IN terminal:**  
Inputs composite video signals. Connect a BNC cable.
- **Y/C IN terminal:**  
Inputs Y/C separate video signals. Connect an S video cable (4PIN). When a wide screen ID signal is input, the ID signal is recorded.

#### To connect digital signals

Connect HDV signals or DV signals to the IEEE1394 terminal.

Connect an IEEE1394 (6PIN) cable.

HDV signals using 720p format can be input.

#### HDV 720p format:

720/30p, 720/24p, 480/60p  
720/25p, 576/50p

- The IEEE1394 switch located on the front panel needs to be set, according to whether the video format is HDV or DV.
- Digital audio is also input from the IEEE1394 terminal.
- Power is not supplied via the IEEE1394 terminal.

- Attach the supplied filter to the IEEE1394 cable. (Page 29)
- For more information on the IEEE1394 terminal, refer to page 18.

### Caution regarding video signals

- If search images or analog video signals with a high level of jitter are input, video or sound may be distorted temporarily. Input stable signals, such as signals passed through a TBC.

### Output signal

#### LINE OUT terminal

Outputs composite video signals.

Connect to a monitor using a BNC cable.

In addition to the composite video signals, it also displays the on-screen status display and the menu settings screen.

#### Y/C OUT terminal

Outputs Y/C separate video signals.

Connect to a monitor using an S video cable (4PIN).

In addition to the Y/C separate video signals, it also displays the on-screen status display and the menu settings screen.

When a wide screen ID signal exists in the video signal, the ID signal is output.

#### COMPONENT OUT terminal

Outputs analog component video signals.

Connect to an HD-compatible monitor using BNC cables (three cables).

View analog HD or SD video on the monitor.

This terminal does not output audio.

In addition to the video signals, it also displays the on-screen status display and the menu settings screen.

#### HDMI OUT terminal

Outputs HDMI signals.

Outputs digital video and digital audio signals.

Connect to a monitor with an HDMI terminal using an HDMI cable.

Outputs digital HD video, SD video, and digital audio to the monitor.

When the monitor connection is a DVI terminal, use an HDMI-DVI cable.

Digital HD/SD video is output to a DVI terminal monitor. Does not output audio.

In addition to the video signals, it also displays the on-screen status display and the menu settings screen.

#### IEEE1394 terminal

This is also an input terminal. Connect an IEEE1394 (6PIN) cable.

Outputs HDV signals or DV signals.

Digital audio signals are output with the video.

- Attach the supplied filter to the IEEE1394 cable. (Page 29)
- For more information on the IEEE1394 terminal, refer to page 18.

### Memo

For more information on input/output terminal video formats, refer to pages 32 to 34.



## CONNECTION

### Connecting audio signals

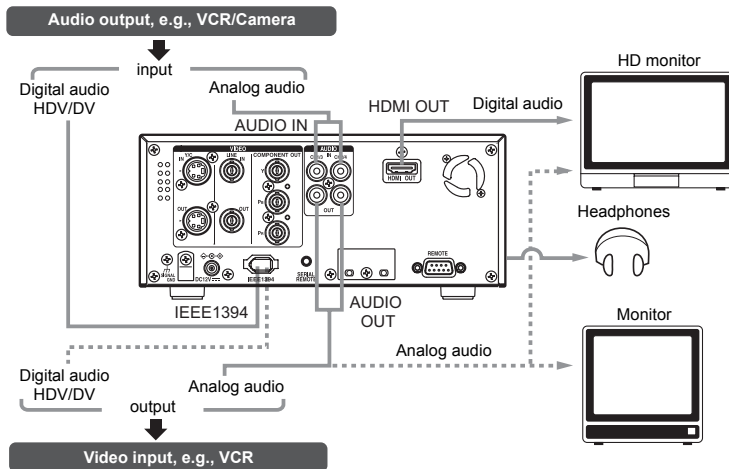

#### ■ Input signal

##### ● Analog input

###### AUDIO IN terminal (RCA×2)

Connect an audio cable.

There are analog input terminals for 2 channels.

Four channels cannot be recorded simultaneously. Audio input from each terminal is recorded to CH1 and CH2.

##### ● Digital input

###### IEEE1394 terminal (6P)

Connect an IEEE1394 (6PIN) cable.

Inputs HDV signals or DV signals.

Digital audio signals are input with the video.

- The DV signal audio mode (48kHz or 32kHz) will match the input signal audio mode.
- During digital signal input, the recording level cannot be adjusted.

#### ■ Output signal

##### ● AUDIO OUT terminal (RCA×2)

Connect an audio cable.

Analog audio is output.

For the DV format, tracks are available for 4 channels (in the 32kHz audio mode).

- In the 32kHz audio mode, the audio channel to output can be selected from 4 channels using A.OUTPUT: DV in the AUDIO Menu screen.

##### ● PHONES terminal (Stereo ø3.5)

Connect headphones.

##### ● IEEE1394 terminal (6P)

This is also an input terminal. Connect an IEEE1394 (6PIN) cable.

Digital audio signals are output with the video.

- Attach the supplied filter to the IEEE1394 cable. (☞ Page 29)
- For more information on the IEEE1394 terminal, refer to page 18.

## CONNECTION

### Attaching the supplied ferrite core

- Always attach the supplied ferrite core to the IEEE1394 cable and DC cord to decrease unnecessary wave radiation.
- Attach the ferrite core close to the unit.

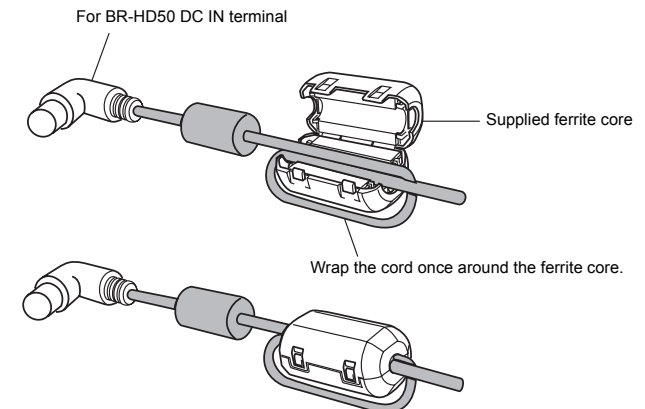
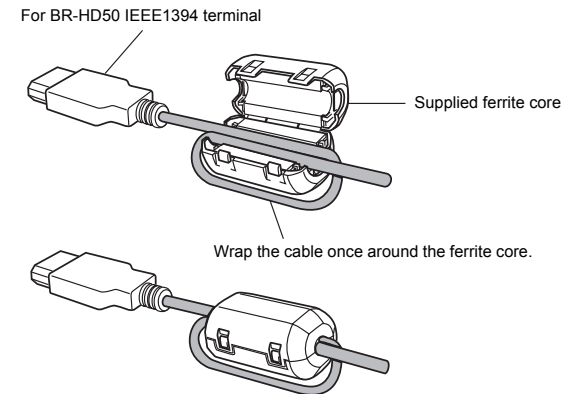

## CONNECTION

### Connecting with SERIAL REMOTE terminals

The following describes examples of SERIAL REMOTE terminal connection.

To use the SERIAL REMOTE terminals, set REMOTE SEL SER of the REMOTE [1/2] Menu screen to "ON" or "LOC+REM." (☞ Page 70)

#### ■ Operate BR-HD50 with the wired remote controller

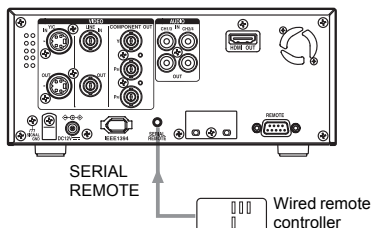

Connect the wired remote controller to the SERIAL REMOTE terminal.

#### ■ Start/stop recording with an external switch, e.g., a foot switch.

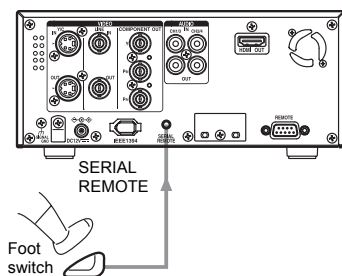

Connect an external switch, e.g., a foot switch, to the SERIAL REMOTE terminal. The format of the input signals can be selected with FOOT SW in the REMOTE [2/2] Menu screen. (☞ Page 71)

## CONNECTION

### Connecting the AC adapter

Connect the supplied AC adapter to BR-HD50.

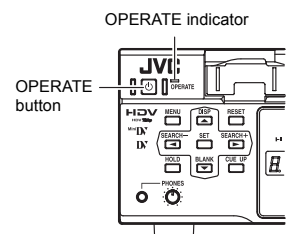
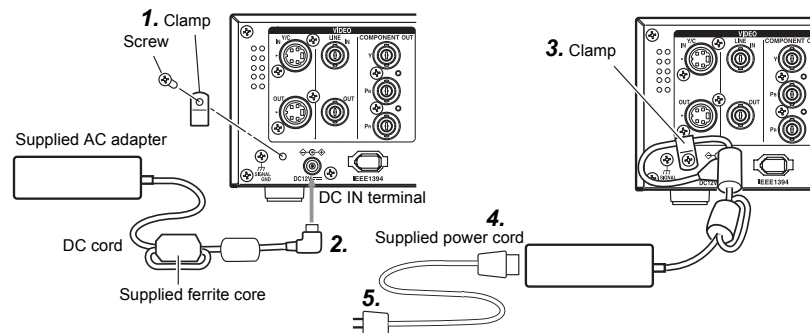

#### ■ Always attach the supplied ferrite core to the DC cord. (☞ Page 29)

1. Remove one screw on the back panel of the unit, and remove the DC cord clamp.
2. Connect the DC cord of the AC adapter to the DC IN terminal of BR-HD50.

3. To prevent accidental disconnection of the DC cord, insert the DC cord into the clamp, orient the clamp as shown in the figure above, and secure the clamp to the unit. Use the screw removed in step 1 above to secure the clamp to the unit.

4. Connect the supplied power cord to the AC IN terminal of the AC adapter.

5. Connect the power cord to the power outlet.

- BR-HD50 is turned on and the OPERATE indicator lights up in red. (OPERATE OFF mode)
- If DC IN MODE of the SYSTEM [2/2] Menu screen is set to "OPE ON", the OPERATE indicator will light up in green. (OPERATE ON mode)

#### — Memo

- Even in the OPERATE OFF mode, a small amount of electricity will still flow into the unit.
- When the unit is in the OPERATE OFF mode, no operation can be performed except that of the OPERATE buttons and cassette loading/ejecting.

#### — Note

- Supply power to BR-HD50 using the supplied AC adapter. Do not use other power sources.
- Do not unplug the DC cord and/or the power cord during recording or playback.
- If the supply voltage is low, an alarm display of "LOW VOLTAGE" is shown.

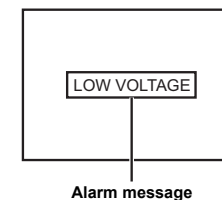

## RECORDING/OUTPUT SIGNAL FORMAT

### Inputting analog signal

- Recording and output terminal video/audio signal format when inputting analog signal

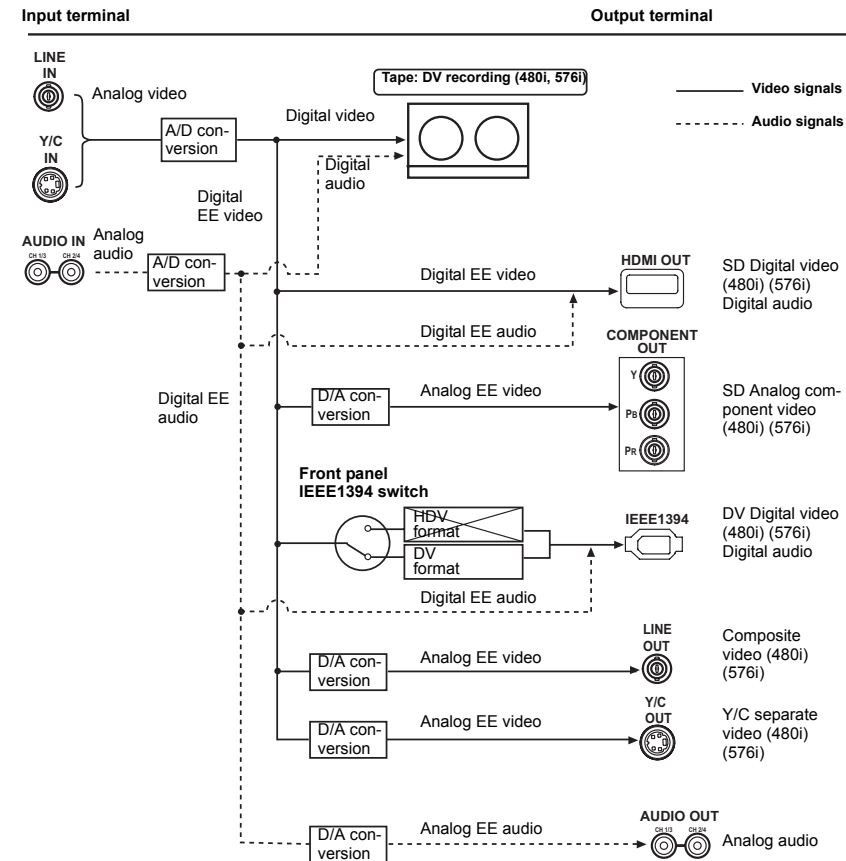

Input video format	Model	Input signal	Tape recording format	IEEE1394 terminal	HDMI OUT terminal COMPONENT OUT terminal	LINE OUT terminal Y/C OUT terminal
Analog	U model	480/60i	480/60i	480/60i	480/60i	480/60i
	E model	576/50i	576/50i	576/50i	576/50i	576/50i

## RECORDING/OUTPUT SIGNAL FORMAT

### Inputting digital signal

- Recording and output terminal video/audio signal format when inputting digital signal

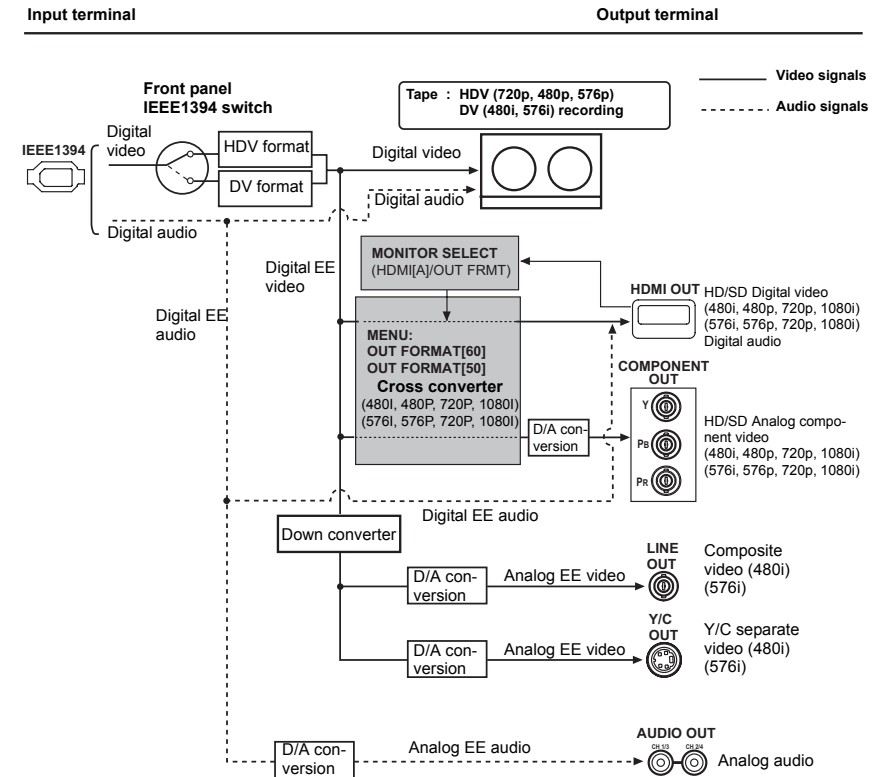

Input video format	HD signal format (*1)	Input signal	Tape recording format	HDMI OUT terminal COMPONENT OUT terminal (*2)	LINE OUT terminal Y/C OUT terminal
HDV	60Hz	720/30p	720/30p	720/60p, 480/60p, 1080/60i, 480/60i	480/60i
		720/24p	720/24p		
	480/60p	480/60p			
50Hz		720/25p	720/25p	720/50p, 576/50p, 1080/50i, 576/50i	576/50i
		576/50p	576/50p		

Input video format	Model	Input signal	Tape recording format	HDMI OUT terminal COMPONENT OUT terminal (*2)	LINE OUT terminal Y/C OUT terminal
DV	U model	480/60i	480/60i	720/60p, 480/60p, 1080/60i, 480/60i	480/60i
	E model	576/50i	576/50i	720/50p, 576/50p, 1080/50i, 576/50i	576/50i

\*1 : Set using 60/50 SEL in the SYSTEM [2/2] Menu screen.

\*2 : Set using OUT FORMAT [60]/OUT FORMAT [50] in the VIDEO Menu screen.

## RECORDING/OUTPUT SIGNAL FORMAT

### Playback

#### ■ Output terminal video/audio signal format during playback

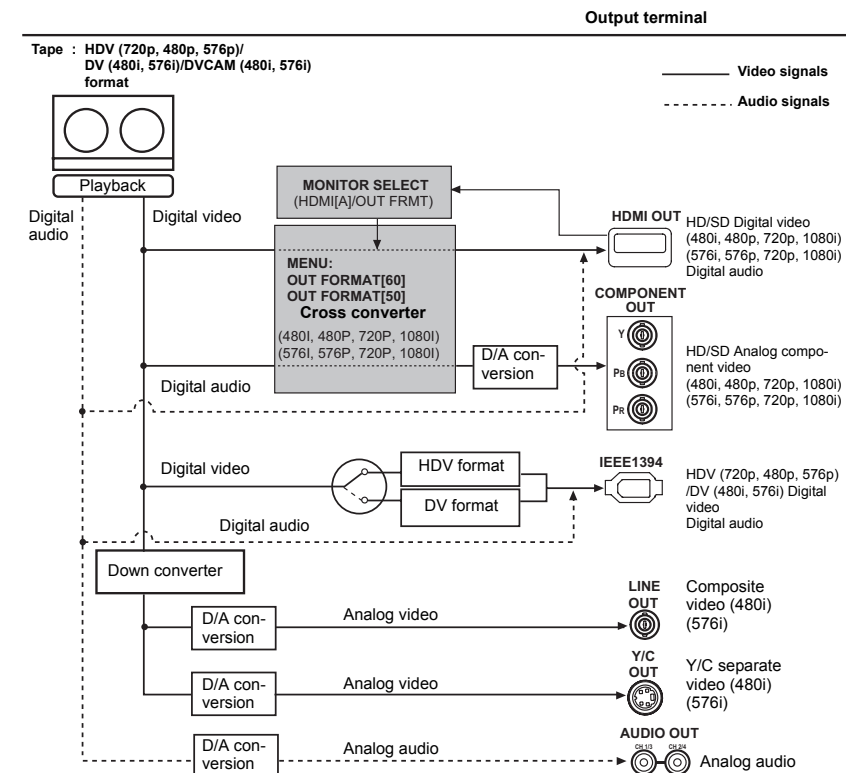

Video format	HD signal format (*1)	Tape recording format	IEEE1394 terminal	HDMI OUT terminal COMPONENT OUT terminal (*2)	LINE OUT terminal Y/C OUT terminal
HDV	60Hz	720/30p	720/30p	720/60p, 480/60p, 1080/60i, 480/60i	480/60i
		720/24p	720/24p		
	50Hz	480/60p	480/60p	720/50p, 576/50p, 1080/50i, 576/50i	576/50i
		720/25p	720/25p		
		576/50p	576/50p		
Video format	Model	Tape recording format	IEEE1394 terminal	HDMI OUT terminal COMPONENT OUT terminal (*2)	LINE OUT terminal Y/C OUT terminal
DV/DVCAM	U model	480/60i	480/60i	720/60p, 480/60p, 1080/60i, 480/60i	480/60i
	E model	576/50i	576/50i	720/50p, 576/50p, 1080/50i, 576/50i	576/50i

\*1: Set using 60/50 SEL in the SYSTEM [2/2] Menu screen.

\*2: Set using OUT FORMAT [60]/OUT FORMAT [50] in the VIDEO Menu screen.

## PREPARATION

### Turning on/off the power

#### Turning on the power

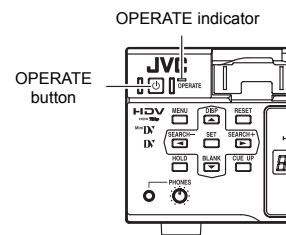

#### ■ Press the OPERATE button when BR-HD50 is in the OPERATE OFF mode (with the OPERATE indicator lit up in red)

- The power is turned on and the OPERATE indicator lights up in green. BR-HD50 is ready for operation. (OPERATE ON mode)

#### — Memo

- In the OPERATE OFF mode, if a cassette tape is inserted, the power is turned on and BR-HD50 goes into the OPERATE ON mode.
- Whether BR-HD50 goes into the OPERATE ON or OFF mode when the power is supplied to the DC IN terminal can be selected with DC IN MODE in the SYSTEM [2/2] Menu screen.

#### — Note

After the OPERATE button is pressed and BR-HD50 is turned on, if the green indicator blinks or the monitor displays "UNPLUG MAIN POWER, PLUG BACK IN AFTER A WHILE", unplug the power cord from the power outlet, leave it for a while before turning on the power again.

#### Turning off the power

#### ■ Turn off BR-HD50

- Press the OPERATE button.
  - BR-HD50 enters the OPERATE OFF mode and the OPERATE indicator lights up in red.
- If BR-HD50 is not to be used for a long period of time, unplug the AC adapter. To unplug the AC adapter, remove the power cord from the power outlet first.

## PREPARATION

### Operation method (main unit/remote controller) and OPERATION LOCK mode

#### Selecting the operating method (main unit/remote controller)

Whether to operate BR-HD50 with its buttons or the remote controller can be selected with the REMOTE/LOCAL switch.

##### ■ Setting the REMOTE/LOCAL switch

- To operate with the buttons of BR-HD50, set it to "LOCAL".
- To operate BR-HD50 with RS-422A editing remote controller that is connected to the REMOTE terminal, set it to "REMOTE".

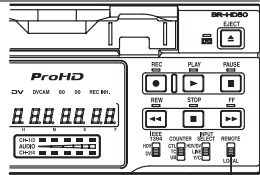

REMOTE/LOCAL switch

REMOTE [1/2] Menu screen

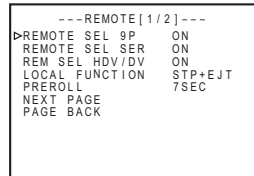

#### — Memo

With the REMOTE/LOCAL switch set to REMOTE, RS-422A can be enabled using REMOTE SEL 9P in the REMOTE [1/2] Menu screen.

- The setting position of the REMOTE switch for operating BR-HD50 with the SERIAL REMOTE terminal can be selected using REMOTE SEL SER in the REMOTE [1/2] Menu screen.
- The setting position of the REMOTE switch for operating BR-HD50 with the IEEE1394 terminal can be selected at REM SEL HDV/DV in the REMOTE [1/2] Menu screen. [Page 70 "REMOTE [1/2] Menu screen"]

#### — Memo

If the REMOTE/LOCAL switch is set to REMOTE, the buttons that can be operated by the main unit can be selected with LOCAL FUNCTION.

## OPERATION LOCK mode

BR-HD50 comes with an operation lock function to prevent unauthorized or incorrect operation. In the OPERATION LOCK mode, the operation buttons and slide switches of BR-HD50 are disabled. However, the OPERATE ON and MENU operations are effective. The PHONES volume is always effective.

##### ■ Turning on the OPERATION LOCK mode

Set OPERATION LOCK in the SYSTEM [2/2] Menu screen to ON.

- If the operation button of BR-HD50 is pressed while BR-HD50 is in the OPERATION LOCK mode, "OPERATION LOCK" is displayed on the monitor for about 3 seconds.

##### ■ Turning off the OPERATION LOCK mode

Set OPERATION LOCK in the SYSTEM [2/2] Menu screen to OFF.

SYSTEM [2/2] Menu screen

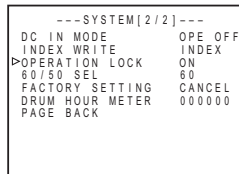

## PREPARATION

### Loading/Ejecting cassette

Use standard DV cassette tapes or mini DV cassette tapes.

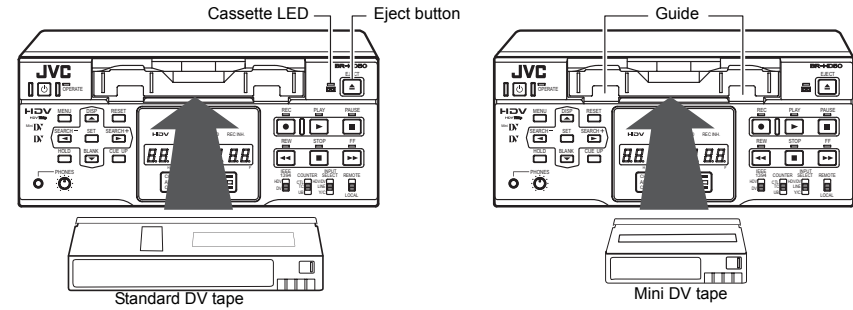

#### Loading the cassette tape

##### 1. Check the cassette tape.

- Setting the rear switch. Push it to "REC" for recording. To prevent its contents from being erased accidentally, push it to "SAVE".
- Ensure that the tape is not loosened.

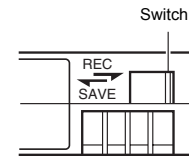

##### 2. Ensure that no cassette tape is loaded.

With no cassette tape loaded, the cassette LED is off. When no cassette tape is loaded, the status display for the VCR operation mode shows "NO CASSETTE" on the monitor.

##### 3. Load the cassette tape.

- Insert a standard DV cassette tape into the tape-loading slot.
- For a mini DV cassette tape, load it in between the left and right guides. Set the tape window face up and push the cassette tape in slowly until it is drawn in automatically.
- When the cassette tape is loaded, the status display indicates "STANDBY-ON".
- \* If the STANDBY-ON mode is left as is, it goes into the STANDBY-OFF mode. In the STANDBY-OFF mode, press the STOP button to return to the STANDBY-ON mode.

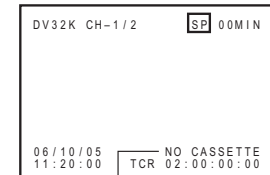

VCR mode status display

#### Ejecting the cassette tape

##### 1. Press the EJECT button of BR-HD50.

→ While the cassette tape is being ejected, the status display flashes "EJECT".

##### 2. Remove the cassette tape.

#### — Memo

- The cassette tape can be loaded/ejected even when BR-HD50 is in the OPERATE OFF mode.
- The loading/ejecting action of the cassette tape takes about 6 seconds.

# PREPARATION

## Setting/Displaying date and time

This function sets up the date and time of the built-in clock. With the built-in chargeable battery, the date and time data that have been set are maintained even after the main power is turned off. The set date and time data are displayed on the monitor according to the settings in the Menu screen. Date and time display information are recorded onto the tape. During IEEE1394 terminal DV signal input, internal clock data is not recorded.

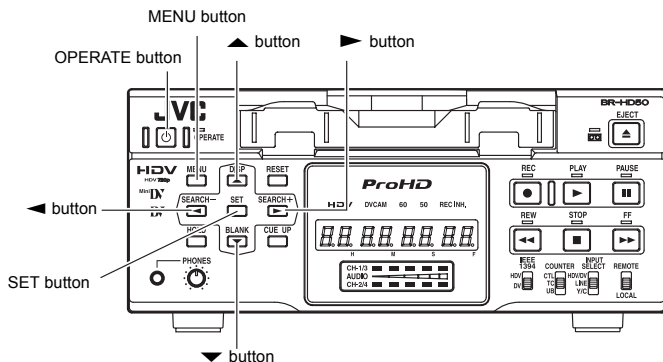

### Setting date and time

The date and time are set up at the CLOCK ADJUST Menu screen.

The CLOCK ADJUST Menu screen is found under the TC/UB/CLOCK [2/2] Menu.

Setting can be performed while checking the information shown on the monitor.

■ Press the OPERATE button to turn on the power and set it to the STOP mode.

1. Press the MENU button to display the TOP Menu screen.

2. Displaying the CLOCK ADJUST Menu.

① Press the ▲ or ▼ button to bring the cursor to the desired TC/UB/CLOCK item. Press SET or the ► button.

② Press the ▲ or ▼ button to bring the cursor to the NEXT PAGE item in the TC/UB/CLOCK [1/2] Menu screen. Press SET or the ► button.

③ Press the ▲ or ▼ button to bring the cursor to the CLOCK ADJUST item in the TC/UB/CLOCK [2/2] Menu screen. Press SET or the ► button.

3. Setting the date and time in the CLOCK ADJUST Menu screen.

① Press the ▲ or ▼ button to bring the cursor to the date or time item. Press SET or the ► button.

② Press the ► or ◀ button to select the digit for setting. The selected digit starts blinking.

③ Press the ▲ or ▼ to set the value.

④ Repeat step ① – ③. After completing the required setting, press the SET button.

TC/UB/CLOCK [2/2] Menu screen

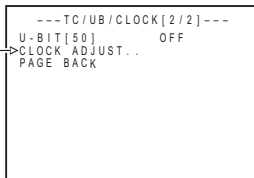

CLOCK ADJUST Menu screen

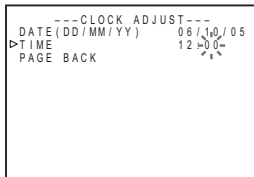
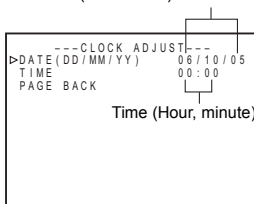

### — Memo —

The seconds for the time cannot be set up. After the minute is set up, press the SET button in synchronization with the time signal.

4. Returning to the TOP Menu from TC/UB/CLOCK after completing all settings

- Press the ◀ button.
- Or
- Press the ▲ or ▼ button to bring the cursor to PAGE BACK and press the SET button.

5. Returning to the usual menu

- Press the MENU button.
- Or
- Bring the cursor to EXIT of the TOP Menu and press the SET button.

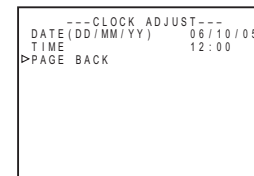

### Selecting date/time display

The date and time data can be displayed on the monitor on-screen display (status display). Setup can be performed at the DISPLAY Menu screen to turn on/off the date/time display and select the display style. (For setting procedure: Page 64)

■ DISPLAY Menu screen

● TIME DATE : For enabling/disabling the display of date and time on the status display

OFF : Does not display date/time.

TIME : Displays time only.

DATE : Displays date only.

DATE+ TM : Displays both the time and date.

● DATE STYLE : For selecting the date display style

YY/MM/DD : Year/month/day

MM/DD/YY : Month/day/year

DD/MM/YY : day/month/year

● TIME STYLE : For selecting the time display style

24H : 24-hour time mode

12H : 12-hour time mode

DISPLAY Menu screen

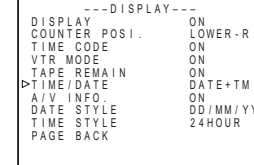

### On-screen status display

Set DISPLAY to ON or AUTO in the DISPLAY Menu screen.

### — Memo —

- In the Analog RECORDING or STOP mode : Displays the time of the built-in clock.
- In the PLAYBACK mode : The date and time recorded on the tape are displayed.
- In the DV RECORDING mode : The date and time from the IEEE1394 terminal are displayed.

On-screen status display

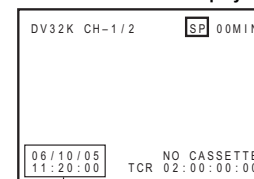

Date/time display

## PREPARATION

### Selecting HD signal format

On this unit, 60Hz format or 50Hz format for the HD signal format can be selected using 60/50 SEL in the SYSTEM [2/2] Menu screen.

This must be set in the following situations.

- Set to match the input signal format when recording HDV signals from the IEEE1394 terminal.
- Set to match the playback signal format when playing a tape recorded with HDV signals.

### Check settings

Current settings on this unit can be checked by whether the front panel 60 or 50 indicator light is lit.

60 indicator : The HD signal format is 60Hz.

50 indicator : The HD signal format is 50Hz.

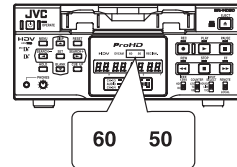

### Setting the Menu screen

Set this using 60/50 SEL in the SYSTEM [2/2] Menu screen.

Perform setting while checking the monitor display.

- Press the OPERATE button to turn on the power, and set it to the STOP mode.

1. Press the MENU button to display the TOP Menu screen.

2. Display the SYSTEM Menu screen.

Press the ▲ or ▼ button to move the cursor to SYSTEM, then press SET or the ► button.

3. Display the SYSTEM [2/2] Menu screen.

Press the ▲ or ▼ button to move the cursor to NEXT PAGE, then press SET or the ► button.

4. Set 60/50 SEL.

- ① Press the ▲ or ▼ button to move the cursor to 60/50 SEL in the SYSTEM [2/2] Menu screen, then press SET or the ► button.
  - The setting value area flashes.
- ② Press the ▲ or ▼ button to select the setting value.
  - 60 : The HD signal format becomes 60Hz.
  - 50 : The HD signal format becomes 50Hz.
- ③ Press the SET or ► button confirm the setting value.

- The unit automatically restarts when the setting is confirmed.

### Memo

- Recording and playback are unavailable when the unit setting differs from the HDV input signal or HDV recorded tape signal format.
- During DV/analog signal input or when playing a tape recorded with DV/analog signals, the field frequency format is fixed for the region, regardless of the 60/50 SEL menu setting. (U model: 60Hz, E model: 50Hz)

## RECORDING

### Settings for analog signal input

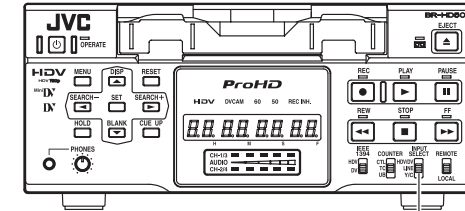

INPUT SELECT switch

### Selecting analog input signal

Set the INPUT SELECT switch located on the front panel to LINE or Y/C.

**LINE** : Inputs composite video from the LINE IN terminal, and analog audio signals from the AUDIO IN terminal.

**Y/C** : Inputs Y/C separate signals from the Y/C IN terminal, and analog audio signals from the AUDIO IN terminal.

### Setting SYSTEM Menu screen

#### ● REC LONG P. TIME

This is for setting the time for BR-HD50 to enter the tape protection mode if there is a long recording pause.

#### ● INDEX WRITE: SYSTEM [2/2] Menu

This is for selecting whether to record index signals automatically when recording starts. (SYSTEM menu details: Page 67 to 69)

- For settings when recording time codes, refer to pages 60 and 61.

### Setting Menu screens

#### ■ Setting VIDEO Menu screen

##### ● SET UP [60]: DV (only for U model)

Set here according to the existence of the setup of analog video signals (composite and Y/C separate). If it exists, set here to ON. If it does not, OFF.

#### ■ Setting AUDIO Menu screen

##### ● AUDIO MODE: DV (In DV mode only)

Selects the audio sampling frequency for recording.

**32k** : Records in 12-bit 32kHz mode. DV format has up to four channels of recording tracks available, but this unit only records onto two channels: CH1 and CH2.

**48k** : Records in 16-bit 48kHz mode. Records onto CH1 and CH2.

### Memo

Audio dubbing is not available on this unit.

## RECORDING

### Settings for digital signal input

#### Selecting input signal

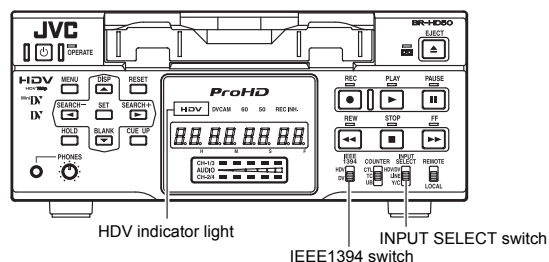

#### ■ Selecting digital input signal

Set the **INPUT SELECT** switch located on the front panel to **HDV/DV**.

Inputs IEEE1394 terminal HDV or DV digital video.

For audio, digital audio is input from the IEEE1394 terminal.

#### ■ Settings for digital video format

Set according to whether the IEEE1394 terminal input video format is HDV or DV.

Set the **IEEE1394 switch on the front panel, according to the video format of the input signal.**

**HDV** : To input HDV format signals, set to this position. The HDV indicator on the front panel will light.

**DV** : To input DV format signals, set to this position. The HDV indicator on the front panel will turn off.

#### — Memo

- During digital signal input, make sure the IEEE1394 switch setting matches the input signal video format. When the switch setting does not match the video format, no recording operation is available.
- During HDV signal input, match the HD signal format (60Hz or 50Hz) to the input signal format. (Page 40 "Selecting HD signal format")
- Recording/output signal format during HDV or DV signal input: Page 33

#### Setting related Menu screen

##### Setting SYSTEM Menu screen

###### REC LONG P. TIME

This is for setting the time for BR-HD50 after the tape protection mode if there is a recording pause.

###### IDEX WRITE: SYSTEM [2/2] Menu

This is for selecting whether to record index signals automatically when recording starts.

SYSTEM menu details: Page 67 to 69

##### Setting VIDEO Menu screen

###### OUT FORMAT [60]/[50]

Select the EE image format output from the DMI OUT terminal and the COMPONENT OUT terminal. (Cross converter video)

Setting [60]: **NATIVE/480I/480P/1080I/720P**

Setting [50]: **NATIVE/576I/576P/1080I/720P**

###### MONITOR SELECT

It automatically match the EE image format output from the HDMI terminal to the video format of the connected display, set this menu item to HDMI[A].

Settings: **HDMI[A]/OUT FRMT]**

###### OWN CONV. MODE

When HDV signal is a wide-screen video signal. When HDV signals are input, the output from the LINE OUT terminal and Y/C OUT terminal will be down-converted EE images (480i/576i). Select the style for displaying the down-converted EE image on a display with a 4:3 aspect ratio.

This will also apply to down-converted EE images (480i/576i) output from the COMPONENT OUT terminal.

Settings: **SQUEEZE/LETTER BOX/SIDE-CUT]**

###### P CONV. MODE

It converts DV input signals or DV/DVCAM recorded tape playback signals, and sets the video mode for output from the COMPONENT OUT terminal.

Settings: **FULL/SIDE P.]**

VIDEO menu details: Page 73 to 75

##### ■ Settings for recording the time code

Select the time code to record, from the data in the built-in time code generator or from the time code data input from the IEEE1394 terminal, using TC DUPLI.: DV in the TC/UB/CLOCK [1/2] Menu screen. To record the time code from the IEEE1394 terminal, set TC DUPLI.: DV to AUTO or NON DROP. (In DV mode only)

(Setting time code recording: Page 60, 61)

#### — Memo

##### ● Audio mode

During digital signal input, the audio mode is identical to the IEEE1394 terminal input signal mode.

DV format : 48K, 44.1K, or 32K mode

HDV format : 48K mode

During digital signal input, the AUDIO MODE: DV setting in the AUDIO menu is invalid.

##### ● Time/Date display

During DV signal input, data from the built-in clock cannot be recorded.

The date/time data input from the IEEE1394 terminal is recorded, regardless of the menu settings.



## RECORDING

### Adjusting audio recording level

The analog audio recording level can be adjusted on this unit. There are two adjustment methods, selected using A.REC VR.MD.: DV in the AUDIO Menu screen.

The audio recording level can be set to the initial setting value. (UNITY mode)

#### — Memo

Audio input level from the IEEE1394 terminal cannot be adjusted.

### Settings

- Set “◀, ▶” KEY FUNC. in the SYSTEM [1/2] Menu screen to VAR/RECV.
- Select an adjustment method using A.REC VR.MD.: DV in the AUDIO Menu screen.
  - BOTH : The audio recording level for both CH1 and CH2 are adjusted simultaneously.
  - INDEPEND : The audio recording level for CH1 and CH2 are adjusted separately.

### Adjusting audio recording level

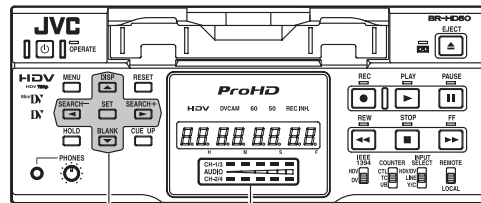

Adjustment buttons

Audio level indicator

- Hide the Menu screen.
- This can be adjusted in the STOP or REC mode. Watching the audio level indicator on the front panel, adjust so that the far right LED is turned off.

### Simultaneously adjusting both channels (BOTH)

#### ■ Increasing the recording level

Press the ▲ button while holding down the ◀ or ▶ button. The audio recording level for both CH1 and CH2 increases.

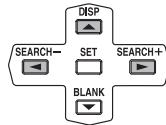

#### ■ Decreasing the recording level

Press the ▼ button while holding down the ◀ or ▶ button. The audio recording level for CH1 and CH2 decreases.

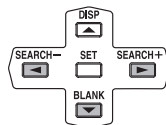

### Adjusting each channel separately (INDEPEND)

#### ■ Adjusting the CH1 channel

Press the ▲ or ▼ button while holding down the ◀ button.  
Press the ▲ button to increase the recording level.  
Press the ▼ button to decrease the recording level.

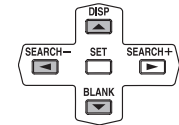

#### ■ Adjusting the CH2 channel

Press the ▲ or ▼ button while holding down the ▶ button.  
Press the ▲ button to increase the recording level.  
Press the ▼ button to decrease the recording level.

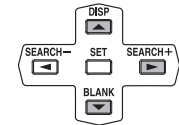

### Adjusting the audio recording level to the initial setting value (UNITY mode)

- To set the audio recording level to the initial setting value, press the ◀ button and ▶ button simultaneously.

• The audio recording level is fixed to the initial setting value.

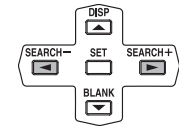

## RECORDING

### Recording procedure

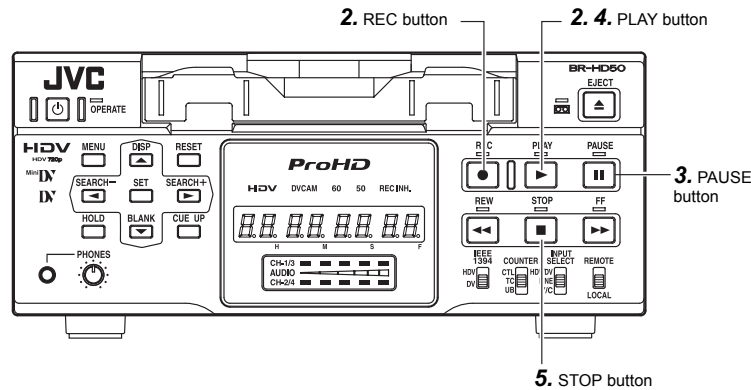

#### 1. Load the cassette tape.

- Before loading the cassette tape, please ensure that the rear slide of the cassette tape is pushed to REC.  
→ The unit is turned on.

#### 2. Start recording.

- Press the PLAY button while holding down the REC button.

#### 3. Pause recording.

- Press the PAUSE button.

#### 4. Resume recording.

- Press the PLAY button.

#### 5. Stop recording.

- Press the STOP button.

#### — Memo —

- The tape protection function enables BR-HD50 automatically to go into the STOP mode when there is a long recording pause. The time to go into the STOP mode can be set with REC LONG P. TIME in the SYSTEM [1/2] Menu screen.
- When a home-use DV VCR is used to play tapes recorded with BR-HD50, the sound level may be reduced.

### Recording index signals

If INDEX WRITE is set to ON in the SYSTEM [2/2] Menu screen, an index signal is recorded at the recording starting position of the tape. In the PLAYBACK mode, the position where the index signal is recorded can be searched. (Index search)

#### ■ Press the REC button to record index signals during recording.

- \* It is not possible to record only index signals after the recording. Allow at least an interval of 1 minute between recordings of index.
- \* Index signals cannot be recorded with the REC button of the remote controller. Use the record button of BR-HD50.

#### — Memo —

- If recording is performed right after the RECORDING PAUSE mode is exited, index signals are not recorded.

## RECORDING

### Backup recording function

In combination with DV equipment, BR-HD50 can perform continuous, long-hour recording. BR-HD50 can be set as the backup unit connected to a DVcamcorder (GY-DV300/DV500/DV550/DV5000, etc.). When the recording tape of the source unit nears its end, BR-HD50 can start recording, enabling long-hour recording.

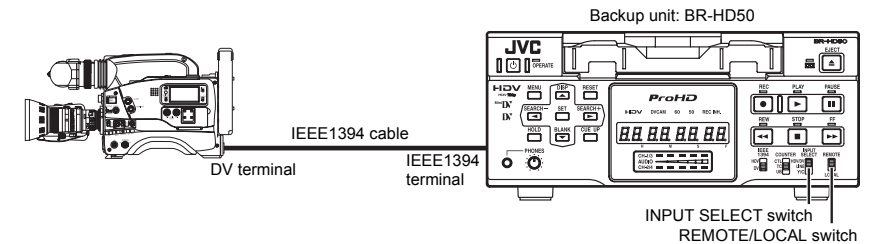

#### Connection

Connect the DV terminal of the source unit to the IEEE1394 terminal of BR-HD50 with an IEEE1394 cable.

#### Setting up BR-HD50

##### ■ Set the INPUT SELECT switch on the front panel to "HDV/DV".

##### ■ Set the REMOTE/LOCAL switch on the front panel to "REMOTE".

##### ■ Set BACKUP REC: DV in the SYSTEM [1/2] Menu screen.

Use the following settings according to the tape length of the source unit.

\* For DV or mini DV cassette tape:

25MIN	: 30-minute tape
55MIN	: 60-minute tape
75MIN	: 80-minute tape
115MIN	: 120-minute tape
175MIN	: 180-minute tape
265MIN	: 270-minute tape
OFF	: No backup recording

##### ■ Set the REM SEL HDV/DV in the REMOTE [1/2] Menu screen to ON or LOC+REM.

##### ■ Set TC DUPLI.: DV in the TC/UB/CLOCK [1/2] Menu screen to OFF.

- It records the data of the built-in time code generator.
- When TC DUPLI.: DV is set to AUTO or NON DROP, the time code of the DV camcorder will stop advancing. If the DV cable is disconnected, the time code of the backup recording will stop advancing.

#### ■ For using GY-DV5000/DV5100 as the source unit

Set DV REC TRIGGER in the OTHERS [1/2] Menu screen of GY-DV5000/DV5100 to OFF.

#### Operation

##### 1. Recording begins on the source unit.

- \* Ensure that recording starts from the beginning of the recording tape.

##### 2. BR-HD50 begins recording when the tape of the source unit nears its end (about 5 minutes before the end of the tape).

- BR-HD50 begins recording when the recording time of the source unit reaches the time set by BACKUP REC: DV.

#### — Memo —

- In backup recording, BR-HD50 records video/sound from the source unit. While this unit is performing backup recording, continue shooting from the source unit.
- The audio mode is the one selected in the source unit. (32 k/48 k)
- Set BACKUP REC: DV to "OFF" if the unit is not performing backup recording.

## RECORDING

### Recording with SERIAL REMOTE terminals

Recording can be turned ON/OFF with a serial remote controller or foot switch connected to the serial remote terminal located at the rear panel of BR-HD50.

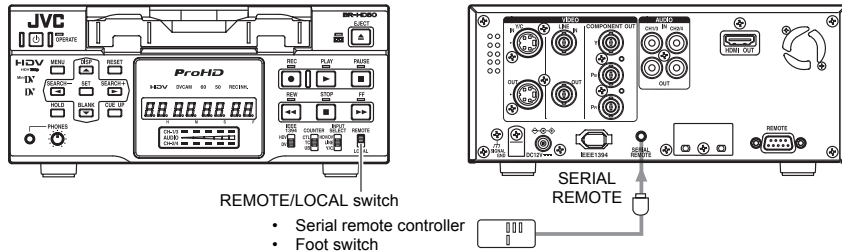

### Connection

The serial remote controller can be connected to the SERIAL REMOTE terminal located on the rear panel of BR-HD50.

### Setting

- To use the SERIAL REMOTE terminal, set REMOTE SEL SER in the REMOTE [1/2] Menu screen to ON or LOC+REM. Then, set the REMOTE/LOCAL switch on the front panel accordingly.

#### ● REMOTE SEL SER

**ON** : When the REMOTE/LOCAL switch is set to REMOTE, operations can be performed via the SERIAL REMOTE terminal.

**LOC+REM** : With the REMOTE/LOCAL switch is set either way, operations can be performed via the SERIAL REMOTE terminal. With this setting, the buttons and switches of the unit can be used too.

- Set FOOT SW in the REMOTE [2/2] Menu screen according to how the SERIAL REMOTE terminal is used.

**OFF** : Set to OFF when the serial remote controller is used. The footswitch cannot be used.

**L EDGE** : Recording and recording pause is switched at the LOW edge of the footswitch signal.

**H EDGE** : Recording and recording pause is switched at the HIGH edge of the footswitch signal.

**L LEVEL** : Recording is performed at the LOW edge and paused at the HIGH edge of the footswitch signal.

### Operation

Before using the foot switch, set BR-HD50 to the RECORDING or RECORDING PAUSE mode using the relevant buttons of the unit. (Only with L EDGE and H EDGE)

### — Memo

- The foot switch can only be used to switch between RECORDING ON and OFF.
- The foot switch can be operated regardless of the setting of the REMOTE/LOCAL switch.

### REMOTE [1/2] Menu screen

```

---REMOTE [ 1 / 2 ] ---
REMOTE SEL 9P ON
REMOTE SEL SER ON
REM SEL HDV/DV ON
LOCAL FUNCTION STP+EJT
PREROLL 7SEC
NEXT PAGE
PAGE BACK
    
```

### — Memo

- Besides recording, the serial remote controller can perform other functions.
- If the REMOTE SEL SER is set to ON, unit buttons that can be operated can be selected from LOCAL FUNCTION in the REMOTE [1/2] Menu screen.

### REMOTE [2/2] Menu screen

```

REMOTE [ 2 / 2 ]
REM FF/REW MODE FF/REW
REM STOP SEL EE
PB START DELAY 0F
SYNCHRONIZATION ON
CONTROLLER SEL TYPE1
FOOT SW L EDGE
PAGE BACK
    
```

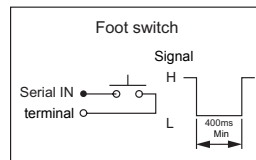

## PLAYBACK

### Playback settings

### Video settings

This unit plays back tapes recorded in HDV, DV, or DVCAM format. (SP mode only)

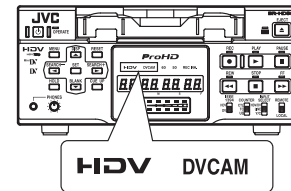

When playing back tapes recorded in HDV or DVCAM format, the front panel HDV or DVCAM indicator is lit.

- Selecting playback video format

Set whether to automatically detect the video format for playback, or to select a specific format, using PB TAPE FORMAT on the SYSTEM [2/2] Menu screen.

[Settings: AUTO, DV, HDV, DVCAM]  
(Details: Page 69)

- Setting IEEE1394 terminal output video format

Set the IEEE1394 terminal output video format to HDV or DV.

Set the IEEE1394 switch on the front panel, according to the playback video format.

**HDV** : Use this setting when the playback tape video format is HDV.

**DV** : Use this setting when the playback tape video format is DV or DVCAM.

### — Memo

- When playing back a tape recorded in HDV format, match the unit HD signal format (60Hz or 50Hz) to the playback signal format. (Page 40 "Selecting HD signal format")
- Playback output signal format: Page 34

### Setting VIDEO Menu screen

- Selecting video format for HDMI OUT terminal and COMPONENT OUT terminal

#### ● OUT FORMAT [60]/[50]

Select the playback image format to output from the HDMI OUT terminal and the COMPONENT OUT terminal. (Cross converter video)  
[Settings [60]: NATIVE, 480i, 480P, 1080i, 720P]  
[Settings [50]: NATIVE, 576i, 576P, 1080i, 720P]

- Automatic selection of HDMI OUT terminal video output

#### ● MONITOR SELECT

To automatically match the playback image format output from the HDMI OUT terminal to the video format of the connected display, set this menu item to HDM[A].  
[Settings: HDM[A]/OUT FRMT]

- Screen display style for up/down-converter video

#### ● DOWN CONV. MODE

The HDV signal is a wide-screen video signal. When playing a tape recorded in HDV format, the output from the LINE OUT terminal and Y/C OUT terminal will be down-converted playback images (480i/576i).

Set the style for displaying the down-converted playback image on a display with a 4:3 aspect ratio.

This will also apply to down-converted playback images (480i/576i) output from the COMPONENT OUT terminal.

[Settings: SQUEEZE/LETTER BOX/SIDECUT]

- UP CONV. MODE

Up-converts DV/DVCAM recorded tape playback signals, and sets the video mode for output from the COMPONENT OUT terminal.  
[Settings: FULL/SIDE P.]

- Setting analog signal setup (U model only)

#### ● SET UP [60]: DV

Set enabling or disabling the application of setups to analog video signals (composite, Y/C separate, and SD component).

VIDEO menu details: Page 73 to 75

## PLAYBACK

### Playback settings (continued)

#### Audio settings

Set audio settings using the AUDIO Menu screen.

#### Setting AUDIO Menu screen

##### ■ Selecting output audio channel (DV only)

###### ● A.OUTPUT: DV

To play back tapes recorded in the 32kHz mode, select the output audio channel for the AUDIO OUT terminal or the PHONES terminal. In the 48kHz mode or HDV format, the audio of CH1 and CH2 is output regardless of the setting of this menu item.

[Settings: CH-1/2, MIX, CH-3/4]

##### ■ Selecting audio output during search (DV only)

###### ● A. OUT AT SRH: DV

For selecting whether sound is output during variable speed playback. In HDV format, audio is not output during search, regardless of the setting of this menu item.

[Settings: ON, OFF]

##### ■ Selecting the standard audio output level

###### ● AUDIO OUT LEVEL

Select the standard audio output level. Set to -12dB to playback tapes recorded at -12dB on a home-use DV machine.

[Settings: -20dB, -12dB]

##### ■ Selecting V. fade function (DV only)

###### ● V.FADE: DV

Select whether to fade the audio during playback at jointed portions of recording. No fading occurs for HDV format.

[Settings: OFF, ON]

#### Settings regarding playback function

Set various functions in the SYSTEM Menu screen.

#### Setting SYSTEM Menu screen

##### ■ Selecting still pictures or frame-advance playback (DV only)

###### ● STL/F.ADV: DV

Selects still pictures or frame-advance playback when playing back DV format video.

[Settings: FIELD, 1ST FIELD, 2ND FIELD, FRAME]

When playing back HDV format video, frame images are output, regardless of the setting of this menu item.

##### ■ Selecting still mode

###### ● LONG PAUSE TIME

For setting the time (minute) when BR-HD50 enters the tape protection mode if BR-HD50 is in the STILL mode for a long time.

[Settings: 5, 3, 2, 1 minute or 30 seconds]

###### ● LONG PAUSE MODE

For selecting the state of BR-HD50 when it enters the tape protection mode after it stayed in the STILL mode for a prolonged period of time.

[Settings: F.ADV or STBY-OFF]

##### ■ Selecting ◀, ▶ button functions

###### ● “◀, ▶” KEY FUNC.

Select whether to use the SEARCH+ (▶) and SEARCH- (◀) buttons for index search, or to change the search speed.

[Settings: INDEX, VAR/RECV]

##### ■ Selecting repeat playback function

###### ● REPEAT MODE

This mode is for turning ON/OFF the REPEAT PLAYBACK function and selecting the type of REPEAT PLAYBACK. If REPEAT PLAYBACK is not performed, set it to OFF.

[Settings: OFF, INDEX, V. END, TAPE END]

## PLAYBACK

### Basic playback procedure

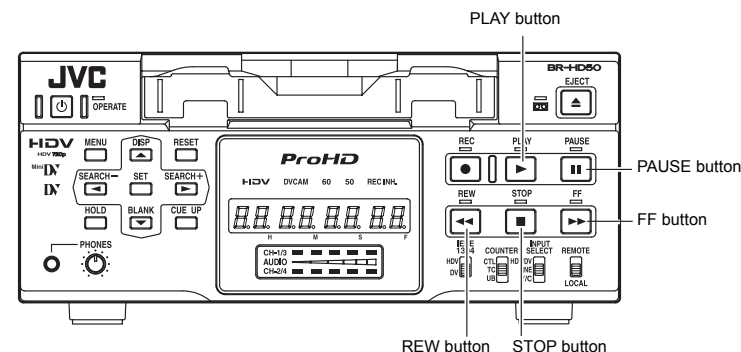

#### 1. Load a recorded cassette tape.

→ The power for BR-HD50 is turned on.

#### 2. Start playback.

Press the PLAY button.

→ Playback starts.

When playing back tapes recorded in HDV format, the front panel HDV indicator is lit.

When the tape is recorded in DVCAM format, the DVCAM indicator is lit.

#### 3. Pause the tape.

Press the PAUSE button.

→ A still image is output.

#### — Memo

The still image selected with STL/F.ADV: DV in the SYSTEM [1/2] Menu screen is output. (1st field image/ 2nd field image/ frame image)

Playback of HDV format tapes is always in frame image output.

#### 4. Resume playback.

Press the PLAY button.

#### 5. Stop playback.

Press the STOP button.

#### Fast forward/rewind

##### ■ When BR-HD50 is in the STOP mode, press the FF button to fast-forward the tape.

##### ■ When BR-HD50 is in the STOP mode, press the REW button to rewind the tape.

#### — Note

Tapes recorded in the LP mode cannot be played. The monitor displays an alarm message: "LP TAPE!"

#### — Memo

● Press the DISPLAY button during PLAY mode to display the playback video format on the counter display.

● When output of still image continues for a prolonged period, BR-HD50 enters the tape protection mode.

#### Playback of tapes recorded in HDV format

Set 60/50 SEL in the SYSTEM [2/2] Menu screen, according to the HD signal format. (60Hz or 50Hz)

#### IEEE1394 terminal output signal

To use the IEEE1394 terminal output signal, set the front panel IEEE1394 switch according to the video format of the playback tape. (HDV or DV)

## PLAYBACK

### Special playback functions

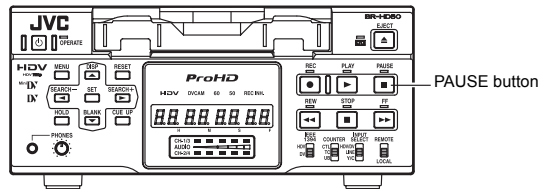

### Frame-advance playback

#### Setting

##### ■ STL/F. ADV: DV in the SYSTEM [1/2] Menu screen

The unit of frame advance and still images can be selected. (DV format only)

**FIELD** : Field-by-field advance

**1st FIELD** : Frame-by-frame advance and stops at the 1st field.

**2nd FIELD** : Frame-by-frame advance and stops at the 2nd field.

**FRAME** : Frame-by-frame advance.

- Does not frame-advance when playing back an HDV tape.

#### SYSTEM [1/2] Menu screen

```

---SYSTEM [1/2]---
P>STL/F.ADV :DV      2ND
BACKUP REC :DV      OFF
LONG PAUSE TIME 30SEC
REC LONG P. TIME 5MIN
LONG PAUSE MODE STBY-OFF
~4~P~ KEY.FUNC. VAR/RECV
REPEAT MODE      OFF
NEXT PAGE
PAGE BACK
    
```

#### Operation

1. Set BR-HD50 to the STILL mode.
2. Press the PAUSE button to perform frame advance.

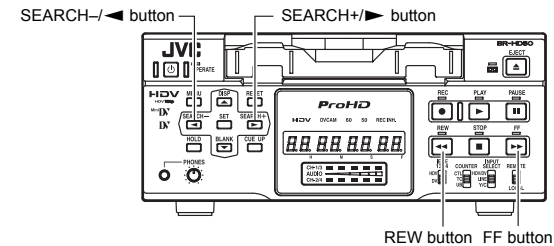

### Slow playback and Search mode

#### Setting

- Set “◀, ▶” KEY FUNC in the SYSTEM [1/2] Menu screen to VAR/RECV.

#### Operation

1. Set BR-HD50 to the PLAYBACK or the STILL mode.
  2. Press the FF button to start fast-forward playback. Press the REW button to start reverse playback.
- Press the SEARCH+ button to increase the search speed. Every time you press this button, the speed increases more.
  - Press the SEARCH- button to decrease the search speed. Every time you press this button, the speed decreases more.

#### Search speed

SEARCH+ button → (Fast) (Slow) ← SEARCH- button

##### ■ DV recorded tape playback

x-20·x-9 (U) / -10 (E) ·x-5·x-2·x-1·x-0.5·x-0.33·  
x-0.2·x-0.1·STILL·x0.1·x0.2·x0.33·x0.5·x1 (PLAY)·  
x2·x5·x9 (U) / 10 (E) ·x20  
(U): U model  
(E): E model

\* The maximum speed in the DVCAM mode is 15x.

##### ■ HDV recorded tape playback

x-16·x-6.5·x-4.5·x-2.5·x-1.5·STILL·x1 (PLAY)·  
x2.5·x5·x8.5·x18

- Cannot perform slow playback when playing back an HDV tape.

#### — Memo —

- Whether to enable/disable audio out in the Slow playback or SEARCH mode can be selected with A. OUT AT SRH: DV in the AUDIO Menu screen.
- Search audio is not output for HDV format.
- Playback at  $\pm 0.1 \times$  speed is step-slow playback (continuous frame-advance playback/frame-reverse playback).
- In step-slow playback, video is output according to the STL/F.ADV: DV setting in the SYSTEM [1/2] Menu screen. (DV format only)
- When step-slow playback is continued, the speed is automatically set to  $\pm 0.2 \times$ .
- During slow-playback or frame-advance, noise is generated to the output images from the IEEE1394 terminal. For recording slow-playback images, use analog output signals of BR-HD50.

## PLAYBACK

### Search function

#### Index search

This function searches to the position where the index signal is recorded.

#### Setting

Set "◀, ▶" KEY FUNC in the SYSTEM [1/2] Menu screen to INDEX.

#### Operation

##### ■ To search an index point in the forward direction from the current tape position:

- Press the SEARCH+ button.  
The index position to be searched can be specified by the number of times this button is pressed. (Max: 99)

##### ■ To search an index point in the reverse direction from the current tape position:

- Press the SEARCH- button.  
The index position to be searched can be specified by the number of times this button is pressed. (Max: 99)

##### ■ When the SEARCH+ or SEARCH- button is pressed, the unit fast-forwards or rewinds to the specified indexed position and start playing.

#### — Memo

- If the interval between index signals is less than one minute, the function may not work well.
- The specifications for index signal recording varies with the device used.

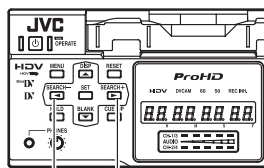

SEARCH- button    SEARCH+ button

Monitor screen

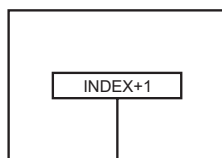

Index search progressing:  
displayed on the screen  
(The number denotes the corresponding index position.)

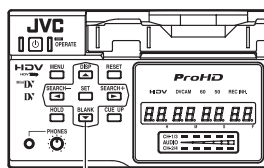

BLANK button

Monitor screen



#### Blank search

This function searches unrecorded parts of the tape.

##### ■ In the STOP mode, press the BLANK button.

- • If the current position is at a recorded part of the tape, BR-HD50 fast-forwards until an unrecorded part is reached and stops there.
- If the current position is an unrecorded part of the tape, BR-HD50 will first advance the tape in the forward direction for confirmation and thereafter rewind and go into the STILL mode at the last recorded position.
- During a blank search, "BLANK SEARCH" is displayed on the monitor.

## PLAYBACK

### Repeat playback

Three types of repeat playback are available for BR-HD50.

The repeat playback function can be set with REPEAT MODE in the SYSTEM [1/2] Menu screen.

#### Setting

##### ■ REPEAT MODE in the SYSTEM [1/2] Menu screen

- OFF : No repeat playback.  
 INDEX : Repeat playback between positions where index signals are recorded.  
 V. END : Repeat playback from the beginning of the tape to the position where recording of video signals ends.  
 TAPE END : Repeat playback from the beginning to the end of the tape.

#### Operation

1. Press the REW button to rewind the tape to the beginning.
  2. Press the PLAY button to start playback.  
→ When it reaches the position set at REPEAT MODE, the tape starts rewinding and plays back again.
- To abort the repeat playback function, press the STOP button.

#### Repeat operation

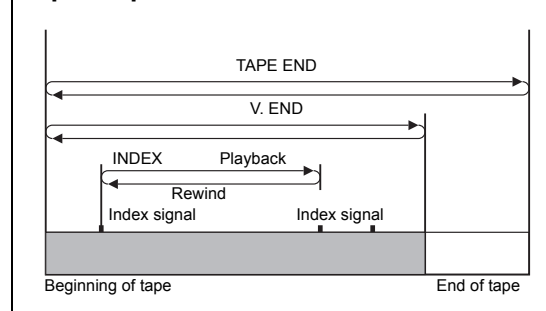

#### SYSTEM [1/2] Menu screen

```

---SYSTEM[1/2]---
STL/F. ADV : DV      2ND
BACKUP REC : DV      OFF
LONG PAUSE TIME 30SEC
REC LONG P.TIME 5MIN
LONG PAUSE MODE STBY-OFF
"<D>" KEY FUNC.  VAR/REC
REPEAT MODE      INDEX
NEXT PAGE
PAGE BACK
  
```

#### INDEX repeat playback

- If no index signal is detected during playback, the tape will run until the end. If no index signal is detected during rewind, the tape will rewind until the beginning.
- If the interval between index signals is less than one minute, the function may not work well.

#### — Memo

If the head is dirty, repeat playback may not work well.

## PLAYBACK

### Multi cue-up

Using the time codes recorded on the tape, up to 5 points on the tape can be registered as cue-up points at the Multi Cue-up screen. The registered tape positions (cue-up points) can be searched.

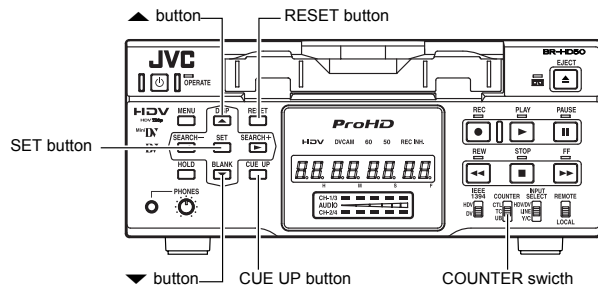

### Registering cue-up points

1. Set the COUNTER switch to TC.
2. Load a tape with time codes recorded.
3. Press the CUE UP button.
  - The MULTI CUE UP screen appears on the monitor.
4. Perform playback or search. At the position to be registered, set it to the STILL or STOP mode.
5. Press the ▲ or ▼ button to bring the cursor to the cue-up point. Press the SET button.
  - Register the time code data of the current position as a cue-up point.
  - If no tape is loaded, "00" is registered.
  - Cue-up points can be registered while the tape is being played back.
6. To register more cue-up points, repeat steps 4 and 5. Up to 5 cue-up points can be registered.

### — Memo —

For details on time code setting and recording: (Page 58)

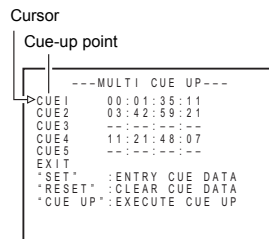

MULTI CUE UP screen

### Clearing registered cue-up points

Press the ▲ or ▼ button to bring the cursor to the cue-up point to be cleared. Press the RESET button.
 

- After a cue-up point is cleared, "—" is displayed.

### Changing cue-up points

1. Press the ▲ or ▼ button to bring the cursor to the cue-up point to be changed. Press the ► button.
  - The hour digits of the registered time code display blink. Press the ► button to select the digit to be changed.
2. Press the ▲ or ▼ button again to change the time code.
  - Press the ▲ button to increase the time code data.
  - Press the ▼ button to decrease the time code data.
3. Press the SET button to register the changed time code.
  - If no time code is to be registered, do not press the SET button. Instead, press the ◀ button to make the blinking time code display disappear.

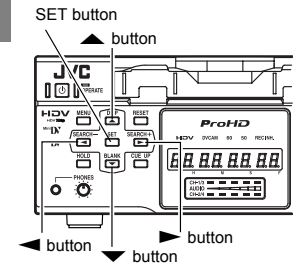

### — Memo —

If the COUNTER switch is set to CTL or UB while the Multi Cue-up screen is being displayed, the display returns to the normal screen.

### Exiting the Multi Cue-up screen

Press the ▲ or ▼ button to bring the cursor to EXIT. Press the SET button.
 

- The display of the monitor returns to the normal screen.

### Searching cue-up points

1. Set the COUNTER switch to TC.
2. Press the CUE UP button when the normal screen is displayed.
  - The Multi Cue-up screen appears on the monitor.
3. Press the ▲ or ▼ button to bring the cursor to the cue-up point to be searched.
4. Press the CUE UP button.
  - The cue-up operation for the selected point is performed.

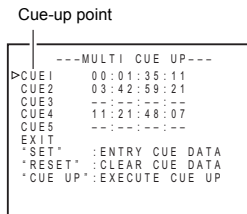

Multi Cue-up screen

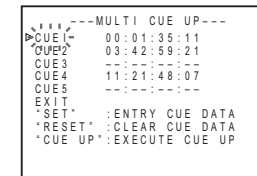

During cue-up operation

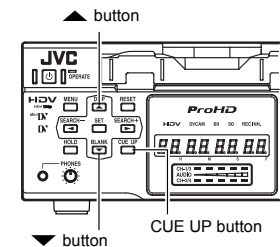

While searching is being performed, the cue-up point to be searched flashes on the monitor.

### — Memo —

- For cue-up operation, use tapes with continuous time codes recorded.
- If the COUNTER switch is set to CTL or UB while the Multi Cue-up screen is being displayed, the COUNTER mode does not change.

## TIME CODE

### Displaying the time code

This unit records or plays back the time code and user's bit. Whether to record the user's bit can be selected with U-BIT in the TC/UB/CLOCK [2/2] Menu screen (only for E model). With the time code function, accurate positions of the tape contents can be specified to enhance editing precision and operation efficiency. During recording or playback, the time code and user's bit are displayed on the monitor or the Counter display.

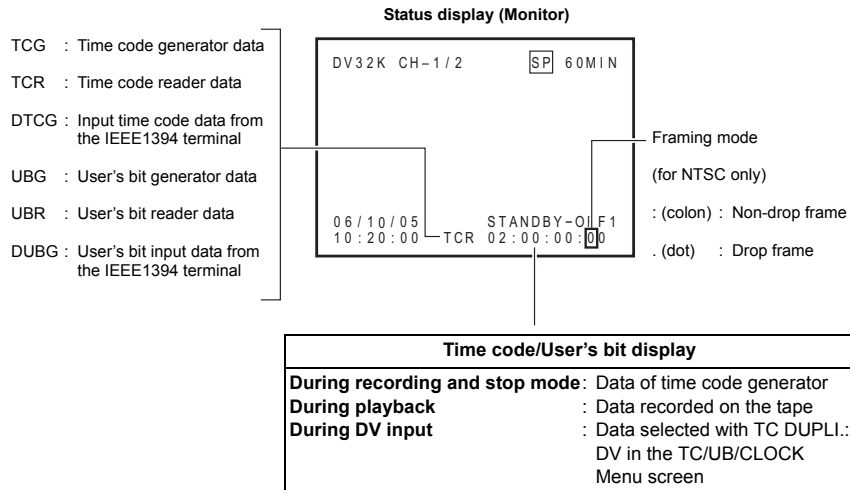

### ■ To display the time code/ user's bit, perform the following settings.

- Set DISPLAY in the DISPLAY Menu screen to ON or AUTO.  
 → The status is displayed on the monitor.
- Set TIME CODE in the DISPLAY Menu screen to ON.  
 → The time code, user's bit or CTL counter is displayed at the counter display section of the status display.
- Select the counter display mode with the COUNTER switch on the front panel.  
 To display the time code, select TC.  
 To display the user's bit, select UB.

#### Checking the data of time code generator

When it is in the STOP mode, press the REC button and the data of the time code generator will be displayed while the button is held down.

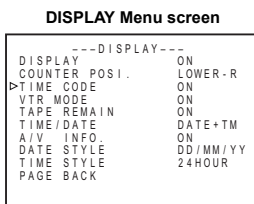

The display position can be selected.

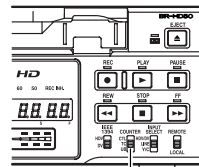

COUNTER switch

## TIME CODE

### Presetting the time code

Variable values can be set for the time code and the user's bit for efficient material management and editing.

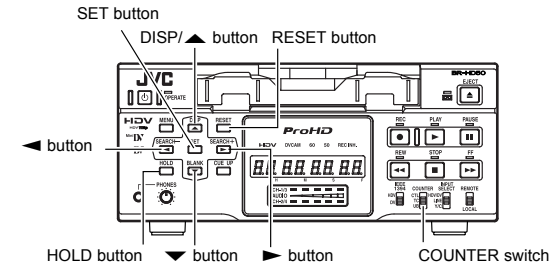

### Setting ...TC/UB/CLOCK [1/2] Menu screen

- **Set TCG SELECT to "PRESET".**  
 The time code advance mode is REC-RUN mode.  
 REC-RUN: The time code runs only during recording.
- **NDF/DF [60] (U model only)**  
 NON-DROP: Enters non-drop frame mode. Use this setting when emphasizing the frame count.  
 DROP: Enters drop-frame mode. Use this setting when emphasizing the recording time.

### TC/UB/CLOCK[1/2] Menu screen

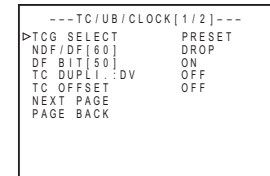

### Operation ...Perform setting while checking the Counter display.

This section describes the setting of the time code. The setting of the user's bit is the same. Values that can be used to configure the user's bit are hexadecimal numeral from 0 - F.

1. **Set the COUNTER switch to TC.**  
 (For user's bit, set the switch to UB.)
2. **In the STOP mode, press the HOLD button.**  
 → The hour digit of the counter starts blinking.
3. **Press the ▲ or ▼ button to change the value.**
4. **Press the ► or ◀ button to move blinking to the next digit.**
5. **Press the ▲ or ▼ button to change the value of the blinking digit.**
6. **Repeat steps 4 and 5 to perform the necessary settings.**
7. **Press the SET button to confirm the setting value and blinking of the counter stops.**  
 → The setting is preset to the time code generator.

### — Memo —

- To stop the setting, press the HOLD button to return to the normal screen.
- To preset all digits to 0, press the RESET button when any of the digits is blinking.
- When the hour digit is blinking, the frame digit starts blinking when the ◀ button is pressed.
- If a user's bit is input with its all digits set as "F", BR-HD50 converts FFFFFFFF to FFFFFFFE before recording.



## TIME CODE

### Recording the time code

Time codes can be recorded with the following ways. Whether to record user's bit can be selected with U-BIT in the TC/UB/CLOCK [2/2] Menu screen. (Only for E model)

- Record it from preset data.
- Record it following the one last recorded on the tape.
- Record the time code, which is input to the IEEE1394 terminal. (In DV mode only)

### Recording from preset data

Record preset time code data to the internal time code generator in the TIME CODE Preset screen.

#### Setting

- Set the TC/UB/CLOCK [1/2] Menu as follows.

**TCG SELECT** : PRESET

The time code advance mode is REC-RUN mode.

**NDF/DF [60]** : NON DROP or DROP (U model only)

#### Operation

1. Check the preset time code.

① Set the COUNTER switch to TC or UB.

② In the STOP mode, hold down the REC button.

→ The preset time code or the user's bit is displayed on the monitor. The counter mode is displayed as TCG or UBG.

③ When the REC button is released, it returns to the original display.

2. Record.

Press the PLAY button while holding down the REC button.

→ The time code and user's bit are recorded.

To stop recording, press the STOP button.

#### Preset time code

Stopping the power supply to the DV IN terminal of BR-HD50 cancels the preset value of the time code generator.

#### TC/UB/CLOCK [1/2] Menu screen

```

---TC/UB/CLOCK[1/2]---
>TCG SELECT    PRESET
NDF/DF[60]    DROP
DF BIT[50]    ON
TC DUPLI.:DV  OFF
TC OFFSET     OFF
NEXT PAGE
PAGE BACK
    
```

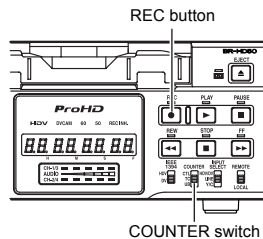

### Recording time code following the one last recorded on the tape

BR-HD50 is equipped with a time code reader. When it enters the RECORD mode from the RECORDING PAUSE mode, it reads the time code data already recorded on the tape and continues recording time code from that value. (Regeneration)

#### Setting

- Set the TC/UB/CLOCK [1/2] Menu as follows.

**TCG SELECT** : REGEN

**NDF/DF [60]** : No setting required. The framing mode will match the tape. (U model only)

#### Operation

1. Insert a tape with time codes recorded.
2. Set BR-HD50 to the RECORDING PAUSE mode at the position where time codes are to be recorded again.
3. Press the PLAY button to go to the RECORDING mode.
  - Time codes will be recorded on the tape, starting from where it stopped at last recording.
  - The counter mode display shows either TCR or UBR.

#### TC/UB/CLOCK [1/2] Menu screen

```

---TC/UB/CLOCK[1/2]---
>TCG SELECT    REGEN
NDF/DF[60]    DROP
DF BIT[50]    ON
TC DUPLI.:DV  OFF
TC OFFSET     OFF
NEXT PAGE
PAGE BACK
    
```

### Recording time code, input to the IEEE1394 terminal (In DV mode only)

#### Setting

- Set the INPUT SELECT switch on the front panel to HDV/DV.

- Set TC DUPLI.: DV in the TC/UB/CLOCK [1/2] Menu screen to AUTO.

\* To record the time code from a BR-DV600 or GY-DV500 in non-drop frame mode, set TC DUPLI.: DV to NON DROP. (U model only)

#### TC/UB/CLOCK [1/2] Menu screen

```

---TC/UB/CLOCK[1/2]---
TCG SELECT    PRESET
NDF/DF[60]    DROP
DF BIT[50]    ON
>TC DUPLI.:DV  AUTO
TC OFFSET     OFF
NEXT PAGE
PAGE BACK
    
```

#### Operation

1. Check the time code of the IEEE1394 terminal.
  - Press the REC button when BR-HD50 is in the STOP mode to display the time code on the monitor. It will be displayed while the button is held down.
  - The counter mode display shows DTCG or DUBG.
2. Select the RECORDING mode.
  - Record time codes from the IEEE1394 terminal.

#### — Memo

For date/time also, data from the IEEE1394 terminal are recorded.

## TIME CODE

### Playing back the time code

BR-HD50 is also equipped with a time code reader. During playback, the time code or user's bit data recorded on the tape is displayed on the monitor or the counter display.

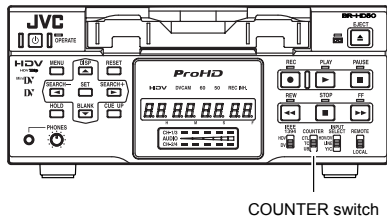

COUNTER switch

#### 1. Select the time code data to display.

Set the COUNTER switch to "TC" or "UB".

#### 2. Press the PLAY button to go to the PLAYBACK mode.

→ It displays the time code and the user's bit on the monitor or the counter display. The counter display mode becomes TCR or UBR.

Monitor (Status display)

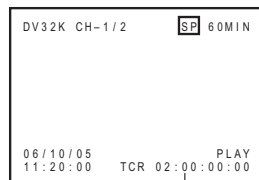

Time code or user's bit

#### Caution on time code playback

- During playback, if a portion of tape without recorded time code runs through, the time code stops running. Playback continues.
- If tapes without recorded user's bit, e.g. those recorded with a home-use DV VCR, are played back on BR-HD50, "--" is displayed.

## EDIT

### Using a non-linear editing system

Tape contents of BR-HD50 are captured by a non-linear editing system and the non-linear edited contents are recorded on BR-HD50.

#### Connection

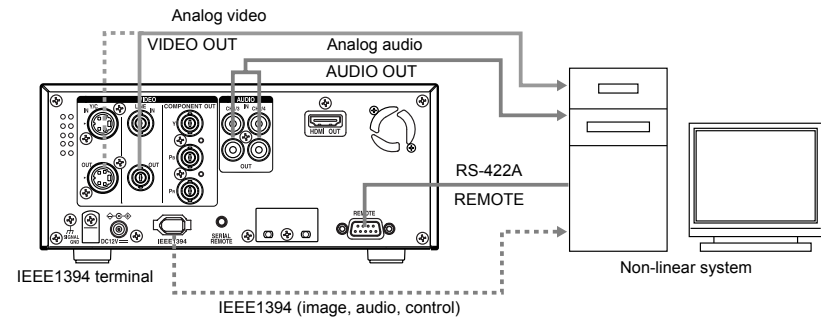

#### Control with RS-422A (Analog signals)

##### Setting

- Set the REMOTE/LOCAL switch on the front panel to REMOTE.
- REMOTE [1/2] Menu screen
  - Set REMOTE SEL 9-PIN to "ON".
- REMOTE [2/2] Menu screen
  - REMOTE FF/REW MODE: Use this item to select the operation to be performed if the FF or REW command is received during playback. (FF/REW or Search) If the search operation is not performed properly, set it to "SEARCH".
  - CONTROLLER TYPE (in the REMOTE [2/2] Menu screen): Set this item to "TYPE1".

#### Control with the IEEE1394 terminal (Digital signals)

##### Setting

- Set the INPUT SELECT switch located on the front panel to HDV/DV.
- Set the IEEE1394 switch located on the front panel to match the video format.
  - Set to DV position for DV mode, and to HDV position for HDV mode.
- Set the REMOTE/LOCAL switch on the front panel to the position matching the REMOTE menu below.
- REMOTE [1/2] Menu screen
  - Set REM SEL HDV/DV to ON or LOC+REM. Set this item to ON if it is to become enabled only when the REMOTE/LOCAL switch on the front panel is set to REMOTE. Set this item to LOC+REM if it is to become enabled regardless of the position of the REMOTE/LOCAL switch.

#### Memo

- If the time code of BR-HD50 is not displayed correctly when the non-linear side moves one frame forward or backward, set the STL/F.ADV: DV in the SYSTEM [1/2] Menu screen to "FRAME." (in DV mode only)
- When controlling with RS-422A using the HDV format, only the capture operation is supported.

## MENU SCREENS

### Setting the menus

The functions of BR-HD50 are configured in the Menu screens. The configured settings are saved in the memory of BR-HD50 and retained even after power off.

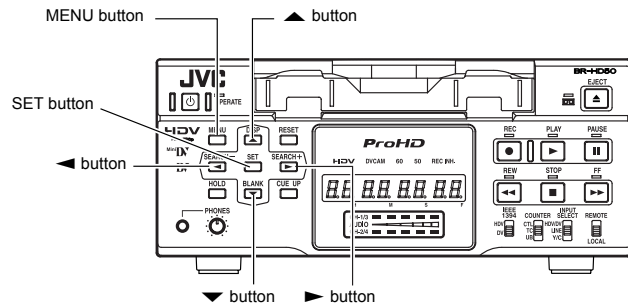

Perform the menu settings while viewing the display on the monitor.

The counter display shows menu code numbers.

#### ■ Set BR-HD50 to the STOP or STILL mode.

##### 1. Displaying the TOP MENU screen.

Press the MENU button.

##### 2. Displaying the Menu screen items for setting.

- ① Press the ▲ or ▼ button to bring the cursor to the Menu screen item for setting.
- ② Press SET or the ► button.

Select EXIT of the TOP Menu screen to return to the normal screen.

##### 3. Setting the Menu item for setting.

- ① Press the ▲ or ▼ button to bring the cursor to the Menu screen item for setting.
- ② Press SET or the ► button.
  - The selected setting value blinks and becomes available for changing.
- ③ Press the ▲ or ▼ button to change the value.
- ④ Press the SET button to confirm the change.
  - Blinking stops and the new value is confirmed.
- ⑤ Repeat steps ① - ④ and continue setting as necessary.

TOP Menu screen

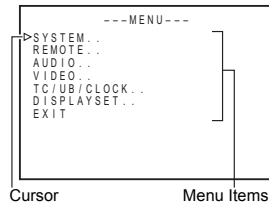

Cursor Item Setting value

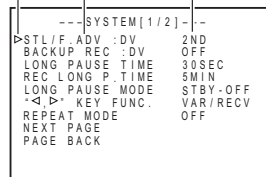

#### ■ To display the Menu screen at the next level, bring the cursor to NEXT PAGE and press the SET or ► button.

#### ■ To return to the previous Menu screen, do one of the following actions.

- Press the ► button.
- Or
- Select PAGE BACK and press the SET or ► button.

#### 4. To return to the normal screen, do one of the following actions.

- Press the MENU button.
- Or
- Select EXIT in the TOP Menu screen and press the SET or ► button.

SYSTEM [1/2] Menu screen

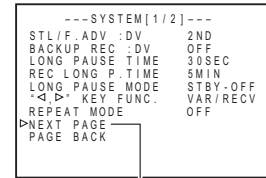

SYSTEM [2/2] Menu screen



### Menu screen on counter display

The counter display shows menu code numbers when setting menus.

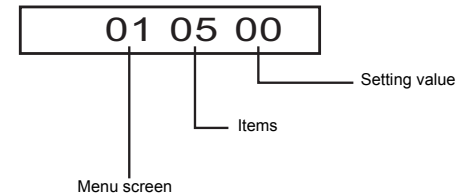

(Example) 01: SYSTEM Menu screen

- Menu display : Flashes when the TOP MENU screen is displayed.
- Items : Flashes when each menu screen is displayed. (No settings are selected yet.)
- Setting : Flashes when a menu item is selected and the setting on the monitor display is flashing.

# MENU SCREENS

## Structure of the Menu screens

The Menu screens are displayed on the monitor. They are structured with multiple layers.

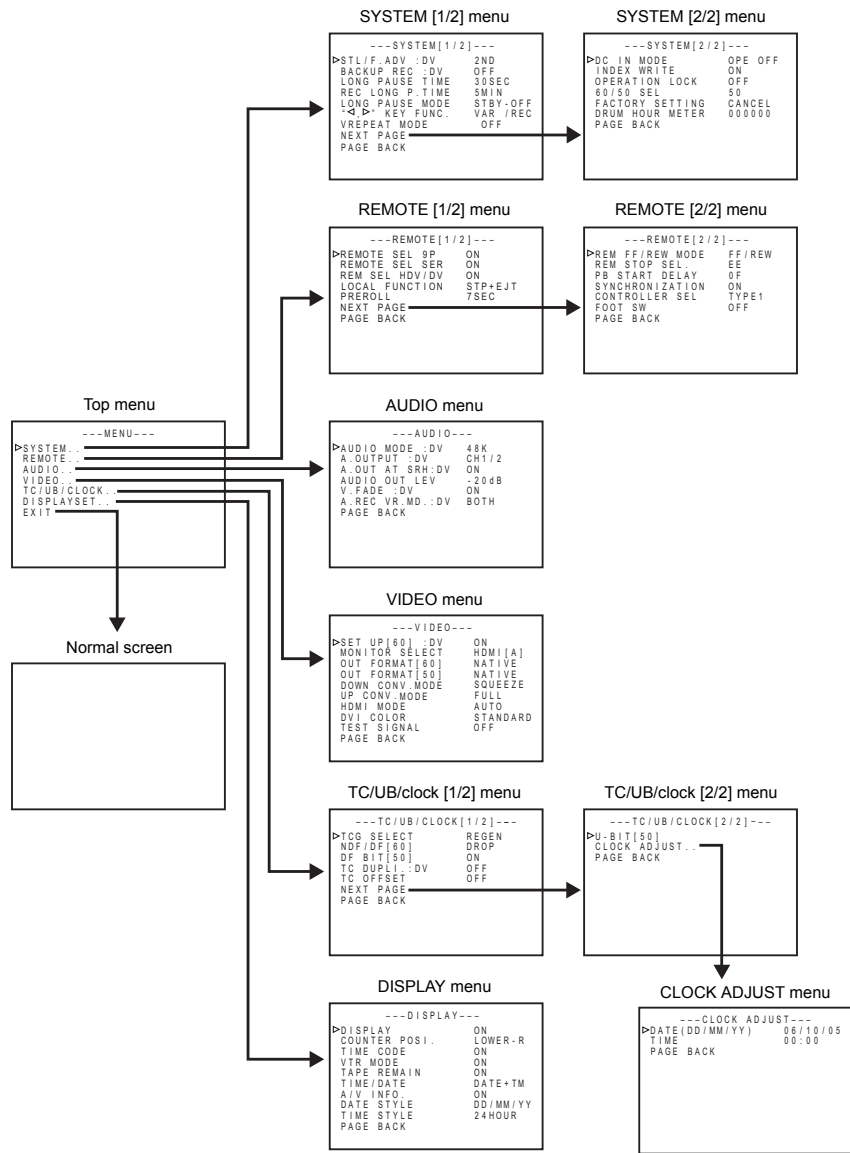

# MENU SCREENS

## Description of the Menu screens

In the following description of the Menus, ☆ indicates factory settings. Numbers in parentheses by items and settings are the code number shown on the counter display.

### TOP Menu screen

Item	Setting	Description
SYSTEM..	-	Displays the menus related to the operating system of BR-HD50. It also displays factory setting and the drum hour meter.
REMOTE..	-	Displays the menus related to the remote controller.
AUDIO..	-	Displays the menus related to the audio.
VIDEO..	-	Displays the menus related to the video.
TC/UB/CLOCK..	-	Displays the menu for setting time codes. Also displays the date/time setting screen.
DISPLAYSET..	-	Displays menus related to on-screen display.
EXIT	-	Return to the normal screen.

### SYSTEM Menu screens

The SYSTEM Menu consists of the following two screens (1/2 and 2/2).

#### ■ SYSTEM [1/2] Menu screens

Item	Setting	Description
STL/F.ADV: DV (0100)	FIELD (00) 1ST (01) ☆2ND (02) FRAME (03)	Use this setting to select the still image for the STILL mode or frame-advance playback. (During DV format video playback) <b>FIELD</b> : Displays the field image. During frame-advance playback, it displays the 1st and 2nd field images alternately. <b>1ST</b> : Displays the 1st field image. <b>2ND</b> : Displays the 2nd field image. <b>FRAME</b> : Displays the frame image.  — <b>Memo</b> — ● Playback of HDV format tapes is always in frame image output, regardless of menu settings. ● The first field image is displayed as the DV output image from the IEEE1394 terminal, regardless of the settings.
BACKUP REC : DV (0101)	☆OFF (00) 25MIN (01) 55MIN (02) 75MIN (03) 115MIN (04) 175MIN (05) 265MIN (06)	For setting backup recording time with DV input signals according to the tape length of the source unit: <b>OFF</b> : No backup recording <b>25MIN</b> : For a 30-minute source unit recording tape <b>55MIN</b> : For a 60-minute source unit recording tape <b>75MIN</b> : For a 80-minute source unit recording tape <b>115MIN</b> : For a 120-minute source unit recording tape <b>175MIN</b> : For a 180-minute source unit recording tape <b>265MIN</b> : For a 270-minute source unit recording tape (☞ Page 47 "Backup recording function")  — <b>Memo</b> — Set this item to "OFF" if DV REC TRIGGER of GY-DV5000/DV5100 is set to ON.

## MENU SCREENS

### Description of the Menu screens (continued)

#### SYSTEM Menu screens (continued)

Item	Setting	Description
<b>LONG PAUSE TIME (0102)</b>	☆30SEC (00) 1MIN (01) 2MIN (02) 3MIN (03) 5MIN (04)	Select the time when BR-HD50 enters the TAPE PROTECTION mode if the unit has stayed at still or stop for a prolonged period of time. The TAPE PROTECTION mode in at STILL can be selected from LONG PAUSE MODE: <b>30SEC</b> : 30 seconds <b>1MIN</b> : 1 minute <b>3MIN</b> : 3 minutes <b>2MIN</b> : 2 minutes <b>5MIN</b> : 5 minutes  — <b>Memo</b> — To prevent the video head from clogged or the tape from being damaged, set as short a time as possible.
<b>REC LONG P.TIME (0103)</b>	30SEC (00) 1MIN (01) 2MIN (02) 3MIN (03) ☆5MIN (04)	Select the time when BR-HD50 enters the TAPE PROTECTION mode if the unit has stayed at recording pause for a prolonged period of time. <b>30SEC</b> : 30 seconds <b>1MIN</b> : 1 minute <b>3MIN</b> : 3 minutes <b>2MIN</b> : 2 minutes <b>5MIN</b> : 5 minutes  — <b>Memo</b> — To prevent the video head from clogged or the tape from being damaged, set as short a time as possible.
<b>LONG PAUSE MODE (0104)</b>	F.ADV (00) ☆STBY-OFF (01)	For selecting the action when BR-HD50 stays at still for a long time. In the case of RECORDING PAUSE or STOP, it enters the STANDBY-OFF status: <b>F.ADV</b> : Frame-advances BR-HD50 five times in the forward direction. On the 6th attempt, this mode stops it. <b>STBY-OFF</b> : Stops BR-HD50.
<b>“◀,▶” KEY FUNC. (0105)</b>	INDEX (00) ☆VAR/RECV (01)	For selecting the function for the SEARCH+/▶ button and SEARCH-/◀ button. <b>INDEX</b> : Performs index search. (☞ Page 54) <b>VAR/RECV</b> : Changes the search speed during a search. (☞ Page 53) Enables adjusting analog audio input level. (☞ Page 44)
<b>REPEAT MODE (0106)</b>	☆OFF (00) INDEX (01) V. END (02) TAPE END (03)	For enabling/disabling repeat playback and selecting the type of repeat playback. <b>OFF</b> : No repeat playback <b>INDEX</b> : Repeat playback between the positions where index signals are recorded. <b>V. END</b> : Repeat playback from the beginning of the tape to the position where video signal recording ends. <b>TAPE END</b> : Repeat playback from the beginning to the end of the tape.
<b>NEXT PAGE</b>		For displaying the SYSTEM [2/2] Menu screen.
<b>PAGE BACK</b>		For returning to the TOP Menu screen.

#### ■ SYSTEM [2/2] Menu

Item	Setting	Description
<b>DC IN MODE (0107)</b>	☆OPE OFF (00) OPE ON (01)	For selecting the action to perform when the power is supplied to the DC IN terminal: <b>OPE OFF</b> : Sets BR-HD50 to the OPERATE OFF mode. <b>OPE ON</b> : Sets BR-HD50 to the OPERATE ON mode.
<b>INDEX WRITE (0108)</b>	OFF (00) ☆ON (01)	For enabling/disabling index signal recording. <b>OFF</b> : No index signal <b>ON</b> : Select here to record index signals. It records an index signal automatically at the position where recording starts.
<b>OPERATION LOCK (0109)</b>	☆OFF (00) ON (01)	For enabling/disabling OPERATION LOCK. <b>OFF</b> : Turns off OPERATION LOCK and the operation buttons of BR-HD50 can be used. <b>ON</b> : Turns on OPERATION LOCK. The operation buttons and slide switches of BR-HD50 are disabled except the OPERATE ON button and MENU operation. (☞ Page 36)
<b>60/50 SEL (010A)</b>	60 (00) 50 (01)	Sets HD video signal format to 60Hz or 50Hz. This menu item applies only to HDV format. This must be set in the following situations. • Set this menu item to match the input video signal format when inputting HDV signals to the IEEE1394 terminal. • Set this menu item to match the video format recorded on the tape when playing a tape recorded with HDV signals. <b>60</b> : The HD signal format becomes 60Hz. <b>50</b> : The HD signal format becomes 50Hz. [Settings upon shipping: U model: 60, E model: 50]  — <b>Memo</b> — • The unit restarts when this menu setting is changed. • The front panel 60 or 50 indicator is lit, according to this menu setting. • Recording and playback are unavailable when this menu setting differs from the HDV input signal or HDV recorded tape signal format. • During DV/analog signal input or when playing a tape recorded with DV/analog signals, the field frequency format is fixed for the region, regardless of this menu setting. [U model: 60Hz (NTSC), E model: 50Hz (PAL)]
<b>FACTORY SETTING (010b)</b>	☆CANCEL (00) EXECUTE (01)	For enabling/disabling the factory setting for the Menu screens. <b>CANCEL</b> : Disable the factory setting <b>EXECUTE</b> : Enable the factory setting  — <b>Memo</b> — The unit restarts when this menu setting is executed.
<b>PB TAPE FORMAT (010c)</b>	☆AUTO (00) DV (01) HDV (02) DVCAM (03)	Selects whether to automatically detect playback tape video format, or to playback only a specific format. <b>AUTO</b> : Automatically detects and plays back all video formats. <b>DV</b> : Plays back only video in DV format. <b>HDV</b> : Plays back only video in HDV format. <b>DVCAM</b> : Plays back only video in DVCAM format.  — <b>Memo</b> — • When set to a specific format and a tape with a different format is played back, there will be noise in the video. • If you play back a tape containing both DV and HDV formats, the video signal is disturbed when the signal is switched.
<b>DRUM HOUR METER</b>		For displaying the time of drum usage. * The cursor cannot be brought to this item.
<b>PAGE BACK</b>		For returning to the SYSTEM [1/2] Menu screen.

## MENU SCREENS

### Description of the Menu screens (continued)

#### REMOTE Menu screens

The REMOTE Menu consists of the following two screens (1/2 and 2/2).

##### ■ REMOTE [1/2] Menu screen

Item	Setting	Description
<b>REMOTE SEL 9P (0200)</b>	OFF (00) ☆ ON (01)	For enabling/disabling the REMOTE terminal when the REMOTE/LOCAL switch on the front panel is set to REMOTE. <b>OFF</b> : Control through RS-422A disabled. <b>ON</b> : Control through RS-422A enabled.
<b>REMOTE SEL SER (0201)</b>	OFF (00) ☆ ON (01) LOC+REM (02)	For enabling/disabling control via the SERIAL REMOTE terminal. <b>OFF</b> : Control disabled regardless of the settings of the REMOTE/LOCAL switch. <b>ON</b> : Control enabled only when the REMOTE/LOCAL switch is set to REMOTE. <b>LOC+REM</b> : Control enabled regardless of the settings of the REMOTE/LOCAL switch.
<b>REM SEL HDV/DV (0202)</b>	OFF (00) ☆ ON (01) LOC+REM (02)	For enabling/disabling control via the IEEE1394 terminal. <b>OFF</b> : Control disabled regardless of the settings of the REMOTE/LOCAL switch. <b>ON</b> : Control enabled only when the REMOTE/LOCAL switch is set to REMOTE. <b>LOC+REM</b> : Control enabled regardless of the settings of the REMOTE/LOCAL switch.
<b>LOCAL FUNCTION (0203)</b>	NO KEY (00) EJECT (01) ☆ STP+EJT (02) ALL KEYS (03)	For selecting the buttons of BR-HD50 to be enabled in remote-controlling it with the REMOTE terminals or the SERIAL REMOTE terminal: <b>NO KEY</b> : No button enabled. <b>EJECT</b> : Only the EJECT button enabled. <b>STP + EJT</b> : Only the STOP button and the EJECT button are enabled. <b>ALL KEYS</b> : All operation buttons are enabled.  — <b>Memo</b> — If OPERATION LOCK in the SYSTEM [2/2] Menu screen is set to ON, the buttons on BR-HD50 will be disabled regardless of the setting here.
<b>PREROLL (0204)</b>	3SEC (00) 5SEC (01) ☆ 7SEC (02) 10SEC (03)	For setting the preroll time of BR-HD50 in remote-controlling it with the REMOTE terminal. Setting done with the editing remote controller prevails over other settings: <b>3SEC</b> : 3 seconds <b>7SEC</b> : 7 seconds <b>5SEC</b> : 5 seconds <b>10SEC</b> : 10 seconds  — <b>Memo</b> — To enhance editing precision, please set it to at least 7 seconds.
<b>NEXT PAGE</b>		For displaying the REMOTE [2/2] Menu screen.
<b>PAGE BACK</b>		For returning to the TOP Menu screen.

##### ■ REMOTE [2/2] Menu screen

Item	Setting	Description
<b>REM FF/REW MODE (0205)</b>	☆ FF/REW (00) SEARCH (01)	For setting the action to be performed when the REMOTE terminal or IEEE1394 terminal received an FF/REW command: <b>FF/REW</b> : Sets BR-HD50 to perform FF/REW when an FF/REW command is received. Normal setting. <b>SEARCH</b> : Sets BR-HD50 to perform searching when an FF/REW command is received. Use this setting if the search (cue up) function does not work properly.
<b>REM STOP SEL (0206)</b>	☆ EE (00) PB (01)	For setting the action to be performed when the REMOTE terminal received a STANDBY-ON command: <b>EE</b> : Sets BR-HD50 to the EE mode. (It goes into the STOP mode.) <b>PB</b> : Sets BR-HD50 to the PLAY mode. (It goes into the STILL mode.)
<b>PB START DELAY (0207)</b>	☆ 0F (00)   9F (09) 10F (0A)   15F (0F)	For adjusting the edit timing. With the remote controller in use, if the start points of edit are not concurrent, adjust the playback startup timing: <b>0F</b> : No correction. <b>1F to 15F</b> : Delays the timing by the number of frames set by the user. When BR-HD50 is connected to an editing remote controller with no bump function, use this setting to adjust the editing precision.
<b>SYNCHRONIZATION (0208)</b>	OFF (00) ☆ ON (01)	For enabling/disabling the bump function when BR-HD50 is connected to an editing remote controller: <b>OFF</b> : No synchronization. <b>ON</b> : Performs synchronization. The editing precision is enhanced. Please set the pre-roll time to at least 7 seconds.
<b>CONTROLLER SEL (0209)</b>	☆ TYPE1 (00) TYPE2 (01) TYPE3 (02) TYPE4 (03) TYPE5 (04) TYPE6 (05) TYPE7 (06)	For setting the type of controller to be connected when remote control is enabled with the RS-422A interface: <b>TYPE1</b> : RM-G820 <b>TYPE2</b> : RM-G860 (set the preroll time to at least 10 seconds) <b>TYPE3</b> : AG-A850 <b>TYPE4</b> : RM-450, PVE-500 <b>TYPE5</b> : FXE-100, FXE-120 <b>TYPE6</b> : (Not in use) <b>TYPE7</b> : Avid Xpress DV, Canopus DV Rex-RT Professional
<b>FOOT SW (020A)</b>	☆ OFF (00) L EDGE (01) H EDGE (02) L LEVEL (03)	For setting when an external switch (e.g., a footswitch) is connected to the SERIAL REMOTE terminal. Before operating an external switch (footswitch) with L EDGE or H EDGE, turn BR-HD50 to the RECORDING PAUSE or RECORDING mode: <b>OFF</b> : For when the external switch is not used. <b>L EDGE</b> : Recording and recording pause is switched at the LOW edge of the external switch signal. <b>H EDGE</b> : Recording and recording pause is switched at the HIGH edge of the external switch signal. <b>L LEVEL</b> : Record at the LOW edge and pause recording at the HIGH edge of the external switch signal.
<b>PAGE BACK</b>		Return to the REMOTE [1/2] Menu screen.

## MENU SCREENS

### Description of the Menu screens (continued)

AUDIO Menu Screen		
Item	Setting	Description
<b>AUDIO MODE : DV (0300)</b>	32K (00) ☆48 K (01)	For selecting the audio sampling frequency for analog audio recording. <b>32 K</b> : Records at 32 kHz. Up to four channels of recording tracks are available, but this unit only records onto two of these channels. <b>48 K</b> : Records at 48 kHz. It records in the 2-channel stereo mode. <b>— Memo</b> Setting this item is not required for DV signal or HDV signal input. The audio mode will match the input signal.
<b>A.OUTPUT: DV (0301)</b>	☆CH1/2 (00) MIX (01) CH3/4 (02)	Select the audio channel for output signals from the AUDIO OUT terminal or PHONES terminal. Select the following audio choices. (In DV format mode only) • Playback audio of tapes recorded in 32kHz audio mode • EE audio of DV signal input in 32kHz audio mode <b>CH1/2</b> : Outputs audio of channels CH1 and CH2. <b>MIX</b> : Outputs mixed sound of CH1 and CH3 to the CH1/3 terminal, and the mixed sound of CH2 and CH4 to the CH2/4 terminal. <b>CH3/4</b> : Outputs audio of channels CH3 and CH4.
<b>A.OUT AT SRH: DV (0302)</b>	OFF (00) ☆ON (01)	For enabling/disabling audio output from this AUDIO OUT terminal during slow playback or searches. (In DV format mode only) <b>OFF</b> : Output off. <b>ON</b> : Output on. <b>— Memo</b> When playing back an HDV format tape, search audio is not output.
<b>AUDIO OUT LEV (0303)</b>	☆-20 dB (00) -12 dB (01)	For selecting the level for playback audio output. <b>-20 dB</b> : Usually, this setting is used. <b>-12 dB</b> : Select here to reduce the analog sound output level. It will be reduced by 8 dB.
<b>V.FADE: DV (0304)</b>	OFF (00) ☆ON (01)	For enabling/disabling the V.FADE function, which reduces sound noise in playback that is produced at jointed parts of recording. <b>OFF</b> : V.FADE function disabled. <b>ON</b> : V.FADE function enabled. <b>— Memo</b> When playing back an HDV format tape, the V. FADE function is unavailable.
<b>A REC VR.MD.: DV (0305)</b>	☆BOTH (00) INDEPEND (01)	Select audio recording level adjustment method. Select whether to adjust both channels simultaneously, or to adjust each channel separately. <b>BOTH</b> : Simultaneously adjusts both channels. <b>INDEPEND</b> : Adjusts both channels separately.
<b>PAGE BACK</b>		For returning to the TOP Menu screen.

VIDEO Menu Screen		
Item	Setting	Description
<b>SET UP [60]: DV (0400)</b>	OFF (00) ☆ON (01)	For enabling/disabling the application of setups to analog video signals (composite, Y/C and SD component). (During recording and playback) (Only for U model) <b>OFF</b> : Does not apply setups. <b>ON</b> : Applies setups. <b>— Memo</b> The application of setups on playback or recorded video signals must match the setting of SET UP. Otherwise, if dubbing is repeatedly performed, the hue and brightness of the video may not appear normal.
<b>MONITOR SELECT (0401)</b>	☆HDMI[A] (00) OUT FRMT (01)	Select the video format to output from the HDMI OUT terminal and the COMPONENT OUT terminal. <b>HDMI[A]</b> : Automatically outputs video to match the video format for the connected HDMI monitor. <b>OUT FRMT</b> : Outputs video format set using menu items <b>OUT FORMAT [60]</b> or <b>OUT FORMAT [50]</b> .
<b>OUT FORMAT [60] (0402)</b>	☆NATIVE (00) 480I (01) 480P (02) 1080I (03) 720P (04)	Sets the video output format to output from COMPONENT OUT terminal or HDMI OUT terminal during HDV/DV signal input or playback. (Cross converter video) * During HDV signal input or playback of a tape recorded with HDV signals, this menu item is available when 60/50 SEL in the SYSTEM [2/2] Menu screen is set to 60. During DV signal input or playback of a tape recorded with DV signals, this menu item applies to the U model. <b>NATIVE</b> : Outputs IEEE1394 terminal video input format or the video format recorded on a tape, without conversion. <b>480I</b> : Video with 480 effective scanlines, 60-field interlace scan (SD video) <b>480P</b> : Video with 480 effective scanlines, 60-frame progressive scan (SD video) <b>1080I</b> : Video with 1080 effective scanlines, 60-field interlace scan (HD video) <b>720P</b> : Video with 720 effective scanlines, 60-frame progressive scan (HD video) <b>— Memo</b> ● This menu item is valid when the MONITOR SELECT menu item is set to OUT FRMT. It is also valid when an HDMI monitor is not in use while the MONITOR SELECT menu is set to HDMI[A]. ● During analog signal input, the SD video (480i) is output from the COMPONENT OUT terminal and HDMI OUT terminal, regardless of the menu settings.

## MENU SCREENS

### Description of the Menu screens (continued)

#### VIDEO Menu screen (continued)

Item	Setting value	Description
<b>OUT FOR-MAT[50] (0403)</b>	☆NATIVE (00) 576i (01) 576P (02) 1080i (03) 720P (04)	<p>Sets the video output format to output from COMPONENT OUT terminal or HDMI OUT terminal during HDV/DV signal input or playback. (Cross converter video)</p> <p>* During HDV signal input or playback of a tape recorded with HDV signals, this menu item is valid when 60/50 SEL in the SYSTEM [2/2] Menu screen is set to 50.</p> <p>During DV signal input or playback of a tape recorded with DV signals, this menu item applies to the E model.</p> <p><b>NATIVE:</b> Outputs IEEE1394 terminal video input format or the video format recorded on a tape, without conversion.</p> <p><b>576i</b> : Video with 576 effective scanlines, 50-field interlace scan (SD video)</p> <p><b>576P</b> : Video with 576 effective scanlines, 50-frame progressive scan (SD video)</p> <p><b>1080i</b> : Video with 1080 effective scanlines, 50-field interlace scan (HD video)</p> <p><b>720P</b> : Video with 720 effective scanlines, 50-frame progressive scan (HD video)</p> <p>— <b>Memo</b> —</p> <ul style="list-style-type: none"> <li>This menu item is valid when the MONITOR SELECT menu item is set to OUT FRMT.</li> <li>It is also valid when an HDMI monitor is not in use while the MONITOR SELECT menu is set to HDMI[A].</li> <li>During analog signal input, SD video (576i) is output from the COMPONENT OUT terminal and HDMI OUT terminal, regardless of the menu settings.</li> </ul>
<b>DOWN CONV. MODE (0404)</b>	☆SQUEEZE (00) LETTER (01) SIDE CUT (02)	<p>The HDV signal is a wide-screen video signal (aspect ratio 16:9). When playing a tape recorded in HDV format, or during HDV signal input, the output from the LINE OUT terminal and Y/C OUT terminal will be down-converted video (480i or 576i).</p> <p>Set the style for displaying the down-converted playback video on a display with a 4:3 aspect ratio.</p> <p>Also, when OUT FORMAT [60] is set to 480i, or OUT FORMAT [50] is set to 576i, this applies to the down-converted video output from the COMPONENT OUT terminal during HDV signal input or when playing back a tape recorded with HDV signals.</p> <p><b>SQUEEZE</b> : The video is compressed horizontally to display wide-screen video on a display with a 4:3 aspect ratio. The video will appear elongated vertically.</p> <p><b>LETTER</b> : Wide-screen video is displayed on a display with a 4:3 aspect ratio, with the top and bottom black.</p> <p><b>SIDE CUT</b> : Cuts the left and right of the wide-screen video and displays on a display with a 4:3 aspect ratio.</p>

Item	Setting value	Description
<b>UP CONV. MODE (0405)</b>	☆FULL (00) SIDE P. (01)	<p>Up-converts DV input signals or DV/DVCAM recorded tape playback signals, and sets the video mode for output from the COMPONENT OUT terminal.</p> <p><b>FULL</b> : The 4:3 angle of view is stretched to 16:9 and displayed. Set here to up-convert tapes recorded in 16:9.</p> <p><b>SIDE P.</b>: The 4:3 angle of view remains, with both sides in black. Set here to up-convert tapes recorded in 4:3.</p>
<b>HDMI MODE (0406)</b>	☆AUTO (00) RGB (01)	<p>Selects the video mode to output from the HDMI OUT terminal.</p> <p><b>AUTO</b>: Automatically outputs video to match the video mode of the connected monitor. Usually, this setting is used.</p> <p><b>RGB</b> : Outputs RGB video. Use this setting when video is not displayed properly on the connected monitor.</p>
<b>DVI COLOR (0407)</b>	☆STANDARD (00) ENHANCED (01)	<p>Set this item when connecting the HDMI OUT terminal to a DVI (Digital Video Interface) terminal on the monitor.</p> <p><b>STANDARD</b> : Standard mode. Usually, this setting is used.</p> <p><b>ENHANCED</b>: Enhanced mode. Select the video of your choice (image quality, color density, black blending).</p>
<b>TEST SIGNAL (0408)</b>	☆OFF (00) CB (01)	<p>Outputs test signals from the built-in video signal generator.</p> <p><b>OFF</b> : Does not output test signals.</p> <p><b>CB</b> : Outputs color bar signals.</p> <p>— <b>Memo</b> —</p> <p>These test signals are not controlled for use as standard signals.</p>
<b>PAGE BACK</b>		Returns to TOP Menu screen.



## MENU SCREENS

### Description of the Menu screens (continued)

#### TC/UB/CLOCK Menu screens

The TC/UB/CLOCK Menu consists of the following two screens. (1/2 and 2/2)

##### ■ TC/UB/CLOCK [1/2] Menu screen

Item	Setting	Description
<b>TCG SELECT (0500)</b>	PRESET (00) ☆REGEN (01)	For selecting the time code generator mode. <b>PRESET</b> : PRESET mode <b>REGEN</b> : REGENERATION mode
<b>NDF/DF [60] (0501)</b>	NON DROP (00) ☆DROP (01)	For selecting the framing mode of the time code generator. (Only for U model) * Select here in the PRESET mode. <b>NON DROP</b> : NON-DROP mode <b>DROP</b> : DROP-FRAME mode
<b>DF BIT [50] (0502)</b>	OFF (00) ☆ON (01)	For selecting whether to record drop-frame bits. (Only for E model) (In DV format mode only) <b>OFF</b> : No recording <b>ON</b> : Recording
<b>TC DUPLI.: DV (0503)</b>	☆OFF (00) AUTO (01) NON DROP (02)	For selecting the type of time code to be recorded with DV signal input (In DV format only). <b>OFF</b> : Records time code of the built-in time code generator of BR-HD50. <b>AUTO</b> : Records the time code input to the IEEE1394 terminal. The framing mode of the time code will be set automatically to the framing of the time code input. <b>NON DROP</b> : Records the time code input to the IEEE1394 terminal. The framing mode of the time code is fixed to non-drop framing. (Only for U model) Use this setting for dubbing tapes recorded with BR-DV600, GY-DV500 or GY-DV550 in the NON-DROP FRAME mode. (Only for U model)
<b>TC OFFSET (0504)</b>	☆OFF (00) +1F (01) +2F (02) -2F (03) -1F (04)	For setting up the timing when time code data from the REMOTE terminal of BR-HD50 to the editing remote controller are output. <b>OFF</b> : Normal setting <b>+1F</b> : Outputs time code data +1 frame. <b>+2F</b> : Outputs time code data +2 frames. <b>-2F</b> : Outputs time code data -2 frames. <b>-1F</b> : Outputs time code data -1 frame.
<b>NEXT BACK</b>		For displaying the TC/UB/CLOCK [2/2] Menu screen.
<b>PAGE BACK</b>		For returning to the TOP Menu screen.

##### ■ TC/UB/CLOCK [2/2] Menu screen

Item	Setting	Description
<b>U-BIT [50] (0505)</b>	OFF (00) ☆ON (01)	For selecting whether to record user's bit. (Only for E model) * Functions in DV format mode only. <b>OFF</b> : No recording <b>ON</b> : Recording
<b>CLOCK ADJUST. (0506)</b>		For displaying the CLOCK ADJUST screen For setting, refer to page 38 "Setting date and time".
<b>DATE [MM/DD/YY] (0507)</b>		Sets the date. The item name differs by model. U model: <b>DATE [MM/DD/YY]</b> , E model: <b>DATE [DD/MM/YY]</b>
<b>TIME (0508)</b>		Sets the time.
<b>PAGE BACK</b>		Returns to the TC/UB/CLOCK [2/2] Menu screen.
<b>PAGE BACK</b>		For returning to the TC/UB/CLOCK [1/2] Menu screen.

## MENU SCREENS

### Description of the Menu screens (continued)

#### DISPLAY Menu screen

Item	Setting	Description
<b>DISPLAY (0600)</b>	OFF (00) ☆ON (01) AUTO (02)	For turning on/off on-screen status display on the monitor connected to the VIDEO OUT terminal. <b>OFF</b> : No on-screen status display. Only video is displayed. <b>ON</b> : Always shows on-screen status display. <b>AUTO</b> : Shows on-screen status display for about 4 seconds during mode changes.
<b>COUNTER POSI. (0601)</b>	☆LOWER-R (00) LOWER-L (01) PPER-R (02) UPPER-L (03) CENTER (04)	For selecting the counter display position (CTL counter, time code and user's bit) of the monitor. <b>LOWER-R</b> : Lower right <b>LOWER-L</b> : Lower left <b>UPPER-R</b> : Upper right <b>UPPER-L</b> : Upper left <b>CENTER</b> : Center
<b>TIME CODE (0602)</b>	OFF (00) ☆ON (01)	For enabling/disabling the time code display on the monitor. <b>OFF</b> : No display <b>ON</b> : Display
<b>VTR MODE (0603)</b>	OFF (00) ☆ON (01)	For enabling/disabling the VCR mode on the monitor. <b>OFF</b> : No display <b>ON</b> : Display
<b>TAPE REMAIN (0604)</b>	OFF (00) ☆ON (01)	For enabling/disabling the display of the remaining time of the tape on the monitor. <b>OFF</b> : No display <b>ON</b> : Display
<b>TIME/DATE (0605)</b>	OFF (00) TIME (01) DATE (02) ☆DATE+TM (03)	For enabling/disabling the time/date display on the monitor and selecting the display format. <b>OFF</b> : No display <b>TIME</b> : Time display only <b>DATE</b> : Date display only <b>DATE+TM</b> : Date/Time display
<b>A/V INFO. (0606)</b>	OFF (00) ☆ON (01)	Select whether to display video/audio information on the monitor. <b>OFF</b> : No display <b>ON</b> : Display
<b>DATE STYLE (0607)</b>	YY/MM/DD (00) MM/DD/YY (01) DD/MM/YY (02)	For selecting the date display format. <b>YY/MM/DD</b> : Year/Month/Day <b>MM/DD/YY</b> : Month/Day/Year (Set when shipping U model) <b>DD/MM/YY</b> : Day/Month/Year (Set when shipping E model)
<b>TIME STYLE (0608)</b>	12HOUR (00) ☆24HOUR (01)	For selecting the display style of time. <b>12HOUR</b> : 12-hour mode <b>24HOUR</b> : 24-hour mode
<b>PAGE BACK</b>		For returning to the TOP Menu screen.

## OTHERS

### Warning display

When an error occurs, BR-HD50 automatically self-diagnoses the cause and displays an error-coded warning message on the monitor.

If BR-HD50 is not in good order, or if an operation error has occurred, an alarm display will be shown on the monitor.

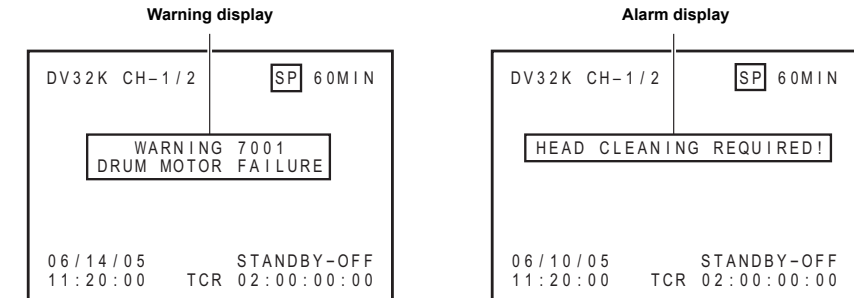

### ■ Alarm display (Displayed regardless of the DISPLAY mode)

Display	Status	Action
<b>LOW VOLTAGE</b>	The DC power voltage is low. BR-HD50 will eventually go into the OPERATE OFF mode if operation is continued.	Check the power voltage.
<b>HEAD CLEANING REQUIRED!</b>	The video head is dirty. (This message is displayed when the DISPLAY mode is ON or AUTO.) If the head is clogged, it will be detected and the alarm message will be displayed in the PLAYBACK mode. The display disappears when the cassette is ejected or the head gets cleared of clog. The message will also disappear when the head cleaning tape is loaded.	Clean it with a JVC head-cleaning tape. (☞ Page 9) If the message persists despite cleaning, it could be due to bad recording condition, defective tape or head lifespan.
<b>OVER HEATING!</b>	The internal temperature of BR-HD50 has exceeded the stated value.	Disconnect the power and place BR-HD50 in a cool place. If this message is displayed again, the unit may have been damaged. In such a case, consult your JVC authorized dealer.
<b>UNPLUG MAIN POWER, PLUG BACK IN AFTER A WHILE</b>	This is a system error that occurs when the power is turned on. The OPERATE indicator on BR-HD50 blinks in green. The unit will not accept any operation commands.	Unplug the power cord from the power outlet and wait for some time before plugging it back in.

• For alarm displays resulting from operation errors, refer to page 24.

## OTHERS

### Warning display (continued)

#### ■ Warning display (Displayed regardless of the DISPLAY mode)

When a warning display appears, BR-HD50 stops operation and ceases to accept any operation command. When TAPE DEFECTIVE (5605 - 5609) is displayed, the unit similarly stops all operations except EJECT operation.

Display	Status	Action
<b>WARNING 0201 CONDENSATION ON DRUM</b>	Condensation.	Leave the power on and wait for the display to disappear.
<b>WARNING 3200 LOADING FAILURE</b>	Unable to load tape.	This error can be resolved by turning off and then on the power. However, doing so may damage the tape in some cases. Consult your JVC authorized dealer.
<b>WARNING 3300 UNLOADING FAILURE</b>	Unable to eject tape.	
<b>WARNING 4100 CASSETTE EJECT FAILURE</b>	Eject error.	
<b>DEFECTIVE TAPE! 5605 - 5609</b>	Broken tape.	Press the EJECT button to remove and replace the tape.
<b>WARNING 5702 TAPE END DET. ERROR!</b>	Tape-end sensor error.	This error can be resolved by turning off and then on the power. However, doing so may damage the tape in some cases. Consult your JVC authorized dealer.
<b>WARNING 5802 TAPE BEGIN DET. ERROR!</b>	Tape-beginning sensor error.	
<b>WARNING 7001 DRUM MOTOR FAILURE</b>	Drum rotation error.	
<b>WARNING 7101 CAP MOTOR FAILURE</b>	Capstan rotation error.	
<b>WARNING 7202 - 7203 SUPPLY REEL FAILURE</b>	Supply reel rotation error.	
<b>WARNING 7302 - 7303 TAKE UP REEL FAILURE</b>	Take up reel rotation error.	
<b>WARNING 7305 TAKE UP REEL FAILURE</b>	Tape winding error during unloading.	
<b>WARNING 7401 REEL MOTOR FAILURE</b>	Reel motor rotation error.	

#### — Memo

This unit uses a microcomputer. It may not function correctly if there is external noise. If this happens, please turn off the power and then on again.

## OTHERS

### Troubleshooting

Symptom	Action
<b>No power.</b>	Is the AC adapter correctly connected?
<b>Unable to record.</b>	Is the slide of the cassette tape turned to "REC"? Set it to "REC" if it is at the "SAVE" position.
<b>The operation buttons of BR-HD50 do not work.</b>	Is OPERATION LOCK of the SYSTEM [2/2] Menu set to ON? Set it to OFF if the operation buttons are to be used. For REMOTE, select the buttons that can be operated with the LOCAL FUNCTION Menu.
<b>Editing cannot be controlled even after the REMOTE/LOCAL switch is set to REMOTE.</b>	To control with RS-422A, set REMOTE SEL 9P in the REMOTE [1/2] Menu screen to "ON".
<b>Noise is produced on the playback video. Playback sound interrupted.</b>	<ul style="list-style-type: none"> <li>The tape is damaged. Replace the tape.</li> <li>The head is dirty. Clean it with the specified head-cleaning tape. (Page 9)</li> </ul>
<b>Cannot play back.</b>	Is the setting for PB TAPE FORMAT in the SYSTEM [2/2] Menu screen something other than AUTO? Playback is not available when this menu item does not match the tape format.
<b>Time codes are not correctly recorded during DV signal input.</b>	Is TC DUPLI.: DV in the TC/UB/CLOCK [1/2] Menu screen correctly set up?
<b>Unable to turn on the power with the OPERATE button.</b>	Isn't the REMOTE/LOCAL switch set to REMOTE when LOCAL FUNCTION in the REMOTE [1/2] Menu screen is not set to ALL KEYS?
<b>SERIAL REMOTE control does not function.</b>	Isn't REMOTE SEL SER in the REMOTE [1/2] Menu screen set to OFF? For SERIAL REMOTE control, set it to ON or LOC+REM.
<b>Unable to operate BR-HD50 with the IEEE1394 terminal.</b>	<ul style="list-style-type: none"> <li>Isn't REM SEL HDV/DV in the REMOTE [1/2] Menu screen set to OFF? To operate with the IEEE1394 terminal, set it to ON or LOC+REM.</li> <li>When the controlling equipment (non-linear editor, etc.) does not recognize this unit, either reconnect the IEEE1394 cable, or reset the power to the unit.</li> </ul>

## OTHERS

### Troubleshooting (continued)

Symptom	Action
Cannot record HDV signals from the IEEE1394 terminal.	<ul style="list-style-type: none"> <li>Is the IEEE1394 switch on the front panel set correctly? To record HDV signals, set this to HDV.</li> <li>Is the HD signal format set correctly? Match the 60/50 SEL setting in the SYSTEM [2/2] Menu screen to the input HDV signal format. (Page 40)</li> </ul>
Cannot record DV signals from the IEEE1394 terminal.	<ul style="list-style-type: none"> <li>Is the IEEE1394 switch on the front panel set correctly? To record DV signals, set this to DV.</li> </ul>
No HD signal is output from the HDMI OUT or COMPONENT OUT terminal.	<ul style="list-style-type: none"> <li>Is the HD signal format set correctly? Match the 60/50 SEL setting in the SYSTEM [2/2] Menu screen to the HD signal format. (Page 40)</li> </ul>
HDMI OUT terminal video does not display on the monitor.	<ul style="list-style-type: none"> <li>Is the monitor compatible with video from the HDMI OUT terminal? Check the monitor specifications.</li> <li>To automatically set the HDMI OUT terminal video to the video format for the connected equipment (monitor), set MONITOR SELECT to HDMI[A] in the VIDEO Menu screen.</li> </ul>
No signal is output from the IEEE1394 terminal during playback.	<ul style="list-style-type: none"> <li>Is the IEEE1394 switch on the front panel set correctly? Match the IEEE1394 switch setting to the playback tape recording format.</li> <li>When playing a tape recorded in HDV format, check that the HD signal format setting is correct. (Page 40)</li> </ul>

## OTHERS

### Checking the hour meter

This unit displays the drum usage time as the hour meter in DRUM HOUR METER in the SYSTEM [2/2] Menu screen. Use it as a guide for regular maintenance. (Page 8)  
Use standard DV cassette tapes or mini DV cassette tapes.

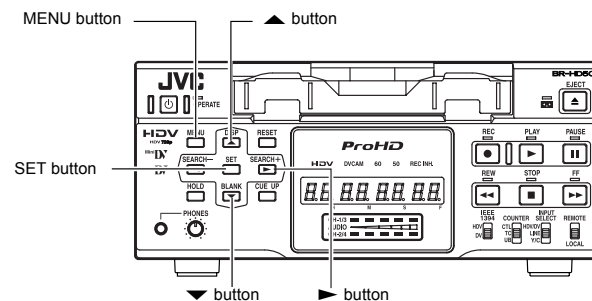

### Operation

#### ■ Set BR-HD50 to the STOP mode:

- Press the MENU button to display the TOP Menu screen.
- Press the ▲ or ▼ button to bring the cursor to SYSTEM. Press SET or the ► button.  
→ The SYSTEM [1/2] Menu screen is displayed.
- Press the ▲ or ▼ button to bring the cursor to NEXT PAGE. Press SET or the ► button.  
→ The SYSTEM [2/2] Menu screen is displayed.
  - The drum usage time is displayed on DRUM HOUR METER in the SYSTEM [2/2] Menu screen.
- Press the MENU button to return to the normal screen.

#### TOP Menu screen

```

---MENU---
>SYSTEM . . .
REMOTE . . .
AUDIO . . .
VIDEO . . .
TC/UB/CLOCK . .
DISPLAYSET . .
EXIT
    
```

#### SYSTEM [1/2] Menu screen

```

---SYSTEM[1/2]---
STL/F ADV :DV 2ND
BACKUP REC :DV OFF
LONG PAUSE TIME 30SEC
REC LONG P.TIME 5MIN
LONG PAUSE MODE STBY-OFF
*4* KEY FUNC. VAR/RECV
REPEAT MODE OFF
>NEXT PAGE
PAGE BACK
    
```

#### SYSTEM [2/2] Menu screen

```

---SYSTEM[2/2]---
>DC IN MODE OPE OFF
INDEX WRITE INDEX
OPERATION LOCK ON
60/50 SEL 60
FACTORY SETTING CANCEL
DRUM HOUR METER 000200
PAGE BACK
    
```

Drum usage time

## OTHERS

### Specifications

#### ■ General

**Power requirements:** DC 12 V  $\approx$  (from provided AC adapter)

**Power consumption:** DC 12 V  $\approx$  26.4 W 2.2 A

**Usable tape** : Standard/ mini DV cassette tape

**Tape speed** : 18.8 mm/s

**Record/play time** : 276 minutes (with LA-DV276PRO tape)

63 minutes (with M-DV63PROHD tape)

**External dimension:** 212 mm (W)  $\times$  88 mm (H)  $\times$  327 mm (D) (Excluding protruding parts)

**Weight** : Approx. 3.9 kg (Not including AC Adapter)

**Allowable operating temperature** : 5°C to 40°C

**Allowable storage temperature** : -20°C to 60°C

**Allowable operating humidity** : 30% RH to 80% RH

**Allowable storage humidity** : 85% RH or less

#### ■ Video

**Recording format:** 720/24p, 720/25p, 720/30p, 576/50p, 480/60p (BR-HD50U/HD50E), 480/60i (BR-HD50U), 576/50i (BR-HD50E)

**Video format** :

**[HDV]**

**Video signal recording format**

: HDV720p format, 8-bit, 19.7 Mbps

**Compression** : MPEG-2 video (profile & level: MP@H-14)

**[DV]**

**Video signal recording format**

: DV format, 8-bit, 25 Mbps

**Compression** : DV format, 4:1:1 (NTSC)/ 4:2:0 (PAL)

#### ■ Audio

**[HDV]**

**Audio signal recording format**

: MPEG1 Audio Layer II

**[DV]**

**Audio signal recording format**

: 16-bit (locked audio), 48 kHz PCM for 2 channels or 12-bit, 32 kHz PCM for 4 channels

#### ■ Connectors

**Video**

**[HDV]**

**Video outputs**

**Analog component**

**Y** : 1.0 V (p-p), 75  $\Omega$  (BNC)

**PB/PR** : 0.7 V (p-p), 75  $\Omega$  (BNC)

**[DV]**

**Video inputs**

**Analog composite:** 1.0 V (p-p), 75  $\Omega$  (BNC)

**Analog Y/C**

**Y** : 1.0 V (p-p), 75  $\Omega$

**C** : 0.286 V (NTSC)/0.3 V (PAL) (p-p), 75  $\Omega$  (4-pin)

**Video outputs**

**Analog composite:** 1.0 V (p-p), 75  $\Omega$  (BNC)

**Analog Y/C**

**Y** : 1.0 V (p-p), 75  $\Omega$

**C** : 0.286 V (NTSC)/0.3 V (PAL) (p-p), 75  $\Omega$  (4-pin)

**Analog component**

**Y** : 1.0 V (p-p), 75  $\Omega$  (BNC)

**PB/PR** : 0.7 V (p-p), 75  $\Omega$  (BNC)

**Audio**

**Audio inputs**

**Line** : -8 dBs, 10 k $\Omega$  unbalanced (RCA)

**Audio outputs**

**Line** : -8 dBs, 1 k $\Omega$  unbalanced (RCA)

**Headphones** : - $\infty$  to -15 dBs, 8  $\Omega$  (Stereo mini Jack)

**HDMI output** : Type A (19-pin)

**IEEE1394 interface:** 6-pin

**RS-422 interface** : D-sub-9pin

**Serial remote interface:** Mini jack

#### ■ AC adapter

**Input** : AC 100 V - 240 V  $\sim$ , 50 Hz/60 Hz 1.0 A - 0.5 A

**Output** : DC 12 V  $\approx$  3.5 A

#### ■ Accessories

AC adapter (AA-G30) .....  $\times$  1

Power cord (for BR-HD50U) .....  $\times$  1

Power cord (for BR-HD50E) .....  $\times$  2

Ferrite core (for IEEE1394 cable) .....  $\times$  1

Ferrite core (for DC cord) .....  $\times$  1

#### ■ External dimensions (Unit: mm)

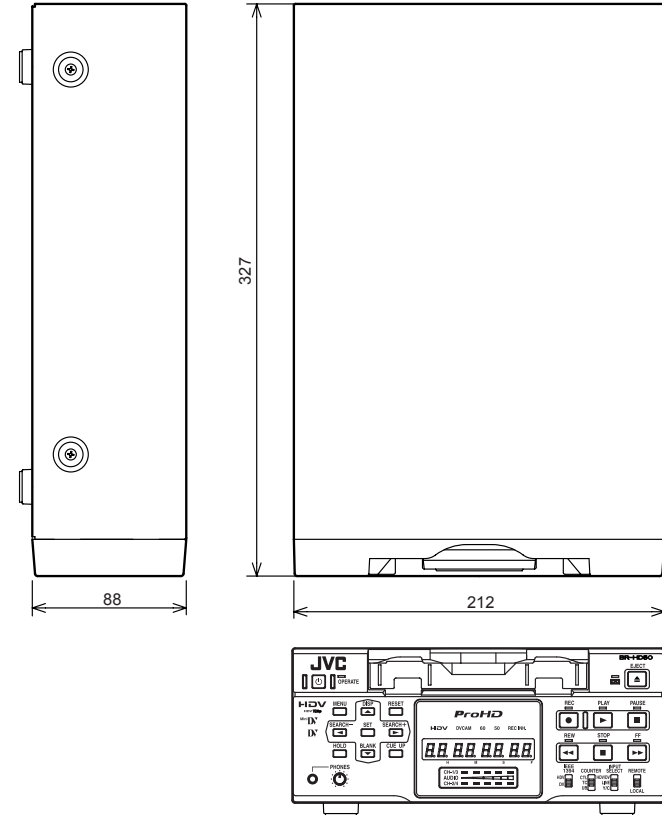

For improvement, the specifications and external appearance may be changed without prior notice.

## OTHERS

### Supplement

#### ■ AC adapter section

### IMPORTANT SAFETY INSTRUCTIONS

- 1) Read these instructions.
- 2) Keep these instructions.
- 3) Heed all warnings.
- 4) Follow all instructions.
- 5) Do not use this apparatus near water.
- 6) Clean only with dry cloth.
- 7) Do not block any ventilation openings. Install in accordance with the manufacturer's instructions.
- 8) Do not install near any heat sources such as radiators, heat registers, stoves, or other apparatus (including amplifiers) that produce heat.
- 9) Do not defeat the safety purpose of the polarized or grounding-type plug. A polarized plug has two blades with one wider than the other. A grounding type plug has two blades and a third grounding prong. The wide blade or the third prong are provided for your safety. If the provided plug does not fit into your outlet, consult an electrician for replacement of the obsolete outlet.
- 10) Protect the power cord from being walked on or pinched particularly at plugs, convenience receptacles, and the point where they exit from the apparatus.
- 11) Only use attachments/accessories specified by the manufacturer.
- 12) Use only with the cart, stand, tripod, bracket, or the table specified by the manufacturer, or sold with the apparatus.  
When a cart is used, use caution when moving the cart/apparatus combination to avoid injury from tip-over.
- 13) Unplug this apparatus during lightning storms or when unused for long periods of time.
- 14) Refer all servicing to qualified service personnel. Servicing is required when the apparatus has been damaged in any way, such as power-supply cord or plug is damaged, liquid has been spilled or objects have fallen into the apparatus, the apparatus has been exposed to rain or moisture, does not operate normally, or has been dropped.

PORTABLE CART WARNING  
(symbol provided by RETAC)



S3125A

**WARNING** – To reduce the risk of fire or electric shock, do not expose this apparatus to rain or moisture.

Apparatus shall not be exposed to dripping or splashing and no objects filled with liquids, such as vases, shall be placed on the apparatus.

**CAUTION** – These servicing instructions are for use by qualified service personnel only. To reduce the risk of electric shock, do not perform any servicing other than that contained in the operating instructions unless you are qualified to do so.

## Free Manuals Download Website

<http://myh66.com>

<http://usermanuals.us>

<http://www.somanuals.com>

<http://www.4manuals.cc>

<http://www.manual-lib.com>

<http://www.404manual.com>

<http://www.luxmanual.com>

<http://aubethermostatmanual.com>

Golf course search by state

<http://golfingnear.com>

Email search by domain

<http://emailbydomain.com>

Auto manuals search

<http://auto.somanuals.com>

TV manuals search

<http://tv.somanuals.com>