

JVC®

NETWORK PACK

KA-DV5000

User's Guide

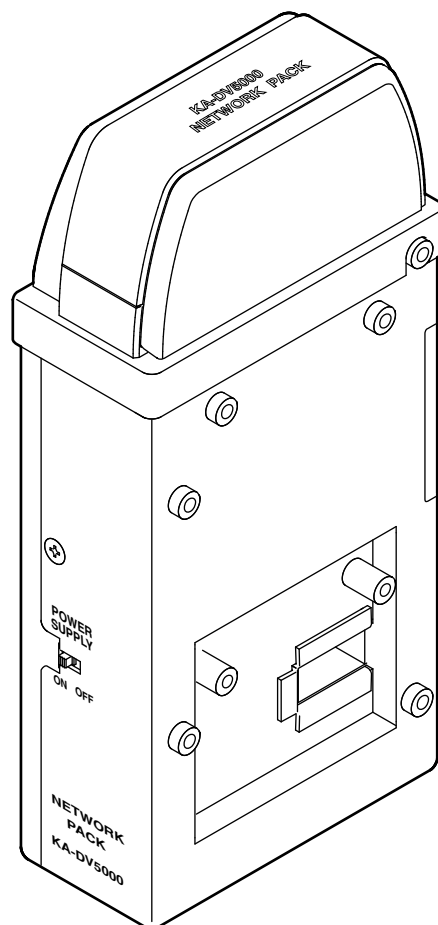

When attaching Network Pack KA-DV5000 to DV Camcorder GY-DV5000, network related menus are added to the GY-DV5000 menu screen.

This User's Guide explains settings for the network related menus, operation for recording streaming data to a CF (Compact Flash) memory card and operation for sending streaming data using a LAN card. When a LAN card is connected, menu screen settings for the Network Pack and GY-DV5000 can be operated from your PC.

Contents

Introduction

Inserting/removing CF memory card/LAN card	3
LCD screen/viewfinder screen	4
When inputting the 44.1 kHz sampling audio signal	4

Menu screen

Menu screen structure	5
NETWORK PACK CONFIG menu screen items	6
Setting the NETWORK PACK CONFIG menu screen	8
Returning the NETWORK PACK CONFIG menu screen to factory settings	9

Network settings

Setting the NETWORK MAIN SETUP menu screen	10
NETWORK MAIN SETUP menu screen items	11
Setting user names and passwords	13
Making network related settings	14
Detailed IP settings (LAN)	15
Detailed network settings (WLAN)	16

Recording on a CF card

Formatting a CF memory card	18
CF memory recording time	18
Recording video on a DV cassette tape and CF memory card	19
Recording video on a CF memory card only	20
Recording playback signals of a DV cassette tape on a CF memory card	21
Deleting all clip files on a CF memory card	22

Movie clips

Playing back video/audio recorded on a CF memory card	23
Protecting a clip file on a CF memory card	25
Deleting a clip file on a CF memory card	26
Playing back CF memory card clips on your PC	27

LAN card

Sending video using LAN card while recording on a DV cassette tape	28
Sending video using a LAN card (no DV cassette tape recording)	29
Sending playback signals of a DV cassette tape using a LAN card	30

Network pack setup

Controlling GY-DV5000/KA-DV5000 via LAN a card	31
NETWORK SETUP screen	32
PORT SETUP screen	34
CAM & VTR CONTROL screen	35
ENCODE PARAMETERS screen	37
Streamcapture screen (Playing back video/audio using a PC and saving to file)	38

Others

TOP PAGE can be customized	42
Connecting Windows Media player	43
Connecting Quick Time player	44
About updating the network pack	45
Troubleshooting	46
Checking communication/connection	48
Terminology	49

Characters and symbols used in this instruction book

Caution	Cautionary notes concerning operation of the unit
Memo	Reference such as restrictions of features, etc.
	Reference page or item

* In general, the names of products manufactured by other companies and mentioned in these instructions are trademarks or registered trademarks of these companies.

Symbols like ™, ©, ®, etc., are not used in these instructions.

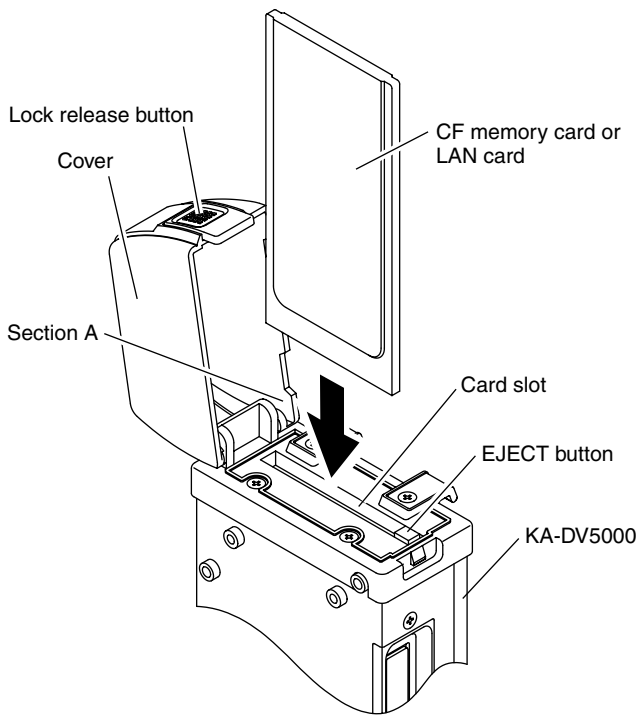

- The KA-DV5000 accepts the following cards for which operation has been confirmed: (As of August 2002)
 Operating voltage 3.3 V
 Current consumption Max. 500 mA
- Wired LAN-card
 US: EA2900-117 (Revision C) (Name of manufacturer: Socket Communications, Inc)¹
 Europe: EA2903-162 (Revision C) (Name of manufacturer: Socket Communications, Inc)¹
 Asia: EA2906-194 (Revision C) (Name of manufacturer: Socket Communications, Inc)¹
 * Revision indicated on the upper right of package production label.
- Wireless LAN-card
 TEW-201PC
 TEW-202CF
 TEW-PC16 (firmware version 0.8.3 or later) (Name of manufacturer: TRENDware)
 WCF11 (Name of manufacturer: LINKSYS)²
 AIR-PCM350
 (Name of manufacturer: Cisco Systems)
 FCCID: LDK102040
- CF (Compact Flash) card
 SDCFB-16 ~ SDCFB-256 (Name of manufacturer: SanDisk)¹
 *1: Use PCMCIA card TYPE I or TYPE II adapter
 *2: Use PCMCIA card TYPE II adapter

For the latest operational check card, visit the website below or contact your JVC dealer.
<http://www.jvc-victor.co.jp/english/pro/prodv/>

Caution

- Make sure the power of GY-DV5000 is off when inserting/removing a CF memory card/LAN card. Inserting/removing a card with the unit power on may damage the data storage section of the CF memory card or the card itself.
- Do not use the wireless LAN card continuously for more than 48 hours.

Inserting card

1. Turn off the GY-DV5000 power.
2. Press and hold the lock release button and open the cover.
3. Insert a card into the KA-DV5000 card slot. Then, close the cover.
 - The cover may not close depending on the wired LAN card or the card shape. In this case, remove the cover by pressing section A and pulling on the cover.
4. Turn on the GY-DV5000 power.
5. Turn on the KA-DV5000 power.

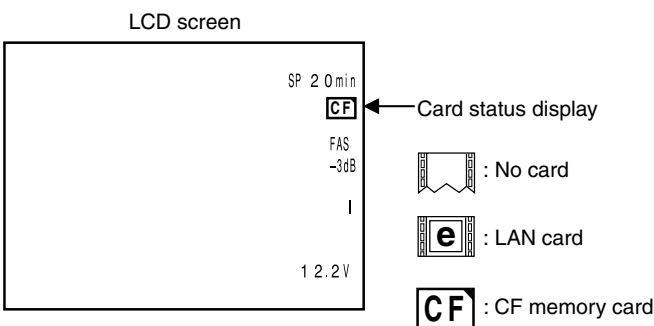

- Card status according to the inserted card type is displayed on the LCD screen/viewfinder screen. (page 4)
 (The viewfinder will show the status in black and white.)

Memo

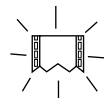

When turning the power on, the card status display shown on left will flash during initialization.

Removing card

1. Turn off the GY-DV5000 power, or turn off the KA-DV5000 power.
2. Open the cover, press the EJECT button of KA-DV5000 and remove the card.

Information from Network Pack KA-DV5000 is displayed on the GY-DV5000 LCD screen/viewfinder screen.

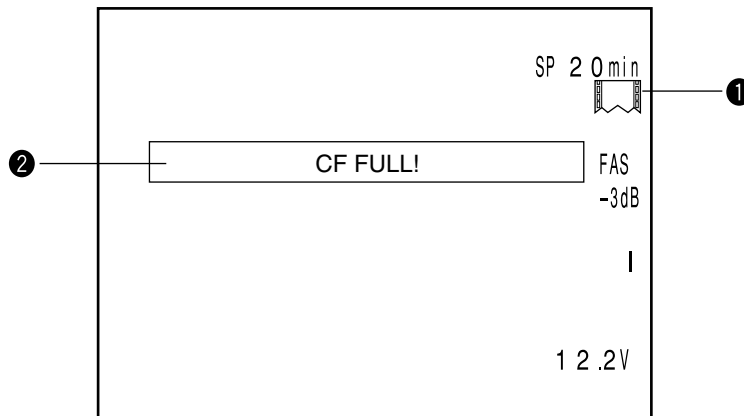

① Card status displays

Display	Description
	No card is inserted in Network Pack. Flashing display during initialization (after power on).
 (White display)	LAN card is inserted in Network Pack.
 (Red display)	Video/audio data is being sent from LAN card.
 (White display)	CF memory card is inserted in Network Pack.
 (Red display)	CF memory card is being recorded with data.
 Flashing display	Card is inserted in Network Pack but transmission is not available. There is possibility of unit malfunction. Contact your nearest JVC dealer.

No colors will be shown on the viewfinder.

② CF Memory card warning display

Displays CF memory card status and system errors.

* For details concerning warning displays, see page 46.

When inputting the 44.1kHz sampling audio signal

This unit is not compatible with audio sampling frequency of 44.1kHz. When playing back a tape recorded with audio of 44.1kHz on GY-DV5000 or when inputting audio in the 44.1kHz mode into the DV terminal, the audio will be processed as muted sound. However, the video will be processed as normal.

Receiving Level Indicator of Wireless LAN

If you are using wireless LAN card that can detect receiving level, receiving level indicator is shown next to the card status information on LCD of your camcorder. The indicator shows value from 5 to 0, 5 means maximum level and 0 means minimum level. (The indicator is for reference. The value does not guarantee communication.)

Menu screen

Menu screen structure

When attaching Network Pack KA-DV5000 to DV Camcorder GY-DV5000, NETWORK PACK CONFIG menu and MOVIE CLIP menu are added to the GY-DV5000 TOP MENU screen.

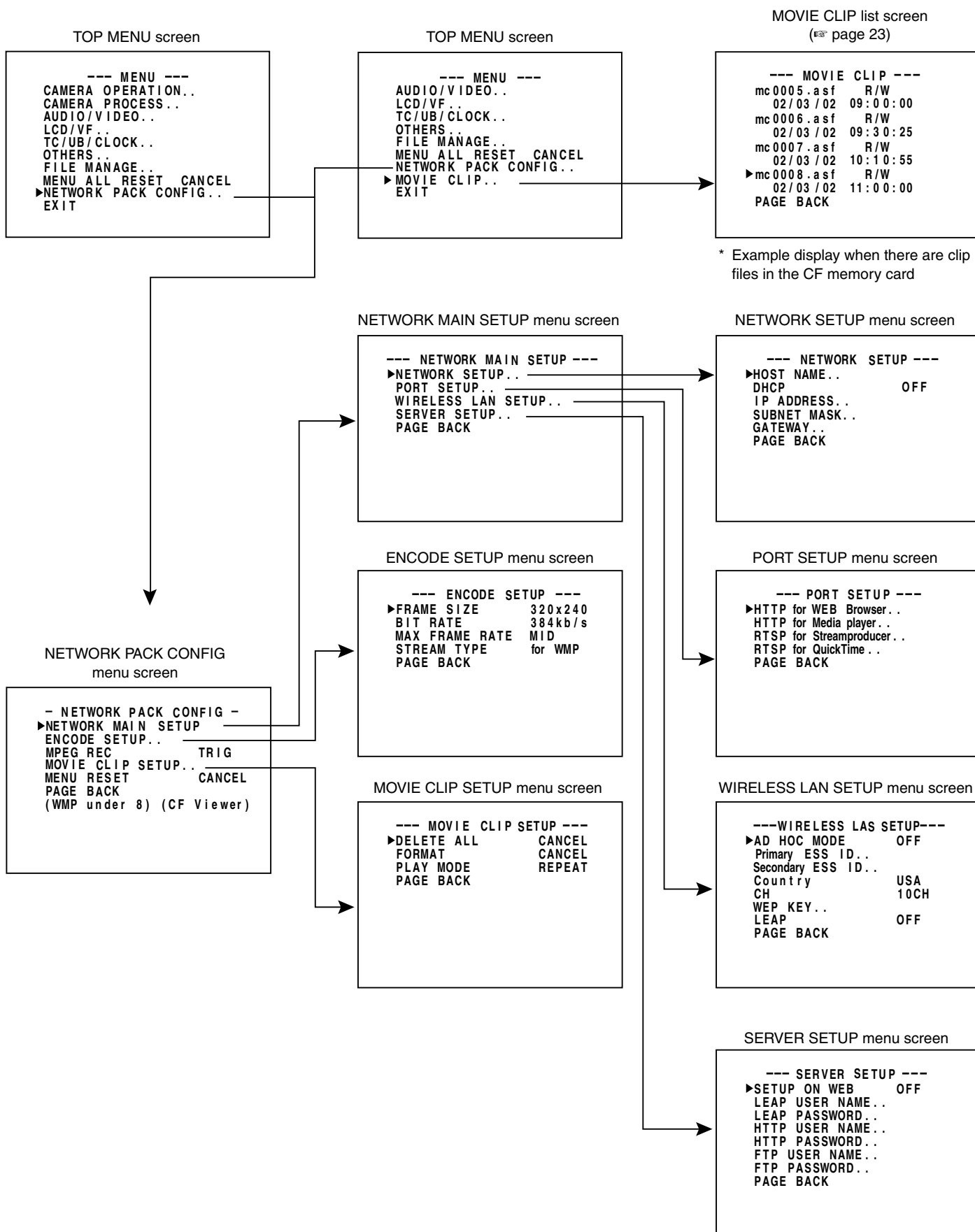

FILE MANAGE settings

When using a CF card, "EXT1" and "EXT2" are additionally displayed in the GY-DV5000 FILE MANAGE screen of LOAD and STORE FILE column. Saving and reading-out can be performed to and from the CF card with MENU setting value as EXT1 or EXT2. When deleting files saved on a CF card, delete "EXT1.dat" or "EXT2.dat" file in the data folder of the CF card using a PC.

Menu screen

NETWORK PACK CONFIG menu screen items

● indicates default factory setting.

Item	Setting	Description																																																																																																																							
NETWORK MAIN SETUP		Displays menu screen for network related settings. (☞ page 11)																																																																																																																							
ENCODE SETUP		Displays menu screen for setting video and audio compressions.																																																																																																																							
FRAME SIZE	● 320 × 240 160 × 120	Sets the video compression size. 320 × 240: Sets the image size to 320 × 240 pixels. (CIF) 160 × 120: Sets the image size to 160 × 120 pixels. (QCIF) (1/4 image size of CIF.)																																																																																																																							
VIDEO RATE	56K 128K 256K ● 384K 512K	Sets streaming speed (bps). 56K: MPEG4 24 kbps G726 16 kbps 128K: MPEG4 104 kbps G726 16 kbps 256K: MPEG4 232 kbps G726 24 kbps 384K: MPEG4 352 kbps G726 32 kbps 512K: MPEG4 472 kbps G726 40 kbps																																																																																																																							
MAX FRAME RATE	MAX ● MID MIN	Sets the frame rate per second. Settings are as shown below.																																																																																																																							
		<table border="1"> <thead> <tr> <th colspan="2" rowspan="2">BIT RATE (bps)</th> <th colspan="6">FRAME SIZE</th> </tr> <tr> <th colspan="3">320 × 240</th> <th colspan="3">160 × 120</th> </tr> <tr> <th colspan="2"></th> <th>MAX</th> <th>MID</th> <th>MIN</th> <th>MAX</th> <th>MID</th> <th>MIN</th> </tr> </thead> <tbody> <tr> <td rowspan="2">512K</td> <td>NTSC</td> <td>15</td> <td>10</td> <td>7.5</td> <td>30</td> <td>15</td> <td>10</td> </tr> <tr> <td>PAL</td> <td>12.5</td> <td>5</td> <td>5</td> <td>25</td> <td>12.5</td> <td>12.5</td> </tr> <tr> <td rowspan="2">384K</td> <td>NTSC</td> <td>15</td> <td>10</td> <td>7.5</td> <td>30</td> <td>15</td> <td>10</td> </tr> <tr> <td>PAL</td> <td>12.5</td> <td>5</td> <td>5</td> <td>25</td> <td>12.5</td> <td>5</td> </tr> <tr> <td rowspan="2">256K</td> <td>NTSC</td> <td>15</td> <td>7.5</td> <td>5</td> <td>30</td> <td>15</td> <td>7.5</td> </tr> <tr> <td>PAL</td> <td>12.5</td> <td>5</td> <td>5</td> <td>25</td> <td>12.5</td> <td>5</td> </tr> </tbody> </table> <table border="1"> <thead> <tr> <th colspan="2" rowspan="2">BIT RATE (bps)</th> <th colspan="6">FRAME SIZE</th> </tr> <tr> <th colspan="3">320 × 240</th> <th colspan="3">160 × 120</th> </tr> <tr> <th colspan="2"></th> <th>MAX</th> <th>MID</th> <th>MIN</th> <th>MAX</th> <th>MID</th> <th>MIN</th> </tr> </thead> <tbody> <tr> <td rowspan="2">128K</td> <td>NTSC</td> <td>7.5</td> <td>5</td> <td>3</td> <td>15</td> <td>10</td> <td>7.5</td> </tr> <tr> <td>PAL</td> <td>5</td> <td>5</td> <td>1</td> <td>12.5</td> <td>12.5</td> <td>5</td> </tr> <tr> <td rowspan="2">56K</td> <td>NTSC</td> <td>3</td> <td>1</td> <td>1</td> <td>10</td> <td>7.5</td> <td>5</td> </tr> <tr> <td>PAL</td> <td>1</td> <td>1</td> <td>1</td> <td>12.5</td> <td>5</td> <td>5</td> </tr> </tbody> </table> <p>* The frame rates shown in the table are not guaranteed values.</p>	BIT RATE (bps)		FRAME SIZE						320 × 240			160 × 120					MAX	MID	MIN	MAX	MID	MIN	512K	NTSC	15	10	7.5	30	15	10	PAL	12.5	5	5	25	12.5	12.5	384K	NTSC	15	10	7.5	30	15	10	PAL	12.5	5	5	25	12.5	5	256K	NTSC	15	7.5	5	30	15	7.5	PAL	12.5	5	5	25	12.5	5	BIT RATE (bps)		FRAME SIZE						320 × 240			160 × 120					MAX	MID	MIN	MAX	MID	MIN	128K	NTSC	7.5	5	3	15	10	7.5	PAL	5	5	1	12.5	12.5	5	56K	NTSC	3	1	1	10	7.5	5	PAL	1	1	1	12.5	5	5
BIT RATE (bps)		FRAME SIZE																																																																																																																							
		320 × 240			160 × 120																																																																																																																				
		MAX	MID	MIN	MAX	MID	MIN																																																																																																																		
512K	NTSC	15	10	7.5	30	15	10																																																																																																																		
	PAL	12.5	5	5	25	12.5	12.5																																																																																																																		
384K	NTSC	15	10	7.5	30	15	10																																																																																																																		
	PAL	12.5	5	5	25	12.5	5																																																																																																																		
256K	NTSC	15	7.5	5	30	15	7.5																																																																																																																		
	PAL	12.5	5	5	25	12.5	5																																																																																																																		
BIT RATE (bps)		FRAME SIZE																																																																																																																							
		320 × 240			160 × 120																																																																																																																				
		MAX	MID	MIN	MAX	MID	MIN																																																																																																																		
128K	NTSC	7.5	5	3	15	10	7.5																																																																																																																		
	PAL	5	5	1	12.5	12.5	5																																																																																																																		
56K	NTSC	3	1	1	10	7.5	5																																																																																																																		
	PAL	1	1	1	12.5	5	5																																																																																																																		
STREAM TYPE	● for WMP for QT	Sets the player for stream playback. for WMP : Media Player, Streamproducer for QT : Quick Time Memo <ul style="list-style-type: none"> No sound will be heard when playing back using QuickTime while in the WMP mode. No sound will be heard when playing back using Media Player while in the QT mode. Set to WMP mode when recording to CF memory card. 																																																																																																																							
PAGE BACK		Pressing the SHUTTER dial returns to the NETWORK PACK CONFIG menu screen.																																																																																																																							
MPEG REC	● TRIG SPLIT OFF	Selects the operation method for recording video data to a CF memory card or sending data to a remote media from a LAN card. TRIG: Pressing the VTR trigger button of GY-DV5000 starts operation. Use this setting when simultaneously recording to a DV tape. SPLIT: Use this setting when recording or transferring with CF memory card or LAN card only. Operation starts when pressing the VTR trigger button on the side of GY-DV5000. Memo When SPLIT is selected, the unit will not operate even when pressing the VTR trigger button on the front or on the lens. OFF: Recording will not be made to the CF memory card and streaming data from the LAN card will not be recorded/sent to the PC even when pressing the VTR trigger button of GY-DV5000.																																																																																																																							

→ OVER

Menu screen

NETWORK PACK CONFIG menu screen items

Item	Setting	Description
MOVIE CLIP SETUP		Displays the menu screen for CF memory card related settings such as formatting or deleting all recorded clip files.
DELETE ALL	<ul style="list-style-type: none"> ●CANCEL EXECUTE 	<p>Selecting EXECUTE and pressing the SHUTTER dial deletes all clip files on the CF memory card.</p> <p>Protected clip files are not deleted.</p>
FORMAT	<ul style="list-style-type: none"> ●CANCEL EXECUTE 	<p>Selecting EXECUTE and pressing the SHUTTER dial starts formatting the card.</p> <p>All recorded clips are erased.</p>
PLAY MODE	<ul style="list-style-type: none"> OFF REPEAT 1 ●REPEAT 	<p>Playback is performed from the specified clip file to the latest clip file and pauses at the specified clip file.</p> <p>Specified clip file is played backed 3 times.</p> <p>Playback is performed 3 times from the specified clip file to the latest clip file.</p>
PAGE BACK		Pressing the SHUTTER dial returns to the NETWORK PACK CONFIG menu screen.
MENU RESET	<ul style="list-style-type: none"> ●CANCEL EXECUTE 	Selecting EXECUTE and pressing the SHUTTER dial returns NETWORK PACK CONFIG menu screen settings to the original factory settings.
PAGE BACK		Pressing the SHUTTER dial returns to the TOP MENU screen.

Menu screen

Setting the NETWORK PACK CONFIG menu screen

Menu screen settings can be made regardless of whether a card is inserted. Settings will be stored in the KA-DV5000 memory even when turning the power off.

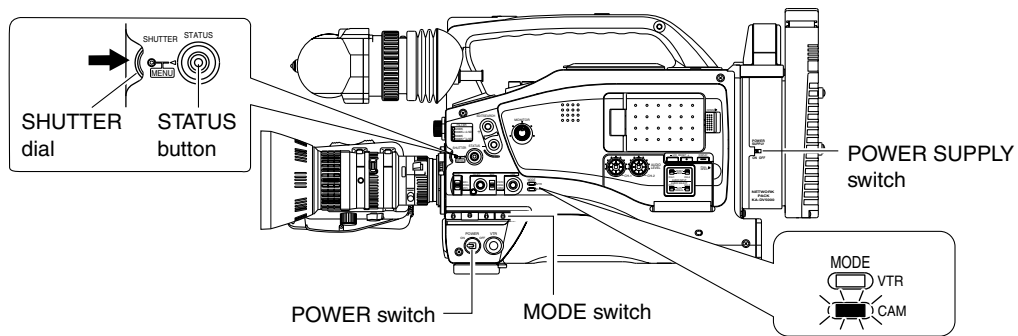

- The NETWORK PACK CONFIG menu screen will not appear during card initialization (flashing display).

■ Settings are made by viewing the LCD screen or viewfinder screen.

If OUTPUT CHAR of the OTHERS (1/2) menu screen is set to ON, the menu screen also appears on the monitor screen connected to the MONITOR OUT or Y/C OUT connector.

1. Set the POWER switch of the GY-DV5000 and KA-DV5000 to ON.
2. Set the MODE switch.
 - Set to "CAM" when shooting a video. (Light the CAM indicator.)
 - Set to "VTR" for VTR playback, clip file playback or DV signal recording. (Light the VTR indicator.)
3. Press the STATUS button for about 1 seconds. The TOP MENU screen appears.
4. Turn the SHUTTER dial, move the cursor (▶) to NETWORK PACK CONFIG and press the SHUTTER dial.
 - The NETWORK PACK CONFIG menu screen appears.
5. Select the item to set. Turn the SHUTTER dial, move the cursor to the desired item to set and press the SHUTTER dial.
 - The selected menu screen appears.
 - When selecting MPEG REC or MENU RESET, the setting area flashes and the setting can be changed. Set the item according to step 7.
 - When selecting NETWORK MAIN SETUP, the network related setting screen appears. (☞ page 10)
6. Select an item within the menu screen. Turn the SHUTTER dial, move the cursor (▶) to the desired item to set and press the SHUTTER dial.
 - The setting area flashes and the setting can be changed.
7. Change the setting. Turn the SHUTTER dial to change the setting and press the SHUTTER dial.
 - Flashing of the setting area stops and the new setting is confirmed.

■ When changing multiple settings, repeat steps 6 and 7 above.

8. Return to the TOP MENU screen. Turn the SHUTTER dial, move the cursor (▶) to PAGE BACK and press the SHUTTER dial.
9. When quitting menu screen setting and returning to the normal screen, perform one of the following operations.
 - Press the STATUS button.
 - Move the cursor (▶) to EXIT in the TOP MENU screen and press the SHUTTER dial.

TOP MENU screen

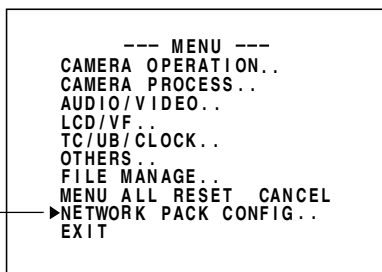

Cursor

NETWORK PACK CONFIG menu screen

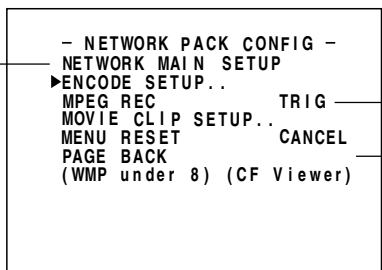

NETWORK MAIN SETUP menu screen Setting (☞ page 10)

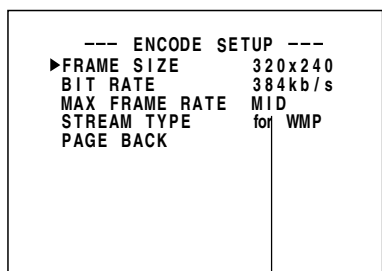

Setting

Menu screen Returning the NETWORK PACK CONFIG menu screen to factory settings

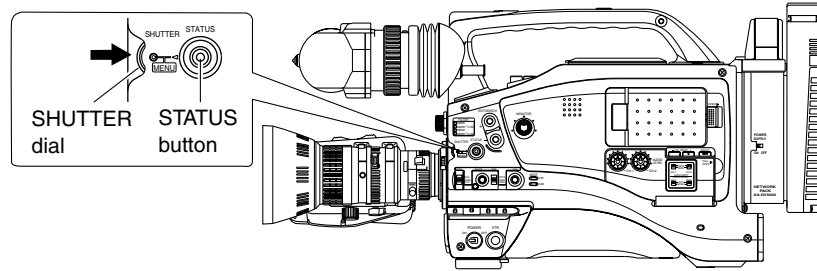

NETWORK PACK CONFIG
menu screen

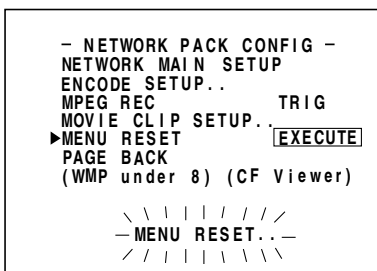

- 1.** Press the STATUS button for about 1 seconds to display the TOP MENU screen.
- 2.** Check to see that the card status display has changed from a flashing to constant display.
- 3.** Turn the SHUTTER dial to select NETWORK PACK CONFIG and press the SHUTTER dial.
 - The NETWORK PACK CONFIG menu screen appears.
- 4.** Turn the SHUTTER dial to set MENU RESET to "EXECUTE" and press the SHUTTER dial.
 - When resetting the menu, "MENU RESET.." will appear at the bottom of the screen for about 5 seconds.
 - The NETWORK PACK CONFIG menu screen settings will return to the factory settings.

Network settings

Setting the NETWORK MAIN SETUP menu screen

When using a LAN card, network related settings for KA-DV5000 are made using NETWORK MAIN SETUP of the NETWORK PACK CONFIG menu. Settings will be stored in the KA-DV5000 memory even when turning the power off.

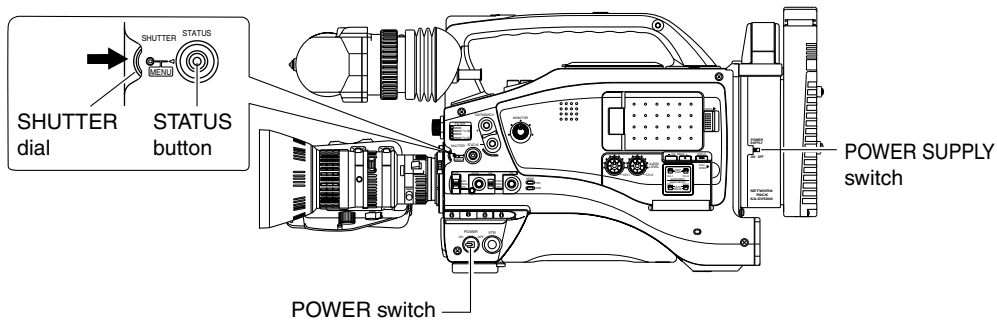

TOP MENU screen

```
--- MENU ---
CAMERA OPERATION..
CAMERA PROCESS..
AUDIO/VIDEO..
LCD/VF..
TC/UB/CLOCK..
OTHERS..
FILE MANAGE..
MENU ALL RESET CANCEL
▶NETWORK PACK CONFIG..
EXIT
```

NETWORK PACK CONFIG menu screen

```
- NETWORK PACK CONFIG -
▶NETWORK MAIN SETUP..
ENCODE SETUP..
MPEG REC TRIG
MOVIE CLIP SETUP..
MENU RESET CANCEL
PAGE BACK
(WMP under 8) (CF Viewer)
```

NETWORK MAIN SETUP menu screen

```
--- NETWORK MAIN SETUP ---
▶NETWORK SETUP..
PORT SETUP..
WIRELESS LAN SETUP..
SERVER SETUP..
PAGE BACK
```

NETWORK SETUP menu screen

```
--- NETWORK SETUP ---
▶HOST NAME..
DHCP ---
IP ADDRESS..
SUBNET MASK..
GATE WAY..
PAGE BACK
```

Settings are made by viewing the LCD screen or viewfinder screen.

If OUTPUT CHAR of the OTHERS (1/2) menu screen is set to ON, the menu screen also appears on the monitor screen connected to the MONITOR OUT or Y/C OUT connector.

Display the NETWORK SETUP menu screen

1. Turn on the GY-DV5000 and KA-DV5000 power.
2. Check to see that the card status display has changed from a flashing to constant display.
3. Press the STATUS button for about 1 seconds to display the TOP MENU screen.
4. Turn the SHUTTER dial, move the cursor (▶) to NETWORK PACK CONFIG and press the SHUTTER dial.
 - The NETWORK PACK CONFIG menu screen appears.
5. Turn the SHUTTER dial, move the cursor (▶) to NETWORK MAIN SETUP and press the SHUTTER dial.
 - The NETWORK MAIN SETUP menu screen will appear.

The NETWORK MAIN SETUP menu screen is structured by four screens.

```
NETWORK SETUP
PORT SETUP
WIRELESS LAN SETUP
SERVER SETUP
```
6. Turn the SHUTTER dial, move the cursor (▶) to SETUP and press the SHUTTER dial.
 - The selected SETUP screen appears.

Items with “.” at the end of the name are set in the INPUT screen.
7. To return to the NETWORK MAIN SETUP menu screen, select PAGE BACK and press the SHUTTER dial.
8. To return to the normal screen after completing setting, perform one of the following operations.
 - Press the STATUS button
 - Select PAGE BACK to return to the TOP MENU screen. Select EXIT in the TOP MENU screen and press the SHUTTER dial.

Network settings

NETWORK MAIN SETUP menu screen items

NETWORK SETUP menu screen ● indicates default factory setting.

Item	Setting	Description
HOST NAME		Displays the host name input setting screen. (4 ~ 64 alphanumerical characters) [Factory setting: none]
DHCP	●OFF ON	Select whether DHCP server is used. OFF: Use this setting when using LAN connection rather than DHCP. When this setting is used, IP ADDRESS and SUBNET MASK, GATEWAY must also be set. ON: Use this setting when using DHCP connection. When using this setting, IP ADDRESS and SUBNET MASK, GATEWAY are automatically set. * When DHCP is set to ON, WLAN ADHOC MODE cannot be set to AHDM or IBSS.
IP ADDRESS		Displays the IP address setting screen. When using LAN connection with DHCP set to OFF, this setting is required. Set a unique IP address. IP ADDRESS setting is not available when DHCP is set to ON. [Factory setting] 192.168.100.101]
SUBNET MASK		Displays the subnet mask input screen. This setting is required when using LAN connection with DHCP set to OFF. SUBNET MASK setting is not available if DHCP is set to ON. [Factory setting: 255.255.255.000]
GATE WAY		Displays the gateway address input screen. GATEWAY setting is not available when DHCP is set to ON. [Factory setting: 192.168.100.254]
PAGE BACK		Pressing the SHUTTER dial returns to the NETWORK MAIN SETUP menu screen.

PORT SETUP menu screen

Item	Setting	Description
HTTP for WEB Browser	1 : ●80 : 32767	The screen for setting RTSP and HTTP port numbers appears. HTTP for Web Browser can be set with the Web browser HTTP port number and HTTP for Media Player can be set with the Media Player HTTP port number. RTSP for Streamproducer can be set with the Streamproducer RTSP port number and RTSP for Quick Time can be set with the Quick Time RTSP port number.
HTTP for Media player	1 : ●8080 : 32767	Normally, the unit can be used without changing the factory settings. If there are port restrictions for the LAN environment of your PC, consult your network administrator. * When changing a port number, refer to "5-1. Connecting with Camcorder" of the "Streamproducer" User's Guide of the network distribution software to change settings.
RTSP for Streamproducer	1 : ●8554 : 32767	* Do not use the same port numbers for RTSP and HTTP. * When a port number is changed, switch the power of the GY-DV5000 off once, and then switch it on again.
RTSP for Quick Time	1 : ●554 : 32767	
PAGE BACK		Pressing the SHUTTER dial returns to the NETWORK SETUP menu screen.

→ OVER

Network settings

NETWORK MAIN SETUP menu screen items

WIRELESS LAN SETUP menu screen ● indicates default factory setting.

Item	Setting	Description
AD HOC MODE	●OFF AHDM IBSS	Wireless LAN setting OFF: Use this setting when performing communication via access point. AHDM/IBSS: Use this setting when performing communication in AD HOC mode with a PC connected with a wireless LAN card. (see page 16) * When this item is set to AHDM or IBSS, DHCP cannot be set to ON.
Primary ESS ID	NONE	Displays the wireless LAN ESS-ID input setting screen (Max. 32 alphanumerical characters)
Secondary ESS ID	NONE	
Country	●USA EU FRN SPN JPN	Setting for the country using wireless LAN USA: USA, EU: Europe, FRN: France SPN: Spain, JPN: Japan (Set according to operating environment.)
CH	1CH : ●10CH : 14CH	Wireless LAN channel setting CH setting changes depending on the Country setting. USA: 1 ~ 11CH, EU: 1 ~ 13CH, FRN: 10 ~ 13CH, SPN: 10, 11CH, JPN: 1 ~ 14CH
WEP KEY		When encrypting data, set the WEP KEY (10 or 26 characters consisting of letters a ~ f and numbers). Must be compatible with access point authentication for the use of this item.
LEAP	ON ●OFF	Set to ON when connecting a Cisco Systems wireless LAN device and using the LEAP function. Memo The LEAP function is exclusive to Cisco Systems wireless LAN devices. For details concerning the LEAP function, see the instruction manual accompanying the wireless LAN device.
PAGE BACK		Pressing the SHUTTER dial returns to the NETWORK MAIN SETUP menu screen.

SERVER SETUP menu screen

Item	Setting	Description
SETUP ON WEB	ON ●OFF	Set to ON when changing the USER NAME and PASSWORD from the Web. Memo If higher security is desired, set this function to OFF so that changes cannot be made from the Web.
LEAP USER NAME		Displays the LEAP USER NAME input screen. (4 ~ 32 alphanumerical characters) Set when using the LEAP function. [Default setting: leap-user]
LEAP PASSWORD		Displays the LEAP PASSWORD input screen. (4 ~ 32 alphanumerical characters) Set when using the LEAP function. [Default setting: ka-dv-jvc]
HTTP USER NAME		Displays the HTTP USER NAME input screen. (3 ~ 8 alphanumerical characters) Set when connecting from the Web browser. [Default setting: jvc]
HTTP PASSWORD		Displays the HTTP PASSWORD input screen. (4 ~ 8 alphanumerical characters) Set when connecting from the Web browser. [Default setting: ka-dv5k]
FTP USER NAME		Displays the FTP USER NAME input screen. (3 ~ 8 alphanumerical characters) Used when uploading USER PAGE. [Default setting: ftp-user]
FTP PASSWORD		Displays the FTP PASSWORD input screen. (4 ~ 8 alphanumerical characters) Used when uploading USER PAGE. [Default setting: ka-dv]
PAGE BACK		Pressing the SHUTTER dial returns to the NETWORK MAIN SETUP menu screen.

Memo

For details concerning user name and password settings, see page 13.

■ Changing the user name

When changing the HTTP USER NAME or FTP USER NAME, "NEXT STEP SET PASSWORD" will appear on the screen and the PASSWORD menu screen is displayed.

When input is canceled in the PASSWORD menu screen, the user name will also be canceled.

It is possible to change only the password.

When changing the LEAP USER NAME setting, the PASSWORD menu screen will not appear automatically.

■ Setting passwords

Set LEAP, HTTP and FTP PASSWORD using the procedure shown below.

- 1.** First, enter the currently used password when "ENTER OLD PASSWORD" is displayed.
- 2.** Next, enter the new password when "ENTER NEW PASSWORD" is displayed.
- 3.** Lastly, enter the new password again when "CONFIRM NEW PASSWORD" is displayed.

Caution

- Do not forget to take a memo of the password. The password cannot be redisplayed.
- Each character input on the PASSWORD menu screen is hidden using asterisks (*).
- When performing MENU RESET, the unit will return the default factory settings.

Network related settings are made in the individual input setting screens.

Here, HTTP USER NAME is set as an example. Other settings are also made in the same manner.

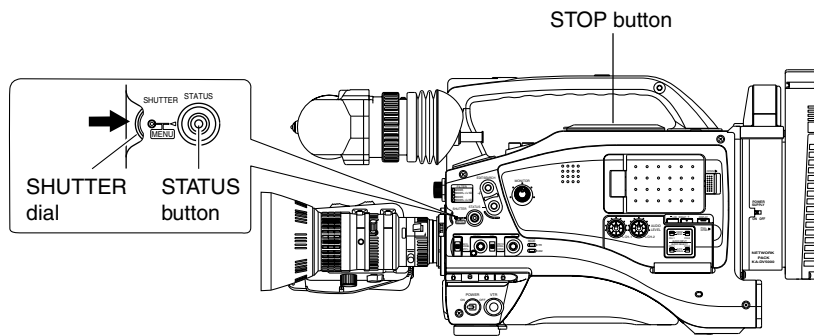

HTTP USER NAME input setting screen

Currently inputted number of characters/
max.number of characters

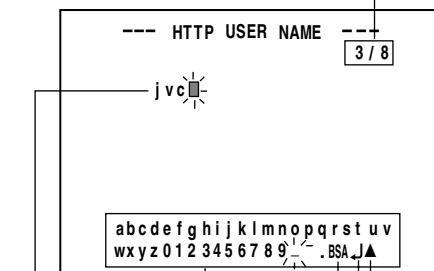

Setting area Character
selection area

BS: Backspace (delete previous character)

J: The set text is confirmed and
returns to the previous screen.

▲: The set text is canceled and
returns to the previous screen.

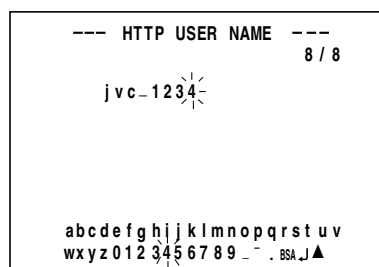
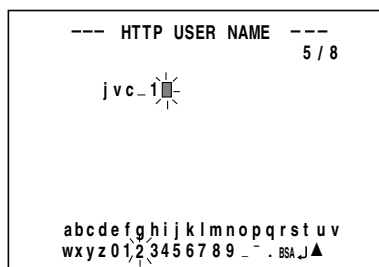
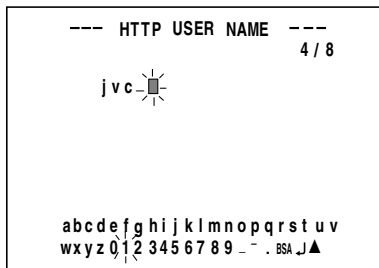

Example: Changing HTTP USER NAME from jvc to jvc-1234

■ Select HTTP USER NAME in the SERVER SETUP menu screen and press the SHUTTER dial.

- The USER NAME input setting screen appears.

1. Characters are selected from the character selection area on the bottom of the screen.

Turn the SHUTTER dial to flash “_” in the character selection area and press the SHUTTER dial.

- The setting changes to “jvc_” and the following digit of the setting area flashes.

2. Turn the SHUTTER dial to select “1” in the character selection area and press the SHUTTER dial.

- The setting changes to “jvc_1” and the following digit of the setting area flashes.

3. Repeat the above step to set “jvc_1234” in the setting area.

■ To delete or edit set characters, select “BS” within the character selection area and press the SHUTTER dial.

The previous character will be deleted. The character on the left will be deleted each time this operation is repeated.

■ When turning the SHUTTER dial while holding down the STOP button, the cursor will move 5 characters at a time.

■ The currently inputted number of characters and the maximum number of characters are displayed on the upper right of the screen.

■ To cancel a setting, select the “▲” within the character selection area and press the SHUTTER dial. The unit will return to the previous screen (SERVER SETUP menu screen).

4. When completed, select “J” within the character selection area and press the SHUTTER dial.

- When changing the HTTP USER NAME or FTP USER NAME, “NEXT STEP SET PASSWORD” will appear on the screen and the PASSWORD menu screen is displayed. Set the password using the procedure shown above.

Memo

When setting is completed for items other than HTTP USER NAME and FTP USER NAME, the unit will return to the previous screen (NETWORK MAIN SETUP or SERVER SETUP menu screen).

Example of IP address and subnet mask settings when using LAN is shown below.

- Operation is only guaranteed for Windows 2000, Windows XP Home Edition or Windows XP Professional.
- Internet Explorer 5.0 or later
- Windows Media Player 7.01 or later (WM9 is not supported.)

1. For 1:1 communication between PC and GY-DV5000/KA-DV5000

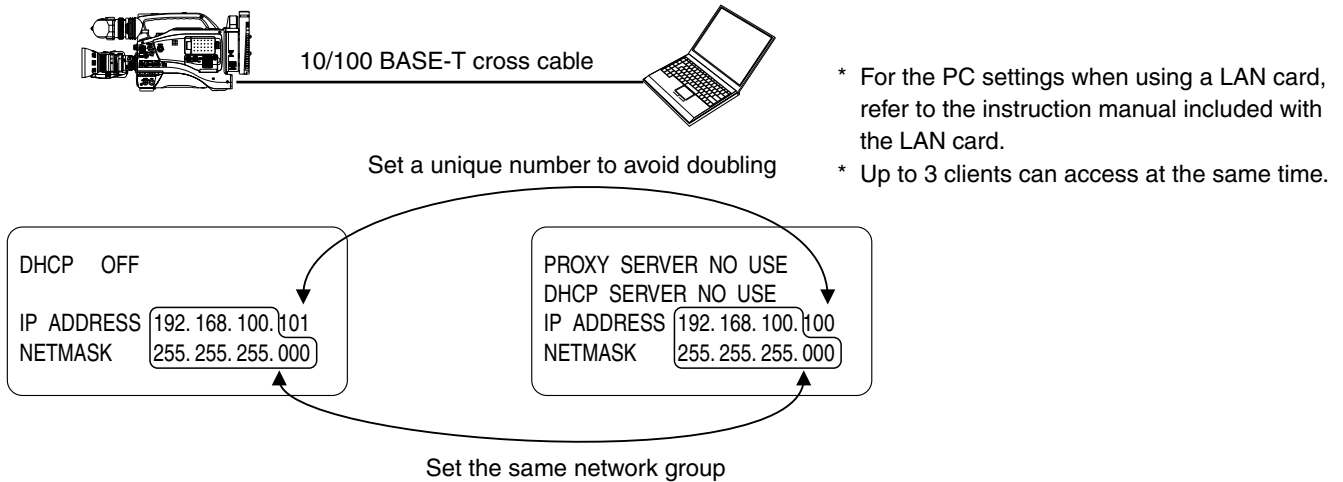

2. For communication between PC and multiple GY-DV5000/KA-DV5000

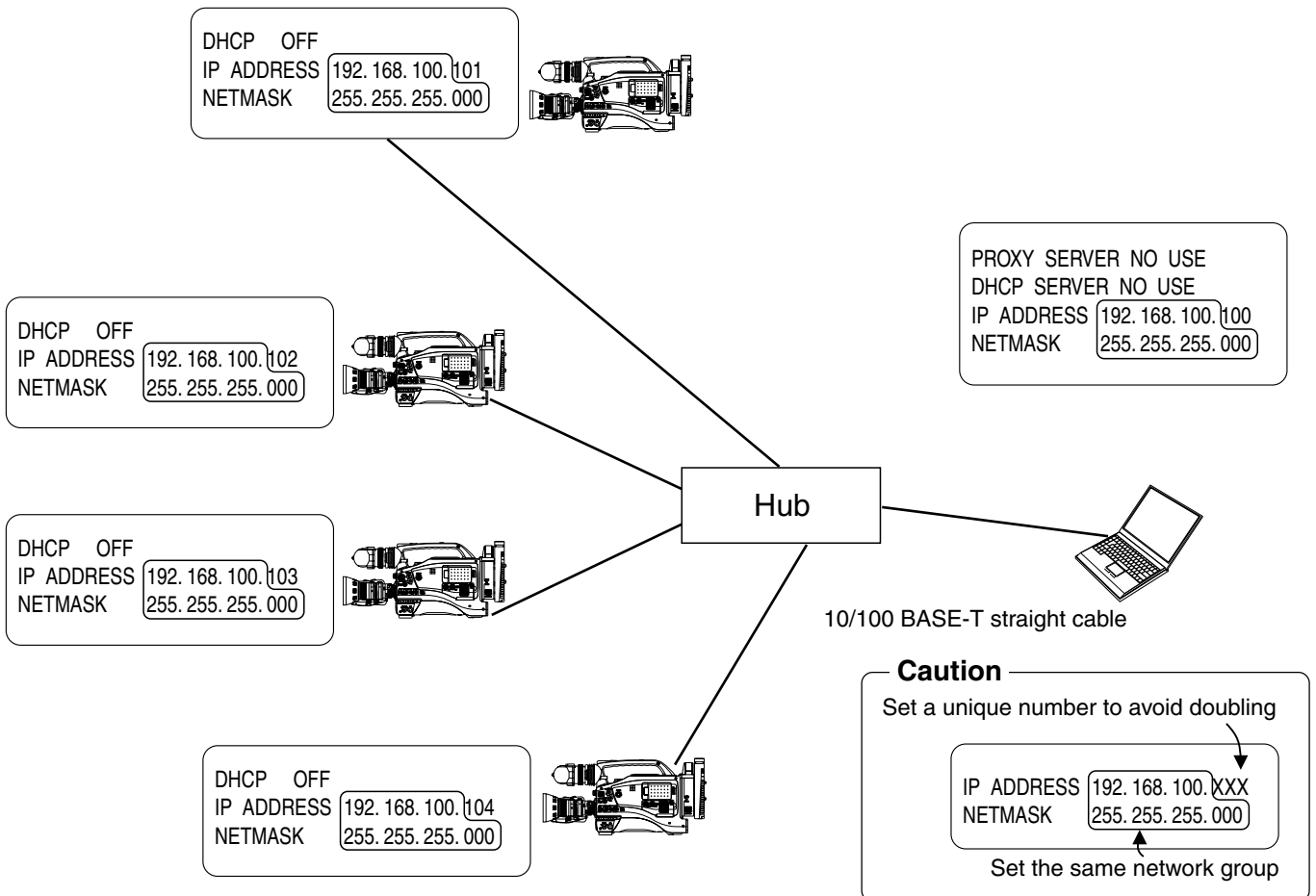

Example of network settings when using wireless LAN is shown below.

- Operation is only guaranteed for Windows 2000, Windows XP Home Edition or Windows XP Professional.
- Internet Explorer 5.0 or later
- Windows Media Player 7.01 or later (WM9 is not supported.)

1. For communication with PC without returning access point (Ad hoc mode)



* Do not perform encryption of the wireless LAN.

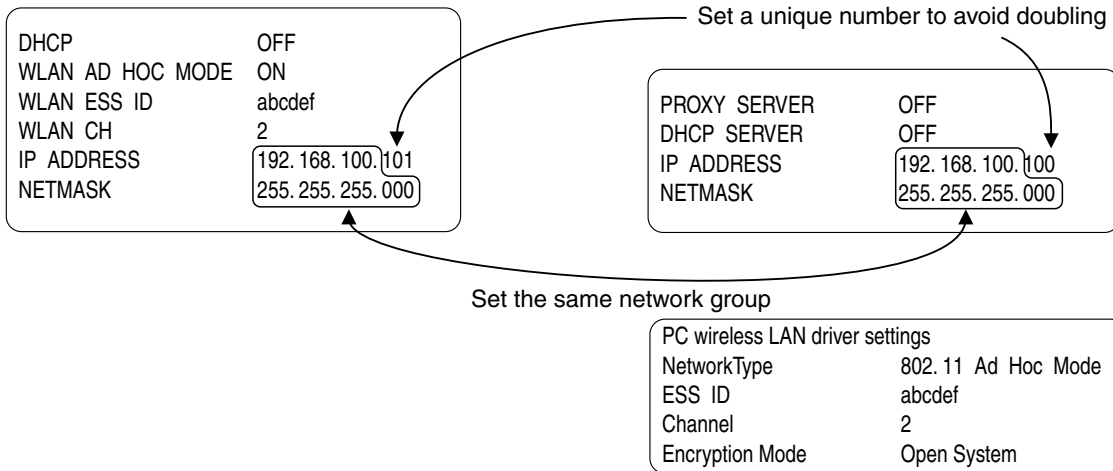

* For the PC settings when using a LAN card, refer to the instruction manual included with the LAN card.

Cautionary items concerning Wireless LAN (WLAN)

- For the WLAN ESS ID, input the values of ESSID set in:
Ad hoc mode: PC of other party
Infrastructure: Access point
- WLAN AD HOC MODE
When IBSS is set, the NETWORK MODE setting of the wireless LAN card on the PC side must be set to 802.11 Adhoc.
When AHDM is set, the NETWORK MODE setting of the wireless LAN card on the PC side must be set to Adhoc. Depending on the LAN card on the PC side, only 802.11 Adhoc mode may be available.
- WLAN CH is the wireless frequency band used for communication. If there is an access point, adapter, etc., using the same band in the proximity, there may be a hindrance in the communication and may reduce throughput or the quality of communication. When setting, check the settings of surrounding access points, etc., to avoid doubling.

Frequency bands (ISM bands) and channels (IEEE803.11b standard)

- N. America : FCC / 2.412~2.462GHz (11 channels)
- Europe : CE ETSI / 2.412~2.472GHz (13 channels)
- Japan : 2.412~2.4835GHz (14 channels)
- France : 2.457~2.472GHz (4 channels)
- Spain : 2.457~2.462GHz (2 channels)

Since adjacent channels causes signal interference, channels are normally spaced 5 channels apart.
(Set according to operating environment.)

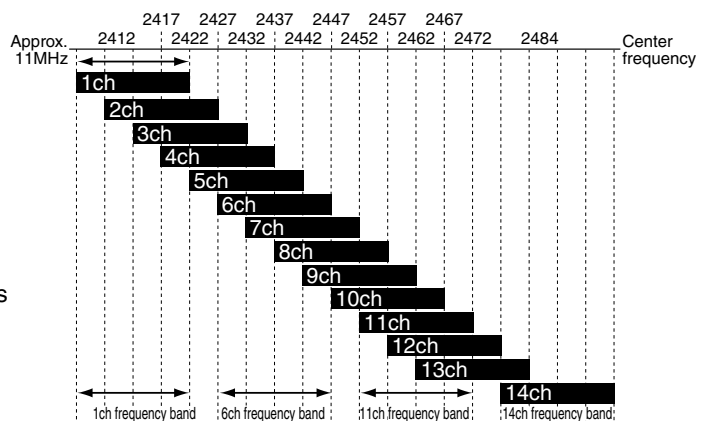

2. For communication with PC via access point (Infrastructure mode)

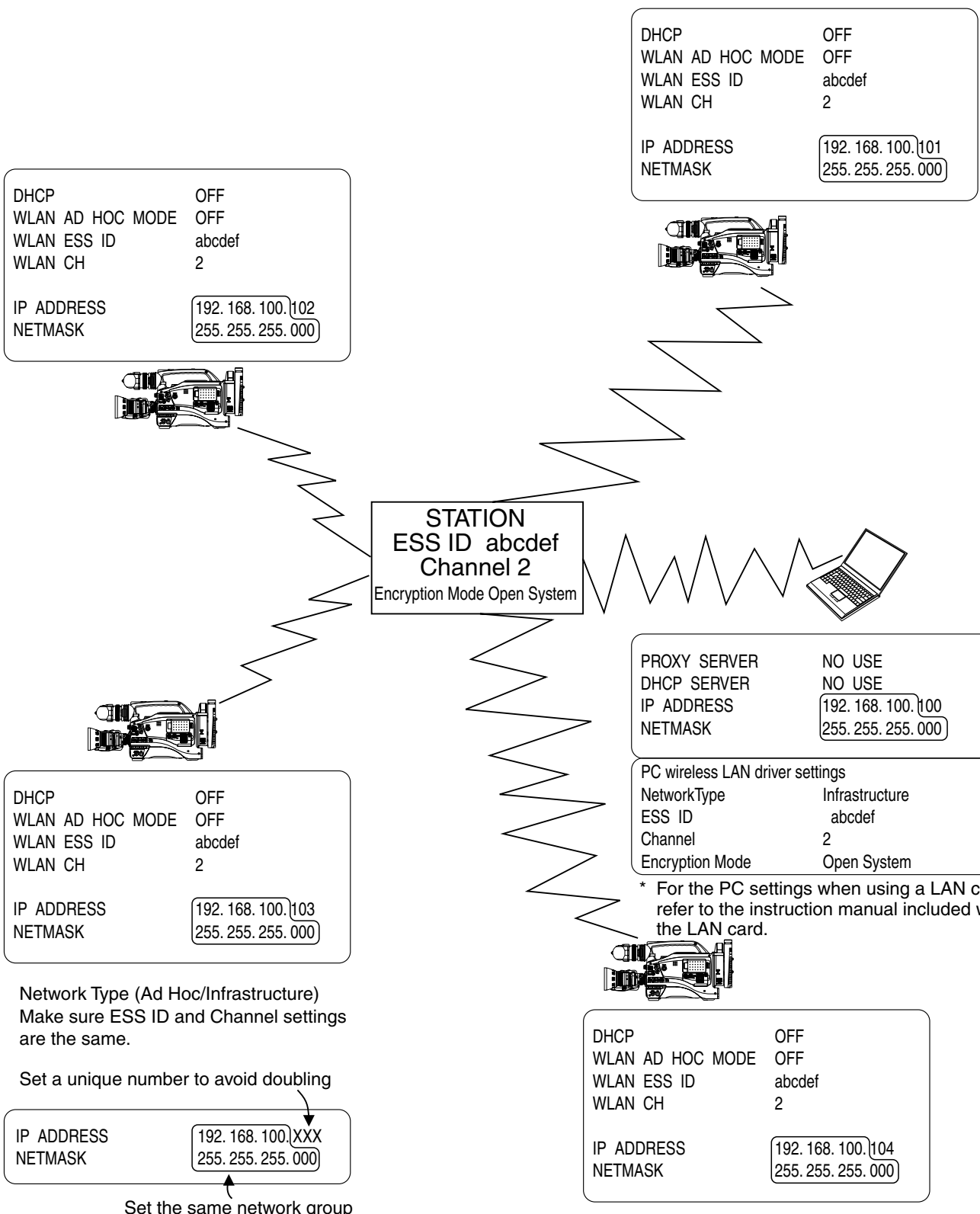

Memo

For network settings and LAN card driver settings, refer to the respective instruction manuals.

Recording on a CF card

Formatting a CF memory card

If the CF memory card is unformatted when performing any of the operations shown below, "NO CF FORMAT" will appear in the LCD screen/viewfinder screen.

- Executing DELETE ALL
- Recording to the CF memory card

Caution

If the unit enters MOVIE CLIP by operating the menu or the VCR trigger button during formatting CF card, a display of the LCD viewer can go wrong. However, if you operate the menu after formatting has been completed, you will be able to regain a normal display.

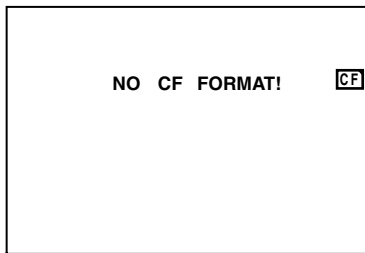
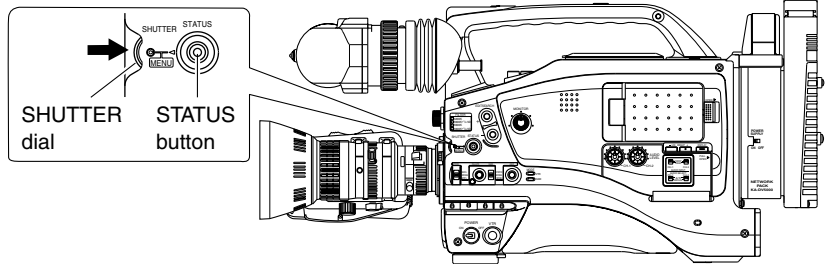

NETWORK PACK CONFIG menu screen

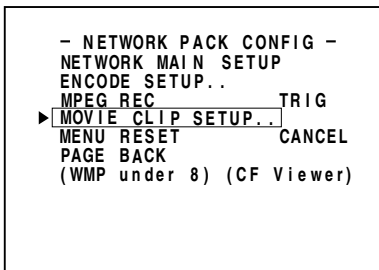

MOVIE CLIP SETUP menu screen

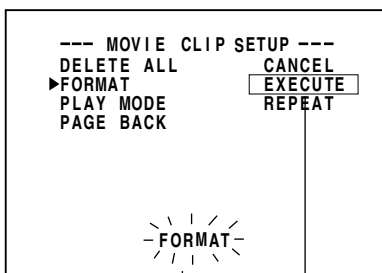

Flashing display during formatting

MOVIE CLIP SETUP menu screen

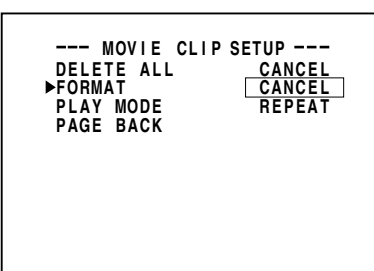

1. Press the STATUS button for about 1 seconds to display the TOP MENU screen.
2. Use the SHUTTER dial to select NETWORK PACK CONFIG menu screen → MOVIE CLIP SETUP menu screen.
3. Set FORMAT in the MOVIE CLIP SETUP menu screen to "EXECUTE" and press the SHUTTER dial.
 - The formatting begins. During formatting, "FORMAT" appears on the screen.
4. When formatting is completed, to the MOVIE CLIP SETUP menu screen returns. The FORMAT setting will return to CANCEL.
5. To return to the NETWORK PACK CONFIG menu screen, select PAGE BACK and press the SHUTTER dial.
 - To return to the normal screen, press the STATUS button.

CF memory recording time

Estimated recording time of CF memory cards is shown below:

CF memory card size	BIT RATE		
	384kbps	256kbps	128kbps ~ 56kbps
16MByte	3min.	5min.	10min. or more
32MByte	7min.	11min.	20min. or more
64MByte	15min.	22min.	40min. or more
128MByte	30min.	44min.	80min. or more
192MByte	46min.	66min.	120min. or more
256MByte	61min.	88min.	160min. or more

Caution

The actual recording time may differ from the estimate recording time shown above depending on the recording subject and movement.

Recording on a CF card Recording video on a DV cassette tape and CF memory card

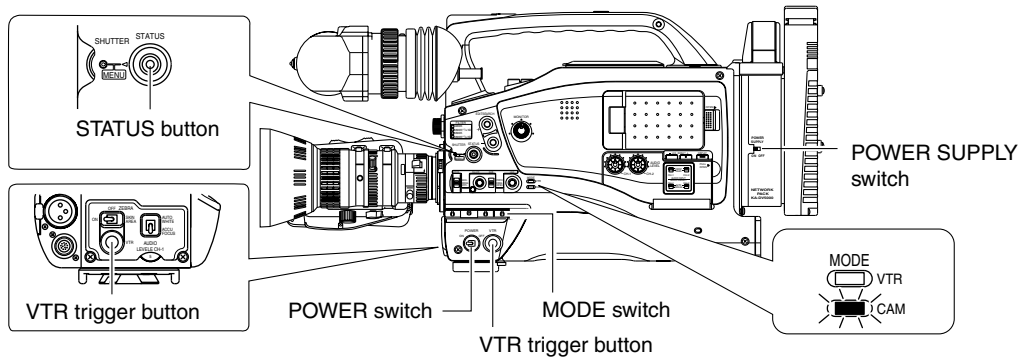

- “NO CF FORMAT!” will appear if the inserted CF memory card is not formatted. Format the card in the MOVIE CLIP SET menu screen. (☞ page 18)

LCD screen



●CF: Red display during recording

☐: Initializing

NETWORK PACK CONFIG menu screen

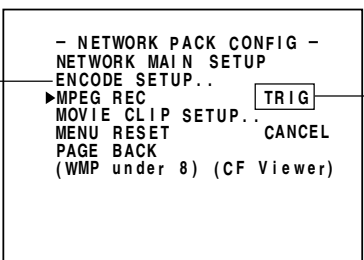

Set to TRIG

ENCODE SETUP menu screen

LCD screen

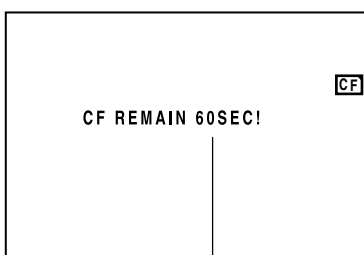

CF memory card remaining warning

1. Insert a CF memory card into the Network Pack.
2. Turn on the GY-DV5000 and KA-DV5000 power. Check to see that the CF display appears on the LCD screen/viewfinder screen. (When the power is turned on, ☐ display will flash during initialization.)
3. Insert a recordable DV cassette tape.
4. Set the MODE switch to “CAM”. (Light the CAM indicator.)
5. Set the NETWORK PACK CONFIG menu screen.
 - ① Set MPEG REC to “TRIG”.
 - ② Set the video/audio compression in the ENCODE SETUP menu screen. (☞ page 6)
 - ③ When completed with settings, press the STATUS button to return to the normal screen.
6. Press the VTR trigger button on GY-DV5000 to start recording on the DV cassette tape as well as video/audio streaming data on the CF memory card.
 - During CF memory card recording, ●CF display will light red.
7. To stop recording, press the VTR trigger button.
8. To resume recording, press the VTR trigger button once more.
9. To end recording, press the VTR trigger button.
 - * Before turning off the power, check to make sure the CF indicator on the LCD screen is white.
 - Turning the power off when the CF indicator is red will damage the recorded clip file.

Memo

- When the DV cassette tape has reached the end during recording, CF memory card recording will also stop.
- Every time recording is performed, the recorded event is stored in the clip list of the CF memory card. Stored contents of clip list: Clip number and date/time when recording was started. All events can be played back on the MOVIE CLIP screen. (☞ page 23)
- The CF memory card remaining warning is displayed on the LCD screen/viewfinder screen. (☞ page 46)
- If recording into the CF card is carried out within 5 seconds, either a file cannot be made or it becomes difficult to display a thumbnail (a still picture displayed when CLIP FILE is selected).
- Do not switch over the CAM/VTR mode during recording into the CF card. If the mode is switched over during recording, the display of the LCD viewer can go wrong once in a while. Also, if the mode is switched over immediately after the start of recording into the CF card, some black images can be mixed into a recorded picture.
- When recording to a CF Memory Card while in the TRIG mode, ***.csv file will be created for viewing using the CFViewer. The CSV file name will be the value of the user's bit (UB) set in GY-DV5000. For details concerning UB, please refer to the operator's manual of GY-DV5000. Time code on CSV files will differ slightly from the actual time code.

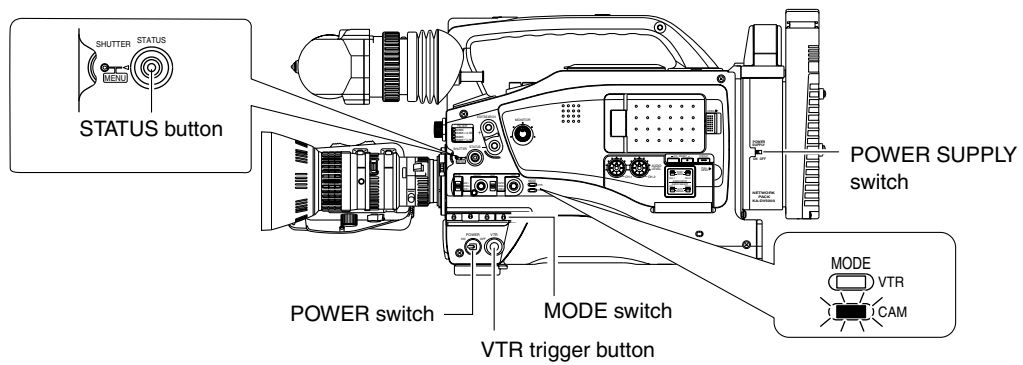

- “NO CF FORMAT!” will appear if the inserted CF memory card is not formatted. Format the card in the MOVIE CLIP SET menu screen. (☞ page 18)

1. Insert a CF memory card into the Network Pack.
2. Turn on the GY-DV5000 and KA-DV5000 power. Check to see that the **CF** display appears on the LCD screen/viewfinder screen. (When the power is turned on, display will flash during initialization.)
3. Set the MODE switch to “CAM”. (Light the CAM indicator.)
4. Set the NETWORK PACK CONFIG menu screen.
 - ① Set MPEG REC to “SPLIT”.
 - ② Set the video/audio compression in the ENCODE SETUP menu screen. (☞ page 6)
 - ③ When completed with settings, press the STATUS button to return to the normal screen.
5. Press the VTR trigger button on side panel of GY-DV5000 to start recording streaming data on the CF memory card.
 - During recording, ● **CF** display will light red.
6. To stop recording, press the VTR trigger button on side panel.
7. To resume recording, press the VTR trigger button on side panel once more.
8. To end recording, press the VTR trigger button on side panel.
 - * Before turning off the power, check to make sure the **CF** indicator on the LCD screen is white.

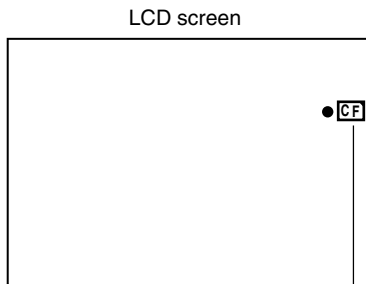

● **CF**: Red display during recording

: Initializing

NETWORK PACK CONFIG menu screen

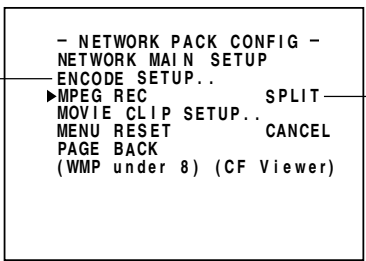

Set to SPLIT

ENCODE SETUP menu screen

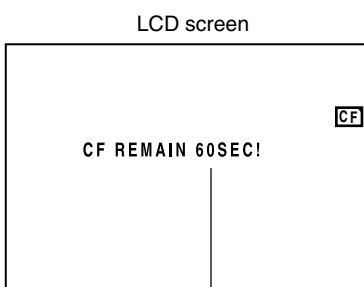

CF memory card remaining warning

Memo

- When recording only to the CF memory card, the clip list will not be registered.
- The CF memory card remaining warning is displayed on the LCD screen/viewfinder screen. (☞ page 46)
- When MPEG REC is set to “SPLIT”, recording is performed only when the VTR trigger button on the side is pressed. The VTR trigger buttons on the front and on the lens are disabled.
- Do not switch over the CAM/VTR mode during recording into the CF card. If the mode is switched over during recording, the display of the LCD viewer can go wrong once in a while. Also, if the mode is switched over immediately after the start of recording into the CF card, some black images can be mixed into a recorded picture.

Recording on a CF card Recording playback signals of a DV cassette tape on a CF memory card

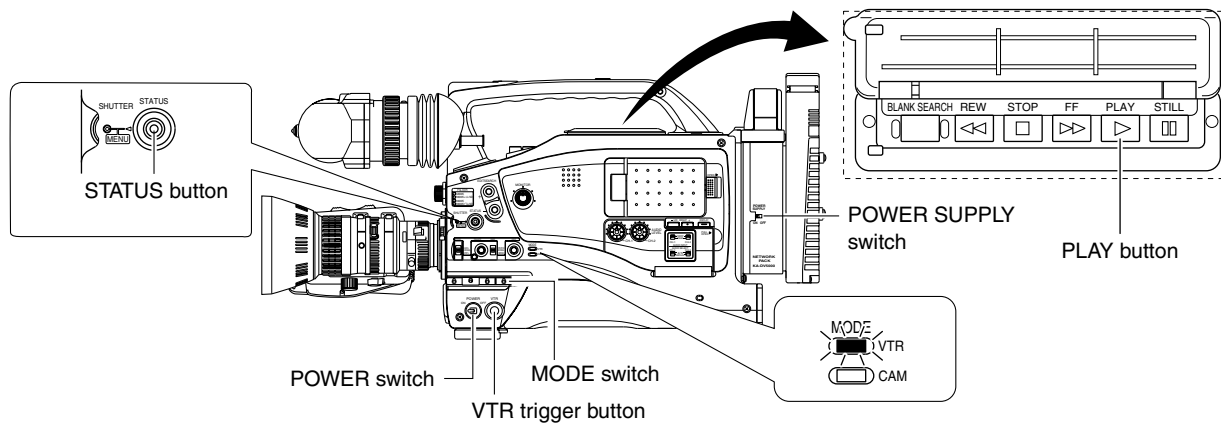

- “NO CF FORMAT!” will appear if the inserted CF memory card is not formatted. Format the card in the MOVIE CLIP SET menu screen. (page 18)

1. Insert a CF memory card into the Network Pack.
2. Turn on the GY-DV5000 and KA-DV5000 power. Check to see that the **CF** display appears on the LCD screen/viewfinder screen. (When the power is turned on, display will flash during initialization.)
3. Insert the recorded DV cassette tape.
4. Set the MODE switch to “VTR”. (Light the VTR indicator.)
5. Set the NETWORK PACK CONFIG menu screen.
 - ① Set MPEG REC to “SPLIT”.
 - ② Set the video/audio compression in the ENCODE SETUP menu screen. (page 6)
 - ③ When completed with settings, press the STATUS button to return to the normal screen.
6. Press the PLAY button of GY-DV5000 to start DV cassette tape playback.
7. Press the VTR trigger button on side panel at the scene to start recording on the CF memory card.
 - During recording, the **CF** display appears in red.
8. To stop recording, press the VTR trigger button on side panel.
9. To resume recording, press the VTR trigger button on side panel once more.
10. To end recording, press the VTR trigger button on side panel.
 - * Before turning off the power, check to make sure the **CF** indicator on the LCD screen is white.

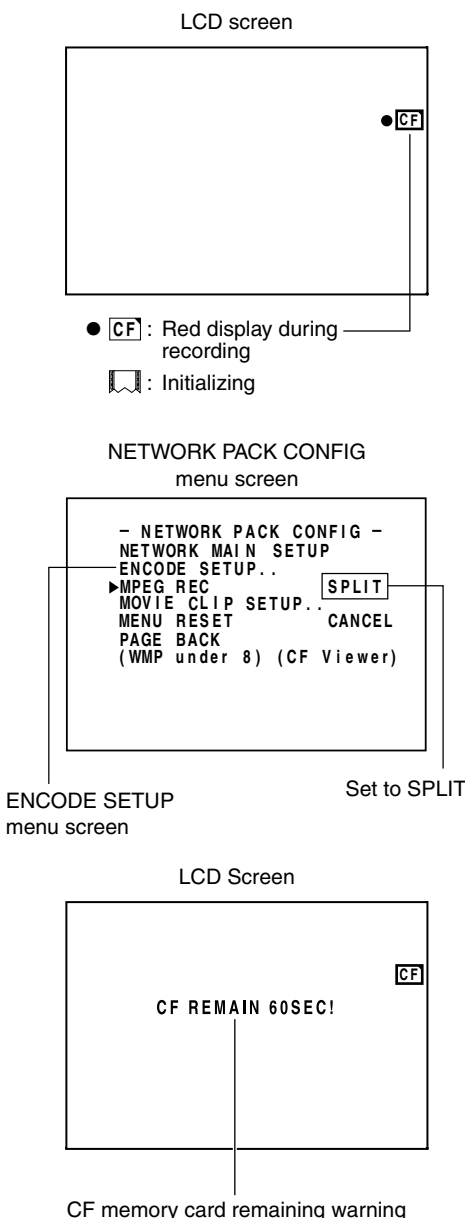

Memo

- When recording only to the CF memory card, the clip list will not be registered.
- The CF memory card remaining time is displayed on the LCD screen/viewfinder screen.
- Do not switch over the CAM/VTR mode during recording into the CF card. If the mode is switched over during recording, the display of the LCD viewer can go wrong once in a while. Also, if the mode is switched over immediately after the start of recording into the CF card, some black images can be mixed into a recorded picture.
- While recording DV input to a CF Memory Card in the SPLIT mode, do not operate the VTR section. Recording to the CF Memory Card may stop as a result.

Recording on a CF card

Deleting all clip files on a CF memory card

MOVIE CLIP SETUP of the NETWORK PACK CONFIG menu screen is used to delete all clips on a CF memory card.

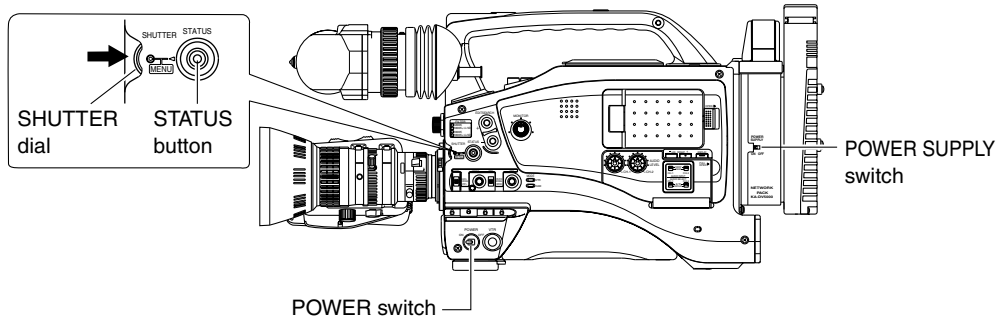

NETWORK PACK CONFIG menu screen

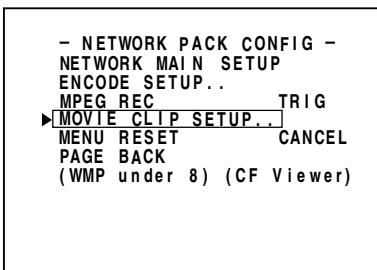

MOVIE CLIP SETUP menu screen

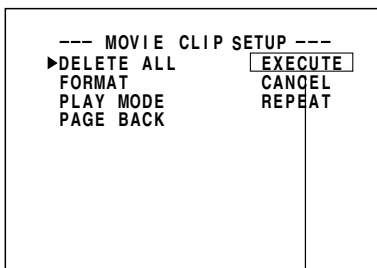

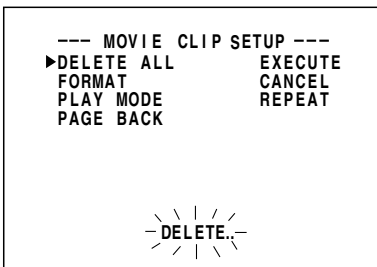

Set to EXECUTE

Deleting

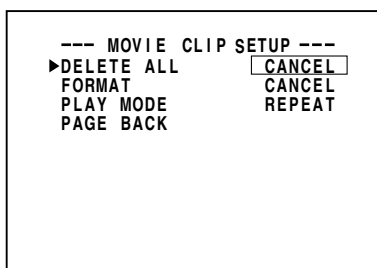

MOVIE CLIP SETUP menu screen



1. Insert an already recorded CF memory card.
2. Turn on the GY-DV5000 and KA-DV5000 power.
Check to see that the **CF** display appears on the LCD screen/viewfinder screen. (The  mark will flash when first turning on the power or during initialization.)
3. Press the STATUS button for about 1 seconds to display the TOP MENU screen.
4. Use the SHUTTER dial to select NETWORK PACK CONFIG menu screen → MOVIE CLIP SETUP menu screen.
5. Set DELETE ALL in the MOVIE CLIP SETUP menu screen to “EXECUTE” and press the SHUTTER dial.
 - Deletion is executed and “DELETE..” appears flashing on the screen.
6. When deletion is completed, to the MOVIE CLIP SETUP menu screen returns. DELETE ALL setting will return to “CANCEL”.
7. ■ To return to the NETWORK CONFIG menu screen, select PAGE BACK and press the SHUTTER dial.
■ To return to the normal screen, press the STATUS button.

Memo

- Protected clips are not deleted.

Movie clip

Playing back video/audio recorded on a CF memory card

When simultaneously recording the camera video to a DV cassette and CF memory card, recording event will be registered to the clip list of the CF memory card each time recording is performed. The clip list is stored with the recorded event number (clip number) and the date/time when the recording was started. All events (clip numbers) can be played back on the MOVIE CLIP screen.

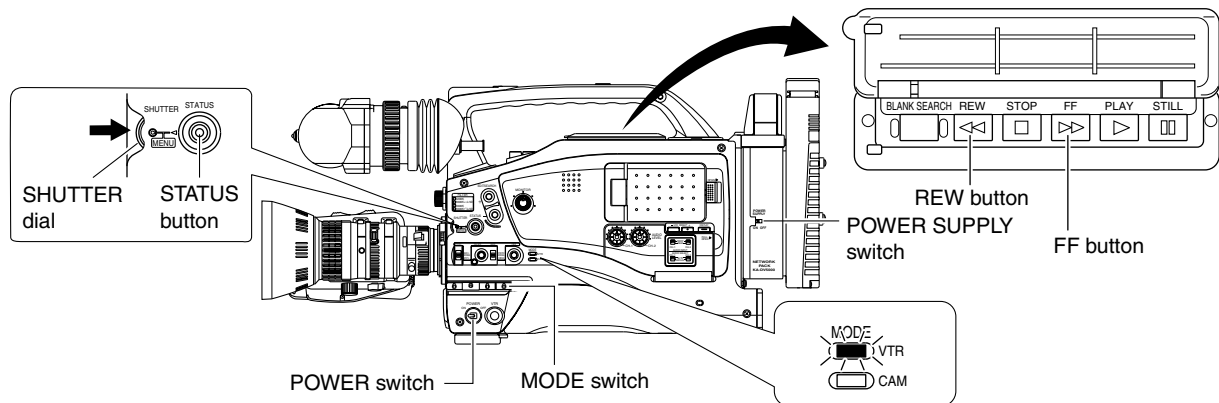

- MOVIE CLIP will not appear during card initialization (flashing display).

1. Insert an already recorded CF memory card.
2. Turn on the GY-DV5000 and KA-DV5000 power. Check to see that the display appears on the LCD screen/viewfinder screen. (When the power is turned on, display will flash during initialization.)
3. Set the MODE switch to "VTR". (Light the VTR indicator.)
4. Make sure GY-DV5000 is not in operation.
5. Display the MOVIE CLIP screen.
 - ① Press the STATUS button for about 1 seconds to display the TOP MENU screen.
 - ② Turn the SHUTTER dial, move the cursor (▶) to MOVIE CLIP and press the SHUTTER dial.

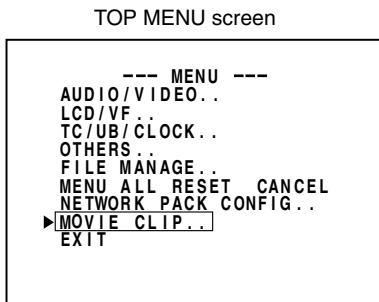

- The movie clip list of the latest clip page recorded on the CF memory card and the still image (starting point) of the latest clip number appear by overlapping.

MOVIE CLIP screen

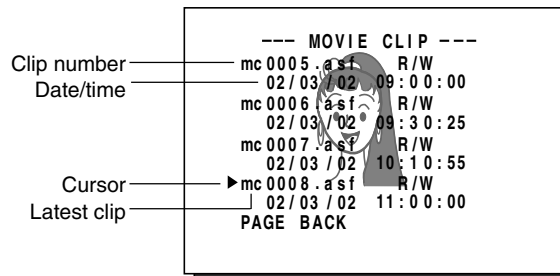

The clip page in the MOVIE CLIP screen displays 4 lists per page.

Memo

When a MOVIE CLIP menu item is selected and the SHUTTER dial is pressed with no clips recorded on the CF memory card, "NO CLIP!" will flash for about 3 seconds.

If there is no CF memory card inserted, "NO CF CARD!" will flash for about 3 seconds.

6. Select the clip to play back.
 - ① Turn the SHUTTER dial and move the cursor (▶) to the clip to play back.
 - Turning the SHUTTER dial up scrolls to the page with smaller (older) clip numbers.
 - Turning the SHUTTER dial down scrolls to the page with larger (newer) clip numbers.
 - Press the [FF] button to scroll to the next page. Press the [REW] button to scroll to the previous page.
 - Press and hold the [FF] button for about 2 seconds to scroll to the page with the newest clip.
 - Press and hold the [REW] button for about 2 seconds to scroll to the page with the oldest clip.
 - ② Press the SHUTTER dial.
 - CLIP FUNCTION screen of the selected clip appears.
 - Still image (starting point) of the selected clip appears.

Note

- ASF files recorded using another device may not play back properly on this unit.
- If recording into the CF card is carried out within 5 seconds, either a file cannot be made or it becomes difficult to display a thumbnail (a still picture displayed when CLIP FILE is selected).

CLIP FUNCTION screen

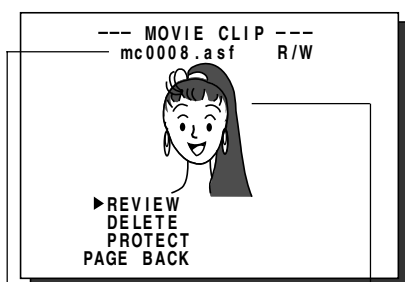

Selected clip number Still image (starting point) of the selected clip

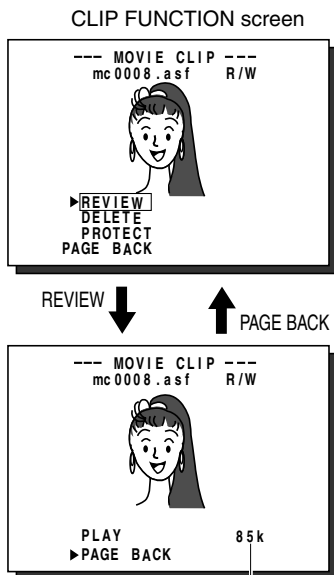

The BIT RATE used for recording is displayed.

Memo

- The video encoded by the KA-DV5000 is so designed that it is displayed in a correct aspect ratio by personal computer monitor. When the CF played-back video is viewed by video-out connector output of the GY-DV5000 or observed on a liquid crystal monitor screen, the aspect ratio may look different. This is because a simple output is made on the video for a personal computer and is therefore normal and not a malfunction.
- When PLAY MODE in the MOVIE CLIP SETUP screen is set to "REPEAT", repeat playback is performed. (page 7)

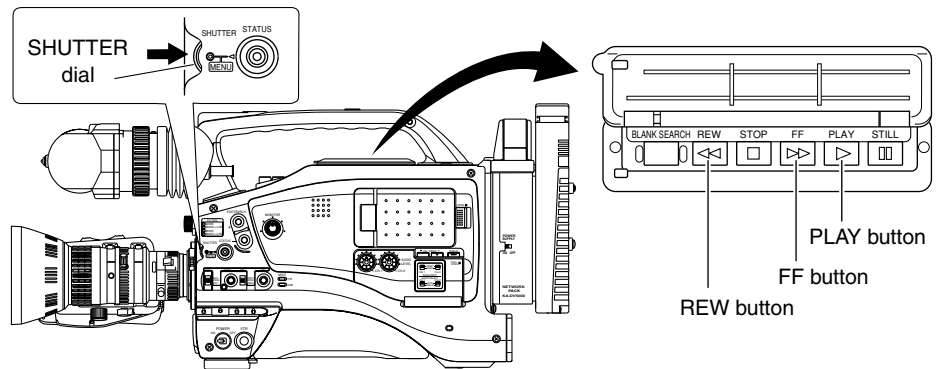

7. Play back the clip.

Turn the SHUTTER dial, move the cursor to REVIEW and press the SHUTTER dial.

- The movie clip is played back after the clip no. flashes. The value of the recorded pixel size (320 × 240 or 160 × 120) appears during displaying the still image. The value of the recorded max. bit rate appears during playback.

8. To pause playback, press the PLAY button.

9. To resume playback, press the PLAY button once more.

10. The following operations are performed when the playback of the selected clip ends. (When PLAY MODE in the MOVIE CLIP SETUP screen is set to "OFF")

- When there are no following clips, the unit pauses at the beginning of the current clip.
- If following clips exist, the clip no. flashes and then playback is performed. When all remaining clips are played back, the unit pauses at the beginning of the played back clip.

■ **Selecting PAGE BACK during playback or pausing and press the SHUTTER dial will return to the MOVIE CLIP screen.**

To move to another clip during playback

- Playback will remain on the current clip even when the FF button is pressed if the latest clip is being played back.

■ To move to the next clip during middle of playback or pausing, press the FF button of GY-DV5000.

- The playback of the current clip stops and the unit pauses at the starting point of the next clip. Pressing the FF button again pauses at the starting point of the following next clip.

- Pressing the REW button during play back of the oldest clip will start playback at the starting point of the that clip.

■ To move to the previous clip during middle of playback or pausing, press the REW button of GY-DV5000.

- The playback of the current clip stops and the unit pauses at the starting point of the previous clip. Pressing the REW button again pauses at the starting point of the clip before the previous clip.

■ To move to the latest clip during middle of playback or pausing, press the FF button of GY-DV5000 for more than 2 seconds.

- The unit pauses at the starting point of the latest clip. To start playback, press the PLAY button.

■ To move to the oldest clip during middle of playback or pausing, press the REW button of GY-DV5000 for more than 2 seconds.

- The unit pauses at the starting point of the oldest clip. To start playback, press the PLAY button.

Clips recorded on a CF memory card can be protected using the MOVIE CLIP screen.

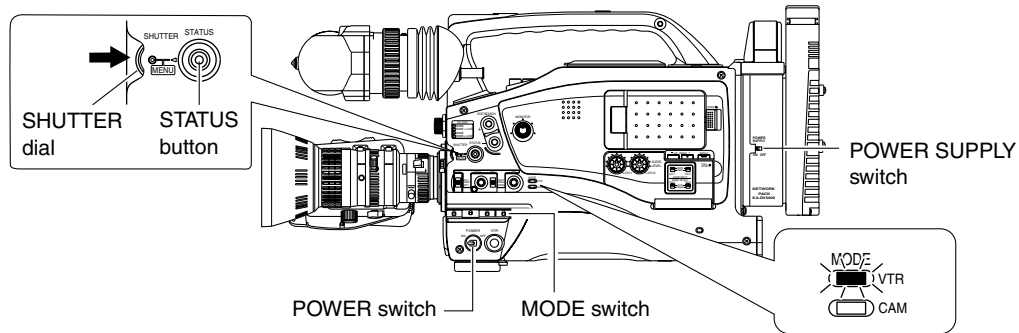

- When executing FORMAT in the MOVIE CLIP SETUP menu screen, protected clips will also be deleted.
- Protected clips will not be deleted even when executing DELETE ALL in the MOVIE CLIP SETUP menu screen.

1. Insert an already recorded CF memory card.
2. Turn on the GY-DV5000 and KA-DV5000 power.
Check to see that the **CF** display appears on the LCD screen/viewfinder screen. (When the power is turned on, display will flash during initialization.)
3. Set the MODE switch to "VTR". (Light the VTR indicator.)
4. Make sure GY-DV5000 is not in operation.
5. Display the MOVIE CLIP screen.
 - ① Press the STATUS button for about 1 seconds to display the TOP MENU screen.
 - ② Turn the SHUTTER dial, move the cursor (▶) to MOVIE CLIP and press the SHUTTER dial.
 - The latest page of the MOVIE CLIP screen appears.
 - R/W display appears on the right of the clip number.
6. Select the clip to protect.
Turn the SHUTTER dial, move the cursor (▶) to the clip to protect and press the SHUTTER dial.
 - The CLIP FUNCTION screen of the selected clip appears.
7. Turn the SHUTTER dial, move the cursor to PROTECT in the CLIP FUNCTION screen and press the SHUTTER dial.

TOP MENU screen

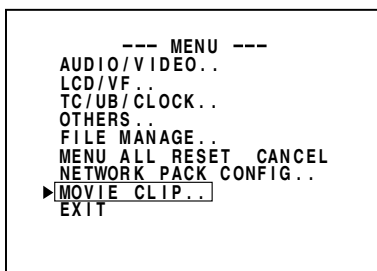

MOVIE CLIP screen

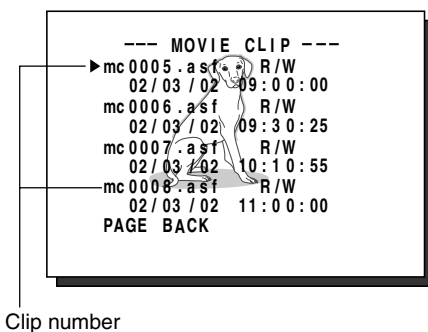

CLIP FUNCTION screen

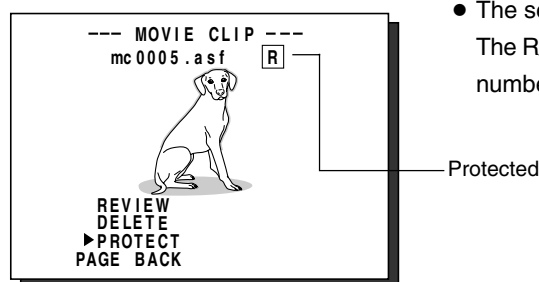

- The selected clip is protected.
- The R/W display on the right of the clip number will change to an R display.

CLIP FUNCTION screen

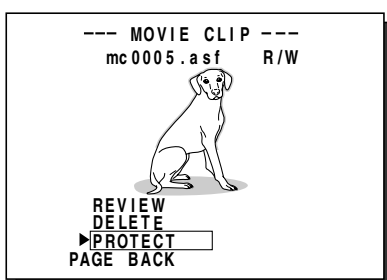

8. To return to the MOVIE CLIP screen after completing setting, select PAGE BACK and press the SHUTTER dial.

■ To cancel the protection, select PROTECT in the CLIP FUNCTION screen and press the SHUTTER dial.

- The R display will change to an R/W display and the protection on the clip will be canceled.

Clips recorded on a CF memory card can be deleted using the MOVIE CLIP screen.

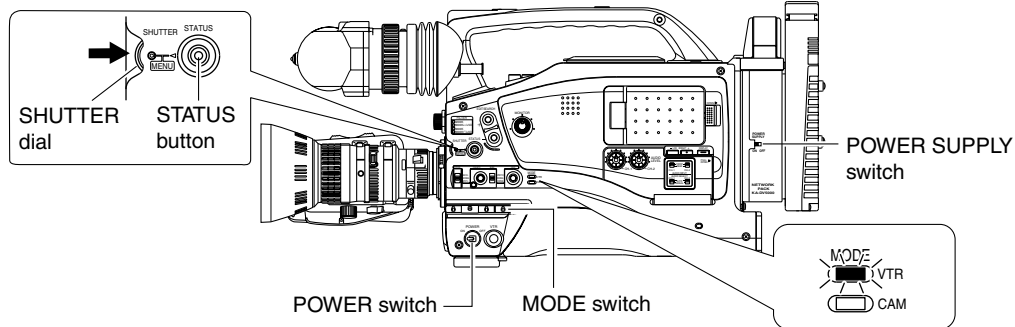

TOP MENU screen

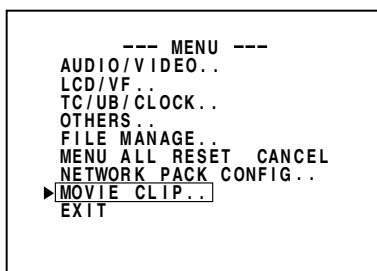

MOVIE CLIP screen

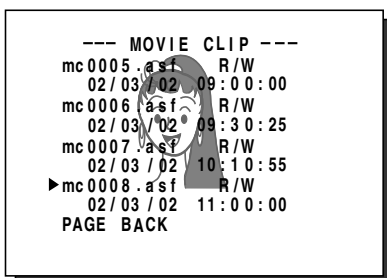

CLIP FUNCTION screen

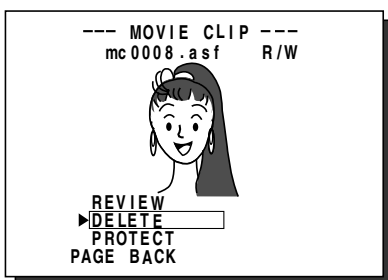

Confirmation screen

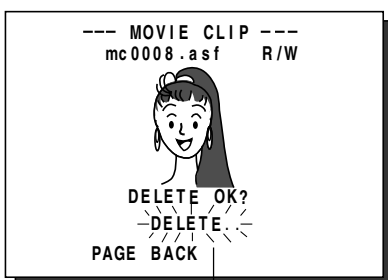

Deleting Flashing display

1. Insert an already recorded CF memory card.
2. Turn on the GY-DV5000 and KA-DV5000 power.
Check to see that the **CF** display appears on the LCD screen/viewfinder screen.
(When the power is turned on, display will flash during initialization.)
3. Set the MODE switch to "VTR". (Light the VTR indicator.)
4. Make sure GY-DV5000 is not in operation.
5. Display the MOVIE CLIP screen.
 - ① Press the STATUS button for about 1 seconds to display the TOP MENU screen.
 - ② Turn the SHUTTER dial, move the cursor (▶) to MOVIE CLIP and press the SHUTTER dial.
 - The latest page of the MOVIE CLIP screen appears.
6. Select the clip to delete.
Turn the SHUTTER dial, move the cursor (▶) to the clip to delete and press the SHUTTER dial.
 - The CLIP FUNCTION screen of the selected clip appears.
7. Turn the SHUTTER dial, move the cursor to DELETE in the CLIP FUNCTION screen and press the SHUTTER dial.
 - A "DELETE OK?" confirmation message appears. (Confirmation screen)
8. To delete, select YES using the SHUTTER dial and press the SHUTTER dial.
 - "DELETE ." flashes on the screen for about 5 seconds and then the MOVIE CLIP screen returns. The clip is deleted from the MOVIE CLIP screen.

Memo

- Protected clips cannot be deleted even when selecting DELETE.
In this case, "PROTECT!" will flash for about 2 seconds and then CLIP FUNCTION screen returns.
- After deleting a clip and there are no remaining clips left on the CF memory card, "NO CLIP!" flashes on the screen for about 3 seconds and then the TOP MENU screen returns.
- To delete all clips, use the MOVIE CLIP SET in the NETWORK PACK CONFIG menu screen. (☞ page 22)

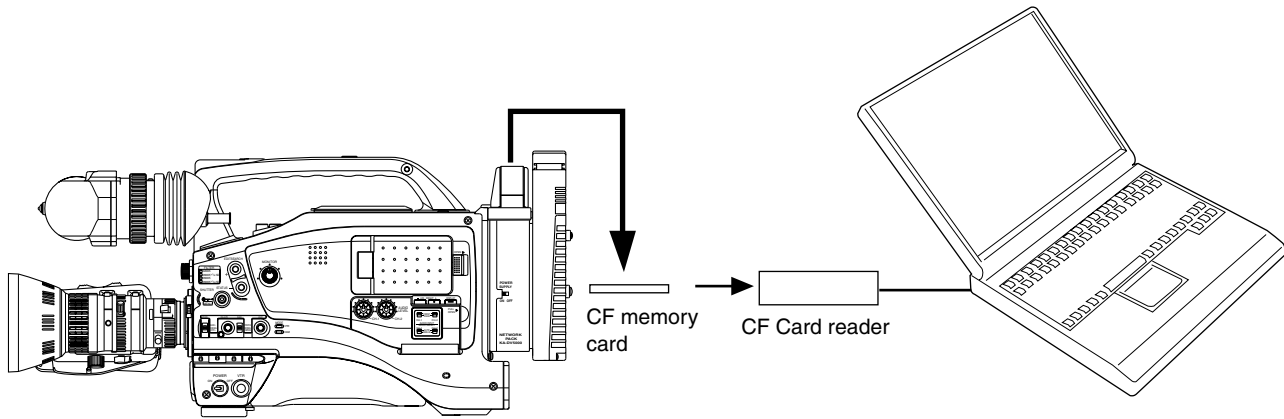

Clips recorded on a CF memory card can be played back on your PC.

* If the PC is equipped with PCMCIA slot(s), CF card reader is not required.

Caution

- Clips recorded on CF memory cards are stored in ASF file format.
 - To play back a clip on your PC, Windows Media Player 7.01 is required. (WM9 is not supported.)
 - * Windows Media Player is compatible with Windows XP or Windows 2000/98(SE)/Me operating system.
 - * Media Player can be downloaded from the Microsoft Website.
- During this time, download the following codec software as well.
The codec software is automatically downloaded when opening the clip file and running Windows Media Player.
- Video codec (decoder) ISO MPEG4
 - Audio codec (decoder) G.726

Operation

- 1.** Load data already recorded on a CF memory card to your PC using a CF card reader, etc.
- 2.** Launch Explorer, etc., and open the recorded clip file in ASF format.
 - Windows Media Player launches and the clip is played back.

Memo

Video and audio files (clip files) in CF memory cards can be appended to email as attachment files.

LAN card Sending video using LAN card while recording on a DV cassette tape

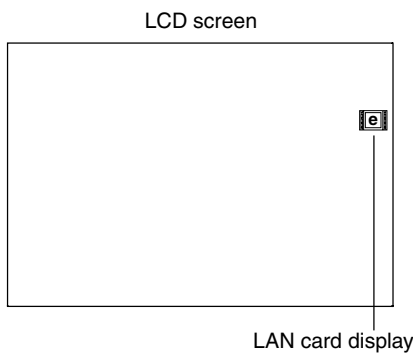
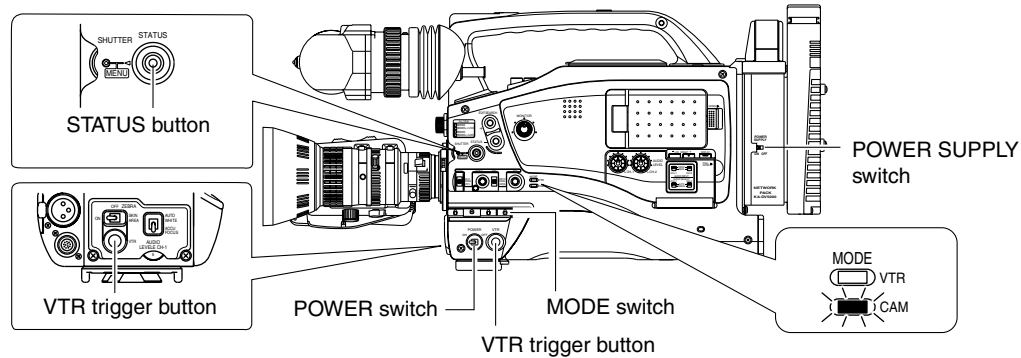

No LAN card is inserted when the  display appears. Turn off the power and insert a LAN card. Then, turn the power back on.

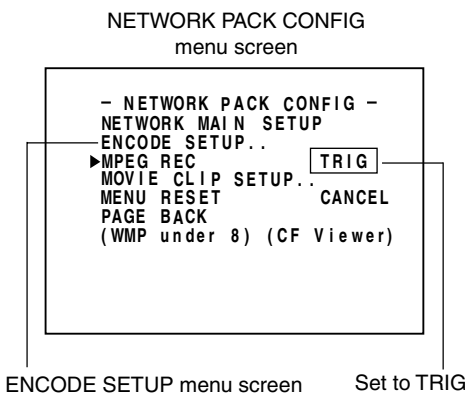

1. Insert a LAN card into the Network Pack.
2. Turn on the GY-DV5000 and KA-DV5000 power.
Check to see that the LAN card display is showing on the LCD screen/viewfinder screen.
3. Set the MODE switch to "CAM". (Light the CAM indicator.)
4. Insert a recordable DV cassette tape.
 - GY-DV5000 will be in the standby mode.
5. Set the NETWORK PACK CONFIG menu screen.
 - ① Set MPEG REC to "TRIG".
 - ② Set the video/audio compress in the ENCODE SETUP menu screen. (page 6)
 - When playing back video/audio streaming data using Quick Time, set STREAM TYPE in the ENCODE SETUP menu to "for QT".
 - ③ When completed, press the STATUS button to return to the normal screen.
6. When pressing the VTR trigger button of GY-DV5000 while Streamproducer is in operation*, transmission of video/audio streaming data from the LAN card is started simultaneously with recording to DV cassette tape.
 - The LAN card display on the LCD screen/viewfinder screen will be as follows:
 -  : Red display during data transmission.
 - * Perform setting described in "5-2 Operating video from DV camcorder • Trigger mode function" of network distribution software "Streamproducer" User's Guide.
7. To stop transmission or recording, press the VTR trigger button.
 - GY-DV5000 will be in the standby mode.
8. To resume transmission or recording, press the VTR trigger button once more.
9. To end, press the VTR trigger button to stop transmission and recording and turn off the power.
Lastly, remove the LAN card.

Memo

- Streaming data will be sent from the LAN card even when a DV cassette tape is not inserted.
- When the DV cassette tape reaches the end during recording, the transmission of streaming data from the LAN card is also stopped.

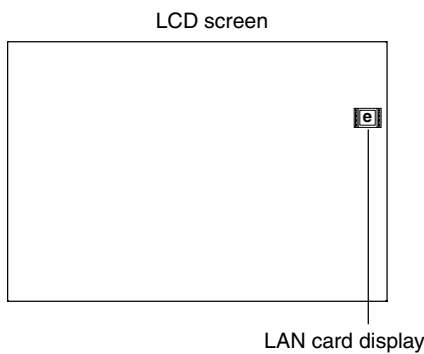
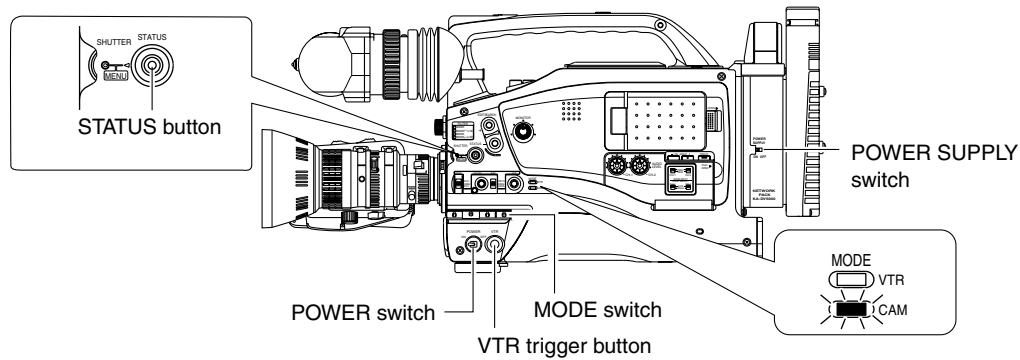

No LAN card is inserted when the  display appears. Turn off the power and insert a LAN card. Then, turn the power back on.

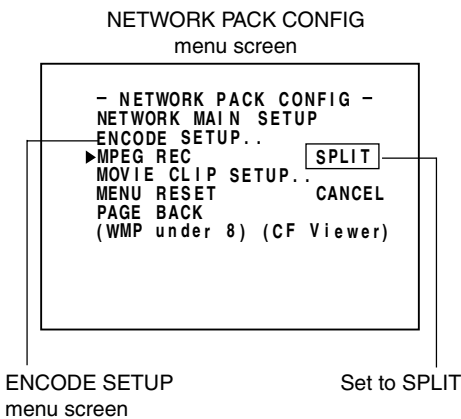

- 1.** Insert a LAN card into the Network Pack.
- 2.** Turn on the GY-DV5000 and KA-DV5000 power.
Check to see that the LAN card display is showing on the LCD screen/viewfinder screen.
- 3.** Set the MODE switch to "CAM". (Light the CAM indicator.)
- 4.** Set the NETWORK PACK CONFIG menu screen.
 - ① Set MPEG REC to "SPLIT".
 - ② Set the video/audio compress in the ENCODE SETUP menu screen. (page 6)
 - When playing back video/audio streaming data using Quick Time, set STREAM TYPE in the ENCODE SETUP menu to "for QT".
 - ③ When completed, press the STATUS button to return to the normal screen.
- 5.** When operating Streamproducer and making network connection with KA-DV5000, sending of streaming video/audio data will start from the LAN card.
When pressing the VTR trigger button on the side of GY-DV5000, recording to the HDD will start.
 - The LAN card display on the LCD screen/viewfinder screen will be as follows:
 -  : Red display during data transmission.
 - * Perform setting described in "5-2 Operating video from DV camcorder • Trigger mode function" of network distribution software "Streamproducer" User's Guide.
- 6.** To stop recording to the HDD, press the VTR trigger button on the side.
- 7.** Press the VTR trigger button on the side to resume recording to the HDD.
- 8.** To end operation, stop the transmission by disconnecting the network connection with KA-DV5000 using Streamproducer, then turn off the power.
Lastly, remove the LAN card.

Memo

- When MPEG REC is set to "SPLIT", sending is performed only when the VTR trigger button on the side is pressed. The VTR trigger buttons on the front and on the lens are disabled.
- Pressing the VTR trigger button on the side does not record the camera image onto the inserted DV cassette tape.

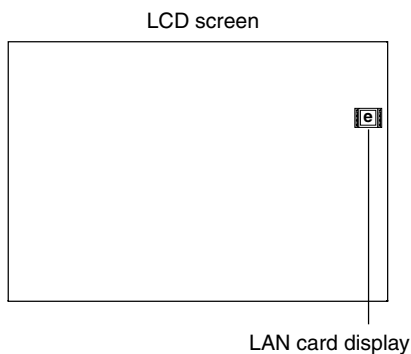
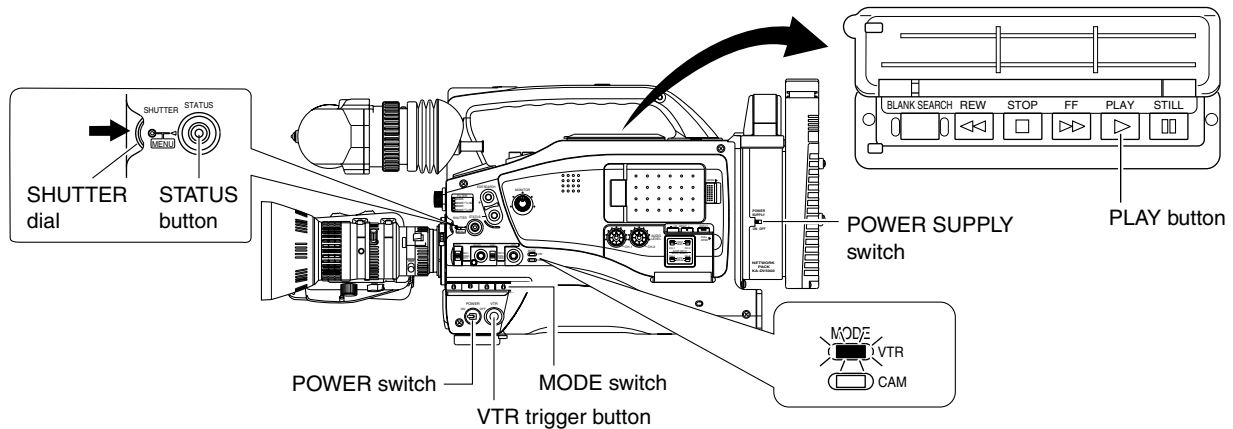

No LAN card is inserted when the  display appears on. Turn off the power and insert a LAN card. Then, turn the power back on.

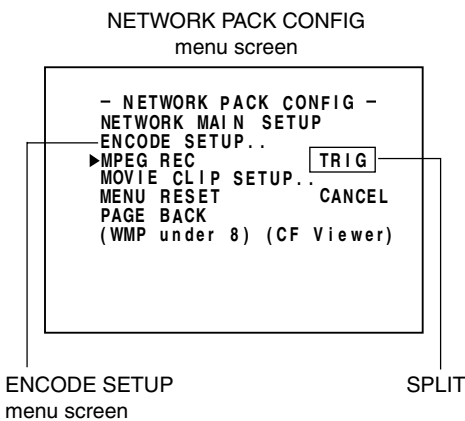

1. Insert a LAN card into the Network Pack.
2. Turn on the GY-DV5000 and KA-DV5000 power. Check to see that the LAN card display is showing on the LCD screen/viewfinder screen.
3. Set the MODE switch to "VTR". (Light the VTR indicator.)
4. Insert the recorded DV cassette tape.
5. Set the NETWORK PACK CONFIG menu screen.
 - ① Set MPEG REC to "SPLIT".
 - ② Set the video/audio compression in the ENCODE SETUP menu screen. (page 6)
 - When playing back video/audio streaming data using Quick Time, set STREAM TYPE in the ENCODE SETUP menu to "for QT".
 - ③ When completed with settings, press the STATUS button to return to the normal screen.
6. When operating Streamproducer and making network connection with KA-DV5000, sending of streaming video/audio data will start from the LAN card.
 - The LAN card display on the LCD screen/viewfinder screen will be as follows:
 -  : Red display during data transmission.
 - * Perform setting described in "5-2 Operating video from DV camcorder • Trigger mode function" of network distribution software "Streamproducer" User's Guide.
7. Press the PLAY button of GY-DV5000 to start DV cassette tape playback.
8. Press the VTR trigger button on the side at the scene to start HDD recording with Streamproducer.
9. To stop recording to the HDD, press the VTR trigger button on the side.
10. Press the VTR trigger button on the side to resume recording to the HDD.
11. To end operation, first disconnect the network connection and then turn off the power. Lastly, remove the LAN card.

Network pack setup

Controlling GY-DV5000/KA-DV5000 via LAN card

With the Network Pack, GY-DV5000/KA-DV5000 can be controlled via LAN.

It is also possible to playback video and audio from KA-DV5000 on your PC in the STREAMCAPTURE screen in realtime (live display) as well as save data to files. However, note that video and audio from KA-DV5000 can be played back only on one PC at a time.

Peer-to-peer connection that directly connects the unit with a PC is explained here.

- There are the 3 types of users for Web access:
- Users referred as "jvc" (can be changed) that can perform all operations, "ENCODE" users that can view all data but only change the encoding settings, and "BROWSE" users that can only view data.
- The default password for each user type is "ka-dv5k" for "jvc" users, first 4 characters of the password set for "jvc" users for "ENCODE" users (default is "ka-d") and fixed password of "ka-dv" for "BROWSER" users.
- The following is an explanation when login is made a user permitted with all operations. In the case of other users, the OK button and Cancel button will be disabled even if operations on the screen are allowed.

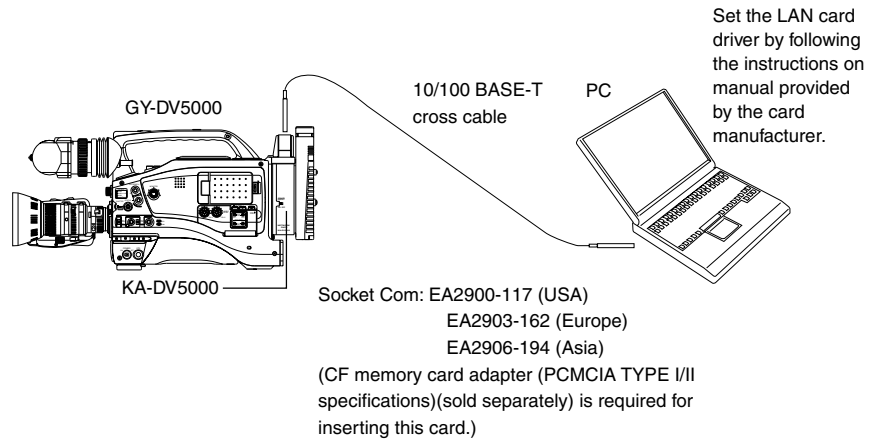

1. Turn your PC and GY-DV5000 and KA-DV5000 power off.
2. Insert the PCMCIA LAN card to specify into KA-DV5000.
3. Connect the unit and PC using a 10/100 BASE-T cross cable.
4. Turn the PC and GY-DV5000 and KA-DV5000 power on.
5. Insert a recordable DV cassette tape.
6. PC settings
 - Set the LAN card driver according to the manual provided by the card manufacturer.
 - Network settings (☞ page 14)
 - ① Set the following items in the TCP IP properties:
 - * DHCP server is not used.
 - IP address: 192.168.100.101
 - Subnet mask: 255.255.255.000
 - ② Setting the proxy server.
 - Set the proxy server using the "LAN SETTINGS" of Windows.
 - When using peer-to-peer communication that directly connects the PC and KA-DV5000, deselect the "Use a proxy server" checkbox.
 - When the "Use a proxy server" setting must be enabled due to a LAN environment (in-company LAN, etc.), click "Advanced..." and input the IP address of GY-DV5000 in "Exceptions" of the "Use a proxy server" setting.
(☞ "About proxy servers," Page 49)
7. Launch the browser on your PC and enter 192.168.100.101 (default factory setting) in the address bar and press ENTER.
 - A confirmation window for user ID and password appears.

8. Input the user ID and password.
 - ① For the user ID, input "jvc" (factory setting).
For the password, input "ka-dv5k" (factory setting) or the name set in the SERVER SETUP menu screen.
(☞ page 12)
 - ② Check to make sure the inputted user ID and password are correct and click the OK icon.
(Check "Save password" so that the password does not need to be inputted for future accesses.)
9. If the user ID and password are correct, the NETWORK PACK SETUP screen appears on the PC monitor.
 - GY-DV5000/KA-DV5000 settings and operations can be controlled using the NETWORK PACK SETUP. (☞ page 32)

Caution

- When setting the NETWORK PACK SETUP screen (CAM & VTR CONTROL, NETWORK SETUP, PORT SETUP or ENCODE PARAMETERS) and the same menu screen is displayed on the LCD screen or viewfinder of GY-DV5000, values set in the NETWORK PACK SETUP screen will not appear on menu screen of the LCD screen or the viewfinder of GY-DV5000.
The values set in the NETWORK PACK SETUP screen will appear after the menu screen of GY-DV5000 is closed once and reopened.
- During camera/VTR control, noise may be heard from the speakers. However, this is not a malfunction. If the noise becomes irritating, open the "Sound & Multimedia" property from the Windows Control Panel and set the sound of "Windows Explorer Start Navigation" of "Sound Events" to off.
* For setting details, see Windows' Help.
- Check to make sure that NET REMOTE in the OTHERS [1/2] menu screen of GY-DV5000 is set to "ON". Camera control will not be available when NET REMOTE is set to "OFF".
- Depending on the cache setting of your browser, the parameters updated in the Camera menu may not be effective immediately.

Network pack setup

NETWORK SETUP screen

Clicking NETWORK SETUP on the left of the Streamcorder screen displays the NETWORK SETUP screen for performing network related settings.

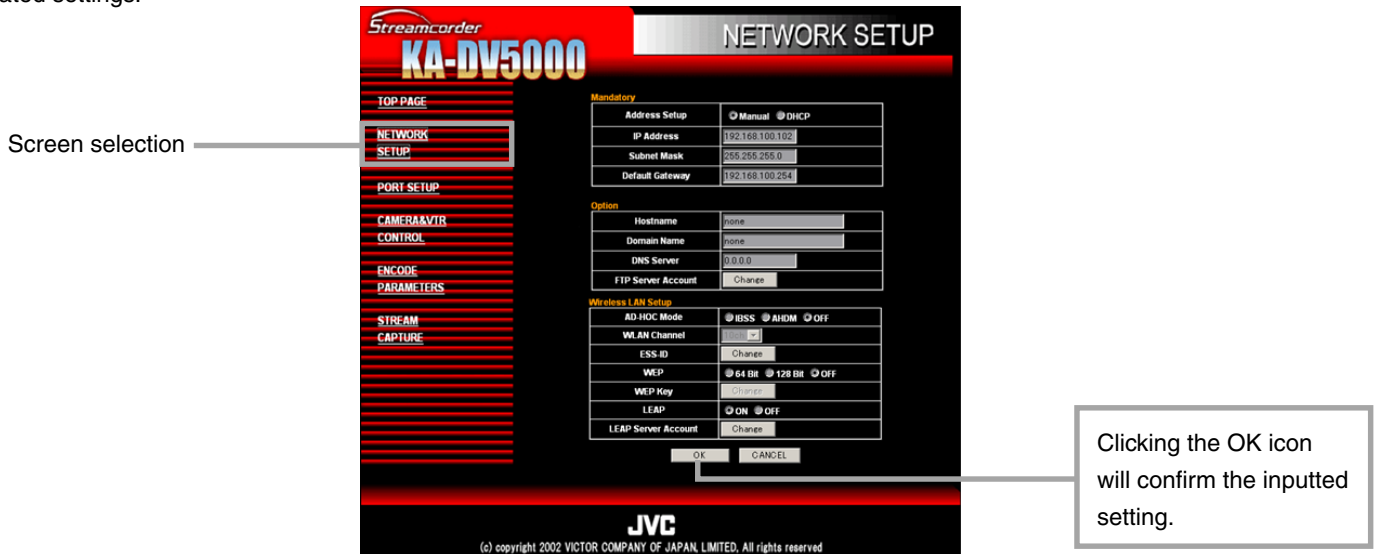

Contact your network administrator for any unclear points concerning network settings.

Item	Setting	Description	Factory setting
Address Setup	MANUAL DHCP	The address setting mode can be selected. MANUAL : Select for MANUAL mode. DHCP : Select for DHCP mode.	MANUAL
IP Address		The IP address can be set.	192.168.100.101
Subnet Mask		The subnet mask can be set.	255.255.255.000
Default Gateway		The gateway address can be set.	192.168.100.254
Host Name		The host name can be set. (Max: 63 alphanumerical characters)	none
Domain Name		The domain name can be entered. (Max: 63 alphanumerical characters)	none
DNS Server		The address of the domain name system server can be set.	0.0.0.0
FTP Server Account		When selecting Change, settings can be made in the FTP Server Account Setup screen. (page 33)	
AD-HOC MODE	IBSS AHDM OFF	The AD-HOC mode can be set.	OFF
WLAN Channel	1 CH : 10 CH : 14 CH	WLAN Channel can be set.	10 CH
ESS-ID		When selecting Change, settings can be made in the ESS-ID Setup screen. (Max: 32 alphanumerical characters) (page 33)	
WEP	64 Bit 128 Bit OFF	WEP is set.	OFF
WEP Key		When selecting Change, settings can be made in the WEP Key Setup screen. (page 33)	
LEAP	ON OFF	When set to ON, LEAP Server Account can be set.	OFF
LEAP Server Account		When Change is selected, settings can be made in the LEAP Server Account Setup screen. (page 33)	

Caution

If the IP address is changed in the Streamcorder screen, the unit will automatically jump to the new IP address. However, the screen may not be displayed correctly depending on the environment. In this case, access by specifying the new IP address using a browser. (operation 7. on pages 31)

FTP Server Account Setup screen

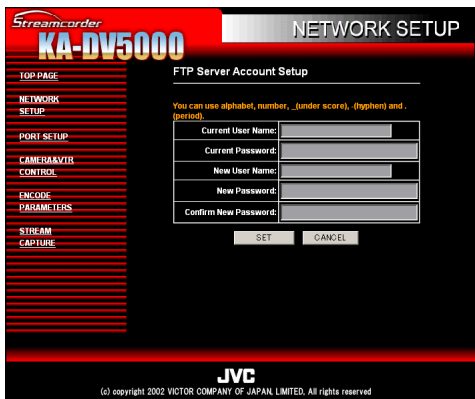

Item	Description	Factory setting
User Name	Input the FTP user name.	ftp-user
Old password	Input the currently used password.	ka-dv
New Password	Input the new password.	
Confirm New	For confirmation, input the new password again.	

ESS-ID Setup screen

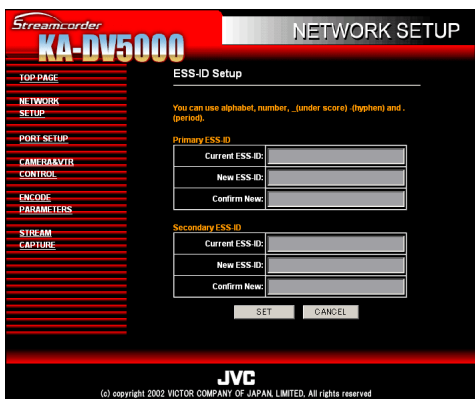

Primary ESS-ID

Item	Description	Factory setting
Current ESS-ID	Input the currently used ESS-ID.	NONE
New ESS-ID	Input the new ESS-ID.	
Confirm New	For confirmation, input the new ESS-ID again.	

Secondary ESS-ID

Item	Description	Factory setting
Current ESS-ID	Input the currently used ESS-ID.	NONE
New ESS-ID	Input the new ESS-ID.	
Confirm New	For confirmation, input the new ESS-ID again.	

WEP Key Setup screen

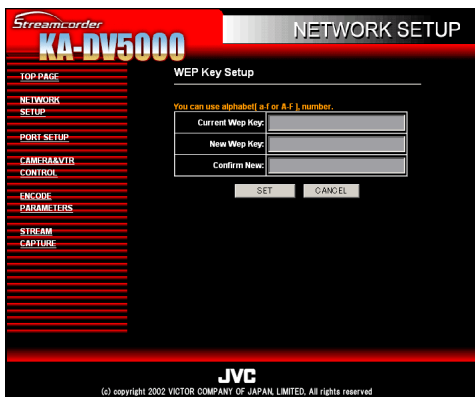

Item	Description	Factory setting
Current Wep Key	Input the currently used Wep Key.	
New Wep Key	Input the new Wep Key.	
Confirm New	For confirmation, input the new Wep Key again.	

LEAP Server Account Setup screen

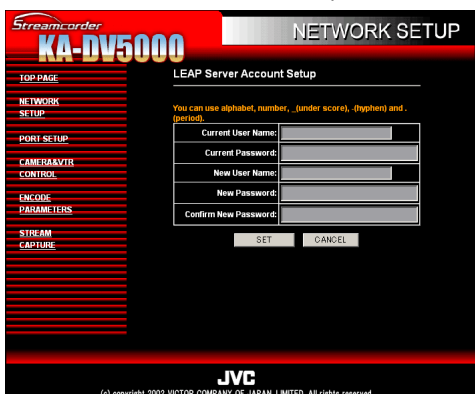

Item	Description	Factory setting
User Name	Input the LEAP user name.	leap-user
Old Password	Input the currently used password.	ka-dv-jvc
New Password	Input the new password.	
Confirm New	For confirmation, input the new password again.	

Clicking PORT SETUP on the left of the Streamcorder screen displays the PORT SETUP screen for performing port settings.

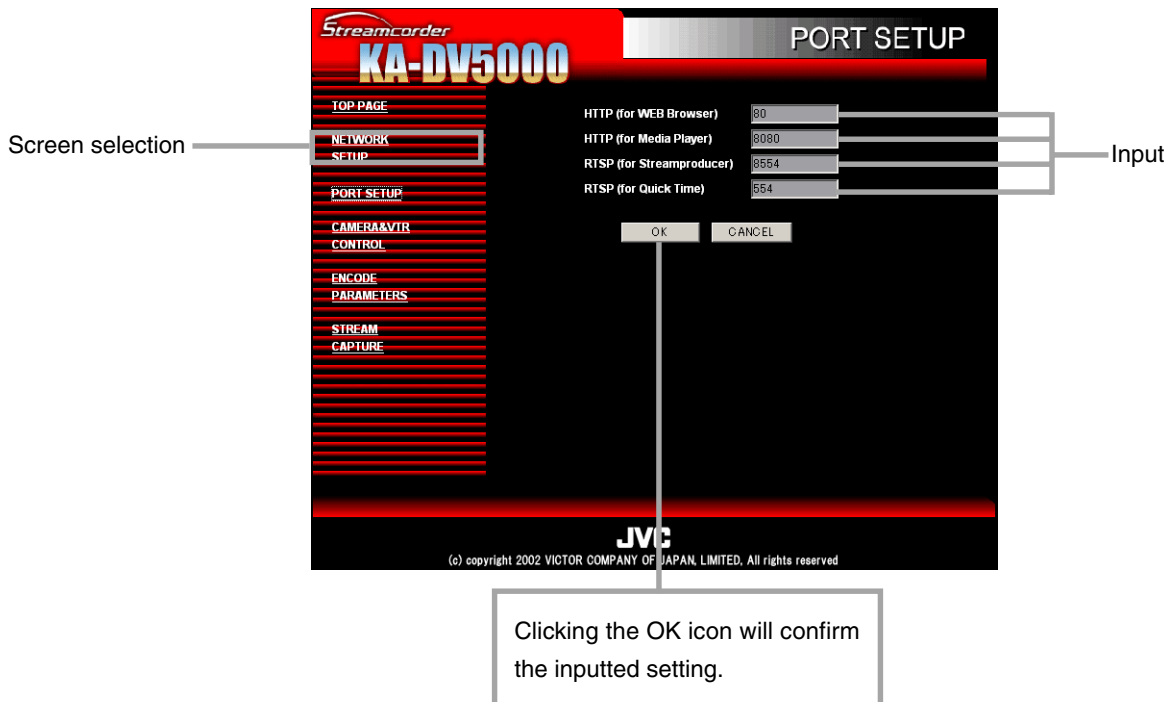

Item	Description	Factory setting
HTTP (for WEB Browser)	The HTTP port for WEB browser can be set. (1 to 32767)	80
HTTP (for Media Player)	The HTTP port for Media player can be set. (1 to 32767)	8080
RTSP (for Streamproducer)	The Streamproducer RTSP port number can be set. (1 ~ 32767)	8554
RTSP (for Quick Time)	Quick Time RTSP port number can be set. (1 ~ 32767)	554

* Changing ports require special knowledge. Always consult the administrator of the connecting network when making changes.

* Do not use the same port numbers for RTSP and HTTP.

Caution

If the port is changed in the Streamcorder screen, the unit will automatically jump to the new port. However, the screen may not be displayed correctly depending on the environment. In this case, access by specifying the new port using a browser. (See operation **7.** on pages 31)

When the correct user ID and password are accepted, the following Streamcorder screen appears.

In the CAM & VTR CONTROL screen, camera adjustments of GY-DV5000 and VTR controls can be made.

The screenshot shows the 'CAM&VTR CONTROL' screen for the Streamcorder KA-DV5000. On the left is a menu with options: TOP PAGE, NETWORK SETUP, PORT SETUP, CAMERA&VTR CONTROL (highlighted), ENCODE PARAMETERS, and STREAM CAPTURE. The main area contains VTR CONTROL buttons (CAM, REC, REW, STOP, FF, PLAY, PAUSE) and a settings menu with options: AUTO (ON/OFF), BARS (ON/OFF), WHITE_BAL (Memory A), IRIS (AUTO/MANUAL), LOLUX (ON/OFF), GAIN (ALC/STEP/0dB), and SHUTTER (STEP/OFF/V-SCAN). At the bottom are OK and CANCEL buttons. Four callout boxes provide instructions: 'Screen selection' points to the menu, 'Setting' points to the pull-down menu, 'Adjustment mode selection' points to the radio buttons, and 'Clicking the OK icon will confirm the inputted setting' points to the OK button.

■ Camera Control

Setting range

- When setting AUTO to ON, items other than LOLUX will not be available.
- When setting BARS to ON, items other than AUTO and LOLUX will not be available.
- When setting GAIN to ALC, IRIS and SHUTTER will not be available.

Item	Adjustment mode	Setting/description
AUTO		ON: Auto mode on. Items other than LOLUX cannot be set. OFF: Auto mode off
BARS		ON: Color bar signals are outputted. Items other than AUTO and LOLUX cannot be set. OFF: Color bar signals are not outputted.
WHITE BAL		FAW: Full white balance mode PRESET: White balance will be in the preset state. (3200K) MEMORY A, B: White balance setting stored in the GY-DV5000 memory will be used.
IRIS	AUTO	Auto iris mode. Iris will be adjusted within the following range: [-3, -2, -1, 0, +1, +2, +3]
	MANUAL	Manual iris mode. Iris will be adjusted within the following range: [CLOSE, F16, F11, F8, F5.6, F4, F2.8, F2, OPEN]
Lolux	ON OFF	Lolux mode
GAIN	ALC	ALC (Auto Level Control) mode. IRIS and SHUTTER cannot be set
	STEP	Gain can be set within the following range. 0dB is not available. [-3dB ~ 18dB]
	0dB	0dB (Sensitivity is not increased)
SHUTTER	STEP	Shutter speed can be set within the following range: U model: [1/7.5, 1/15, 1/30, 1/100, 1/250, 1/500, 1/1000, 1/2000, 1/4000, 1/10000] E model: [1/6.25, 1/12.5, 1/25, 1/120, 1/250, 1/500, 1/1000, 1/2000, 1/4000/, 1/10000]
	OFF	Shutter speed will be 1/60 (1/50). () for E model
	V-SCAN	Although this setting can be canceled, future settings of this item will not be allowed.

■ VTR Control



VTR control icons
Click each button to perform operation.

■ To control the VTR in the Streamcorder screen, the following menu items of GY-DV5000 must be set in advance.

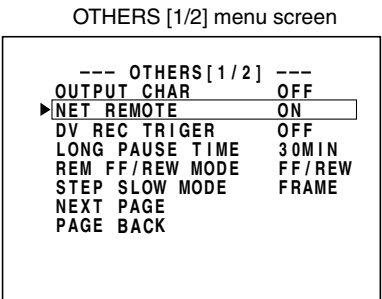

- Set NET REMOTE in the OTHERS [1/2] menu screen to ON. When set to OFF, the VTR cannot be controlled from the Streamcorder screen.

■ VTR control icon operations by MODE switch settings of GY-DV5000 are as follows:

—: Mode will not change

GY-DV5000 state		Clicking VTR control icon					
MODE switch	Previous mode	REC	REW	STOP	FF	PLAY	PAUSE/STILL
VTR	STOP	REC	REW	—	FF	PLAY	—
	FF	—	REW	STOP	—	PLAY	—
	REW	—	—	STOP	FF	PLAY	—
	PLAY	—	REV SEARCH	STOP	FWD SEARCH	—	STILL
	STILL	—	—	STOP	—	PLAY	—
CAM	STOP	REC	REW	—	FF	—	—
	REC	—	—	STOP	—	—	STBY
	STBY	REC	—	STOP	—	—	—

Clicking ENCODE PARAMETERS on the left of the Streamcorder screen displays the ENCODE PARAMETERS screen for performing video/audio compression settings.

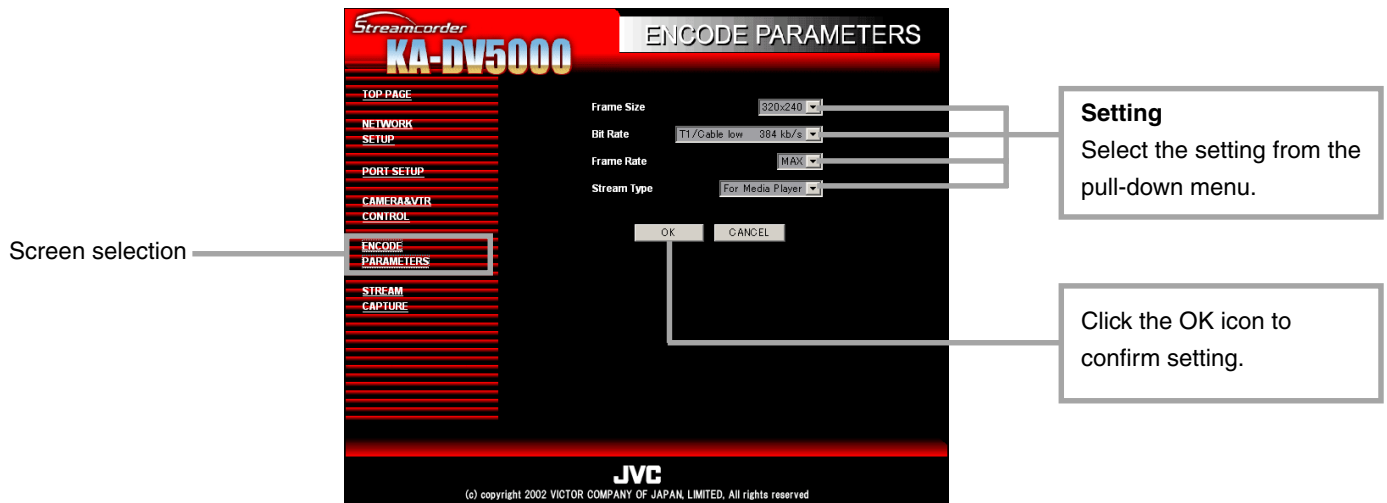

Setting range

● indicates default factory setting.

Item	Setting	Description																																																																	
Frame Size	<ul style="list-style-type: none"> ● 320 × 240 160 × 120 	Sets the video compression size. 320 × 240: Sets the image size to 320 × 240 pixels. (CIF) 160 × 120: Sets the image size to 160 × 120 pixels. (QCIF) (1/4 image size of CIF.)																																																																	
Bit Rate	<ul style="list-style-type: none"> 56K (bps) 128K (bps) 256K (bps) ● 384K (bps) 512K (bps) 	Sets the video streaming speed.																																																																	
Frame Rate	<ul style="list-style-type: none"> MAX ● MID MIN 	Sets the frame rate per second. Settings are as shown below.																																																																	
<table border="1" style="width: 100%; border-collapse: collapse; text-align: center;"> <thead> <tr> <th colspan="2" rowspan="3">BIT RATE (bps)</th> <th colspan="6">FRAME SIZE</th> </tr> <tr> <th colspan="3">320 × 240</th> <th colspan="3">160 × 120</th> </tr> <tr> <th>MAX</th> <th>MID</th> <th>MIN</th> <th>MAX</th> <th>MID</th> <th>MIN</th> </tr> </thead> <tbody> <tr> <td rowspan="2">512K</td> <td>NTSC</td> <td>15</td> <td>10</td> <td>7.5</td> <td>30</td> <td>15</td> <td>10</td> </tr> <tr> <td>PAL</td> <td>12.5</td> <td>5</td> <td>5</td> <td>25</td> <td>12.5</td> <td>12.5</td> </tr> <tr> <td rowspan="2">384K</td> <td>NTSC</td> <td>15</td> <td>10</td> <td>7.5</td> <td>30</td> <td>15</td> <td>10</td> </tr> <tr> <td>PAL</td> <td>12.5</td> <td>5</td> <td>5</td> <td>25</td> <td>12.5</td> <td>5</td> </tr> <tr> <td rowspan="2">256K</td> <td>NTSC</td> <td>15</td> <td>7.5</td> <td>5</td> <td>30</td> <td>15</td> <td>7.5</td> </tr> <tr> <td>PAL</td> <td>12.5</td> <td>5</td> <td>5</td> <td>25</td> <td>12.5</td> <td>5</td> </tr> </tbody> </table>			BIT RATE (bps)		FRAME SIZE						320 × 240			160 × 120			MAX	MID	MIN	MAX	MID	MIN	512K	NTSC	15	10	7.5	30	15	10	PAL	12.5	5	5	25	12.5	12.5	384K	NTSC	15	10	7.5	30	15	10	PAL	12.5	5	5	25	12.5	5	256K	NTSC	15	7.5	5	30	15	7.5	PAL	12.5	5	5	25	12.5	5
BIT RATE (bps)		FRAME SIZE																																																																	
		320 × 240			160 × 120																																																														
		MAX	MID	MIN	MAX	MID	MIN																																																												
512K	NTSC	15	10	7.5	30	15	10																																																												
	PAL	12.5	5	5	25	12.5	12.5																																																												
384K	NTSC	15	10	7.5	30	15	10																																																												
	PAL	12.5	5	5	25	12.5	5																																																												
256K	NTSC	15	7.5	5	30	15	7.5																																																												
	PAL	12.5	5	5	25	12.5	5																																																												
Stream Type	<ul style="list-style-type: none"> ● For Media Player For Quick Time 	Sets the player for stream playback.																																																																	
<div style="border: 1px solid black; padding: 5px;"> <p>Memo</p> <ul style="list-style-type: none"> No sound will be heard when playing back using QuickTime while in the WMP mode. No sound will be heard when playing back using Media Player while in the QT mode. Set to WMP mode when recording to CF memory card. </div>																																																																			

Network pack setup STREAMCAPTURE screen (Playing back video/audio using a PC and saving to file)

Click the characters "STREAMCAPTURE" on the left of the Streamcorder screen to display the Streamcapture screen shown below. Video and audio sent from KA-DV5000 via LAN can be played back on your PC in the Streamcapture screen or data can be saved to files. It can be used on a PC that has Streamproducer installed.

* Since video on the STREAMCAPTURE screen is converted video data, images will take more time to appear than the actual video taken with GY-DV5000.



Video display
The display size can be changed in the Property dialog box. (☞ page 41)

Status/Time elapsed display

- The current status is displayed.
 - VIEWING: Video or audio from KA-DV5000 is being played back in realtime (live display).
 - CAPTURING: Video or audio is being saved in your PC.
 - STOP: Playback is stopped.
 - WAITING: TRIG recording standby.

Clicking the button will display the Property dialog box. Video display size and the save destination folder can be changed. (☞ page 41)

Operation buttons — Clicking will start operation. When on, the button will light.

VIEW	Click to play back or stop video/audio from KA-DV5000 on your PC. (ON when the Streamcapture screen is opened.)
CAPTURE	Click to save video or audio to a PC. Default destination My Document\Streamcorder (IPAddress) Saved file name: The file name based on the capture start time will be used. 0 2 0 3 0 4 - 1 5 3 0 0 0 .asf └─┘ └─┘ └─┘ └─┘ └─┘ └─┘ Year Month Day Hour Minute Second
CAPTURE-TRIG.	Click when saving the video/audio from KA-DV5000 to your PC when starting recording with GY-DV5000. (☞ page 39)
CAST-CAM	Click when sending the video/audio from KA-DV5000 to another PC. (☞ page 39)
CAST-BARS	Click when transmitting color bars rather than video from KA-DV5000. (Video from KA-DV5000 will be displayed in the video display of the Streamcapture screen. Color bars will not be displayed.)
CAST-TRIG.	Click when sending the video/audio from KA-DV5000 to another PC when starting recording with GY-DV5000. (☞ page 39)
MUTE	Click to turn on/off the mute setting. When on, the playback sound will be muted.

→ OVER

About the Trigger Mode function (TRIG)

The Trigger Mode function can be used to save and transmit video/audio from KA-DV5000 to your PC by synchronizing to the button operations of GY-DV5000.

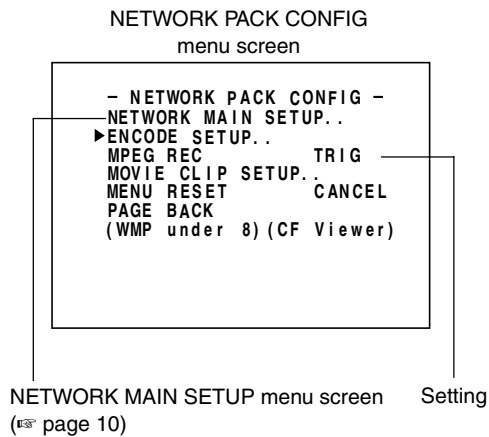

1. Set MPEG REC in the NETWORK PACK CONFIG menu to "TRIG" or "SPLIT" using steps 1 ~ 9 of page 8.
 - TRIG: Records/transmits video/audio streaming data to your PC at the same time as the recording to the DV cassette tape set in GY-DV5000.
 - SPLIT: Records/transmits video/audio streaming data to your PC regardless of whether the DV cassette is set.
2. Click the CAPTURE-TRIG./CAST-TRIG. button in the Streamcapture screen.
 - Button lights and the program enters the trigger standby mode.

Memo

- When the CAPTURE-TRIG. button is on: Saves the video/audio from KA-DV5000 to your PC by synchronizing to the button operations of GY-DV5000.
- When the CAST-TRIG. button is on: Transmits video/audio from KA-DV5000 to another PC by synchronizing to the button operations of GY-DV5000.
- * When saving and transmitting video/audio at the same time, light both CAPTURE-TRIG. and CAST-TRIG. buttons.



CAPTURE-TRIG. button

CAST-TRIG. button

3. Press the VTR trigger button of GY-DV5000.
 - When the MPEG REC item is set to "SPLIT", only the VTR trigger button on the side panel is effective.
 - A red ● [e] mark appears on the GY-DV5000 LCD screen and recording/sending to the PC starts.
4. Press the VTR triggerbutton of GY-DV5000 while the red ● [e] mark is displayed.
 - The [e] mark on the LCD screen of GY-DV5000 turns white and recording/sending to the PC stops.

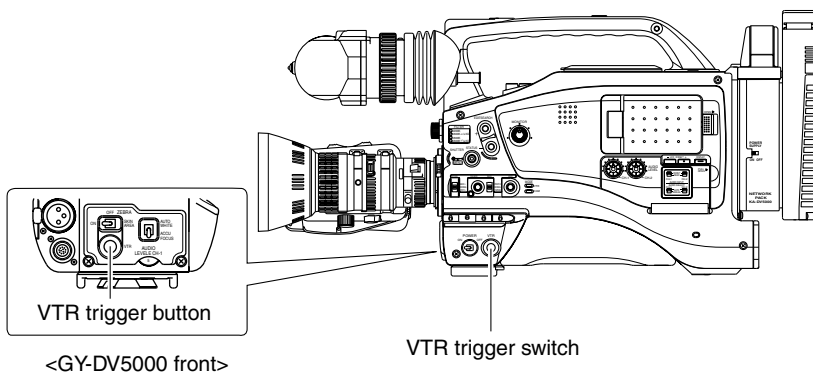

About the Cast function (CAST)

The Cast function can be used to send video/audio from KA-DV5000 to another PC.

<Sending method>

Display the video to send in the video display window of the Streamcapture screen and click the CAST-CAM button.



CAST-CAM button CAST-BARS button CAST-TRIG. button

<Color bar transmission>

When clicking the BARS button, color bars are transmitted rather than the video from KA-DV5000.

- Video of the receiving side will be displayed with color bars. (Video from KA-DV5000 will be displayed in the video display of the Streamcapture screen. Color bars will not be displayed.)
- Click the CAST button to switch back to the transmission of video from KA-DV5000.
- To stop the transmission of video from KA-DV5000 / color bars, turn off the CAST-CAM/CAST-BARS button. In this case, the connection with the receiving side will be disconnected.

<Trigger transmission>

When transmitting video/audio from KA-DV5000 to another PC by synchronizing to the button operations of GY-DV5000, click the CAST-TRIG. Button. (☞ page 39)

<Receiving sent video>

Video sent using the Cast function can be received using Windows Media Player.

1. Launch Windows Media Player and select [Open URL] from the [File] menu.



2. Input the IP address and port number of the PC sending data using Streamcapture.

* The settings can be checked in "Internet URL" of the Cast dialog box.

• Internet connection

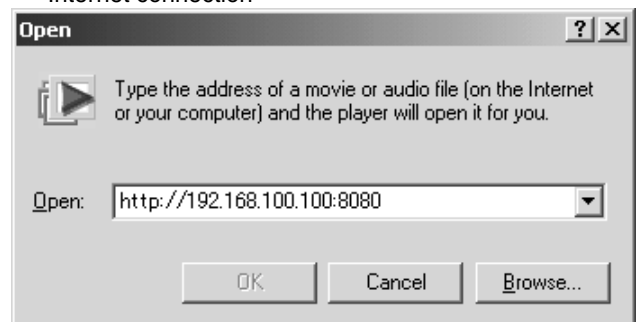

• LAN connection

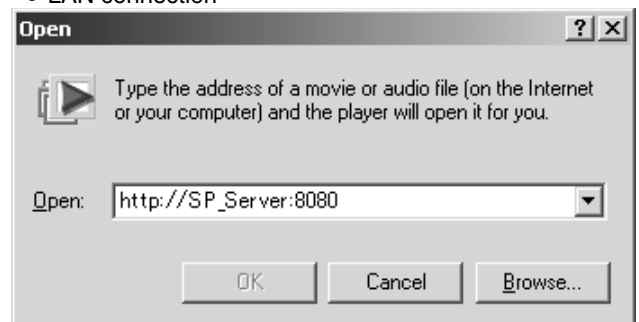

3. Click OK to view the received video.

Caution

When Windows Media Player is receiving a video being sent, sometimes the connection with a server can be cut off. In such a case, press the PLAY button of Windows Media Player again.

Property dialog box

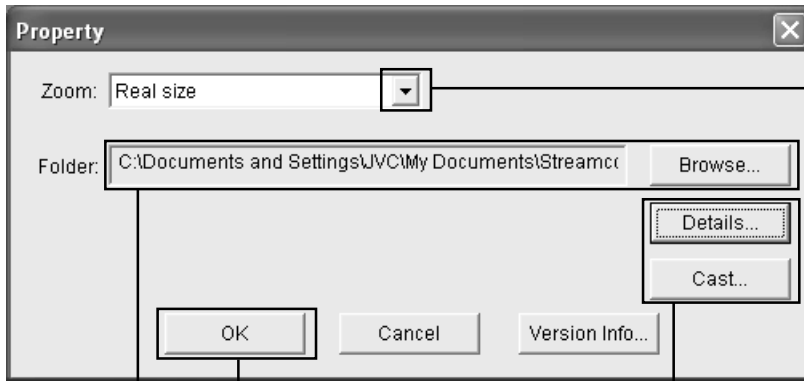

Select the video display size
 Select the display size from the pull-down menu.

Setting range:

- Real size
- Fit to window

Click the OK button to confirm settings.

Save destination folder
 The default save destination is as follows:
 Set this field when changing the save destination folder.
 My Document\Streamcorder (\IPAddress)
 When changing the destination folder, press the Browse... button and select the desired folder. The changed destination folder will be the default folder for future save operations.

Advanced settings dialog box

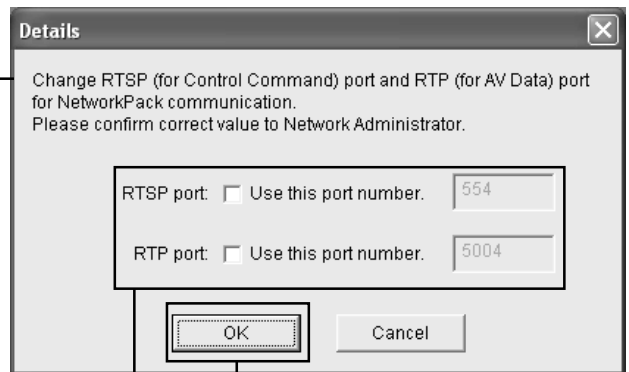

Click the OK button to confirm settings.

Cast dialog box

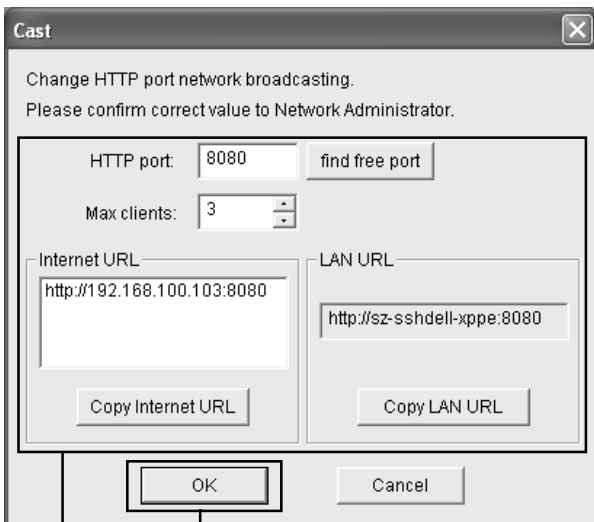

Click the OK button to confirm settings.

HTTP port
 Port number of the network used when sending video/audio is set. Normally, no user setting is required.

Max clients
 Sent video/audio can be received up to the number specified in this dialog box.

Internet/LAN URL
 When receiving video/audio, the URL displayed here is entered in Windows Media Player.

Copy Internet URL
 Copies Internet URL to clipboard

Copy LAN URL
 Copies LAN URL to clipboard

Port numbers of the network used on the PC side during communication with the network pack are set.
 RTSP port: used for handling commands. Use [TCP].
 RTP port: used for receiving video data. Use [UDP].

Normally, available ports are automatically searched and set.
 If there are restrictions to the port numbers due to the LAN environment settings of your PC, consult your network administrator.
 When specifying the port numbers for use, check each checkbox and input the number in the edit box on the right.

TOP PAGE can be customized as desired.

TOP PAGE created on a PC is uploaded by FTP.

- 1.** Set the unit so that NETWORK SETUP can be displayed. (☞ page 31)
- 2.** Create HTML on the PC using a commercially available HTML editor, etc.
Save the created HTML file under the name of "index.html".
- 3.** Use a commercially available FTP program on the PC to upload index.html created in step 2 above to KA-DV5000.
FTP program settings (Execute using the set value.)
IP Address : 192.168.100.101
Remort Port : 21
USER ID : ftp-user
PASSWORD : ka-dv

■ It is also possible to upload link pages from index.html, images, etc.

Caution

- Make sure the uploaded files do not exceed 100KB in total.
- The HTML display will fit properly on the screen when creating at a size of about 500 × 360 pixels.
- Once uploaded, the file is overwritten and cannot be reproduced. Download and backup necessary files in the FTP.

Connect the KA-DV5000 to Windows Media Player using the network.

1. Set STREAM TYPE in the ENCODE SETUP menu to “for WMP”.
2. Open Windows Media Player.



3. Select [File] → [Open URL].
The following dialog box will appear.

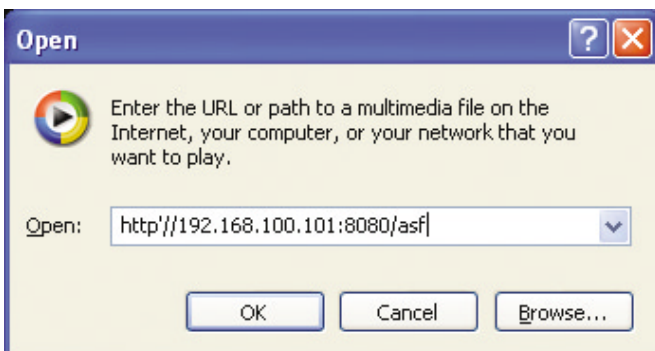

4. Set the IP address of the camera.
http://*.*.*.*.###/asf
* → IP address of camera
→ HTTP Port number set in “for Media player”
5. When completed with setting, select OK to establish connection.

Memo

- WMP for Mac OS not supported.
Use QuickTime Player. (☞ page 44)

Connect the KA-DV5000 to QuickTime Player using the network.

1. Set STREAM TYPE in the ENCODE SETUP menu to "for QT".
2. Open Quick Time Player.



3. Select [File] → [Open URL with New Player].
The following dialog box will appear.

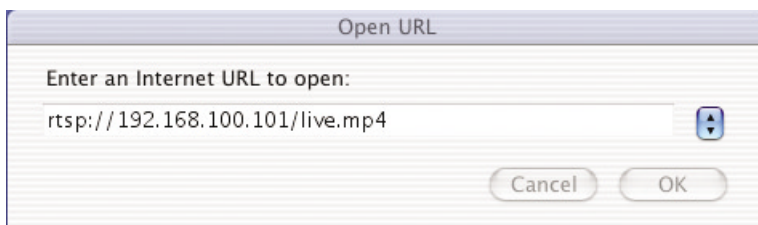

4. Set the IP address of the camera.
rtsp://*.*.*/live.mp4
* → IP address of camera
5. When completed with setting, select OK to establish connection.

The network pack firmware version can be updated.

For details concerning version update data, visit the JVC homepage.

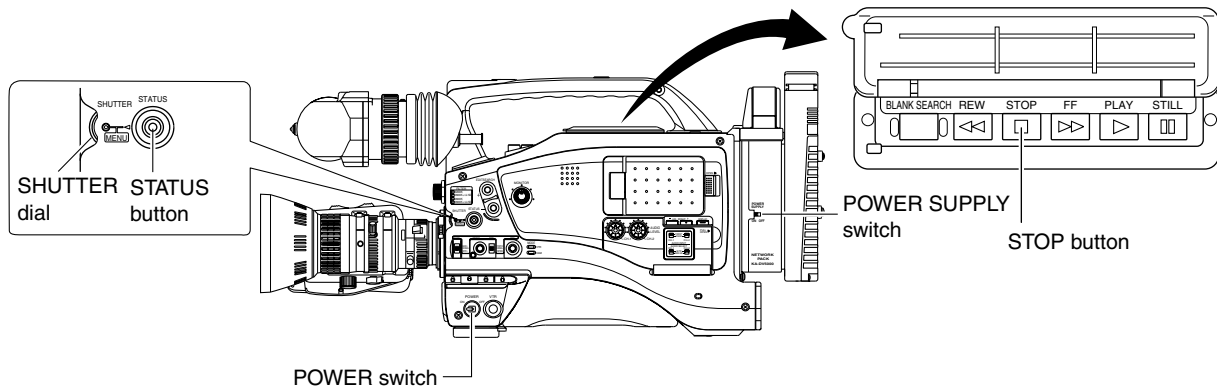

NETWORK PACK CONFIG menu screen

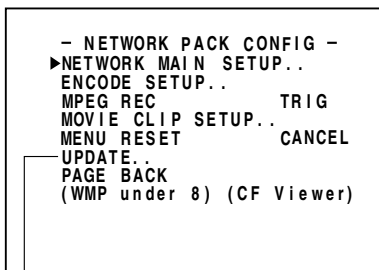

→ UPDATE menu screen

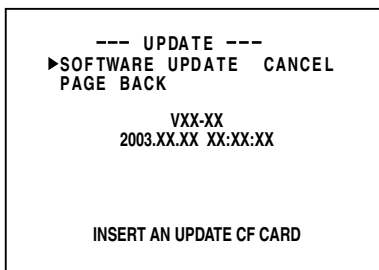

1. Insert a CF memory card with update data into the slot.
2. Set the POWER switch of GY-DV5000 or KA-DV5000 to ON.
3. Press and hold the STATUS button for at least 1 second to display the TOP MENU screen.
4. Set the cursor to NETWORK PACK CONFIG and press the SHUTTER dial while holding the STOP button of the camera.
 - The NETWORK PACK CONFIG menu screen added with the UPDATE item appears.
5. Turn the SHUTTER dial, set the cursor to UPDATE and press the SHUTTER dial.
 - The UPDATE menu screen appears.
6. Set the cursor to SOFTWARE UPDATE and press the SHUTTER dial.
 - CANCEL display will flash and changes will be allowed.
7. Using the SHUTTER dial, set the display to EXECUTE and press the SHUTTER dial.
 - Update will begin and "UPDATE.." will flash on the screen during the process.
8. When update is completed, the normal screen appears.

Caution:

During update, do not turn the power off or perform menu or camera operations. Malfunction may occur as a result.

UPDATE menu screen contents ● indicates default settings.

Item	Setting	Description
NETWORK UPDATE	●CANCEL EXECUTE	Set EXECUTE and press the SHUTTER dial to start update.
PAGE BACK		Press the SHUTTER dial to return to the NETWORK PAC CONFIG menu screen.

When there is a system error, network error, unit malfunction, etc., KA-DV5000 displays the error on the GY-DV5000 LCD screen or viewfinder screen.

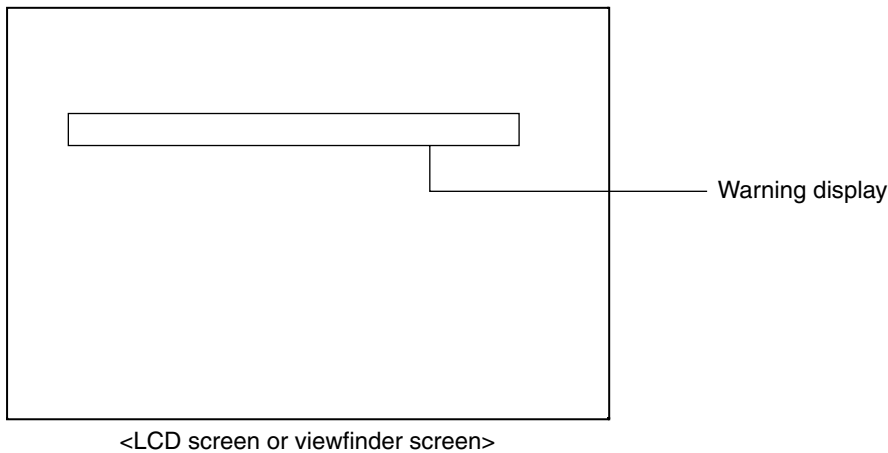

Screen display	Cause	Remedy	Reference page
<File system related>			
CF REMAIN 60SEC! (Flashing for 3 sec.)	Remaining time became less than 60 seconds during recording to CF memory card.	Stop recording and replace with a new CF memory card, or delete files on the current CF memory card to secure recording space.	26
CF REMAIN 30SEC!	Remaining time became less than 30 seconds during recording to CF memory card.		
CF REMAIN 20SEC!	Remaining time became less than 20 seconds during recording to CF memory card.		
CF REMAIN 10SEC!	Remaining time became less than 10 seconds during recording to CF memory card.		
CF FULL! (Displayed until CF recording stops)	Remaining time has run out during recording to CF memory card.		
CF FULL! (Flashing for 3 sec.)	Recording is being attempted on CF memory card with remaining time of less than 10 seconds.		
FORMAT ERROR!	Failed to format CF memory card.	Check the CF memory card and format again. If the card still cannot be formatted, contact your nearest JVC-authorized service agent.	18
NO CF FORMAT! (Flashing)	CF memory card is unformatted, or an unknown format is being used.	Check the CF memory card and format.	18

→ OVER

Screen display	Cause	Remedy	Reference page
<Operation related>			
NO CF CARD! (Flashing for 3 sec.)	There is no CF memory card inserted.	Insert a CF memory card.	3
PROTECT! (Flashing for 3 sec.)	Deletion of a protected clip file was attempted.	To delete the clip file, remove the protection.	25
NO CLIP! (Flashing for 3 sec.)	There is no CF memory card inserted, of there is no clip file available.	Check the CF memory card.	—
SET WLAN AD HOC MODE OFF! (Flashing for 3 sec.)	Use of DHCP server was attempted while in the AD HOC mode.	Set DHCP in the NETWORK SET menu screen to OFF when using the AD HOC mode.	11
SET DHCP OFF! (Flashing for 3 sec.)	Selection of AD HOC mode was attempted while using DHCP server.	Set WLAN AD MOC MODE in the NETWORK SET menu screen to OFF when using DHCP server.	11
OVERLAP HTTP! (Flashing for 3 sec.)	Port set for HTTP for WEB Browser is already in use.	Set an unused port.	11, 34
OVERLAP ASF_HTTP! (Flashing for 3 sec.)	Port set for HTTP for Media Player is already in use.	Set an unused port.	11, 34
OVERLAP ASF-RTSP! (Flashing for 3 sec)	Set port for RTSP for Streamproducer is already in use by another port.	Set an unused port.	11, 34
OVERLAP QT-RTSP! (Flashing for 3 sec)	Set port for RTSP for Quick time is already in use by another port.	Set an unused port.	11, 34
ILLEGAL SETTING! (Flashing for 3 sec.)	Set value exceeded setting range.	Set a value within the setting range.	11, 32, 33, 34
DATA LENGTH 10 or 26 (Flashing for 3 sec)	Setting made with other than 10 or 26 characters.	Set using 10 or 26 characters.	12, 33
CHRACTER IS SHORT!! (Flashing for 3 sec)	Set number of characters is 2 or less / 3 or less.	Set using 3 or more / 4 or more characters.	12, 33
SET LEAP MODE OFF!! (Flashing for 3 sec)	Attempted to use LEAP while in the ADHOC mode.	Set LEAP to OFF when in the ADHOC mode.	12, 32
SAME OLD PASSWORD!! (Flashing for 3 sec)	The new password is the same as the old password.	Set a password different from the old password.	12, 33
GARBAGE! (Flashing display while optimizing)	Optimization of internal ROM disk currently being processed.	Please wait until process is completed.	—
IP ADDRESS ERROR! (Flashing display until network connection is established)	Failed to acquire IP address when DHCP is ON.	Set DHCP again.	11, 32
NO UPDATE FILES! (Flashing for 3 sec.)	There is no update data in the CF memory card.	Insert a CF memory card with UPDATE data into the slot.	
NO UPDATE CARD! (Flashing for 3 sec.)	CF memory card is not inserted.	Insert a CF memory card with UPDATE data into the slot.	
UPDATE FAILED!	Update was not successful.	Contact your JVC dealer.	
COPY GUARD!	Signal of recording origin is protected with copy guard.	Input recording signal with no copy guard protection.	—

By using the PING command standard to Windows, it is possible to check whether the connection is correct and that communication can be made from the PC to KA-DV5000.

- 1.** Launch the command prompt.
 - For Windows 2000
From the Start button, select [Programs] → [Accessories] → [Command Prompt].
- 2.** Input the following and press the Enter key.
PING xxx.xxx.xxx.xxx
(xxx.xxx.xxx.xxx is the IP address of the other party)
Input example: When the IP address of the other party is "192.168.0.10"
PING 192.168.0.010
- 3.** Check to see that the other party is successfully displayed.
If connection is not successful, "Request timed out" or "Destination host unreachable" message will appear.

- **IP address**

Identification number assigned to each computer that is connected to a network. The address is used for communication between network devices.

- **LAN (Local Area Network)**

A network structured within a relatively small range such as in a single building or an office of a company.

- **DHCP (Dynamic Host Control Protocol)**

Method of automatically assigning IP address within a network. When a computer is connected to a network, the DHCP server automatically assigns the IP address.

- **WAN (Wide Area Network)**

A network structured within a wide area such as between the main office of a company and its branch offices. Internet is also generally referred to as WAN.

- **Netmask**

An IP address has the following two roles: 1) address for identifying the network, and 2) address for identifying individual computers. Netmask is a 32-bit value that defines the number of bits of the IP address to use for identifying the network.

- **Gateway**

Hardware and software that translates different types of protocols when a computer communicates with another computer outside the network. The gateway IP address is referred to as the gateway address.

- **RTP (Realtime Transport Protocol)**

Protocol to transmit in realtime digitalized video/audio data via a network.

- **RTSP (Real Time Streaming Protocol)**

Protocol to control realtime transmission of video/audio data via a network.

- **HTTP (Hypertext Transport Protocol)**

Protocol used when transferring HTML (Hypertext Markup Language) files between WWW server and browser.

- **Protocol**

A set rule for a computer or communication device to perform communication over a network, etc.

- **IEEE802,11b**

International standard for wireless LAN with maximum communication speed of 11Mbps.

- **Channel (wireless LAN)**

Frequency range used by wireless LAN. The same frequency must be set by two sides for proper communication.

If there is an access point, adapter, etc., using the same band in the proximity, there may be a hindrance in the communication and may reduce throughput or the quality of communication. When setting, check the settings of surrounding access points, etc., to avoid doubling.

- **ESS-ID (wireless LAN)**

Network identification name used by wireless LAN. The name is used to distinguish other wireless LAN devices.

- **Ad hoc mode (wireless LAN)**

A mode for direct communication without passing through an access point.

- **Infrastrucure (wireless LAN)**

Form of communication via an access point.

→ OVER

- **Encryption mode**

Setting for encrypting the flow of data during wireless communication.

Following settings are available:

None (Open System): No encryption. Setting will be unavailable and throughput will be improved. However, there is the risk of information leakage.

40bit WEP: Encryption is performed using 40-bit encryption key.

128bit: Encryption is performed using 104-bit + 24-bit (1V) keys. Although throughput will decline compared to Open System, security of data will be improved.

- **Access point (wireless LAN)**

Relay point for infrastructure communication. It can also serve as the relay point for cable LAN or wireless LAN.

- **ASF (Advanced Streaming Format)**

Data streaming format developed by Microsoft Corporation (U.S.) for transmission of video and audio.

- **Host name**

Name of a device (not limited to a computer but all connection devices with an IP address) on a network.

- **Port number**

Number used for detecting applications and service during TCP/IP communication.

- **TCP/IP**

Abbreviation for Transmission Control Protocol/Internet Protocol and is one of the protocols used during network connection.

- **UDP**

Different from TCP, UDP is a low-level protocol that does not perform receive checks. In some cases, missing and distorted images may occur due to packet loss.

■ About IP address

Global IP address and local IP address

There are 2 types of IP addresses: "global IP address" and "local IP address".

Global IP address: Just as different IP addresses are needed on a network, all PCs using the Internet worldwide must use a unique IP address. This IP address is referred to as "global IP address".

Normally, the global address is assigned by the IS provider.

Local IP address: In an environment not connected to the Internet (within a household, within a company, etc.), separate IP addresses can be used freely within a network.

This IP address is referred to as "local IP address".

IP address classes

IP addresses are categorized into 3 classes depending on the number of PCs structuring a network.

"Class A IP addresses" are used for large-scale networks, "Class B IP addresses" are used for medium-scale networks and "Class C IP addresses" are used for small-scale networks.

Within a network, all IP addresses must be of the same class. Each IP address is structured by a series of 4 digit numbers separated by a period. The first number of the IP address indicates the class.

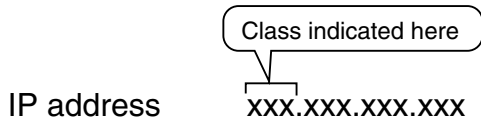

First number of the IP address	Class	Application (number of PCs structuring the network)
1~127	Class A	For large-scale networks (max. approx. 16 million units)
128~191	Class B	For medium-scale networks (max. approx. 65,000 units)
192~223	Class C	For small-scale networks (max. approx. 120 units)

* "224 ~ 255" are normally not used for IP addresses.

For example, a network structured by a few PCs to dozens of PCs would use Class C IP addresses.

Normally, the following special IP addresses are used when structuring a network.

Class	Set IP address
Class A	10.0.0.0 ~ 10.255.255.255
Class B	172.16.0.0 ~ 172.31.255.255
Class C	192.168.0.0 ~ 192.168.255.255

About proxy server

A proxy is a "relay point" for accessing the Internet. When enabling "Use a proxy server", the proxy server will make access to the Internet.

Since various access information is cached at this time, downloading will be faster when reloading the same information from the Internet since the data is loaded from the proxy server.



JVC[®] is a registered trademark owned by VICTOR COMPANY OF JAPAN, LTD.

JVC[®] is a registered trademark in Japan, the U.S.A., the U.K. and many other countries.

© 2002 VICTOR COMPANY OF JAPAN, LIMITED

Free Manuals Download Website

<http://myh66.com>

<http://usermanuals.us>

<http://www.somanuals.com>

<http://www.4manuals.cc>

<http://www.manual-lib.com>

<http://www.404manual.com>

<http://www.luxmanual.com>

<http://aubethermostatmanual.com>

Golf course search by state

<http://golfingnear.com>

Email search by domain

<http://emailbydomain.com>

Auto manuals search

<http://auto.somanuals.com>

TV manuals search

<http://tv.somanuals.com>