

# JVC



## MINI VIDEO PRINTER

# GV-HT1

ENGLISH

Please visit our CyberCam Homepage on the World Wide Web and answer our Consumer Survey (in English only):

<http://www.jvc-victor.co.jp/index-e.html>

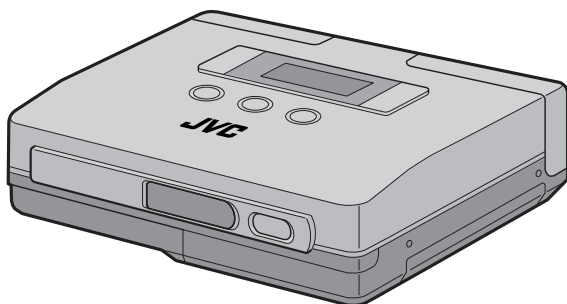

## INSTRUCTIONS

This printer is designed to be used with PAL-type colour television signals. It cannot be used for monitoring with a television of a different standard. Use the BN-V607 battery pack and, to recharge it, the optional multi-voltage AC Power Adapter/Charger. (An appropriate conversion adapter may be necessary to accommodate different designs of AC outlets in different countries.)

This unit is produced to comply with Standard IEC Publ. 65.

### IMPORTANT (for U. K. owners)

**Connection to the mains supply in the United Kingdom.**

**DO NOT cut off the mains plug from this equipment.** If the plug fitted is not suitable for the power points in your home or the cable is too short to reach a power point, then obtain a proper safety approved extension lead/adaptor or consult your dealer.

**BE SURE to replace the fuse only with an identical approved type, as originally fitted, and to replace the fuse cover.**

If nonetheless the mains plug is cut off remove the fuse and dispose of the plug immediately, to avoid a possible shock hazard by inadvertent connection to the mains supply.

If this product is not supplied fitted with a mains plug then follow the instructions given below:

**DO NOT** make any connection to the Larger Terminal coded E or Green.

The wires in the mains lead are coloured in accordance with the following code:

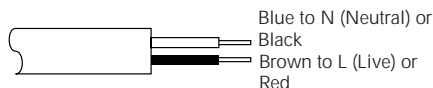

If these colours do not correspond with the terminal identifications of your plug, connect as follows:

Blue wire to terminal coded N (Neutral) or coloured Black.

Brown wire to terminal coded L (Live) or coloured Red.

***If in doubt — consult a competent electrician.***

# Some Do's And Don'ts On The Safe Use Of Equipment

This equipment has been designed and manufactured to meet international safety standards but, like any electrical equipment, care must be taken if you are to obtain the best results and safety is to be assured.

- DO** read the operating instructions before you attempt to use the equipment.
- DO** ensure that all electrical connections (including the mains plug, extension leads and interconnections between pieces of equipment) are properly made and in accordance with the manufacturer's instructions. Switch off and withdraw the mains plug when making or changing connections.
- DO** consult your dealer if you are ever in doubt about the installation, operation or safety of your equipment.
- DO** be careful with glass panels or doors on equipment.
- DON'T** continue to operate the equipment if you are in any doubt about it working normally, or if it is damaged in any way — switch off, withdraw the mains plug and consult your dealer.
- DON'T** remove any fixed cover as this may expose dangerous voltages.
- DON'T** leave equipment switched on when it is unattended unless it is specifically stated that it is designed for unattended operation or has a standby mode. Switch off using the switch on the equipment and make sure that your family knows how to do this. Special arrangements may need to be made for infirm or handicapped people.
- DON'T** use equipment such as personal stereos or radios so that you are distracted from the requirements of road safety. It is illegal to watch television whilst driving.
- DON'T** listen to headphones at high volume, as such use can permanently damage your hearing.
- DON'T** obstruct the ventilation of the equipment, for example with curtains or soft furnishings. Overheating will cause damage and shorten the life of the equipment.
- DON'T** use makeshift stands and NEVER fix legs with wood screws — to ensure complete safety always fit the manufacturer's approved stand or legs with the fixings provided according to the instructions.
- DON'T** allow electrical equipment to be exposed to rain or moisture.

## ABOVE ALL...

- **NEVER** let anyone especially children push anything into holes, slots or any other opening in the case — this could result in a fatal electrical shock;
- **NEVER** guess or take chances with electrical equipment of any kind — it is better to be safe than sorry!

Exercise caution when moving the printer. If you drop the unit, do not attempt to use it. If during use you notice that the cabinet is damaged, shut the printer down, remove power supply unit and contact your JVC dealer. Use of the printer under these conditions can lead to fire or electric shock.

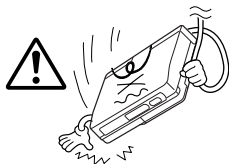

DO NOT place heavy objects on the AC power adapters cords, or leave the cord near any heat-generating appliance, as this can damage the cords. Avoid excessive pulling or twisting of the power cords. If the power cords becomes cut or otherwise damaged, contact your JVC dealer. When unplugging the AC power adapter, DO NOT pull on the cord. Hold the plug itself and remove it from the AC outlet. Use of the printer with a damaged power cord can lead to fire, electric shock and unit malfunctions.

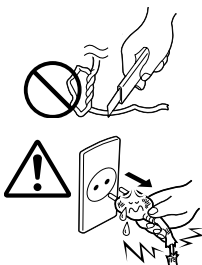

DO NOT remove the cover and attempt to repair or modify the printer. There are high-voltage components within the unit, and the risk of electric shock and unit malfunctions exists. If a problem occurs, contact your JVC dealer.

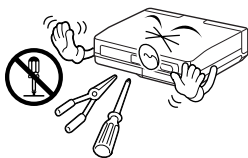

Illustrations of this printer may differ slightly from production models.

## ABOUT THERMAL HEADS

- The thermal heads, necessary for printing, are located within the unit. The heads can become extremely warm. To prevent possible burns and injuries, do not touch the thermal heads.
- When the printer is used for extended periods, the thermal heads experience wear and tear just like VCR heads. As the thermal heads become worn, print quality will gradually decrease. When you notice a decline in quality, it is possible that the heads may need to be replaced. Consult your JVC dealer.

## DUST

Due to dust or lint adhering to print paper, or to extreme variations in temperature, a small degree of colour smearing or lines may be visible in prints.

Failure to heed the following precautions may result in damage to the printer.

1. **DO NOT** place the printer . . .
  - ... in an environment prone to extreme temperatures or humidity.
  - ... in direct sunlight.
  - ... in a dusty environment.
  - ... in an environment where strong magnetic fields are generated.
  - ... on a surface that is unstable or subject to vibration.
2. **DO NOT** place heavy objects on the printer.
3. **DO NOT** place anything which might spill on top of the printer.
4. **AVOID** violent shocks to the printer during transport.

### CAUTION:

Changes or modifications not approved by JVC could void user's authority to operate the equipment.

## Battery Packs

The supplied battery pack is a lithium-ion battery. Before using the supplied battery pack or an optional battery pack, be sure to read the following cautions:

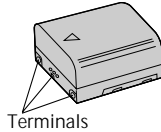

### <Depleting the batteries completely>

1. Turn on the power.
2. Set "save mode" to "off" and remove the batteries when the power is automatically turned off.

### 1. To avoid hazard . . .

- .... do not burn.
- .... do not short-circuit the terminals.
- .... do not modify or disassemble.
- .... do not expose the battery to temperatures exceeding 60°C, as this may cause the battery to overheat, explode or catch fire.
- .... use only specified chargers.

### 2. To prevent damage and prolong service life . . .

- .... do not subject to unnecessary shock.
- .... charge in an environment where temperatures are within the tolerances shown in the chart below. This is a chemical reaction type battery—cooler temperatures impede chemical reaction, while warmer temperatures can prevent complete charging.
- .... store in a cool, dry place. Extended exposure to high temperatures will increase natural discharge and shorten service life.
- .... fully charge and then fully discharge the battery once a year when storing the battery pack over a long period time.
- .... remove from charger or powered unit when not in use, as some machines use current even when switched off.

## NOTES:

- It is normal for the battery pack to be warm after charging, or after use.

### Temperature Range Specifications

Charging .....	10°C to 35°C
Operation .....	0°C to 40°C
Storage .....	-10°C to 30°C

- Recharging time is based on room temperature of 20°C.
- The lower the temperature, the longer recharging takes.

## About Batteries

**DANGER!** Do not attempt to take the batteries apart, or expose them to flame or excessive heat, as there is a risk of fire or explosion.

**WARNING!** Do not allow the battery terminals, or the battery itself, to come in contact with metals, as this can result in a short circuit and possibly start a fire.

## The Benefits Of Lithium-Ion Batteries

Lithium-ion battery packs are small but possess a large power capacity. However, when the battery pack becomes cool in an environment subject to cold temperatures (below 10°C), the battery pack has a characteristic that its usage time becomes shorter and may cease to function. If this happens, place the battery pack in your pocket or other warm, protected place for a short time, then re-attach it to the camcorder. As long as the battery pack itself is not cold, it should not affect performance.

(If you're using some kind of heating pad, make sure the battery pack does not come in direct contact with the pad.)

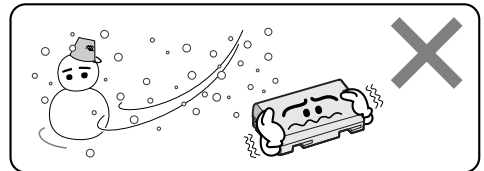

Lithium-ion is vulnerable in colder temperatures.

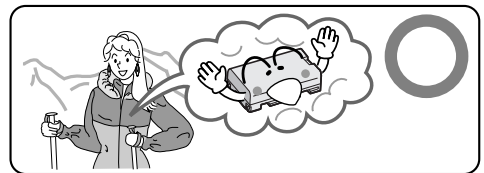

## Serious malfunctioning

If malfunctioning occurs, stop using the unit immediately and consult your local JVC dealer.

The printer is a microcomputer-controlled device. External noise and interference (from a TV, a radio, etc.) might prevent it from functioning properly. In such cases, first disconnect its power supply unit (battery pack, AC Power Adapter/Battery Charger, etc.) and then reconnect it and proceed as usual from the beginning.

- This printer uses the following program under license from Okaya Systemware Co., Ltd. for IrDA infrared transmission:  
IrDA Protocol Stack "Deep Core™" Okaya Systemware Co., Ltd.

## NOTICE

### Copyright

Use of images imported from television broadcasts and recorded materials for other than personal enjoyment without permission from the copyright owner constitutes an infringement on applicable copyright laws.

### Sample Images

The sample images supplied with this printer are used under license from Kodak Japan Co., Ltd. who is the copyright owner.

The image samples provided with this printer are Photo CD images from the Kodak Photo CD Sampler with FILM that were processed as described below using Adobe Photoshop 3.0J.

#### <Sample Image Data>

The original 768 x 512 image was trimmed to 598 x 488 and compressed using the JPEG format before recording.

#### <Source of Images>

Kodak Photo CD Sampler with FILM No. 2  
"Marine" 18

#### Note:

- Note that prints of camcorder or Digital Still Camera images will not be as sharp as prints of the sample images.
- Company names and product names mentioned in this manual are the logos or registered trademarks of respective company.

This equipment is a portable printer that is light enough to bring along with a camcorder or digital still camera on a trip or outing. It can be used in a wide variety of applications.

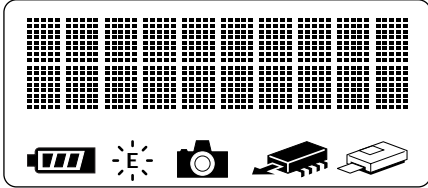

### Easy to read LCD Display

The messages and icons displayed on the LCD panel show at a glance the operating state of the printer.

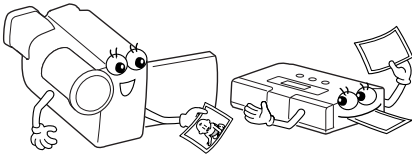

### Printing from Camcorder

Any camcorder with an output terminal can be connected to the printer for instant printing of the desired photo anywhere.

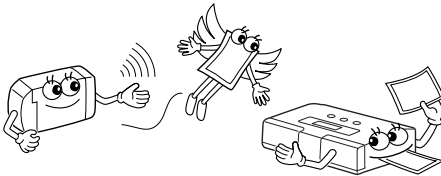

### Cordless connection to digital still cameras

This printer offers cordless connection to any digital still camera conforming to the infrared image transmission (IrTran-P) standard.

### Battery powered for portable operation

Load the battery and you are ready to provide your friends with instant printouts of pictures taken at parties or outdoors.

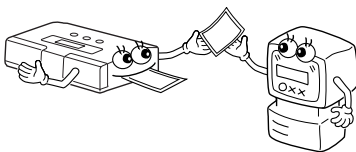

### Input for PC Connection

Used with optional software, this printer connects to a Windows® PC communications port (RS-232C) or Macintosh communications port (RS-422) for printing images.

You can print the picture of your choice on standard paper, stickers.  
A number of special effects are available in addition to normal printing.

## Multipix

On a page you can print 2, 6 or 8 images.

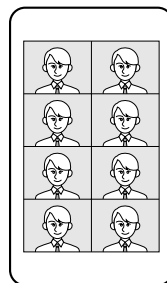

## Calendar Printing

You can use pictures of your choice to print your own calendar.

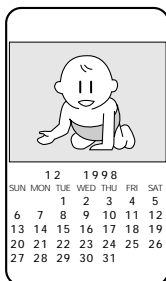

## Frame Print

Internal frames can be superimposed on an image for printing stickers.





<b>CAUTIONS</b>	<b>3</b>
<b>MAJOR FEATURES</b>	<b>6</b>
<b>CONTROLS, INDICATORS AND CONNECTORS</b>	<b>10</b>
Front View .....	10
Rear View .....	11
Bottom View .....	11
Operation buttons .....	12
Memory and Print Operations .....	12
Selecting and setting menu items .....	12
Menu Setting List .....	13
<b>CONNECTIONS (Video Connections)</b>	<b>14</b>
Printing from source with video output terminals .....	14
<b>CONNECTIONS (IrDA Reception)</b>	<b>15</b>
Printing from a digital still camera with IrTran-P .....	15
<b>SUPPLYING THE POWER</b>	<b>16</b>
Charging the Battery .....	16
Loading the Battery .....	17
Using AC power .....	17
<b>INSTALLATION OF INK CASSETTE</b>	<b>18</b>
Installing the Ink cassette .....	18
<b>LOADING THE BLANK PAPER</b>	<b>20</b>
Loading Blank Paper .....	20
<b>PREPARATION</b>	<b>21</b>
<b>PRINTING FROM VIDEO SOURCE WITH VIDEO TERMINALS</b>	<b>22</b>
<b>PRINTING FROM IrTran-P EQUIPPED DIGITAL STILL CAMERA</b>	<b>24</b>
<b>MISCELLANEOUS PRINTING OPERATIONS</b>	<b>26</b>
Superimposing the Frame of Choice on the Image – Frame Printing – .....	26
Printing Multiple Images on the Same Paper – MULTI Print – .....	28
Combining Image and Calendar – Calendar Printing – .....	30
Printing Using Special Effects – Special Effects – .....	32
Manual Feed .....	34
Printing Reversed Images – Mirror Images – .....	36

<b>ADJUSTMENTS</b>	<b>37</b>
Adjusting Image Quality – Adjustments before Printing – .....	37
Saving Energy – Save Mode – .....	38
Switching between motion Picture and Still Picture – Memory Mode Selections – ...	39
<b>TROUBLESHOOTING</b>	<b>40</b>
<b>SPECIFICATIONS</b>	<b>43</b>
<b>INDEX</b>	<b>44</b>

## PROVIDED ACCESSORIES

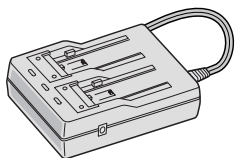

AC adapter/Charger AA-V68



DC cord,  
approx. 0.8 m

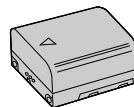

Battery Pack BN-V607  
(battery)



Video cable 1



Video cable 2

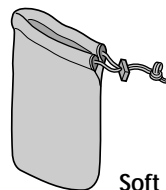

Soft case

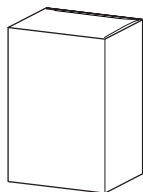

Blank Paper Sheet Set

- Standard Print Paper (6 sheets)
- Sticker paper (6 sheets)
- Ink Cassette (12 prints)

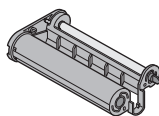

Ink cassette

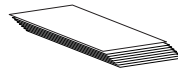

Printing paper

It should be noted that it may be unlawful to print from pre-recorded tapes or discs without the consent of the owner of copyright in the video recording, broadcast or cable programme and in any literary, dramatic, musical, or artistic work embodied therein.

## Front View

**MENU Button**  
Turns menu items on and off.

**MEMORY/SELECT Button**  
**MEMORY Button**  
Press to store an input image.  
**SELECT Button**  
Selects menu items.

**PRINT/SET Button**  
**PRINT Button**  
Press this button after storing an image to print it.  
**SET Button**  
Press to change setup items.

### LCD Panel

Displays messages and icons during operation to indicate printer operating status.

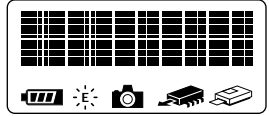

Display	Function	See page
	Message field Indicates menu settings and printer status.	<b>13, 40</b>
	Indicates remaining battery power.	-
	Lights when a print error has occurred. The message field indicates the nature of the error.	<b>41</b>
	Lights when still image memory mode has been selected.	<b>39</b>
	Lights to indicate that an image has been stored in the printer.	<b>23</b>
	Lights during printing.	<b>23</b>

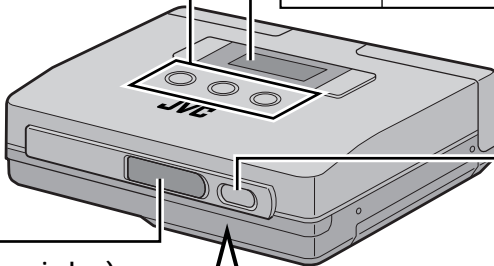

**STANDBY/ON Button**  
Turns the printer on and off.

**IrTran-P (IrDA receiving window)**  
Receives image data during infrared transmission.

**Video input jack**  
Connects a video cable from the video output terminal on camcorder or other unit.

**PC connection jack**  
With the use of optional software, the printer can be connected to a communications port on a PC compatible (RS-232C) or Macintosh (RS-422).

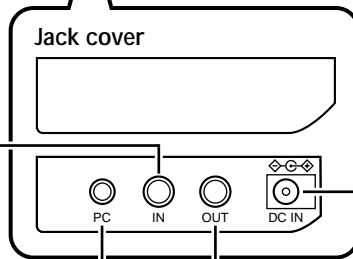

**DC IN**  
Connects AC Adapter/Charger by using a DC cord (provided).

**Video output jack**

- Outputs input image or print image for viewing on a TV or other monitor.
- Connect this output to a video input terminal on a TV.

## Rear View

### Battery compartment

Open the lid to load or remove batteries.

### Paper out/manual feed slot

- Finished prints are ejected from this exit.
- Single sheets of paper are inserted here during manual feed.

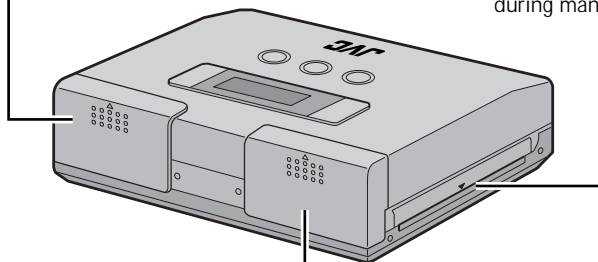

### Ink cassette compartment

Open the lid to load or remove ink cassettes.

## Bottom View

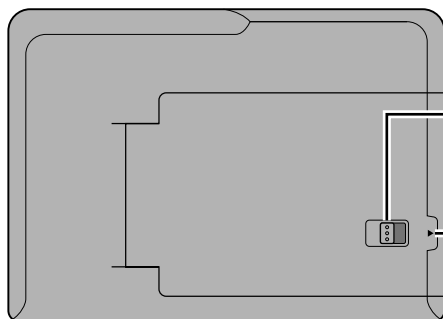

### Paper compartment door switch

Slide this switch to open the paper compartment.

### Paper compartment door

Open this door to load paper.



## ● Operation buttons

Use these buttons to perform operations from storing through to printing images, selecting and setting menu items.

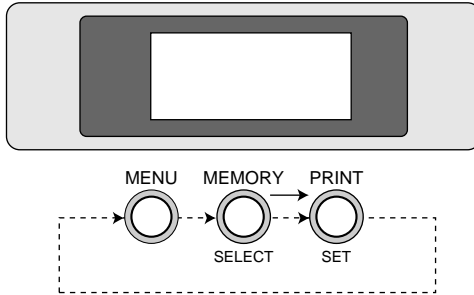



Use the buttons and follow the instructions given on the LCD panel.



## ● Memory and Print Operations

Mode overview		See page
	· Press to store input video image.	23
	· Press to print stored video image.	23

## ● Selecting and setting menu items

Mode overview		See page
	· Turns menus on and off. · Press once to select a menu.	22
	· Each press of the SELECT button displays a menu item on the LCD panel. · Select desired item.	22
 	· Press the SET button and the Selected mode indicator blinks. · Each press of the SET button changes the blinking item on the LCD panel. Select the desired item. · Press the MENU button after selecting the desired item with the SET button to confirm the selection.	22

## ● Menu Setting List

Desired Action	Menu item	Setting				
<b>Set video source</b> · Print sample · Superimpose frame list	input	<input type="checkbox"/> video → infrared → PC <input type="checkbox"/> <input type="checkbox"/> sample → frame list <input type="checkbox"/>				
<b>Superimpose frame</b>	frame Set.	<input type="checkbox"/> off → frame 1 → frame 2 → frame 3 <input type="checkbox"/> <input type="checkbox"/> frame 4 → frame 5 → frame 6 <input type="checkbox"/> <input type="checkbox"/> frame 7 → frame 8 → frame 9 <input type="checkbox"/>				
<b>Enter print mode</b>	print mode	<input type="checkbox"/> standard → 2 div. → 6 div. <input type="checkbox"/> <input type="checkbox"/> 8 div. → calender <input type="checkbox"/>				
<b>Add special print effect</b>	effect	<input type="checkbox"/> off → sepia → B/W <input type="checkbox"/>				
<b>Adjust brightness or tint</b> · Brightness (adjust before storing the image) · Tint (adjust after storing the image)	adj. image	<table border="1"> <tr> <td>bright.</td> <td>0 +1, +2, +3, +4, +5 -1, -2, -3, -4, -5</td> </tr> <tr> <td>tint</td> <td></td> </tr> </table>	bright.	0 +1, +2, +3, +4, +5 -1, -2, -3, -4, -5	tint	
bright.	0 +1, +2, +3, +4, +5 -1, -2, -3, -4, -5					
tint						
<b>Suppress blur</b>	memo. mode	<input type="checkbox"/> motion pic ↔ still pic				
<b>Manual feed print</b>	man. feed	<input type="checkbox"/> off ↔ on				
<b>Print mirror image</b>	mirror	<input type="checkbox"/> off ↔ on				
<b>Save energy</b>	save mode	<input type="checkbox"/> 5min. ↔ off				
<b>Remove jammed paper</b>	form feed	<input type="checkbox"/> off ↔ on				
<b>Switch language display</b>	language	<input type="checkbox"/> English → français → Deutsch <input type="checkbox"/>				
<b>Switch monitor display</b>	monitor	<input type="checkbox"/> input pic. ↔ memo. pic.				

- Initial settings are indicated in gray.  
The printer returns to these settings when powered up after shutdown.
- Menu items that cannot be selected are not displayed.
- The "PC" input mode requires the use of special software.  
For detailed information, consult your nearest JVC dealer.
- A sample video image is stored in the printer. You can select "sample" to print out this sample in the "input" menu.

## Printing from source with video output terminals

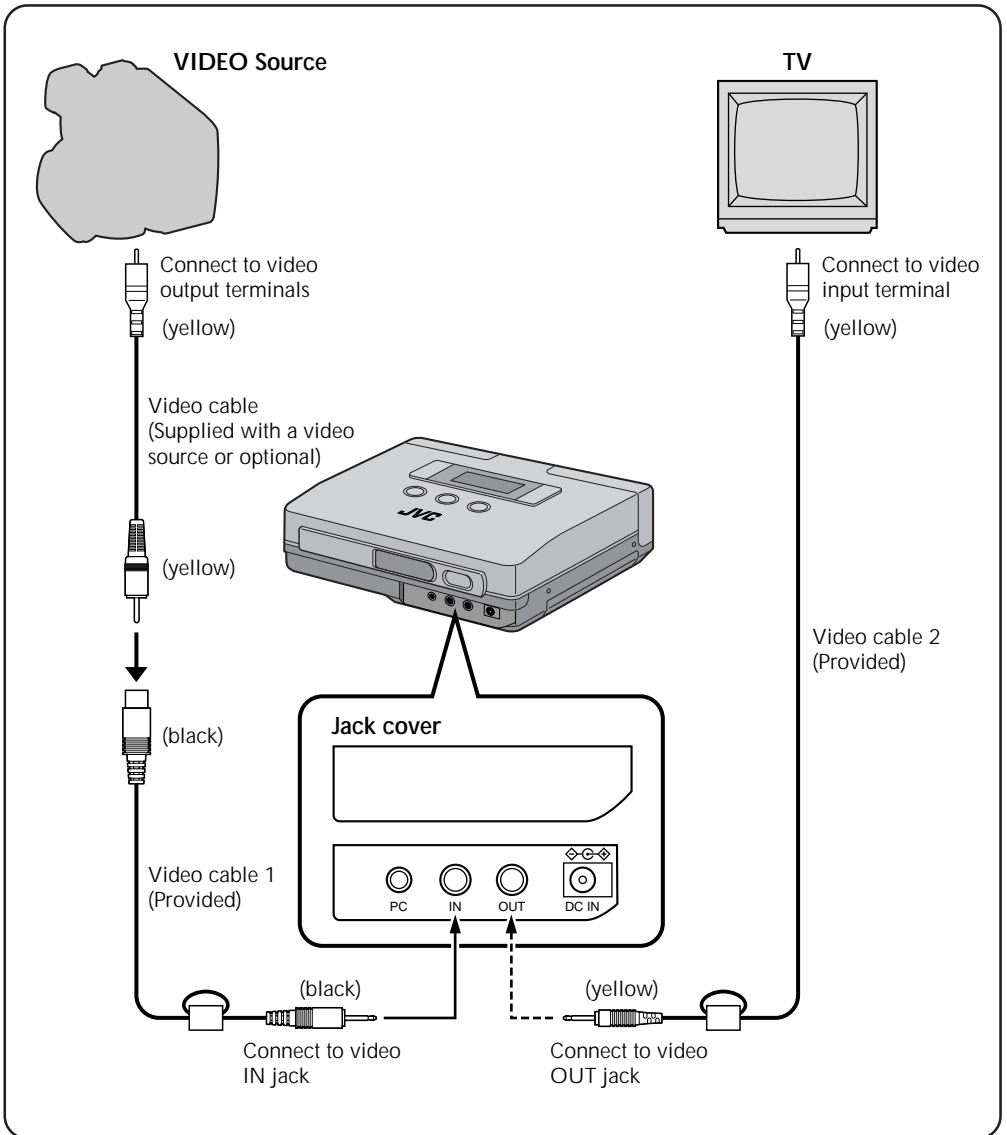

- Notes:**
- Make sure that the printer is properly connected to the video source. A loose video cable connection will prevent printing.
  - Do not place the printer on its side or on a leaning surface as this may cause paper jams.

## Printing from a Digital Still Camera with IrTran-P

This is a standard for transmitting data using infrared transmission. Equipment that conform to this standard can transmit to each other regardless of make.

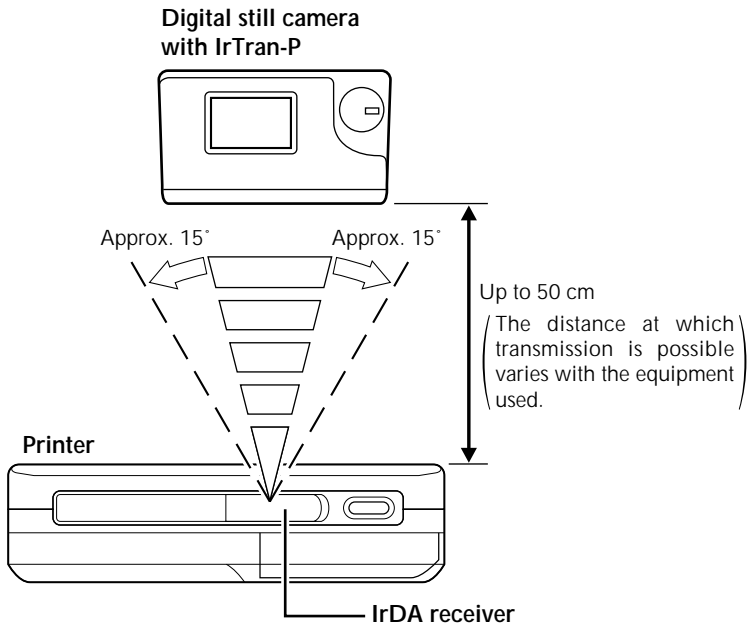

- Notes:**
- IrDA infrared communications allow only two pieces of equipment to communicate. Transmission from one digital still camera to several printers simultaneously is not possible. Only the printer that first receives the data can print it.
  - Transmission may become unstable or impossible due to external light, the state of battery depletion and the distance or angle between the equipment.



## Charging the battery

Use the provided AA-V68 AC adapter/Charger for charging the battery. Batteries that have not been completely depleted can also be charged.

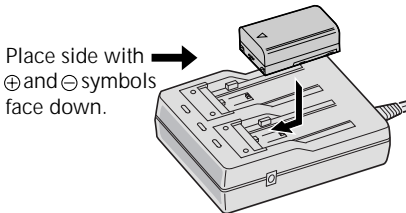
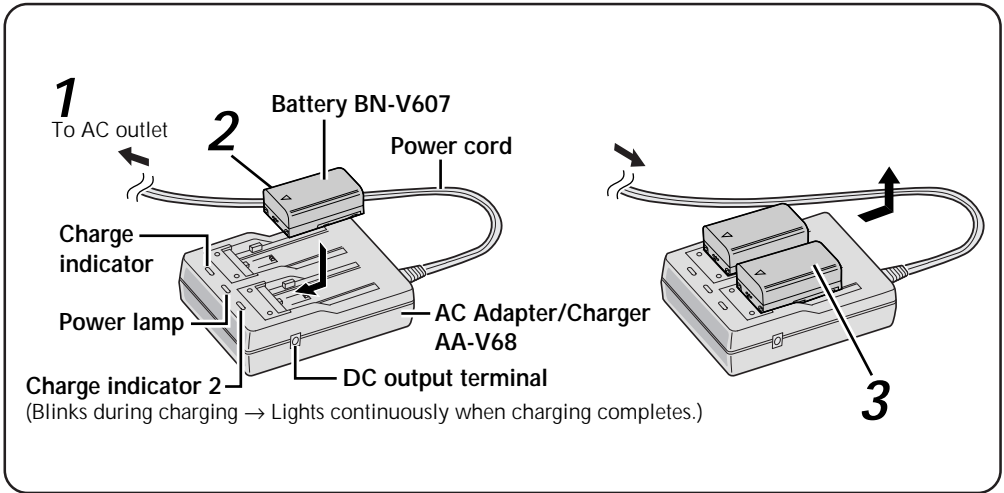

### 1 CONNECT AC ADAPTER/CHARGER

- Connect the power cord to a wall outlet.

### 2 INSERT THE BATTERY

- The charge indicator starts to blink.
- Charging has completed when the indicator stops blinking and is on continuously.

### 3 REMOVE THE BATTERY

- Remove the power cord.

- Approximate charge time → Approx. 90 min for each BN-V607 battery
- Charging not possible → Charging is not possible when the DC cord is connected to the AC adapter.
- Number of prints per battery charge → 40 prints for each BN-V607 battery (at room temperature)

#### NOTES:

- If you connect the DC cord to the AC adapter during battery charging, power is supplied to the printer and charging stops.
- When charging the Battery for the first time or after a long storage period, the Charger Indicator may not light. In this case, remove the Battery from the AC Power Adapter then try charging again.
- Since the AC Power Adapter processes electricity internally, it becomes warm during use. Be sure to use it only in well-ventilated areas.
- If the battery operation time remains extremely short even after having been fully charged, the battery is worn out and needs to be replaced. Please purchase a new one.

## Loading the Battery

The battery (BN-V607) is not charged when shipped. Charge it using the AC adapter before use.

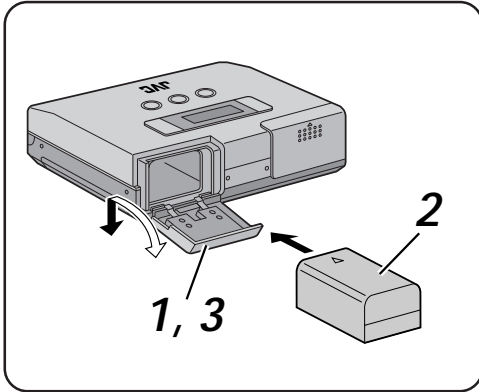

### 1 OPEN THE BATTERY COMPARTMENT LID

- Slide and open the battery compartment lid in the direction of the arrow.

### 2 INSERT THE CHARGED BATTERY

- Note that the battery may be damaged if it is inserted incorrectly.
- Slide in the battery as far as it will go until it is properly seated.

### 3 CLOSE THE BATTERY COMPARTMENT LID

## Using AC power

When using the printer indoors, you can use the AC Adapter instead of a battery.

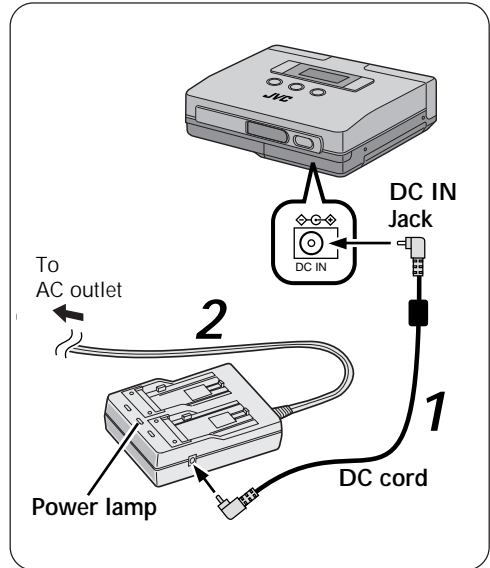

### 1 CONNECT DC CORD

- Connect the DC cord to the AC Adapter then to the printer.

### 2 SUPPLY AC POWER

- Connect the power cord to an AC outlet.

#### NOTE:

When using the provided DC cord, make sure you connect the end of the cable with the core filter to the camcorder. The core filter reduces the interference.

## Removing the Battery

- Open the battery compartment lid and take out the battery.

## Installing the Ink cassette

Before printing, load printing paper and ink kit as shown below.

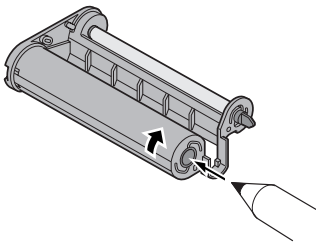
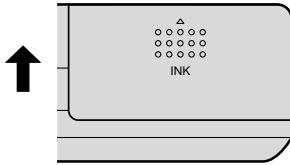
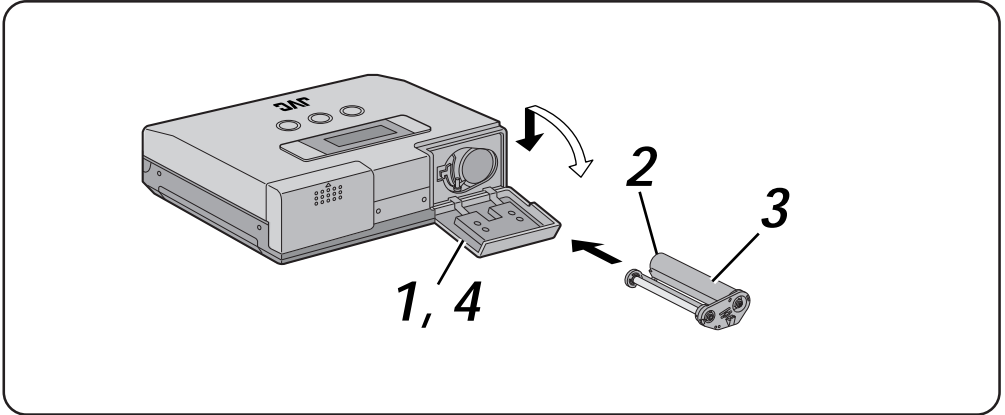

### 1 OPENING INK CASSETTE COMPARTMENT LID

- To open the ink cassette compartment lid, slide it in the direction of the arrow as far as it will go.

### 2 REMOVING SLACK IN THE INK RIBBON, IF ANY

- Insert a propelling pencil or a ball-point pen and rotate the roller in the indicated direction.

### 3 INSTALLING INK CASSETTE

- Hold the side with model label face up and slide in the ink cassette as far as it will go.

### 4 CLOSE THE INK CASSETTE COMPARTMENT LID

## When removing ink cassette

- Grasp the knob at the center of the ink cassette and pull it towards you.

### CAUTION:

Do not touch the inside of the ink cassette compartment to avoid burns and other injuries.

## About blank Paper sheet Set (optional)

The following accessories are required in printing with this printer.

SET	CONTENTS	USES
PV-C20AU (Standard type)	Standard paper: 20 sheets Ink cassette (20 prints)	To print the scene of your choice to make commemorative shots.
PV-C12SAU (Sticker type)	Sticker paper: 12 sheets Ink cassette (12 prints)	Make personalized stickers for pasting on cards, etc.
PV-C12KAU (Standard type, Sticker type)	Standard paper: 6 sheets Sticker paper: 6 sheets Ink cassette (12 prints)	Make personalized stickers for pasting on cards, etc.

**Note:** Pay attention to the following in handling printing paper and ink cassettes

### Before printing

- Do not use printing paper that has been folded or curled to avoid paper jams.
- Do not use wet or humid printing paper as it will not print normally and could cause a paper jam.
- Do not touch or write on the print surface.
- Do not touch or pull out the ink sheets in the ink cassette.
- Make sure that children do not lick or ingest the ink sheets.
- Used ink cassettes should be replaced with new cartridges.  
Old cartridges cannot be reused. Do not attempt to reuse the cartridge by rewinding the rollers.
- Printing paper and ink cassettes must not be stored in a location exposed to high temperatures, high humidity or direct sunlight.
- Read the instructions accompanying the printing paper and ink cassette and use them accordingly.

### After printing

- The printer applies a coating to make the prints glossy.
- The prints should be handled with care since they are coated with a soft material that can easily be damaged by sharp objects such as a fingernail or the like.
- The colors will fade if the paper is exposed to volatile solvents (alcohol, toluene, ketone, etc.).
- Do not paste adhesive tape on the print surface. The image will be damaged when the tape is removed.

### Care in storing prints

- Printed paper must not be stored in a location exposed to high temperatures, high humidity or direct sunlight.
- Store printing paper horizontally in the box. If stored vertically, the paper might curl and cause paper jams.

## Loading Blank Paper

To print, load Blank paper sheet set.

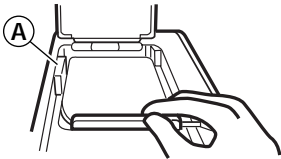
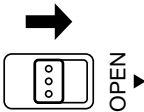
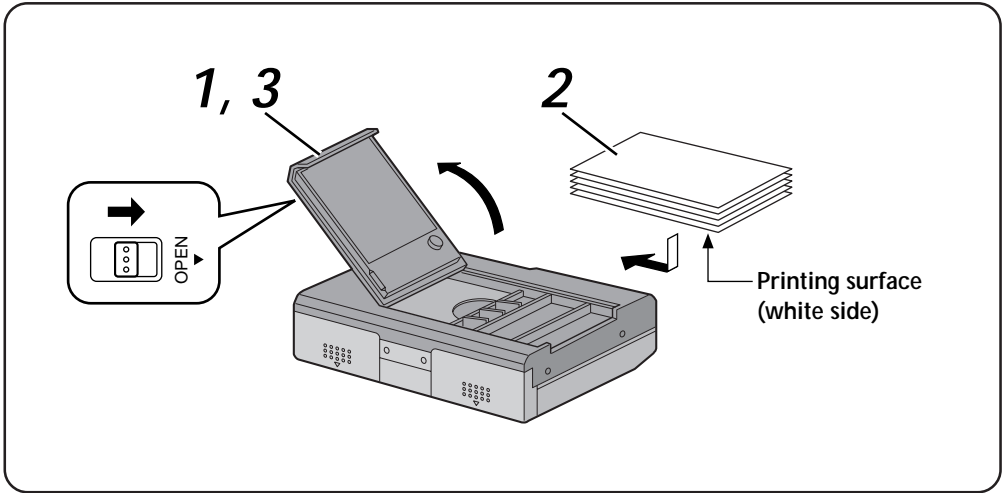

### Notes:

- Make sure that the paper does not rise above tab (A).
- Place the side with the text face up.
- Number of sheets: max. 15 sheets

### 1 OPEN PAPER COMPARTMENT DOOR

- Slide the paper compartment door switch in the direction of the arrow to open the paper compartment door.

### 2 LOAD BLANK PAPER

- Riffle through the paper so that each sheet is separated from the next and place it with the printing surface (white side) facing inside.
- Make sure that the paper does not rise above tab (A).

### 3 CLOSE THE PAPER COMPARTMENT DOOR

- Make sure that the paper has been correctly loaded.
- The door clicks into place when the door is properly closed.

**Notes:** • Read the instructions on the printing paper and ink kit, and the "Caution on Loading Printing Paper" on the inside of the printing paper compartment.

#### • Loading printing paper

Since the paper cannot be properly fed if each sheet sticks together, riffle through the paper before loading it and make sure that the paper ends are aligned.

If the message, "Load paper" is displayed when there is paper in the paper compartment, reload the paper.

- Before printing, make sure everything is set up and ready.

## 1. Connect the printer to the video source to be printed from. (☞pg. 14).

- To use IrTran-P, transmit the images after turning on the power as described in step 5.



## 2. Have a Blank Paper Sheet Set ready (☞pg. 19).



## 3. Install the ink cassette in the printer (☞pg. 18).



## 4. Open the paper compartment door and place the printing paper (☞pg. 20).

- Use the printing paper in the same box as the ink cassette.



## 5. Turn on the power. (☞pg. 10).

- Insert the power plug of the AC adapter in a wall outlet.
- The printer can also be battery powered.
- Turn on the printer.



## 6. Select Language displayed on the LCD panel

You can select desired one of the following display languages: English, French and German.

- Select the Language menu and choose the desired language (☞pg. 13).
  1. Press the MENU button.
  2. Press the SELECT button repeatedly until "language" appears on the LCD panel.
  3. Press the SET button until desired language appears.
  4. Press the MENU button twice.

### Notes:

- The above completes all printer preparations.
- Please read the instructions on pages 22 to 39 before printing.

This is the standard method for printing from a video source with video terminals. It allows you to easily connect your Camcorder, VCR or other video source with video terminals to the printer.

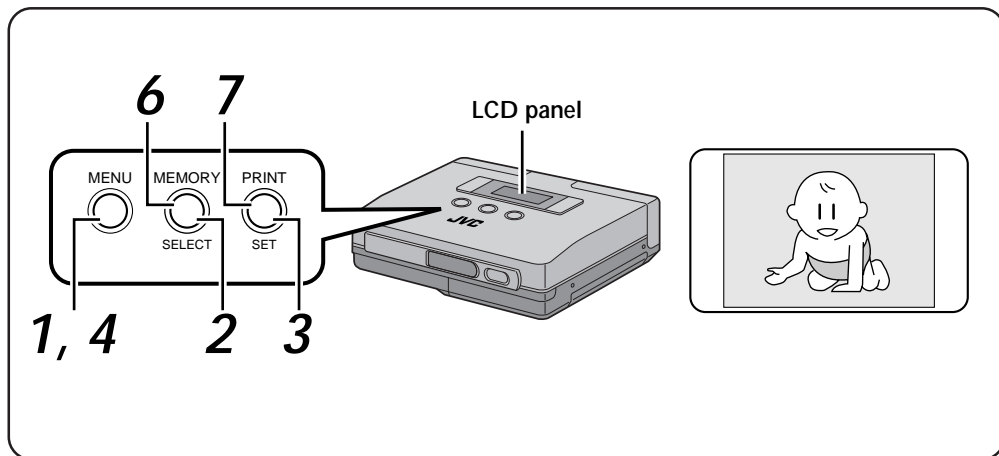

### Preparations

- Make the connections (see pg. 14).

### Selecting Menu Item

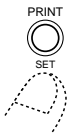
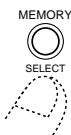

## 1 PRESS THE MENU BUTTON

- This action displays the printer menu on the LCD panel.

## 2 PRESS THE SELECT BUTTON

- Press the SELECT button repeatedly until "input" appears.

### Note:

When "video" is already displayed on the LCD panel, press the MENU button and skip steps 3 and 4.

## 3 PRESS THE SET BUTTON

- The item on the second line of the LCD panel starts to flash.
- Press the SET button until "video" appears.

## 4 PRESS THE MENU BUTTON TWICE TO CONFIRM THE ENTRY

## Print Operations

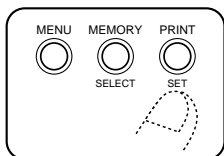
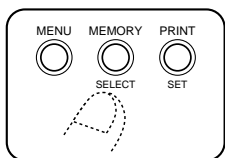
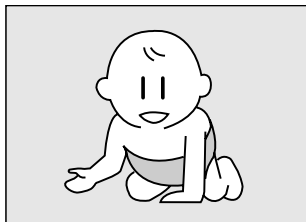

### 5 SET THE VIDEO SOURCE TO PLAY-BACK MODE

- For details, refer to the instruction manual supplied with the video source.

### 6 PRESS THE MEMORY BUTTON WHEN THE IMAGE YOU WISH TO PRINT APPEARS

- This action stores the image you wish to print.
- The message, "Please wait ..." is displayed on the LCD panel while the image is being stored. The message, "Store in memory" is displayed when the image has been stored.
- The memory icon  indicates the following conditions.

**on:** image data has been stored in the printer

**off:** no image data is stored in the printer

### 7 PRESS THE PRINT BUTTON

- The printer starts printing the stored image.
- The message, "Please wait ..." is displayed on the LCD.

Then the printer icon  appears.

- The printer icon  indicates the following conditions.

**on:** image data is being printed

**off:** printing has been completed

- When printing is completed, the message, "Remove paper" is displayed on the LCD panel.

Do not touch the printer or printing paper until this message is displayed.

#### NOTES:

- To print the same image again, press the PRINT button. One print is made each time the PRINT button is pressed.
- To print a different image, perform operations in steps 5 to 7.
- To store the picture again before printing, switch menu item "monitor" from "memo. pic" to "input pic."
- Do not touch the printer or the paper during printing  
During printing paper will come out of the paper out/manual feed slot; do not touch the paper until printing stops to prevent paper jams.  
Do not open the paper compartment door or the ink cassette compartment lid during printing. When the printer is battery powered, do not open the battery compartment door. If opened, printing stops and the power is automatically turned off. When the printer is powered up again, the paper that was being printed when printing stopped is ejected.



The printer can receive and print images from an IrTran-P equipped digital still camera. Since no cables are required, this printing method is ideal at wedding receptions, parties or the like.

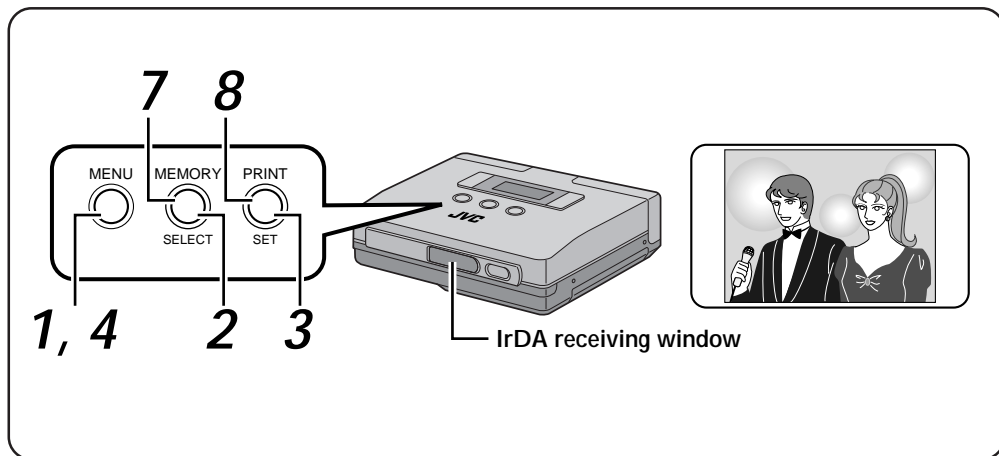

### Preparations

- Make the connections (pg. 15).
- Place the digital still camera and printer within a 50 cm distance of each other. Image transmission can be performed within a 15° angle of the printer receiving window.
- Read the instructions in the instruction manual supplied with the IrTran-P equipped digital still camera.

### Selecting Menu Item

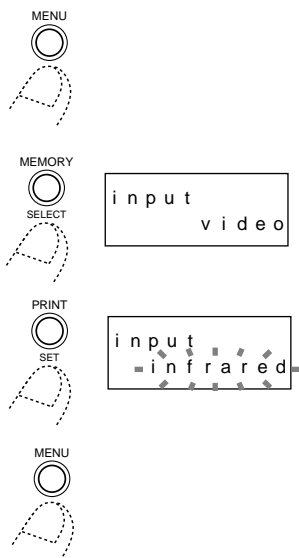

#### 1 PRESS THE MENU BUTTON

- This action displays the printer menu on the LCD panel.

#### 2 PRESS THE SELECT BUTTON

- Press the SELECT button repeatedly until "input" appears.

#### 3 PRESS THE SET BUTTON

- The item on the second line of the LCD panel starts to blink.
- Press the SET button until "infrared" appears.

#### 4 PRESS THE MENU BUTTON TWICE TO CONFIRM THE ENTRY

## Digital Still Camera Operations

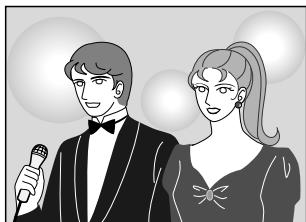

### Note:

Transmission may become unstable or impossible due to external light, the state of battery depletion and the distance or angle between the equipment.

## 5 SELECT THE DIGITAL STILL CAMERA IMAGE YOU WISH TO PRINT

- For details, refer to the instruction manual supplied with the camera.

## 6 TRANSFER THE CAMERA IMAGE TO THE PRINTER

- Orient the infrared sending window on the digital still camera so that it faces the IrTran-P receiving window on the printer.
- Make sure that there are no objects between the printer and the camera.
- Transmit the data from the camera to the printer.

## Print Operations

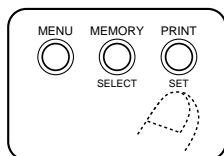



### NOTES:

- To print the same image again, press the PRINT button. One print is made each time the PRINT button is pressed.
- To print a different image, perform operations in steps 5 to 8.

## 7 THE PRINTER STARTS RECEIVING THE IMAGE

- The image you wish to print is now being stored.
- While the image data is being stored, the message, "infrared receiving" is displayed on the LCD panel.
- The memory icon  indicates the following conditions.
  - on:** image data has been stored in the printer
  - off:** no image data is stored in the printer

## 8 PRESS THE PRINT BUTTON

- The printer starts printing the stored image.
- The message, "Please wait ..." is displayed on the LCD panel. Then the printer icon  appears.
- The printer icon  indicates the following conditions.
  - on:** image data is being printed
  - off:** printing has been completed

## Superimposing the Frame of Choice on the Image - Frame Printing -

- You can print a frame around an image.
- Select one frame you wish to use out of the nine available frames. You can use sticker paper to print titles for greeting cards and so on.

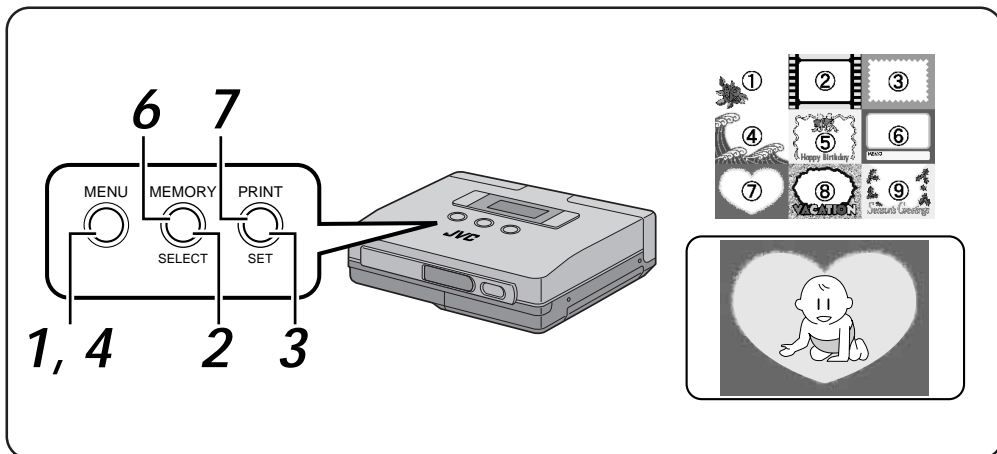

### Preparations

- Make the connections (see pg. 14).

### Selecting Menu Item

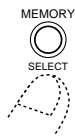

```
f r a m e  s e t .
o f f
```

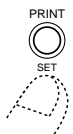

```
f r a m e  s e t .
f r a m e  7
```



### 1 PRESS THE MENU BUTTON

- This action displays the printer menu on the LCD panel.

### 2 PRESS THE SELECT BUTTON

- Press the SELECT button repeatedly until "frame set." appears.

### 3 PRESS THE SET BUTTON

- The item on the second line of the LCD panel starts to blinking.
- Press the SET button until the desired frame number appears.

### 4 PRESS THE MENU BUTTON TWICE TO CONFIRM THE ENTRY

## Print Operations

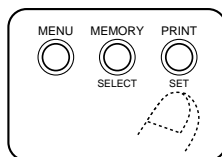
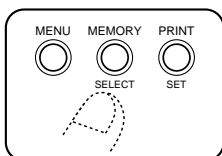
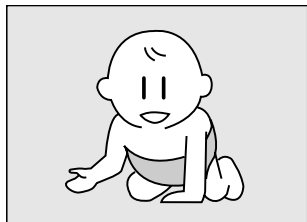



### 5 SET THE VIDEO SOURCE TO PLAY-BACK MODE

- For details, refer to the instruction manual supplied with the video source.

### 6 PRESS THE MEMORY BUTTON WHEN THE IMAGE YOU WISH TO PRINT APPEARS

- This action stores the image you wish to print.
- The message, "Please wait ..." is displayed on the LCD panel while the image is being stored.
- The memory icon  indicates the following conditions.
  - on:** image data has been stored in the printer
  - off:** no image data is stored in the printer

### 7 PRESS THE PRINT BUTTON

- The printer starts printing the stored image.
- The message, "Please wait ..." is displayed on the LCD panel. Then the printer icon  appears.
- The printer icon  indicates the following conditions.
  - on:** image data is being printed
  - off:** printing has been completed

#### NOTES:

- To print the same image again, press the PRINT button. One print is made each time the PRINT button is pressed.
- To print a different image, perform operations in steps 5 to 7.
- The frame cannot be changed after printing.
- When the "input" menu item is displayed (see page 13), you can select "frame list" and print all 9 frames. This makes it easier to select a frame.

## Printing Multiple Images on the Same Paper – MULTI Print –

You can print 2, 6 or up to 8 images on a single paper.

This makes it easy to customize printing to suit the application.

You can use sticker paper to print titles for season's greetings and so on.

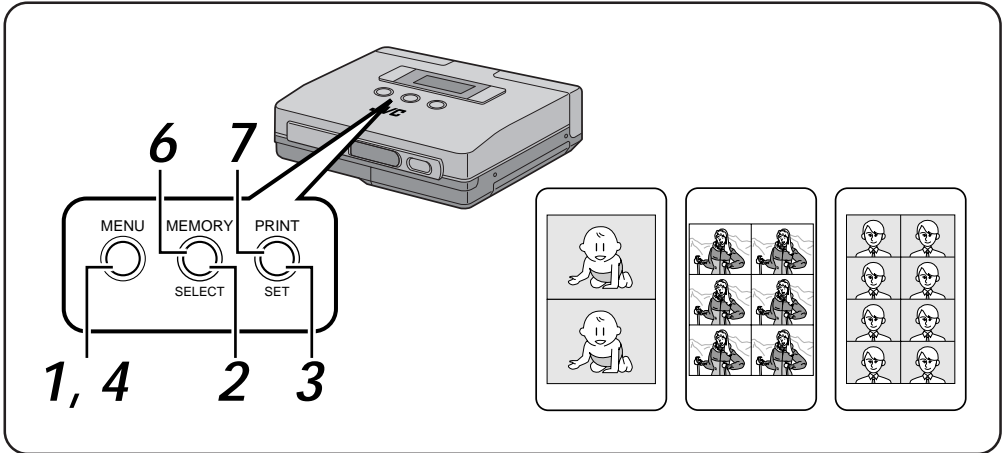

### Preparations

- Make the connections (☞ pg. 14).

### Selecting Menu Item

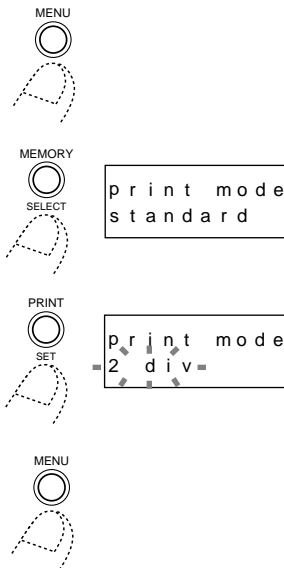

#### 1 PRESS THE MENU BUTTON

- This action displays the printer menu on the LCD panel.

#### 2 PRESS THE SELECT BUTTON

- Press the SELECT button repeatedly until "print mode" appears.

#### 3 PRESS THE SET BUTTON

- The item on the second line of the LCD panel starts to blink.
- Press the SET button until the desired number of images appears.

#### 4 PRESS THE MENU BUTTON TWICE TO CONFIRM THE ENTRY

## Print Operations

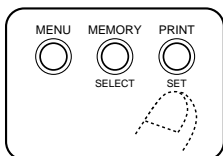
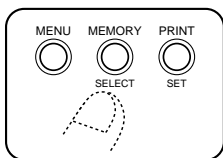
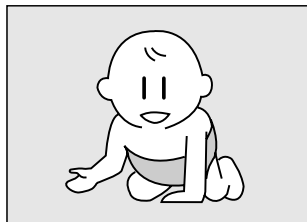



### 5 SET THE VIDEO SOURCE TO PLAY-BACK MODE

- For details, refer to the instruction manual supplied with the video source.

### 6 PRESS THE MEMORY BUTTON WHEN THE IMAGE YOU WISH TO PRINT APPEARS

- This action stores the image you wish to print.
- The image stored in memory is displayed in the selected number of multiple images.
- The message, "Please wait ..." is displayed on the LCD panel while the image is being stored.
- The memory icon  indicates the following conditions.
  - on:** image data has been stored in the printer
  - off:** no image data is stored in the printer

### 7 PRESS THE PRINT BUTTON

- The printer starts printing the stored image.
- The message, "Please wait ..." is displayed on the LCD panel. Then the printer icon  appears.
- The printer icon  indicates the following conditions.
  - on:** image data is being printed
  - off:** printing has been completed

#### NOTES:

- To print the same image again, press the PRINT button. One print is made each time the PRINT button is pressed.
- To print a different image, perform operations in steps 5 to 7.
- The multipix setting cannot be changed after printing.
- On a TV screen, multipix images are displayed horizontally across the screen.

## Combining Image and Calendar – Calendar Printing –

You can turn your favorite picture into a calendar.

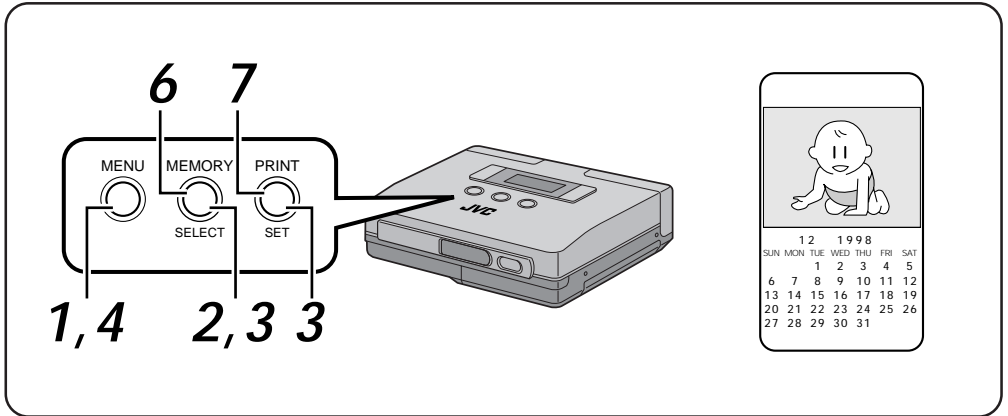

### Preparations

- Make the connections (☞ pg. 14).

### Selecting Menu Item

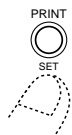
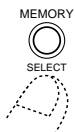
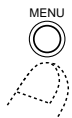

```
print mode
standard
```

```
print mode
calendar
```

```
year 1998
month Jan
```

```
year 1998
month Dec
```

### 1 PRESS THE MENU BUTTON

- This action displays the printer menu on the LCD panel.

### 2 PRESS THE SELECT BUTTON

- Press the SELECT button repeatedly until "print mode" appears.

### 3 PRESS THE SET BUTTON

- The item on the second line of the LCD panel starts to blink.
- Press the SET button until the "calendar" appears on the LCD panel.
- Do as follows to change calendar years and months.
  - Press the SELECT button when "calendar" blinks.
  - Press the SET button repeatedly until the desired year appears on the LCD panel. Years between 1998 and 2007 can be selected.
  - Press the SELECT button.
  - Press the SET button repeatedly until the desired month appears on the LCD panel.
  - Press the MENU button to confirm the entry.

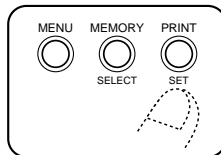
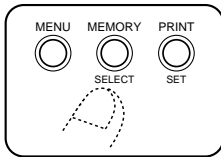
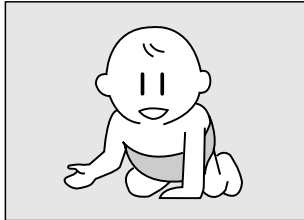

## 4 PRESS THE MENU BUTTON TWICE TO CONFIRM THE ENTRY

- When entering the year and month in step 3, press the MENU button only once.

### Print Operations



## 5 SET THE VIDEO SOURCE TO PLAY-BACK MODE

- For details, refer to the supplied instruction manual.

## 6 PRESS THE MEMORY BUTTON WHEN THE IMAGE YOU WISH TO PRINT APPEARS

- This action stores the image you wish to print.
- The message, "Please wait ..." is displayed on the LCD panel while the image is being stored.
- The memory icon  indicates the following conditions.
  - on:** image data has been stored in the printer
  - off:** no image data is stored in the printer

## 7 PRESS THE PRINT BUTTON

- The printer starts printing the stored image.
- The message, "Please wait ..." is displayed on the LCD panel.
  - Then the printer icon  appears.
- The printer icon  indicates the following conditions.
  - on:** image data is being printed
  - off:** printing has been completed

### NOTES:

- To print the same image again, press the PRINT button. One print is made each time the PRINT button is pressed.
- To print a different image, perform operations in steps 5 to 7.
- On a TV screen, the images are displayed horizontally across the screen.



## Printing Using Special Effects – Special Effects –

You can print an image in “sepia” or “black and white”.

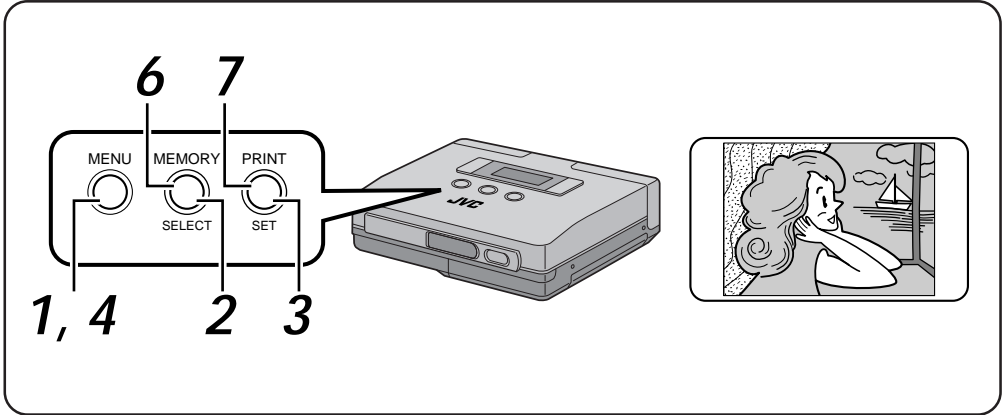

### Preparations

- Make the connections (☞ pg. 14).

### Selecting Menu Item

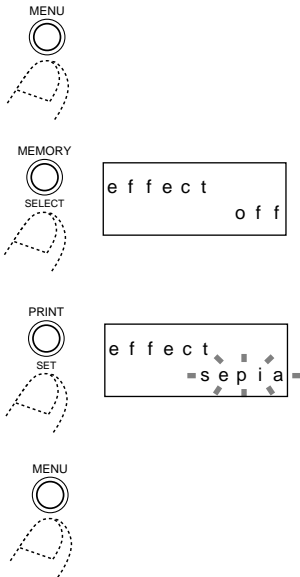

#### 1 PRESS THE MENU BUTTON

- This action displays the printer menu on the LCD panel.

#### 2 PRESS THE SELECT BUTTON

- Press the SELECT button repeatedly until “effect” appears.

#### 3 PRESS THE SET BUTTON

- The item on the second line of the LCD panel starts to blink.
- Press the SET button repeatedly until “sepia” or “B/W” appears.

#### 4 PRESS THE MENU BUTTON TWICE TO CONFIRM THE ENTRY

#### Notes:

- When “sepia” is selected, the image is printed in sepia-tinted (reddish-brown) monochrome like an old faded photograph.
- When “B/W” is selected, the image is printed in black and white.
- The special effect appears only in the printed image, while the image on the monitor is displayed in color.

## Print Operations

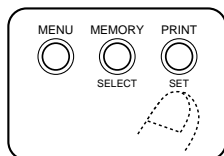
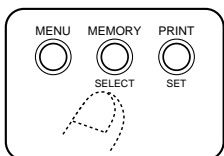



### 5 SET THE VIDEO SOURCE TO PLAY-BACK MODE

- For details, refer to the instruction manual supplied with the video source.

### 6 PRESS THE MEMORY BUTTON WHEN THE IMAGE YOU WISH TO PRINT APPEARS

- This action stores the image you wish to print.
- The message, "Please wait ..." is displayed on the LCD panel while the image is being stored.
- The memory icon  indicates the following conditions.
  - on:** image data has been stored in the printer
  - off:** no image data is stored in the printer

### 7 PRESS THE PRINT BUTTON

- The printer starts printing the stored image.
- The message, "Please wait ..." is displayed on the LCD panel. Then the printer icon  appears.
- The printer icon  indicates the following conditions.
  - on:** image data is being printed
  - off:** printing has been completed
- The image is printed using the selected special effect.

#### NOTES:

- To print the same image again, press the PRINT button. One print is made each time the PRINT button is pressed.
- To print a different image, perform operations in steps 5 to 7.
- The settings cannot be changed when printing is completed. To change settings, store an image into a memory again.

## Manual Feed

This function allows you to print one page at a time using manual feed.

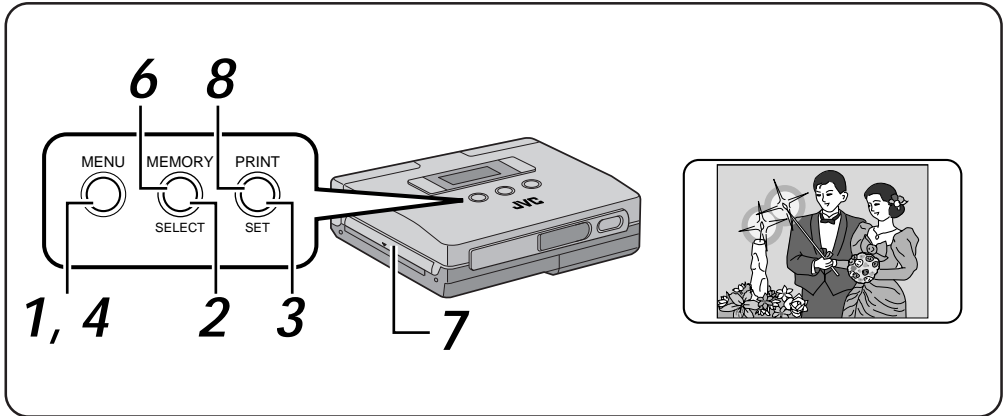

### Preparation

- Make the connections (pg. 14).

### Selecting Menu Item

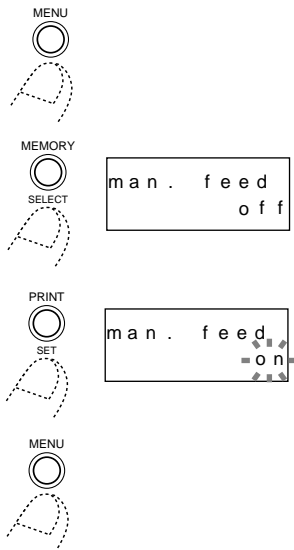

#### 1 PRESS THE MENU BUTTON

- This action displays the printer menu on the LCD panel.

#### 2 PRESS THE SELECT BUTTON

- Press the SELECT button repeatedly until "man. feed" appears.

#### 3 PRESS THE SET BUTTON

- The item on the second line of the LCD panel starts to blink.
- Press the SET button until "on" appears.

#### 4 PRESS THE MENU BUTTON TWICE TO CONFIRM THE ENTRY

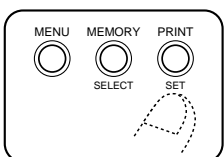
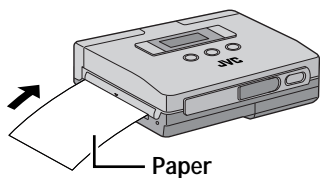
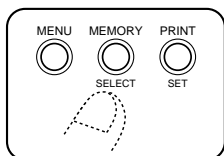

## Print Operations

### 5 SET THE VIDEO SOURCE TO PLAY-BACK MODE

- For details, refer to the instruction manual supplied with the video source.



### 6 PRESS THE MEMORY BUTTON WHEN THE IMAGE YOU WISH TO PRINT APPEARS

- This action stores the image you wish to print.
- The message, "Please wait ..." is displayed on the LCD panel while the image is being stored.
- The memory icon  indicates the following conditions.
  - on:** image data has been stored in the printer
  - off:** no image data is stored in the printer

### 7 INSERT PRINTING PAPER IN PAPER OUT/MANUAL FEED SLOT

- Slide in the printing paper with the printing surface up as far as it will go without curling it.
- Unless the printing paper is inserted straight, it will cause a paper jam.

### 8 PRESS THE PRINT BUTTON

- Gently press the edge of the printing paper into the printer.
- Release the paper when it is pulled into the printer.
- The printer starts printing the stored image.
- The message, "Please wait ..." is displayed on the LCD panel. Then the printer icon  appears.
- The printer icon  indicates the following conditions.
  - on:** image data is being printed
  - off:** printing has been completed

#### NOTES:

- You can add a frame, produce multipix prints or add special effects.
- To print the same image again, press the PRINT button. One print is made each time the PRINT button is pressed.
- To print a different image, perform operations in steps 5 to 8.

## Printing Reversed Images – Mirror Images –

You can, if you wish, reverse a printed image.

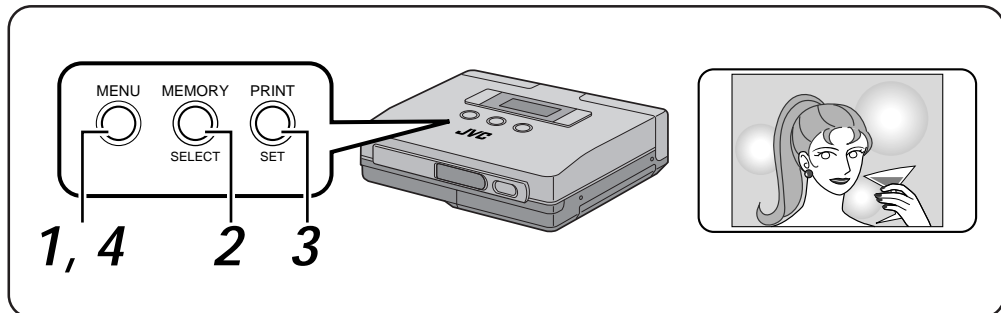

### Preparations

- Make the connections (☞ pg. 14).

### Selecting Menu Item

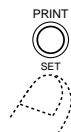
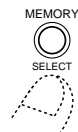

### 1 PRESS THE MENU BUTTON

- This action displays the printer menu on the LCD panel.

### 2 PRESS THE SELECT BUTTON

- Press the SELECT button repeatedly until "mirror" appears.

### 3 PRESS THE SET BUTTON

- The item on the second line of the LCD panel starts to blink.
- Press the SET button until "on" appears.

#### NOTE:

Only the printed image will be reversed, a monitor connected to the printer will display the normal image.

### 4 PRESS THE MENU BUTTON TWICE TO CONFIRM THE ENTRY

### Print Operations

- Observe the instructions on pages 22 to 35 to print the image.

## Adjusting Image Quality – Adjustments before Printing –

When “video” is set in the menu item “input”, you can adjust the brightness and tint before printing.

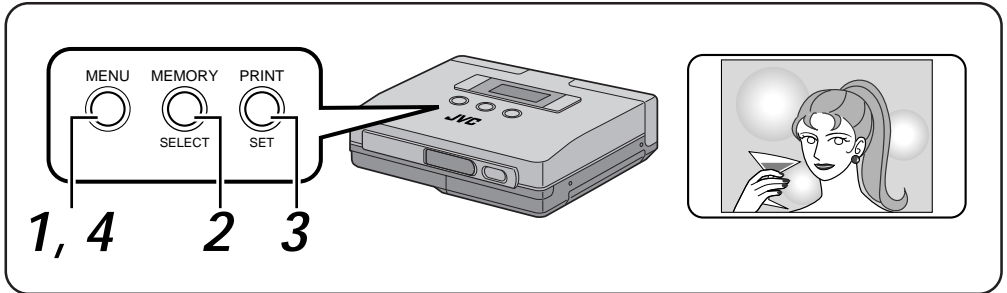

### Preparations

- Make the connections (pg. 14).
- Select “video” in the “input” menu (pg. 22).

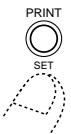
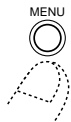

```
adj . image
br ight . 0
```

```
adj . image
br ight . =0
```

```
adj . image
br ight . +1
```

```
adj . image
tint . +1
```

### Selecting Menu Item

- The brightness of the image can be adjusted only before storing it.
- The tint of the image can be adjusted only after storing it.

#### 1 PRESS THE MENU BUTTON

- This action displays the printer menu on the LCD panel.

#### 2 PRESS THE SELECT BUTTON

- Press the SELECT button repeatedly until “adj. image” appears.

#### 3 PRESS THE SET BUTTON

- The item on the second line of the LCD panel starts to blink.
- Adjusting image brightness
  - Press the SELECT button until “bright.” appears.
  - Press the SET button repeatedly to select the desired brightness.
  - To increase brightness, select 0, +1, +2, +3, +4 or +5. The higher numbers indicate greater brightness. To decrease brightness, select 0, -1, -2, -3, -4 or -5. The higher numbers indicate lower brightness.
- Adjusting image tint
  - Press the SELECT button until “tint” appears.
  - Press the SET button repeatedly to select the desired tint. To increase saturation, select 0, +1, +2, +3, +4 or +5. The higher numbers indicate greater saturation. To decrease saturation, select 0, -1, -2, -3, -4 or -5. The higher numbers indicate lower saturation.

#### 4 PRESS THE MENU BUTTON TWICE TO CONFIRM THE ENTRY

## Saving Energy – Save Mode –

- The printer is equipped with a power saving feature to reduce battery power consumption.
- When the printer is turned on and not used for 5 minutes, the save mode automatically turns it off.

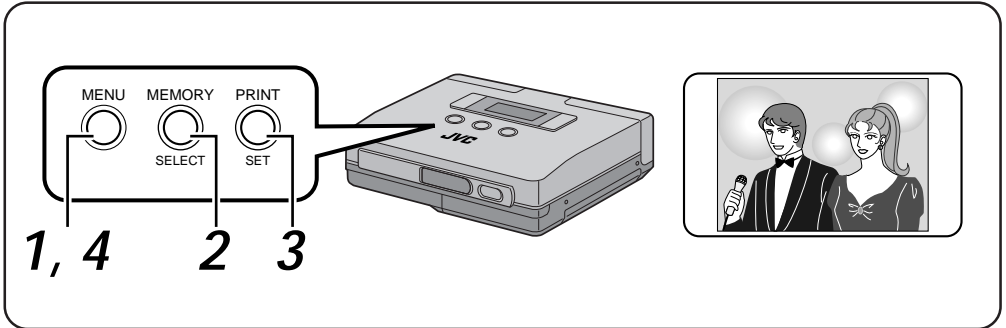

### Preparations

- Make the connections (☞ pg. 14).

### Selecting Menu Item

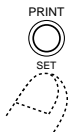
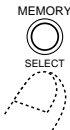

save mode  
off

save mode  
5 min

#### 1 PRESS THE MENU BUTTON

- This action displays the printer menu on the LCD panel.

#### 2 PRESS THE SELECT BUTTON

- Press the SELECT button repeatedly until "save mode" appears.

#### 3 PRESS THE SET BUTTON

- The item on the second line of the LCD panel starts to blink.
- Press the SET button until "5 min." appears.

#### 4 PRESS THE MENU BUTTON TWICE TO CONFIRM THE ENTRY

- When "5 min" is selected, the printer will automatically be turned off if it is left idle for 5 minutes.
- When "off" is selected, the printer will be on continuously.

#### Notes:

- When the printer is turned off, it will automatically be reset to the "5 min" setting.
- "save mode" cannot be selected when "PC" is selected in the "input" menu item (see page 13).

## Switching between Motion Picture and Still Picture - Memory Mode Selection -

- When "video" is set in the menu item "input", you can select between motion picture or still picture.
- The motion picture setting has a feature for suppressing blur and thus lends itself to capturing images from camcorder or VCRs.
- The still picture setting turns off the blur suppressing function and is therefore best suited to storing still images from digital still cameras and so on.

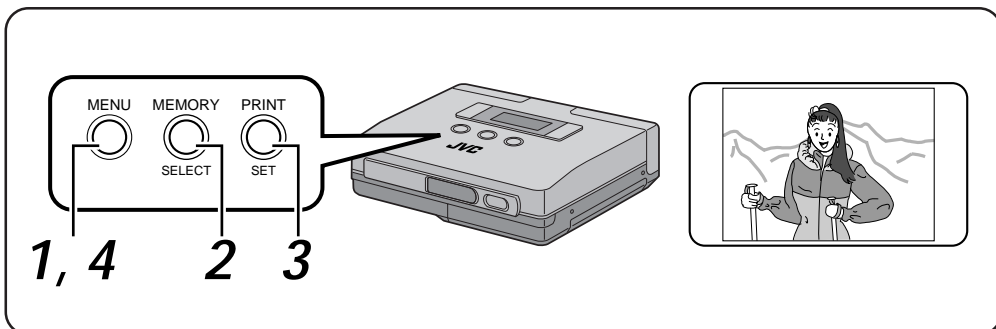

### Preparations

- Make the connections (☞ pg. 14).

### Selecting Menu Item

#### 1 PRESS THE MENU BUTTON

- This action displays the printer menu on the LCD panel.

#### 2 PRESS THE SELECT BUTTON

- Press the SELECT button repeatedly until "memo. mode" appears.

#### 3 PRESS THE SET BUTTON

- The item on the second line of the LCD panel starts to blink.
- Press the SET button until "motion pic" appears.

#### NOTE:

The camera  icon is displayed in the still picture mode.

#### 4 PRESS THE MENU BUTTON TWICE TO CONFIRM THE ENTRY

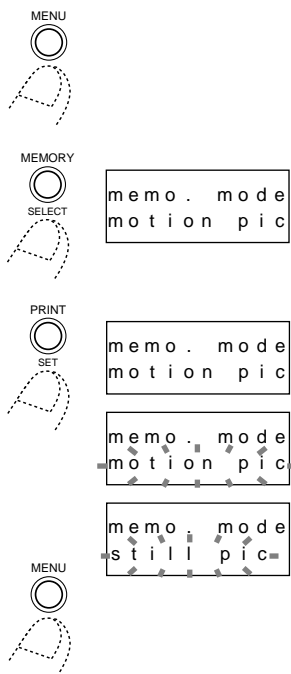



## Meaning of Messages Displayed on the LCD panel

Message	<ul style="list-style-type: none"> <li>● <b>Appears when:</b></li> <li>■ <b>Action:</b></li> </ul>	page
Please wait...	<ul style="list-style-type: none"> <li>● Image data is being stored or printing has started.</li> </ul>	-
Connect video in	<ul style="list-style-type: none"> <li>● The video source and the printer are not connected or the cable has been disconnected.</li> <li>■ Connect the video cable according to the instructions on page 14.</li> </ul>	14
No video signal	<ul style="list-style-type: none"> <li>● An attempt is made to store an image from a video source that has been turned off.</li> <li>■ Turn on the video source.</li> </ul>	-
Memorise image	<ul style="list-style-type: none"> <li>● An attempt is made to print before an image has been stored.</li> <li>■ Store image data before printing.</li> </ul>	-
Charge battery	<ul style="list-style-type: none"> <li>● The battery is depleted.</li> <li>■ Load a charged battery (BN-V607).</li> </ul>	16-17
Insert ink cassette	<ul style="list-style-type: none"> <li>● An ink cassette has not been loaded or not been properly loaded.</li> <li>■ Load ink cassette and close the lid.</li> </ul>	18
Close cass. door	<ul style="list-style-type: none"> <li>● The ink cassette compartment lid is open.</li> <li>■ Close ink cassette compartment lid.</li> </ul>	18
Change ink cassette	<ul style="list-style-type: none"> <li>● The ink cassette is depleted.</li> <li>■ Load new ink cassette.</li> </ul>	18
Insert paper	<ul style="list-style-type: none"> <li>● No printing paper is loaded.</li> <li>■ Load printing paper properly and close the paper compartment door.</li> </ul>	20
Close paper door	<ul style="list-style-type: none"> <li>● The paper compartment door is open.</li> <li>■ Load printing paper properly and close the paper compartment door.</li> </ul>	20
Paper jammed	<ul style="list-style-type: none"> <li>● A paper jam occurs during printing.</li> <li>■ Clear paper jam according to instructions on page 42.</li> </ul>	42
Remove paper	<ul style="list-style-type: none"> <li>● A paper jam occurs during printing.</li> <li>■ Clear paper jam according to instructions on page 42.</li> </ul>	42
Print is impossible	<ul style="list-style-type: none"> <li>● Printing is attempted at low temperature (0°C or colder).</li> <li>● Abnormal image data has been stored.</li> <li>■ Use the printer under specified conditions.</li> </ul>	43

## OTHER PROBLEMS:

This printer contains microprocessors. External electronic noise or interference could cause malfunctioning. In such a case, switch the power off. Then turn on the power and check again.

If	Check to see if	Page
No power is applied to the printer.	<ul style="list-style-type: none"> <li>● Has the battery been properly charged?</li> <li>● Has the power supply been correctly connected?</li> </ul>	16
The error icon  is lit (or blinks) on the LCD panel	<ul style="list-style-type: none"> <li>● Is a message displayed on the LCD panel? If a message is displayed, follow instructions on page 40.</li> <li>● If not, turn off the printer and wait. Then turn on the power again.</li> </ul>	40
Paper jam	<ul style="list-style-type: none"> <li>● A paper jam may be caused by the following factors.               <ul style="list-style-type: none"> <li>· Paper was not inserted straight during manual feed.</li> <li>· The printer was placed on its side or on a leaning surface.</li> </ul> </li> </ul>	34
	<ul style="list-style-type: none"> <li>● Remove a jammed paper according to instructions on page 42.</li> </ul>	42
The video source image you wish to print is not displayed on the TV.	<ul style="list-style-type: none"> <li>● Is the video cable correctly connected?</li> <li>● Is the TV input selector set to "Video (external input)"?</li> <li>● The input terminal has priority.</li> </ul>	14
The TV is showing a still image.	<ul style="list-style-type: none"> <li>● Is the TV showing the stored image (memory image)? Set the "monitor" menu to "input pic".</li> </ul>	13
The stored image disappeared.	<ul style="list-style-type: none"> <li>● The stored image is deleted when the power is turned off. Store the image again.</li> </ul>	-
The color appears faded. The color differs from set image	<ul style="list-style-type: none"> <li>● The color may differ somewhat from the image displayed on the TV. This is not due to any defect of the printer.</li> </ul>	-
The image quality cannot be adjusted	<ul style="list-style-type: none"> <li>● Image adjustment is not possible when the menu input mode is something other than video.</li> </ul>	-
The printed image is not clean.	<ul style="list-style-type: none"> <li>● The printed image is not clean when dirt or dust adheres to the printing paper. Dirt and dust can also cause equipment breakdown.</li> </ul>	-
Stripes on the printed surface	<ul style="list-style-type: none"> <li>● Due to the reflection of light, stripes may appear on the printed surface. This is normal and is not a cause for concern.</li> </ul>	-
The printed image may differ from the TV image.	<ul style="list-style-type: none"> <li>● The tint and brightness of the printed image may differ from the image as it is displayed on the TV connected to the printer. This is normal and not a failure.</li> </ul>	-

## WHEN PAPER JAMS

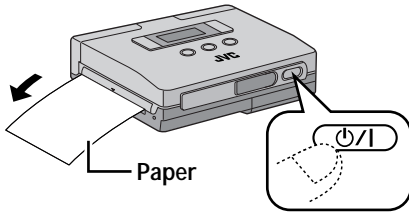

# 1 TURN OFF THE POWER AND TURN IT BACK ON AGAIN

- The jammed paper is ejected from the PAPER OUT/MANUAL FEED slot.

When paper jam is not removed using procedure 1.

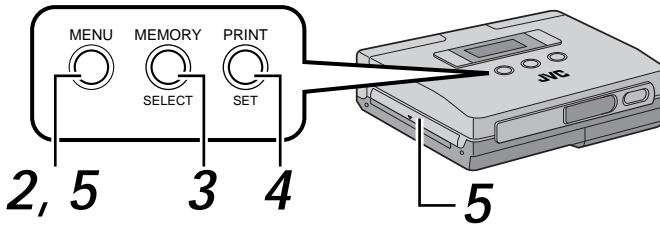

# 2 PRESS THE MENU BUTTON

- This action displays the printer menu on the LCD panel.

# 3 PRESS THE SELECT BUTTON

- Press the SELECT button repeatedly until "form feed" appears.

# 4 PRESS THE SET BUTTON

- The item on the second line of the LCD panel starts to blink.
- Press the SET button repeatedly until "on" appears.

# 5 PRESS THE MENU BUTTON

- The jammed paper is ejected from the PAPER OUT/MANUAL FEED slot.



```

form feed
off
  
```

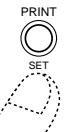

```

form feed
on
  
```

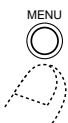

<b>Power supply</b>	DC 6 V $\overline{\text{=}}$ (with AC adapter) DC 7.2 V $\overline{\text{=}}$ (with lithium-ion battery)
<b>Power consumption</b>	11 W
<b>Print format</b>	Dye sublimation
<b>Print area</b>	70 mm x 52 mm (area depends on print format)
<b>Paper size</b>	86 x 54 mm
<b>Print quality</b>	598 (horiz.) dots x 448 (vert.) dots
<b>Resolution</b>	217 dpi
<b>Print speed (processing time)</b>	Approx. 70 sec (excluding data transfer and processing)
<b>Connectors</b>	<ul style="list-style-type: none"> <li>· IrDA input: infrared receiver (one on front panel) (conforms to IrDA Ver. 1.0 IrTran-P)</li> <li>· Video input : 3.5 mm in diam. (one on front panel)</li> <li>· Video output : 3.5 mm in diam. (one on front panel)</li> <li>· PC input : 2.5 mm in diam. (one on front panel)</li> </ul>
<b>Operating temperature</b>	+5 – +35°C
<b>Relative humidity</b>	35 – 80 %
<b>Storage temperature</b>	-20 – +60°C
<b>Dimensions</b>	130 (W) x 36.5 (H) x 94.5 (D) mm
<b>Weight</b>	345 g . (printer excluding battery and blank paper sheet set)
<b>AC Adapter/Charger</b>	<ul style="list-style-type: none"> <li>• Power requirement : AC 110 – 240 V <math>\sim</math>, 50/60 Hz</li> <li>• Power consumption : 20 W</li> <li>• Output : DC 7.2 V<math>\overline{\text{=}}</math>, 0.77 A (CHARGE) DC 6.3 V<math>\overline{\text{=}}</math>, 1.8 A (VTR)</li> <li>• Dimenusions : 94 (W) x 35 (H) x 122 (D) mm</li> <li>• Weight : AA-V68EG : Approx. 300 g AA-V68EK : Approx. 360 g</li> </ul>

E. & O. E. design and specifications subject to change without notice.

**B**

Battery compartment lid ..... 17

**C**

Calendar print ..... 30  
 Charging the battery ..... 16  
 Connections ..... 14, 15

**D**

Depleting the battery ..... 4  
 DC input jack ..... 10

**F**

Frame print ..... 26

**I**

Icon ..... 10  
 Image adjustment ..... 37  
 Ink cassette compartment lid ..... 18  
 IrTran-P (IrDA) ..... 10, 24

**J**

Jack cover ..... 10

**L**

LCD panel ..... 10

**M**

Manual feed slot ..... 11, 35  
 MEMORY button ..... 12  
 MENU button ..... 12  
 Menu item list ..... 13  
 Mirror print ..... 36  
 Multipix ..... 28

**O**

Operation buttons ..... 12

**P**

Paper compartment door switch ..... 11, 20  
 PC connection jack ..... 10  
 PRINT button ..... 12  
 Printing from digital still camera ..... 24  
 Printing with special effects ..... 32

**S**

Save mode ..... 38  
 SELECT button ..... 12  
 SET button ..... 12  
 Switching between motion picture  
 and still image ..... 39  
 STANDBY/ON  $\phi$ /I button ..... 10

**V**

Video input jack ..... 10, 14  
 Video output jack ..... 10, 14





## Free Manuals Download Website

<http://myh66.com>

<http://usermanuals.us>

<http://www.somanuals.com>

<http://www.4manuals.cc>

<http://www.manual-lib.com>

<http://www.404manual.com>

<http://www.luxmanual.com>

<http://aubethermostatmanual.com>

Golf course search by state

<http://golfingnear.com>

Email search by domain

<http://emailbydomain.com>

Auto manuals search

<http://auto.somanuals.com>

TV manuals search

<http://tv.somanuals.com>