

JVC



MINI VIDEO PRINTER

GV-HT1

ENGLISH

Please visit our CyberCam Homepage on the World Wide Web and answer our Consumer Survey (in English only):

<http://www.jvc-victor.co.jp/index-e.html>

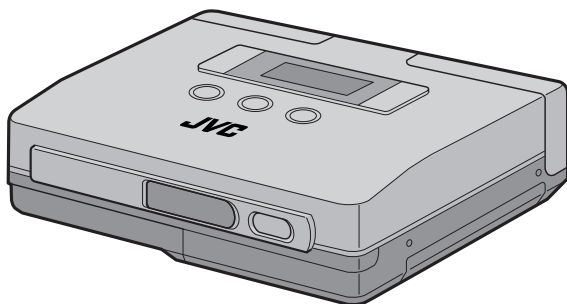

For Customer Use:

Enter below the Model No. and Serial No. which is located on the bottom of cabinet. Retain this information for future reference.

Model No. _____

Serial No. _____

INSTRUCTIONS

Dear Customer,

Thank you for purchasing this Printer. Before use, please read the safety information and precautions contained in the following pages to ensure safe use of this product.

Using This Instruction Manual

- All major sections and subsections are listed in the Table Of Contents (☞ pg. 8, 9).
- Notes appear after most subsections. Be sure to read these as well.
- Basic and advanced features/operation are separated for easier reference.

It is recommended that you . . .

- ... refer to "Controls, Indicators and Connectors" (☞ pgs. 12 – 15) and familiarize yourself with button locations, etc. before use.
- ... read thoroughly the Safety Precautions and Safety Instructions that follow. They contain extremely important information regarding the safe use of your new Printer.

You are recommended to carefully read the cautions on page 5 before use.

SAFETY PRECAUTIONS

	CAUTION RISK OF ELECTRIC SHOCK DO NOT OPEN	
<p>CAUTION: TO REDUCE THE RISK OF ELECTRIC SHOCK, DO NOT REMOVE COVER (OR BACK). NO USER-SERVICEABLE PARTS INSIDE. REFER SERVICING TO QUALIFIED SERVICE PERSONNEL.</p>		



The lightning flash with arrowhead symbol, within an equilateral triangle, is intended to alert the user to the presence of uninsulated "dangerous voltage" within the product's enclosure that may be of sufficient magnitude to constitute a risk of electric shock to persons.



The exclamation point within an equilateral triangle is intended to alert the user to the presence of important operating and maintenance (servicing) instructions in the literature accompanying this product.

WARNING:

TO PREVENT FIRE OR SHOCK HAZARD, DO NOT EXPOSE THIS UNIT TO RAIN OR MOISTURE.

CAUTIONS:

- To prevent shock, do not open the cabinet. No user serviceable parts inside. Refer servicing to qualified personnel.
- When you are not using the AC Power Adapter/Battery charger for a long period of time, it is recommended that you disconnect the power cord from AC outlet.

The AA-V68U AC Power Adapter should be used with:
AC 120 V~, 60 Hz in the USA and Canada,
AC 110 – 240 V~, 50/60 Hz in other countries.

CAUTION (applies to the AA-V68U)

TO PREVENT ELECTRIC SHOCK MATCH WIDE BLADE OF PLUG TO WIDE SLOT, FULLY INSERT.

ATTENTION (s'applique à l'AA-V68U)

POUR ÉVITER LES CHOCS ÉLECTRIQUES, INTRODUIRE LA LAME LA PLUS LARGE DE LA FICHE DANS LA BORNE CORRESPONDANTE DE LA PRISE ET POUSSER JUSQU'AU FOND.

NOTES:

- The rating plate (serial number plate) is on the bottom and/or the back of the main unit.
- The rating plate (serial number plate) of the AC Power Adapter/Charger is on its bottom.

IMPORTANT

- Never use any AC Power Adapter/Battery Charger other than the one provided with this printer.
- If you lose the provided AC Power Adapter/Battery Charger or if it malfunctions, please consult your nearest JVC service dealer.

This printer is designed to be used with NTSC-type colour television signals. It cannot be used for monitoring with a television of a different standard. Use the BN-V607 battery pack and, to recharge it, the multi-voltage AC Power Adapter/Charger. (An appropriate conversion adapter may be necessary to accommodate different designs of AC outlets in different countries.)

IMPORTANT PRODUCT SAFETY INSTRUCTIONS

Electrical energy can perform many useful functions. But improper use can result in potential electrical shock or fire hazards. This product has been engineered and manufactured to assure your personal safety. In order not to defeat the built-in safeguards, observe the following basic rules for its installation, use and servicing.

ATTENTION:

Follow and obey all warnings and instructions marked on your product and its operating instructions. For your safety, please read all the safety and operating instructions before you operate this product and keep this manual for future reference.

INSTALLATION

1. Grounding or Polarization

- (A) Your product may be equipped with a polarized alternating-current line plug (a plug having one blade wider than the other). This plug will fit into the power outlet only one way. This is a safety feature. If you are unable to insert the plug fully into the outlet, try reversing the plug. If the plug should still fail to fit, contact your electrician to replace your obsolete outlet. Do not defeat the safety purpose of the polarized plug.
- (B) Your product may be equipped with a 3-wire grounding-type plug, a plug having a third (grounding) pin. This plug will only fit into a grounding-type power outlet. This is a safety feature. If you are unable to insert the plug into the outlet, contact your electrician to replace your obsolete outlet. Do not defeat the safety purpose of the grounding-type plug.

2. Power Sources

Operate your product only from the type of power source indicated on the marking label. If you are not sure of the type of power supply to your home, consult your product dealer or local power company. If your product is intended to operate from battery power, or other sources, refer to the operating instructions.

3. Overloading

Do not overload wall outlets, extension cords, or integral convenience receptacles as this can result in a risk of fire or electric shock.

4. Power Cord Protection

Power supply cords should be routed so that they are not likely to be walked on or pinched by items placed upon or against them, paying particular attention to cords at plugs, convenience receptacles, and the point where they exit from the product.

5. Ventilation

Slots and openings in the cabinet are provided for ventilation. To ensure reliable operation of the product and to protect it from overheating, these openings must not be blocked or covered.

- Do not block the openings by placing the product on a bed, sofa, rug or other similar surface.
- Do not place the product in a built-in installation such as a bookcase or rack unless proper ventilation is provided or the manufacturer's instructions have been adhered to.

6. Wall or Ceiling Mounting

The product should be mounted to a wall or ceiling only as recommended by the manufacturer.

USE

1. Accessories

To avoid personal injury:

- Do not place this product on an unstable cart, stand, tripod, bracket or table. It may fall, causing serious injury to a child or adult, and serious damage to the product.
- Use only with a cart, stand, tripod, bracket, or table recommended by the manufacturer or sold with the product.
- Use a mounting accessory recommended by the manufacturer and follow the manufacturer's instructions for any mounting of the product.
- Do not try to roll a cart with small casters across thresholds or deep-pile carpets.

2. Product and Cart Combination

A product and cart combination should be moved with care. Quick stops, excessive force, and uneven surfaces may cause the product and cart combination to overturn.

3. Water and Moisture

Do not use this product near water—for example, near a bath tub, wash bowl, kitchen sink or laundry tub, in a wet basement, or near a swimming pool and the like.

PORTABLE CART WARNING
(Symbol provided by RETAC)



4. Object and Liquid Entry

Never push objects of any kind into this product through openings as they may touch dangerous voltage points or short-out parts that could result in a fire or electric shock. Never spill liquid of any kind on the product.

5. Attachments

Do not use attachments not recommended by the manufacturer of this product as they may cause hazards.

6. Cleaning

Unplug this product from the wall outlet before cleaning. Do not use liquid cleaners or aerosol cleaners. Use a damp cloth for cleaning.

7. Heat

The product should be situated away from heat sources such as radiators, heat registers, stoves, or other products (including amplifiers) that produce heat.

SERVICING

1. Servicing

If your product is not operating correctly or exhibits a marked change in performance and you are unable to restore normal operation by following the detailed procedure in its operating instructions, do not attempt to service it yourself as opening or removing covers may expose you to dangerous voltage or other hazards. Refer all servicing to qualified service personnel.

2. Damage Requiring Service

Unplug this product from the wall outlet and refer servicing to qualified service personnel under the following conditions:

- When the power supply cord or plug is damaged.
- If liquid has been spilled, or objects have fallen into the product.
- If the product has been exposed to rain or water.
- If the product does not operate normally by following the operating instructions. Adjust only those controls that are covered by the operating instructions as an improper adjustment of other controls may result in damage and will often require extensive work by a qualified technician to restore the product to its normal operation.
- If the product has been dropped or damaged in any way.
- When the product exhibits a distinct change in performance—this indicates a need for service.

3. Replacement Parts

When replacement parts are required, be sure the service technician has used replacement parts specified by the manufacturer or have the same characteristics as the original part. Unauthorized substitutions may result in fire, electric shock or other hazards.

4. Safety Check

Upon completion of any service or repairs to this product, ask the service technician to perform safety checks to determine that the product is in safe operating condition.

Exercise caution when moving the printer. If you drop the unit, do not attempt to use it. If during use you notice that the cabinet is damaged, shut the printer down, remove power supply unit and contact your JVC dealer. Use of the printer under these conditions can lead to fire or electric shock.

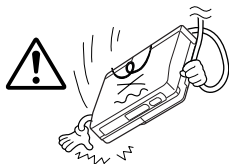

DO NOT place heavy objects on the AC power adapters cords, or leave the cord near any heat-generating appliance, as this can damage the cords. Avoid excessive pulling or twisting of the power cords. If the power cords becomes cut or otherwise damaged, contact your JVC dealer. When unplugging the AC power adapter, DO NOT pull on the cord. Hold the plug itself and remove it from the AC outlet. Use of the printer with a damaged power cord can lead to fire, electric shock and unit malfunctions.

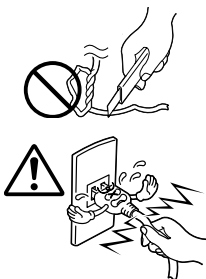

DO NOT remove the cover and attempt to repair or modify the printer. There are high-voltage components within the unit, and the risk of electric shock and unit malfunctions exists. If a problem occurs, contact your JVC dealer.

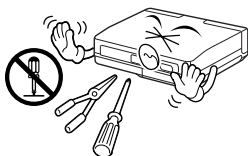

Illustrations of this printer may differ slightly from production models.

ABOUT THERMAL HEADS

- The thermal heads, necessary for printing, are located within the unit. The heads can become extremely warm. To prevent possible burns and injuries, do not touch the thermal heads.
- When the printer is used for extended periods, the thermal heads experience wear and tear just like VCR heads. As the thermal heads become worn, print quality will gradually decrease. When you notice a decline in quality, it is possible that the heads may need to be replaced. Consult your JVC dealer.

DUST

Due to dust or lint adhering to print paper, or to extreme variations in temperature, a small degree of colour smearing or lines may be visible in prints.

Failure to heed the following precautions may result in damage to the printer.

1. **DO NOT** place the printer . . .
 - ... in an environment prone to extreme temperatures or humidity.
 - ... in direct sunlight.
 - ... in a dusty environment.
 - ... in an environment where strong magnetic fields are generated.
 - ... on a surface that is unstable or subject to vibration.
2. **DO NOT** place heavy objects on the printer.
3. **DO NOT** place anything which might spill on top of the printer.
4. **AVOID** violent shocks to the printer during transport.

CAUTION:

Changes or modifications not approved by JVC could void user's authority to operate the equipment.

Battery Packs

The supplied battery pack is a lithium-ion battery. Before using the supplied battery pack or an optional battery pack, be sure to read the following cautions:

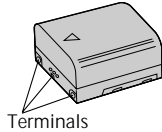

<Depleting the batteries completely>

1. Turn on the power.
 2. Set "power save" to "off" and remove the batteries when the power is automatically turned off.
1. **To avoid hazard . . .**
 - **do not** burn.
 - **do not** short-circuit the terminals.
 - **do not** modify or disassemble.
 - **do not** expose the battery to temperatures exceeding 60°C (140°F), as this may cause the battery to overheat, explode or catch fire.
 - use only specified chargers.
 2. **To prevent damage and prolong service life . . .**
 - **do not** subject to unnecessary shock.
 - charge in an environment where temperatures are within the tolerances shown in the chart below. This is a chemical reaction type battery—cooler temperatures impede chemical reaction, while warmer temperatures can prevent complete charging.
 - store in a cool, dry place. Extended exposure to high temperatures will increase natural discharge and shorten service life.
 - fully charge and then fully discharge the battery once a year when storing the battery pack over a long period time.
 - remove from charger or powered unit when not in use, as some machines use current even when switched off.

NOTES:

- *It is normal for the battery pack to be warm after charging, or after use.*
- Temperature Range Specifications**
- | | |
|-----------------|------------------------------|
| Charging | 10°C to 35°C (50°F to 95°F) |
| Operation | 0°C to 40°C (32°F to 104°F) |
| Storage | -10°C to 30°C (14°F to 86°F) |
- *Recharging time is based on room temperature of 20°C (68°F).*
 - *The lower the temperature, the longer recharging takes.*

About Batteries

DANGER! Do not attempt to take the batteries apart, or expose them to flame or excessive heat, as there is a risk of fire or explosion.

WARNING! Do not allow the battery terminals, or the battery itself, to come in contact with metals, as this can result in a short circuit and possibly start a fire.

The Benefits Of Lithium-Ion Batteries

Lithium-ion battery packs are small but possess a large power capacity. However, when the battery pack becomes cool in an environment subject to cold temperatures (below 10°C (50°F)), the battery pack has a characteristic that its usage time becomes shorter and may cease to function. If this happens, place the battery pack in your pocket or other warm, protected place for a short time, then re-attach it to the camcorder. As long as the battery pack itself is not cold, it should not affect performance.

(If you're using some kind of heating pad, make sure the battery pack does not come in direct contact with the pad.)

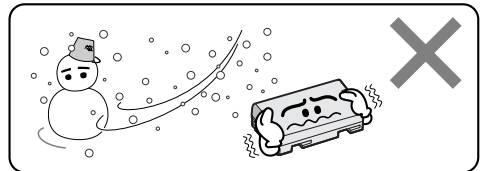

Lithium-ion is vulnerable in colder temperatures.

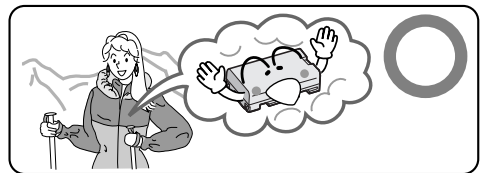

Serious malfunctioning

If malfunctioning occurs, stop using the unit immediately and consult your local JVC dealer.

The printer is a microcomputer-controlled device. External noise and interference (from a TV, a radio, etc.) might prevent it from functioning properly. In such cases, first disconnect its power supply unit (battery pack, AC Power Adapter/Battery Charger, etc.) and then reconnect it and proceed as usual from the beginning.

Declaration of Conformity

Model Number : GV-HT1U
Trade Name : JVC
Responsible party : US JVC CORP.
Address : 41 Slater Drive,
 Elmwood Park, N. J.
 07407
Telephone Number : (201) 794-3900

This device complies with Part 15 of FCC Rules. Operation is subject to the following two conditions:

(1) This device may not cause harmful interference, and (2) this device must accept any interference received, including interference that may cause undesired operation.

Change or modifications not approved by the party responsible for compliance could void the user's authority to operate the equipment. This equipment has been tested and found to comply with the limits for a Class B digital device, pursuant to Part 15 of the FCC Rules. These limits are designed to provide reasonable protection against harmful interference in a residential installation. This equipment generates, uses, and can radiate radio frequency energy and, if not installed and used in accordance with the instructions, may cause harmful interference to radio communications. However, there is no guarantee that interference will not occur in a particular installation. If this equipment does cause harmful interference to radio or television reception, which can be determined by turning the equipment off and on, the user is encouraged to try to correct the interference by one or more of the following measures:

- Reorient or relocate the receiving antenna.
- Increase the separation between the equipment and receiver.
- Connect the equipment into an outlet on a circuit different from that to which the receiver is connected.
- Consult the dealer or an experienced radio/TV technician for help.

This Class B digital apparatus complies with Canadian ICES-003.

Cet appareil numérique de la classe B est conforme à la norme NMB-003 du Canada.

When using the AC Power Adapter/Charger in areas other than the USA

- The provided AC Power Adapter/Charger features automatic voltage selection in the AC range from 110 V to 240 V.

USING HOUSEHOLD AC PLUG ADAPTER

In case of connecting the unit's power cord to an AC wall outlet other than American National Standard C73 series type use an AC plug adapter, called a "Siemens Plug", as shown.

For this AC plug adapter, consult your nearest JVC dealer.

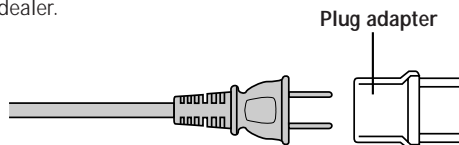

- This printer uses the following program under license from Okaya Systemware Co., Ltd. for IrDA infrared transmission:

IrDA Protocol Stack "Deep Core™" Okaya Systemware Co., Ltd.

NOTICE**Copyright**

Use of images imported from television broadcasts and recorded materials for other than personal enjoyment without permission from the copyright owner constitutes an infringement on applicable copyright laws.

Sample Images

The sample images supplied with this printer are used under license from Kodak Japan Co., Ltd. who is the copyright owner.

The image samples provided with this printer are Photo CD images from the Kodak Photo CD Sampler with FILM that were processed as described below using Adobe Photoshop 3.0J.

<Sample Image Data>

The original 768 x 512 image was trimmed to 598 x 448 and compressed using the JPEG format before recording.

<Source of Images>

Kodak Photo CD Sampler with FILM No. 2
 "Marine" 18

Note:

- Note that prints of camcorder or Digital Still Camera images will not be as sharp as prints of the sample images.
- Company names and product names mentioned in this manual are the logos or registered trademarks of respective company.

This equipment is a portable printer that is light enough to bring along with a camcorder or digital still camera on a trip or outing. It can be used in a wide variety of applications.

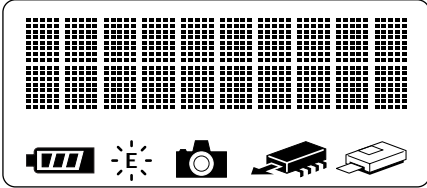

Easy to read LCD Display

The messages and icons displayed on the LCD panel show at a glance the operating state of the printer.

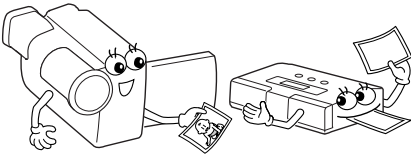

Printing from Camcorder

Any camcorder with an output terminal can be connected to the printer for instant printing of the desired photo anywhere.



Cordless connection to digital still cameras

This printer offers cordless connection to any digital still camera conforming to the infrared image transmission (IrTran-P) standard.

Battery powered for portable operation

Load the battery and you are ready to provide your friends with instant printouts of pictures taken at parties or outdoors.

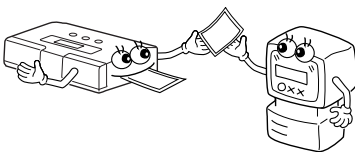

Input for PC Connection

Used with optional software, this printer connects to a Windows® PC communications port (RS-232C) or Macintosh communications port (RS-422) for printing images.

You can print the picture of your choice on standard paper, stickers.
A number of special effects are available in addition to normal printing.

Multipix

On a page you can print 2, 6 or 8 images.

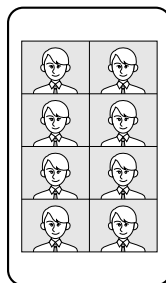
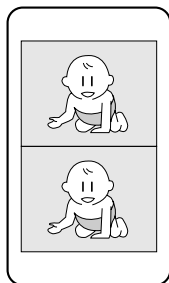

Calendar Printing

You can use pictures of your choice to print your own calendar.



Frame Print

Internal frames can be superimposed on an image for printing stickers.

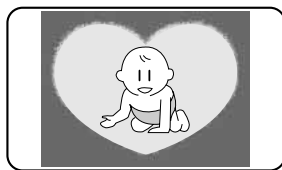

CAUTIONS	5
MAJOR FEATURES	8
CONTROLS, INDICATORS AND CONNECTORS	12
Front View	12
Rear View	13
Bottom View	13
Operation buttons	14
Memory and Print Operations	14
Selecting and setting menu items	14
Menu Setting List	15
CONNECTIONS (Video Connections)	16
Printing from source with video output terminals	16
CONNECTIONS (IrDA Reception)	17
Printing from a digital still camera with IrTran-P	17
SUPPLYING THE POWER	18
Charging the Battery	18
Loading the Battery	19
Using AC power	19
INSTALLATION OF INK CASSETTE	20
Installing the Ink cassette	20
LOADING THE BLANK PAPER	22
Loading Blank Paper	22
PREPARATION	23
PRINTING FROM VIDEO SOURCE WITH VIDEO TERMINALS	24
PRINTING FROM IrTran-P EQUIPPED DIGITAL STILL CAMERA	26
MISCELLANEOUS PRINTING OPERATIONS	28
Superimposing the Frame of Choice on the Image – Frame Printing –	28
Printing Multiple Images on the Same Paper – MULTI Print –	30
Combining Image and Calendar – Calendar Printing –	32
Printing Using Special Effects – Special Effects –	34
Manual Feed	36
Printing Reversed Images – Mirror Images –	38

ADJUSTMENTS	39
Adjusting Image Quality – Adjustments before Printing –	39
Saving Energy – Power Save –	40
Switching between Moving Picture and Still Picture – Memory Mode Selections – ...	41
TROUBLESHOOTING	42
PRINTING FROM THE PERSONAL COMPUTER	45
SPECIFICATIONS	46
INDEX	47
FOR SERVICING (Only in U.S.A.)	48
WARRANTY (Only in U.S.A.)	49

PROVIDED ACCESSORIES

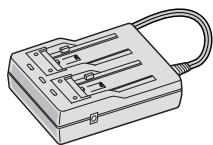

AC adapter/Charger AA-V68



DC cord,
approx. 0.8 m

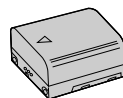

Battery Pack BN-V607



Video cable 1



Video cable 2

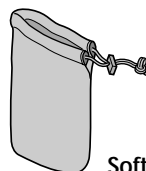

Soft case

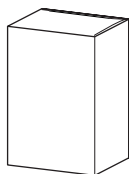

Blank Paper Sheet Set

- Standard Print Paper (6 sheets)
- Sticker paper (6 sheets)
- Ink Cassette (12 prints)

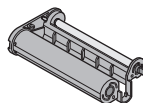

Ink cassette

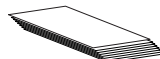

Printing paper

It should be noted that it may be unlawful to print from pre-recorded tapes or discs without the consent of the owner of copyright in the video recording, broadcast or cable programme and in any literary, dramatic, musical, or artistic work embodied therein.

Front View

MENU Button
Turns menu items on and off.

MEMORY/SELECT Button
MEMORY Button
Press to store an input image.
SELECT Button
Selects menu items.

PRINT/SET Button
PRINT Button
Press this button after storing an image to print it.
SET Button
Press to change setup items.

LCD Panel

Displays messages and icons during operation to indicate printer operating status.

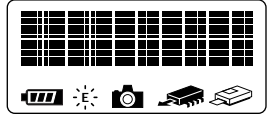

Display	Function	See page
	Message field Indicates menu settings and printer status.	15, 42
	Indicates remaining battery power.	-
	Lights when a print error has occurred. The message field indicates the nature of the error.	43
	Lights when still image memory mode has been selected.	41
	Lights to indicate that an image has been stored in the printer.	25
	Lights during printing.	25

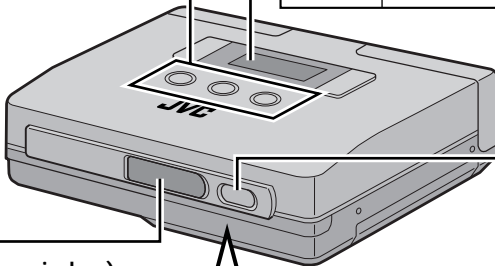

POWER Button
Turns the printer on and off.

IrTran-P (IrDA receiving window)
Receives image data during infrared transmission.

Video input jack
Connects a video cable from the video output terminal on camcorder or other unit.

PC connection jack
With the use of optional software, the printer can be connected to a communications port on a PC compatible (RS-232C) or Macintosh (RS-422).

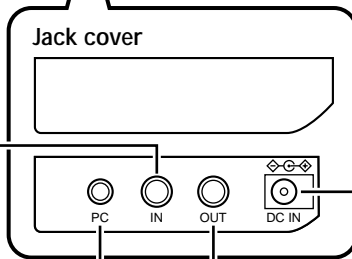

DC IN
Connects AC Adapter/Charger by using a DC cord (provided).

Video output jack

- Outputs input image or print image for viewing on a TV or other monitor.
- Connect this output to a video input terminal on a TV.

Rear View

Battery compartment

Open the lid to load or remove battery.

Paper out/manual feed slot

- Finished prints are ejected from this exit.
- Single sheets of paper are inserted here during manual feed.

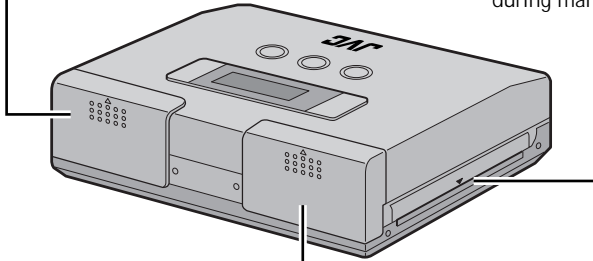

Ink cassette compartment

Open the lid to load or remove ink cassette.

Bottom View

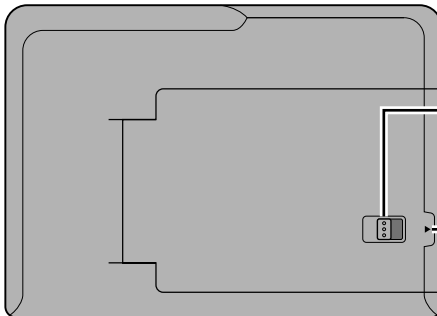

Paper compartment door switch

Slide this switch to open the paper compartment.

Paper compartment door

Open this door to load paper.



● Operation buttons

Use these buttons to perform operations from storing to printing images, selecting and setting menu items.

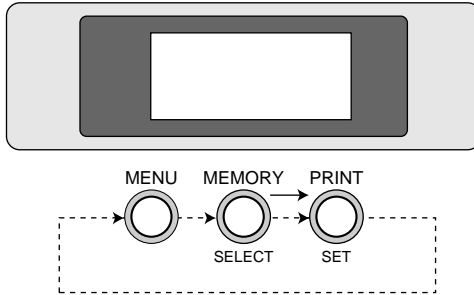



Use the buttons and follow the instructions given on the LCD panel.



● Memory and Print Operations

Mode overview		See page
MEMORY 	· Press to store input video image.	25
PRINT 	· Press to print stored video image.	25

● Selecting and setting menu items

Mode overview		See page
MENU 	· Turns menus on and off. · Press once to select a menu.	24
 SELECT	· Each press of the SELECT button displays a menu item on the LCD panel. · Select desired item.	24
 SET ↓  MENU	· Press the SET button and the Selected mode indicator blinks. · Each press of the SET button changes the blinking item on the LCD panel. Select the desired item. · Press the MENU button after selecting the desired item with the SET button to confirm the selection.	24

● Menu Setting List

Desired Action	Menu item	Setting				
Set video source · Print sample · Superimpose frame list	input	→ video → infrared → PC ——— ↳ sample → frame list ———				
Superimpose frame	frame set.	→ off → frame 1 → frame 2 → frame 3 ——— ↳ frame 4 → frame 5 → frame 6 ——— ↳ frame 7 → frame 8 → frame 9 ———				
Enter print mode	print mode	→ standard → multi-2 → multi-6 ——— ↳ multi-8 → calendar ———				
Add special print effect	effect	→ off → sepia → B/W ———				
Adjust brightness or tint · adjust before storing the image	adj. image	<table border="1"> <tr> <td>tint</td> <td>0 +1, +2, +3, +4, +5 -1, -2, -3, -4, -5</td> </tr> <tr> <td>bright.</td> <td></td> </tr> </table>	tint	0 +1, +2, +3, +4, +5 -1, -2, -3, -4, -5	bright.	
tint	0 +1, +2, +3, +4, +5 -1, -2, -3, -4, -5					
bright.						
Suppress blur	mem. mode	moving pic ↔ still pic				
Manual feed print	man. feed	off ↔ on				
Print mirror image	mirror	off ↔ on				
Save energy	power save	5min. ↔ off				
Remove jammed paper	form feed	off ↔ on				
Switch monitor display	monitor	input pic. ↔ mem. pic.				

- Initial settings are indicated in gray.
The printer returns to these settings when powered up after shutdown.
- Menu items that cannot be selected are not displayed.
- A sample video image is stored in the printer. You can select "sample" to print out this sample in the "input" menu.

Printing from source with video output terminals

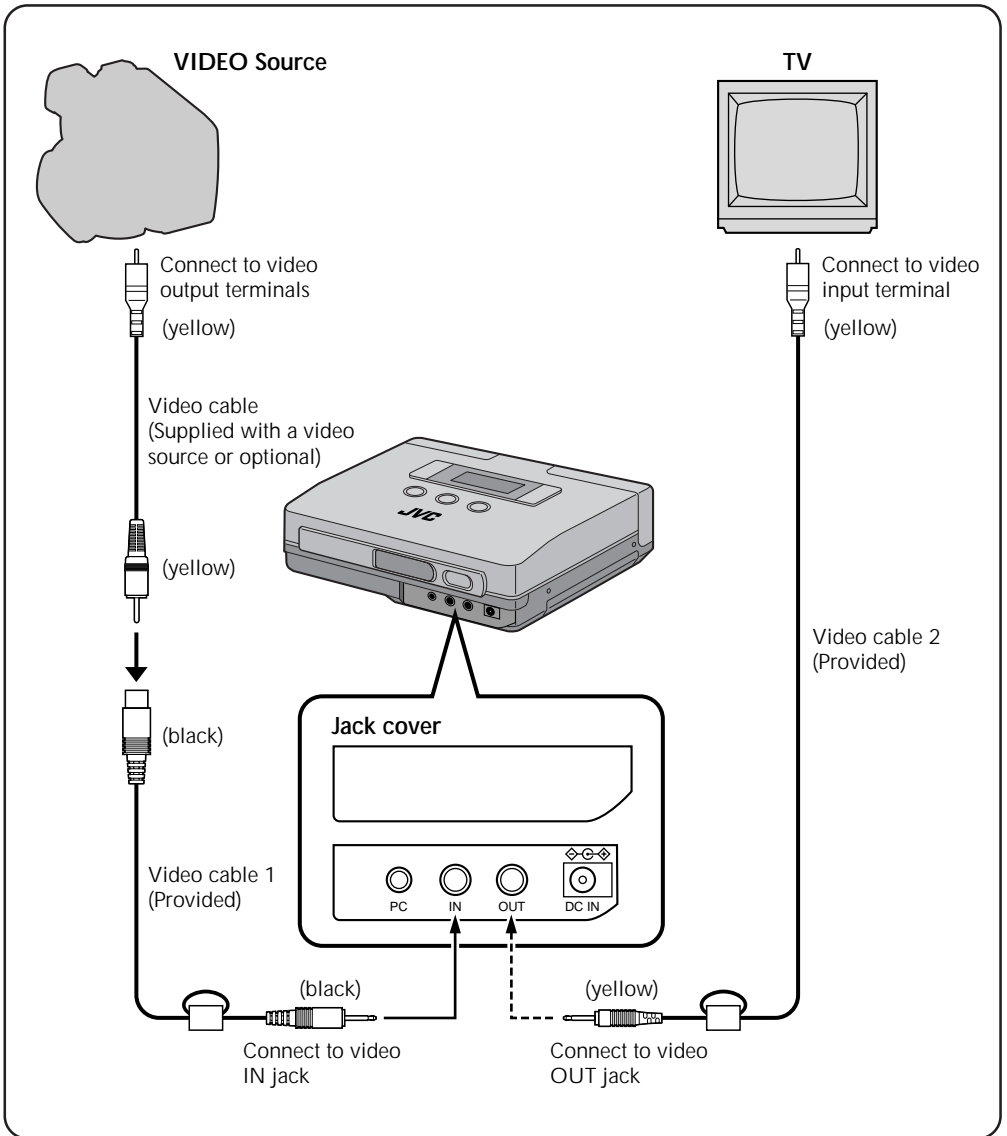

- Notes:**
- Make sure that the printer is properly connected to the video source. A loose video cable connection will prevent printing.
 - Do not place the printer on its side or on a leaning surface as this may cause paper jams.

Printing from a Digital Still Camera with IrTran-P

This is a standard for transmitting data using infrared transmission. Equipment that conform to this standard can transmit to each other regardless of make.

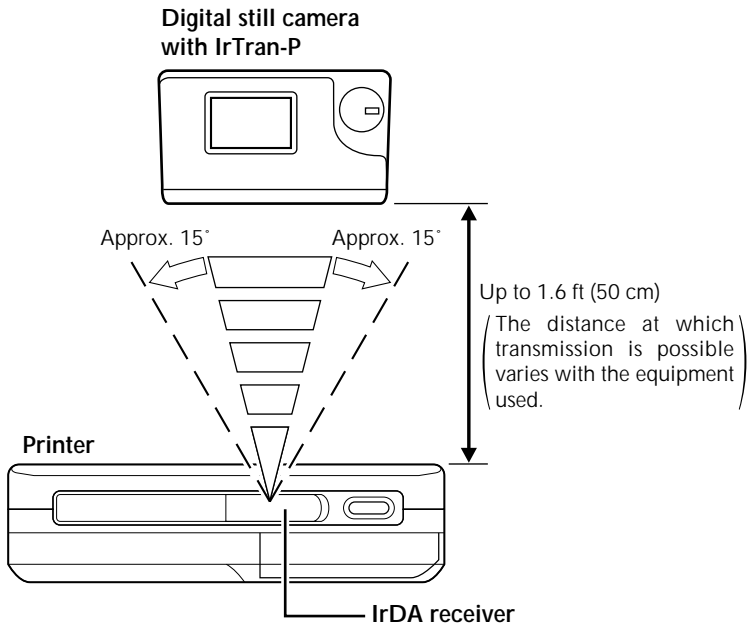

- Notes:**
- IrDA infrared communications allow only two pieces of equipment to communicate. Transmission from one digital still camera to several printers simultaneously is not possible. Only the printer that first receives the data can print it.
 - Transmission may become unstable or impossible due to external light, the state of battery depletion and the distance or angle between the equipment.

Charging the battery

Use the provided AA-V68 AC adapter/Charger for charging the battery. Batteries that have not been completely depleted can also be charged.

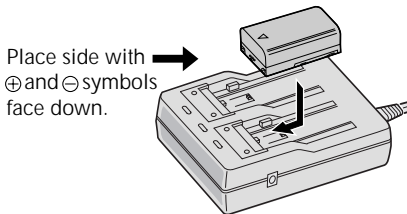
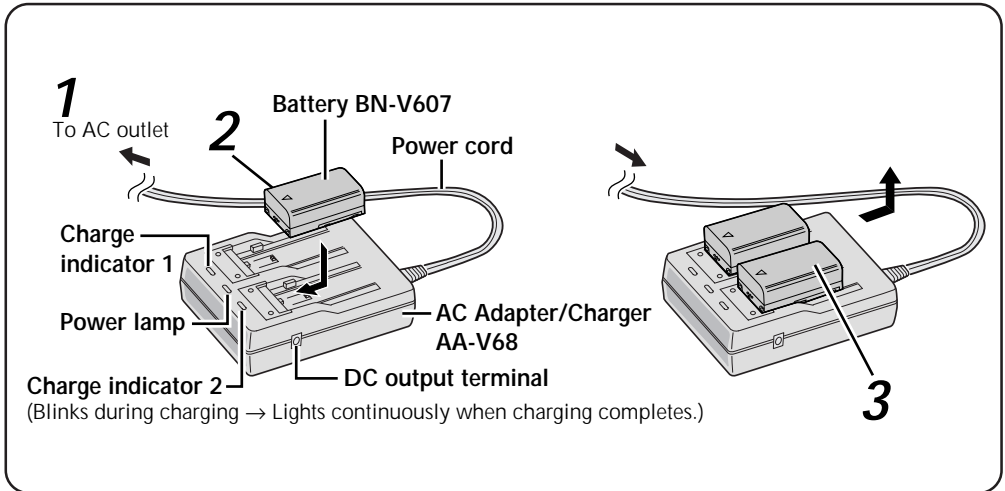

1 CONNECT AC ADAPTER/CHARGER

- Connect the power cord to a wall outlet.

2 INSERT THE BATTERY

- The charge indicator starts to blink.
- Charging has completed when the indicator stops blinking and is on continuously.

3 REMOVE THE BATTERY

- Remove the power cord.

- Approximate charge time → Approx. 90 min for each BN-V607 battery
- Charging not possible → Charging is not possible when the DC cord is connected to the AC adapter.
- Number of prints per battery charge → 40 prints for each BN-V607 battery (at room temperature)

NOTES:

- If you connect the DC cord to the AC adapter during battery charging, power is supplied to the printer and charging stops.
- When charging the Battery for the first time or after a long storage period, the Charger Indicator may not light. In this case, remove the Battery from the AC Power Adapter then try charging again.
- Since the AC Power Adapter processes electricity internally, it becomes warm during use. Be sure to use it only in well-ventilated areas.
- If the battery operation time remains extremely short even after having been fully charged, the battery is worn out and needs to be replaced. Please purchase a new one.

Loading the Battery

The battery (BN-V607) is not charged when shipped. Charge it using the AC adapter before use.

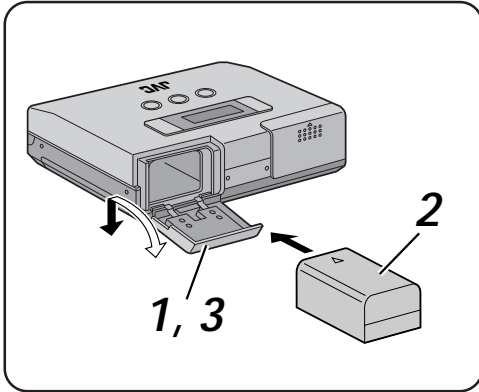

1 OPEN THE BATTERY COMPARTMENT LID

- Slide and open the battery compartment lid in the direction of the arrow.

2 INSERT THE CHARGED BATTERY

- Note that the battery may be damaged if it is inserted incorrectly.
- Slide in the battery as far as it will go until it is properly seated.

3 CLOSE THE BATTERY COMPARTMENT LID

Using AC power

When using the printer indoors, you can use the AC Adapter instead of a battery.

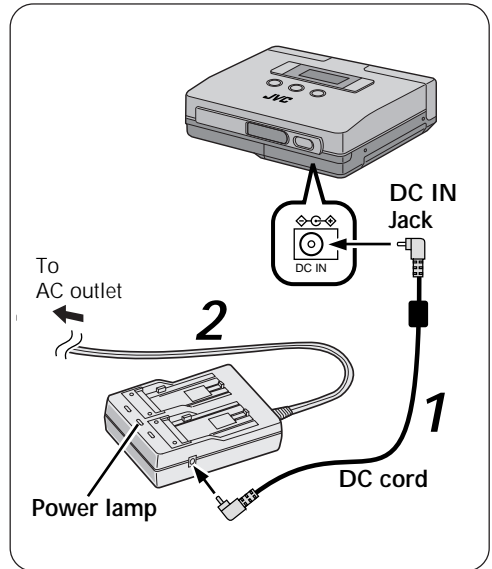

1 CONNECT DC CORD

- Connect the DC cord to the AC Adapter then to the printer.

2 SUPPLY AC POWER

- Connect the power cord to an AC outlet.

NOTE:

When using the provided DC cord, make sure you connect the end of the cable with the core filter to the printer. The core filter reduces the interference.

Removing the Battery

- Open the battery compartment lid and take out the battery.

Installing the Ink cassette

Before printing, load printing paper and ink kit as shown below.

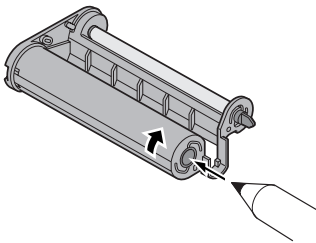
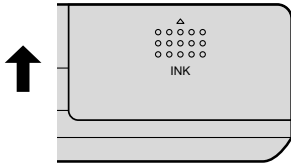
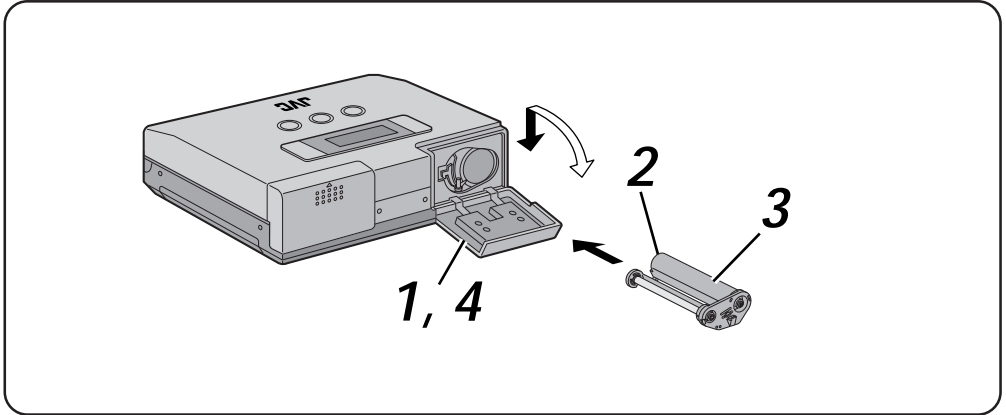

1 OPENING INK CASSETTE COMPARTMENT LID

- To open the ink cassette compartment lid, slide it in the direction of the arrow as far as it will go.

2 REMOVING SLACK IN THE INK RIBBON, IF ANY

- Insert a ball-point pen or the like and rotate the roller in the indicated direction.

3 INSTALLING INK CASSETTE

- Hold the side with model label face up and slide in the ink cassette as far as it will go.

4 CLOSE THE INK CASSETTE COMPARTMENT LID

When removing ink cassette

- Grasp the knob at the center of the ink cassette and pull it towards you.

CAUTION:

Do not touch the inside of the ink cassette compartment to avoid burns and other injuries.

About blank Paper sheet Set (optional)

One of the following accessories is required in printing with this printer.

SET	CONTENTS	USES
PV-C20AU (Standard type)	Standard paper: 20 sheets Ink cassette (20 prints)	To print the scene of your choice to make commemorative shots.
PV-C12SAU (Sticker type)	Sticker paper: 12 sheets Ink cassette (12 prints)	Make personalized stickers for pasting on cards, etc.
PV-C12KAU (Standard type, Sticker type)	Standard paper: 6 sheets Sticker paper: 6 sheets Ink cassette (12 prints)	Make personalized stickers for pasting on cards, etc.

Note: Pay attention to the following in handling printing paper and ink cassettes

Before printing

- Do not use printing paper that has been folded or curled to avoid paper jams.
- Do not use wet or humid printing paper as it will not print normally and could cause a paper jam.
- Do not touch or write on the print surface.
- Do not touch or pull out the ink sheets in the ink cassette.
- Make sure that children do not lick or ingest the ink sheets.
- Used ink cassettes should be replaced with new cartridges.
Old cartridges cannot be reused. Do not attempt to reuse the cartridge by rewinding the rollers.
- Printing paper and ink cassettes must not be stored in a location exposed to high temperatures, high humidity or direct sunlight.
- Read the instructions accompanying the printing paper and ink cassette and use them accordingly.

After printing

- The printer applies a coating to make the prints glossy.
- The prints should be handled with care since they are coated with a soft material that can easily be damaged by sharp objects such as a fingernail or the like.
- The colors will fade if the paper is exposed to volatile solvents (alcohol, toluene, ketone, etc.).
- Do not paste adhesive tape on the print surface. The image will be damaged when the tape is removed.

Care in storing prints

- Printed paper must not be stored in a location exposed to high temperatures, high humidity or direct sunlight.
- Store printing paper horizontally in the box. If stored vertically, the paper might curl and cause paper jams.

Loading Blank Paper

To print, load Blank paper sheet set.

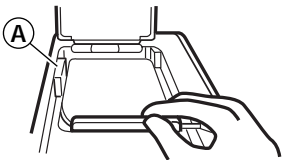
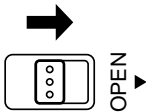
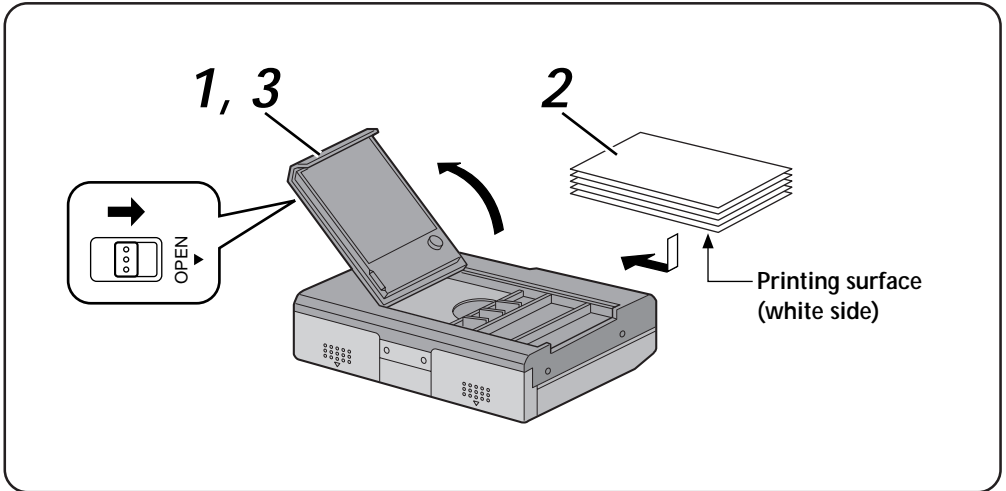

Notes:

- Make sure that the paper does not rise above tab **A**.
- Place the side with the text face up.
- Number of sheets: max. 15 sheets

1 OPEN PAPER COMPARTMENT DOOR

- Slide the paper compartment door switch in the direction of the arrow to open the paper compartment door.

2 LOAD BLANK PAPER

- Riffle through the paper so that each sheet is separated from the next and place it with the printing surface (white side) facing inside.
- Make sure that the paper does not rise above tab **A**.

3 CLOSE THE PAPER COMPARTMENT DOOR

- Make sure that the paper has been correctly loaded.
- The door clicks into place when the door is properly closed.

Notes: • Read the instructions on the printing paper and ink kit, and the "Caution on Loading Printing Paper" on the inside of the printing paper compartment.

• Loading printing paper

Since the paper cannot be properly fed if each sheet sticks together, riffle through the paper before loading it and make sure that the paper ends are aligned.

If the message, "Insert paper" is displayed when there is paper in the paper compartment, reload the paper.

- Before printing, make sure everything is set up and ready.

1. Connect the printer to the video source to be printed from. (☞pg. 16).

- To use IrTran-P, transmit the images after turning on the power as described in step 5.



2. Have a Blank Paper Sheet Set ready (☞pg. 21).



3. Install the ink cassette in the printer (☞pg. 20).



4. Open the paper compartment door and place the printing paper (☞pg. 22).

- Use the printing paper in the same box as the ink cassette.



5. Turn on the power. (☞pg. 12).

- Insert the power plug of the AC adapter in a wall outlet.
- The printer can also be battery powered.
- Turn on the printer.

Notes:

- The above completes all printer preparations.
- Please read the instructions on pages 24 to 41 before printing.

This is the standard method for printing from a video source with video terminals. It allows you to easily connect your Camcorder, VCR or other video source with video terminals to the printer.

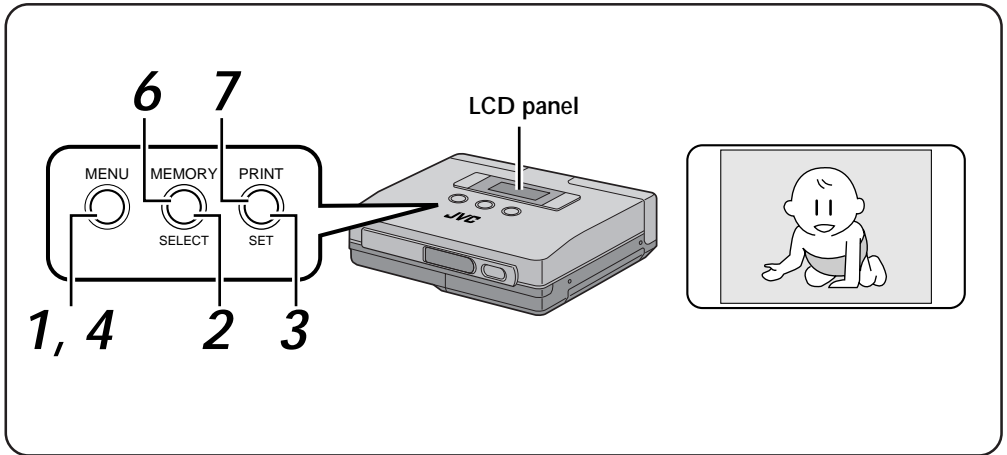

Preparations

- Make the connections (see pg. 16).

Selecting Menu Item

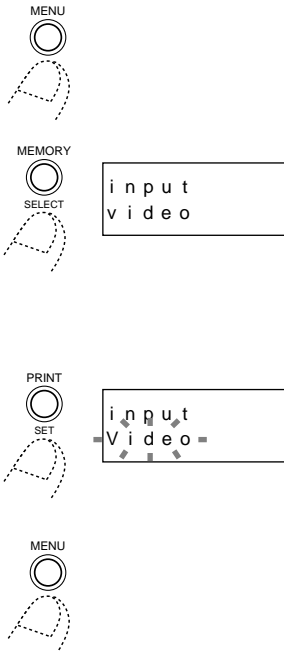

1 PRESS THE MENU BUTTON

- This action displays the printer menu on the LCD panel.

2 PRESS THE SELECT BUTTON

- Press the SELECT button repeatedly until "input" appears.

Note:

When "video" is already displayed on the LCD panel, press the MENU button and skip steps 3 and 4.

3 PRESS THE SET BUTTON

- The item on the second line of the LCD panel starts to flash.
- Press the SET button until "video" appears.

4 PRESS THE MENU BUTTON TWICE TO CONFIRM THE ENTRY

Print Operations

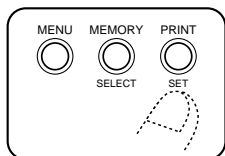
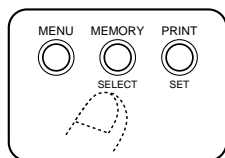
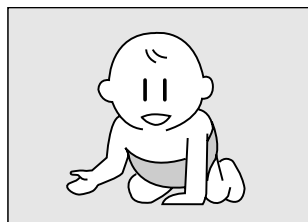

5 SET THE VIDEO SOURCE TO PLAY-BACK MODE

- For details, refer to the instruction manual supplied with the video source.



6 PRESS THE MEMORY BUTTON WHEN THE IMAGE YOU WISH TO PRINT APPEARS

- This action stores the image you wish to print.
- The message, "Please wait ..." is displayed on the LCD panel while the image is being stored. The message, "Store in memory" is displayed when the image has been stored.
- The memory icon  indicates the following conditions.

on: image data has been stored in the printer

off: no image data is stored in the printer

7 PRESS THE PRINT BUTTON

- The printer starts printing the stored image.
- The message, "Please wait ..." is displayed on the LCD.
- Then the printer icon  appears.
- The printer icon  indicates the following conditions.
- **on:** image data is being printed
- **off:** printing has been completed
- When printing is completed, the message, "Remove paper" is displayed on the LCD panel.

Do not touch the printer or printing paper until this message is displayed.

NOTES:

- To print the same image again, press the PRINT button. One print is made each time the PRINT button is pressed.
- To print a different image, perform operations in steps 5 to 7.
- To store the picture again before printing, switch menu item "monitor" from "mem. pic" to "input pic."
- Do not touch the printer or the paper during printing
During printing paper will come out of the paper out/manual feed slot; do not touch the paper until printing stops to prevent paper jams.
Do not open the paper compartment door or the ink cassette compartment lid during printing. When the printer is battery powered, do not open the battery compartment door. If opened, printing stops and the power is automatically turned off. When the printer is powered up again, the paper that was being printed when printing stopped is ejected.

The printer can receive and print images from an IrTran-P equipped digital still camera. Since no cables are required, this printing method is ideal at wedding receptions, parties or the like.

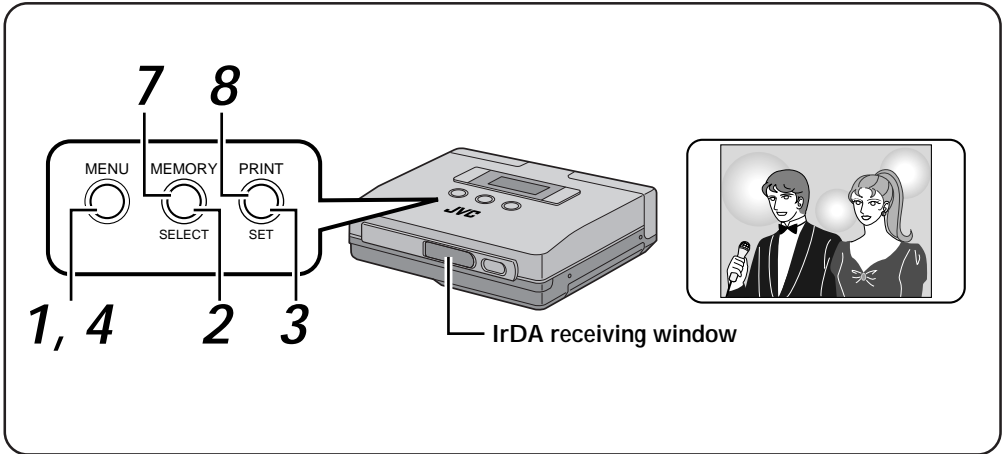

Preparations

- Make the connections (pg. 17).
- Place the digital still camera and printer within a 1.6 ft (50 cm) distance of each other. Image transmission can be performed within a 15° angle of the printer receiving window.
- Read the instructions in the instruction manual supplied with the IrTran-P equipped digital still camera.

Selecting Menu Item

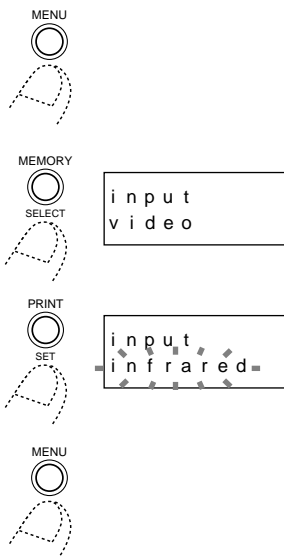

1 PRESS THE MENU BUTTON

- This action displays the printer menu on the LCD panel.

2 PRESS THE SELECT BUTTON

- Press the SELECT button repeatedly until "input" appears.

3 PRESS THE SET BUTTON

- The item on the second line of the LCD panel starts to blink.
- Press the SET button until "infrared" appears.

4 PRESS THE MENU BUTTON TWICE TO CONFIRM THE ENTRY

Digital Still Camera Operations



Note:

Transmission may become unstable or impossible due to external light, the state of battery depletion and the distance or angle between the equipment.

5 SELECT THE DIGITAL STILL CAMERA IMAGE YOU WISH TO PRINT

- For details, refer to the instruction manual supplied with the camera.

6 TRANSFER THE CAMERA IMAGE TO THE PRINTER

- Orient the infrared sending window on the digital still camera so that it faces the IrTran-P receiving window on the printer.
- Make sure that there are no objects between the printer and the camera.
- Transmit the data from the camera to the printer.

Print Operations

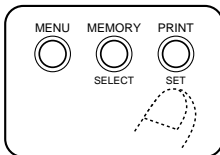



NOTES:

- To print the same image again, press the PRINT button. One print is made each time the PRINT button is pressed.
- To print a different image, press the MEMORY button to clear the stored image and perform operations in steps 5 to 8.

7 THE PRINTER STARTS RECEIVING THE IMAGE

- The image you wish to print is now being stored.
- While the image data is being stored, the message, "infrared receiving" is displayed on the LCD panel.
- The memory icon  indicates the following conditions.
 - on:** image data has been stored in the printer
 - off:** no image data is stored in the printer

8 PRESS THE PRINT BUTTON

- The printer starts printing the stored image.
- The message, "Please wait ..." is displayed on the LCD panel. Then the printer icon  appears.
- The printer icon  indicates the following conditions.
 - on:** image data is being printed
 - off:** printing has been completed

Superimposing the Frame of Choice on the Image - Frame Printing -

- You can print a frame around an image.
- Select one frame you wish to use out of the nine available frames. You can use sticker paper to print titles for greeting cards and so on.

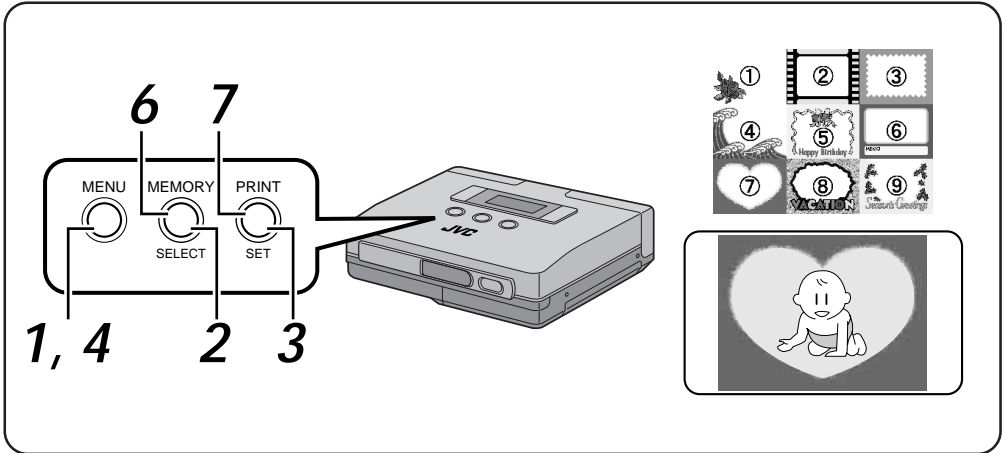

Preparations

- Make the connections (see pg. 16).

Selecting Menu Item

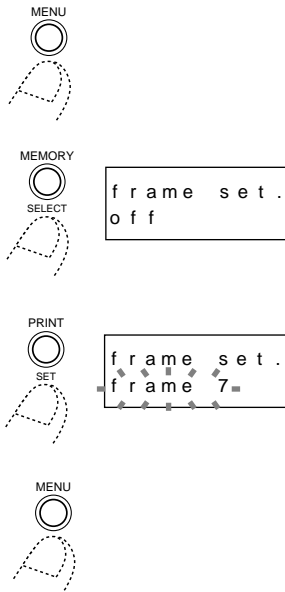

1 PRESS THE MENU BUTTON

- This action displays the printer menu on the LCD panel.

2 PRESS THE SELECT BUTTON

- Press the SELECT button repeatedly until "frame set." appears.

3 PRESS THE SET BUTTON

- The item on the second line of the LCD panel starts to blinking.
- Press the SET button until the desired frame number appears.

4 PRESS THE MENU BUTTON TWICE TO CONFIRM THE ENTRY

Print Operations

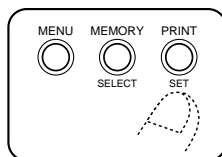
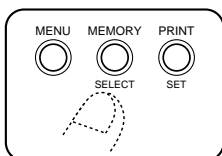
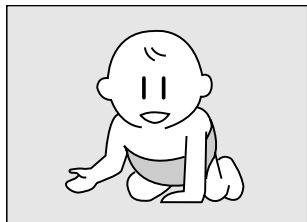



5 SET THE VIDEO SOURCE TO PLAY-BACK MODE

- For details, refer to the instruction manual supplied with the video source.

6 PRESS THE MEMORY BUTTON WHEN THE IMAGE YOU WISH TO PRINT APPEARS

- This action stores the image you wish to print.
- The message, "Please wait ..." is displayed on the LCD panel while the image is being stored.
- The memory icon  indicates the following conditions.
 - on:** image data has been stored in the printer
 - off:** no image data is stored in the printer

7 PRESS THE PRINT BUTTON

- The printer starts printing the stored image.
- The message, "Please wait ..." is displayed on the LCD panel. Then the printer icon  appears.
- The printer icon  indicates the following conditions.
 - on:** image data is being printed
 - off:** printing has been completed

NOTES:

- To print the same image again, press the PRINT button. One print is made each time the PRINT button is pressed.
- To print a different image, perform operations in steps 5 to 7.
- The frame cannot be changed after printing.
- When the "input" menu item is displayed (see page 15), you can select "frame list" and print all 9 frames. This makes it easier to select a frame.

Printing Multiple Images on the Same Paper – MULTI Print –

You can print 2, 6 or up to 8 images on a single paper.

This makes it easy to customize printing to suit the application.

You can use sticker paper to print titles for season's greetings and so on.

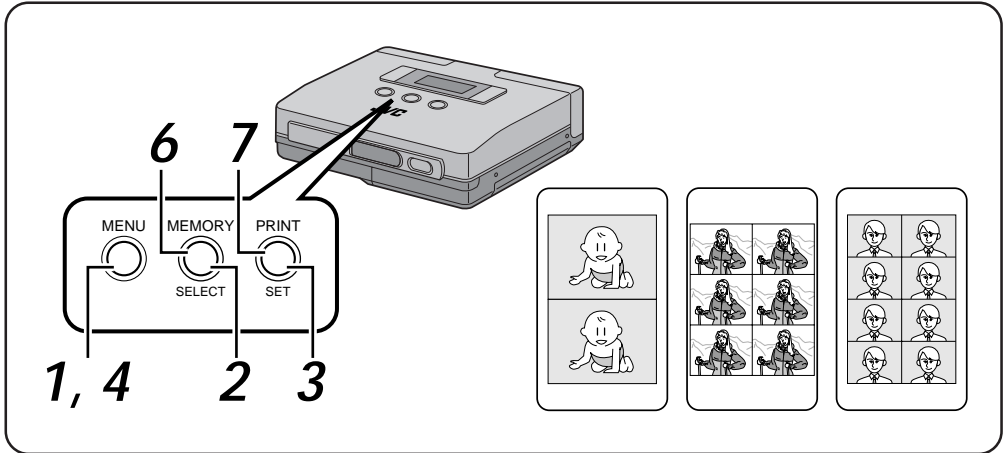

Preparations

- Make the connections (☞ pg. 16).

Selecting Menu Item

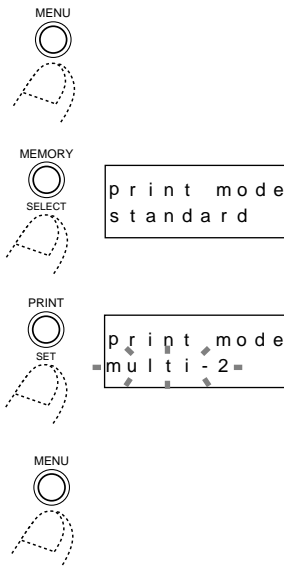

1 PRESS THE MENU BUTTON

- This action displays the printer menu on the LCD panel.

2 PRESS THE SELECT BUTTON

- Press the SELECT button repeatedly until "print mode" appears.

3 PRESS THE SET BUTTON

- The item on the second line of the LCD panel starts to blink.
- Press the SET button until the desired number of images appears.

4 PRESS THE MENU BUTTON TWICE TO CONFIRM THE ENTRY

Print Operations

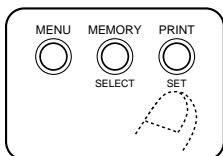
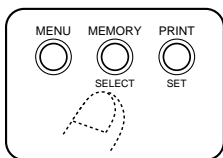
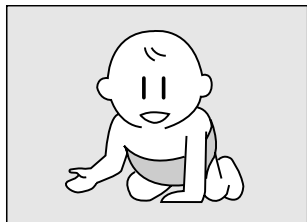



5 SET THE VIDEO SOURCE TO PLAY-BACK MODE

- For details, refer to the instruction manual supplied with the video source.

6 PRESS THE MEMORY BUTTON WHEN THE IMAGE YOU WISH TO PRINT APPEARS

- This action stores the image you wish to print.
- The image stored in memory is displayed in the selected number of multiple images.
- The message, "Please wait ..." is displayed on the LCD panel while the image is being stored.
- The memory icon  indicates the following conditions.
 - on:** image data has been stored in the printer
 - off:** no image data is stored in the printer

7 PRESS THE PRINT BUTTON

- The printer starts printing the stored image.
- The message, "Please wait ..." is displayed on the LCD panel. Then the printer icon  appears.
- The printer icon  indicates the following conditions.
 - on:** image data is being printed
 - off:** printing has been completed

NOTES:

- To print the same image again, press the PRINT button. One print is made each time the PRINT button is pressed.
- To print a different image, perform operations in steps 5 to 7.
- The multipix setting cannot be changed after printing.
- On a TV screen, multipix images are displayed horizontally across the screen.

Combining Image and Calendar – Calendar Printing –

You can turn your favorite picture into a calendar.

Month

- 1 : January
- 2 : February
- 3 : March
- 4 : April
- 5 : May
- 6 : June
- 7 : July
- 8 : August
- 9 : September
- 10 : October
- 11 : November
- 12 : December

Year

1	2	1998				
SUN	MON	TUE	WED	THU	FRI	SAT
6	7	8	9	10	11	12
13	14	15	16	17	18	19
20	21	22	23	24	25	26
27	28	29	30	31		

Preparations

- Make the connections (☞ pg. 16).

Selecting Menu Item

1 PRESS THE MENU BUTTON

- This action displays the printer menu on the LCD panel.

2 PRESS THE SELECT BUTTON

- Press the SELECT button repeatedly until "print mode" appears.

3 PRESS THE SET BUTTON

- The item on the second line of the LCD panel starts to blink.
- Press the SET button until the "calendar" appears on the LCD panel.
- Do as follows to change calendar years and months.
 - Press the SELECT button when "calendar" blinks.
 - Press the SET button repeatedly until the desired year appears on the LCD panel. Years between 1998 and 2007 can be selected.
 - Press the SELECT button.
 - Press the SET button repeatedly until the desired month appears on the LCD panel. The months are displayed on the LCD panel as the figures 1 to 12 (for January to December).
 - Press the MENU button to confirm the entry.

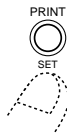
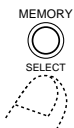

```
print mode
standard
```

```
print mode
calendar
```

```
year 1998
month 1
```

```
year 1998
month 12
```

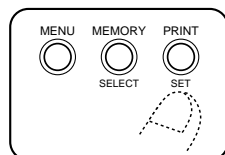
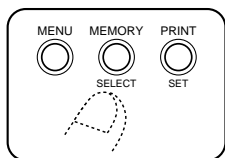
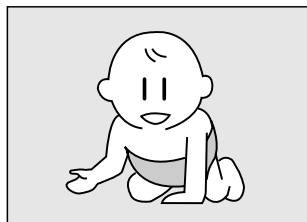
4 PRESS THE MENU BUTTON TWICE TO CONFIRM THE ENTRY

- When entering the year and month in step 3, press the MENU button only once.

Print Operations



5 SET THE VIDEO SOURCE TO PLAY-BACK MODE

- For details, refer to the supplied instruction manual.

6 PRESS THE MEMORY BUTTON WHEN THE IMAGE YOU WISH TO PRINT APPEARS

- This action stores the image you wish to print.
- The message, "Please wait ..." is displayed on the LCD panel while the image is being stored.
- The memory icon  indicates the following conditions.
 - on:** image data has been stored in the printer
 - off:** no image data is stored in the printer

7 PRESS THE PRINT BUTTON

- The printer starts printing the stored image.
- The message, "Please wait ..." is displayed on the LCD panel.
 - Then the printer icon  appears.
- The printer icon  indicates the following conditions.
 - on:** image data is being printed
 - off:** printing has been completed

NOTES:

- The frame printing (pg. 28) is not available in the calendar printing mode.
- To print the same image again, press the PRINT button. One print is made each time the PRINT button is pressed.
- To print a different image, perform operations in steps 5 to 7.
- On a TV screen, the images are displayed horizontally across the screen.

Printing Using Special Effects – Special Effects –

You can print an image in “sepia” or “black and white”.

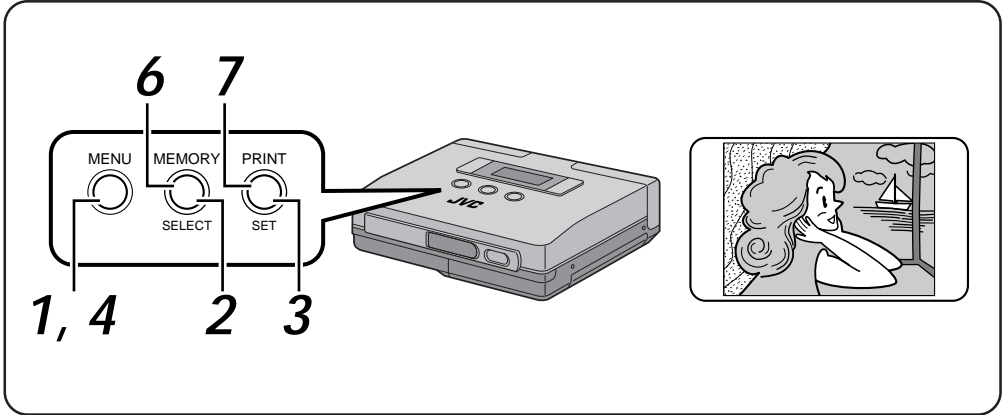

Preparations

- Make the connections (☞ pg. 16).

Selecting Menu Item

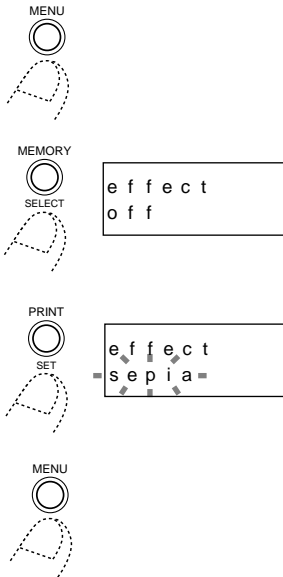

1 PRESS THE MENU BUTTON

- This action displays the printer menu on the LCD panel.

2 PRESS THE SELECT BUTTON

- Press the SELECT button repeatedly until “effect” appears.

3 PRESS THE SET BUTTON

- The item on the second line of the LCD panel starts to blink.
- Press the SET button repeatedly until “sepia” or “B/W” appears.

4 PRESS THE MENU BUTTON TWICE TO CONFIRM THE ENTRY

Notes:

- When “sepia” is selected, the image is printed in sepia-tinted (reddish-brown) monochrome like an old faded photograph.
- When “B/W” is selected, the image is printed in black and white.
- The special effect appears only in the printed image, while the image on the monitor is displayed in color.

Print Operations

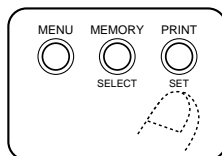
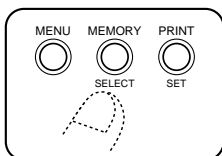

5 SET THE VIDEO SOURCE TO PLAY-BACK MODE

- For details, refer to the instruction manual supplied with the video source.

6 PRESS THE MEMORY BUTTON WHEN THE IMAGE YOU WISH TO PRINT APPEARS

- This action stores the image you wish to print.
- The message, "Please wait ..." is displayed on the LCD panel while the image is being stored.

- The memory icon  indicates the following conditions.

on: image data has been stored in the printer
off: no image data is stored in the printer

7 PRESS THE PRINT BUTTON

- The printer starts printing the stored image.
- The message, "Please wait ..." is displayed on the LCD panel. Then the printer icon  appears.

- The printer icon  indicates the following conditions.

on: image data is being printed
off: printing has been completed

- The image is printed using the selected special effect.

NOTES:

- To print the same image again, press the PRINT button. One print is made each time the PRINT button is pressed.
- To print a different image, perform operations in steps 5 to 7.
- The settings cannot be changed when printing is completed. To change settings, store an image into a memory again.

Manual Feed

This function allows you to print one page at a time using manual feed.

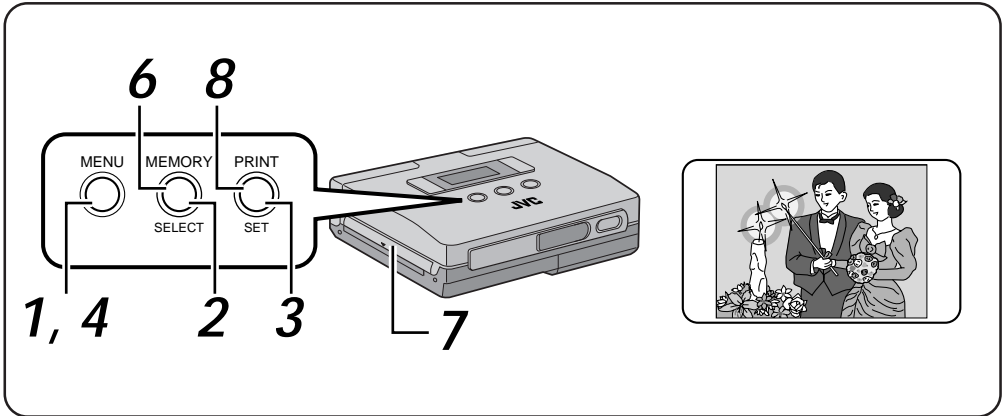

Preparation

- Make the connections (☞ pg. 16).

Selecting Menu Item

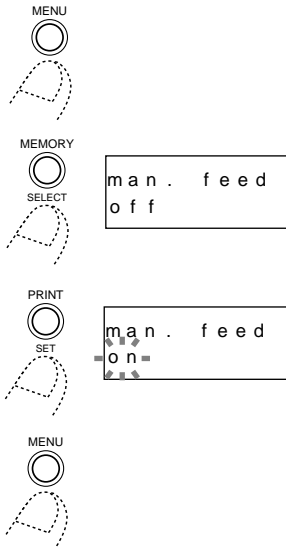

1 PRESS THE MENU BUTTON

- This action displays the printer menu on the LCD panel.

2 PRESS THE SELECT BUTTON

- Press the SELECT button repeatedly until "man. feed" appears.

3 PRESS THE SET BUTTON

- The item on the second line of the LCD panel starts to blink.
- Press the SET button until "on" appears.

4 PRESS THE MENU BUTTON TWICE TO CONFIRM THE ENTRY

Print Operations

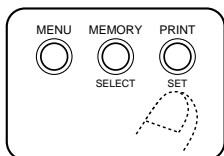
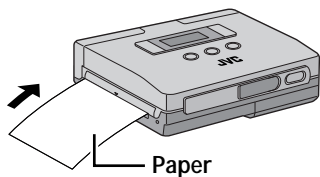
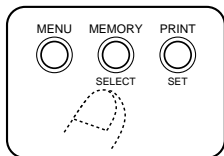

5 SET THE VIDEO SOURCE TO PLAYBACK MODE

- For details, refer to the instruction manual supplied with the video source.

6 PRESS THE MEMORY BUTTON WHEN THE IMAGE YOU WISH TO PRINT APPEARS



- This action stores the image you wish to print.
- The message, "Please wait ..." is displayed on the LCD panel while the image is being stored.
- The memory icon  indicates the following conditions.

on: image data has been stored in the printer
off: no image data is stored in the printer

7 INSERT PRINTING PAPER IN PAPER OUT/MANUAL FEED SLOT

- Slide in the printing paper with the printing surface up as far as it will go without curling it.
- Unless the printing paper is inserted straight, it will cause a paper jam.

8 PRESS THE PRINT BUTTON

- Gently press the edge of the printing paper into the printer.
- Release the paper when it is pulled into the printer.
- The printer starts printing the stored image.
- The message, "Please wait ..." is displayed on the LCD panel. Then the printer icon  appears.
- The printer icon  indicates the following conditions.

on: image data is being printed
off: printing has been completed

- After printing the message "Remove paper" is displayed.

When the paper is removed "Feed paper manually" is displayed.

This display indicates that the printer is now in the manual feed printing mode.

NOTES:

- You can add a frame, produce multipix prints or add special effects.
- To print the same image again, press the PRINT button. One print is made each time the PRINT button is pressed.
- To print a different image, perform operations in steps 5 to 8.

Printing Reversed Images – Mirror Images –

You can, if you wish, reverse a printed image.

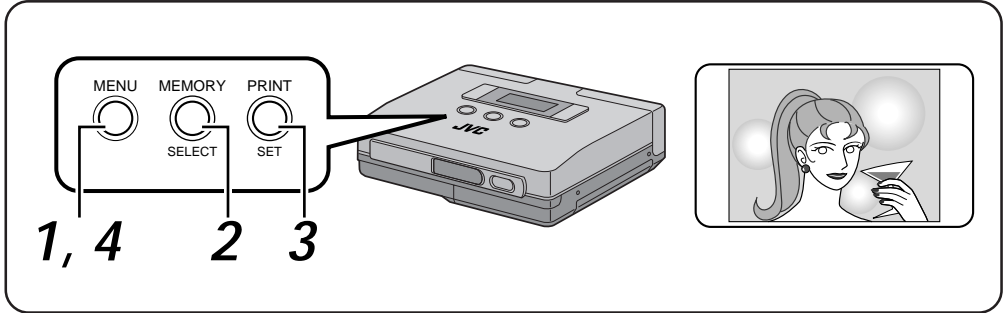

Preparations

- Make the connections (☞ pg. 16).

Selecting Menu Item

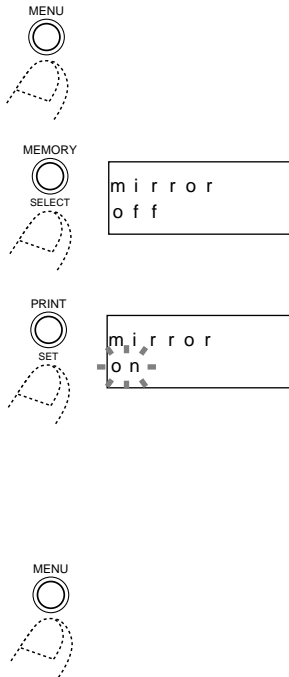

1 PRESS THE MENU BUTTON

- This action displays the printer menu on the LCD panel.

2 PRESS THE SELECT BUTTON

- Press the SELECT button repeatedly until "mirror" appears.

3 PRESS THE SET BUTTON

- The item on the second line of the LCD panel starts to blink.
- Press the SET button until "on" appears.

NOTE:

Only the printed image will be reversed, a monitor connected to the printer will display the normal image.

4 PRESS THE MENU BUTTON TWICE TO CONFIRM THE ENTRY

Print Operations

- Observe the instructions on pages 24 to 37 to print the image.

Adjusting Image Quality – Adjustments before Printing –

When “video” is set in the menu item “input”, you can adjust the brightness and tint before printing.

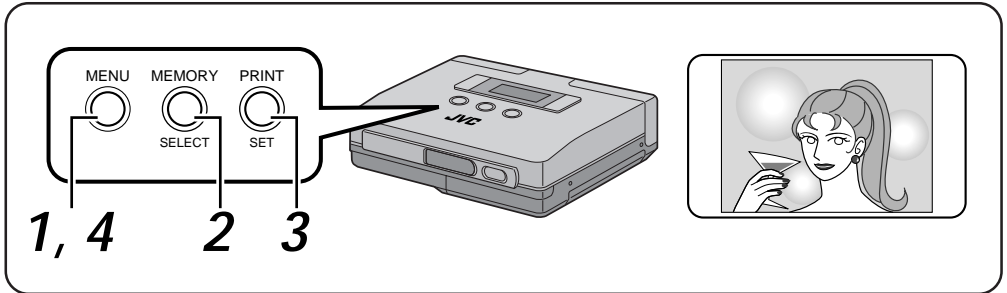

Preparations

- Make the connections (pg. 16).
- Select “video” in the “input” menu (pg. 24).

Selecting Menu Item

- The tint and the brightness of the image can be adjusted only before storing it.

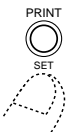

```

adj . image
tint .      0
    
```

```

adj . image
tint .      0
    
```

```

adj . image
tint .      +1
    
```

```

adj . image
bright .    +1
    
```

1 PRESS THE MENU BUTTON

- This action displays the printer menu on the LCD panel.

2 PRESS THE SELECT BUTTON

- Press the SELECT button repeatedly until “adj. image” appears.

3 PRESS THE SET BUTTON

- The item on the second line of the LCD panel starts to blink.
- Adjusting image tint
 - Press the SELECT button until “tint” appears.
 - Press the SET button repeatedly to select the desired tint. To increase saturation, select 0, +1, +2, +3, +4 or +5. The higher numbers indicate greater saturation. To decrease saturation, select 0, -1, -2, -3, -4 or -5. The higher numbers indicate lower saturation.
- Adjusting image brightness
 - Press the SELECT button until “bright.” appears.
 - Press the SET button repeatedly to select the desired brightness. To increase brightness, select 0, +1, +2, +3, +4 or +5. The higher numbers indicate greater brightness. To decrease brightness, select 0, -1, -2, -3, -4 or -5. The higher numbers indicate lower brightness.

4 PRESS THE MENU BUTTON TWICE TO CONFIRM THE ENTRY

Saving Energy – Power Save –

- The printer is equipped with a power saving feature to reduce battery power consumption.
- When the printer is turned on and not used for 5 minutes, the save mode automatically turns it off.

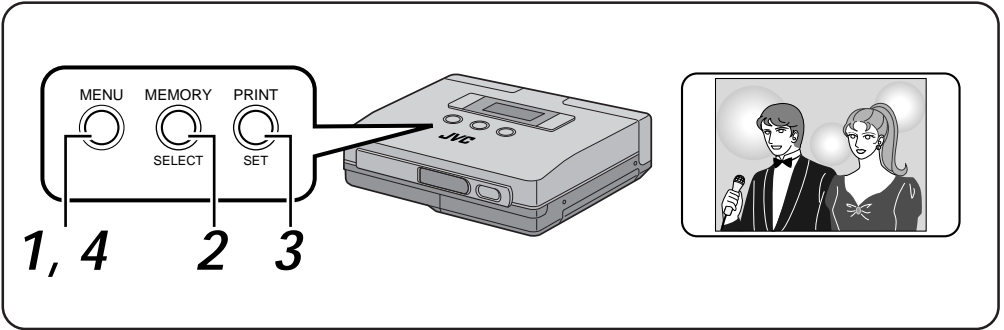

Preparations

- Make the connections (☞ pg. 16).

Selecting Menu Item

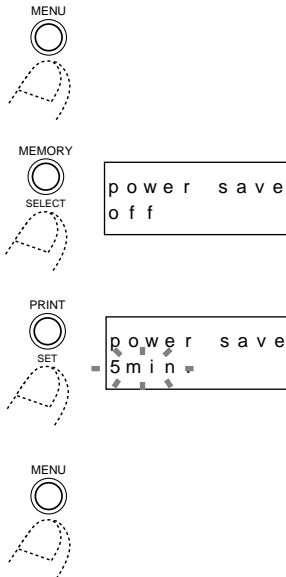

1 PRESS THE MENU BUTTON

- This action displays the printer menu on the LCD panel.

2 PRESS THE SELECT BUTTON

- Press the SELECT button repeatedly until "power save" appears.

3 PRESS THE SET BUTTON

- The item on the second line of the LCD panel starts to blink.
- Press the SET button until "5 min." appears.

4 PRESS THE MENU BUTTON TWICE TO CONFIRM THE ENTRY

- When "5 min." is selected, the printer will automatically be turned off if it is left idle for 5 minutes.
- When "off" is selected, the printer will be on continuously.

Notes:

- When the printer is turned off, it will automatically be reset to the "5 min." setting.
- "power save" cannot be selected when "PC" is selected in the "input" menu item (☞ pg. 15).

Switching between Moving Picture and Still Picture - Memory Mode Selection -

- When "video" is set in the menu item "input", you can select between moving picture or still picture.
- The moving picture setting has a feature for suppressing blur and thus lends itself to capturing images from camcorder or VCRs.
- The still picture setting turns off the blur suppressing function and is therefore best suited to storing still images from digital still cameras and so on.

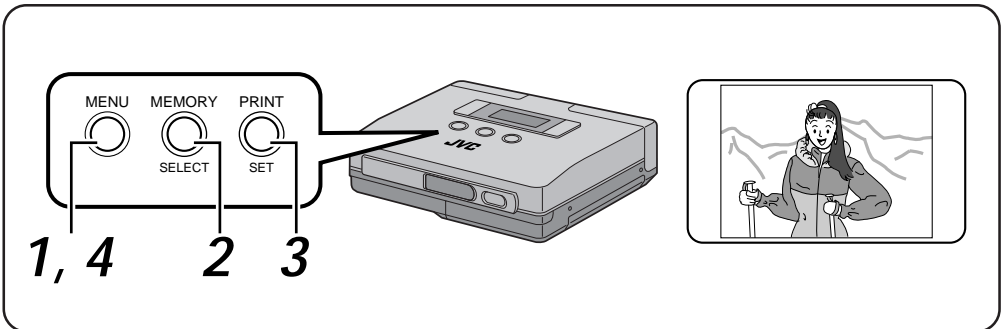

Preparations

- Make the connections (☞ pg. 16).

Selecting Menu Item

1 PRESS THE MENU BUTTON

- This action displays the printer menu on the LCD panel.

2 PRESS THE SELECT BUTTON

- Press the SELECT button repeatedly until "mem. mode" appears.

3 PRESS THE SET BUTTON

- The item on the second line of the LCD panel starts to blink.
- Press the SET button until "moving pic" appears.

NOTE:

The camera  icon is displayed in the still picture mode.

4 PRESS THE MENU BUTTON TWICE TO CONFIRM THE ENTRY

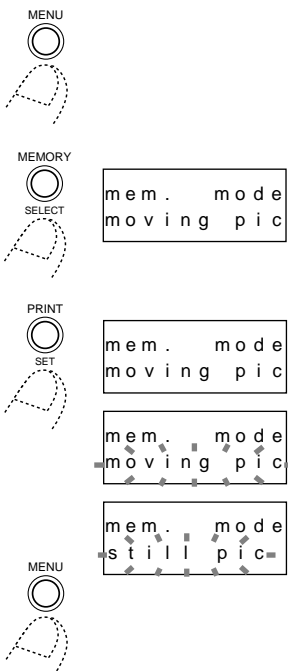

Meaning of Messages Displayed on the LCD panel

Message	<ul style="list-style-type: none"> ● Appears when: ■ Action: 	page
Please wait...	<ul style="list-style-type: none"> ● Image data is being stored or printing has started. 	-
Connect video in	<ul style="list-style-type: none"> ● The video source and the printer are not connected or the cable has been disconnected. ■ Connect the video cable according to the instructions on page 16. 	16
No video signal	<ul style="list-style-type: none"> ● An attempt is made to store an image from a video source that has been turned off. ■ Turn on the video source. 	-
Memorize image	<ul style="list-style-type: none"> ● An attempt is made to print before an image has been stored. ■ Store image data before printing. 	-
Charge battery	<ul style="list-style-type: none"> ● The battery is depleted. ■ Load a charged battery (BN-V607). 	18-19
Insert ink cassette	<ul style="list-style-type: none"> ● An ink cassette has not been loaded or not been properly loaded. ■ Load ink cassette and close the lid. 	20
Close cass. door	<ul style="list-style-type: none"> ● The ink cassette compartment lid is open. ■ Close ink cassette compartment lid. 	20
Change ink cassette	<ul style="list-style-type: none"> ● The ink cassette is depleted. ■ Load new ink cassette. 	20
Insert paper	<ul style="list-style-type: none"> ● No printing paper is loaded. ■ Load printing paper properly and close the paper compartment door. 	22
Close paper door	<ul style="list-style-type: none"> ● The paper compartment door is open. ■ Load printing paper properly and close the paper compartment door. 	22
Paper jammed	<ul style="list-style-type: none"> ● A paper jam occurs during printing. ■ Clear paper jam according to instructions on page 44. 	44
Remove paper	<ul style="list-style-type: none"> ● A paper jam occurs during printing. ■ Clear paper jam according to instructions on page 44. 	44
Print is impossible	<ul style="list-style-type: none"> ● Printing is attempted at low temperature (0°C (32°F) or colder). ● Abnormal image data has been stored. ■ Use the printer under specified conditions. 	45

OTHER PROBLEMS:

This printer contains microprocessors. External electronic noise or interference could cause malfunctioning. In such a case, switch the power off. Then turn on the power and check again.

If	Check to see if	Page
No power is applied to the printer.	<ul style="list-style-type: none"> ● Has the battery been properly charged? ● Has the power supply been correctly connected? 	18
The error icon  is lit (or blinks) on the LCD panel	<ul style="list-style-type: none"> ● Is a message displayed on the LCD panel? If a message is displayed, follow instructions on page 42. ● If not, turn off the printer and wait. Then turn on the power again. 	42
Paper jam	<ul style="list-style-type: none"> ● A paper jam may be caused by the following factors. <ul style="list-style-type: none"> · Paper was not inserted straight during manual feed. · The printer was placed on its side or on a leaning surface. 	36
	<ul style="list-style-type: none"> ● Remove a jammed paper according to instructions on page 44. 	44
The video source image you wish to print is not displayed on the TV.	<ul style="list-style-type: none"> ● Is the video cable correctly connected? ● Is the TV input selector set to "Video (external input)"? ● The input terminal has priority. 	16
The TV is showing a still image.	<ul style="list-style-type: none"> ● Is the TV showing the stored image (memory image)? Set the "monitor" menu to "input pic". 	15
The stored image disappeared.	<ul style="list-style-type: none"> ● The stored image is deleted when the power is turned off. Store the image again. 	-
The color appears faded. The color differs from set image	<ul style="list-style-type: none"> ● The color may differ somewhat from the image displayed on the TV. This is not due to any defect of the printer. 	-
The image quality cannot be adjusted	<ul style="list-style-type: none"> ● Image adjustment is not possible when the menu input mode is something other than video. 	-
The printed image is not clean.	<ul style="list-style-type: none"> ● The printed image is not clean when dirt or dust adheres to the printing paper. Dirt and dust can also cause equipment breakdown. 	-
Stripes on the printed surface	<ul style="list-style-type: none"> ● Due to the reflection of light, stripes may appear on the printed surface. This is normal and is not a cause for concern. 	-
The printed image may differ from the TV image.	<ul style="list-style-type: none"> ● The tint and brightness of the printed image may differ from the image as it is displayed on the TV connected to the printer. This is normal and not a failure. 	-

WHEN PAPER JAMS

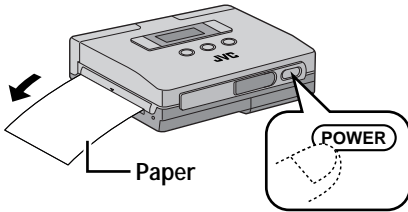

1 TURN OFF THE POWER AND TURN IT BACK ON AGAIN

- The jammed paper is ejected from the PAPER OUT/MANUAL FEED slot.

When paper jam is not removed using procedure 1.

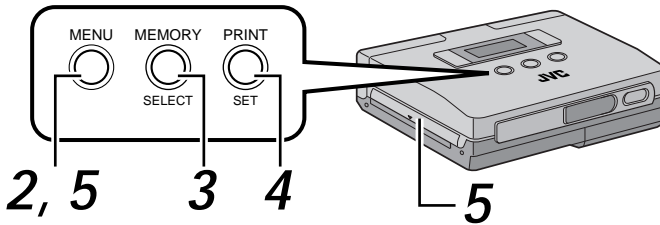

2 PRESS THE MENU BUTTON

- This action displays the printer menu on the LCD panel.

3 PRESS THE SELECT BUTTON

- Press the SELECT button repeatedly until "form feed" appears.

4 PRESS THE SET BUTTON

- The item on the second line of the LCD panel starts to blink.
- Press the SET button repeatedly until "on" appears.

5 PRESS THE MENU BUTTON

- The jammed paper is ejected from the PAPER OUT/MANUAL FEED slot.

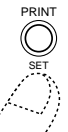
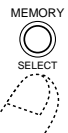

form feed
off

form feed
on

In order to print from the PC, an optional PC connection kit HS-V11 is required. Customers who have purchased a JVC Digital Still Camera such as GC-S1 with which Picture Navigator software and PC connection cable are provided in the same package are enabled to print images from their personal computer.

- Before connection, turn off the power on your PC and Video Printer for safety.
- We recommend you should use the AC Adapter/Charger.

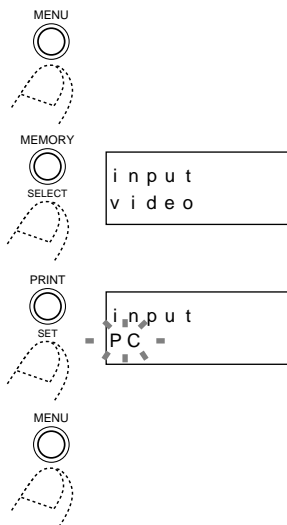
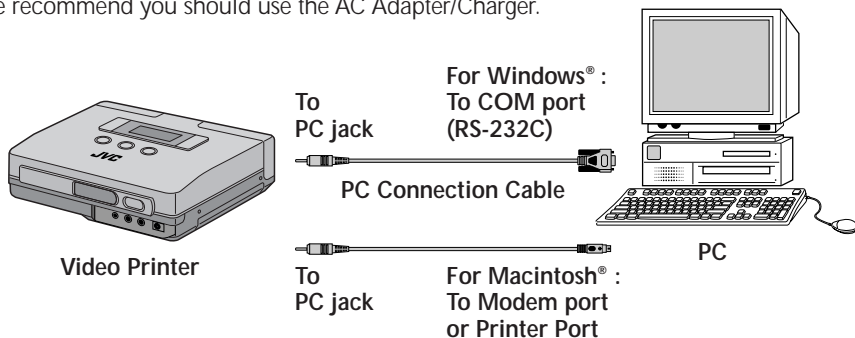

Selecting Menu item

- 1 PRESS THE MENU BUTTON**
 - This action displays the printer menu on the LCD panel.
- 2 PRESS THE SELECT BUTTON**
 - Press the SELECT button repeatedly until "input" appears.
- 3 PRESS THE SET BUTTON**
 - The item on the second line of the LCD panel starts to flash.
 - Press the SET button until "PC" appears.
- 4 PRESS THE MENU BUTTON TWICE TO CONFIRM THE ENTRY**

PC Operations

- 5 TO TRANSMIT THE IMAGE TO BE PRINTED**
 - For more details, refer to the Picture Navigator manual.

Print Operations

- 6 PRESS THE PRINT BUTTON**
 - The printer starts printing the stored image.

NOTES:

- By using HS-V11, communication from a PC to a printer by IrTran-P becomes available. For more details, please refer to the Instructions for the HS-V11.
- The software, Picture Navigator is provided in the same package with the JVC's Digital Still Camera GC-S1, however communication by IrTran-P is not available from the PC to the printer with this software.

Power supply	DC 6 V \equiv (with AC adapter) DC 7.2 V \equiv (with lithium-ion battery)
Power consumption	11 W
Print format	WAX Thermal Permeation
Print area	70 mm x 52 mm (area depends on print format)
Paper size	86 x 54 mm
Print quality	598 (horiz.) dots x 448 (vert.) dots
Resolution	217 dpi
Print speed (processing time)	Approx. 70 sec (excluding data transfer and processing)
Connectors	<ul style="list-style-type: none"> · IrDA input: infrared receiver (one on front panel) (conforms to IrDA Ver. 1.0 IrTran-P) · Video input : 3.5 mm in diam. (one on front panel) · Video output : 3.5 mm in diam. (one on front panel) · PC input : 2.5 mm in diam. (one on front panel)
Operating temperature	+5 - +35°C (+41 - +95°F)
Relative humidity	35 - 80 %
Storage temperature	-20 - +60°C (-4 - +140°F)
Dimensions	130 (W) x 36.5 (H) x 94.5 (D) mm (5-1/8" x 1-7/16" x 3-3/4")
Weight	345 g (0.76 lbs). (printer excluding battery and blank paper sheet)
AC Adapter/Charger	<ul style="list-style-type: none"> • Power requirement : U.S.A. & CANADA AC 120V \sim , 60Hz FOREIGN AC 110 - 240V \sim , 50/60 Hz • Power consumption : 20 W • Output : DC 7.2 V\equiv , 0.77 A (CHARGE) DC 6.3 V\equiv , 1.8 A (VTR) • Dimenusions : 94 (W) x 35 (H) x 122 (D) mm (3-3/4" x 1-7/16 x 4-13/16") • Weight : Approx. 300g (0.67 lbs)

E. & O. E. design and specifications subject to change without notice.

- B**
 Battery compartment lid 19
- C**
 Calendar print 32
 Charging the battery 18
 Connections 16, 17
- D**
 Depleting the battery 6
 DC input jack 12
- F**
 Frame print 28
- I**
 Icon 12
 Image adjustment 39
 Ink cassette compartment lid 20
 IrTran-P (IrDA) 12, 26
- J**
 Jack cover 12
- L**
 LCD panel 12
- M**
 Manual feed slot 13,37
 MEMORY button 14
 MENU button 14
 Menu item list 15
 Mirror print 38
 Multipix 30
- O**
 Operation buttons 14
- P**
 Paper compartment door switch 13, 22
 PC connection jack 12
 PRINT button 14
 Printing from digital still camera 26
 Printing from the personal computer 45
 Printing with special effects 34
 Power button 12
 Power save 40
- S**
 SELECT button 14
 SET button 14
 Switching between moving picture
 and still image 41
- V**
 Video input jack 12, 16
 Video output jack 12, 16

HOW TO LOCATE YOUR JVC SERVICE CENTER**TOLL FREE: 1-800-252-5722****Dear customer:**

In order to receive the most satisfaction from your purchase, read the instruction booklet before operating the unit. In the event that repair is necessary, or for the address nearest your location, please refer to the factory service center list below or within the Continental United States, call 1-800-252-5722 for your authorized servicer. Remember to retain your Bill of Sale for Warranty Service.

— JVC

**JVC SERVICE & ENGINEERING
COMPANY OF AMERICA
DIVISION OF US JVC CORP.**

FACTORY SERVICE CENTER LOCATIONS

107 Little Falls Road
Fairfield, NJ 07004-2105
(973) 808-9279

1500 Lakes Parkway
Lawrenceville, GA 30243-5857
(770) 339-2522

705 Enterprise Street
Aurora, IL 60504-8135
(630) 851-7855

5665 Corporate Avenue
Cypress, CA 90630-4727
(714) 229-8011

10700 Hammerly Blvd., Suite 110
Houston, TX 77043-2310
(713) 935-9331

2969 Mapunapuna Place, Suite 101
Honolulu, HI 96819-2000
(808) 833-5828

230 Eliot Street
Ashland, MA 01721-2377
(508) 881-5923

8192 West State Road 84
Davie, FL 33324-4611
(954) 472-1960

890 Dubuque Avenue
South San Francisco, CA 94080-1804
(415) 871-2666

Sophisticated electronic products may require occasional service. Just as quality is a keyword in the engineering and production of the wide array of JVC products, service is the key to maintaining the high level performance for which JVC is world famous. The JVC service and engineering organization stands behind our products.

NATIONAL HEADQUARTERS
JVC SERVICE & ENGINEERING COMPANY OF AMERICA
DIVISION OF US JVC CORP.
107 Little Falls Road
Fairfield, NJ 07004-2105

If you ship the product...

Pack your JVC unit in the original carton or one of equivalent size and strength. Enclose, with the unit, a letter stating the problem or symptom that exists and also a copy of the receipt or bill of sale you received when you purchased your JVC unit. Print your home return address on the outside and the inside of the carton. Send to the appropriate JVC Factory Service Center as listed above.

ACCESSORIES

To purchase accessories for your JVC product, you may contact your local JVC Dealer.
Or from the 48 Continental United States call toll free:
1-800-882-2345.

Don't service it yourself.**CAUTION**

To prevent electrical shock, do not open the cabinet. No user serviceable parts inside.
Refer servicing to qualified service personnel.

LIMITED WARRANTY**CONSUMER VIDEO 1-90**

JVC COMPANY OF AMERICA warrants this product and all parts thereof, except as set forth below **ONLY TO THE ORIGINAL PURCHASER AT RETAIL** to be **FREE FROM DEFECTIVE MATERIALS AND WORKMANSHIP** from the date of original retail purchase for the period as shown below. ("The Warranty Period")

PARTS	1 YR	LABOR	90 DAYS
-------	-------------	-------	----------------

THIS LIMITED WARRANTY IS VALID ONLY IN THE FIFTY (50) UNITED STATES, THE DISTRICT OF COLUMBIA AND IN COMMONWEALTH OF PUERTO RICO.

WHAT WE WILL DO:

If this product is found to be defective, JVC will repair or replace defective parts at no charge to the original owner. Such repair and replacement services shall be rendered by JVC during normal business hours at JVC authorized service centers. Parts used for replacement are warranted only for the remainder of the Warranty Period. All products and parts thereof may be brought to a JVC authorized service center on a carry-in basis except for Television sets having a screen size 25 inches and above which are covered on an in-home basis.

WHAT YOU MUST DO FOR WARRANTY SERVICE:

Return your product to a JVC authorized service center with a copy of your bill of sale. For your nearest JVC authorized service center, please call toll free: (800) 252-5722.

If service is not available locally, box the product carefully, preferably in the original carton, and ship, insured, with a copy of your bill of sale plus a letter of explanation of the problem to the nearest JVC Factory Service Center, the name and location of which will be given to you by the toll-free number.

If you have any questions concerning your JVC Product, please contact our Customer Relations Department.

WHAT IS NOT COVERED:

This limited warranty provided by JVC does not cover:

1. Products which have been subject to abuse, accident, alteration, modification, tampering, negligence, misuse, faulty installation, lack of reasonable care, or if repaired or serviced by anyone other than a service facility authorized by JVC to render such service, or if affixed to any attachment not provided with the products, or if the model or serial number has been altered, tampered with, defaced or removed;
2. Initial installation and installation and removal for repair;
3. Operational adjustments covered in the Owner's Manual, normal maintenance, video and audio head cleaning;
4. Damage that occurs in shipment, due to act of God, and cosmetic damage;
5. Signal reception problems and failures due to line power surge;
6. Video Pick-up Tubes/CCD Image Sensor, Cartridge, Stylus (Needle) are covered for 90 days from the date of purchase;
7. Accessories;
8. Batteries (except that Rechargeable Batteries are covered for 90 days from the date of purchase);from the date of purchase);

There are no other express warranties except as listed above.

THE DURATION OF ANY IMPLIED WARRANTIES INCLUDING THE IMPLIED WARRANTY OF MERCHANTABILITY, IS LIMITED TO THE DURATION OF THE EXPRESS WARRANTY HEREIN.

JVC SHALL NOT BE LIABLE FOR THE LOSS OF USE OF THE PRODUCT, INCONVENIENCE, LOSS OR ANY OTHER DAMAGES, WHETHER DIRECT, INCIDENTAL OR CONSEQUENTIAL (INCLUDING, WITHOUT LIMITATION, DAMAGE TO TAPES, RECORDS OR DISCS) RESULTING FROM THE USE OF THIS PRODUCT, OR ARISING OUT OF ANY BREACH OF THIS WARRANTY. ALL EXPRESS AND IMPLIED WARRANTIES, INCLUDING THE WARRANTIES OF MERCHANTABILITY AND FITNESS FOR PARTICULAR PURPOSE, ARE LIMITED TO THE WARRANTY PERIOD SET FORTH ABOVE.

Some states do not allow the exclusion of incidental or consequential damages or limitations on how long an implied warranty lasts, so these limitations or exclusions may not apply to you. This warranty gives you specific legal rights and you may also have other rights which vary from state to state.

JVC COMPANY OF AMERICA
DIVISION OF US JVC CORP.

41 Slater Drive
Elmwood Park, New Jersey 07407

REFURBISHED PRODUCTS CARRY A SEPARATE WARRANTY, THIS WARRANTY DOES NOT APPLY. FOR DETAILS OF REFURBISHED PRODUCT WARRANTY, PLEASE REFER TO THE REFURBISHED PRODUCT WARRANTY INFORMATION PACKAGED WITH EACH REFURBISHED PRODUCT.

For customer use:

Enter below the Model No. and Serial No. which is located either on the rear, bottom or side of the cabinet. Retain this information for future reference.

Model No.: _____**Serial No.:** _____**Purchase date:** _____**Name of dealer:** _____

EN

GV-HT1



Free Manuals Download Website

<http://myh66.com>

<http://usermanuals.us>

<http://www.somanuals.com>

<http://www.4manuals.cc>

<http://www.manual-lib.com>

<http://www.404manual.com>

<http://www.luxmanual.com>

<http://aubethermostatmanual.com>

Golf course search by state

<http://golfingnear.com>

Email search by domain

<http://emailbydomain.com>

Auto manuals search

<http://auto.somanuals.com>

TV manuals search

<http://tv.somanuals.com>