

JVC



VIDEO PRINTER

IMPRIMANTE VIDÉO

IMPRESOR DE VIDEO

GV-PT1

ENGLISH

FRANÇAIS

ESPAÑOL

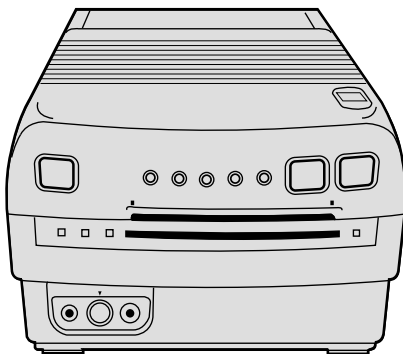

INSTRUCTIONS

MANUEL D'INSTRUCTIONS
MANUAL DE INSTRUCCIONES

For Customer Use:

Enter below the Serial No. of the
GV-PT1U Video Printer.
The serial number is located on the
bottom of the GV-PT1U.

Model No. GV-PT1U

Serial No. _____

Dear Customer,

Thank you for purchasing this Video Printer. Before use, please read the safety information and precautions contained in the following pages to ensure safe use of this product.

Using This Instruction Manual

- All major sections and subsections are listed in the Table Of Contents (☞ pg. 7).
- Notes appear after most subsections. Be sure to read these as well.
- Basic and advanced features/operation are separated for easier reference.

It is recommended that you . . .

- refer to "Controls, Indicators and Connectors" (☞ pgs. 8 – 9) and familiarize yourself with button locations, etc. before use.
- read thoroughly the Safety Precautions and Safety Instructions that follow. They contain extremely important information regarding the safe use of your new video printer.

You are recommended to carefully read the cautions on page 5 before use.

INFORMATION

This device complies with Part 15 of FCC Rules. Operation is subject to the following two conditions: (1) This device may not cause harmful interference, and (2) this device must accept any interference received, including interference that may cause undesired operation. Change or modifications not approved by the party responsible for compliance could void the user's authority to operate the equipment. This equipment has been tested and found to comply with the limits for a Class B digital device, pursuant to Part 15 of the FCC Rules. These limits are designed to provide reasonable protection against harmful interference in a residential installation. This equipment generates, uses, and can radiate radio frequency energy and, if not installed and used in accordance with the instructions, may cause harmful interference to radio communications. However, there is no guarantee that interference will not occur in a particular installation. If this equipment does cause harmful interference to radio or television reception, which can be determined by turning the equipment off and on, the user is encouraged to try to correct the interference by one or more of the following measures:

- Reorient or relocate the receiving antenna.
- Increase the separation between the equipment and receiver.
- Connect the equipment into an outlet on a circuit different from that to which the receiver is connected.
- Consult the dealer or an experienced radio/TV technician for help.

SAFETY PRECAUTIONS

	CAUTION RISK OF ELECTRIC SHOCK DO NOT OPEN	
CAUTION: TO REDUCE THE RISK OF ELECTRIC SHOCK, DO NOT REMOVE COVER (OR BACK). NO USER-SERVICEABLE PARTS INSIDE. REFER SERVICING TO QUALIFIED SERVICE PERSONNEL.		



The lightning flash with arrowhead symbol, within an equilateral triangle, is intended to alert the user to the presence of uninsulated "dangerous voltage" within the product's enclosure that may be of sufficient magnitude to constitute a risk of electric shock to persons.



The exclamation point within an equilateral triangle is intended to alert the user to the presence of important operating and maintenance (servicing) instructions in the literature accompanying the appliance.

The GV-PT1 Video Printer should be used with: AC 120 V~, 60 Hz
To prevent electric shock and hazards, DO NOT use any other power source.

CAUTION

TO PREVENT ELECTRIC SHOCK MATCH WIDE BLADE OF PLUG TO WIDE SLOT, FULLY INSERT.

ATTENTION

POUR ÉVITER LES CHOCS ÉLECTRIQUES, INTRODUIRE LA LAME LA PLUS LARGE DE LA FICHE DANS LA BORNE CORRESPONDANTE DE LA PRISE ET POUSSER JUSQU'AU FOND.

WARNING:
TO PREVENT FIRE OR SHOCK HAZARD, DO NOT EXPOSE THIS UNIT TO RAIN OR MOISTURE.

NOTE:

The rating plate (serial number plate) and safety caution are on the bottom and/or the back of the main unit.

This Class B digital apparatus meets all requirements of the Canadian Interference – Causing Equipment Regulations.

“Cet appareil numérique de la classe B respecte toutes les exigences du Règlement sur le matériel brouilleur du Canada.”

IMPORTANT PRODUCT SAFETY INSTRUCTIONS

Electrical energy can perform many useful functions. But improper use can result in potential electrical shock or fire hazards. This product has been engineered and manufactured to assure your personal safety. In order not to defeat the built-in safeguards, observe the following basic rules for its installation, use and servicing.

ATTENTION:

Follow and obey all warnings and instructions marked on your product and its operating instructions. For your safety, please read all the safety and operating instructions before you operate this product and keep this manual for future reference.

INSTALLATION

1. Grounding or Polarization

(A) Your product may be equipped with a polarized alternating-current line plug (a plug having one blade wider than the other). This plug will fit into the power outlet only one way. This is a safety feature.

If you are unable to insert the plug fully into the outlet, try reversing the plug. If the plug should still fail to fit, contact your electrician to replace your obsolete outlet. Do not defeat the safety purpose of the polarized plug.

(B) Your product may be equipped with a 3-wire grounding-type plug, a plug having a third (grounding) pin. This plug will only fit into a grounding-type power outlet. This is a safety feature.

If you are unable to insert the plug into the outlet, contact your electrician to replace your obsolete outlet. Do not defeat the safety purpose of the grounding-type plug.

2. Power Sources

Operate your product only from the type of power source indicated on the marking label. If you are not sure of the type of power supply to your home, consult your product dealer or local power company. If your product is intended to operate from battery power, or other sources, refer to the operating instructions.

3. Overloading

Do not overload wall outlets, extension cords, or integral convenience receptacles as this can result in a risk of fire or electric shock.

4. Power Cord Protection

Power supply cords should be routed so that they are not likely to be walked on or pinched by items placed upon or against them, paying particular attention to cords at plugs, convenience receptacles, and the point where they exit from the product.

5. Ventilation

Slots and openings in the cabinet are provided for ventilation. To ensure reliable operation of the product and to protect it from overheating, these openings must not be blocked or covered.

- Do not block the openings by placing the product on a bed, sofa, rug or other similar surface.
- Do not place the product in a built-in installation such as a bookcase or rack unless proper ventilation is provided or the manufacturer's instructions have been adhered to.

6. Wall or Ceiling Mounting

The product should be mounted to a wall or ceiling only as recommended by the manufacturer.

USE

1. Accessories

To avoid personal injury:

- Do not place this product on an unstable cart, stand, tripod, bracket or table. It may fall, causing serious injury to a child or adult, and serious damage to the product.
- Use only with a cart, stand, tripod, bracket, or table recommended by the manufacturer or sold with the product.
- Use a mounting accessory recommended by the manufacturer and follow the manufacturer's instructions for any mounting of the product.
- Do not try to roll a cart with small casters across thresholds or deep-pile carpets.

2. Product and Cart Combination

A product and cart combination should be moved with care. Quick stops, excessive force, and uneven surfaces may cause the product and cart combination to overturn.

3. Water and Moisture

Do not use this product near water—for example, near a bath tub, wash bowl, kitchen sink or laundry tub, in a wet basement, or near a swimming pool and the like.

PORTABLE CART WARNING
(Symbol provided by RETAC)



4. Object and Liquid Entry

Never push objects of any kind into this product through openings as they may touch dangerous voltage points or short-out parts that could result in a fire or electric shock. Never spill liquid of any kind on the product.

5. Attachments

Do not use attachments not recommended by the manufacturer of this product as they may cause hazards.

6. Cleaning

Unplug this product from the wall outlet before cleaning. Do not use liquid cleaners or aerosol cleaners. Use a damp cloth for cleaning.

7. Heat

The product should be situated away from heat sources such as radiators, heat registers, stoves, or other products (including amplifiers) that produce heat.

SERVICING

1. Servicing

If your product is not operating correctly or exhibits a marked change in performance and you are unable to restore normal operation by following the detailed procedure in its operating instructions, do not attempt to service it yourself as opening or removing covers may expose you to dangerous voltage or other hazards. Refer all servicing to qualified service personnel.

2. Damage Requiring Service

Unplug this product from the wall outlet and refer servicing to qualified service personnel under the following conditions:

- When the power supply cord or plug is damaged.
- If liquid has been spilled, or objects have fallen into the product.
- If the product has been exposed to rain or water.
- If the product does not operate normally by following the operating instructions. Adjust only those controls that are covered by the operating instructions as an improper adjustment of other controls may result in damage and will often require extensive work by a qualified technician to restore the product to its normal operation.
- If the product has been dropped or damaged in any way.
- When the product exhibits a distinct change in performance—this indicates a need for service.

3. Replacement Parts

When replacement parts are required, be sure the service technician has used replacement parts specified by the manufacturer or have the same characteristics as the original part. Unauthorized substitutions may result in fire, electric shock or other hazards.

4. Safety Check

Upon completion of any service or repairs to this product, ask the service technician to perform safety checks to determine that the product is in safe operating condition.

If you notice smoke or a peculiar smell coming from the printer, shut it down and unplug it IMMEDIATELY. Use of the video printer under these conditions could lead to fire or electric shock. Contact your JVC dealer. DO NOT attempt to repair the malfunction yourself.

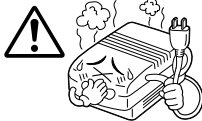

DO NOT attempt to insert foreign objects into the video printer, as this can lead to electric shock or fire. If an object other than print paper is accidentally inserted, shut the video printer down, unplug it and contact your JVC dealer.

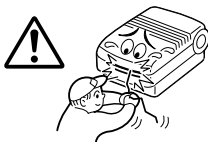

Exercise caution when moving the video printer. If you drop the unit, do not attempt to use it. If during use you notice that the cabinet is damaged, shut the video printer down, unplug it and contact your JVC dealer. Use of the video printer under these conditions can lead to fire or electric shock.



DO NOT place heavy objects on the video printer's power cord, or leave the cord near any heat-generating appliance, as this can damage the cord. Avoid excessive pulling or twisting of the power cord. If the power cord becomes cut or otherwise damaged, contact your JVC dealer. When unplugging the video printer, DO NOT pull on the cord. Hold the plug itself and remove it from the AC outlet. Use of the video printer with a damaged power cord can lead to fire, electric shock and unit malfunctions.



DO NOT remove the cover and attempt to repair or modify the video printer. There are high-voltage components within the unit, and the risk of electric shock and unit malfunctions exists. If a problem occurs, contact your JVC dealer.



ABOUT THERMAL HEADS

- The thermal heads, necessary for printing, are located within the unit. The heads can become extremely warm. To prevent possible burns and injuries, do not touch the thermal heads.
- When the Video Printer is used for extended periods, the thermal heads experience wear and tear just like VCR heads. As the thermal heads become worn, print quality will gradually decrease. When you notice a decline in quality, it is possible that the heads may need to be replaced. Consult your JVC dealer.

MOISTURE CONDENSATION

If condensation occurs inside the printer, it may adhere to print paper during printing, causing poor quality prints and paper jams. If you think condensation may exist within the unit, let the unit sit for at least 2 hours (with the power on) to dry sufficiently. If paper is stuck within the unit, remove it before turning the power on. Unused print paper subjected to moisture should not be used for printing.

- Condensation may occur in the following situations:
 - 1) In a room when the heater suddenly comes on;
 - 2) In the direct path of cool air from an air conditioner;
 - 3) When the unit is moved from a cool place to a warm place.

DUST

Due to dust or lint adhering to print paper, or to extreme variations in temperature, a small degree of color smearing or lines may be visible in prints.

Failure to heed the following precautions may result in damage to the Video Printer.

1. **DO NOT** place the Video Printer . . .
 - ... in an environment prone to extreme temperatures or humidity.
 - ... in direct sunlight.
 - ... in a dusty environment.
 - ... in an environment where strong magnetic fields are generated.
 - ... on a surface that is unstable or subject to vibration.
2. **DO NOT** block the Video Printer's ventilation openings.
3. **DO NOT** place heavy objects on the Video Printer.
4. **DO NOT** place anything which might spill on top of the Video Printer.
5. **AVOID** violent shocks to the Video Printer during transport.

CAUTION:

Changes or modifications not approved by JVC could void user's authority to operate the equipment.

Using the GV-PT1, you can print scenes onto standard or seal print paper, in any one of several formats.

MULTI-PRINT (☞ pgs. 18–21)
Print 4 or 16 images on one sheet.

The same scene . . .



. . . or different scenes



INSET PRINT
(☞ pgs. 22–23)
Inset one scene onto another.

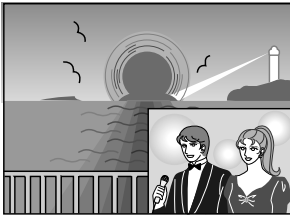

STROBE PRINT
(☞ pgs. 24–25)
Print at set intervals, as when taking rapid-fire snapshots.

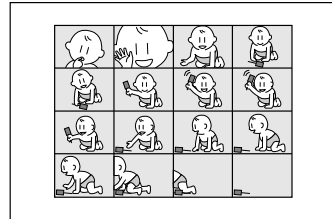

TITLE IMPOSE PRINT
(☞ pgs. 26–27)
Impose hand-drawn titles or illustrations on an image.

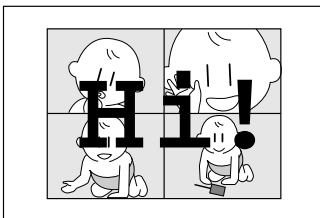

When using a JVC camcorder or VCR . . .

SNAPSHOT PRINT
(☞ pgs. 28–29)

If your JVC camcorder is equipped with Snapshot Search (such as the GR-SV7 or GR-DV1), you can automatically edit and print snapshots.

EDITING INDEX
(☞ pgs. 30–31)

When used in conjunction with Random Assemble Editing, this feature enables the making of an index.

CONTROLS, INDICATORS AND CONNECTORS	8
PREPARATION	10
Install/Remove Ink Sheet Cartridge	10
About Print Sheet Sets	11
About Ink Sheet Cartridges	11
BASIC PRINTING	12
Connections	12
Language Select	13
Single Print	14
ADVANCED PRINTING	16
Setting The Print Menu	16
Multi-Print (Same Scene)	18
Multi-Print (Different Scenes)	20
Inset Print	22
Strobe Print	24
Title Impose Print	26
Snapshot Print	28
Editing Index	30
ERROR MESSAGES	32
TROUBLESHOOTING	33
CORRECTIVE ACTION	34
Paper Jam	34
Cleaning The Thermal Heads	34
SPECIFICATIONS	35
INDEX	35

Front View

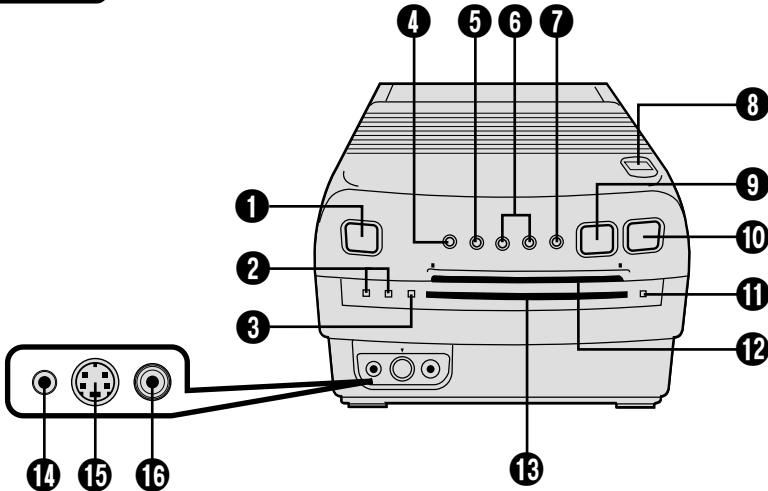
**1 POWER On/Off**

- Turns the printer on and off.

2 POWER ON Lamp

- Lights when power is turned on.
- POWER OFF Lamp**
- Lights when power is turned off.

3 Print Lamp

- Lights when printing is in progress.

4 MENU Button

- Brings up and closes the Printer Menu screen.

5 SELECT Button

- Selects items at the Printer Menu and Mode Select screens.
- Reverses the transparent and opaque portions of a title in Title Impose mode.

6 SET +/- Buttons

- Cycle through options at the Print Menu screen.
- Select memory position when printing in multi-print mode (ⓘ pg. 20).
- Select title color in Title Impose mode (ⓘ pg. 26).

7 MODE SELECT Button

- Brings up and closes the Mode Select Menu screen.

8 Slide Knob "Open"

- Slide to open the lid. This allows you to install or remove the ink sheet cartridge or remove a sheet that has become stuck.

9 PICTURE SELECT Button

- Determines whether the image being input or the image stored in memory is displayed on the connected TV's screen.

10 MEMORY Button

- Press to store an image for printing.

11 Error Lamp

- Lights when there's no ink sheet cartridge installed, or when printing is impossible due to a malfunction.

12 Print Sheet Insertion Slot

- Insert a sheet for printing.

13 Print Sheet Exit Slot

- Printed images come out here.

Rear View

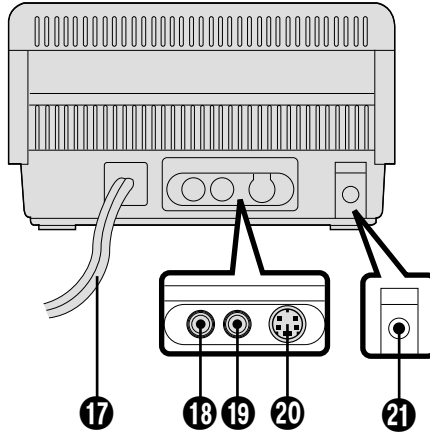

14 PAUSE Connector

- Used when printing snapshots or an editing index from a JVC camcorder or video cassette recorder. Connect a commercially available ϕ 3.5 mm mini plug to either the camcorder's editing jack or the video cassette recorder's R.A. EDIT or SPECIAL FUNCTION jack.

15 S-Video Input Connector (front)

- If the source (camcorder or video cassette recorder) has an S-Video output jack, connect it to the video printer using a commercially available S-Video cable. The printer gives this input priority over the normal inputs and the rear S-Video input.

16 Video Input Connector (front)

- If the source doesn't have an S-Video output jack, connect its normal video output to the printer using a commercially available video cable. The printer gives this input priority over the S-Video and normal video inputs on the rear of the unit.

17 Power Cord

- Plug into an AC outlet. If the AC outlet is not a grounding-type outlet, use the provided conversion plug.

18 Video Output Connector

- Use this connector when you want to see the input image, or the image stored in memory, on a television. Using a commercially available video cable, connect the printer to a television.

19 Video Input Connector (Rear)

- If the source doesn't have an S-Video output jack, connect its normal video output to this connector using a commercially available video cable.

20 S-Video Input Connector (Rear)

- If the source has an S-Video output jack, connect it to the printer using a commercially available S-Video cable. The printer gives this input priority over the rear normal video input.

21 JLIIP (Joint Level Interface Protocol) Connector

- In the future, connection to a computer or other device for manipulation of images will become possible.

* When using the PAUSE Connector 14, JLIIP cannot be used.

Input connectors are prioritized as follows:

15, 16, 20, 19

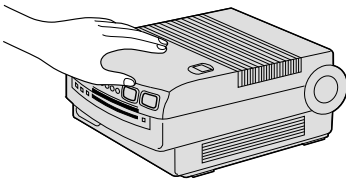
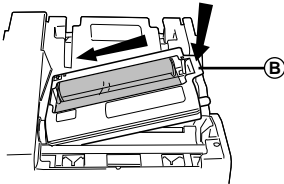
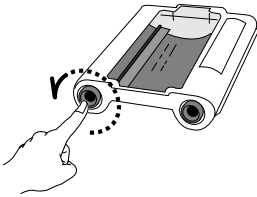
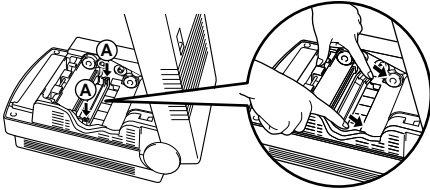
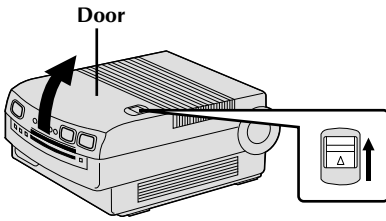

Install/Remove Ink Sheet Cartridge

Before printing, you need to install an ink sheet cartridge. Follow these instructions for initial installation and for removal and replacement of a used cartridge.

NOTE:

Make sure the unit power is off before opening the lid.

1 OPEN PRINTER LID

Slide the knob in the direction of the arrow.

- The lid springs up, so apply gentle pressure as you open it.

2 REMOVE PROTECTIVE CLIP

Press **A** as indicated by the arrow, then lift and remove the clip.

- Store the clip in a safe place, and re-attach it prior to transporting the unit.

3 TAKE UP SLACK

Using your index finger, turn the roller on the side with the "⇒" mark in the direction of the arrow.

4 INSTALL CARTRIDGE

Hold **B**, turn the cartridge until it's at the proper angle, then slide it in until you hear it click.

OR . . .

REMOVE CARTRIDGE

Open the printer lid, grab the **B** of the cartridge, and slide it out slowly.

5 CLOSE PRINTER LID

Press down on the lid (where **PUSH** appears) until you hear it click into place.

CAUTION:

The thermal heads on the underside of the lid may become hot. Take care not to touch them when installing or removing the cartridge.

NOTE:

When you're moving, or prior to transporting the video printer, be sure to remove the ink sheet cartridge and re-attach the protective clip.

About Print Sheet Sets

You must use one of the sets shown in the following chart:

SET	CONTENTS	USES
VU-PS50U (Standard)	<ul style="list-style-type: none"> • Standard Print Paper (50 Sheets) • Ink Sheet Cartridge (50 Prints) 	Print your favorite scenes, just like snapshots.
VU-PC50U (Seal)	<ul style="list-style-type: none"> • Seal Print Paper (50 Sheets) • Ink Sheet Cartridge (50 Prints) 	Make customized seals and stick them on business cards, greeting cards, etc.

* One VU-PS50U set is provided. Both VU-PS50U and VU-PC50U are sold separately.

Before Printing

- If the print side (the side with no writing on it) becomes dirty due to dust or fingerprints, poor print quality or paper jamming may result.
- Do not use paper that is torn or bent, as this can result in paper jamming.
- Do not use paper that is wet or damp. Printing may become impossible and paper jamming may occur.
- One side of VU-PS50 print paper contains writing.
- If you want to write something on a print sheet, wait until printing is finished. If you write before the sheet is printed on, printing may not work properly.

During Printing

- Do not pull on the print sheet during printing, as this can cause poor print quality or a malfunction.
- Do not turn the Video Printer's power off during printing, as the print in progress will be incomplete and a paper jam may result.

After Printing

- If you hold a fresh print in your hand for an extended period, the colors may change slightly.
- If a print absorbs organic cleaning solvents (alcohol, ester, ketone, etc.), the colors will fade.
- If cellophane tape or soft PVC are affixed to a print, the chemical reaction will cause accelerated color fading.
- When writing on a VU-PS50U print sheet, be sure to use a pencil or an oil-based writing utensil. If you apply too much pressure, you'll leave imprints on the print sheet.

Storage

- Avoid storing prints in areas subject to high temperatures or humidity, or near a heater or heat-generating device.
- Do not store prints in a soft plastic folder. Accelerated color fading may result due to the chemical reaction, or the print(s) may stick to the file.
- Do not store 2 prints with the printed sides touching, as the sheets may stick together.
- Store print paper in its box, on a level surface. Failure to do so may cause the print paper to curl or bend, which can result in a paper jam within the unit.

About Ink Sheet Cartridges

Before Printing

- Use a cartridge and paper from the same set. Do not mix cartridges and paper from different types of sets.

After Printing

- When a cartridge is fully used, replace it with a new one. Do not attempt to reuse a cartridge by rewinding it manually.

Storage

- Avoid storing cartridges in areas subject to high temperatures or humidity, or in direct sunlight.
- Keep ink sheets out of the reach of small children.

Connections

The GV-PT1 accepts both normal video and S-video signals. The connection you make depends on the image source (camcorder, video cassette recorder) and its output capabilities.

TO CONNECT TO AN IMAGE SOURCE WITH S-VIDEO OUTPUT CONNECTORS

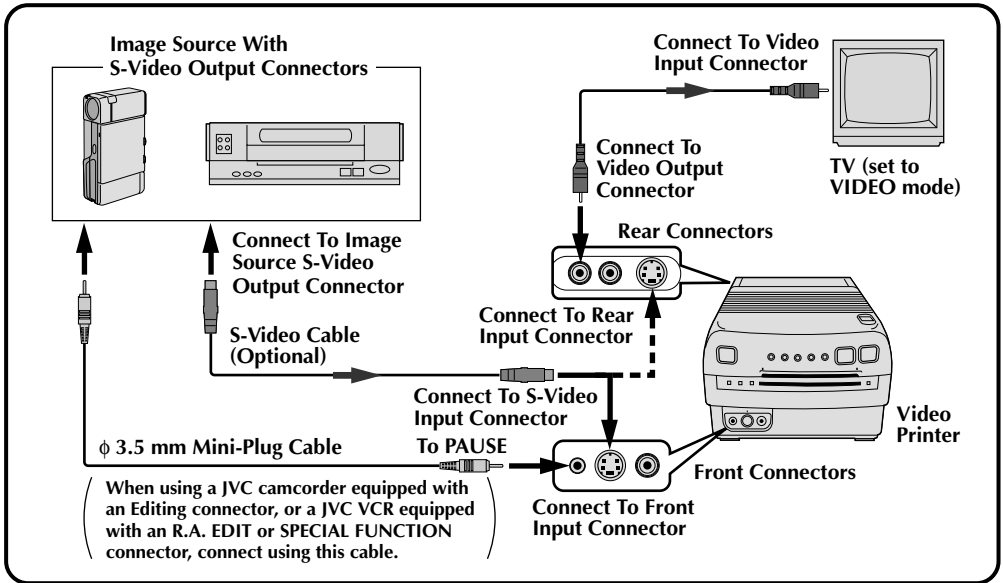

TO CONNECT TO AN IMAGE SOURCE WITH REGULAR VIDEO OUTPUT CONNECTORS

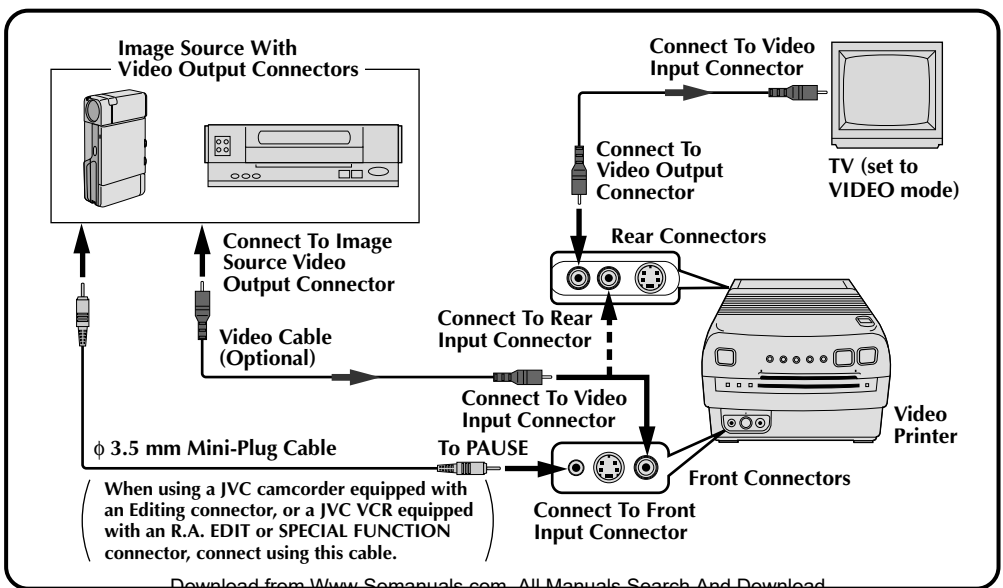

NOTES:

- Some televisions and video cassette recorders require a specific type of output cable. Refer to the TV's and/or VCR's instruction manual when connecting to the GV-PT1.
- The video printer assigns a priority to input signals. A signal input to the front terminals is accepted before a signal input to the rear terminals. S-Video signals take priority over regular video signals.
- When you connect the output of a camcorder equipped with an LCD monitor to the GV-PT1, you can view the video printer's output image on the LCD monitor .

Language Select

You can view on-screen menus and messages in English, French or Spanish.

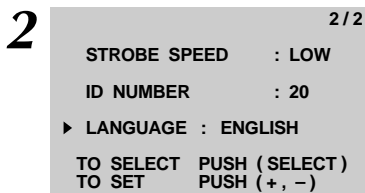
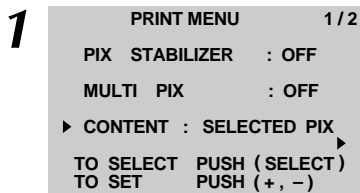
**1 ACCESS PRINT MENU**

Press **MENU**. The Print Menu screen appears on the connected TV.

2 SELECT LANGUAGE

Place the pointer next to "LANGUAGE" by pressing **SELECT**, then press **SET +/-** to cycle through the languages until the one you want appears.

3 CLOSE PRINT MENU

Press **MENU**. The Print Menu screen disappears.

Single Print

You should already have performed the following steps:

- Prepare paper sheet set (☞ pg. 11)
- Install ink sheet cartridge (☞ pg. 10)
- Prepare print paper (☞ pg. 11)
- Connect image source to video printer (☞ pg. 12)
- Plug video printer's power plug into AC outlet and press **POWER**. The power comes on and the **POWER ON Lamp** lights.

If not, go back to the appropriate page and perform the procedure(s).

This section details the procedure for printing one scene. It provides a convenient way to make a photo album.

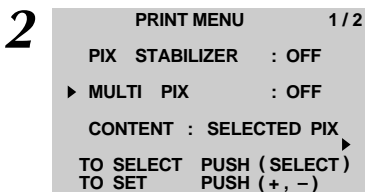
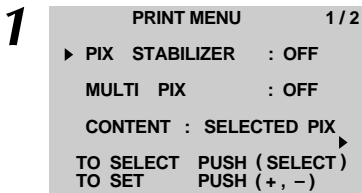
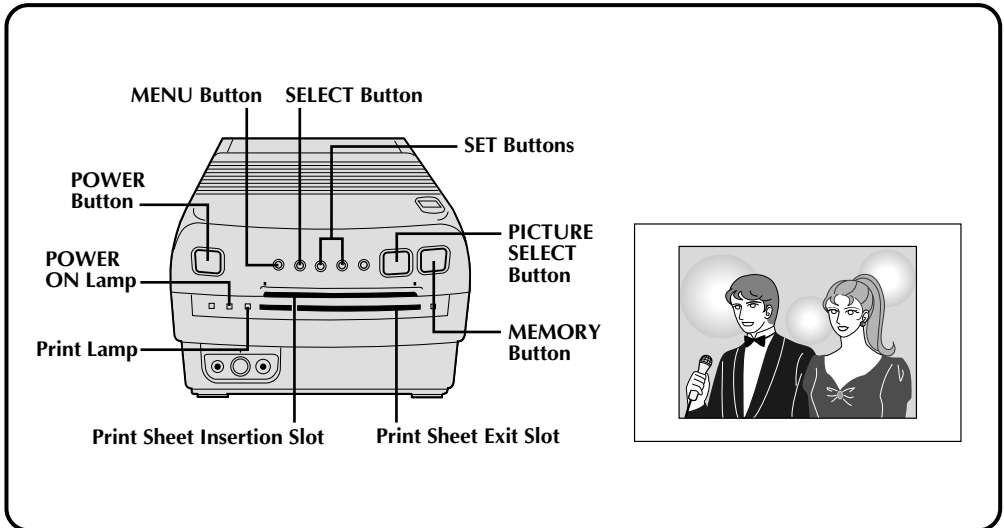

1 ACCESS PRINT MENU SCREEN

Press **MENU**. The Print Menu screen appears on the connected TV.

2 SELECT NO. OF SCENES

Press **SELECT** to place the pointer next to "MULTI PIX", then press **SET +/-** to cycle through until "OFF" appears.

3 CLOSE PRINT MENU

Press **MENU**. The Print Menu screen disappears, and setting is complete.

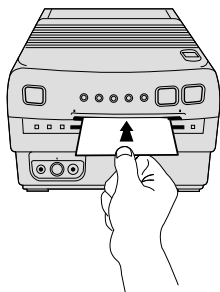

4 BEGIN SOURCE PLAYBACK

Fast-forward or rewind the source tape to find the desired scene, then start playback a little before the scene.

5 STORE DESIRED SCENE

Press **MEMORY** when the desired scene appears. The scene is stored in memory and appears on the screen.

6 PRINT SCENE

Insert a print sheet with the print side (the side with no writing on it) UP into the print sheet insertion slot until it is pulled in automatically.

- The Print Lamp comes on, indicating printing is in progress.
- “NOW PRINTING” appears on screen, on a blue background.
- When the Print Lamp starts blinking, printing is complete. Remove the print from the exit slot. The Print Lamp goes out.

If the stored image is shaky . . .

.... set “PIX STABILIZER” at the Print Menu to “ON”.

If you want to switch between the image being input and the stored image . . .

.... press **PICTURE SELECT**. The input image and the stored image appear on the connected TV alternately.

- * During printing, the image being input alternates with “NOW PRINTING” (appears on a blue background).
- * During printing, noise or color changing may be visible on the connected TV. This is normal and does not affect printing.

If you store the wrong scene . . .

.... press **PICTURE SELECT** so the input image appears, then find the correct scene and store it in memory.

If you want to print multiple copies of the same scene . . .

.... after printing, take the print sheet out of the exit slot. Insert a new print sheet in the insertion slot.

- * Do not attempt to insert a print sheet during printing, as this can result in malfunctions.

To print a “live” image using a camcorder as the source . . .

.... in step 4, instead of playing back the source tape, engage the camcorder’s Record mode.

If you’re using a JVC camcorder, you can store a scene you want to print by pressing the camcorder’s Start/Stop button (in place of the GV-PT1’s **MEMORY** button). Connect the camcorder’s Editing connector to the PAUSE Connector on the GV-PT1 using the camcorder’s supplied Editing cable (or a commercially available ϕ 3.5 Mini plug cable).

Setting The Print Menu

Options available in the menu are as shown in the chart.

PRINT MENU 1 / 2		2 / 2	
▶ PIX STABILIZER	: OFF	STROBE SPEED	: LOW
MULTI PIX	: OFF	ID NUMBER	: 20
CONTENT	: SELECTED PIX	LANGUAGE	: ENGLISH
TO SELECT	PUSH (SELECT)	TO SELECT	PUSH (SELECT)
TO SET	PUSH (+ , -)	TO SET	PUSH (+ , -)

Menu

ITEM	OPTIONS	APPLICATION
PIX STABILIZER	OFF	This is the default setting.
	ON	If the scene you want to print is shaking, select "ON" to stabilize it.
MULTI PIX	OFF	To print 1 scene per sheet.
	4	To print 4 equally sized scenes per sheet.
	16	To print 16 equally sized scenes per sheet.
CONTENT	SELECTED PIX	When printing multiple scenes on one sheet, select this option when you want a different image to appear in each section.
	SAME PIX	When printing multiple scenes on one sheet, select this option when you want the same scene to appear in each section.
	STROBE PIX	To print in Strobe Print format.
STROBE SPEED	HIGH	To print scenes at approximately 1/4 sec. intervals in Strobe Print format.
	LOW	To print scenes at approximately 1/2 sec. intervals in Strobe Print format.
ID Number	1—99	In the future, connection to and operation from a personal computer will be possible using the JLIP connector.

The shaded options represent factory settings. When you unplug the printer and plug it in again, all items indicated return to the factory settings.

* When printing with "PIX STABILIZER" set to "ON", there may be some loss of detail or clarity.

In this case, simply set "PIX STABILIZER" to "OFF".

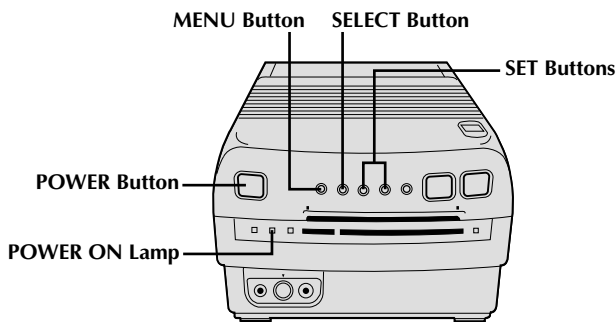

2

PRINT MENU 1 / 2

► PIX STABILIZER : OFF
 MULTI PIX : OFF
 CONTENT : SELECTED PIX
 TO SELECT PUSH (SELECT)
 TO SET PUSH (+, -)

2 / 2

STROBE SPEED : LOW
 ID NUMBER : 20
 LANGUAGE : ENGLISH
 TO SELECT PUSH (SELECT)
 TO SET PUSH (+, -)

1

TURN ON VIDEO PRINTER'S POWER

Press **POWER**. The Power On Lamp comes on.

2

ACCESS PRINT MENU

Press **MENU**. The Print Menu screen appears on the connected TV.

3

SELECT OPTIONS

Press **SELECT** to place the pointer next to the desired option.

4

MAKE CHOICES

Press **SET +/-** to cycle through each option's available settings.

5

CLOSE PRINT MENU

Press **MENU**. The screen disappears, and selection is complete.

Multi-Print (Same Scene)

You can print the same scene 4 or 16 times on one sheet.

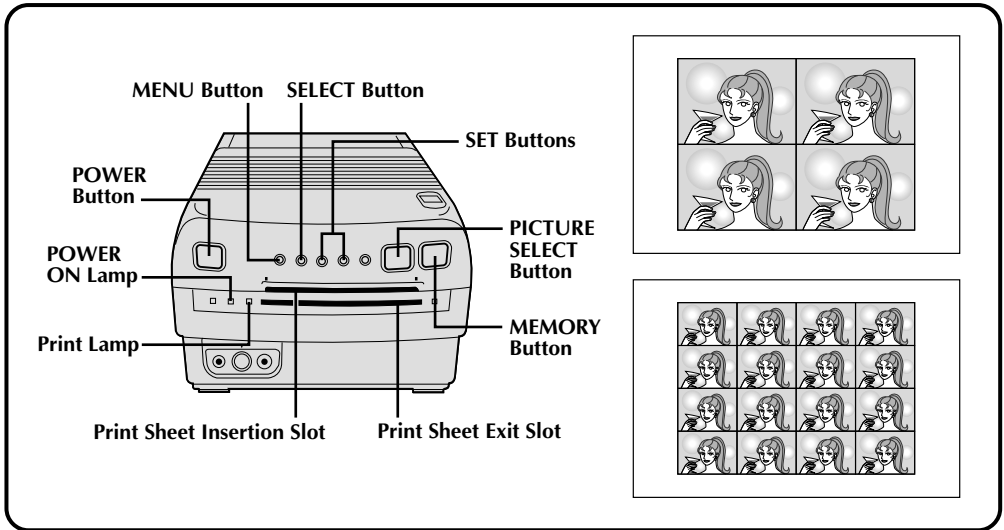

Preparation

- Connect the image source (camcorder, video cassette recorder) to the printer (☞ pg. 12).
- Install the ink sheet cartridge in the printer (☞ pg. 10)
- Plug in the printer and press **POWER**. The power comes on and the POWER ON Lamp lights.

2

PRINT MENU	1 / 2
PIX STABILIZER	: OFF
▶ MULTI PIX	: 16
CONTENT	: SELECTED PIX
TO SELECT	PUSH (SELECT)
TO SET	PUSH (+, -)

3

PRINT MENU	1 / 2
PIX STABILIZER	: OFF
MULTI PIX	: 16
▶ CONTENT	: SAME PIX
TO SELECT	PUSH (SELECT)
TO SET	PUSH (+, -)

1 ACCESS PRINT MENU
Press **MENU**. The Print Menu appears.

2 SELECT NO. OF SCENES
Place the pointer next to "MULTI PIX" by pressing **SELECT**, then set to "4" or "16" by pressing **SET +/-**.

3 SELECT PRINT CONTENT
Place the pointer next to "CONTENT" by pressing **SELECT**, then set to "SAME PIX" by pressing **SET +/-**.

4 CLOSE PRINT MENU
Press **MENU**. The Print Menu disappears, and selection is complete.

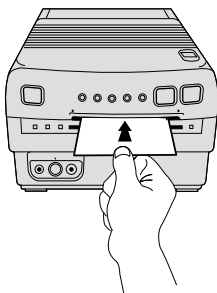
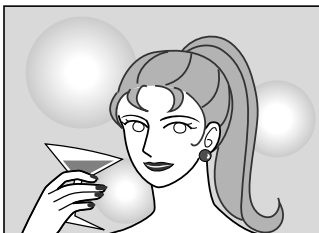

5 BEGIN SOURCE PLAYBACK

Fast-forward or rewind the source tape to find the desired scene, then start playback a little before the scene.

6 STORE SCENE FOR PRINTING MEMORY

When the desired scene is located, press **MEMORY**. The image appears on screen and is stored in memory.

- Only one image is stored in memory, regardless of the "MULTI PIX" setting.

7 PRINT STORED SCENE

Insert a print sheet with the print side (the side with no writing on it) UP into the print sheet insertion slot until it is pulled in automatically.

- The Print Lamp comes on, indicating printing is in progress.
- "NOW PRINTING" appears on screen, on a blue background.
- When the Print Lamp starts blinking, printing is complete. Remove the print from the exit slot. The Print Lamp goes out.
- The number of images printed depends on the selection you made in step 2.

If the stored image is shaky . . .

.... set "PIX STABILIZER" at the Print Menu to "ON".

If you want to switch between the image being input and the stored image . . .

.... press **PICTURE SELECT**. The input image and the stored image appear on the connected TV alternately.

- * During printing, the image being input alternates with "NOW PRINTING" (appears on a blue background).
- * During printing, noise or color changing may be visible on the connected TV. This is normal and does not affect printing.

If you store the wrong image . . .

.... press **PICTURE SELECT** so the input image appears, then find the correct image and store it in memory.

If you want to print multiple copies of the same image . . .

.... after printing, take the printed image out of the exit slot and insert a new print sheet in the insertion slot.

- * Do not attempt to insert a print sheet during printing, as this can result in malfunctions.

To print a "live" image using a camcorder as the source . . .

.... in step 5, instead of playing back the source tape, engage the camcorder's Record mode. If you're using a JVC camcorder, you can store a scene you want to print by pressing the camcorder's Start/Stop button (in place of the GV-PT1's **MEMORY** button). Connect the camcorder's Editing connector to the PAUSE Connector on the GV-PT1 using the camcorder's supplied Editing cable (or a commercially available ϕ 3.5 Mini plug cable).

Multi-Print (Different Scenes)

You can print various scenes on the same print sheet.

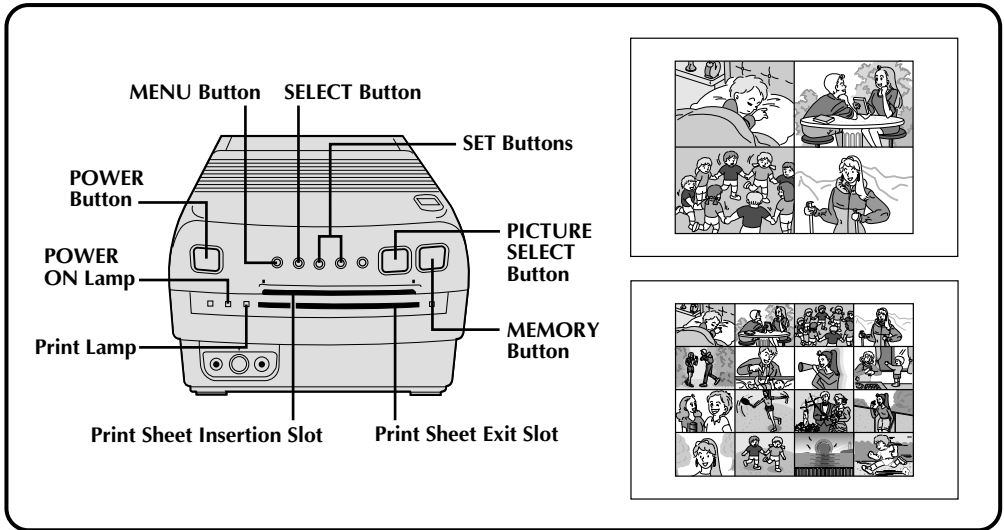

Preparation

- Connect the image source (camcorder, video cassette recorder) to the printer (☞ pg. 12).
- Install the ink sheet cartridge in the printer (☞ pg. 10).
- Plug in the printer and press **POWER**. The power comes on and the POWER ON Lamp lights.

2 and 3

PRINT MENU		1 / 2
PIX STABILIZER	:	OFF
▶ MULTI PIX	:	16
CONTENT	:	SELECTED PIX
TO SELECT	PUSH (SELECT)	▶
TO SET	PUSH (+, -)	

1 ACCESS PRINT MENU

Press **MENU**. The Print Menu appears.

2 SELECT NO. OF SCENES

Place the pointer next to "MULTI PIX" by pressing **SELECT**, then set to "4" or "16" by pressing **SET +/-**.

3 SELECT PRINT CONTENT

Make sure "CONTENT" is set to "SELECTED PIX". If not, place the pointer next to "CONTENT" by pressing **SELECT**, then set to "SELECTED PIX" by pressing **SET +/-**.

4 CLOSE PRINT MENU

Press **MENU**. The Print Menu disappears and selection is complete.

5 BEGIN SOURCE PLAYBACK

Fast-forward or rewind the source tape to find the desired scene, then start playback a little before the scene.

1	2
3	4

1	2	3	4
5	6	7	8
9	10	11	12
13	14	15	16

6 STORE DESIRED SCENE, SELECT POSITION

When the desired scene is located, press **MEMORY**. The scene appears on screen and is stored in memory.

- The next segment of the total image to be displayed darkens.

Now set the position of the stored image. Press **SET +/-** to move the shading to a different section of the image.

- Pressing “+” moves from “1” toward “4” (or “16” if you selected “16”), and pressing “-” moves in the reverse direction.

7 STORE AND POSITION ALL SCENES

Repeat step 6 for every scene you are going to print (a total of 4 or 16).

8 PRINT SCENES

Insert a print sheet with the print side (the side with no writing on it) UP into the insertion slot until it is pulled in automatically.

- The Print Lamp lights, indicating printing is in progress.
- “NOW PRINTING” appears on screen, on a blue background.
- When the Print Lamp starts blinking, printing is complete. Remove the print from the exit slot. The Print Lamp goes out.

If the stored image is shaky . . .

..... set “PIX STABILIZER” in the Print Menu to “ON”. This should stabilize the image.

If you store the wrong scene . . .

..... press **PICTURE SELECT** and the stored image appears on screen. Then press **SET +/-** to cycle through the images until the incorrect one appears, and press **PICTURE SELECT** again to return to the source image display. You can now store the image you want in its place.

If you want to switch between the image being input and the stored image . . .

..... press **PICTURE SELECT**. The connected TV screen switches between the source image and the stored image.

- * During printing, the image being input alternates with “NOW PRINTING” (appears on a blue background).
- * During printing, noise or color changing may be visible on the connected TV. This is normal and does not affect printing.

To print multiple copies of the same set of scenes . . .

..... after the first sheet comes out the exit slot, put another in the insertion slot to print as before. Repeat as many times as desired.

- * Do not attempt to insert a print sheet during printing, as this can result in malfunctions.

To print a “live” image using a camcorder as the source . . .

..... in step 5, instead of playing back the source tape, engage the camcorder’s Record mode. If you’re using a JVC camcorder, you can store a scene you want to print by pressing the camcorder’s Start/Stop button (in place of the GV-PT1’s **MEMORY** button). Connect the camcorder’s Editing connector to the PAUSE Connector on the GV-PT1 using the camcorder’s supplied Editing cable (or a commercially available ϕ 3.5 Mini plug cable).

Inset Print

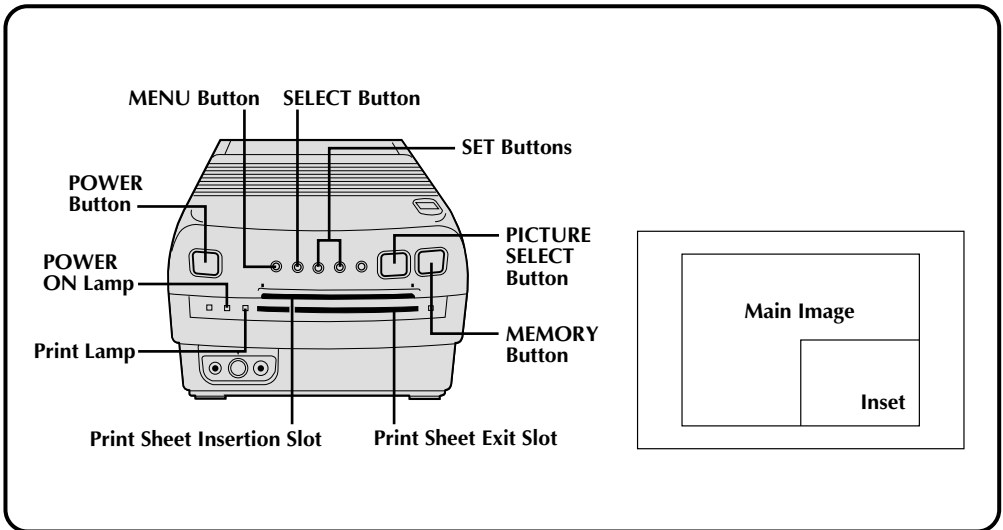

Preparation

- Connect the image source (camcorder, video cassette recorder) to the printer (☞ pg. 12).
- Install the ink sheet cartridge in the printer (☞ pg. 10).
- Plug in the printer and press **POWER**. The power comes on and the POWER ON Lamp lights.

1 PRINT MENU 1/2
 PIX STABILIZER : OFF
 ▶ MULTI PIX : OFF
 CONTENT : SELECTED PIX
 TO SELECT PUSH (SELECT)
 TO SET PUSH (+, -)

2 PRINT MENU 1/2
 PIX STABILIZER : OFF
 ▶ MULTI PIX : 4
 CONTENT : SELECTED PIX
 TO SELECT PUSH (SELECT)
 TO SET PUSH (+, -)

1 STORE MAIN IMAGE

Perform steps 1 – 5 on page 14.
 • Set “MULTI PIX” to “OFF”.

2 SET SIZE OF INSET IMAGE

At the Print Menu, set “MULTI PIX” to “4” or “16”.
 • Selecting “4” makes the inset image 1/4 the size of the full image, and “16” results in an inset 1/16 to size of the full image.

3 SET POSITION OF INSET IMAGE

Press **SET +/-** to move the shading around the image.

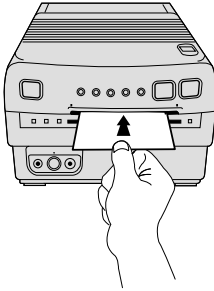
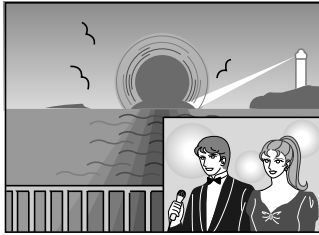
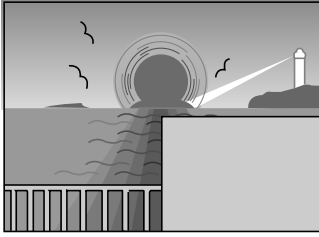

4 LOCATE/STORE INSET IMAGE

Press **PICTURE SELECT** to return to the source image display. Then fast-forward or rewind to locate the desired image, and press **MEMORY**.

- To add more insets to the main image, repeat steps 3 and 4.

5 PRINT IMAGE

Insert a print sheet with the print side (the side with no writing on it) UP into the insertion slot until it is pulled in automatically.

- The Print Lamp lights, indicating printing is in progress.
- “NOW PRINTING” appears on screen, on a blue background.
- When the Print Lamp starts blinking, printing is complete. Remove the print from the exit slot. The Print Lamp goes out.

If the stored image is shaky . . .

..... set “PIX STABILIZER” in the Print Menu to “ON”. This should stabilize the image.

If you want to add an inset to a 4-scene print . . .

..... set “MULTI PIX” to “4” in step 1, then change the setting to “16” in step 2. This results in a 1/16-size inset on a 1/4-size scene.

If you want to switch between the image being input and the stored image . . .

..... press **PICTURE SELECT**. The input image and the stored image appear on the connected TV alternately.

- * During printing, the image being input alternates with “NOW PRINTING” (appears on a blue background).
- * During printing, noise or color changing may be visible on the connected TV. This is normal and does not affect printing.

If you store the wrong scene . . .

..... press **PICTURE SELECT** and the stored scene appears on screen. Then press **SET +/-** to cycle through the scenes until the incorrect one appears, and press **PICTURE SELECT** again to return to the source image display. You can now store the scene you want in its place.

To print multiple copies of the same image . . .

..... after the first print sheet comes out the exit slot, put another in the insertion slot and print as before.

- * Do not attempt to insert a print sheet during printing, as this can result in malfunctions.

To print a “live” image using a camcorder as the source . . .

..... in steps 1 and 4, instead of playing back the source tape, engage the camcorder’s Record mode. If you’re using a JVC camcorder, you can store a scene you want to print by pressing the camcorder’s Start/Stop button (in place of the GV-PT1’s **MEMORY** button). Connect the camcorder’s Editing connector to the PAUSE Connector on the GV-PT1 using the camcorder’s supplied Editing cable (or a commercially available ϕ 3.5 Mini plug cable).

Strobe Print

The printer stores a selected number of images at short intervals, and prints them on one sheet.

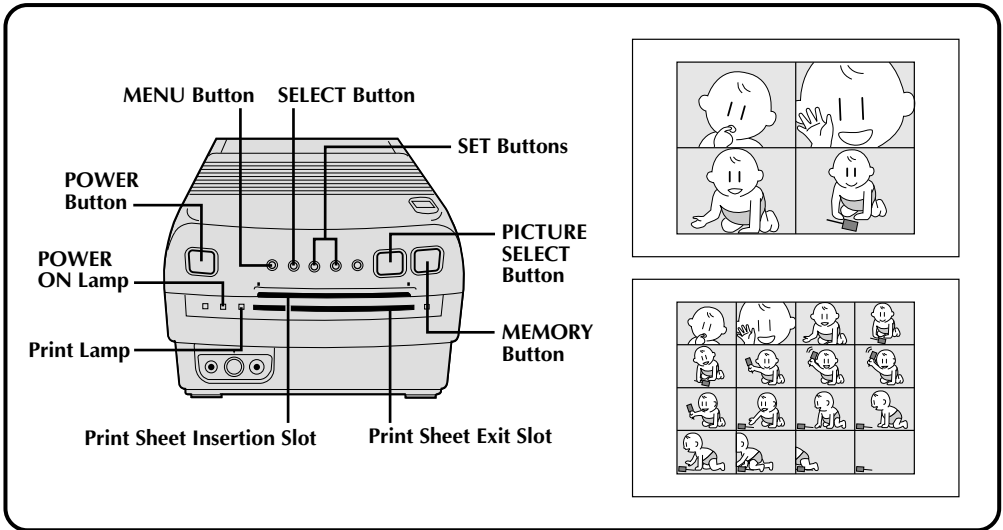

Preparation

- Connect the image source (camcorder, video cassette recorder) to the printer (☞ pg. 12).
- Install the ink sheet cartridge in the printer (☞ pg. 10).
- Plug in the printer and press **POWER**. The power comes on and the POWER ON Lamp lights.

2

PRINT MENU	1/2
PIX STABILIZER	: OFF
▶ MULTI PIX	: 4
CONTENT	: SELECTED PIX
TO SELECT	PUSH (SELECT)
TO SET	PUSH (+, -)

PRINT MENU	1/2
PIX STABILIZER	: OFF
MULTI PIX	: 16
▶ CONTENT	: STROBE PIX
TO SELECT	PUSH (SELECT)
TO SET	PUSH (+, -)

	2/2
▶ STROBE SPEED	: HIGH
ID NUMBER	: 20
LANGUAGE	: ENGLISH
TO SELECT	PUSH (SELECT)
TO SET	PUSH (+, -)

1

ACCESS PRINT MENU

Press **MENU**. The Print Menu appears.

2

SET PARAMETERS

Set "MULTI PIX" to "4" or "16". Then set "CONTENT" to "STROBE PIX", and set "STROBE SPEED" to either "HIGH" or "LOW".

3

CLOSE PRINT MENU

Press **MENU**. The Print Menu disappears, and selection is complete.

4

BEGIN SOURCE PLAYBACK

Fast-forward or rewind the source tape to locate the desired scene, then start playback a little before the scene.

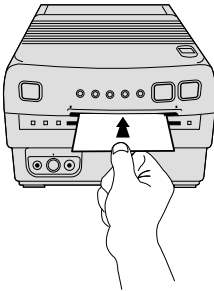
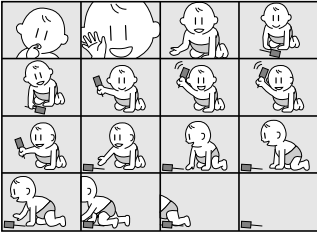
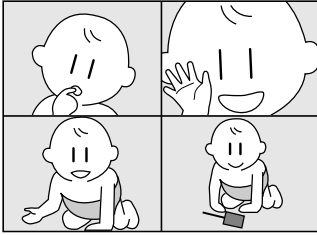

5 STORE DESIRED SCENE

When the scene appears, press **MEMORY**.

- When “STROBE SPEED” is set to “HIGH”, the printer stores images approximately every 1/4 of a second, and when set to “LOW”, images are stored approximately every 1/2 a second.
- Once the selected number of images has been stored, the input image is replaced on the screen by the most recently stored image.

6 PRINT IMAGE

Insert a print sheet with the print side (the side with no writing on it) UP into the insertion slot until it is pulled in automatically.

- The Print Lamp lights, indicating printing is in progress.
- “NOW PRINTING” appears on screen, on a blue background.
- When the Print Lamp starts blinking, printing is complete. Remove the print from the exit slot. The Print Lamp goes out.

If the stored image is shaky . . .

..... set “PIX STABILIZER” in the Print Menu to “ON”. This should stabilize the image.

If you want to switch between the image being input and the stored image . . .

..... press **PICTURE SELECT**. The input image and the stored image appear on the connected TV alternately.

* During printing, the image being input alternates with “NOW PRINTING” (appears on a blue background).

* During printing, noise or color changing may be visible on the connected TV. This is normal and does not affect printing.

If you store the wrong scene . . .

..... press **PICTURE SELECT** and the stored scene appears on screen. Then press **SET +/-** to cycle through the scenes until the incorrect one appears, and press **PICTURE SELECT** again to return to the source image display. You can now store the scene you want in its place.

To print multiple copies of the same image . . .

..... after the first print sheet comes out the exit slot, put another in the insertion slot and print as before.

* Do not attempt to insert a print sheet during printing, as this can result in malfunctions.

To print a “live” image using a camcorder as the source . . .

..... in step 4, instead of playing back the source tape, engage the camcorder’s Record mode. If you’re using a JVC camcorder, you can store a scene you want to print by pressing the camcorder’s Start/ Stop button (in place of the GV-PT1’s **MEMORY** button). Connect the camcorder’s Editing connector to the PAUSE Connector on the GV-PT1 using the camcorder’s supplied Editing cable (or a commercially available ϕ 3.5 Mini plug cable).

Title Impose

You can print a scene or image with your own handwritten characters or drawing imposed on it. The title or drawing will cover the entire image area of the print sheet, regardless of the "MULTI PIX" setting.

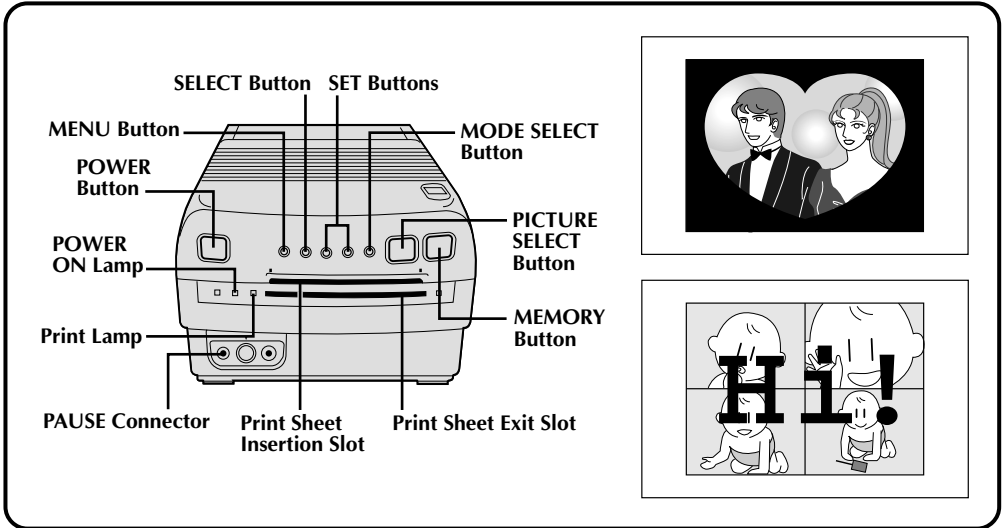

Preparation

- Connect the image source (camcorder, video cassette recorder) to the printer (☞ pg. 12).
- Install the ink sheet cartridge in the printer (☞ pg. 10).
- Plug in the printer and press **POWER**. The power comes on and the POWER ON Lamp lights.

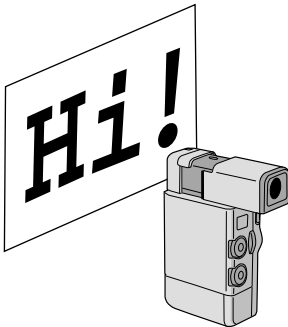
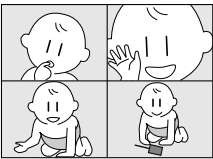

1 STORE DESIRED IMAGE

Use any of the methods described on pages 14, 15 and 19 – 25.

2 RECORD TITLE/DRAWING

Press **PICTURE SELECT** so that the input image is displayed. Then record the handwritten title or drawing using a camcorder.

- To ensure that your title or drawing is clearly visible and has sufficient contrast with the image, use a dark-colored pen, pencil or marker on white or light-colored paper. Make sure the lines are wide and the figures large.

3 ACCESS MODE SELECT MENU

Press **MODE SELECT**. The Mode Select Menu appears.

4

MODE SELECT MENU

- ▶ **TITLE**
- SNAP SHOT PRINTING**
- EDITING INDEX**
- QUIT**

TO SELECT PUSH (SELECT)
TO SET PUSH (MODE SELECT)

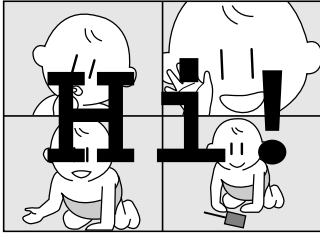

4

SELECT MODE

Place the pointer next to "TITLE" by pressing **SELECT**, then press **MODE SELECT**.

- The Mode Select Menu disappears, and the image with the title or drawing imposed on it appears on screen.

5

SET CONDITION AND COLOR

Pressing **SELECT** reverses the transparent and opaque portions of the title or drawing.

To change the color, press **SET +/-**. The colors change as follows:

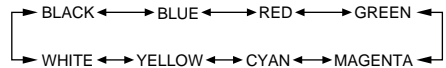
**6 STORE TITLE IMPOSE IMAGE**

Press **MEMORY**, and the image is stored. The Title Impose mode is deactivated.

- To impose multiple titles on the same image, repeat steps 2 – 6.

7 PRINT STORED IMAGE

Insert a print sheet with the print side (the side with no writing on it) UP into the print sheet insertion slot until it is pulled in automatically.

- The Print Lamp comes on and printing begins.
- When the Print Lamp starts blinking, printing is complete. Remove the print from the exit slot. The Print Lamp goes out.

If the stored image is shaky . . .

..... set "PIX STABILIZER" at the Print Menu to "ON".

If you want to switch between the image being input and the stored image . . .

..... press **PICTURE SELECT**. The input image and the stored image appear on the connected TV alternately.

- * During printing, the image being input alternates with "NOW PRINTING" (appears on a blue background).
- * During printing, noise or color changing may be visible on the connected TV. This is normal and does not affect printing.

If you want to print multiple copies of the same image . . .

..... after the first sheet comes out the exit slot, put another in the insertion slot to print as before. Repeat as many times as desired.

- * Do not attempt to insert a print sheet during printing, as this can result in malfunctions.

If you want to change the title or drawing . . .

..... before pressing **MEMORY** in step 6, access the Mode Select Menu by pressing **MODE SELECT**. Place the pointer next to "QUIT" by pressing **SELECT**, then repeat steps 2 through 5.

Once you press **MEMORY** in step 6, you can't change only the title or drawing. In this case, repeat the entire procedure from step 1.

To print a "live" image using a camcorder as the source . . .

..... in step 1, instead of playing back the source tape, engage the camcorder's Record mode. If you're using a JVC camcorder, you can store a scene you want to print by pressing the camcorder's Start/Stop button (in place of the GV-PT1's **MEMORY** button). Connect the camcorder's Editing connector to the PAUSE Connector on the GV-PT1 using the camcorder's supplied Editing cable (or a commercially available ϕ 3.5 Mini plug cable).

If you want to print the image being recorded . . .

..... instead of starting source playback in step 1, engage the camcorder's Record mode. To store the desired image, press the camcorder's Start/Stop button. Connect the camcorder's editing connector to the printer's PAUSE Connector using the editing cable supplied with the camcorder, or using a commercially available ϕ 3.5 mini plug (see pg. 12).

Snapshot Print

If you have a JVC camcorder with a Snapshot Search function (such as the GR-SV7 and GR-DV1), you can easily locate and print snapshots.

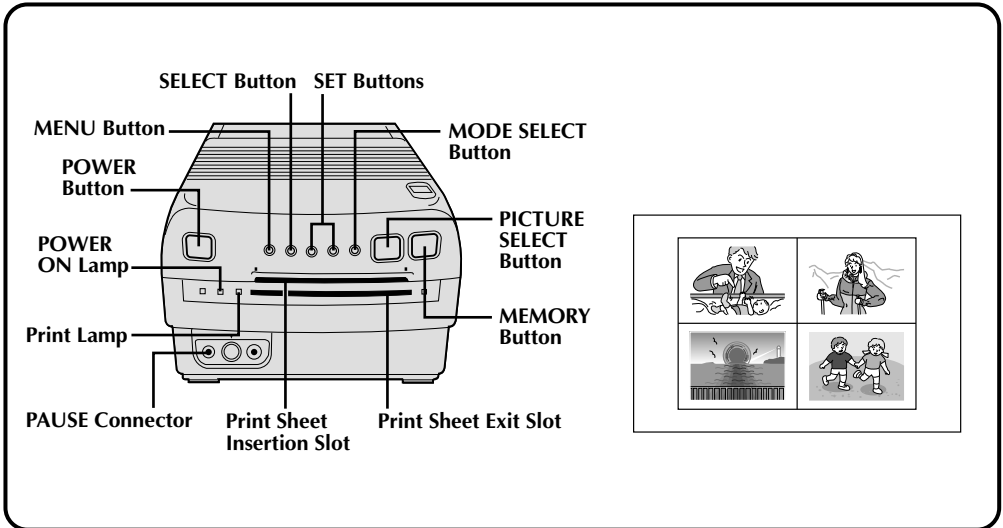

Preparation

- Connect the image source (camcorder, video cassette recorder) to the printer (☞ pg. 12).
- Install the ink sheet cartridge in the printer (☞ pg. 10).
- Plug in the printer and press **POWER**. The power comes on and the **POWER ON Lamp** lights.
- Connect the camcorder's editing connector to the **PAUSE Connector** on the printer using the editing cable supplied with the camcorder, or a commercially available ϕ 3.5 mini plug.

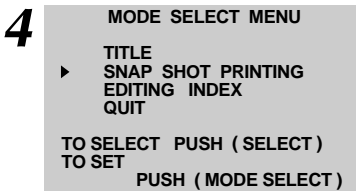
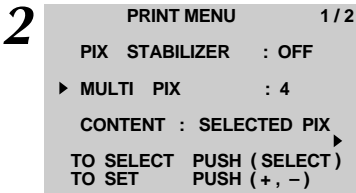

1 ACCESS PRINT MENU

Press **MENU**. The Print Menu appears.

2 SELECT NO. OF SCENES

Set "MULTI PIX" for "OFF", "4" or "16" as desired.

3 ACCESS MODE SELECT MENU

Press **MODE SELECT**. The Mode Select Menu appears.

4 SELECT MODE

Place the pointer next to "SNAP SHOT PRINTING" by pressing **SELECT**, then press **MODE SELECT**.

- The Mode Select Menu disappears and the Snapshot print mode is activated.

5 LOCATE DESIRED SCENE

Rewind the tape in the camcorder to the scene you want to print, then pause the tape.

6 STORE SNAPSHOT

Press the camcorder's Snapshot button. The camcorder automatically locates the beginning of the snapshot, and the printer stores the scene.

- Once the selected number of images has been stored, "STOP PLAYBACK MACHINE" appears on screen. Press the Stop button on the camcorder.

7 PRINT SNAPSHOT

Insert a print sheet with its print side (the side with no writing on it) UP into the insertion slot until it is pulled in automatically.

- The Print Lamp lights, indicating printing is in progress.
- "NOW PRINTING" appears on screen, on a blue background.
- When the Print Lamp starts blinking, printing is complete. Remove the print from the exit slot. The Print Lamp goes out.

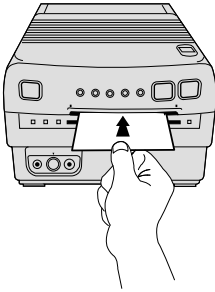

If the stored image is shaky . . .

..... set "PIX STABILIZER" in the Print Menu to "ON". This should stabilize the image.

If you have activated "MULTI PIX" . . .

..... the next segment of the total image to be printed darkens. To store the new scene where a scene has already been stored, press **SET +/-** to darken the desired segment. However, if no other scenes have yet been stored, or if all available locations are filled, you cannot change the location of the new scene.

If you want to switch between the image being input and the stored image . . .

..... press **PICTURE SELECT**. The input image and the stored image appear on the connected TV alternately.

* During printing, the image being input alternates with "NOW PRINTING" (appears on a blue background).

* During printing, noise or color changing may be visible on the connected TV. This is normal and does not affect printing.

If the source tape contains snapshots taken in Motor Drive mode . . .

..... you cannot print these snapshots using Snapshot Print. Access the Print Menu, set "MULTI PIX" to "4" or "16" and set "CONTENT" to "SELECTED PIX" to print these scenes.

If you want to print before all scenes have been stored . . .

..... press the Stop button on the camcorder, then insert a print sheet in the insertion slot. Any sections on the print not filled with a scene will be white.

To exit the Snapshot mode . . .

..... place the pointer next to "QUIT" in the Mode Select Menu by pressing **SELECT**, then press **MODE SELECT**. The screen disappears.

To print multiple copies of the same scene . . .

..... after the first print sheet comes out the exit slot, put another in the insertion slot and print as before.

* Do not attempt to insert a print sheet during printing, as this can result in malfunctions.

Editing Index

While editing the source tape, using Random Assemble Editing (available on selected JVC camcorders and VCRs), you can store and print out the scenes at the Edit-In and Edit-Out points you've registered. This allows you to make an editing index.

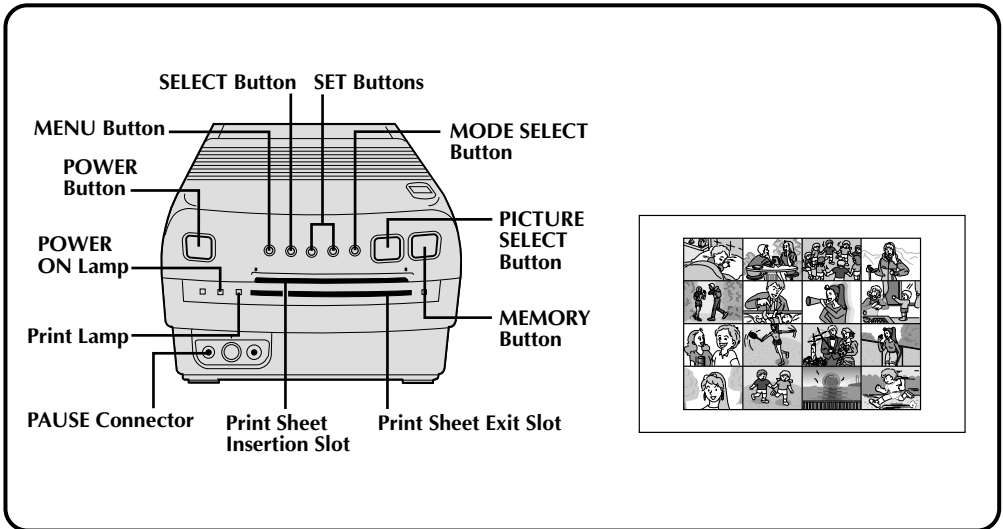

Preparation

- Install the ink sheet cartridge in the printer (☞ pg. 10).
- Plug in the printer and press **POWER**. The power comes on and the POWER ON Lamp lights.

	IN	OUT
1	0:00:25	0:01:05
2	0:03:18	0:03:31
3	0:02:33	0:02:53
▶ 4	0:04:11	
5		
6		
7		
8		
COUNTER	0:04:11	
TOTAL	0:01:13	

Random Assemble Editing selection screen

1 PERFORM RANDOM ASSEMBLE EDITING

See your camcorder and video cassette recorder instruction manuals for editing procedures.

- After editing, the Random Assemble Editing selection screen appears.

2 CONNECT IMAGE SOURCE TO PRINTER

Connect either the camcorder or the video cassette recorder to the printer's PAUSE Connector using the editing cable supplied with the camcorder, or a commercially available ϕ 3.5 mini plug, and a video cable.

3 ACCESS MODE SELECT MENU

Press **MODE SELECT**. The Mode Select Menu appears.

4

MODE SELECT MENU

TITLE
 SNAP SHOT PRINTING
 ▶ EDITING INDEX
 QUIT

TO SELECT PUSH (SELECT)
 TO SET PUSH (MODE SELECT)

1	→ 2	→ 3	→ 4
5	6	7	8
9	10	11	12
13	14	15	16

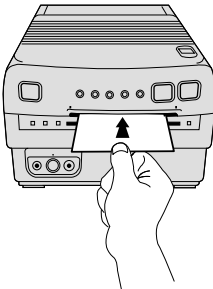

4

SELECT MODE

Place the pointer next to "EDITING INDEX" by pressing **SELECT**, then press **MODE SELECT**.

- The Mode Select Menu disappears and the Editing Index mode is activated.
- In this mode, one sheet is divided into 16 equal sections, regardless of the "MULTI PIX" setting in the Print Menu.

5

ENGAGE SOURCE EDIT START MODE

Edit indexing begins, and the Edit-In and Edit-Out points are automatically stored in the printer's memory (1, 2, 3 and so on in ascending order).

- If you edited 8 scenes (a total of 16 "in" and "out" points), once they are all stored "MEMORY FULL" appears on screen.
- If you edited less than 8 scenes, the sections not filled with scenes will be white.

6

PRINT STORED SCENES

Insert a print sheet with its print side (the side with no writing on it) UP into the insertion slot until it is pulled in automatically.

- The Print Lamp lights, indicating printing is in progress.
- "NOW PRINTING" appears on screen, on a blue background.
- When the Print Lamp starts blinking, printing is complete. Remove the print from the exit slot. The Print Lamp goes out.

If the stored image is shaky . . .

.... set "PIX STABILIZER" in the Print Menu to "ON". This should stabilize the image.

If you want to switch between the image being input and the stored image . . .

.... press **PICTURE SELECT**. The input image and the stored image appear on the connected TV alternately.

- * During printing, the image being input alternates with "NOW PRINTING" (appears on a blue background).
- * During printing, noise or color changing may be visible on the connected TV. This is normal and does not affect printing.

To exit the Editing Index mode . . .

.... after printing, place the pointer next to "QUIT" in the Mode Select Menu by pressing **SELECT**, then press **MODE SELECT**. The screen disappears.

To print multiple copies of the same scene . . .

.... after the first print sheet comes out the exit slot, put another in the insertion slot and print as before.

- * Do not attempt to insert a print sheet during printing, as this can result in malfunctions.

Message	<ul style="list-style-type: none"> ● Appears in this situation ■ How to clear indication
CLOSE DOOR	<ul style="list-style-type: none"> ● When the lid is not securely closed. ■ Press PUSH to close the lid (☞ pg. 10).
PAPER JAM POWER OFF/REMOVE PAPER	<ul style="list-style-type: none"> ● When a print sheet or the ink sheet is caught inside the printer. ■ Open the lid, remove the ink sheet cartridge, then remove the problem sheet (☞ pg. 10).
LOAD INK SHEET	<ul style="list-style-type: none"> ● There is no ink sheet cartridge installed, or the one installed is used up. ■ Install an ink sheet cartridge (☞ pg. 10).
REMOVE PAPER	<ul style="list-style-type: none"> ● When you turn on the power and there is a print sheet inside the printer. ■ Open the lid and remove the print sheet (☞ pg. 10).
HIGH TEMPERATURE WAIT A WHILE	<ul style="list-style-type: none"> ● When the printer's temperature gets too high and printing becomes impossible. ■ Turn off the power, wait a few minutes and then turn it on again. Confirm that the error message has disappeared before trying to use the printer.
MEMORY FULL	<ul style="list-style-type: none"> ● When you press MEMORY after having stored the selected number of snapshots, or when you have stored 8 Edit-In and 8 Edit-Out points. ■ Start printing, or access the Mode Select Menu screen (☞ pg. 27).
STOP PLAYBACK MACHINE	<ul style="list-style-type: none"> ● When you have stored the selected number of snapshots. ■ Start printing, or access the Mode Select Menu screen (☞ pg. 28).
NO SIGNAL	<ul style="list-style-type: none"> ● When you press MEMORY without having connected an image source. ■ Make sure the image source is properly connected, then engage its Play mode [or Record mode if using a camcorder].
NOW PRINTING	<ul style="list-style-type: none"> ● When printing is being performed. ■ Disappears when printing is finished.
NO IMAGE IN MEMORY	<ul style="list-style-type: none"> ● When you try to print without having stored a scene. ■ Remove the print sheet, then store a scene using any of the described methods.

SYMPTOM	POSSIBLE CAUSE	CORRECTIVE ACTION
The power doesn't come on.	<ul style="list-style-type: none"> ● The video printer's power cord is not plugged into an AC outlet. 	<ul style="list-style-type: none"> ● Plug the power cord into an AC outlet.
The error lamp lights or begins blinking.	<ul style="list-style-type: none"> ● An error message appears on the connected TV's screen. ● A malfunction has occurred but no message appears. 	<ul style="list-style-type: none"> ● Refer to the list of error messages (☞ pg. 32). ● Turn off the video printer's power, unplug the power cord and plug it in again, then turn the power back on. If the trouble does not clear, contact your JVC dealer.
The video from the connected image source does not appear on the connected TV.	<ul style="list-style-type: none"> ● The video cable is not properly connected. ● The connected TV has not been set to its Video input mode. ● The image source input signal has been superceded by a priority input. 	<ul style="list-style-type: none"> ● Connect the video cable correctly (☞ pg. 12). ● Set the TV to its Video mode. ● Disconnect all higher priority inputs (☞ pg. 9, 13 and also refer to the TV's instruction manual).
The image on the connected TV is frozen.	<ul style="list-style-type: none"> ● You're looking at a stored image, not the input image. 	<ul style="list-style-type: none"> ● Press PICTURE SELECT to view the input image.
The stored image has disappeared.	<ul style="list-style-type: none"> ● After storing the image, the video printer's power was turned off. 	<ul style="list-style-type: none"> ● Turning off the power erases all stored images. To retain images, do not turn the power off.
The inserted print sheet comes out several times during printing.	<ul style="list-style-type: none"> ● This video printer employs the 3-color consecutive printing method (Yellow, Magenta, Cyan). As each color is printed, the print sheet protrudes partially from the video printer. This is normal. Do not attempt to remove the print sheet until the Print Lamp stops blinking but stays lit, signaling the end of printing. 	
During Multi-Print, the size of the shaded segment changes.	<ul style="list-style-type: none"> ● When using the Multi-Print mode set to either 4 or 16, the segment where a scene is to be stored may change in size depending on the TV or the image source used. This is not a malfunction. The actual size of the printed image, or the position in which it is to be stored, do not change. 	
The color of a printed image is thin or incorrect.	<ul style="list-style-type: none"> ● The ink sheet cartridge being used does not match the print medium. ● The color seen on the connected TV and the actual color of the image may differ slightly. This is not a malfunction. 	<ul style="list-style-type: none"> ● Make sure you use the ink sheet cartridge appropriate for the type of print sheets in use (☞ pg. 11).
The Strobe print mode doesn't work.	<ul style="list-style-type: none"> ● "CONTENT" in the Print Menu is set for "SELECTED PIX". 	<ul style="list-style-type: none"> ● Set "CONTENT" for "STROBE PIX" (☞ pg. 24).
An unusual image appears on the connected TV.	<ul style="list-style-type: none"> ● The Title Impose mode is activated. 	<ul style="list-style-type: none"> ● Access the Mode Select Menu and deactivate the Title Impose mode (☞ pg. 27).
Detailed portions of the print don't come out clearly.	<ul style="list-style-type: none"> ● "PIX STABILIZER" was set to "ON" during printing. 	<ul style="list-style-type: none"> ● Set "PIX STABILIZER" to "OFF" and try printing the image again.

Printer Jam

If a print sheet gets stuck inside the printer, follow these steps to remove it:

1 OPEN LID, REMOVE INK SHEET CARTRIDGE

Move the slide knob in the direction of the arrow. The lid springs open, so apply gentle pressure to the top when opening (☞ pg. 10).

2 REMOVE PROBLEM SHEET

If the ink sheet, or a print sheet, is caught in the roller and can't be removed, close the lid and shut off the printer's power. Then turn the power back on.

3 RE-INSTALL INK SHEET CARTRIDGE, CLOSE LID

While holding the "☐" portion of the ink sheet cartridge, position it at the proper angle, insert and push in until you hear it click (☞ pg. 10).

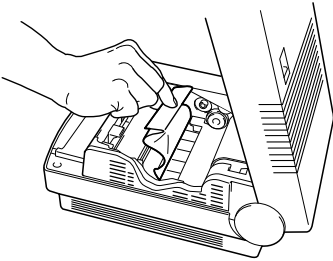

Cleaning The Thermal Heads

The thermal heads may be in need of cleaning. If the heads become covered with dust or dirt, print quality will drop. Use a cotton swab to clean the heads. If this doesn't remove the dirt, please consult your nearest JVC dealer or Technical Service Center.

1 OPEN LID

See page 10.

2 CLEAN HEADS

Clean thoroughly using a clean cotton swab. Using anything else could result in scratches which could cause a head malfunction.

3 CLOSE LID

See page 10.

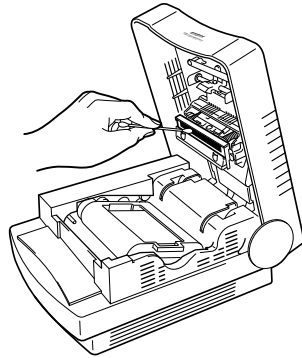

CAUTIONS:

- The thermal heads on the underside of the door can become hot. Be careful not to touch them when opening or closing the door.
- It's a good idea to turn off the printer's power and wait for a short time before opening the door, to give the thermal heads a chance to cool.

Power	: AC 120 V ~, 60 Hz
Power consumption	
During printing	: Approx. 74 W
When idle	: Approx. 13 W
Signal	: NTSC standard
Print format	: Sublimation dye thermal transfer line printing
Print quality	
Resolution	: 704 (horiz.) x 464 (vert.) dots
Gradation	: 256 tones
Print medium	
Ink sheet (dedicated)	: Cartridge 3-color consecutive printing (yellow, magenta, cyan)
Print sheet (dedicated)	: Paper size 150 x 100 mm Print area 103 x 79 mm
Connectors	
S-Video input	: S-connector (front x 1, rear x 1)
Normal video input	: Pin jack (RCA connector) (front x 1, rear x 1) (1.0 V p – p, 75 Ω unbalanced)
Normal output	: Pin jack (RCA connector) (Rear x 1) (1.0 V p – p, 75 Ω unbalanced)
Remote pause	: φ 3.5 mm Mini jack (bipolar)
JLIP	: φ 3.5 mm Mini jack (four poles)
Operating temperature	: +5 — +35°C (+41 — +95°F)
Operating humidity	: 35 — 80%
Storage temperature	: –20 — +60°C (–4 — +140°F)
Operating position	: Level (horizontal) ±5°
Dimensions	: 200 W x 116 H x 280 D mm (7-7/8" x 4-5/8" x 11-1/16")
Weight	: Approx. 3.4 kg (7.5 lbs)
Provided accessories	: Print sheet set VU-PS50U (standard print paper and ink sheet cartridge) Conversion plug

- Design and specifications subject to change without notice.

C	
Content	☞ pg. 16
E	
Editing Index	☞ pg. 30
Error Message	☞ pg. 32
I	
ID Number	☞ pg. 16
Ink Sheet Cartridge	☞ pg. 10
Inset Image	☞ pg. 22
Inset Print	☞ pg. 22
M	
Main Image	☞ pg. 22
Mode Select Menu	☞ pg. 27
Motor Drive	☞ pg. 29
Multi-Print (Different Scenes)	☞ pg. 20
Multi-Print (Same Scene)	☞ pg. 18
N	
No. Of Scenes	☞ pg. 18
P	
Paper Jam	☞ pg. 34
Paper Sheet Set	☞ pg. 11
PIX STABILIZER	☞ pg. 16
Print Menu	☞ pg. 13
Print Sheet	☞ pg. 11
Protective Clip	☞ pg. 10
S	
Snapshot Print	☞ pg. 28
Snapshot Search	☞ pg. 28
Stored Image	☞ pg. 15
Strobe Print	☞ pg. 24
Strobe Speed	☞ pg. 16
T	
Thermal Heads	☞ pg. 10
Title Impose Print	☞ pg. 26



JVC

JVC COMPANY OF AMERICA
DIVISION OF US JVC CORP.
41 Slater Drive, Elmwood Park, N.J. 07407

JVC CANADA INC.
21 Finchdene Square, Scarborough Ontario M1X 1A7



Free Manuals Download Website

<http://myh66.com>

<http://usermanuals.us>

<http://www.somanuals.com>

<http://www.4manuals.cc>

<http://www.manual-lib.com>

<http://www.404manual.com>

<http://www.luxmanual.com>

<http://aubethermostatmanual.com>

Golf course search by state

<http://golfingnear.com>

Email search by domain

<http://emailbydomain.com>

Auto manuals search

<http://auto.somanuals.com>

TV manuals search

<http://tv.somanuals.com>