

JVC



MULTIMEDIA PRINTER

GV-PT2

ENGLISH

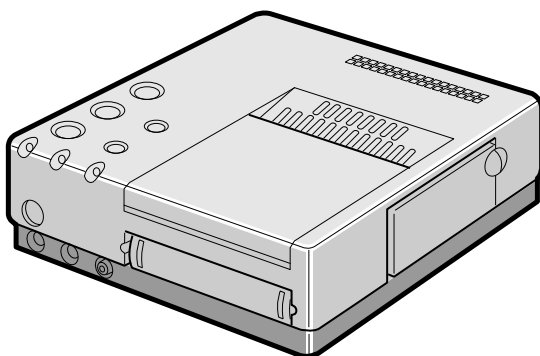

INSTRUCTIONS

For Customer Use:

Enter below the Serial No. of the
GV-PT2U Multimedia Printer.
The serial number is located on the
bottom of the GV-PT2U.

Model No. **GV-PT2U**

Serial No. _____

Dear Customer,

Thank you for purchasing this Multimedia Printer. Before use, please read the safety information and precautions contained in the following pages to ensure safe use of this product.

Using This Instruction Manual

- All major sections and subsections are listed in the Table Of Contents (☞ pg. 8, 9).
- Notes appear after most subsections. Be sure to read these as well.
- Basic and advanced features/operation are separated for easier reference.

It is recommended that you . . .

- refer to "Controls, Indicators and Connectors" (☞ pgs. 10 – 12) and familiarize yourself with button locations, etc. before use.
- read thoroughly the Safety Precautions and Safety Instructions that follow. They contain extremely important information regarding the safe use of your new Multimedia Printer.

You are recommended to carefully read the cautions on page 5 before use.

INFORMATION

This device complies with Part 15 of FCC Rules. Operation is subject to the following two conditions: (1) This device may not cause harmful interference, and (2) this device must accept any interference received, including interference that may cause undesired operation. Change or modifications not approved by the party responsible for compliance could void the user's authority to operate the equipment. This equipment has been tested and found to comply with the limits for a Class B digital device, pursuant to Part 15 of the FCC Rules. These limits are designed to provide reasonable protection against harmful interference in a residential installation. This equipment generates, uses, and can radiate radio frequency energy and, if not installed and used in accordance with the instructions, may cause harmful interference to radio communications. However, there is no guarantee that interference will not occur in a particular installation. If this equipment does cause harmful interference to radio or television reception, which can be determined by turning the equipment off and on, the user is encouraged to try to correct the interference by one or more of the following measures:

- Reorient or relocate the receiving antenna.
- Increase the separation between the equipment and receiver.
- Connect the equipment into an outlet on a circuit different from that to which the receiver is connected.
- Consult the dealer or an experienced radio/TV technician for help.

SAFETY PRECAUTIONS

	CAUTION RISK OF ELECTRIC SHOCK DO NOT OPEN	
<p>CAUTION: TO REDUCE THE RISK OF ELECTRIC SHOCK, DO NOT REMOVE COVER (OR BACK). NO USER-SERVICEABLE PARTS INSIDE. REFER SERVICING TO QUALIFIED SERVICE PERSONNEL.</p>		



The lightning flash with arrowhead symbol, within an equilateral triangle, is intended to alert the user to the presence of uninsulated "dangerous voltage" within the product's enclosure that may be of sufficient magnitude to constitute a risk of electric shock to persons.



The exclamation point within an equilateral triangle is intended to alert the user to the presence of important operating and maintenance (servicing) instructions in the literature accompanying the appliance.

The GV-PT2 Multimedia Printer should be used with: AC 120 V~, 60 Hz
To prevent electric shock and hazards, DO NOT use any other power source.

CAUTION

TO PREVENT ELECTRIC SHOCK MATCH WIDE BLADE OF PLUG TO WIDE SLOT, FULLY INSERT.

ATTENTION

POUR ÉVITER LES CHOCs ÉLECTRIQUES, INTRODUIRE LA LAME LA PLUS LARGE DE LA FICHE DANS LA BORNE CORRESPONDANTE DE LA PRISE ET POUSSER JUSQU'AU FOND.

WARNING:
TO PREVENT FIRE OR SHOCK HAZARD, DO NOT EXPOSE THIS UNIT TO RAIN OR MOISTURE.

NOTE:

The rating plate (serial number plate) and safety caution are on the bottom and/or the back of the main unit.

This Class B digital apparatus meets all requirements of the Canadian Interference – Causing Equipment Regulations.

"Cet appareil numérique de la classe B respecte toutes les exigences du Règlement sur le matériel brouilleur du Canada."

IMPORTANT PRODUCT SAFETY INSTRUCTIONS

Electrical energy can perform many useful functions. But improper use can result in potential electrical shock or fire hazards. This product has been engineered and manufactured to assure your personal safety. In order not to defeat the built-in safeguards, observe the following basic rules for its installation, use and servicing.

ATTENTION:

Follow and obey all warnings and instructions marked on your product and its operating instructions. For your safety, please read all the safety and operating instructions before you operate this product and keep this manual for future reference.

INSTALLATION

1. Grounding or Polarization

- (A) Your product may be equipped with a polarized alternating-current line plug (a plug having one blade wider than the other). This plug will fit into the power outlet only one way. This is a safety feature. If you are unable to insert the plug fully into the outlet, try reversing the plug. If the plug should still fail to fit, contact your electrician to replace your obsolete outlet. Do not defeat the safety purpose of the polarized plug.
- (B) Your product may be equipped with a 3-wire grounding-type plug, a plug having a third (grounding) pin. This plug will only fit into a grounding-type power outlet. This is a safety feature. If you are unable to insert the plug into the outlet, contact your electrician to replace your obsolete outlet. Do not defeat the safety purpose of the grounding-type plug.

2. Power Sources

Operate your product only from the type of power source indicated on the marking label. If you are not sure of the type of power supply to your home, consult your product dealer or local power company. If your product is intended to operate from battery power, or other sources, refer to the operating instructions.

3. Overloading

Do not overload wall outlets, extension cords, or integral convenience receptacles as this can result in a risk of fire or electric shock.

4. Power Cord Protection

Power supply cords should be routed so that they are not likely to be walked on or pinched by items placed upon or against them, paying particular attention to cords at plugs, convenience receptacles, and the point where they exit from the product.

5. Ventilation

Slots and openings in the cabinet are provided for ventilation. To ensure reliable operation of the product and to protect it from overheating, these openings must not be blocked or covered.

- Do not block the openings by placing the product on a bed, sofa, rug or other similar surface.
- Do not place the product in a built-in installation such as a bookcase or rack unless proper ventilation is provided or the manufacturer's instructions have been adhered to.

6. Wall or Ceiling Mounting

The product should be mounted to a wall or ceiling only as recommended by the manufacturer.

USE

1. Accessories

To avoid personal injury:

- Do not place this product on an unstable cart, stand, tripod, bracket or table. It may fall, causing serious injury to a child or adult, and serious damage to the product.
- Use only with a cart, stand, tripod, bracket, or table recommended by the manufacturer or sold with the product.
- Use a mounting accessory recommended by the manufacturer and follow the manufacturer's instructions for any mounting of the product.
- Do not try to roll a cart with small casters across thresholds or deep-pile carpets.

2. Product and Cart Combination

A product and cart combination should be moved with care. Quick stops, excessive force, and uneven surfaces may cause the product and cart combination to overturn.

3. Water and Moisture

Do not use this product near water—for example, near a bath tub, wash bowl, kitchen sink or laundry tub, in a wet basement, or near a swimming pool and the like.

PORTABLE CART WARNING
(Symbol provided by RETAC)



4. Object and Liquid Entry

Never push objects of any kind into this product through openings as they may touch dangerous voltage points or short-out parts that could result in a fire or electric shock. Never spill liquid of any kind on the product.

5. Attachments

Do not use attachments not recommended by the manufacturer of this product as they may cause hazards.

6. Cleaning

Unplug this product from the wall outlet before cleaning. Do not use liquid cleaners or aerosol cleaners. Use a damp cloth for cleaning.

7. Heat

The product should be situated away from heat sources such as radiators, heat registers, stoves, or other products (including amplifiers) that produce heat.

SERVICING

1. Servicing

If your product is not operating correctly or exhibits a marked change in performance and you are unable to restore normal operation by following the detailed procedure in its operating instructions, do not attempt to service it yourself as opening or removing covers may expose you to dangerous voltage or other hazards. Refer all servicing to qualified service personnel.

2. Damage Requiring Service

Unplug this product from the wall outlet and refer servicing to qualified service personnel under the following conditions:

- When the power supply cord or plug is damaged.
- If liquid has been spilled, or objects have fallen into the product.
- If the product has been exposed to rain or water.
- If the product does not operate normally by following the operating instructions. Adjust only those controls that are covered by the operating instructions as an improper adjustment of other controls may result in damage and will often require extensive work by a qualified technician to restore the product to its normal operation.
- If the product has been dropped or damaged in any way.
- When the product exhibits a distinct change in performance—this indicates a need for service.

3. Replacement Parts

When replacement parts are required, be sure the service technician has used replacement parts specified by the manufacturer or have the same characteristics as the original part. Unauthorized substitutions may result in fire, electric shock or other hazards.

4. Safety Check

Upon completion of any service or repairs to this product, ask the service technician to perform safety checks to determine that the product is in safe operating condition.

If you notice smoke or a peculiar smell coming from the printer, shut it down and unplug it IMMEDIATELY. Use of the printer under these conditions could lead to fire or electric shock. Contact your JVC dealer. DO NOT attempt to repair the malfunction yourself.

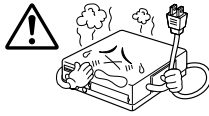

DO NOT attempt to insert foreign objects into the printer, as this can lead to electric shock or fire. If an object other than print paper is accidentally inserted, shut the printer down, unplug it and contact your JVC dealer.

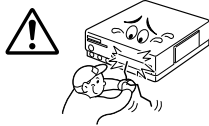

Exercise caution when moving the printer. If you drop the unit, do not attempt to use it. If during use you notice that the cabinet is damaged, shut the printer down, unplug it and contact your JVC dealer. Use of the printer under these conditions can lead to fire or electric shock.

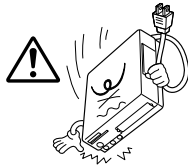

DO NOT place heavy objects on the printer's power cord, or leave the cord near any heat-generating appliance, as this can damage the cord. Avoid excessive pulling or twisting of the power cord. If the power cord becomes cut or otherwise damaged, contact your JVC dealer. When unplugging the printer, DO NOT pull on the cord. Hold the plug itself and remove it from the AC outlet. Use of the printer with a damaged power cord can lead to fire, electric shock and unit malfunctions.

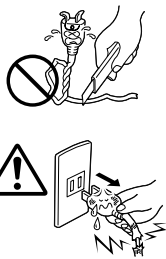

DO NOT remove the cover and attempt to repair or modify the printer. There are high-voltage components within the unit, and the risk of electric shock and unit malfunctions exists. If a problem occurs, contact your JVC dealer.



ABOUT THERMAL HEADS

- The thermal heads, necessary for printing, are located within the unit. The heads can become extremely warm. To prevent possible burns and injuries, do not touch the thermal heads.
- When the printer is used for extended periods, the thermal heads experience wear and tear just like VCR heads. As the thermal heads become worn, print quality will gradually decrease. When you notice a decline in quality, it is possible that the heads may need to be replaced. Consult your JVC dealer.

MOISTURE CONDENSATION

If condensation occurs inside the printer, it may adhere to print paper during printing, causing poor quality prints and paper jams. If you think condensation may exist within the unit, let the unit sit for at least 2 hours (with the power on) to dry sufficiently. If paper is stuck within the unit, remove it before turning the power on. Unused print paper subjected to moisture should not be used for printing.

- Condensation may occur in the following situations:
 - 1) In a room when the heater suddenly comes on;
 - 2) In the direct path of cool air from an air conditioner;
 - 3) When the unit is moved from a cool place to a warm place.

DUST

Due to dust or lint adhering to print paper, or to extreme variations in temperature, a small degree of color smearing or lines may be visible in prints.

Failure to heed the following precautions may result in damage to the printer.

1. **DO NOT** place the printer . . .
 - ... in an environment prone to extreme temperatures or humidity.
 - ... in direct sunlight.
 - ... in a dusty environment.
 - ... in an environment where strong magnetic fields are generated.
 - ... on a surface that is unstable or subject to vibration.
2. **DO NOT** block the printer's ventilation openings.
3. **DO NOT** place heavy objects on the printer.
4. **DO NOT** place anything which might spill on top of the printer.
5. **AVOID** violent shocks to the printer during transport.

CAUTION:

Changes or modifications not approved by JVC could void user's authority to operate the equipment.

This printer allows you to print text or images on standard or seal paper in any of one of several formats.

MULTI-PRINT

Print 4 or 16 images on one sheet.

The same image ... (page 24)



... or different images (page 26)



INSET PRINT (page 28)

Inset one image inside another

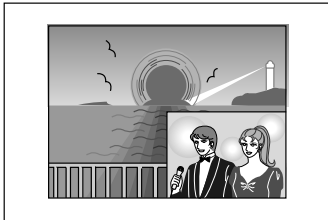

STROBE PRINT (page 30)

Print at set intervals, as when taking snapshots in rapid succession.

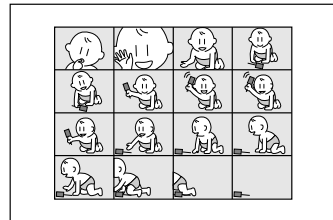

TITLE IMPOSE PRINT (page 42)

Impose hand-drawn titles or illustrations on an image.

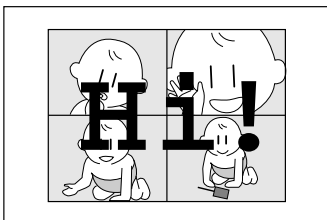

When using a JVC camcorder or VCR ...

SNAPSHOT PRINT (page 46)

If your JVC camcorder is equipped with Snapshot Search (such as the GR-SV7 or GR-DV1), you can automatically edit and print snapshots.

EDITING INDEX (page 48)

When used in conjunction with Random Assemble Editing, this feature allows you to create an index.

LAYOUT PRINT

Horizontal layout
(page 20)

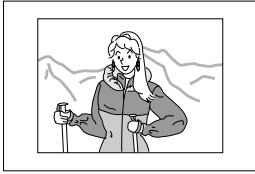

Video cassette label
(page 34)

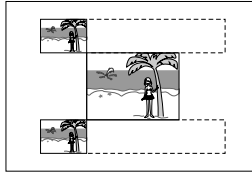

Name Sticker
(page 36)

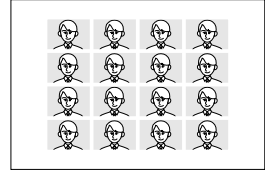

Vertical layout
(page 32)

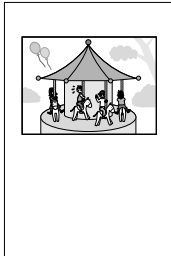

Calendar
(page 38)

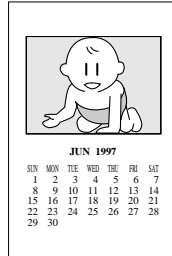

MASKING PRINT (page 44)

STAR



OVAL

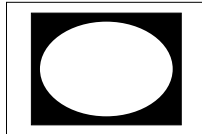

HEART

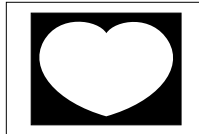

WAVE

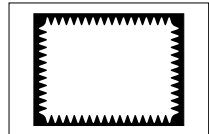

STORED TITLE IMPOSE (page 40)

- HAPPY BIRTHDAY
- HAPPY HOLIDAYS
- CONGRATULATIONS
- OUR VACATION
- WISH YOU WERE HERE

BUILT-IN CAPTURE FACILITY (page 63)

Images stored in the printer can be transferred to your computer. The transferred image can be processed or printed using commercially available software.

MAJOR FEATURES	6
CONTROLS, INDICATORS AND CONNECTORS	10
Front View	10
Rear View	11
Remote Control Unit	12
PREPARATION OF THE REMOTE CONTROL (RC) UNIT	13
CONNECTIONS	14
INSTALLATION OF INK CASSETTE	16
LOADING THE PAPER TRAY	18
PREPARATION	19
BASIC PRINTING	20
DIFFERENT TYPES OF PRINTING	22
Print Menu Display	22
Setting (with remote control unit)	22
Select Layout	23
Multi-Print (Same Scene)	24
Multi-Print (Different Scenes)	26
Inset Print	28
Strobe Print	30
Vertical Layout Print	32
Video Cassette Label Print	34
Name Sticker Print	36
Calendar Print	38
Stored Title Impose	40
Camera Title Impose	42
Masking Print	44
Snapshot Print	46
Editing Index	48
PERSONAL COMPUTER PRINTER SECTION	51
INTRODUCTION	52

PERIPHERAL UNIT CONNECTIONS	54
INSTALLING THE SOFTWARE	56
OPEN & CLOSE (Basic Operation Procedure)	58
CONTROLS AND OPERATIONS	60
PRINTING PROCEDURE	63
Video Printer Operation	63
PC Operation	64
Print Operation	64
How The Setup Dialog Works	66
How The Spooler Window Works	67
TROUBLESHOOTING	68
SPECIFICATIONS	74
INDEX	75

PROVIDED ACCESSORIES

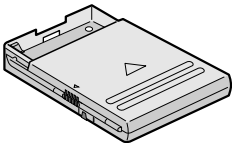

Paper Tray

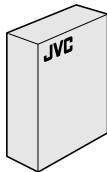

Color Print Paper Sheet Set
 • Standard Print Paper (10 sheets)
 • Ink Cassette (10 prints)



Remote Control Unit

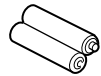

"AAA" Battery x 2



Floppy Disk

It should be noted that it may be unlawful to print from pre-recorded tapes or discs without the consent of the owner of copyright in the video recording, broadcast or cable programme and in any literary, dramatic, musical, or artistic work embodied therein.

Front View

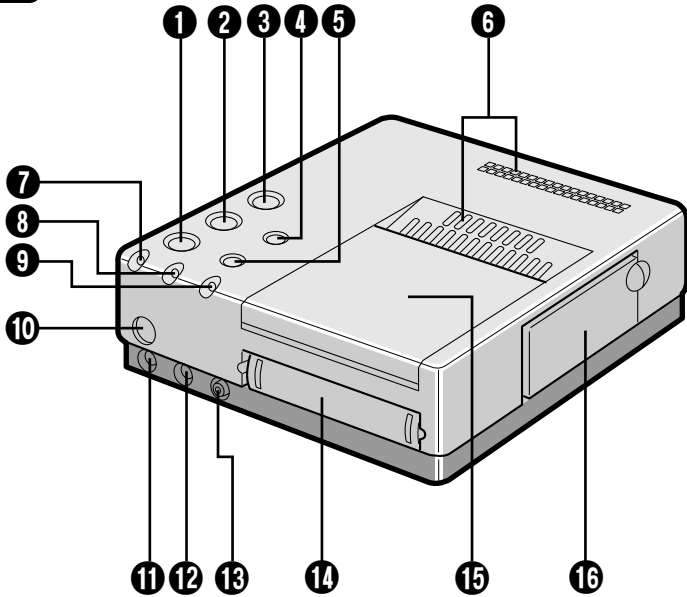
**1 PRINT button****2 MEMORY button**

- Press to store an input image for printing.

3 POWER button

- Turns the printer on and off.

4 SOURCE/ON LINE button**5 FRAME STABILIZER****6 Vent holes**

- Periodically clean these holes with a vacuum cleaner. Make sure the printer's power cord is unplugged.

7 ERROR lamp**8 INK lamp**

- Lights when the ink cassette is loaded.

9 ON LINE lamp

- Lights when the PC mode is on.

10 Remote Control Signal Receiver**11 REMOTE PAUSE connector**

- Used when printing snapshots or an editing index from a JVC camcorder or video cassette recorder. Connect a commercially available $\varnothing 3.5\text{mm}$ mini plug to either the camcorder's editing jack or the video cassette recorder's R.A.EDIT or SPECIAL FUNCTION jack.

12 S-Video Input Connector

- If the source unit has an S-Video output jack, connect it to the multimedia printer using a commercially available S-Video cable. S-VHS input has priority over normal inputs.

13 Video Input Connector

- If the source unit doesn't have an S-Video output jack, connect its normal video output to the printer using a commercially available video cable.

14 Paper Tray Insertion Slot

- Insert the paper tray into this slot.

15 Output Tray

- Printed sheets are stacked here.
- * Be sure to open the tray when using the printer.

16 Ink Cassette Insertion Slot

- Open this to load or unload the ink cassette.

Rear View

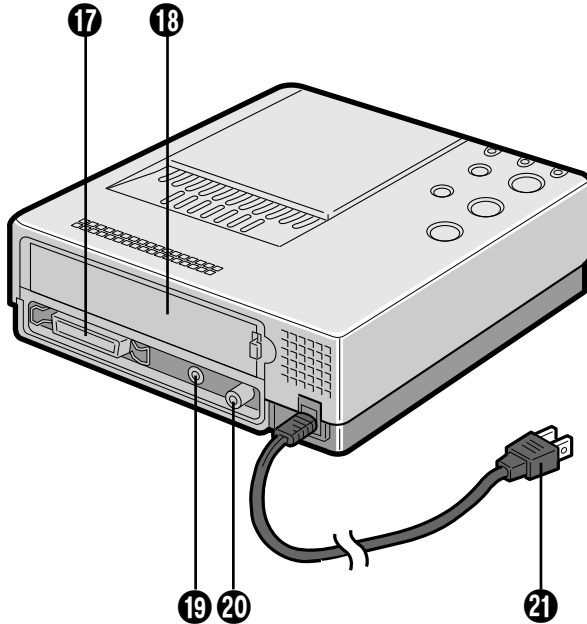
**17 PARALLEL Connector**

- Connect to the parallel (printer) terminal of a computer using a commercially available printer cable.

18 Service Door for Jammed Paper Removal

- Open this door when paper is jammed.
- * Do not open this door unless paper is jammed. Be sure to close this after clearing the paper jam.

19 JLIP (Joint Level Interface Protocol) Connector

- For connection to a computer for manipulation of printer images. Refer to the HELP or README files provided with the HS-V1U (Ver 1.10) software for details.

20 Video Output Connector

- Use this connector when you want to view the input image, or an image stored in memory, on a television. Using a commercially available video cable, connect the printer to a television.

21 Power Cord

- Plug into an AC outlet (AC 120 V).

Notice to JLIP PLAYER PACK HS-V1U (Ver. 1.08) users

HS-V1U (Ver. 1.08) is not compatible with the GV-PT2U. (If the version number is not printed on the HS-V1U's diskette, that means that the version is 1.08.) A version of HS-V1U compatible with the GV-PT2U will be made available from our home page (in English):

<www> <http://www.jvc-victor.co.jp/>

For further details, consult your nearest JVC dealer.

Remote Control Unit

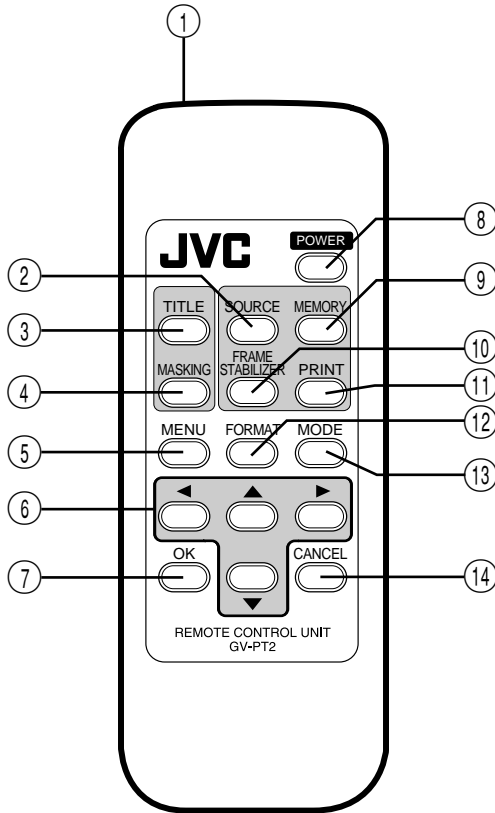

- | | |
|-------------------------|------------------------------|
| ① Transmitter | ⑧ POWER button |
| ② SOURCE select button | ⑨ MEMORY button |
| ③ TITLE button | ⑩ FRAME STABILIZER |
| ④ MASKING button | ⑪ PRINT button |
| ⑤ MENU control button | ⑫ FORMAT control button |
| ⑥ CURSOR control button | ⑬ MODE select control button |
| ⑦ OK button | ⑭ CANCEL button |

How to install the batteries

Place two R03/AAA batteries in the compartment. Align the batteries as shown.

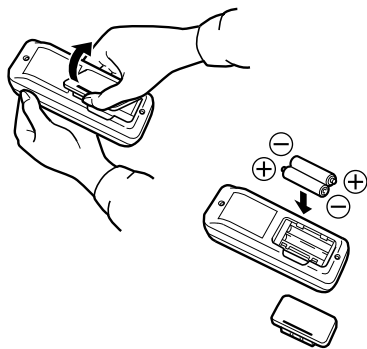

How to aim the remote control unit

Remote control signal receiver

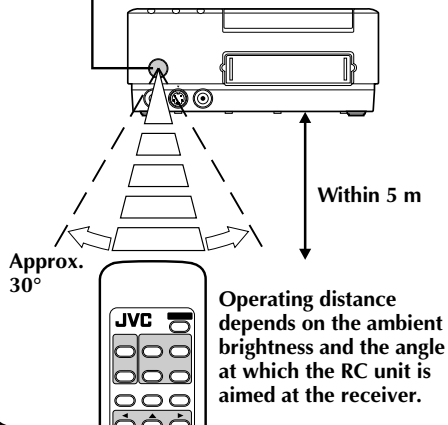

Notes on the batteries

- Remove the batteries from the RC unit when not using it for a long period.
- If the RC unit does not work properly, remove the batteries from the unit and let it stand for a while, then replace the batteries and try using it again.

When to replace the batteries:

- When the remote control's operating distance starts to decrease, it means that the battery level is dropping. In this case, replace the batteries with new ones.

When replacing the batteries

- Use two R03/AAA batteries.
- Replace both batteries at the same time. Do not mix new batteries with used batteries.
- Insert the batteries in accordance with the + and - indications.
- Be sure to read the precautions on the battery label.

Make sure that you have easy access to the AC outlet which the printer is plugged into so that it can be immediately unplugged in case of emergency. Connect the printer power plug to a different AC outlet from the TV and VCR.

TO CONNECT TO AN IMAGE SOURCE WITH S-VIDEO OUTPUT CONNECTORS

Connection using S-video cable is recommended to ensure a clearer print.

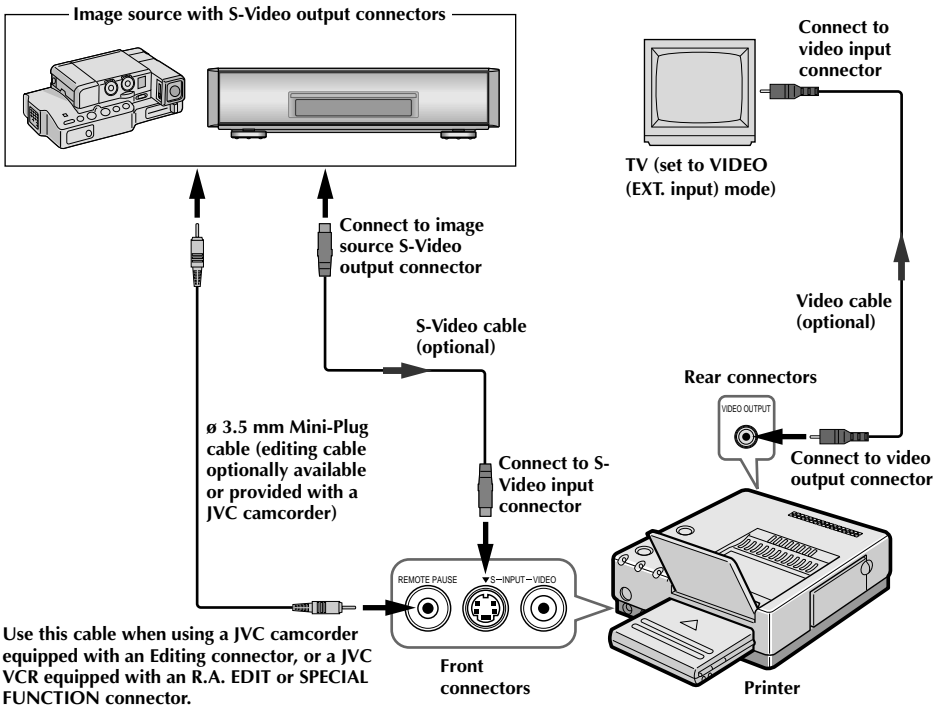

Be sure to carefully review the instruction manuals for all the units that you will be using in conjunction with this printer.

Some televisions and video cassette recorders require a specific type of output cable. Refer to their instruction manuals for details on television and VCR connections to the GV-PT2.

The printer assigns priority to input signals.

S-video signals take priority over regular video signals.

When you use an LCD video camera with a printer input connector:

When you connect the output of a camcorder equipped with an LCD monitor to the GV-PT2, you can view the printer's output image on the LCD monitor. Refer to the camcorder's instruction manual for connection details.

When SQUEEZE or CINEMA video is input into the S-Video input connector of the GV-PT2:

Print this input with a wide format (aspect ratio of 16 : 9)

TO CONNECT TO AN IMAGE SOURCE WITH REGULAR VIDEO OUTPUT CONNECTORS

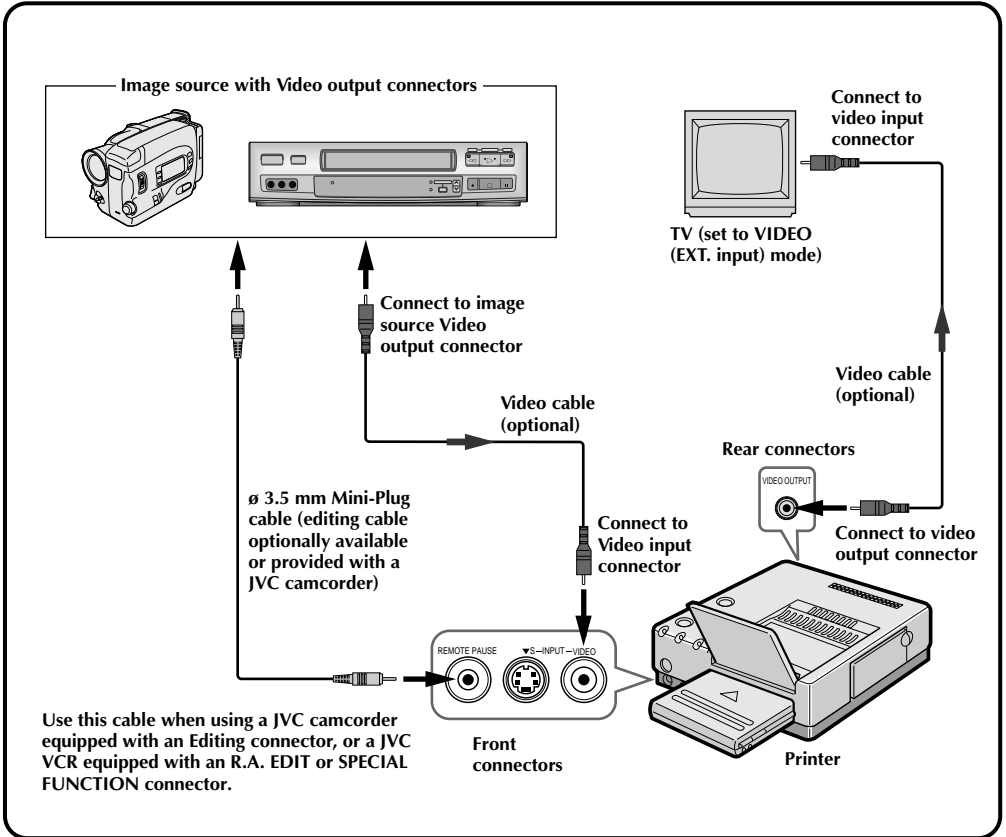

Install the ink cassette included with the optionally available color print paper sheet set.

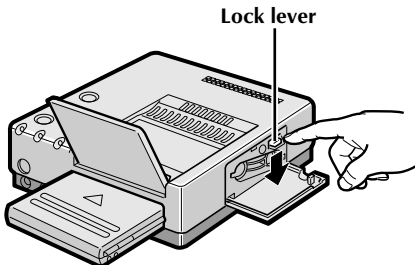
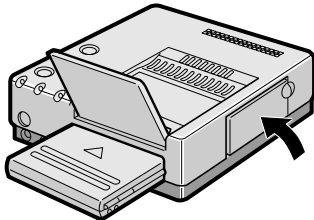
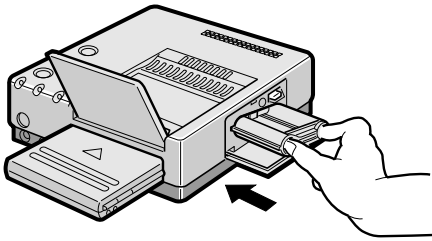
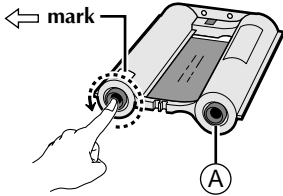
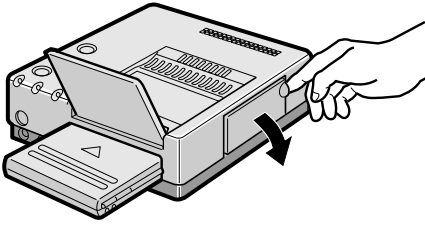

1 OPEN CASSETTE DOOR

Pull the right top of the door in the direction indicated by the arrow to open it.

2 TAKE UP SLACK

Turn the roller on the side with the "←" mark in the direction of the arrow. Do not turn the part marked with Ⓐ.

3 INSTALL INK CASSETTE

Insert the cassette label-side up from the end marked. Push it until you hear a click.

4 CLOSE CASSETTE DOOR

Push the right side of the door.
•The door clicks when it is fully closed.

When removing ink cassette

Push the lock lever in the direction of arrow. The ink cassette is unlocked and can be removed.

CAUTION

Do not stick your fingers into the ink cassette storage space. You may be burned or injured.

About Color Print Paper Sheet Sets (optional)

You must use one of the sets shown in the following chart:

SET	CONTENTS	USES
PV-50SFAU (Standard type)	<ul style="list-style-type: none"> • Standard Print Paper (50 Sheets) • Ink Cassette (50 Prints) 	Print your favorite images, just like snapshots.
PV-25SFAU (Sticker type)	<ul style="list-style-type: none"> • Sticker Print Paper (25 Sheets) • Ink Cassette (25 Prints) 	Make customized seals and stick them on greeting cards, envelopes, letters, etc.

Before Printing

- Do not touch printing side of the paper.
- Do not use paper that is torn or curled, as this can result in paper jamming.
- Do not use paper that is wet or damp. Printing may not be possible and paper jamming may occur.
- Do not touch or pull out the ink cassette's ink sheet.
- Keep young children away from the ink cassette's ink sheet.
- When the ink cassette is empty, replace it with a new one. An empty ink cassette cannot be used. Do not try to rewind and re-use cassette.
- Do not expose the paper to high temperatures, high humidity and/or direct sunlight.
- You can write on one side a PV-50SFAU print sheet.
- If you want to write something or stick a stamp on a PV-50SFAU sheet, wait until printing is finished. If you write something or stick something on before printing, the printer may not work properly.
- Carefully read the precautions in the color print paper sheet set box and on the back of the color print paper sheet set before using.

After Printing

- If you touch a fresh print with wet hands, the print image may be discolored.
- If a print absorbs organic cleaning solvents (alcohol, ester, keton, etc.), the colors will fade.
- If cellophane tape or soft PVC are affixed to a print, the chemical reaction will cause accelerated color fading.
- When writing on a PV-50SFAU print sheet, be sure to use a pencil or an oil-based writing utensil. If you apply too much pressure, you'll leave imprints on the print sheet.

Storage

- Avoid storing prints in areas subject to high temperatures or humidity, or near a heater or heat-generating device.
- Do not store prints in a soft plastic folder. Accelerated color fading may result due to the chemical reaction, or the print(s) may stick to the file.
- Do not store 2 prints with the printed sides touching, as the sheets may stick together.
- Store print paper in its box, on a level surface. Failure to do so may cause the print paper to curl or bend, which can result in a paper jam within the unit.

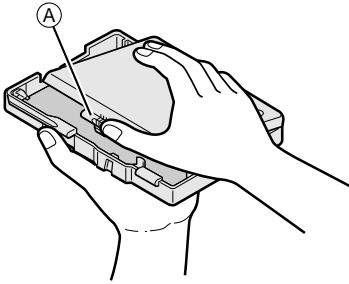

Opening the paper tray

- Open the lid while pushing ①.

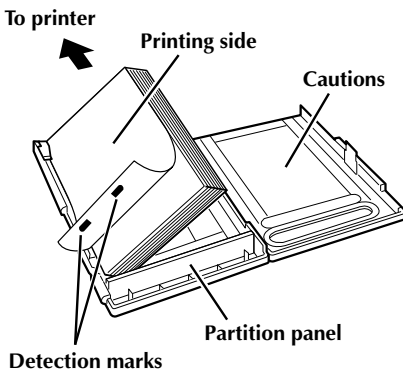

Inserting color print paper sheets in the paper tray

1. Keep the partition panel upright. If it is tilted, get it upright by pushing the back of the paper tray.
2. Load print sheets in the tray, placing the side with the detection marks toward you, face down.
 - The tray can hold up to 25 sheets at one time.

Be sure to read "Precautions when inserting printing paper" on the back of the paper tray lid.

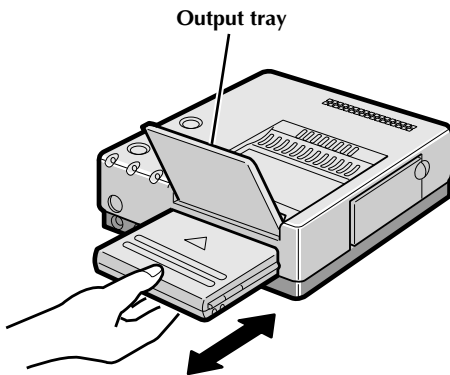

Loading/unloading the paper tray

- When loading, push the tray until it clicks.
- When unloading, push the tray slightly to unlock the latch, then pull it out.

- Before printing, make sure everything is set up and ready.

1 Have a Color Print Paper Sheet Set (option) ready. (page 17)



2 Install the ink cassette in the printer (page 16)



3 Place the color print paper sheets in the paper tray and load the tray (page 18).

- Use print sheets and ink cassette from the same kit.



4 Open the output tray.



5 Connect image source to the printer (page 14).



6 Plug the printer's power cable into an AC outlet and press the POWER button.

- Power comes on and the POWER indicator lights.



You are now ready to print. For specific printing instructions, read the page corresponding to the type of printing you want to do (pages 20 through 49).

This section explains how to print a single image — for example, if you want to print individual photographs to put in a photo album.

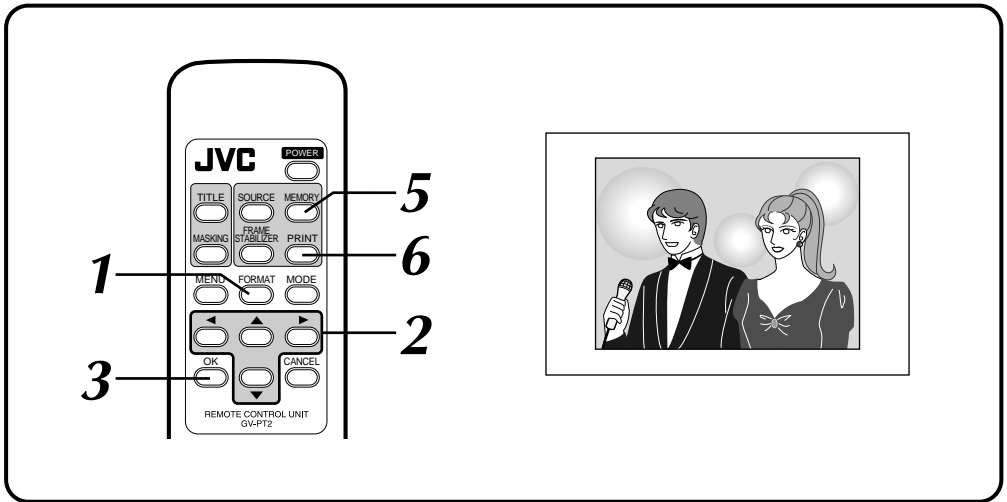

Preparation

See page 19.

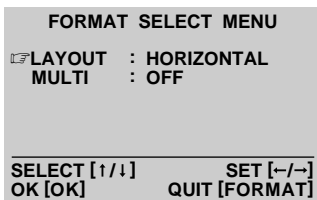

1 PRESS FORMAT

- FORMAT SELECT MENU appears on the connected monitor.

2 SELECT LAYOUT AND NO. OF SCENES

- ① Press cursor button ▲/▼ and place the pointer on LAYOUT.
- ② Press cursor button ◀/▶ and change the LAYOUT to HORIZONTAL.
- ③ Press cursor button ▲/▼ and place the pointer on MULTI.
- ④ Press cursor button ◀/▶ and change the number to OFF.

3 PRESS OK

- FORMAT SELECT MENU disappears, and setting is complete.

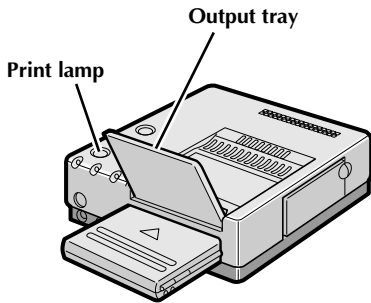

4 BEGIN SOURCE PLAYBACK

Fast-forward or rewind the source tape to find the desired scene, then start playback a little before the scene.

5 PRESS MEMORY WHEN THE DESIRED IMAGE APPEARS

- The image is stored in memory and appears on the screen.
- If MEMORY display is unstable, press F.STABILIZER button to call up "F.STABILIZER ON" on TV screen to stabilize the frame.

6 PRESS PRINT

- Print Lamp blinks, indicating that printing has started.
- "Now printing!!" appears on screen during printing.
- When the printed sheets are delivered to the output tray and "Now printing!!" disappears, printing is complete. Do not leave more than 25 printed sheets stacked on the tray.

ATTENTION

When using the Video Printer GV-PT2 in a location where static electricity is easily produced

When you are printing more than one sheet consecutively, the GV-PT2 may stop printing midway temporarily to avoid paper jam due to static electricity. When making more than one print, make sure that over 5 printed sheets do not accumulate in the output tray.

If you want to switch between the input image and the stored image ...

press SOURCE. Each time you press the button, the displayed image alternates between the input image and the stored image. This function is not available during printing.

If you store the wrong image or store an image incorrectly ...

press SOURCE to call up the INPUT display, then find the correct image and store it in memory. The incorrect image will be deleted and the new image be stored.

FRAME STABILIZER

With a "squeezed" video input signal, switching between ON/OFF of FRAME STABILIZER is not available. Enter the pause mode on the video unit, make sure that there is no noise or fluctuation on the frame and store the scene in memory.

If you want to print multiple copies of the same scene ...

select the number of print copies on the PRINTER MENU screen. You can select up to 25 copies (page 22). When printing two or more copies, you can press the CANCEL button on the remote control unit at any time to stop print operation after finishing the currently printing page. "Remaining sheets: 1" appears on the monitor screen.

To print a "live" image using a camcorder as the source ...

in step 4, instead of playing back the source tape, engage the camcorder's Record mode.

Print menu display

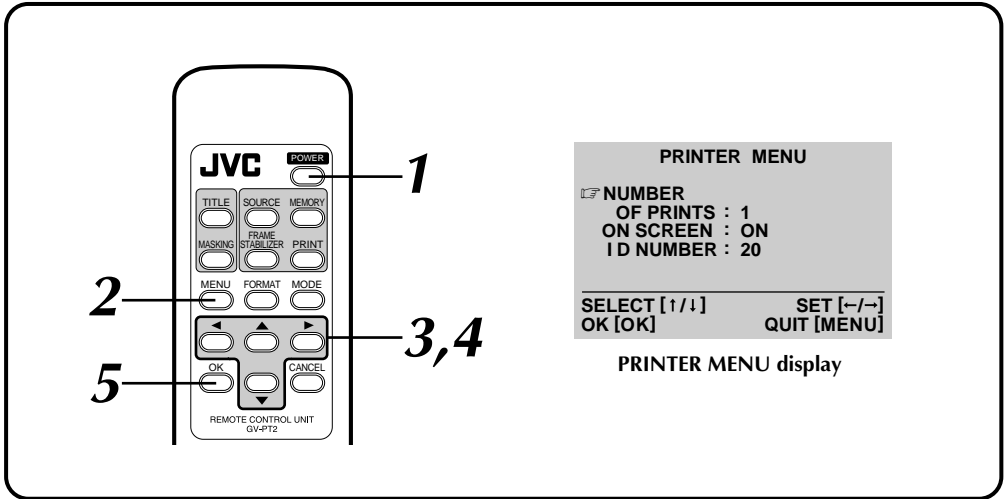

ITEM	OPTIONS	APPLICATION
No. of prints	1 – 25	Selectable up to 25. Factory set at 1.
ON SCREEN	ON	Usually set to ON.
	OFF	No display in the INPUT or MEMORY mode.
ID Number	1 – 99	Connection to and operation from a personal computer will be possible using the JLIP connector. Factory set at 20.

Setting (with remote control unit)

1 PRESS POWER

- Power comes on and POWER indicator lights.

2 PRESS MENU

- PRINTER MENU appears on the connected monitor.

3 PRESS CURSOR BUTTONS ▲/▼ TO PLACE THE POINTER ☛ ON THE DESIRED ITEM**4 PRESS CURSOR BUTTONS ◀/▶ TO SELECT THE DESIRED OPTION****5 REPEAT 3 AND 4 AND PRESS OK BUTTON WHEN SETTING IS COMPLETE**

- PRINTER MENU disappears and setting is finished.

Select Layout

FORMAT SELECT MENU

LAYOUT : HORIZONTAL
MULTI : 4
CONTENT : SAME PIX

SELECT [↑/↓] SET [←/→]
OK [OK] QUIT [FORMAT]

FORMAT SELECT MENU display

ITEM	OPTION	APPLICATION	Reference page
Layout	HORIZONTAL	Usually set to this option.	24 – 31
	VERTICAL	For vertical layout.	32
	VIDEO CASSETTE	To print video cassette labels.	34
	NAME STICKER	To print stickers for visiting cards.	36
	CALENDAR	To print calendar on lower half of vertical layout.	38
Number of images (displays only for horizontal layout)	OFF	To print 1 image.	24 – 31
	4	To print 4 images on one sheet.	
	16	To print 16 images on one sheet.	
Image content (displays only when number of scenes is set to 4 or 16 in horizontal layout)	SAME PIX	Print the same image in each of the sections (4/16) on one sheet.	24
	SELECTED PIX	Print selected images in each of the sections (4/16) on one sheet.	26
	STROBE <HIGH>	Stores images at approximately 1/15 sec. intervals when printing in Strobe Print format.	30
	STROBE <LOW>	Stores images at approximately 1/2 sec. intervals when printing in Strobe Print format.	

: Factory setting. When you unplug the printer and plug it again, the default factory settings are restored.

Multi-Print (Same Scene)

You can print the same image 4 or 16 times on one sheet.

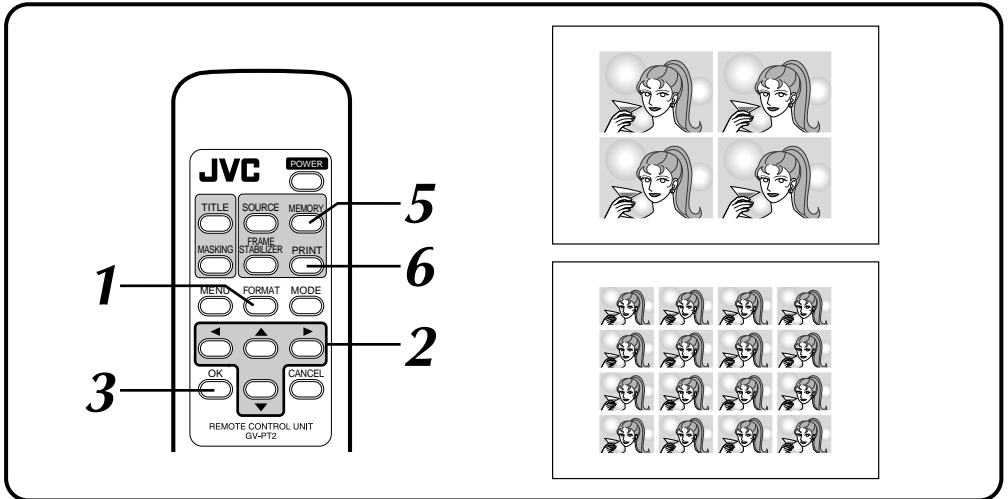

Preparation

See page 19.

FORMAT SELECT MENU	
LAYOUT	: HORIZONTAL
<input checked="" type="checkbox"/> MULTI	: 16
CONTENT	: SAME PIX
SELECT [↑/↓]	SET [←/→]
OK [OK]	QUIT [FORMAT]

1 PRESS FORMAT

- FORMAT SELECT MENU appears on the monitor.

2 SELECT HORIZONTAL ON LAYOUT, SELECT 4 OR 16 ON MULTI AND SELECT SAME PIX ON CONTENT

Press cursor buttons ▲/▼ to place the pointer  on items and press cursor buttons ◀/▶ to change the options.

3 PRESS OK

- FORMAT SELECT MENU disappears and selection is complete.

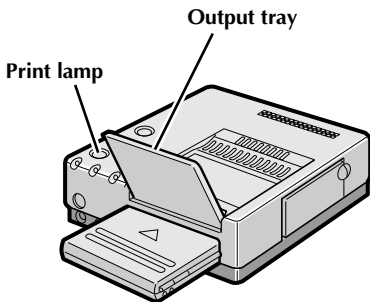

4 BEGIN SOURCE PLAYBACK

Fast-forward or rewind the source tape to find the desired scene, then start playback a little before the scene.

5 PRESS MEMORY WHEN THE DESIRED IMAGE APPEARS

- The image is stored in memory and appears on the screen.
- Only one image is stored in memory, regardless of the MULTI setting.
- In order to superimpose titles and masking, see pages 40 through 45. Title superimposing or masking is done on each image.

6 PRESS PRINT

- Print Lamp blinks, indicating that printing has started.
- "Now printing!!" appears on screen during printing.
- When the printed sheets are delivered to the output tray and "Now printing!!" disappears, printing is complete. Do not leave more than 25 printed sheets stacked on the tray.

FRAME STABILIZER

Switching between ON/OFF of FRAME STABILIZER is not available in Multi-Print (same scene) mode.

Multi-Print (Different Scenes)

You can print various images on the same print sheet.

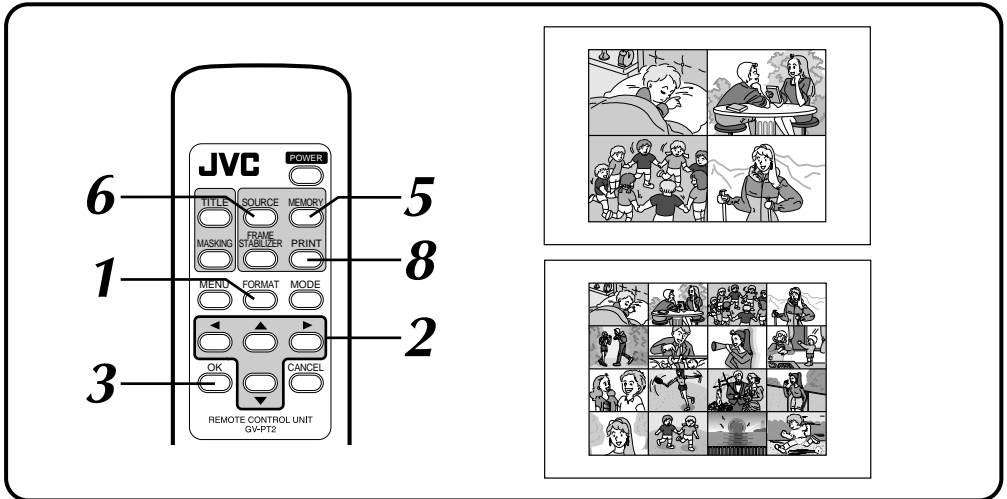

Preparation

See page 19.

FORMAT SELECT MENU	
LAYOUT	: HORIZONTAL
MULTI	: 16
CONTENT	: SELECTED PIX
<hr/>	
SELECT [↑/↓]	SET [←/→]
OK [OK]	QUIT [FORMAT]

1 PRESS FORMAT

- FORMAT SELECT MENU appears on the monitor.

2 SELECT HORIZONTAL ON LAYOUT, SELECT 4 OR 16 ON MULTI AND SELECT SELECTED PIX ON CONTENT

Press cursor buttons ▲/▼ to place the pointer  on items and press cursor buttons ◀/▶ to change the options.

3 PRESS OK

- FORMAT SELECT MENU disappears and selection is complete.

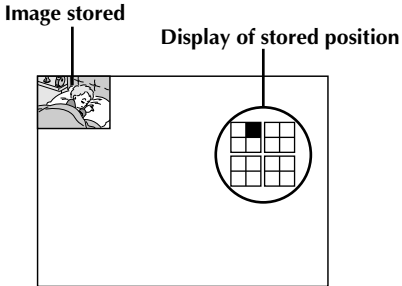

4 BEGIN SOURCE PLAYBACK

Fast-forward or rewind the source tape to find the desired scene, then start playback a little before the scene.

5 PRESS MEMORY WHEN THE DESIRED IMAGE APPEARS

- The image is stored in memory and appears in the upper lefthand corner of the screen.
- The next position to be stored in memory appears in all white in the upper righthand corner of the screen.
- You can select which position to store next by pressing the cursor buttons ▲/▼ and ◀/▶.
- With ON SCREEN set to OFF on the PRINTER MENU (Page 22), only the position stored in memory appears on the display.

6 PRESS SOURCE TO CALL UP THE INPUT DISPLAY

7 REPEAT STEPS 5 AND 6 FOR EACH IMAGE YOU ARE GOING TO PRINT (4 OR 16) AND STORE THEM

- In order to superimpose titles and masking, see pages 40 through 45. Title imposing or masking is done across the entire screen, not on each image separately.

8 PRESS PRINT

- Print Lamp blinks, indicating that printing has started.
- “Now printing!!” appears on screen during printing.
- When the printed sheets are delivered to the output tray and “Now printing!!” disappears, printing is complete. Do not leave more than 25 printed sheets stacked on the tray.

FRAME STABILIZER

If MEMORY display is not stable, press F.STABILIZER button to call up “F.STABILIZER ON” on TV screen.

If you store the wrong image or store an image incorrectly ...

- ① Press the cursor buttons ▲/▼ and ◀/▶, and select the image you want to change.
 - The position stored appears in white in the upper righthand corner of the screen.
- ② Press SOURCE to call up the INPUT display and store a new image.
 - The wrong image is deleted and the new image is stored in memory.

Inset Print

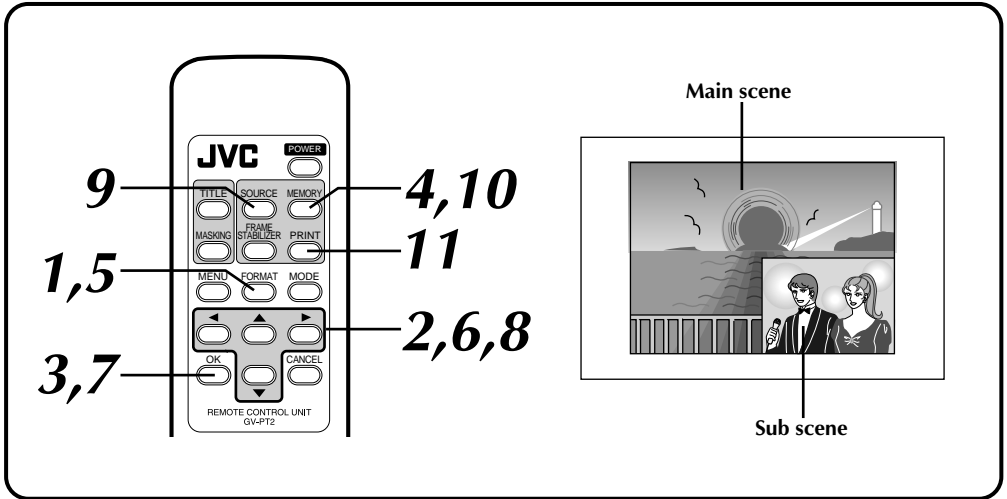

Preparation

See page 19.

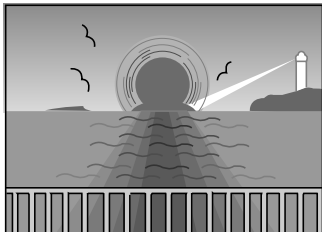
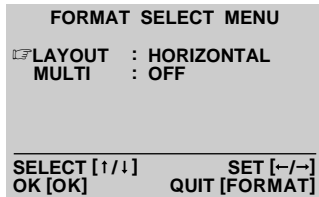

Store the main scene

- 1 PRESS FORMAT**
 - FORMAT SELECT MENU appears on the monitor.
- 2 SELECT HORIZONTAL ON LAYOUT AND SELECT OFF FOR MULTI**

Press cursor buttons ▲/▼ to place the pointer on items and press cursor buttons ◀/▶ to change the options.
- 3 PRESS OK**
 - FORMAT SELECT MENU disappears and selection is complete.
- 4 BEGIN SOURCE PLAYBACK. WHEN YOU REACH THE SCENE YOU WANT TO SELECT AS THE MAIN SCENE, PRESS MEMORY**
 - The main scene is stored and displayed on the monitor.

Strobe Print

The printer stores a selected number of images at short intervals, and print them on one sheet.

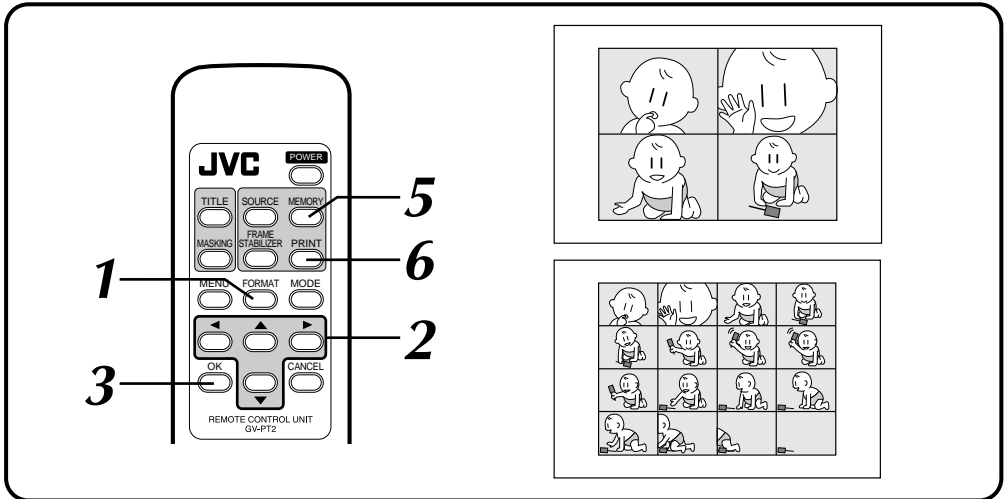

Preparation

See page 19.

FORMAT SELECT MENU	
LAYOUT	: HORIZONTAL
MULTI	: 16
CONTENT	: STROBE<HIGH>
SELECT [↑/↓]	SET [←/→]
OK [OK]	QUIT [FORMAT]

1 PRESS FORMAT

- FORMAT SELECT MENU appears on the monitor.

2 SELECT HORIZONTAL ON LAYOUT, SELECT 4 OR 16 ON MULTI AND SELECT STROBE<HIGH> OR STROBE<LOW> ON CONTENT

Press cursor buttons ▲/▼ to place the pointer  on items and press cursor buttons ◀/▶ to change the options.

- The images are automatically stored at intervals of approx. 1/15 sec. in STROBE<HIGH> and 1/2 sec. in STROBE<LOW>.

3 PRESS OK

- FORMAT SELECT MENU disappears and selection is complete.

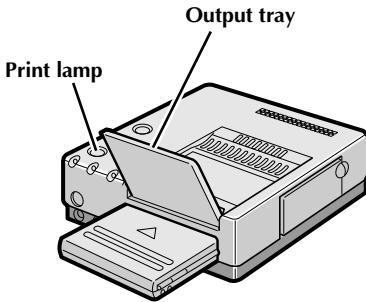
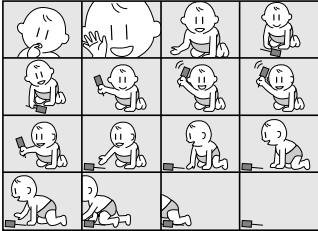
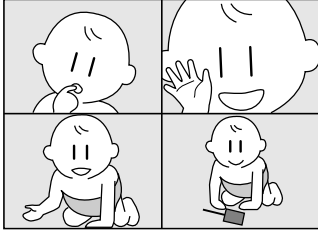

4 BEGIN SOURCE PLAYBACK

Fast-forward or rewind the source tape to find the desired scene, then start playback a little before the scene.

5 PRESS MEMORY WHEN THE DESIRED IMAGE APPEARS

- The images are automatically stored at intervals of approx. 1/15 sec. in STROBE<HIGH> and 1/2 sec. in STROBE<LOW>.
- When the maximum number of images is stored, the screen switches from INPUT to MEMORY display.
- In order to superimpose titles, see pages 40 through 43. Title imposing is done across the entire screen, not on each image separately.
- Masking facility is not available.

6 PRESS PRINT

- Print Lamp blinks, indicating that printing has started.
- “Now printing!!” appears on screen during printing.
- When the printed sheets are delivered to the output tray and “Now printing!!” disappears, printing is complete. Do not leave more than 25 printed sheets stacked on the tray.

FRAME STABILIZER

Switching between ON/OFF of FRAME STABILIZER is not available in the Strobe Print mode.

Vertical Layout Print

An image can be printed on the upper half of a print sheet.

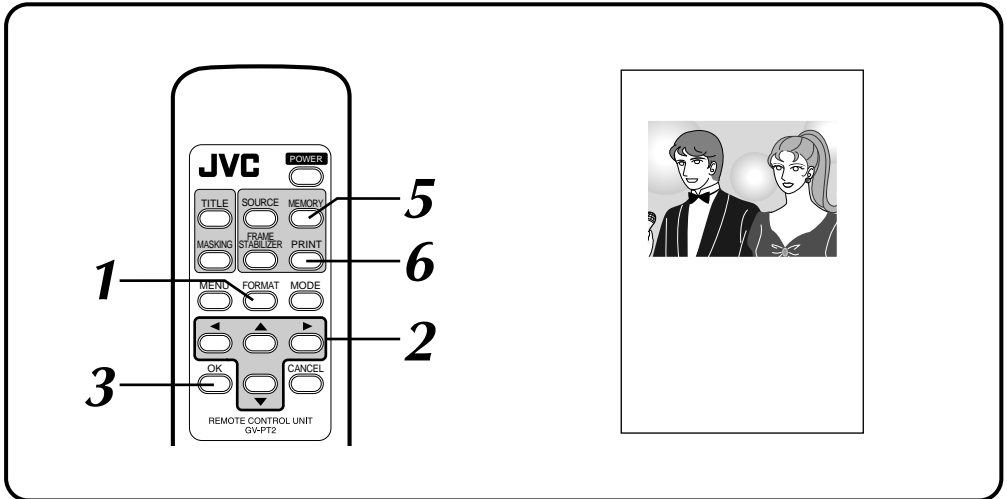

Preparation

See page 19.

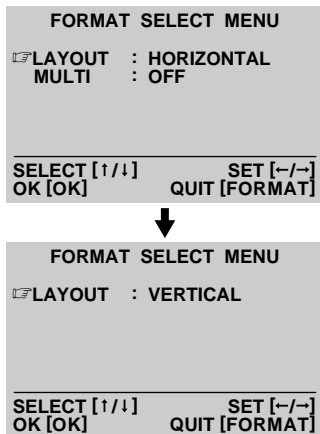

1 PRESS FORMAT

- FORMAT SELECT MENU appears on the monitor.

2 SELECT VERTICAL ON LAYOUT

Press cursor buttons ◀/▶ to choose the options.

3 PRESS OK

- FORMAT SELECT MENU disappears and selection is complete.

Image on the TV monitor

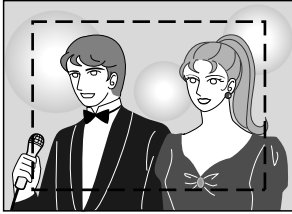

The area within
the broken line is
stored in memory.

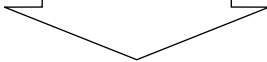
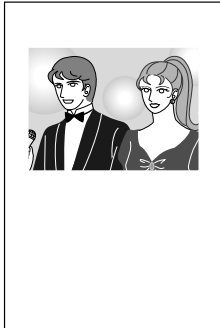

Image to be stored



4 BEGIN SOURCE PLAYBACK

Fast-forward or rewind the source tape to find the desired scene, then start playback a little before the scene.

5 PRESS MEMORY WHEN THE DESIRED IMAGE APPEARS

- The desired image is stored in memory and a vertical layout of the image appears on screen.
- The area to be stored is as shown to the left.
- If the image was recorded with a camcorder, the date display may be omitted from the image.
- In order to print characters on lower half of the layout, see the Camera Title Impose section on page 42.
- Stored Title Impose or Masking is not available in the Vertical Layout mode.

6 PRESS PRINT

- Print Lamp blinks, indicating that printing has started.
- "Now printing!!" appears on screen during printing.
- When the printed sheets are delivered to the output tray and "Now printing!!" disappears, printing is complete. Do not leave more than 25 printed sheets stacked on the tray.

FRAME STABILIZER

Switching between ON/OFF of FRAME STABILIZER is not available in the Vertical Layout mode.

Video Cassette Label Print

You can print video cassette labels that you can use to record the contents of your video cassettes. Use the optional Color Print Paper Sheet Set PV-25SFAU.

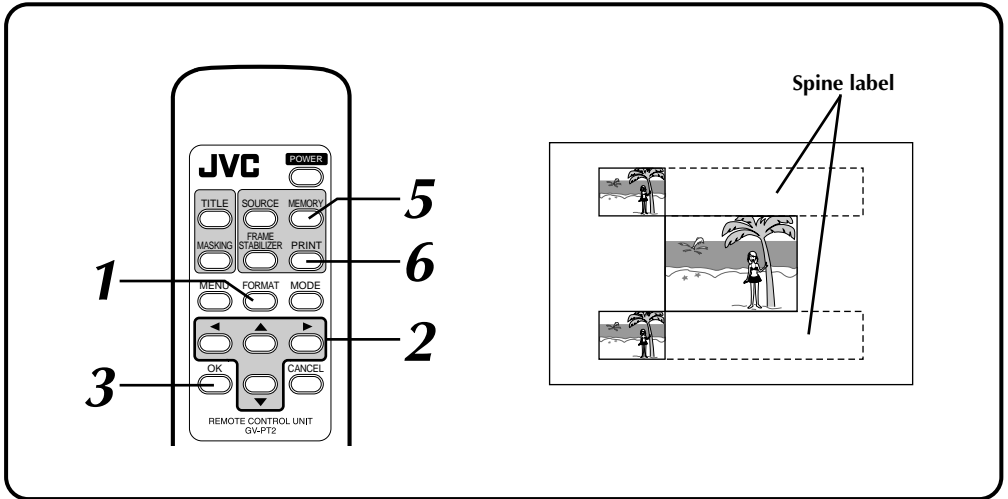

Preparation

See page 19.

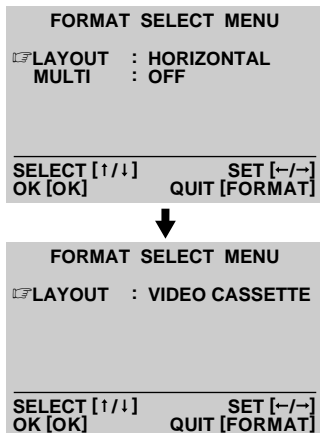

- 1 PRESS FORMAT**
FORMAT SELECT MENU appears on the monitor.
- 2 SELECT VIDEO CASSETTE ON LAYOUT**
Press cursor buttons ◀/▶ to choose the options.
- 3 PRESS OK**
 - FORMAT SELECT MENU disappears and selection is complete.

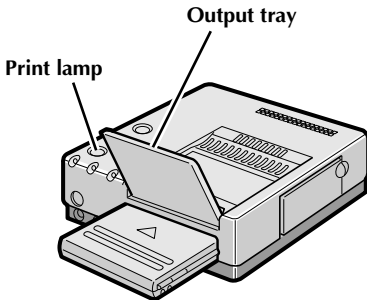
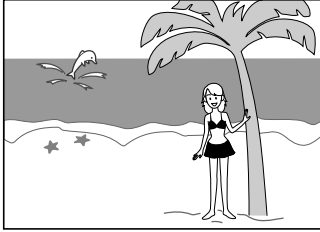

4 BEGIN SOURCE PLAYBACK

Fast-forward or rewind the source tape to find the desired scene, then start playback a little before the scene.

5 PRESS MEMORY WHEN THE DESIRED IMAGE APPEARS

- The desired scene is stored in memory and appears on screen.
- While the MEMORY screen shows one image, the actual print looks as illustrated on the opposite page.
- In order to print characters on the spine label of the cassette, see the Camera Title Impose section on page 42.
- Stored Title Impose or Masking is not available in this mode.

6 PRESS PRINT

- Print Lamp blinks, indicating that printing has started.
- "Now printing!!" appears on screen during printing.
- When the printed sheets are delivered to the output tray and "Now printing!!" disappears, printing is complete. Do not leave more than 25 printed sheets stacked on the tray.

FRAME STABILIZER

Switching between ON/OFF of FRAME STABILIZER is not available in the Video Cassette Label Print mode.

To affix labels on video cassettes ...

First cut out the labels and then stick onto video cassettes.

Name Sticker Print

You can print 16 separate copies of the same image. Use the optional Color Print Paper Sheet Set PV-25SFAU.

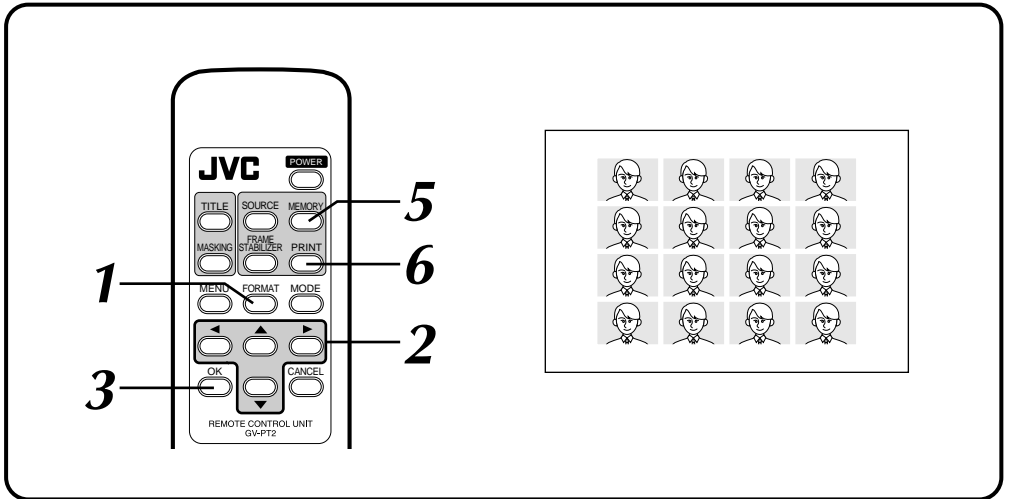

Preparation

See page 19.

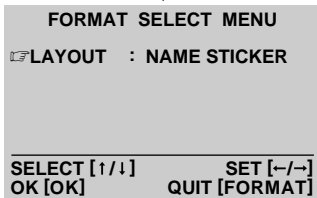
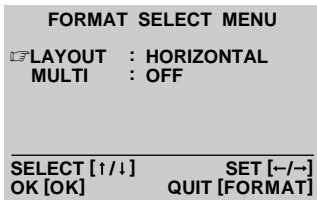

1 PRESS FORMAT

- FORMAT SELECT MENU appears on the monitor.

2 SELECT NAME STICKER ON LAYOUT

- Press cursor buttons ◀/▶ to choose the options.

3 PRESS OK

- FORMAT SELECT MENU disappears and selection is complete.

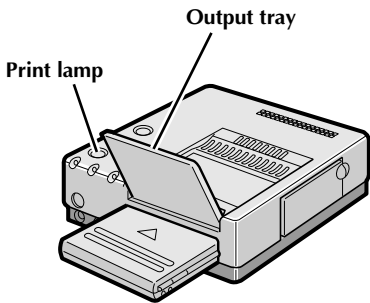
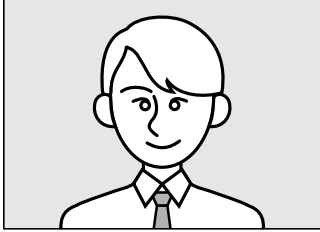

4 BEGIN SOURCE PLAYBACK

Fast-forward or rewind the source tape to find the desired scene, then start playback a little before the scene.

5 PRESS MEMORY WHEN THE DESIRED IMAGE APPEARS

- The desired image is stored in memory and appears on screen.
- While the MEMORY screen shows one image, the actual print looks as illustrated on the opposite page.
- In order to superimpose title characters or masking, see pages 40 through 45. Characters or masking are superimposed on each copy of print.

6 PRESS PRINT

- Print Lamp blinks, indicating that printing has started.
- "Now printing!!" appears on screen during printing.
- When the printed sheets are delivered to the output tray and "Now printing!!" disappears, printing is complete. Do not leave more than 25 printed sheets stacked on the tray.

FRAME STABILIZER

Switching between ON/OFF of FRAME STABILIZER is not available in the Name Sticker Print mode.

Calendar Print

You can print an image and calendar together. Available only with the vertical layout.

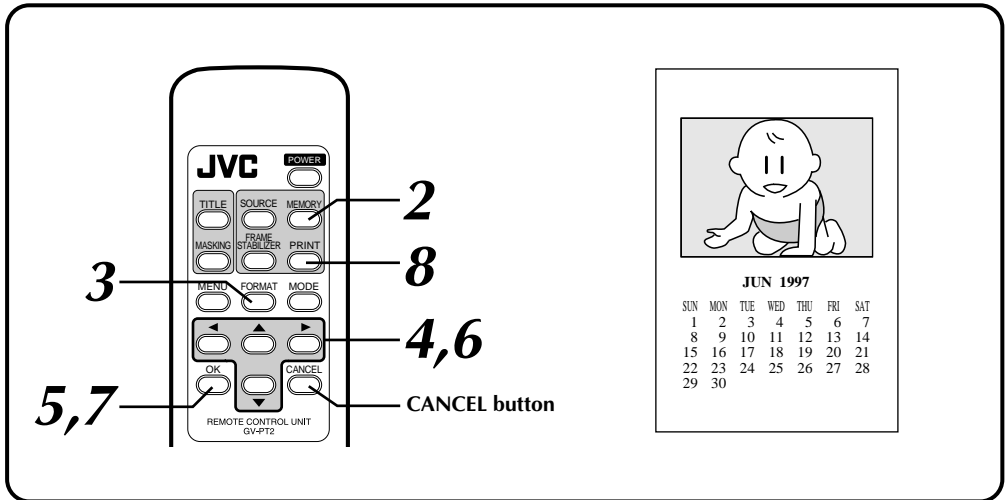

Preparation

See page 19.

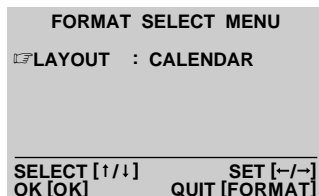
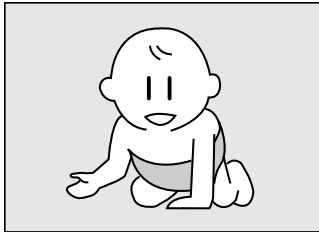

1 BEGIN SOURCE PLAYBACK

Fast-forward or rewind the source tape to find the desired scene, then start playback a little before the scene.

2 STORE THE DESIRED IMAGE IN MEMORY

- The desired scene is stored in memory and appears on screen.
- Select HORIZONTAL on LAYOUT and OFF on MULTI for the print format of the image you want to store. Other formats cannot be correctly stored.
- Title Impose or masking is not available.

3 PRESS FORMAT

- FORMAT SELECT MENU appears on screen.

4 SELECT CALENDAR ON LAYOUT

Press cursor buttons ◀/▶ to choose the options.

MAKE/ERASE CALENDAR☞ **YEAR** : 1997**MONTH** : JUN**ERASE CALENDAR**

SELECT [↑/↓]	SET [←/→]
OK [OK]	QUIT [FORMAT]

MEMORY display on vertical layout appears in the center of screen together with this MAKE/ERASE CALENDAR display

Image on the TV monitor

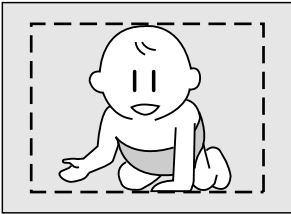

The area within the broken line is stored in memory.

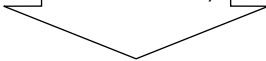
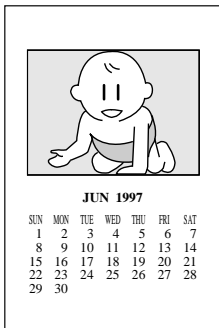

Image to be stored

**5 PRESS OK**

- MAKE/ERASE CALENDAR display appears with the image of vertical layout.

6 SET YEAR/MONTH OF CALENDAR

Press cursor buttons ▲/▼, place the pointer ☞ on year or month and change year or month with cursor buttons ◀/▶.

7 PRESS OK BUTTON

- Screen turns blue with "Please wait." displayed. After a while, the image combined with the calendar is displayed on screen.
- Holidays are not colored red.

8 PRESS PRINT

- Print Lamp blinks, indicating that printing has started.
- "Now printing!!" appears on screen during printing.
- When the printed sheets are delivered to the output tray and "Now printing!!" disappears, printing is complete. Do not leave more than 25 printed sheets stacked on the tray.

- When you want to erase the calendar before printing, press CANCEL. Pressing the OK button restores the calendar.

FRAME STABILIZER

Switching between ON/OFF of FRAME STABILIZER is not available in the Calendar Print mode.

If you store the wrong calendar ...
redo steps 3 through 7.

Stored Title Impose

Five different titles including "HAPPY BIRTHDAY" are stored in the printer and can be called up for superimposed printing. Colors and positions of the titles are set in advance.

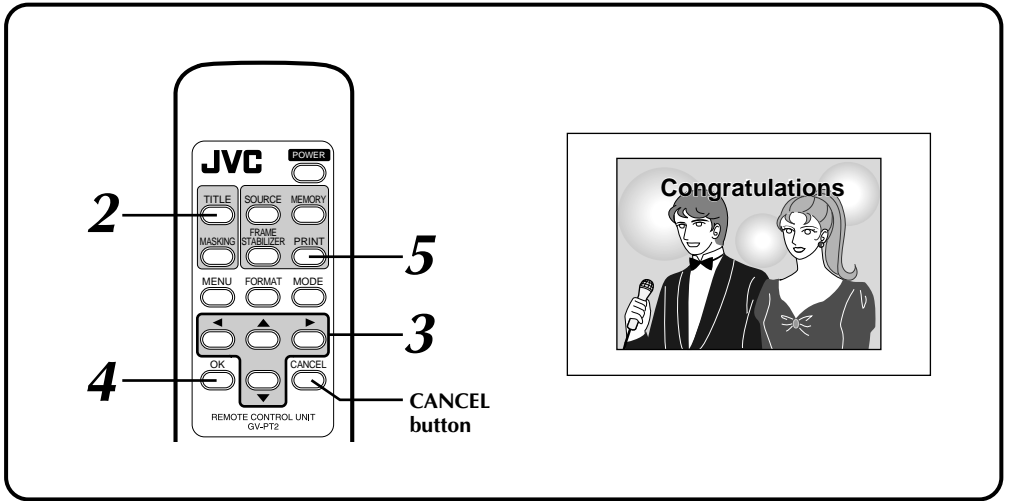

Preparation

See page 19.

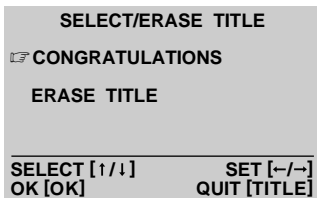

1 STORE THE DESIRED IMAGE IN MEMORY

See pages 20 through 31 for storing as desired.

2 PRESS TITLE

- SELECT/ERASE TITLE appears.

3 CHOOSE YOUR DESIRED TITLE

Press cursor buttons ◀/▶ to choose the title.



4 PRESS OK

- Screen turns blue with "Please wait." displayed. The title superimposed on the image then appears on MEMORY display.
- If masking is desired at the same time, follow the steps 2 through 4 on page 44.
- When both the masking and title are superimposed on the image, the title appears on the frame.

5 PRESS PRINT

- Print Lamp blinks, indicating that printing has started.
- "Now printing!!" appears on screen during printing.
- When the printed sheets are delivered to the output tray and "Now printing!!" disappears, printing is complete. Do not leave more than 25 printed sheets stacked on the tray.

■ **When you want to erase the title before printing, press CANCEL. Pressing the OK button restores the title.**

■ **If you want to erase title only when superimposing both title and masking ...**

1. Press TITLE.
 - SELECT/ERASE TITLE appears.
2. Press cursor buttons ▲/▼ and place the pointer  on ERASE TITLE.
3. Press OK.
 - The title and the SELECT TITLE/ERASE disappear.
 - See page 45 to erase masking only.

If the title characters and on-screen display are superimposed upon one another, making the MEMORY display difficult to view ...

1. Press MENU.
 - PRINTER MENU appears.
2. Press cursor buttons ▲/▼ and place the pointer  on ON SCREEN.
3. Press cursor buttons ◀/▶ and to choose OFF.
4. Press OK.
 - PRINTER MENU disappears with no message displayed on screen.

If you want to change the title ...
redo the steps 2 through 4.

Camera Title Impose

You can print a scene or image with your own handwritten characters or drawing imposed on it. The title or drawing will cover the entire image area of the color print paper sheet, regardless of the "MULTI" setting.

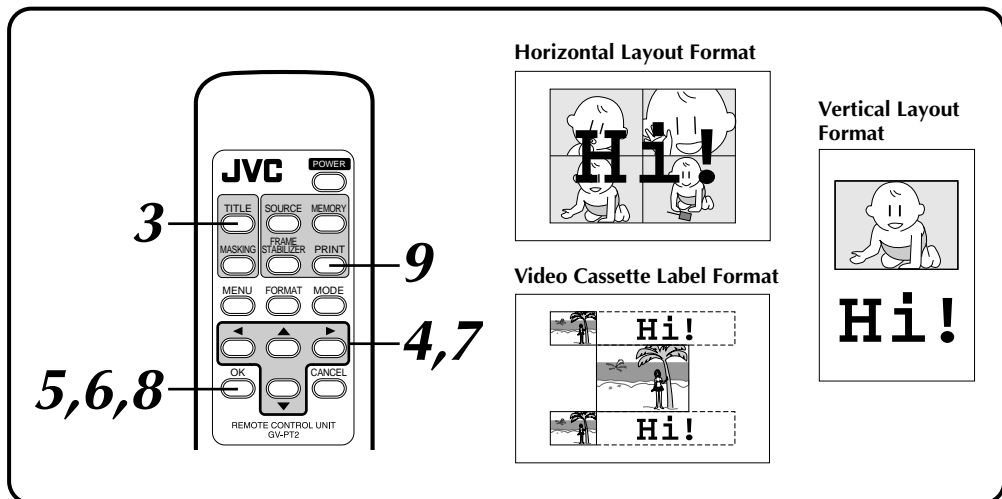

Preparation

See page 19.

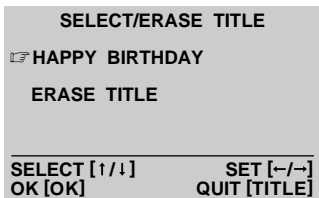
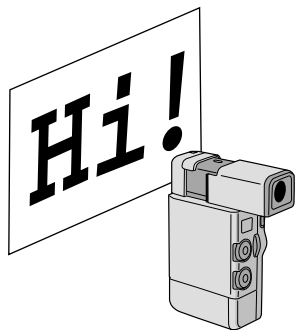

1 STORE THE DESIRED IMAGE IN MEMORY

See pages 20 through 35 for storing as desired.

2 RECORD TITLE OR DRAWING WITH YOUR CAMCORDER

Connect the S-Video (or Video) output connector of the camcorder to the S-Video (or Video) input connector and record your title or drawing using the camcorder.

- To ensure that your title or drawing is clearly visible and contrasts sufficiently with the image, use a dark-colored pen, pencil or marker on white or light-colored paper. Make sure the lines are wide and the figures large.

3 PRESS TITLE

- SELECT/ERASE TITLE appears.

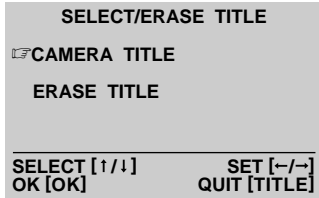

Erase title when printing is finished.

- 1 Press TITLE.
 - SELECT/ERASE TITLE appears.
- 2 Press cursor buttons ▲/▼ and place the pointer  on ERASE TITLE.
- 3 Press OK.
 - The title disappears.

If you want to change the title ... after performing steps 1 through 2, redo steps 2 through 8.

If you want to change COLOR or INVERSE ... redo steps 3, 4, 5, 7, 8.

4

SELECT CAMERA TITLE

Press cursor buttons ◀/▶ to place the pointer  on CAMERA TITLE.

5

PRESS OK

- SELECT/ERASE TITLE disappears with title entry display entered.
- Title automatically turns blue.
- If a vertical layout or video cassette label format is selected, ensure that the title is inside the image area.
- With vertical layout, the title will be set in the lower half of the image stored.
- With video cassette label, the same title is set on two spine labels.

6

WHEN THE TITLE OR DRAWING TO BE PRINTED HAS BEEN CHOSEN, PRESS OK

- SET CAMERA TITLE appears.
- Title automatically turns black.

7

CHOOSE NEGATIVE/POSITIVE OF THE TITLE

- 1 Press cursor buttons ◀/▶ and choose the color.

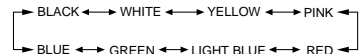

- 2 Press cursor buttons ▲/▼ and place the pointer  on INVERSE.
- 3 Press cursor buttons ◀/▶ and choose YES or NO.

8

PRESS OK

- Screen turns blue with "Please wait." displayed. The title superimposed on the image then appears and is stored in memory.
- With video cassette label, the title is superimposed on the image stored, though actual print looks like illustrated on page 42.

9

PRESS PRINT

- Print Lamp blinks, indicating that printing has started.
- "Now printing!!" appears on screen during printing.
- When the printed sheets are delivered to the output tray and "Now printing!!" disappears, printing is complete. Do not leave more than 25 printed sheets stacked on the tray.

Masking Print

You can print an image inside a frame by masking part of the image. Four different frame shapes are available.



Star

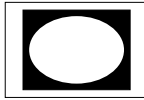

Oval

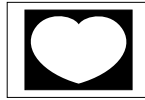

Heart

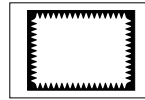

Wave

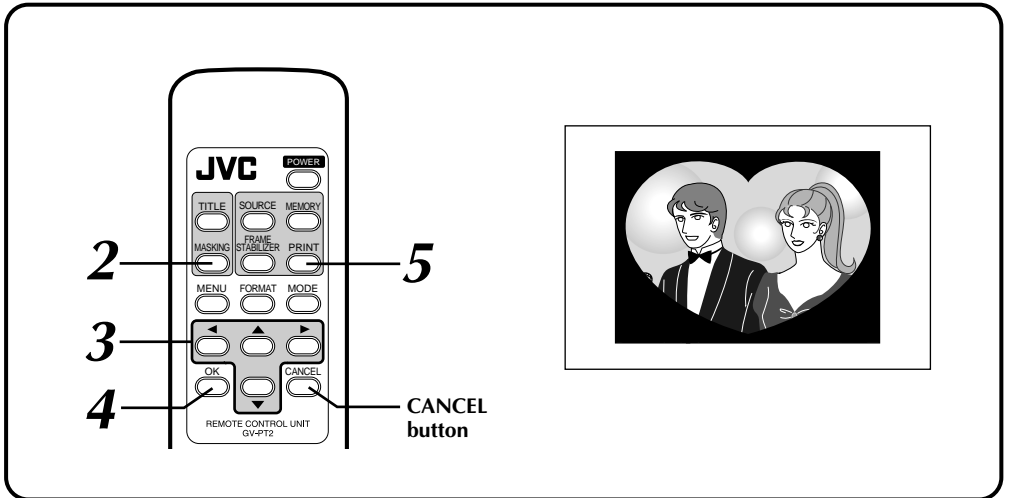

Preparation

See page 19.

SELECT/ERASE MASKING

☞ SHAPE : STAR
COLOR : BLACK

ERASE MASKING

SELECT [1/1] SET [-/→]
OK [OK] QUIT [MASKING]

1 STORE THE DESIRED IMAGE IN MEMORY

See pages 20 through 29.

2 PRESS MASKING

•SELECT/ERASE MASKING appears.

3 CHOOSE COLOR AND SHAPE OF MASK

- ① Press cursor buttons ▲/▼ and place the pointer ☞ on SHAPE.
- ② Press cursor buttons ◀/▶ and choose shape.
- ③ Press cursor buttons ▲/▼ and place the pointer ☞ on COLOR.
- ④ Press cursor buttons ◀/▶ and choose color.

→ STAR ← OVAL ← HEART ← WAVE ←

→ BLACK ← WHITE ← YELLOW ← PINK ←
→ BLUE ← GREEN ← LIGHT BLUE ← RED ←

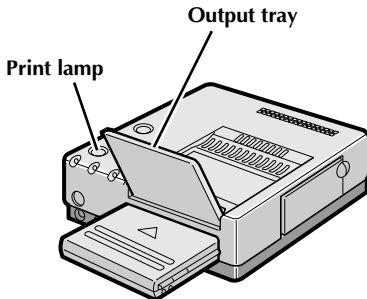

4 PRESS OK

- Screen turns blue with "Please wait." displayed. The masking superimposed on the image then appears on MEMORY display.
- If you want to title-superimpose at the same time, follow the steps **2** through **4** on page 40.
- When both the masking and title are superimposed on the image, the title appears on the frame.

5 PRESS PRINT

- Print Lamp blinks, indicating that printing has started.
- "Now printing!!" appears on screen during printing.
- When the printed sheets are delivered to the output tray and "Now printing!!" disappears, printing is complete. Do not leave more than 25 printed sheets stacked on the tray.

■ **If you want to remove the masking before printing, press CANCEL. Pressing the OK button restores the masking.**

■ **If you want to remove the masking when superimposing both title and masking ...**

1. Press MASKING.
 - SELECT/ERASE MASKING appears.
2. Press cursor buttons ▲/▼ and place the pointer  on ERASE MASKING.
3. Press OK.
 - The masking and the SELECT/ERASE MASKING disappear.
 - See page 41 to erase title only.

If you want to change the masking ...
redo steps **2** through **4**.

Snapshot Print

If you have a JVC camcorder with a Snapshot Search function (such as the GR-SV7 and GR-DV1), you can easily locate and print snapshots.

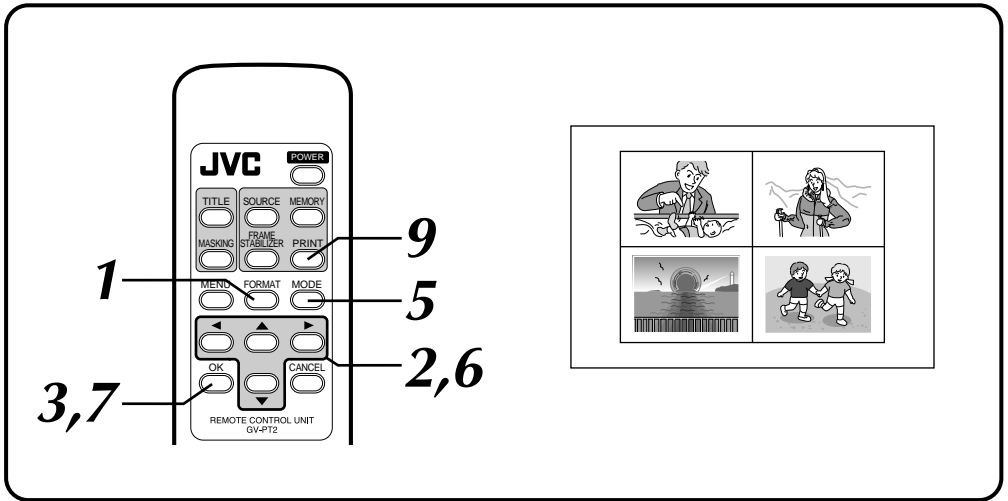

Preparation

- Connect the camcorder's editing connector to the PAUSE connector on the printer using the editing cable supplied with the camcorder, or a commercially available ø3.5 mini plug. (See pages 14 & 15).
- Perform preparation referring to page 19.

FORMAT SELECT MENU	
LAYOUT	: HORIZONTAL
MULTI	: 4
☒ CONTENT	: SELECTED PIX
SELECT [↑/↓]	SET [←/→]
OK [OK]	QUIT [FORMAT]

1 PRESS FORMAT

- FORMAT SELECT MENU appears on the monitor.

2 SELECT HORIZONTAL ON LAYOUT, SELECT 1, 4 OR 16 ON MULTI AND SELECT SAME PIX OR SELECTED PIX ON CONTENT

Press cursor buttons ▲/▼ to place the pointer ☒ on items and press cursor buttons ◀/▶ to change the options.

3 PRESS OK

- FORMAT SELECT MENU disappears and selection is complete.

MODE SELECT MENU

☞ SNAP SHOT PRINTING
EDITING INDEX

ENTER THE MODE [OK]
SELECT [↑/↓] QUIT [MODE]

To exit Snapshot Print mode ..., press MODE after printing. The SNAP SHOT PRINTING disappears.

If you do not want to store the preset number of scenes ..., press OK during storing. The MEMORY display appears and the rest of the scenes turn white.

FRAME STABILIZER

ON/OFF switching of the frame stabilizer is available only for one-scene snapshot printing.

If the contour line is indented, press F.STABILIZER button to call up "F.STABILIZER ON" on TV screen.

If Snap Shot Print does not work ..., see page 14 or 15 and make sure that the mini plug cord is correctly connected.

If the source tape contains snapshots taken in Motor Drive mode ..., you cannot print these snapshots using Snapshot Print. Exit Snap Shot Print mode and store the image with MULTI set to 4 or 16 and CONTENT set to SELECTED PIX (on page 26).

4 REWIND THE TAPE IN THE CAMCORDER TO THE SCENE YOU WANT TO PRINT, THEN PAUSE THE TAPE

5 PRESS MODE

- MODE SELECT MENU appears.
- If the image to be printed is not stored in memory, "CAPTURE" is not displayed on the MODE SELECT MENU.

6 SELECT SNAP SHOT PRINTING

Press cursor buttons ▲/▼ and place the pointer ☞ on SNAP SHOT PRINTING.

7 PRESS OK

- MODE SELECT MENU disappears and SNAP SHOT PRINTING appears.

8 PRESS THE CAMCORDER'S SNAP SHOT BUTTON

- Refer to the camcorder's instruction manual for details.
- The camcorder automatically locates the beginning of the snapshot, and the printer stores the scene.
- When the number of scenes set in 2 is stored, the MEMORY display is entered.
- If you do not want to store all the 16 scenes, press OK. The MEMORY display is entered with the rest of the scenes turning white.
- When the MEMORY display appears, stop the snapshot search on the camcorder.
- If you have chosen 4 or 16 of the same scene, the MEMORY displays only one scene.
- Title Impose or masking is not available.

9 PRESS PRINT

- Print Lamp blinks, indicating that printing has started.
- "Now printing!!" appears on screen during printing.
- When the printed sheets are delivered to the output tray and "Now printing!!" disappears, printing is complete. Do not leave more than 25 printed sheets stacked on the tray.

Editing Index

When you edit a source tape using Random Assemble Editing (available on selected JVC camcorders and VCRs), you can print out the scenes at the Edit-In and Edit-Out points you've registered. This allows you to make an editing index.

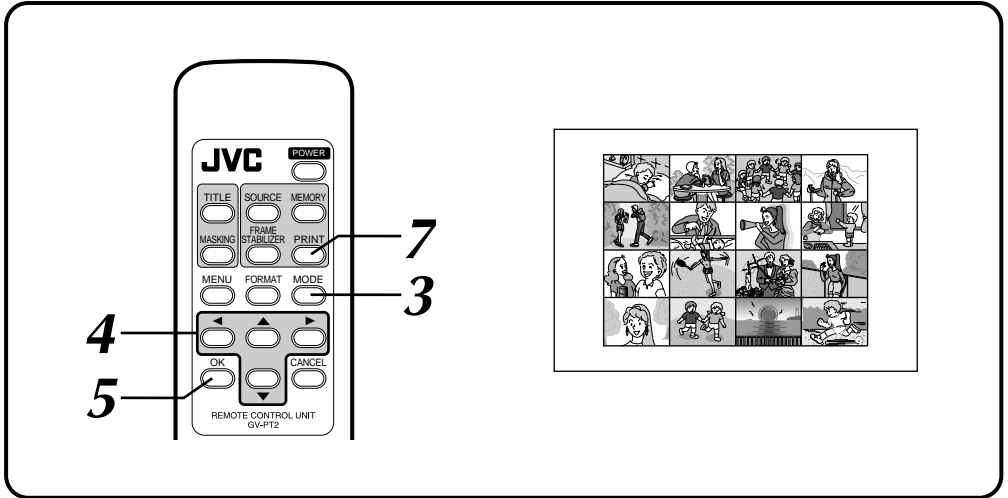

Preparation

Perform preparation referring to page 19.

	IN	OUT
1	0:00:25	0:01:05
2	0:03:18	0:03:31
3	0:02:33	0:02:53
▶ 4	0:04:11	
5		
6		
7		
8		
COUNTER	0:04:11	
TOTAL	0:01:13	

Random Assemble Editing selection screen

If the camcorder's power goes off before you press the Edit Start button ...

turn the camcorder's power off and then on. The Random Assemble Editing selection screen appears in the camcorder's viewfinder display.

1 CONNECT IMAGE SOURCE (CAMCORDER OR VCR) TO PRINTER (PAGE 14, 15)

Connect either the camcorder or the video cassette recorder to the printer's REMOTE PAUSE connector using the mini plug cord (or a editing cable supplied with the camcorder).

2 SET EDIT-IN OR EDIT-OUT POINT OF THE SCENE TO BE STORED

- When the scene to be printed is reached, set Edit-in and Edit-out points with the camcorder or VCR. Up to 16 scenes can be set.
- For details, refer to the camcorder and VCR operation manuals.

3 PRESS MODE SELECT BUTTON

- MODE SELECT MENU appears.

MODE SELECT MENU

CAPTURE
SNAP SHOT PRINTING
EDITING INDEX

ENTER THE MODE [OK]
SELECT [↑/↓] QUIT [MODE]

Sequence for memory

A: 1st Edit-in of the Editing program,
B: 1st Edit-out of the program, C: 2nd
Edit-in P: 8th Edit-out to be stored
in this sequence

A →	B →	C →	D
E	F	G	H
I	J	K	L
M	N	O	P

4 CHOOSE EDITING INDEX

Press cursor buttons ▲/▼ and place the pointer  on EDITING INDEX.

5 PRESS OK

- MODE SELECT MENU disappears and EDITING INDEX appears.
- 16 image sections are displayed regardless of the number of scenes set on the PRINTER MENU.

6 PRESS THE CAMCORDER'S EDIT START BUTTON OR THE VCR'S START BUTTON

- Edit indexing begins and the Edit-In and Edit-Out points are automatically stored in the printer's memory.
- Once all 16 scenes are stored, they appear on display.
- If you do not want to store all the 16 scenes, press OK. The MEMORY display is appears and the rest of the scenes turn white.
- Title Impose or masking is not available.

7 PRESS PRINT

- Print Lamp blinks, indicating that printing has started.
- "Now printing!!" appears on screen during printing.
- When the printed sheets are delivered to the output tray and "Now printing!!" disappears, printing is complete. Do not leave more than 25 printed sheets stacked on the tray.

To exit Editing Index mode...

press MODE after printing, and the EDITING INDEX disappears.

If you use a camcorder (such as GR-DV1) with FADE or WIPE function available at the edit-in and edit-out points of assemble editing...

you can store the faded or wiped image by engaging the FADE or WIPE mode at the edit-in or edit-out points. (eg. a black image is stored using the fader.) In this case, store the edit-in and edit-out points in sequence with MULTI set to 4 or 16 and CONTENT set to SELECTED PIX (page 26).

FRAME STABILIZER

Switching between ON/OFF of FRAME STABILIZER is not available in the Editing Index mode.

PERSONAL COMPUTER PRINTER SECTION

- The Readme.TXT file provides additional information for setup and information that is not included in the instruction manual. Please read the file before installing the provided software program.
- You can find the latest information (in English) on the provided software program at our www server:
<www><http://www.jvc-victor.co.jp/>

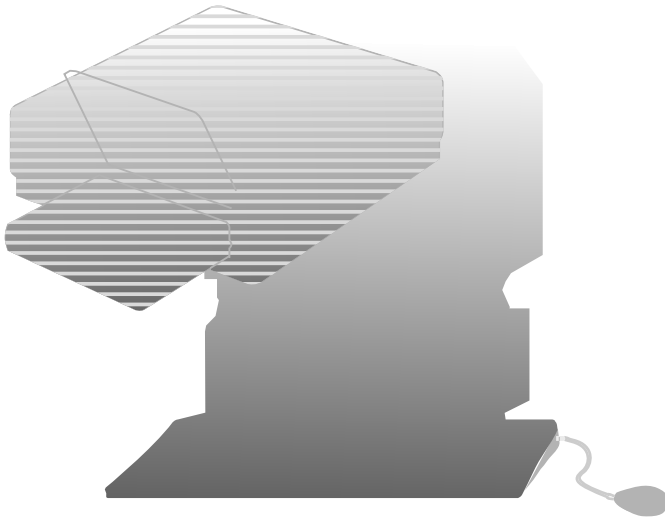

REQUIRED HARDWARE

- Bi-Directional 25-pin printer interface
- 486DX2 or higher CPU

OPERATING ENVIRONMENT

- Personal computer with Microsoft®* Windows®* Operating System Version 3.1 (also verified to run with Microsoft® Windows® 95)
 - * Microsoft® and Windows® are trademarks of the Microsoft Corporation registered in the United States and other countries.
- 16 MB RAM or more
- At least 8 MB available hard disk space
- Color display capable of handling at least 640 x 480 dots and 256 colors (Recommended: true color 24-bit)
- Windows®-compatible mouse connected to PC
- 3.5" 1.44MB floppy disk drive
- PC which allows setting of Parallel Port to "Bi-Directional" or "Enhanced Parallel Port" mode.
- BIOS setting (with EPP or Bi-Directional setting) (see below)

BIOS SETTING

The GV-PT2 Driver & Capture Utility Software is designed to use a two-way communications interface as a prerequisite in the environment of Windows®. It runs when the parallel-port mode is set to EPP or Bi-Directional (represented as PS/2 Exchange mode or Extension mode in some PCs).

The initial setting of some PCs may not be EPP or Bi-Directional. In this case, set the mode to EPP or Bi-Directional using the PC's set-up utility. Refer to your computer's user manual for details.

Some PCs capable of two-way communications may not provide any setup indication for EPP or Bi-Directional. In this case, consult the manufacturer of your computer.

SOFTWARE FEATURES

DRIVER WINDOW

Print orientation, number of prints and image adjustment can be selected in this window.

- Print orientation : Portrait/Landscape
- No. of prints : 1 to 25
- Image adjustment
 - Contrast : Low — High (11 grades from -5 — +5)
 - Brightness : Dark — Bright (11 grades from -5 — +5)

CAPTURE UTILITY WINDOW FOR IMAGE CAPTURING

Images stored in the GV-PT2 can be processed and stored in your computer in the bitmap (BMP) format.

Storage format	Extension: *.BMP format (full color / 256 tone / gray scale) Image size 640 x 480 / 320 x 240 / 160 x 120	Edit	Undo / Copy / Rotate 90° / Resize / Change color mode
		Image	Enlarge / Reduce
		Window	Tile / Cascade / Arrange icons / Select file
File	Image capture / Save / Save as / Exit	Help	Help menu / Version

THINGS YOU'LL NEED IN ADDITION THE PROVIDED ACCESSORIES

A commercially available printer cable (3 m or shorter). Use one capable of all-pin wiring. Some PCs are compatible only with a particular design of printer cable. Consult your dealer before purchasing a cable.

When using a printer cable which is over 3 m long, a transmission error may occur.

(Example)

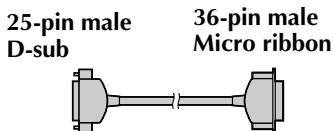

- When connecting components, make sure all units are turned off.

TV
(Set the input
select switch to
VIDEO (EXT.IN))

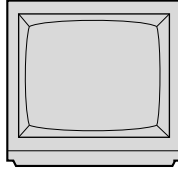

To VIDEO
INPUT

Video cable
(optional)

Machine with S-Video or Video output connector

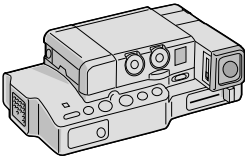

To VIDEO
OUTPUT
connector

To S-VIDEO
OUTPUT
connector

An S-Video cable connection
is recommended for optimal
image quality.

S-Video cable (option)

Video cable (option)

Use if the video recorder
does not have an S-VIDEO
OUTPUT connector.

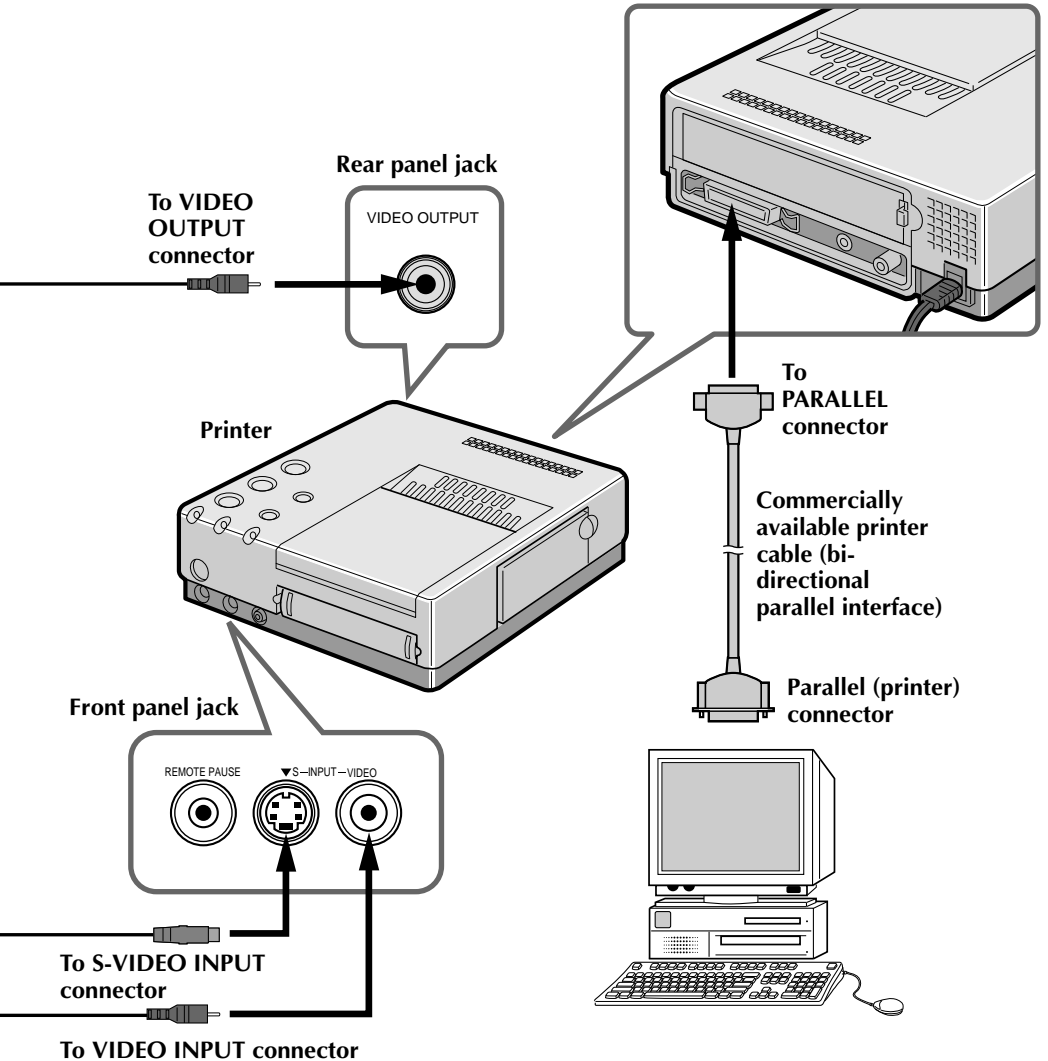

INSTALLING IN A WINDOWS-COMPATIBLE PC

Refer to the Windows® user manual for details on basic Windows® operation.

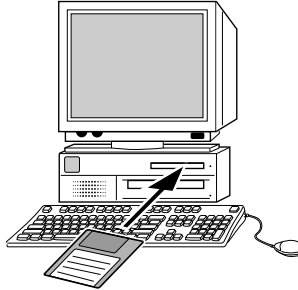
INSTALLATION**★ Setting up ...**

1. Start Windows®.
 - Close any other programs that are open.
2. Insert the “Driver & Capture Utility Software (INSTALL DISK)” into the floppy disk drive.
3.
 - With Windows® 95, select [START]-Run command.
 - With Windows® 3.1, [ICON]-Run on the program manager.
4. Once the Driver & Capture Utility Software has been loaded into drive A, type a:\setup in the [COMMAND LINE] textbox. (Type b:\setup if the disk is in drive B.)
 - Click the <OK> button.
 - Once the setup program launches, follow the instructions that appear on screen.
 - If you agree with the Software License Agreement, type [Yes]. If not, type [No] to quit the program.
 - When the setup is complete, the “JVC GV-PT2 Capture” icon appears on the screen.
 - [Normal installation completed] message is displayed.
5. Click the <Reboot> button.

Windows® closes and then opens again. This completes installation.

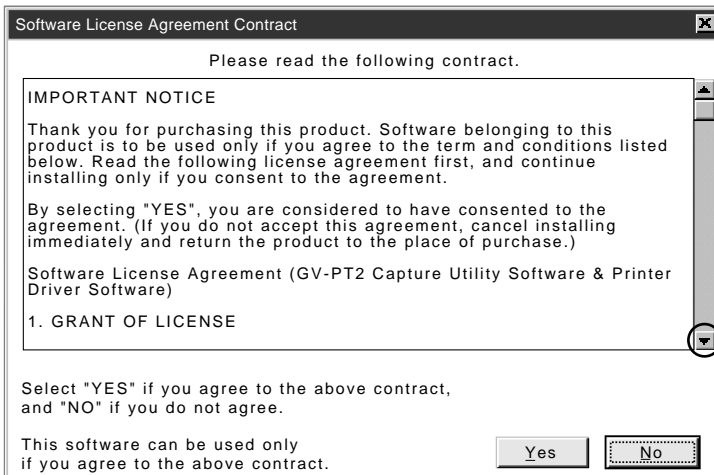
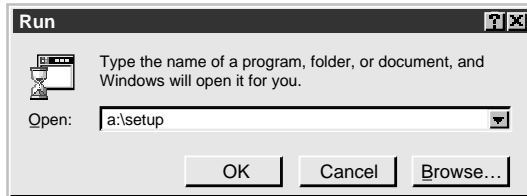

Read to the end of the text (press the scroll button to scroll the text.)

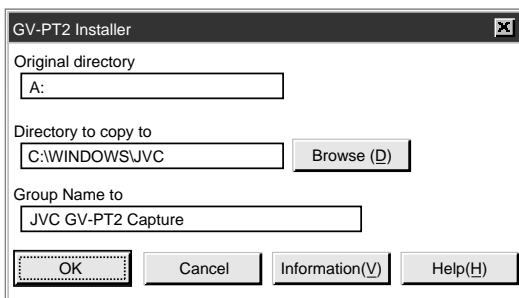

GETTING STARTED

You can launch this program using the standard procedure for Windows®. There are some differences between Windows® 3.1 and Windows® 95.

Windows® 3.1 offers a number of ways to launch an application.

1. Open the group of application icons on the program manager and double-click the application you want to open.
2. Select Run in the program manger, select the file name of the application and click the RUN button.
3. Double-click the application name in the File Manager menu.

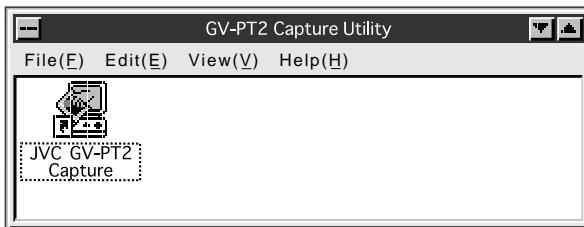

With Windows® 95, click the [START] button on the taskbar, and the program menu appears on the screen. Move the cursor to the program you want to run and click to start the program.

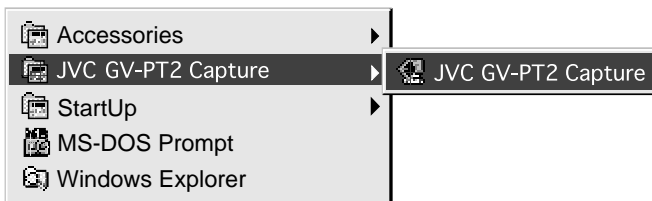

Now let's actually launch the program.

If you're using Windows® 3.1, open the JVC GV-PT2 Capture group on the program manager and double-click the JVC GV-PT2 Capture icon.

If you're using Windows® 95, select JVC GV-PT2 Capture on the start menu and start it.

Once the program has loaded, Windows® 3.1 displays the screen shown below.

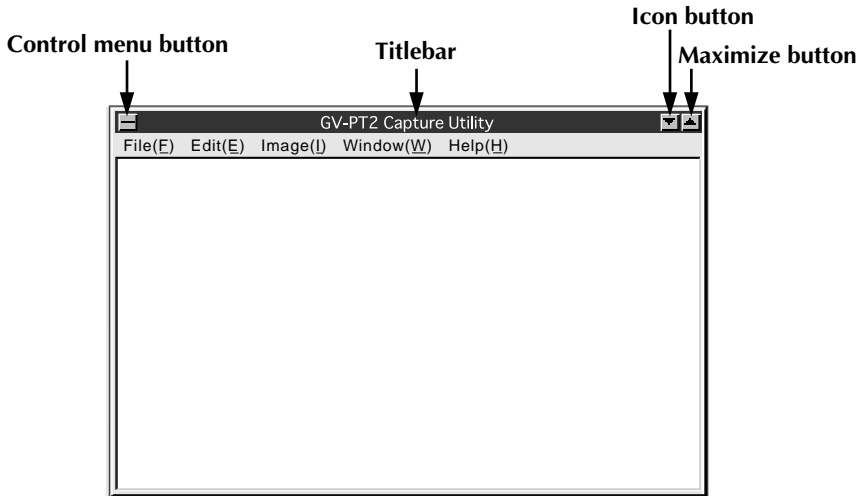

The titlebar and menubar look different on Windows® 95.

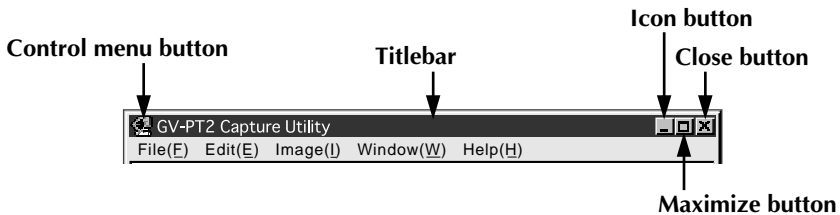

CLOSING THE PROGRAM

Double-click the control menu button in Windows® 3.1 or click Close GV-PT2 Capture Utility (X) on the [File (F)] menu.

With Windows® 95, simply click the Close button.

MENUBAR

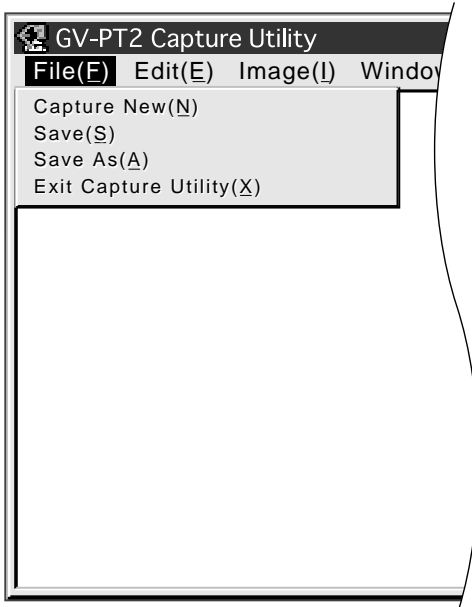

The menubar provides several menus with lists of commands that enable you to execute various program functions.

Click the desired item on the menubar to pull down the menu. Then click on the desired command in the pulldown menu.

Some commands may not be executable depending on where you are in the program. Disabled functions look lighter than other items.

Each menu is configured as shown below

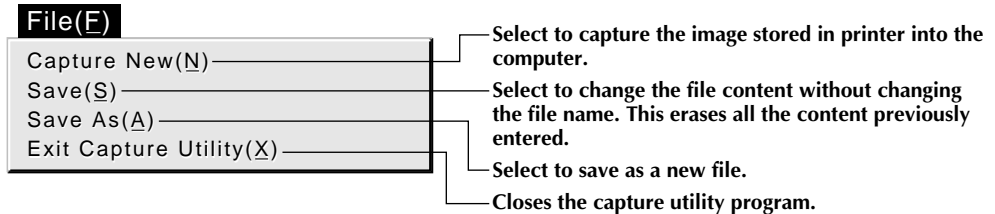

Edit(E)

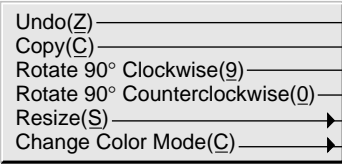

- Select to undo the most recent work done.
- Select to copy to the clipboard. The copy is displayed in color according to the monitor setup.
- Select to rotate through 90° clockwise.
- Select to rotate through 90° counterclockwise.
- Select to reduce the captured image to 1/4 or 1/16.
- Select to change the number of colors (color grade scale) of the capture image.

Captured image

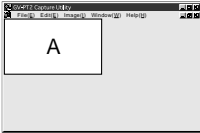

Rotate 90° clockwise

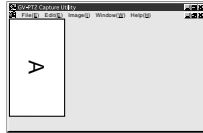

Rotate 90° counterclockwise

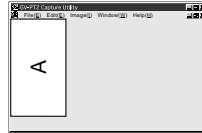

Click Undo when you want to restore the previous image.

Edit(E)

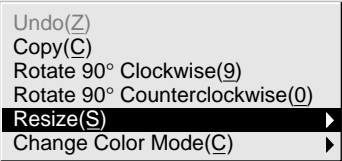

If you want to restore the previous size after resizing, click Undo. If you resized the image more than once, you cannot restore the original size.

640x480->320x240
640x480->160x120

Reduces the current image to 1/4.
Reduces the current image to 1/16.

Captured image

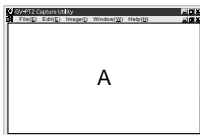

1/4

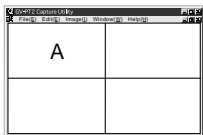

1/16

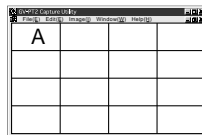

Edit(E)

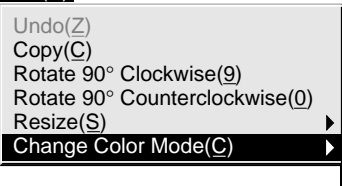

256-Tone Index Color
Gray Scale

Switches between full-color mode, 256-tone index color mode and Gray Scale mode.

Image(I)

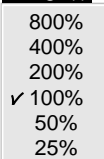

Displays the captured image at the desired magnification.

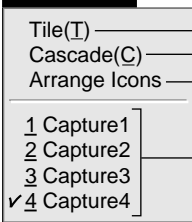
Window(W)

- Arranges the captured images side by side and stacked one upon another. A maximum of four tiles are visible at one time.
- Arranges the captured images in cascade. Shows a maximum of four images overlapping one another.
- Arranges the minimized images side by side.
- Temporary file names for the captured images.

• Tile

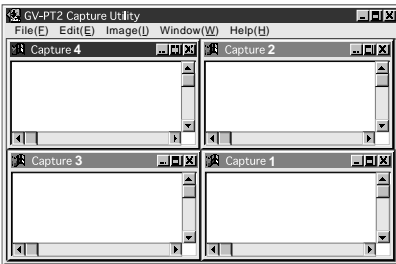

• Cascade

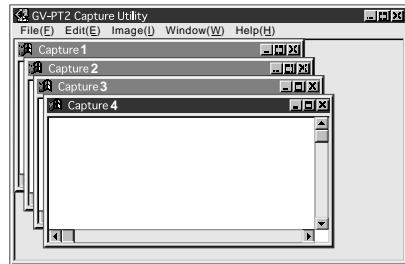

• Arrange Icons

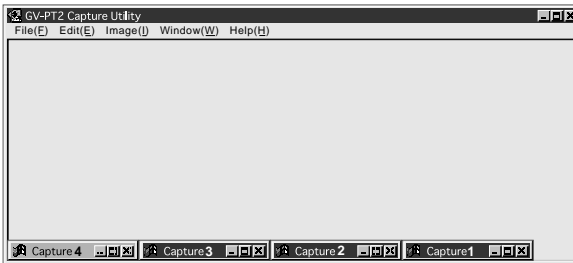
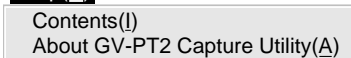
**Help(H)**

- Displays contents of the help file.
- Displays the software version information.

PRINTING AN IMAGE FROM YOUR PC

You can work on images captured on your PC using commercially available Paint software programs — for instance, to add text or modify the image — and then print the results.

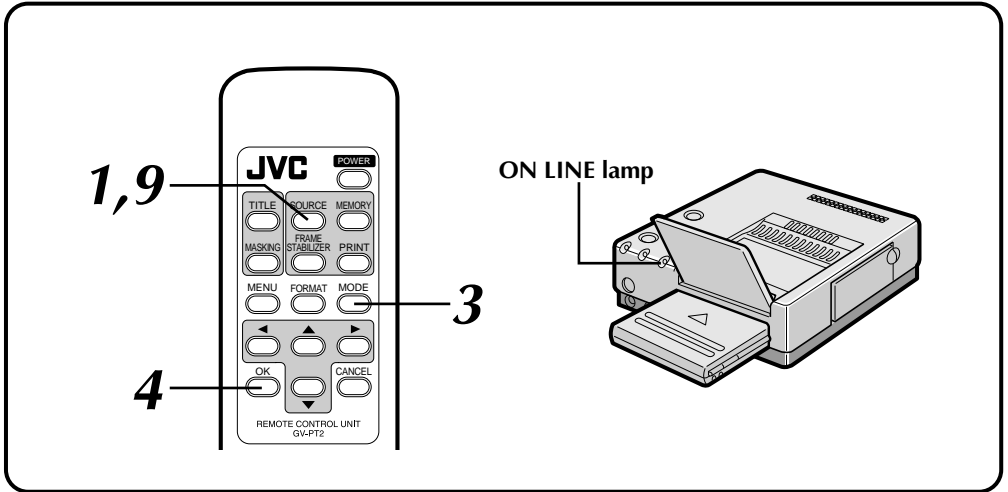

Preparation:

Refer to page 19.

VIDEO PRINTER OPERATION

1. Make sure that the ON LINE lamp is off (in video printer mode).
 - If it is on, press and hold the SOURCE button for at least two seconds to turn off the lamp.
2. Store the image you want to capture on the PC.
3. Press the MODE button on the remote control unit.
 - MODE SELECT MENU appears on the monitor.
4. Press OK.
 - CAPTURE display appears and displays "Waiting for transfer of captured data".

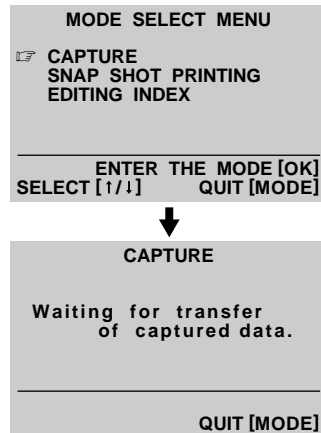

PC OPERATION

5. Capture the image.
- Select [Capture New (N)] in the File menu to transfer the image data from printer to PC.
 - The captured image is framed in white.

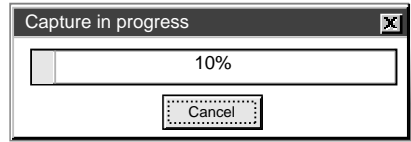

6. Repeat steps 2 through 5 to capture other images.

NOTE: A maximum of four images can be captured with the Capture Utility. If you want to capture more images, save and close one or more of the images you have already captured. You may then capture additional images.

7. Save the captured image(s).
- Type the file name in [Save As (A)] of the File menu and save it. The file will be saved in the bitmap (BMP) form.

PRINT OPERATION

You cannot print the captured image with the provided Driver & Capture Utility Software. Use a commercially available Paint or other photo editing software program to print the image.

8. Launch your photo editing program. Add text or make modifications to the image as desired.
- Refer to the photo editing software's user manual for details.
9. Press and hold the SOURCE for at least two seconds to turn the ON LINE lamp on.
- "PC mode is selected." is displayed on the monitor.

10. Set up the printer.

(Example)

- Windows® 95

Select [Print (P)] of the File menu to call up the print display. Select [JVC GV-PT2] in the printer name box.

- Windows® 3.1

Select [Printer Setup (R)] of the File menu to call up the printer setup display. Select [JVC GV-PT2] as the printer name.



Operations and displays may be different than described above in some applications. Refer to the application's instruction manual for details.

11. Call up the printer setup display (setup dialog).

(Example)

• *Windows® 95*

Click [Properties (P)] on the display on page 64, and the [Setup Dialog] box appears.

• *Windows® 3.1*

Click [Option (O)] on the printer setup display, and the [Setup Dialog] box appears.

• *Select print orientation, number of prints and image adjustment.*

• *When this is done, click OK. The new settings are saved and the Setup Dialog box closes.*

12. To start printing ...

• *Click [OK] on the display on page 64 to open the [Spooler] window. When the all the print data is transferred to the printer (the spooler bar reaches the end), printing starts.*

• *When printing is finished, press and hold the SOURCE button for at least two seconds to turn the ON LINE lamp off (video printer mode).*

NOTE : *Printing may not work properly with some software programs.*

HOW THE SETUP DIALOG WORKS

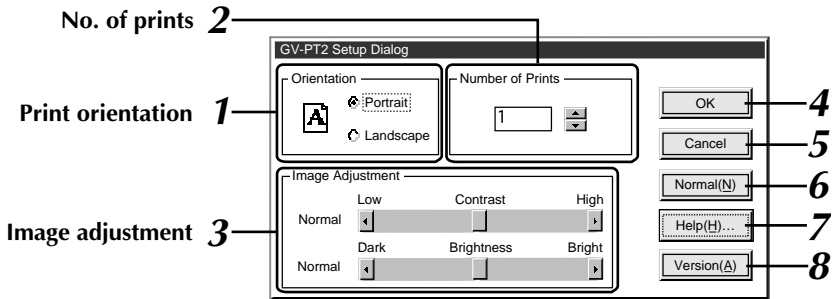
**1. Print orientation**

Select when printing.

Portrait : Select when printing a vertical image layout.
(Maximum size: H 480 dots x V 640 dots)

Landscape : Select when printing a horizontal image layout.
(Maximum size: H 640 dots x V 480 dots)

2. Number of prints

Enter a number when you want to make multiple prints of the same image. Up to 25 prints possible.

3. Image adjustment

Select when you want to adjust how the image looks.

Contrast (Low/High adjustment):
Adjustable between -5 (min.) and +5 (max.).

Brightness:
Adjustable between -5 (min.) and +5 (max.).

4. [OK]

Click to validate the change you have made.

5. [Cancel]

Click to cancel the change you have made and close this window.

6. [Normal (N)]

Click to set contrast and brightness to normal.

7. [Help (H)]

Click to call up help information.

8. [Version (A)]

Click to display the GV-PT2 printer driver version.

HOW THE SPOOLER WINDOW WORKS

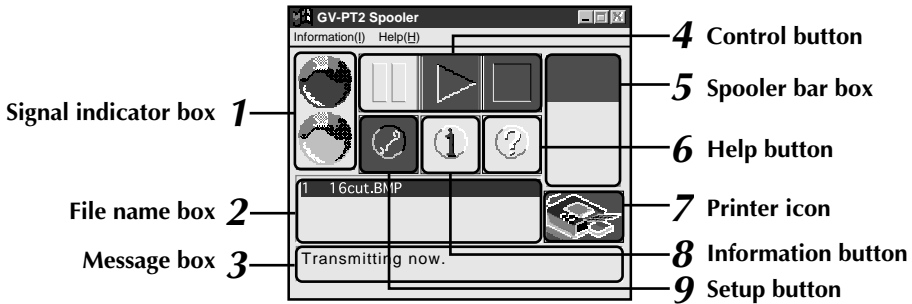

1. Signal indicator box

Red : Print data capture in pause.
Blue : Print data capture in progress.





2. File name box

Displays the names of the files which have been specified for printing. The Printing sequence can be changed for the second and subsequent files. Select the line you want to move and drag it to wherever you want.

3. Message box

Displays the current status.

4. Control button

-  : Click to pause the spooler.
-  : Click to re-open the spooler. When an error message appears, click [Close] and then .
-  : Click to delete the spooler bar.

5. Spooler bar box

Displays progress of the data transfer from PC to printer. Print starts when the bar is fully down.

6. Help button

Click to call up help information for the spooler window. Same as [Help] on the menu bar.

7. Printer icon

Displays the current printer status. See Help for details.

8. Information button

Displays the spooler version.

9. Setup button

Spooler setup can be changed depending on how Windows® is used.

- Shape when opening the spooler
 - State when opening the spooler
 - How to open the spooler
 - How to close the spooler
- See Help for details.

WHAT TO DO IF ANY OF THE MESSAGES BELOW APPEAR

VIDEO PRINTER MODE

Message	<ul style="list-style-type: none"> ● Appears when: ■ Action: 	Page
Please wait.	<ul style="list-style-type: none"> ● Power is turned on, or title impose or masking data are being prepared. ● Printer internal temperature rises. The message may remain for about 3 minutes until the printer has cooled down. 	40 44
Set ink cassette and close cover.	<ul style="list-style-type: none"> ● Ink cassette not set or improperly set. ■ Insert the ink cassette until it clicks and close the cover. 	16
Set paper tray.	<ul style="list-style-type: none"> ● Paper tray is not inserted correctly. ■ Place color print paper sheets on the paper tray and insert it correctly. 	18
Open output tray.	<ul style="list-style-type: none"> ● Output tray is closed. ■ Open the output tray. 	10
Paper is not compatible with ink cassette. Open back door and remove paper.	<ul style="list-style-type: none"> ● Print sheets are not compatible with the ink cassette model or the print paper orientation is wrong. ■ Open the jammed paper removing door and remove the jammed sheet. Make sure that the color print paper sheets are compatible with the ink cassette model. 	73 17
Pull out paper tray and check paper.	<ul style="list-style-type: none"> ● Paper tray is running out of paper or paper feed is not working improperly. ■ Remove the paper tray and correctly set print sheets. 	18
Replace ink cassette. Pull out paper tray and check paper.	<ul style="list-style-type: none"> ● Ink cassette is consumed. ■ Replace with a new one. 	16
Now printing!! Number of sheets: 1	<ul style="list-style-type: none"> ● During printing. 	—

WHAT TO DO IF ANY OF THE MESSAGES BELOW APPEAR

VIDEO PRINTER MODE

Message	<ul style="list-style-type: none"> ● Appears when: ■ Action: 	Page
Paper jammed. Remove paper.	<ul style="list-style-type: none"> ● Paper is jammed during printing. ■ Remove paper (refer to page 73). 	73
Close back door.	<ul style="list-style-type: none"> ● Jammed paper removing door is open. ■ Close the jammed paper removing door. 	11
PC mode is selected.	<ul style="list-style-type: none"> ● The SOURCE button is pressed and held for at least two seconds and the ON LINE lamp has been turned on. 	64
Video printer mode is selected.	<ul style="list-style-type: none"> ● The SOURCE button is pressed and held for at least two seconds and the ON LINE lamp has been turned off. 	63
Waiting for transfer of captured data.	<ul style="list-style-type: none"> ● With a desired image stored for printing, "CAPTURE" has been selected on MODE SELECT MENU and OK button pressed. 	63
Transferring captured data!!	<ul style="list-style-type: none"> ● On PC, [File]-[Capture New] has been selected on the Capture Utility window. 	64

WHAT TO DO IF ANY OF THE MESSAGES BELOW APPEAR

PC PRINTER MODE

Message	<ul style="list-style-type: none"> ● Appears when: ■ Action: 	Page
<p>Failed in connecting with a printer. Check printer type, cable connection, and power.</p>	<ul style="list-style-type: none"> ● Printer power is not on, printer is improperly connected, or BIOS setting is not correct. ■ Turn the printer power on after checking to make sure connections are correct. 	<p>52 54</p>
<p>Check the back door or the paper / output trays.</p>	<ul style="list-style-type: none"> ● The jammed paper removing door is not fully closed. ■ Close the jammed paper removing door. ● The paper tray is not inserted properly. ■ Insert the paper tray. ● The output tray is closed. ■ Open the output tray. 	<p>18</p>
<p>No ink cassette loaded. Set ink cassette and close cover.</p>	<ul style="list-style-type: none"> ● The ink cassette is not installed or is improperly installed. ■ Insert the ink cassette and close the door. 	<p>16</p>
<p>Paper is not compatible with ink cassette. Open back door and remove paper.</p>	<ul style="list-style-type: none"> ● Print sheets are not compatible with the ink cassette model or the paper orientation is wrong. ■ Open the jammed paper removing door and remove the jammed paper. Make sure that the print paper is compatible with the ink cassette model. 	<p>73 17</p>
<p>PC mode is selected. Switch to the Capture mode.</p>	<ul style="list-style-type: none"> ● With the printer ON LINE lamp on, [File]-[Capture New] is selected on the Capture Utility window. ■ Press and hold the printer ON LINE button for at least 2 seconds to turn the lamp off. Then store the image to be printed, select "CAPTURE" on the MODE SELECT MENU and press OK. 	<p>63</p>
<p>Video printer mode is selected. Switch to the Capture mode.</p>	<ul style="list-style-type: none"> ● Capture is not selected on the MODE SELECT MENU. ■ Store the image to be printed, select "CAPTURE" on the MODE SELECT MENU and press OK. 	<p>63</p>

WHAT TO DO IF ANY OF THE MESSAGES BELOW APPEAR

PC PRINTER MODE

Message	<ul style="list-style-type: none"> ● Appears when: ■ Action: 	Page
Video printer mode is selected. Switch to the PC mode.	<ul style="list-style-type: none"> ● The printer is in video printer mode when a print command is issued from the PC. ■ Press and hold the printer ON LINE button for at least 2 seconds to turn the lamp on. 	64
Capture mode is selected. Switch to the PC mode.	<ul style="list-style-type: none"> ● The printer is in Capture mode when a print command is issued from the PC. ■ Press the MODE button to close the Capture mode window, then press and hold the printer ON LINE button for at least 2 seconds to turn the lamp on. 	64
Ink cassette is empty. Replace ink cassette. Pull out paper tray and check paper.	<ul style="list-style-type: none"> ● Ink cassette is running out. ■ Replace with a new one. Make sure that the print paper is compatible with the ink cassette model. 	16 1 18
Paper jammed. Remove paper.	<ul style="list-style-type: none"> ● Paper jams during printing. ■ Remove jammed paper referring to page 73. 	73
Pull out paper tray and check paper.	<ul style="list-style-type: none"> ● The paper tray is running out of paper or paper feeding is not working. ■ Remove the paper tray and set print sheets correctly. 	18
Printer has malfunctioned unexpectedly. Printing will be cancelled.	<ul style="list-style-type: none"> ● Any abnormality occurs during printing. ■ Turn the power off, unplug the power cord, then plug the cord back in and turn the power on again. If the message remains, consult your dealer or your local JVC service center. 	—

OTHER PROBLEMS:

If	Check to see if	Page
power won't turn on	<ul style="list-style-type: none"> ● power cord is unplugged. 	—
Error lamp lights (or blinks)	<ul style="list-style-type: none"> ● any message appears on the screen. If a message appears, take the appropriate action as indicated on pages 68 to 71. If no message appears, turn the power off, unplug the cord and wait several minutes. Then plug the cord back in and turn the power on again. 	68 71
paper is jammed	<ul style="list-style-type: none"> ● paper jam may be due to: <ul style="list-style-type: none"> • incompatibility of paper with ink cassette • wrong paper orientation • the printer set upright or tilted ● remove paper as directed on page 73. 	73
two or more stacked sheets have printed	<ul style="list-style-type: none"> ● color print paper sheets have been properly shuffled. If not, shuffle them thoroughly to separate each sheet before placing them on the paper tray. 	18
the image you want to print from the playback unit cannot be called up on screen.	<ul style="list-style-type: none"> ● video cable is correctly connected. ● input select switch of TV is set to VIDEO (EXT.IN). ● input connector priority has been observed. 	14 10
the image on the TV screen won't change or the stored image has disappeared.	<ul style="list-style-type: none"> ● MEMORY mode has been entered. If so, press the SOURCE button. ● the power has been turned off. The stored image disappears when the power is turned off. Store the image in memory again. 	—
color is weak or wrong.	<ul style="list-style-type: none"> ● colors are generally acceptable. The colors on the TV screen may be somewhat different from those actually printed, which is normal with this Printer. 	—
the image to be printed is expanded vertically or black bars appear at the top and bottom of the image.	<ul style="list-style-type: none"> ● you are making multiple prints of images recorded in "SQUEEZE" or "CINEMA" mode. In this mode, <ul style="list-style-type: none"> • SQUEEZE mode is engaged. If so, the image is stretched vertically. • CINEMA mode is engaged. If so, black bars will appear at the top and bottom of the image. 	—
the top of the printed image is not straight.	<ul style="list-style-type: none"> ● you have printed a playback image from a tape recorded on another VCR. If so, the top zone of the image may not be straight. This is normal with this printer. 	—

WHEN PAPER JAMS

1. Unplug the power cord.
 - The stored image disappears.
2. Remove the jammed sheet from the output tray.

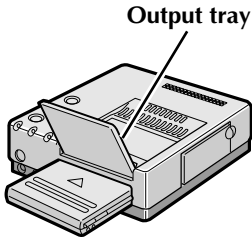

If no paper is jammed in the slot of the paper tray

4. Remove the jammed paper removing door and remove the paper.

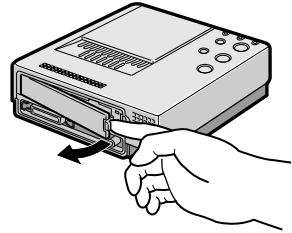

If no paper is jammed in the output tray

3. Remove the paper tray and remove the jammed sheet.

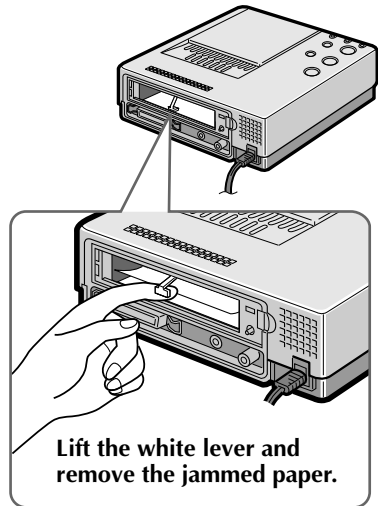
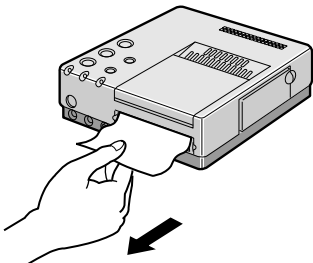
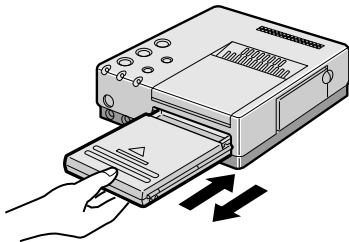







5. After removing the paper, insert the paper tray and re-place the jammed paper removing door.
6. Plug in the power cord and turn on the power.



Power	AC 120 V ~, 60 Hz
Power consumption	During printing : Approx. 63 W, 1.0 A When idle : Approx. 4 W
Signal	NTSC standard
Print format	Sublimation dye thermal transfer line printing
Print quality	Resolution : 640 (horiz.) x 480 (vert.) dots Gradation : 256 tones
Print medium	Ink sheet : Cartridge (dedicated) 3-color consecutive printing (yellow, magenta, cyan) Print sheet : Paper size 144 x 100 mm (dedicated) Maximum print area 112 x 84 mm
Connectors	S-Video input : S-connector (front x 1) Normal video input : Pin jack (RCA connector) (front x 1) (1.0 V p – p, 75 Ω unbalanced) Normal video output : Pin jack (RCA connector) (Rear x 1) (1.0 V p – p, 75 Ω unbalanced) Remote pause : ø 3.5 mm Mini jack (bipolar) JLIP : ø 3.5 mm Mini jack (four poles) PARALLEL : Amphenol 36 pin
Operating temperature	+5 — +35°C (+41 — +95°F)
Operating humidity	35 — 80%
Storage temperature	–20 — +60°C (–4 — +140°F)
Operating position	Level (horizontal) ±5°
Dimensions	213 W x 90 H x 213 D mm (8-7/16" x 3-9/16" x 8-7/16")
Weight	Approx. 2.3 kg (5.1 lbs)

Design and specifications subject to change without notice.

C

- Calendar Print  pg. 38
- Camera Title Impose  pg. 42
- Capture the Image Into PC  pg. 64
- Capture Utility  pg. 60
- Capture Utility window  pg. 60
- Color Print Paper Sheet Set  pg. 17
- Content of Images  pg. 23

E

- Editing Index  pg. 48
- Error Messages  pg. 68–71



F

- FORMAT SELECT MENU  pg. 23
- Frame Stabilizer  pg. 21,24–39,47–49

H

- How the Setup Dialog Works  pg. 66
- How the Spooler Window Works  pg. 67





I

- ID Number  pg. 22
- Inset Print  pg. 28
- Installation  pg. 56
- Installation of Ink Cassette  pg. 16



L

- Layout  pg. 23

M

- Masking Print  pg. 44
- MODE SELECT MENU  pg. 46,48,64
- Multi-Print (Different Scenes)  pg. 26
- Multi-Print (Same Scene)  pg. 24

N

- Name Sticker Print  pg. 36
- Number of Images  pg. 23

O

- ON SCREEN  pg. 22

P

- PRINTER MENU  pg. 22

S

- Snapshot Print  pg. 46
- Stored Title Impose  pg. 40
- Strobe Print  pg. 30
- Strobe Speed  pg. 23,30

V

- Vertical Layout Print  pg. 32
- Video Cassette Label Print  pg. 34

W

- When Paper Jams  pg. 73



JVC

JVC COMPANY OF AMERICA

DIVISION OF US JVC CORP.

41 Slater Drive, Elmwood Park, N.J. 07407

JVC CANADA INC.

21 Finchdene Square, Scarborough Ontario M1X 1A7

Free Manuals Download Website

<http://myh66.com>

<http://usermanuals.us>

<http://www.somanuals.com>

<http://www.4manuals.cc>

<http://www.manual-lib.com>

<http://www.404manual.com>

<http://www.luxmanual.com>

<http://aubethermostatmanual.com>

Golf course search by state

<http://golfingnear.com>

Email search by domain

<http://emailbydomain.com>

Auto manuals search

<http://auto.somanuals.com>

TV manuals search

<http://tv.somanuals.com>