

JVC

HD-Z70RX5 HD-Z56RX5

Rear Projection TV

INSTRUCTIONS



HD-ILA™
Powered by **D-ILA**

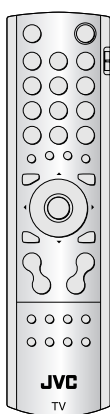

LCT1911-001A

Introduction

Thank you for buying this JVC projection television.

To make sure you understand how to use your new TV, please read this manual thoroughly before you begin.



The most amazing picture imaginable is what you will see with JVC's HD-ILA Rear Projection Television. This Widescreen model is built on JVC's 3-Chip D-ILA Technology, a revolutionary Micro-display technology that will give you the most incredible picture imaginable. Packed with supporting features like NEW 5-Point Color Management, Dynamic Gamma Correction Circuitry, an HDMI/HDCP Digital Input, 2 HD Component Inputs and JVC's D.I.S.T 1080i, 720p (Digital Image Scaling Technology), JVC delivers the most technologically advanced and superior Micro-display televisions available today.*

The Big Picture - Product overview

HD-ILA televisions were developed by the world's most brilliant and dedicated engineers. Every new feature is designed to become the perfect complement to every existing feature. And, at the same time, our engineers continually strive to improve upon all of our proven and existing features so that each generation of JVC television is even more outstanding than preceding ones.

Microdisplay Technology - The D-ILA chip

HD-ILA TV is the most technologically advanced microdisplays available today. Powered by the same D-ILA (Direct-drive Image Light Amplifier) microchips employed by our highly successful professional video projectors, HD-ILA microdisplays make up JVC's flagship television line-up.

The HD-ILA Advantage - Replaceable lamp

At JVC, we believe that convenience factors make all the difference in the world. This TV is equipped with a long life user replaceable lamp. The old lamp can be pulled straight out and the new lamp pushed straight back into place.

***D.I.S.T. demonstration**

To start the D.I.S.T. demonstration:

Press the **MENU** button to display the menu bar. Then press the yellow button.

A picture split in two (D.I.S.T. turned on and D.I.S.T. turned off) will appear on the screen.

To quit the D.I.S.T. demonstration:

Press the yellow button, **BACK** button, **CHANNEL** \vee/\wedge buttons or any of the number buttons.

Warnings

Please follow all the guidelines below.

Never insert objects into the cabinet openings!

It may cause a fatal electric shock.
Take care when children are near.

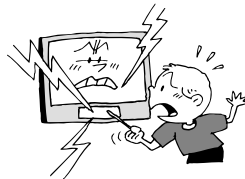

Never dismantle the rear panel!

It may cause an electric shock.

Never obstruct the ventilation holes!

It may cause overheating or a fire.

Handle the screen with care!

Use a soft, dry cloth when cleaning.
Do not apply alcohol, organic solvents (like acetone), acidic or alkaline cleansers to the screen.
Do not push or hit the screen.

Never place anything on the TV!

Placing liquids, naked flames, cloths, paper, etc. on the TV may cause a fire.



Never try to repair the TV yourself!

If the problem cannot be solved in "Troubleshooting" on page 26, unplug the power cord and contact your retailer.

If the TV is damaged or behaving strangely, stop using it at once!

Unplug the power cord and contact your retailer.

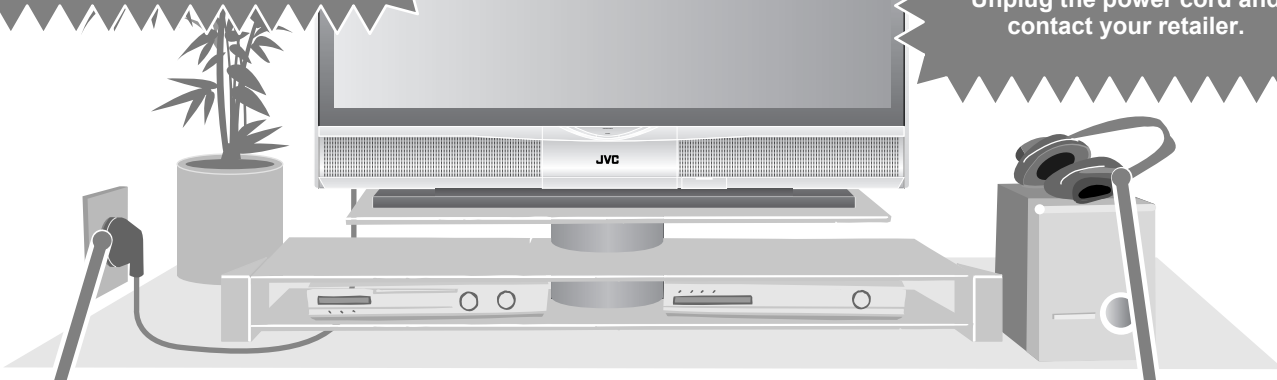

Never cut or damage the power cord!

If the AC plug is not the right shape, or the power cord is not long enough, use an appropriate plug adapter or extension cable. (Consult your retailer.)

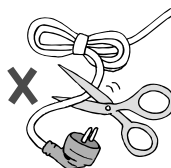

Unplug the power cord when going out!

The power buttons on the remote control and the TV unit cannot completely turn off the TV. (Make appropriate arrangements for bedridden people.)

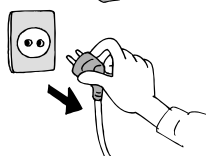

Never listen to headphones at high volume!

It may damage your hearing.

Follow this manual regarding setup!

Connect only to a 110-240V, 50/60Hz AC outlet.

Never expose to rain or moisture!

To prevent fire or electric shock, never allow liquids to enter the unit.

Do not allow the TV to fall!

Do not rest your elbows on, or allow children to hang from the TV. There is a risk that the TV will fall and cause injuries.



Installation requirements

To avoid overheating, ensure the unit has ample room.

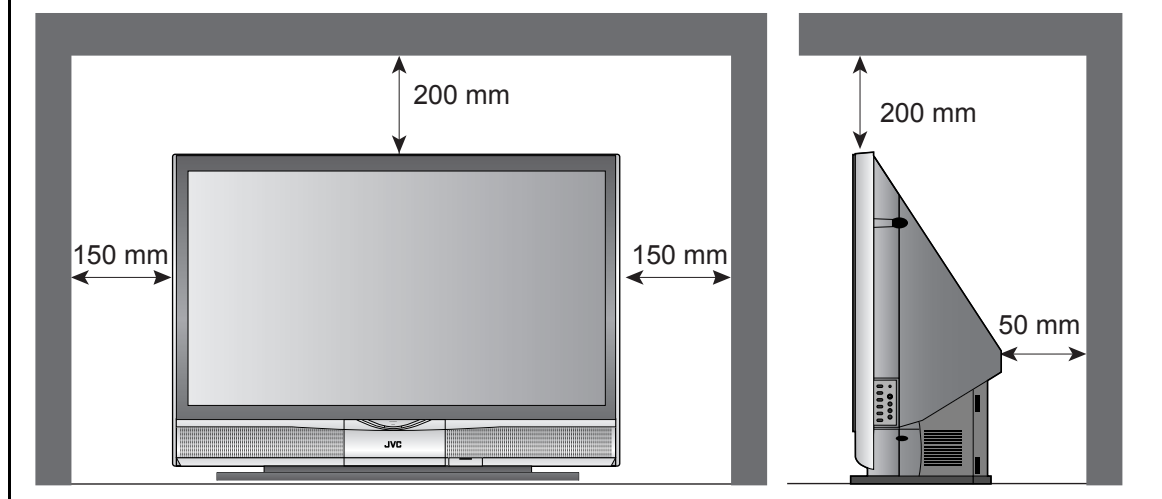

In order to use the television for a long time

This television uses a lamp to project the picture onto the screen. Before using this television, please read the safety cautions and information about this television which are summarized below (1 to 10).

1. When the power is turned on, the warming up commences

This television uses a lamp to project the picture onto the screen. Once the lamp has warmed up, you can enjoy the pictures at their full brightness. What happens when the power is turned on is explained below. Immediately after the power is turned on, since the lamp has not had time to warm up, the picture is displayed only dimly on the screen. As the lamp warms up, the picture becomes brighter. It takes approximately one minute for the lamp to warm up to its normal operating temperature. There are 2 LED indicators on the front panel of the television that can be used as a guide. When the POWER button is pressed, the LAMP LED indicator blinks in orange for approximately 1 minute at approximately every 2 seconds, and then goes out.

- It is impossible to turn the power off during this period. After 1 or more minutes have passed, you can turn off the power.

2. Cooling the inside of the television and the lamp

Cooling is also performed while the television is being shut down.

When the POWER button is pressed to turn off the power, the following operations are performed. When the television is turned off, the picture on the screen disappears gradually within approximately 5 seconds. Once the screen is dark, cooling is performed for approximately 90 seconds. When the cooling is being performed, the LAMP LED indicator on the front panel blinks in orange at approximately every 3 seconds. **The television can not be operated while the cooling is being performed.** After the cooling has been performed for 90 seconds, the power is turned off. **Do not remove the electrical plug until after the cooling process has completed.** If the electrical plug is removed before the cooling process has completed, the internal circuits and lamp may overheat leading to the life of the lamp being shortened and the possibility of malfunctions.

- When it is hotter, the cooling fan works harder to cool the lamp. The noise of the fan becomes bigger then but it is not malfunction.
- You can cancel to turn off the power by pressing the POWER button before the picture on the screen disappears completely.

Do not block the ventilation holes.

3. The lamp is a consumable item

Replace the lamp when it has blown or when the picture becomes dark. The lamp is a user replaceable item. The lamp must be recycled. For a detailed explanation on how to recycle the lamp, refer to the Appendix and the instructions that are included with the replacement lamp kit. The life of the lamp changes depending on the atmospheric temperature and altitude in which the TV is being used.

Do not turn the power on and off repeatedly in a short amount of time.

It subjects the television and the lamp to stress and may lead to malfunctions and the life of the lamp being shortened.

4. Caution! Warm air from the air ducts

This unit has an air duct for cooling. The duct will blow warm air while the television is operating. When placing the television, make sure not to locate it too close to wallpaper. The warm air could cause the color of the wallpaper to change. Also, take care to keep children and pets away from the warm air ducts. Long exposure to the warm air from the ducts could cause a minor burn.

5. Caution! Moving this television

When lifting this television, Do not hold by the screen frame. Holding the screen frame could cause it to detach, causing the television to fall.

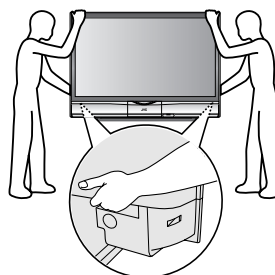

6. Do not replace the lamp immediately after use

The lamp becomes extremely hot during use. If the lamp is touched immediately after use before it has a chance to cool down, there is a danger of burns. Be careful when handling the lamp.

7. Do not touch the lamp glass

If the lamp is used when there is dirt from fingers on the lamp glass, there is a possibility of the lamp breaking. Be careful not to touch the lamp glass.

8. ILA element characteristics

Do not project still pictures or pictures that have still segments for a long period of time. The still parts of the picture may remain on the screen. This is a characteristic of ILA elements and not a malfunction. The picture will disappear over time.

9. Condensation

When a heater is turned on or the television is moved from a cold place to a hot place, droplets of water may form on the lamp and screen. This is called condensation. If the television is used while this condensation is still present, the picture may seem distorted, and the inside of the screen may become dirty. In this case, wait until the condensation has gone before using the television.

10. Usable Time

Do not keep the TV on for more than 24 hours consecutively. There is a possibility of the life of the lamp being shortened.

CONTENTS

Introduction	1	SOUND menu	18
Warnings	2	STEREO / I • II	18
Setting up your TV	5	BASS	18
Installation	5	TREBLE	18
Connecting the aerial and video cassette recorder (VCR)	5	BALANCE	18
Connecting the power cord to the AC outlet	5	CINEMA SURROUND	18
Putting the batteries into the remote control	5	BBE	18
Turning the TV on	5	FEATURES menu	19
Initial settings (Setup tour)	6	SLEEP TIMER	19
TV buttons and functions	7	CHANNEL GUARD	19
Turning the TV on from standby mode	7	APPEARANCE	20
Choosing a TV channel	7	BLUE BACK	20
Adjusting the volume	7	CHILD LOCK	20
Using the Menu	7	AUTO SHUTOFF	20
Remote control buttons and functions	8	FAVOURITE SETTING	20
Turning the TV on or off from standby mode	8	ILLUMINATION	20
Choosing a TV channel and watch images from external devices	8	SET UP menu	21
Adjusting the volume	9	AUTO PROGRAM	21
Display function	9	EDIT/MANUAL	21
ZOOM function	9	LANGUAGE	23
CINEMA SURROUND function	10	VIDEO-1 SETTING/VIDEO-3 SETTING	23
Using the "Freeze" function	10	AI VOLUME	23
Using the "Multi-picture" function	11	TELETEXT LANGUAGE	23
RETURN PLUS function and Return function	11	HDMI SETTING	23
Favourite channel function	12	LAMP TIMER RESET	23
Operating a JVC brand DVD player	12	Additional preparation	24
Operating a JVC brand VCR	12	Connecting external equipment	24
Teletext function	13	Troubleshooting	26
Basic operation	13	Severe noise or snow	26
Using the List Mode	13	Patterns, stripes or noise	26
Hold	13	Ghosting	26
Sub-page	13	I can't turn it on!	26
Reveal	13	The remote control doesn't work!	26
Size	13	Warning LED Messages	26
Index	13	The followings are not malfunctions	28
Cancel	13	Technical Information	28
Using the TV's menu	14	Connection with HDMI or DVI devices	28
Basic operation	14	PC Signals that can be displayed	28
PICTURE menu	15	CH/CC numbers	29
PICTURE MODE	15	Appendix	30
CONTRAST	15	Changing the Lamp	30
BRIGHT	15	Replacement Lamp Kit	30
SHARP	15	Lamp Message	30
COLOUR	15	How to Replace the Lamp	31
TINT	15	LAMP TIMER RESET	31
WHITE BALANCE	15	Specifications	32
FEATURES	16		

Setting up your TV

Installation

Cautions for installation

- Install the TV in a corner, against a wall or on the floor so as to keep cords out of the way.
- The TV will generate a slight amount of heat during operation. Ensure that sufficient space is available around the TV to allow satisfactory cooling. See "Installation requirements" on page 3.

Connecting the aerial and video cassette recorder (VCR)

Caution

- Turn off all the equipment including the TV before connecting anything.

- Aerial cable is not supplied. Use a good quality 75-ohm coaxial cable.
- Read the manual that came with the VCR before connecting.

■ When connecting the aerial without a VCR:

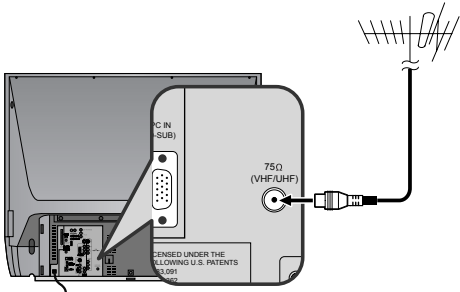

■ When connecting the aerial with a VCR:

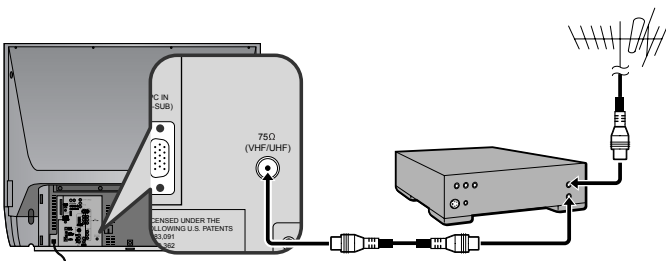

To connect a video and audio cable to a VCR

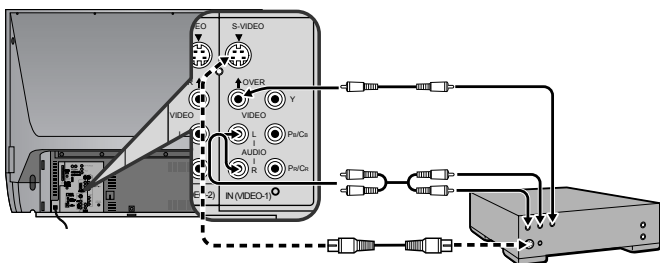

Note that the connection with a video cable will be ignored in case you connect a VCR to the TV with both video cable and S-VIDEO cable.

- To connect additional external devices, please see "Additional preparation" on page 24.

Connecting the power cord to the AC outlet

Insert the AC plug on the power cord from the TV into AC outlet.

Caution

- Operate only from the power source specified (AC 110 – 240 V, 50/60 Hz) on the unit.

- Remove the AC plug from the outlet to completely disconnect the TV from the power supply.

Putting the batteries into the remote control

Use two AA/R6 dry cell batteries.

Insert the batteries from the ⊖ end, making sure the ⊕ and ⊖ polarities are correct.

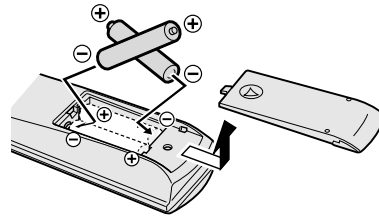

- The batteries we supply are only for setting up and testing your TV, please replace them as soon as you need to.

Turning the TV on

Press the **POWER** button on the TV or **⏻/I** (standby) button on the remote control.

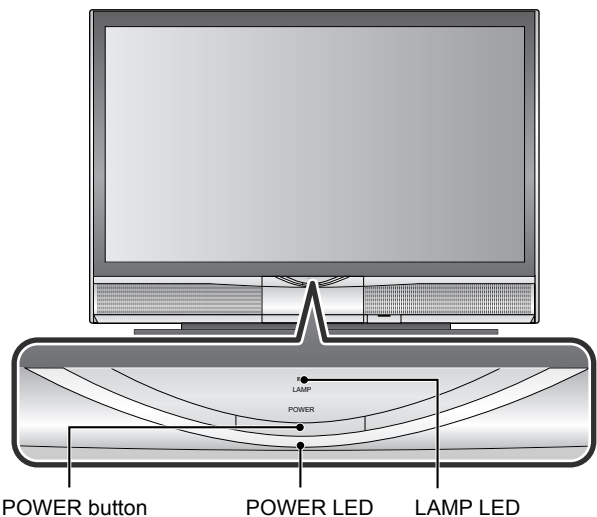

When the **POWER** button is pressed, the **POWER LED** lights up and the **LAMP LED** indicator blinks in orange for approximately 1 minute at approximately every 2 seconds.

As the picture becomes brighter, the **LAMP LED** goes out.

- Immediately after the power is turned on, the picture is displayed only dimly on the screen.
- It is impossible to turn the power off during this period. After 1 or more minutes have passed, you can turn off the power.
- When the TV is first turned on, it goes into the initial settings mode (see "Initial settings (Setup tour)" on page 6).

Initial settings (Setup tour)

When the TV is first turned on, it goes into the initial settings mode, and you will see the JVC logo. Follow the instructions on the screen display to make the initial settings.

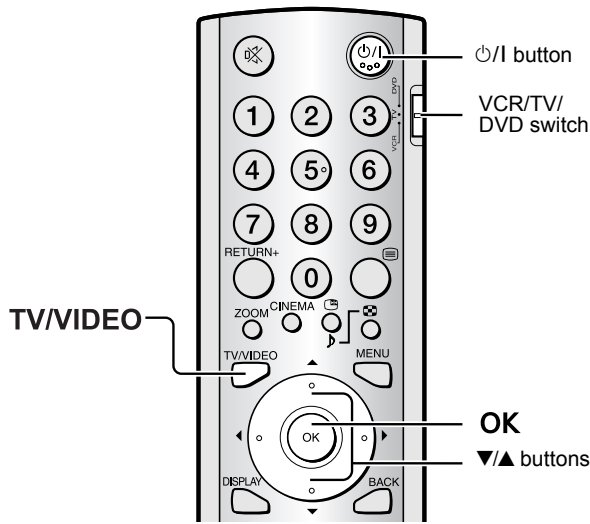

1 Make sure to set the VCR/TV/DVD switch on the remote control to the TV position

- You cannot turn the TV on when the VCR/TV/DVD switch is set to the DVD position.

2 Press the POWER button on the TV or ⏻ (standby/on) button on the remote control

The TV turns on from standby mode and the JVC logo is displayed.

- Check that the AC plug on the power cord from the TV is connected to AC outlet.

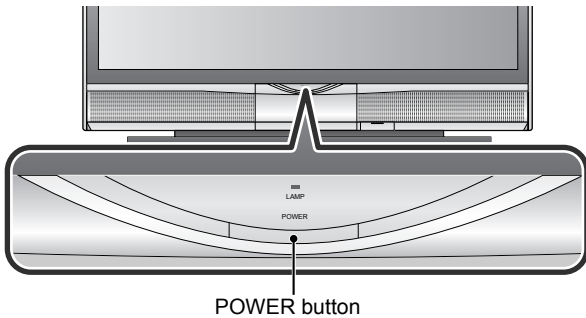

- If the JVC logo does not appear this is because your TV has already been turned on for the first time; use the “LANGUAGE”, “TELETEXT LANGUAGE” and “AUTO PROGRAM” functions to make the initial settings. For details, see “SET UP menu” on page 21.

3 Press the OK button

The LANGUAGE menu appears.

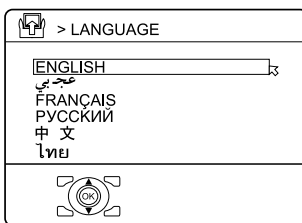

4 Press the ▼/▲ buttons to choose ENGLISH. Then press the OK button

The TELETEXT LANGUAGE menu appears. Set the teletext language group that corresponds to the language of the teletext programme that you want to watch.

For details, see “TELETEXT LANGUAGE” on page 23.

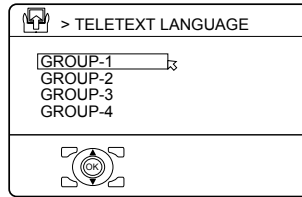

5 Press the ▼/▲ buttons to choose a group. Then press the OK button

The AUTO PROGRAM function starts. The TV channels you receive are automatically stored in the programme numbers (PR) list.

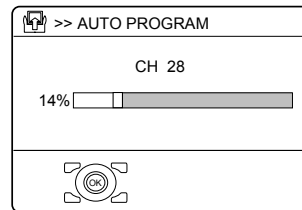

- To stop the AUTO PROGRAM function, press the OK button.

6 After the TV channels have been registered in the programme numbers (PR), the EDIT menu appears

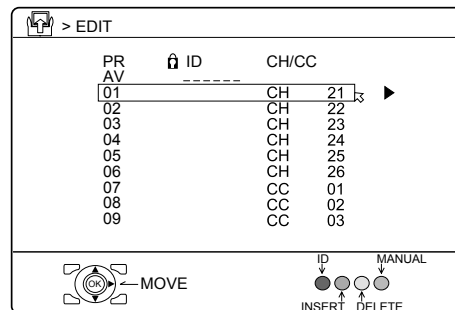

- You can proceed to edit the programme numbers (PR) list using the EDIT/MANUAL function. For details, see “EDIT/MANUAL” on page 21.
- If a TV channel you want to view is not stored in the programme numbers (PR) list, you can register it using the MANUAL function. For details, see “EDIT/MANUAL” on page 21.
- The AUTO PROGRAM function does not store a TV channel to the programme number PR 0 (AV).
- If you do not need to use the EDIT/MANUAL function, press the OK button to close the EDIT menu.

Now, setting up is complete.
Please enjoy your new JVC TV!

TV buttons and functions

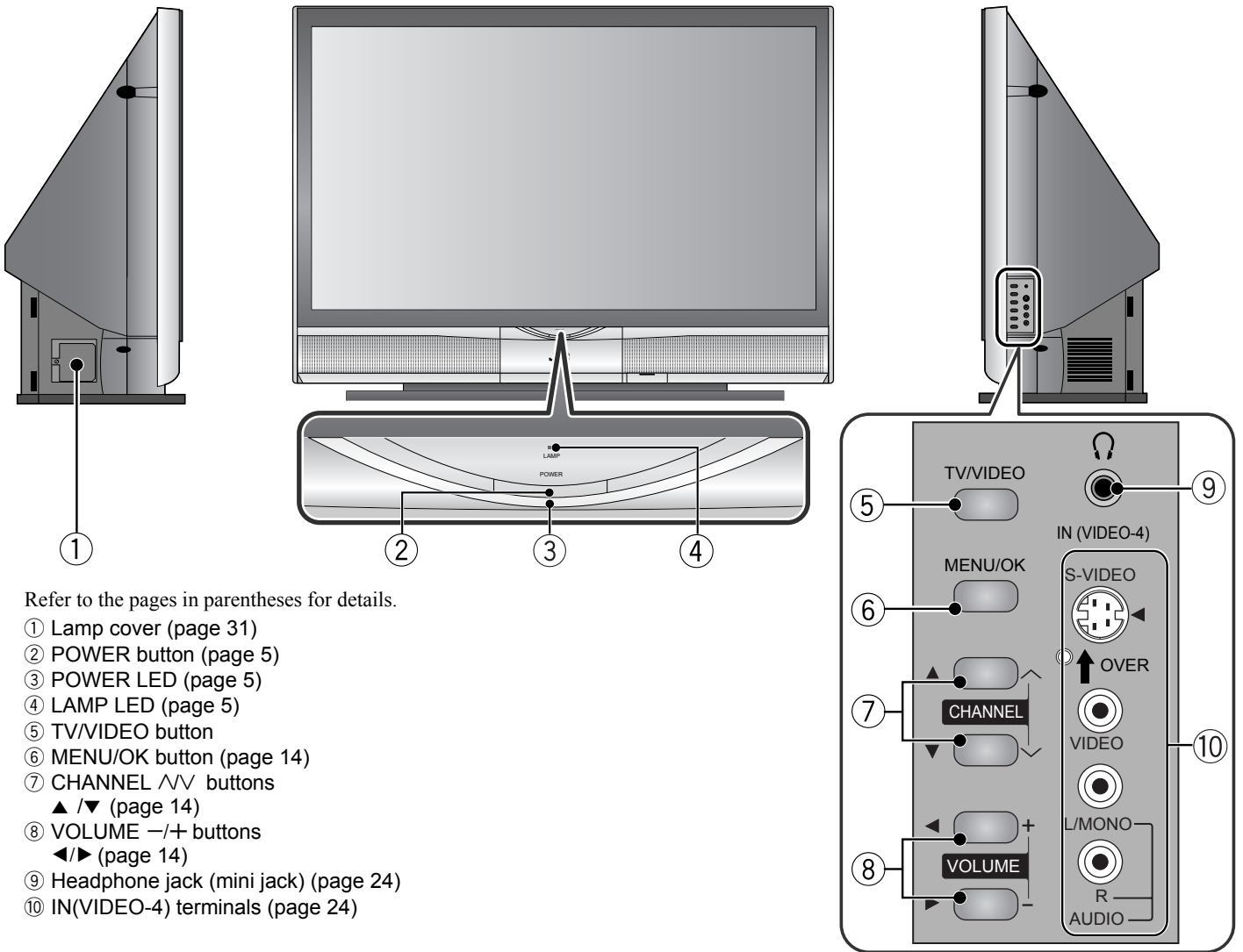

Refer to the pages in parentheses for details.

- ① Lamp cover (page 31)
- ② POWER button (page 5)
- ③ POWER LED (page 5)
- ④ LAMP LED (page 5)
- ⑤ TV/VIDEO button
- ⑥ MENU/OK button (page 14)
- ⑦ CHANNEL \wedge / \vee buttons
 \blacktriangle / \blacktriangledown (page 14)
- ⑧ VOLUME $-/+$ buttons
 \blacktriangleleft / \blacktriangleright (page 14)
- ⑨ Headphone jack (mini jack) (page 24)
- ⑩ IN(VIDEO-4) terminals (page 24)

Turning the TV on from standby mode

Press the POWER button or CHANNEL \wedge / \vee buttons to turn the TV on from standby mode.

When the TV is turned on, the power lamp lights up blue.

Choosing a TV channel

Press the CHANNEL \wedge / \vee buttons to choose a programme number (PR) and a VIDEO terminal

Press the INPUT button to choose a VIDEO terminal.

Adjusting the volume

Press the VOLUME $-/+$ buttons

The volume level indicator appears.

Using the Menu

Use the MENU/OK button

Refer to "Using the TV's menu" (see page 14) for details of using the menu.

Remote control buttons and functions

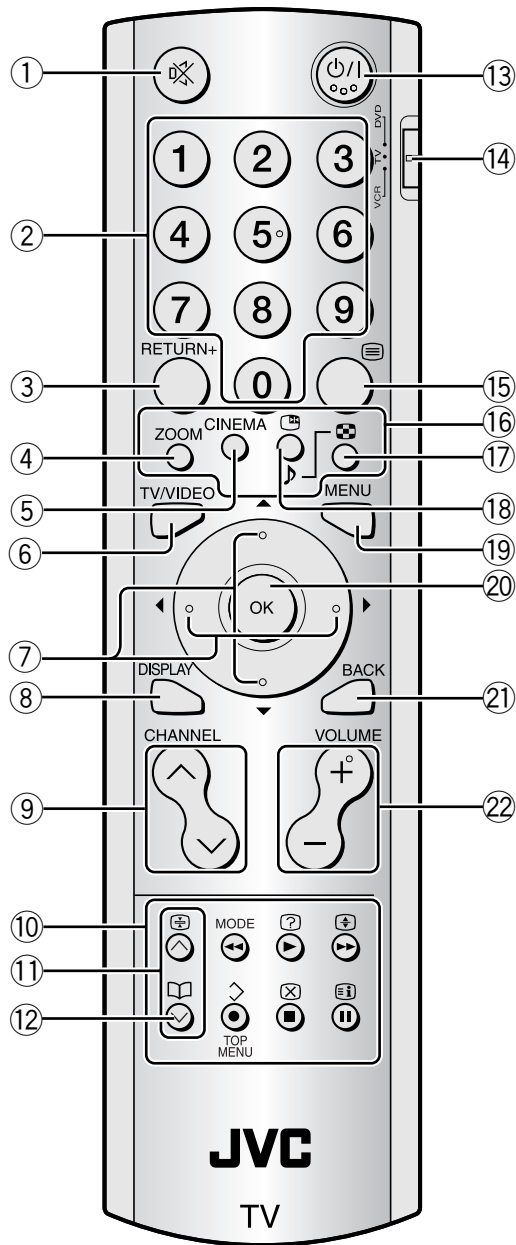

- ① Muting button
- ② Number buttons
- ③ **RETURN+** button
- ④ **ZOOM** button
- ⑤ **CINEMA** button
- ⑥ **TV/VIDEO** button
- ⑦ **◀/▶/▼/▲** buttons
- ⑧ **DISPLAY** button
- ⑨ **CHANNEL** ∇/Δ buttons
- ⑩ VCR/DVD/Teletext control buttons
- ⑪ ∇/Δ buttons
- ⑫ (Favourite) button
- ⑬ \odot/I (Standby/on) button
- ⑭ VCR/TV/DVD switch
- ⑮ (Text) button
- ⑯ Colour buttons
- ⑰ (Multi) button
- ⑱ (Freeze)/ (Select) button
- ⑲ **MENU** button
- ⑳ **OK** button
- ㉑ **BACK** button
- ㉒ **VOLUME** $-/+$ buttons

Turning the TV on or off from standby mode

Press the \odot/I (standby/on) button to turn the TV on or off. When the TV is turned on, the power lamp lights up blue.

- The power can be turned on by pressing the **TV/VIDEO** button, **CHANNEL** ∇/Δ buttons or Number buttons.

To turn the TV on or off, set the VCR/TV/DVD switch on the remote control to the TV position and press the \odot/I button. If the VCR/TV/DVD switch on the remote control is set to the DVD position, the TV will not be turned on or off even if the \odot/I button is pressed.

Choosing a TV channel and watch images from external devices

- Use the number buttons:
Enter the programme number (PR) of the channel using the number buttons.

Example:

- PR 6 → press **6**
- PR 12 → press **1** and **2**

- Use the **CHANNEL** ∇/Δ buttons:
Press the **CHANNEL** ∇/Δ buttons to choose the programme number (PR) you want or a VIDEO terminal.

- Use the **TV/VIDEO** button:
Press the **TV/VIDEO** button to choose a VIDEO terminal.

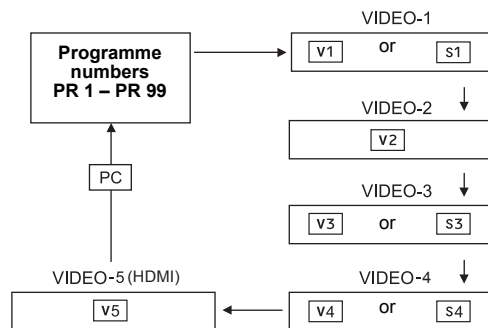

- The leading character is changed from V to S (eg V1 is changed to S1) when VIDEO-1, VIDEO-2, or VIDEO-4 is connected to the S terminal.
- If you do not have a clear picture or no colour appears, follow the operation procedure "COLOUR SYSTEM" on page 17.
- If you cannot hear the normal sound even if the picture of the TV channel appears normally. Follow the description "EDIT/MANUAL" on page 21 to use the MANUAL function to change the SYSTEM setting.
- Since this TV is designed to make full use of the resolution of the original video source, the motion may appear unnatural when the video source is input with progressive-scanning component signals.
- If this happens, change the output setting of the connected device to interlace-scanning component signal output. See the instructions that came with the device for more information.
- The PC sound is the same as the VIDEO-3 sound.

To return to a TV channel:

Press the **TV/VIDEO** button, the **CHANNEL** \vee/\wedge buttons or the number buttons.

To use the programme number PR 0 (AV):

When the TV and VCR are connected only by the aerial cable, choosing the programme number PR 0 (AV) allows you to view images from the VCR. Set the VCR RF channel to the programme number PR 0 (AV) manually. For details, see "EDIT/MANUAL" on page 21.

Adjusting the volume

Press the VOLUME $-/+$ buttons to adjust the volume.

The volume level indicator appears and the volume changes as you press the **VOLUME** $-/+$ buttons.

■ Muting the sound

Press the \times (muting) button to turn off the sound.

Pressing the \times (muting) button again restores the previous volume level.

Display function

You can see the channel number of the programme you are watching or the PR LIST.

From the PR LIST, you can choose a channel or VIDEO terminal.

Press the DISPLAY button to display the information you want to see.

Pressing the **DISPLAY** button changes the display as follows:

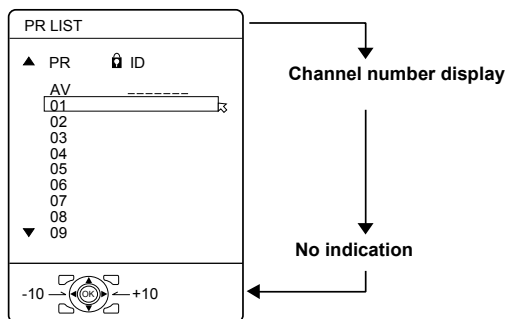
**Channel number display:**

The channel number and channel name (when the channel name is registered) of the programme you are watching or the VIDEO terminal number is displayed.

PR LIST:

The programme number (PR) and VIDEO terminal list is displayed. Pressing the **OK** button after choosing the programme number (PR) or VIDEO terminal with the $\blacktriangleleft/\blacktriangleright/\blacktriangledown/\blacktriangleup$ buttons will display the chosen programme or VIDEO terminal.

- For programme numbers (PR) for which the CHANNEL GUARD function is set, the $\hat{\text{A}}$ (CHANNEL GUARD) mark is displayed. For details see "CHANNEL GUARD" on page 19.
- The VIDEO terminals are registered after the programme number PR 99.
- For programme numbers (PR) which are registered as a favourite channel, the 📖 (favourite) mark is displayed. For details see "Favourite channel function" on page 12.

ZOOM function

You can change the screen size according to the picture aspect ratio. Choose the optimum one from the following ZOOM modes.

- The ZOOM mode is fixed at FULL when you are using the TV as a PC screen or watching a 1080i or 720p picture signal.

AUTO:

When a WSS (Wide Screen Signalling) signal, which shows the aspect ratio of the picture, is included in the broadcast signal or the signal from an external device, the TV automatically changes the ZOOM mode to 16:9 ZOOM mode or FULL mode according to the WSS signal.

If a WSS signal is not included, the picture is displayed according to the ZOOM mode set with the 4:3 AUTO ASPECT function.

- For details of the 4:3 AUTO ASPECT function, see "4:3 AUTO ASPECT" on page 17.
- When the AUTO (WSS) mode does not function correctly due to poor WSS signal quality or when you want to change the ZOOM mode, press the **ZOOM** button and change to another ZOOM mode.

REGULAR:

Use to view a normal picture (4:3 aspect ratio) as this is its original shape.

**PANORAMIC:**

This stretches the left and right sides of a normal picture (4:3 aspect ratio) to fill the screen, without making the picture appear unnatural.

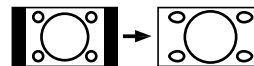

- The top and bottom of the picture are slightly cut off.

14:9 ZOOM:

This zooms up the wide picture (14:9 aspect ratio) to the upper and lower limits of the screen.

**16:9 ZOOM:**

This zooms up the wide picture (16:9 aspect ratio) to the full screen.

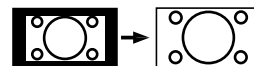
**16:9 ZOOM SUBTITLE:**

This zooms up the wide picture (16:9 aspect ratio) with subtitles to the full screen.

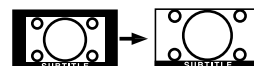
**FULL:**

This uniformly stretches the left and right sides of a normal picture (4:3 aspect ratio) to fill the wide TV screen.

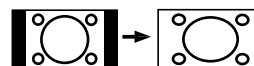

- For 16:9 aspect ratio pictures that have been squeezed into a normal picture (4:3 aspect ratio), use the FULL mode to restore the picture to its original shape.

■ Choose the ZOOM mode

1 Press the **ZOOM** button to display the **ZOOM** menu

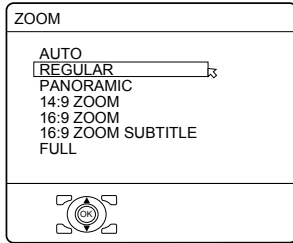

2 Press the **▼/▲** buttons to choose a **ZOOM** mode. Then press the **OK** button

The picture expands and the chosen **ZOOM** mode is displayed in about 5 seconds.

■ Adjusting the visible area of the picture

If subtitles or the top (or bottom) of the picture are cut off, you can adjust the visible area of the picture manually.

1 Press the **ZOOM** button

The **ZOOM** menu appears.

2 Press the **OK** button to display the **ZOOM** mode indicator

The indicator appears.

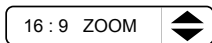

3 While it is displayed, press the **▼/▲** buttons to change the position of the picture

- You cannot adjust the visible area in **REGULAR** or **FULL** mode.

The visible area adjustment is saved even after the TV channel is changed.

However, it is cancelled if the following operations are performed.

- The power is turned off/on
- The **ZOOM** mode is changed
- The **Multi** button, **Freeze** button, or **Text** button is pressed
- The TV is switched between TV mode and VIDEO mode

CINEMA SURROUND function

You can enjoy sounds with a wider ambience.

- This function does not work for the sound from headphones.

Press the **CINEMA** button to select one of **CINEMA SURROUND** modes

HIGH/LOW:

When you listen to stereo sound, please select **HIGH** or **LOW** mode. You can enjoy sound similar to the experience at the theatre.

When you combine the functions of **A.H.B.** and **BBE**, you can enjoy more powerful sound.

- When you set the **CINEMA SURROUND** function to **HIGH** mode, there may be slight volume distortion. If that occurs, please switch to **LOW** mode. The effect of **CINEMA SURROUND** functions will be less noticeable, but the volume distortion will be corrected.

MONO:

Select the **MONO** mode, to listen to the mono sound.

You can enjoy the sound for a wider audience similar to stereo sound.

OFF:

The **CINEMA SURROUND** function switches off.

- You can choose the **CINEMA SURROUND** mode with the "SOUND menu" (see page 18).

Using the "Freeze" function

You can view the current programme as a still picture.

1 Set the **VCR/TV/DVD** switch to the **TV** position

When using the "Freeze" function, set the **VCR/TV/DVD** switch to the **TV** position.

2 Press the **Freeze** button

The still picture of the current picture will appear.

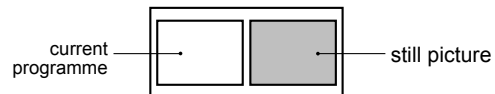

To cancel the "Freeze" function:

Press the **Freeze** button, the **CHANNEL** **▼/▲** buttons or the number buttons.

- The "Freeze" function does not work while a sub-picture is displayed.
- The still picture cannot be output from the TV.
- The "Freeze" function does not work for picture of PC signals.

Using the “Multi-picture” function

1 Set the VCR/TV/DVD switch to the TV position

When using the “Multi-picture” function, set the VCR/TV/DVD switch to the TV position.

2 Press the button

The “Multi-picture” menu appears.

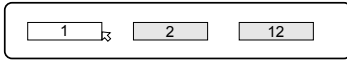

3 Press the /▶ buttons to choose the number of screens and then press the OK button



Choose to return to one screen.



Choose to change to 2-pictures multi.



Choose to change to 12-pictures multi.

2-pictures multi:

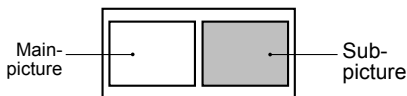



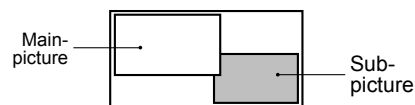

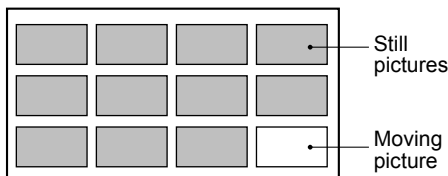

With 1125i and 750p signals, the screen is split into two as shown below.



12-pictures multi:



- When set to 2-pictures multi, you can view a TV picture and a picture from an external device. You cannot view a TV picture on more than one screen at the same time.
- When 12-pictures multi is set, pictures from external devices are not displayed.
- When watching a picture from the HDMI signal, 12-pictures multi can not be displayed.
- When set to 2-pictures multi, the main-picture can be changed by pressing the **CHANNEL** /▶ buttons. The sub-picture screen can be changed by pressing the /▶ buttons.
- When set to 12-pictures multi and there are more than 12 pictures, the next or previous 12 screens can be displayed by pressing the **CHANNEL** /▶ buttons.
- When set to 2-pictures multi, the main-picture sound from the TV speaker can be changed to the sub-picture sound by pressing the  button when the VCR/TV/DVD switch is set to the VCR position. (The speaker mark moves from the main-picture to the sub-picture.)
The sound changes to the main-picture sound if the  button is pressed again.
When the headphones are connected, you can listen to the sound from the side at which the headphones mark is displayed. No sound comes from the TV speaker.

- When set to 2-pictures multi, picture from HDMI can not be displayed on the Sub-picture.
- The pictures from VIDEO-1 (or VIDEO-2) cannot be displayed in the sub-picture when the VIDEO-1 SETTING (or VIDEO-2 SETTING) is set to COMPONENT (see page 23).
- The “Multi-picture” function does not work for a PC signals.
- When set to 12-pictures multi, press the /▶/▼/▶ buttons to choose the screen you want to view and the press the **OK** button to display that picture on the whole screen.
- The BLUE BACK function does not work when the “Multi-picture” function is being used.
- The ZOOM function does not work when the “Multi-picture” function is being used.

To return the “Multi-picture” to one screen:

Press the  button, press the /▶ buttons to choose one screen, and then press the **OK** button.

- Pressing the **TV/VIDEO** button will also return the display to one screen.

RETURN PLUS function and Return function

The **RETURN+** button has two functions; the RETURN PLUS function and the Return function. If a channel has been registered as the “Return Channel”, the RETURN PLUS function operates. If there is no setting for the “Return Channel”, the Return function operates.

■ RETURN PLUS

By registering a channel you frequently view as the “Return Channel”, you can select that channel at any time simply by pressing the **RETURN+** button.

To register a TV channel as the “Return Channel”:

Press and hold **RETURN+** button for more than 3 seconds while the channel you want to register is chosen. “RETURN PLUS PROGRAMMED!” is displayed and the registration is completed.

To cancel a TV channel registered as the “Return Channel”:

While viewing any TV channel, press the **RETURN+** button and hold for more than 3 seconds continuously. “RETURN PLUS CANCELED!” is displayed and the registration is cancelled.

- When you turn off the TV, the registration for the “Return Channel” is cancelled.
- If you want to view the “Return Channel” and another TV channel alternately, first choose a channel other than the “Return Channel”. And then press the **RETURN+** button to change the channel to the “Return Channel.” In this way, you can view two channels alternately by pressing the **RETURN+** button.

■ Return function

The TV temporarily memorises the TV channel that was chosen right before the current TV channel as the “Last Channel”. By pressing the **RETURN+** button, you can alternately view the current TV channel and the “Last Channel”.

If you want to view two channels alternately by using the Return function, first choose one TV channel and then choose the other TV channel with the number buttons. If you choose the TV channel without using the number buttons, there are cases where a channel other than the one you first chose is registered as the “Last Channel”.

Favourite channel function

You can register your favourite TV channels (PR 1 – PR 99) in the number buttons 1 to 4.

After registering, the channel can be called by pressing the  (favourite) button and a number button 1 to 4.

■ Favourite channel registration

1 In the normal screen, choose a TV channel (PR 1 – PR 99) that you want to register

2 Press and hold the (favourite) button for three seconds or more

Then “SET 1-4?” appears on the screen.

3 Press one of the number buttons 1 to 4

The current channel is registered in the pressed number button. After “PROGRAMMED!” appears on the screen, the favourite channel icon appears at the top-right of the screen.

- If the channel you are trying to register is already registered in one of the other number buttons 1 to 4, “NOT AVAILABLE” appears on the screen.
- Channels locked with the CHANNEL GUARD function cannot be registered.
- If AUTO PROGRAM is performed, the registered favourite channels are reset.

- When you want to delete a favourite channel, delete the set channel and set contents with FAVOURITE SETTING (see page 20) in the FEATURES menu.

■ Calling the favourite channel

1 In the normal screen, press the (favourite) button

Then “FAVOURITE1-4?” appears.

2 Press one of the number buttons 1 to 4

The called favourite channel appears on the screen.

- If a number button in which no channel is registered is pressed, “NO MEMORY” appears on the screen.

■ Setting the picture effect

When a favourite channel has been chosen with the  (favourite) button and number buttons 1 to 4, picture effect settings can be memorised for each favourite channel by setting the picture effects in the PICTURE menu (see page 15).

The following items in the PICTURE menu (see pages 15 to 17) are memorised.

PICTURE MODE
CONTRAST
BRIGHT
SHARP
COLOUR
TINT
WHITE BALANCE
DIGITAL VNR
COLOUR SYSTEM





The last setting made for each item is memorised.

Operating a JVC brand DVD player

These buttons will operate a JVC brand DVD player. Pressing a button that looks the same as the device’s original remote control button has the same function as the original remote control.

1 Set the VCR/TV/DVD switch to the DVD position

When you are operating the DVD player, set the switch to the DVD position.

- You can turn the DVD player on or off with the  (standby) button.
- You can also press the **MENU** or **TOP MENU** button and display the DVD disc menu screen, and then operate by pressing the     buttons and **OK** button.

2 Press the DVD control button to control your DVD player

- If your DVD player is not made by JVC, these buttons will not work.
- Even if your device is made by JVC, some of these buttons may not work, depending on the device you are using.

You cannot turn the TV on or off when the VCR/TV/DVD switch is set to the DVD position.

When you turn the TV on or off, set the VCR/TV/DVD switch to the TV position.

Operating a JVC brand VCR

These buttons will operate a JVC brand VCR. Pressing a button that looks the same as the device’s original remote control button has the same function as the original remote control.

1 Set the VCR/TV/DVD switch to the VCR position

When you are operating the VCR, set the switch to the VCR position.

- You can turn the VCR on or off with the  (standby) button.

2 Press the VCR control button to control your VCR

- If your VCR is not made by JVC, these buttons will not work.
- Even if your device is made by JVC, some of these buttons may not work, depending on the device you are using.

You cannot turn the TV on or off when the VCR/TV/DVD switch is set to the VCR position.

When you turn the TV on or off, set the VCR/TV/DVD switch to the TV position.

Teletext function

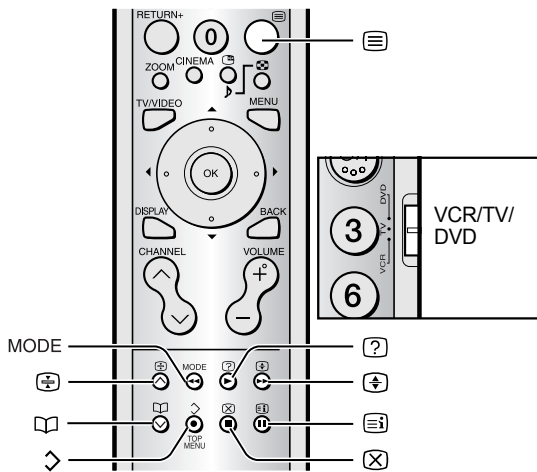

Basic operation

- 1 Choose a TV channel with a teletext broadcast
- 2 Set the VCR/TV/DVD switch to the TV position



- 3 Press (Text) button to display the teletext

Pressing (Text) button changes the mode as follows:

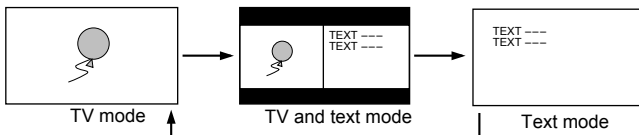

- 4 Choose a teletext page by pressing the **CHANNEL** buttons, number buttons or colour buttons

To return to the TV mode:

Press the **TV/VIDEO** button, **BACK** button, or (Text) button.

- If you have trouble receiving teletext broadcasts, consult your local dealer or the teletext station.
- The ZOOM function will not work in the TV and text mode or Text mode.
- You cannot operate menus when viewing a teletext programme.
- If characters on a teletext programme do not appear properly, change the TELETEXT LANGUAGE setting. For details, see "TELETEXT LANGUAGE" on page 23.

Using the List Mode

You can store the numbers of your favourite teletext pages in memory and call them up quickly using the colour buttons.

■ To store the page numbers:

- 1 Press **MODE** button to go into the List mode
The page numbers you have stored are displayed at the bottom of the screen.
- 2 Press a colour button to choose a position. Then press the number buttons to enter the page number
- 3 Press and hold down the (Store) button
The four page numbers blink white to show that they are stored in memory.

■ To call up a stored page:

- 1 Press the **MODE** button to enter the List mode
- 2 Press a colour button having a stored page

To exit the List mode:

Press the **MODE** button again.

Hold

You can hold a teletext page on the screen for as long as you want, even while several other teletext pages are being received.

Press the (Hold) button

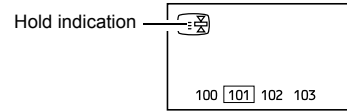

To cancel the Hold function:

Press (Hold) button again.

Sub-page

Some teletext pages include sub-pages that are automatically displayed.

- 1 Choose a teletext page that includes sub-pages
Sub-page numbers that can be viewed are automatically displayed at the top of the screen.
- 2 Press the buttons to choose a sub-page number

Reveal

Some teletext pages include hidden text (such as answers to a quiz). You can display the hidden text.

Each time you press the (Reveal) button, text is hidden or revealed

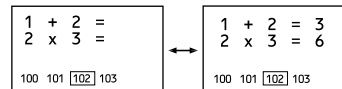

Size

You can double the height of the teletext display.

Press the (Size) button



Index

You can return to the index page instantly.

Press the (Index) button

Returns to page 100 or a previously specified page.

Cancel

You can search for a teletext page while watching TV.

- 1 Press the number button to enter a page number, or press a colour button
The TV searches for a teletext page.
- 2 Press (Cancel) button
The TV programme appears. When the TV finds the teletext page, its page number appears in the upper left of the screen.
- 3 Press (Cancel) button to return to a teletext page when the page number is on the screen
 - The TV mode cannot be resumed by pressing the (Cancel) button. To return to the TV mode press the **TV/VIDEO** or **BACK** button.

Using the TV's menu

This TV has a number of functions you can operate using menus. To use all your TV's functions, you need to understand the basic menu operating techniques fully.

Basic operation

1 Press the **MENU** button to display the menu bar



2 Press the **◀/▶** buttons to choose the menu you want to use and then press the **OK** button

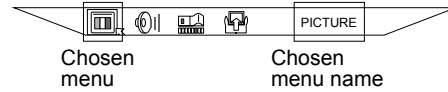

3 Press the **▼/▲** buttons to choose the item to be set, press the **◀/▶** buttons to set the item, and then press the **OK** button

If there are sub-menus, use the **◀/▶/▼/▲** buttons to operate them.

- Press the **BACK** button to return to the previous menu.
- Press the **TV/VIDEO** or **MENU** button to exit from the menu.
- Some menu items may not be operated or set depending on the TV status, input signal or other menu item settings. Menu items that cannot be operated or set are displayed in grey in the menu and cannot be chosen.

Types of menu



PICTURE menu

Choose to set the screen settings.



SOUND menu

Choose to set the sound settings.



FEATURES menu

Choose to set the sleep timer and child lock settings.



SET UP menu

Choose to edit the channels or set the display language settings.

- The menu will disappear after about one minute if no operation is performed.

The menu guide area can be made to appear and disappear for some menus.

While the menu is displayed, press the **DISPLAY** button to change between the guide area being displayed and not displayed.

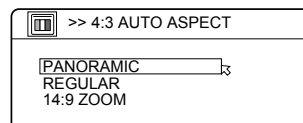
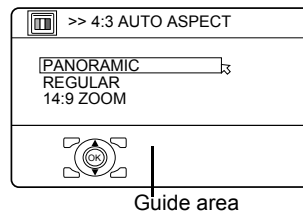

- The guide area for some menus will still be displayed even if the **DISPLAY** button is pressed. This is not a fault.

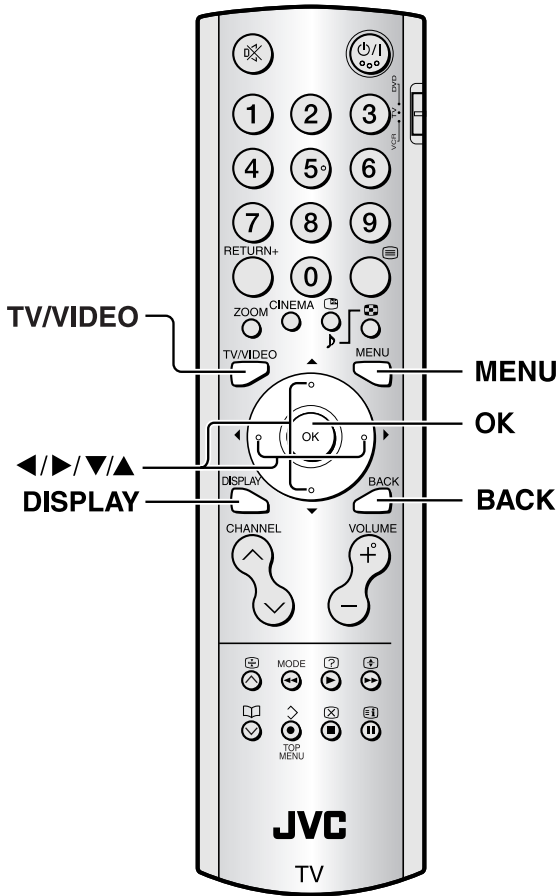

Operation with the buttons on the TV

You can also operate the menus using the buttons on the TV.

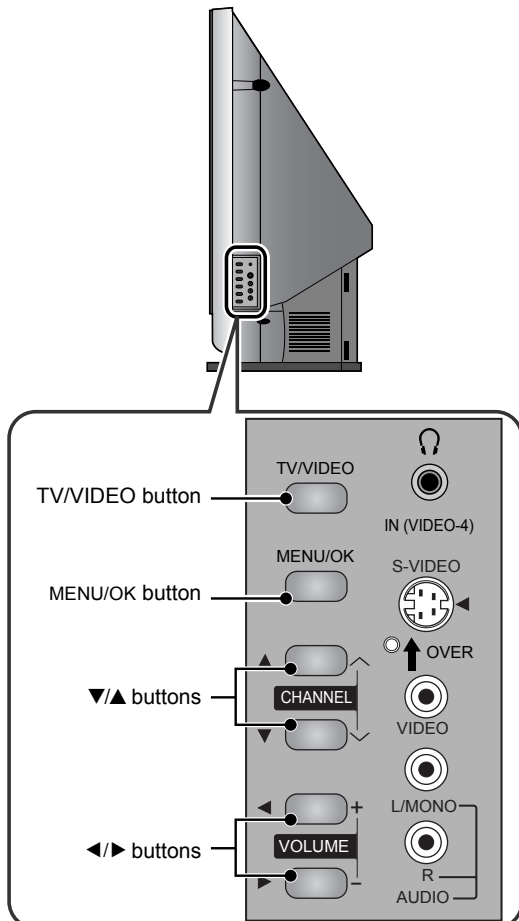

The menu guide area can be made to appear and disappear for some menus.

While the menu is displayed, press the **DISPLAY** button to change between the guide area being displayed and not displayed.

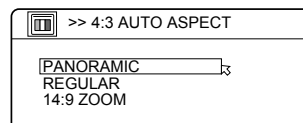
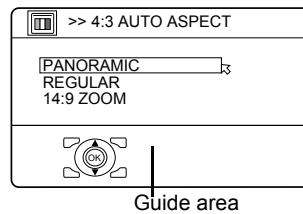

- The guide area for some menus will still be displayed even if the **DISPLAY** button is pressed. This is not a fault.

PICTURE menu

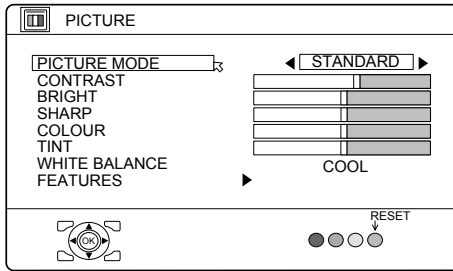

- While the PICTURE menu is displayed, pressing the blue button will set the CONTRAST, BRIGHT, SHARP, COLOUR, TINT settings to their default settings.
- When watching the picture from VIDEO-1 to VIDEO-5 (HDMI) or the PC, picture effect settings can be memorised for each external input by setting the picture effects in the PICTURE menu. The following items in the PICTURE menu are memorised.

PICTURE MODE
CONTRAST
BRIGHT
SHARP
COLOUR
TINT
WHITE BALANCE
DIGITAL VNR
COLOUR SYSTEM

The last setting made for each item is memorised.

PICTURE MODE

You can choose one of three PICTURE MODEs to adjust the picture settings automatically.

BRIGHT:

Heightens contrast and sharpness.

STANDARD:

Standardises picture adjustment.

SOFT:

Softens contrast and sharpness.

CONTRAST

You can adjust the picture contrast.

◀ : lower

▶ : higher

BRIGHT

You can adjust the picture brightness.

◀ : darker

▶ : brighter

SHARP

You can adjust the picture sharpness.

◀ : softer

▶ : sharper

COLOUR

You can adjust the picture colour.

◀ : lighter

▶ : deeper

TINT

You can adjust the picture tint.

◀ : reddish

▶ : greenish

- You can change the TINT setting (picture hue) when the colour system is NTSC 3.58, or NTSC 4.43.

WHITE BALANCE

You can select one of three WHITE BALANCE modes (three tones of white) to adjust the white balance of the picture. Since white is the colour which is used as a reference for all the other colours, changing the WHITE BALANCE mode affects the appearance of all the other colours on the screen.

COOL:

A bluish white. Using this mode when watching bright pictures allows you to enjoy a more vivid and bright picture.

MID:

The normal white colour.

WARM:

A reddish white. Using this mode when watching films allows you to enjoy colours that are characteristic of films.

FEATURES

Choose FEATURES and press the **OK** or **▶** button to display the sub-menu.

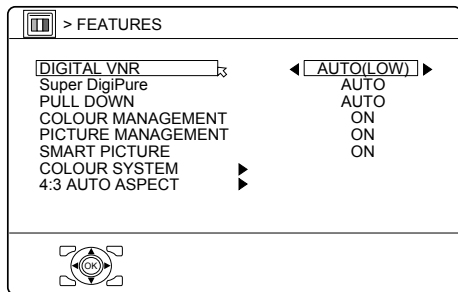

■ DIGITAL VNR

The DIGITAL VNR function cuts down the amount of ‘noise’ (‘snow’ or interference) in the original picture. You can choose from the three DIGITAL VNR function settings of AUTO, MIN and MAX.

AUTO(LOW)/AUTO(HIGH):

The TV will automatically adjust the level of the DIGITAL VNR effect to match the amount of noise in the picture, giving you the best possible picture.

- If you set the DIGITAL VNR effect too high it can make the picture less sharp. It is recommended you use the AUTO(LOW) setting if you can. If you set the DIGITAL VNR function to AUTO(LOW) but still notice some noise, change the setting from AUTO(LOW) to AUTO(HIGH).

MIN:

The level of the DIGITAL VNR effect is set to the minimum. If you set the DIGITAL VNR function to AUTO(LOW) but feel that the sharpness of the original picture has not been reproduced fully, change the setting from AUTO(LOW) to MIN.

- The MIN setting is not suitable for low-quality pictures which contain a lot of noise.

MAX:

The level of the DIGITAL VNR effect is set to the maximum. If you set the DIGITAL VNR function to AUTO(HIGH) but still notice some noise, change the setting from AUTO(HIGH) to MAX.

- The MAX setting is not suitable for high-quality pictures which contain very little noise.

■ Super DigiPure

The Super DigiPure function uses the latest in digital technology to give you a natural-looking picture. The Super DigiPure function includes the following two functions.

DigiPure function:

This function helps to create a natural-looking picture by eliminating unnecessary edges from high-contrast and crisp images. For images with low-contrast, edges are added to produce a sharper, more detailed picture.

You can choose from the three DigiPure function settings of AUTO, MIN and MAX.

- If you set the DigiPure effect too high on a low-quality picture that contains a lot of noise, this may actually make the noise worse. We recommend you use the AUTO setting if you can.

Picture motion compensation function:

This function displays fast-moving pictures (for example, the players or ball in a football game) more smoothly and naturally on the screen.

- The effect level of the picture motion compensation function cannot be changed. The effect level is the same no matter which of the AUTO, MIN or MAX settings is used.

AUTO:

The TV will automatically adjust the level of the DigiPure effect to match the amount of noise in the picture, giving the best possible picture.

MIN:

The level of DigiPure effect is set to the minimum. When you set the Super DigiPure function to AUTO and notice some noise, change the setting from AUTO to MIN.

- The MIN setting is not suitable for high-quality pictures which contain very little noise.

MAX:

The level of DigiPure effect is set to the maximum. If you set the Super DigiPure function to AUTO but feel that the original picture quality has not been reproduced fully, change the setting from AUTO to MAX.

- The MAX setting is not suitable for low-quality pictures which contain a lot of noise.

OFF:

The Super DigiPure function is turned off.

■ PULL DOWN

The PULL DOWN function displays a cinema film picture more smoothly and naturally on the screen.

AUTO:

The television automatically recognises the type of signal and turns the function on and off.

ON:

This function is turned on.

OFF:

This function is turned off.

■ COLOUR MANAGEMENT

This TV supports the COLOUR MANAGEMENT function to ensure dull colours are compensated to produce natural hues. The COLOUR MANAGEMENT function is on by default.

ON:

COLOUR MANAGEMENT function is turned on.

OFF:

COLOUR MANAGEMENT function is turned off.

-
- Set this function to ON under normal conditions.
-

■ PICTURE MANAGEMENT

The PICTURE MANAGEMENT function makes it easier to see the dark areas when a picture has many dark areas, and makes it easier to see the bright areas when a picture has many bright areas. Normally use with this function on.

ON:

PICTURE MANAGEMENT function is turned on.

OFF:

PICTURE MANAGEMENT function is turned off.

■ SMART PICTURE

The SMART PICTURE function detects the APL (Average Picture Level) and adjusts the contrast suitable for what you are watching. Normally use with this function on.

ON:

SMART PICTURE function is turned on.

OFF:

SMART PICTURE function is turned off.

- When you have selected “BRIGHT” in the “PICTURE MODE,” SMART PICTURE function is fixed to “OFF.”

■ COLOUR SYSTEM

The colour system is chosen automatically. However, if the picture is not clear or no colour appears, choose the colour system manually.

1 Choose COLOUR SYSTEM. Then press the OK or ► button

The sub-menu of the COLOUR SYSTEM function appears.

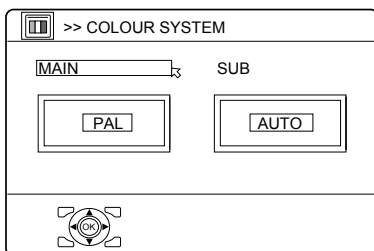

2 Press the ◀/▶ buttons to choose MAIN or SUB

MAIN:

You can change the colour system of the main-picture.

SUB:

You can change the colour system of the sub-picture.

- Choose MAIN when a sub-picture is not displayed.

3 Press the ▼/▲ buttons to choose the appropriate colour system. Then press the OK button

PAL:

PAL system

SECAM:

SECAM system

NTSC 3.58:

NTSC 3.58 MHz system

NTSC 4.43:

NTSC 4.43 MHz system

AUTO:

This function detects a colour system from the input signal.

- The AUTO function may not function properly if you have poor signal quality. If the picture is abnormal in the AUTO function, choose another colour system manually.

For colour system in your country or region, refer to the table below:

Area	Country or Region	System
Asia, Middle East	Bahrain, Kuwait, Oman, Qatar, United Arab Emirates, Yemen, etc.	PAL
	Indonesia, Malaysia, Singapore, Thailand, India, etc.	PAL
	China, Vietnam, etc.	PAL
	Hong Kong, etc.	PAL
	Islamic Republic of Iran, Lebanon, Saudi Arabia, etc.	SECAM
	Philippines, Taiwan, Myanmar, etc.	NTSC
Europe	Russia, etc.	SECAM
	Czech Republic, Poland, etc.	PAL
	Germany, Holland, Belgium, etc.	PAL
	UK, etc.	PAL
Oceania	Australia, New Zealand, etc.	PAL
Africa	Republic of South Africa, etc.	PAL
	Nigeria, etc.	PAL
	Egypt, Morocco, etc.	SECAM

■ 4:3 AUTO ASPECT

You can choose one of three ZOOM modes, REGULAR, PANORAMIC or 14:9 ZOOM, as the ZOOM mode for the normal picture (4:3 aspect ratio).

1 Choose 4:3 AUTO ASPECT then press the OK button

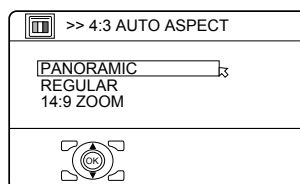

2 Press the ▼/▲ buttons to choose a ZOOM mode

SOUND menu

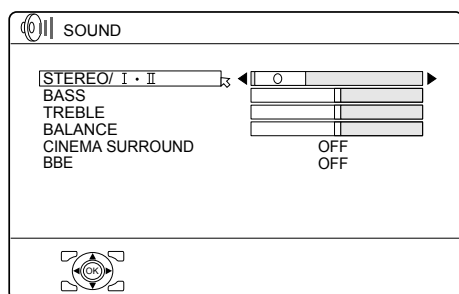

- When the headphones are connected, only “STEREO / I • II” can be used.

STEREO / I • II

When you are viewing a bilingual broadcast programme, you can choose the sound from Bilingual I (Sub I) or Bilingual II (Sub II).

⊕ : Stereo sound

○ : mono sound

I : Bilingual I (sub I)

II : Bilingual II (sub II)

MONO:

Cancels the Multi Sound function and the sound becomes monaural.

- If stereo sound or bilingual sound is hard to hear, please select MONO so that you can hear the broadcast more clearly.
- The sound mode you can choose differs depending on the TV programme.
- This function does not work in the VIDEO modes.

BASS

You can adjust the low tone of the sound.

◀ : weaker

▶ : strong

TREBLE

You can adjust the high tone of the sound.

◀ : weaker

▶ : strong

BALANCE

You can adjust the volume balance between the left and right speaker.

◀ : turn the left speaker's volume level up.

▶ : turn the right speaker's volume level up.

CINEMA SURROUND

You can enjoy Surround sound with a “live” effect by using the CINEMA SURROUND function.

- You can choose a CINEMA SURROUND mode from HIGH, LOW, MONO and OFF modes. For details, see “CINEMA SURROUND function” on page 10.
- You can also operate the CINEMA SURROUND function with the **CINEMA** button. For details, see “CINEMA SURROUND function” on page 10.

BBE

BBE function restores clarity and presence for better speech intelligibility and musical realism.

ON:

This function is turned on.

OFF:

This function is turned off.

- Manufactured under license from BBE Sound, Inc. Licensed by BBE Sound, Inc. under USP4638258, 5510752 and 5736897. BBE and BBE symbol are registered trademarks of BBE Sound, Inc.

FEATURES menu

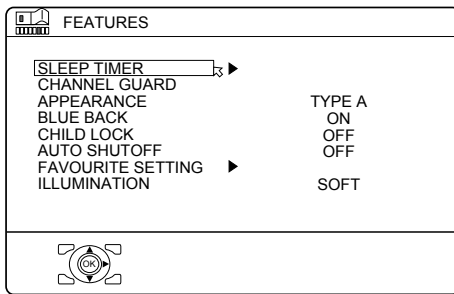

SLEEP TIMER

You can set the TV to automatically turn off after a set period of time.

- 1 Choose **SLEEP TIMER**. Then press the **OK** or **▶** button
A Sub-menu of the SLEEP TIMER function appears.

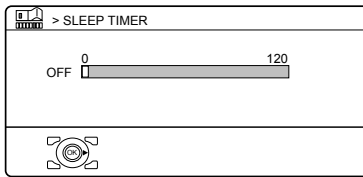

- 2 Press the **◀/▶** buttons to set the period of time.
Then press the **OK** button

You can set the period of time for up to 120 minutes (2 hours) in 10 minute steps.

- One minute before the SLEEP TIMER function turns off the TV, "GOOD NIGHT!" appears.
- The SLEEP TIMER function cannot be used to turn off the TV's main power.
- When the SLEEP TIMER function is on, you can display the sub-menu of the SLEEP TIMER function again to confirm or change the remaining period of time of the SLEEP TIMER function. Press the **OK** button to leave the menu after confirming or changing the remaining time.

To cancel the SLEEP TIMER function:

Press the **◀** button to set the period of time to "OFF".

CHANNEL GUARD

When there is a TV channel you do not want your children to watch, you can use the CHANNEL GUARD function to lock out the TV channel. Even when a child chooses a programme number (PR) for a locked TV channel the screen will change to blue and display **Ⓜ** (CHANNEL GUARD) so the TV channel cannot be viewed. Unless you enter a pre-set ID number by a special operation, the lock cannot be released and the child cannot view the TV channel.

- **To set the CHANNEL GUARD function**

- 1 Choose **CHANNEL GUARD**, then press the **0** button
"SET ID NO." (ID number setting screen) appears.

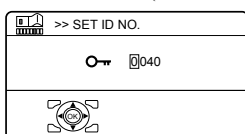

- 2 Set the ID number to your liking

- 1 Press the **▼/▲** buttons to choose a number.
- 2 Press the **◀/▶** buttons to move the cursor.

- 3 Press the **OK** button

The Sub-menu of CHANNEL GUARD appears.

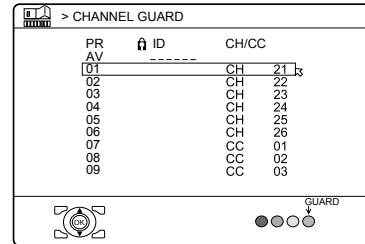

- 4 Press the **▼/▲** buttons to choose a TV channel

Every time you press the **▼/▲** buttons, the Programme number (PR) changes, and the picture of the TV channel registered in the Programme number (PR) is displayed on the screen.

- 5 Press the blue button and set the **CHANNEL GUARD** function.
Then press the **OK** button

Ⓜ (CHANNEL GUARD) appears and the TV channel is locked.

To reset the CHANNEL GUARD function:

Press the blue button again.

Ⓜ (CHANNEL GUARD) disappears.

To disable easy resetting of the CHANNEL GUARD function, the menu disappears if you choose the CHANNEL GUARD function and press the **OK** button.

- **To view a locked TV channel**

- 1 Choose a programme number (PR) of a locked TV channel with the number buttons or **PR LIST**

The screen changes to blue and the **Ⓜ** (CHANNEL GUARD) appears. You cannot view the TV channel.

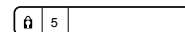

- 2 Press the **DISPLAY** button to display "ID NO." (ID No. input screen)

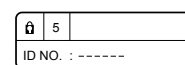

- 3 Press the number buttons to enter the ID number

The lock is temporarily released so you can view the TV channel.

If you have forgotten the ID number:

Perform step 1 of "To set the CHANNEL GUARD function".

After confirming the ID number, press the **TV/VIDEO** button to exit the menu.

- Even if you reset the lock temporarily, it does not mean that the CHANNEL GUARD function set for the TV channel is cancelled. The next time anyone tries to view the TV channel, it will be locked again.
- When you want to cancel the CHANNEL GUARD function, you must perform the operation "To set the CHANNEL GUARD function" again.
- To stop it from being easy to choose the programme number (PR) of a locked TV channel, the programme number (PR) has been set so that it cannot be chosen with the **▼/▲** buttons or the buttons of the TV.
- "ID NO." (ID No. input screen) does not appear without pressing **DISPLAY** button so as to make the lock resetting difficult.

APPEARANCE

Press the ◀/▶ button and choose the format in which the channel number is displayed from the four types: TYPE A, TYPE B, TYPE C, and TYPE D.

- The TV is set to TYPE D when shipped from factory. TYPE D sets all screens to semitransparent. The menu screens are not semitransparent when set to a type other than TYPE D.

BLUE BACK

You can set the TV to automatically change to a blue screen and mute the sound if the signal is weak or absent, or when there is no input from an external device.

ON:
This function is turned on.

OFF:
This function is turned off.

CHILD LOCK

You can disable the front control buttons of the TV. When this function is set to ON, the TV can be operated only by using the remote control.

Use this function to prevent children from operating the TV at their own discretion (without parent consent).

ON:
This function is turned on.

OFF:
This function is turned off.
When you disconnect the AC plug, the CHILD LOCK will be cancelled.

AUTO SHUTOFF

You can set the power to turn off if no signal is received and no operation is performed for about 15 minutes or longer after the end of a broadcast.

ON:
This function is turned on.

- OFF:**
This function is turned off.
- The AUTO SHUTOFF function does not turn off the TV's main power.
 - The AUTO SHUTOFF function does not work for the VIDEO mode or a picture from a PC signal.

FAVOURITE SETTING

Choose when deleting the favourite channels registered in the buttons 1 to 4.

1 Choose FAVOURITE SETTING, then press the OK or ► button

The FAVOURITE SETTING menu appears.

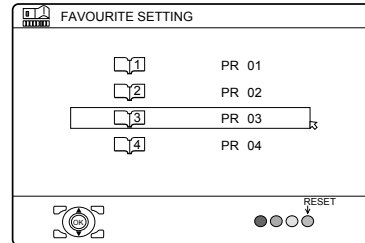

2 Press the ▼/▲ buttons and choose the favourite channel that you want to delete

3 Press the blue button

The chosen favourite channel and set contents are deleted.

- For details of the favourite channels, see “Favourite channel function” on page 12.

ILLUMINATION

You can choose one of two ILLUMINATION modes to adjust the illumination settings.

SOFT:
Softens illumination lights.

BRIGHT:
Heightens illumination lights.

- ILLUMINATION mode is temporarily set to “BRIGHT” for approximately a minute after turning on the power.

SET UP menu

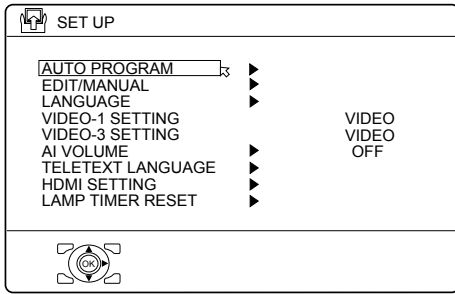

AUTO PROGRAM

You can register the TV channel automatically. This function is same as step 5 and 6 of the “Initial settings (Setup tour)” on page 6.

1 Choose AUTO PROGRAM, then press the OK or ► button

The AUTO PROGRAM function starts. The TV channels you receive are automatically stored in the programme numbers list.

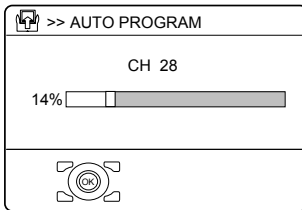

- To stop the AUTO PROGRAM function, press the **OK** button.

2 After the TV channels have been stored in the programme number list, the EDIT menu appears

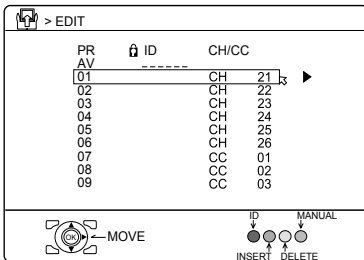

- You can proceed to edit the programme numbers list using the EDIT/MANUAL function. For details, see “EDIT/MANUAL” on the right column.
- If a TV channel you want to view is not stored in the programme numbers list, you can register it using the MANUAL function. For details, see “EDIT/MANUAL” on the right column.
- The AUTO PROGRAM function does not store a TV channel to the programme number PR 0 (AV).
- If you do not need to use the EDIT/MANUAL function, press the **OK** button to exit the EDIT menu.
- Starting the AUTO PROGRAM deletes the registered favourite channel.

EDIT/MANUAL

The EDIT/MANUAL functions are divided into two types:

- editing the current programme numbers (PR) (EDIT functions); and
- manually storing a TV channel you want to view on a particular programme number (PR) (MANUAL function).

Here are the details about these functions:

MOVE:

This function changes the programme number (PR) of a TV channel.

ID:

This function registers a channel name (ID) to a TV channel.

INSERT:

This function adds a new TV channel in the current programme numbers (PR) list by using the CH/CC number.

- You cannot use the INSERT function if you do not know the channel number of a TV channel. In this case, use the MANUAL function to register a TV channel.

DELETE:

This function deletes a TV channel you do not want to list.

MANUAL:

This function manually stores a new TV channel in a programme number (PR).

Caution

- Using the MOVE, DELETE or INSERT functions rewrites the current programme numbers (PR) list. Therefore, the programme numbers (PR) of some of the TV channels will change.
- Using the MANUAL function for a TV channel for which the CHANNEL GUARD function has been set cancels the CHANNEL GUARD function for that channel.
- When a TV channel has already been registered in PR 1 – PR 99, using the INSERT function deletes the last registered TV channel.

Basic operation

1 Choose EDIT/MANUAL, then press the OK or ► button

The EDIT menu appears.

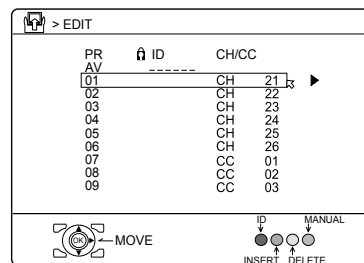

2 Follow the description for the function you want to use

3 Press the OK button to complete the settings

- For programme number PR 0, “AV” appears in the programme numbers (PR) list.
- A VIDEO terminal number does not appear in the programme numbers (PR) list.
- The CH/CC number is a number unique to the TV and corresponds to the channel number of a TV channel. For the relationship between a channel number and a CH/CC number, see “Troubleshooting” on page 26.

MOVE

- 1 Press the **▼/▲** buttons to choose a TV channel
- 2 Press the **▶** button to start the MOVE function

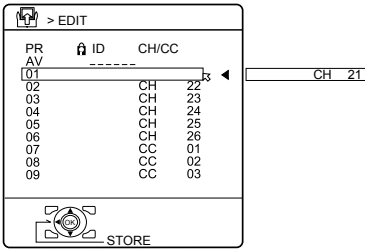

- 3 Press the **▼/▲** buttons to choose a new programme number (PR)

To cancel the MOVE function:
Press the **BACK** button.

- 4 Press the **◀** button to change the programme number (PR) of a TV channel to a new programme number (PR)

DELETE

- 1 Press the **▼/▲** buttons to choose a TV channel
- 2 Press the yellow button to delete the TV channel
The TV channel is deleted from the programme numbers (PR) list.

ID

- 1 Press the **▼/▲** buttons to choose a TV channel
- 2 Press the red button to start the ID function
- 3 Enter a channel name (ID). Press the **▼/▲** buttons to choose a character. Press the **◀/▶** buttons to move the cursor

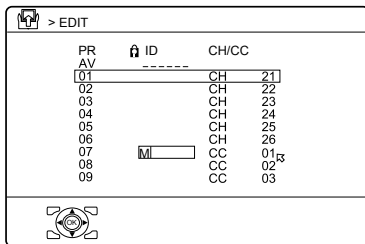

To cancel the ID function:
Press the **BACK** button.

- 4 Press the **OK** button to give a channel name to a TV channel

Before performing INSERT operation

- A CH/CC number unique to this TV and corresponding to the Channel number of a TV channel is required. Find the corresponding CH/CC number from a table “Troubleshooting” on page 26 based on the Channel number of the TV channel.

INSERT

- 1 Press the **▼/▲** buttons to choose a programme number (PR) for which you will register a new TV channel
- 2 Press the green button to start the INSERT function

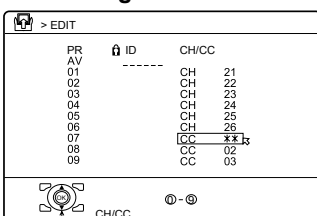

- 3 Press the **▼/▲** buttons to choose “CC” or “CH” according to the CH/CC number of the TV channel

To cancel the INSERT function:
Press the **BACK** button.

- 4 Press the number buttons to enter the remaining CH/CC number

The TV shifts to registration mode. When the registration is completed, the picture of the TV channel appears on the screen.

- The CH/CC number is a number given to each broadcast frequency that carries a TV channel. If the TV cannot detect the TV channel corresponding to the broadcast frequency indicated by the CH/CC number, a “no-signal” picture appears.

MANUAL

- 1 Press the **▼/▲** buttons to choose a programme number (PR) for a new TV channel

- 2 Press the blue button to activate the MANUAL function

At the right side following the CH/CC number, the SYSTEM (sound system) of the TV channel appears.

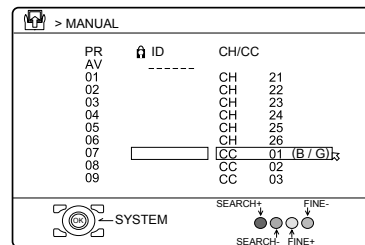

To cancel the MANUAL function:
Press the **BACK** button.

- 3 Press the **▶** button to choose the SYSTEM (sound system) for a TV channel you want to register

- For the sound systems in each country or region, refer to the table below:

Area	Country or Region	System
Asia, Middle East	Bahrain, Kuwait, Oman, Qatar, United Arab Emirates, Yemen, etc.	B/G
	Indonesia, Malaysia, Singapore, Thailand, India, etc.	D/K
	China, Vietnam, etc.	I
	Hong Kong, etc.	B/G
	Islamic Republic of Iran, Lebanon, Saudi Arabia, etc.	M
Europe	Philippines, Taiwan, Myanmar, etc.	D/K
	Russia, etc.	D/K
	Czech Republic, Poland, etc.	B/G
	Germany, Holland, Belgium, etc.	I
Oceania	UK, etc.	B/G
Africa	Australia, New Zealand, etc.	I
	Republic of South Africa, etc.	B/G
	Nigeria, etc.	B/G
	Egypt, Morocco, etc.	B/G

- 4 Press the green or red button to search for a TV channel
Scanning stops when the TV finds a TV channel. Then the TV channel is displayed.

- 5 Press the green or red button repeatedly until the TV channel you want appears

If the TV channel reception is poor:

Press the blue or yellow button to fine-tune the TV channel.

If you cannot hear the normal sound even when the picture of the TV channel appears normally:

The SYSTEM setting is wrong. Press the **▶** button and choose a SYSTEM that has normal sound.

- 6 Press the **OK** button and register the TV channel to a Programme number (PR)

The normal EDIT menu is resumed.

LANGUAGE

The LANGUAGE setting which was performed in the “Initial settings (Setup tour)” (page 6) can be changed.

1 Choose LANGUAGE, then press the OK or ► button

A sub-menu of the LANGUAGE function appears.

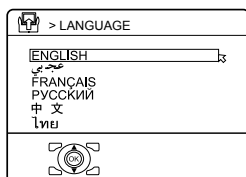

2 Press the ▼/▲ buttons to choose a language. Then press the OK button

VIDEO-1 SETTING/VIDEO-3 SETTING

Set the VIDEO-1 SETTING or VIDEO-3 SETTING correctly according to the video signal input from the external device connected to the VIDEO-1 or VIDEO-3 terminal. If this setting is incorrect, images will not be displayed.

VIDEO:

If a normal video signal (composite video signal) is input.

COMPONENT:

If a Component video signal (Y, Cb/Pb, Cr/Pr signals) is input.

- For detailed connecting methods, see “Additional preparation” on page 24. This Television is compatible with the 1125i, 625p or 525p video signal only when the component video signal is input.
- When the input signal is 1125i, 625p or 525p, each signal type is displayed at the upper right side on the TV screen by setting the input to VIDEO-1 or VIDEO-3.

AI VOLUME

You can prevent the sudden increase or decrease of sound that occurs when changing the channel to another channel.

ON:

This function is turned on.

OFF:

This function is turned off.

- The AI VOLUME function may not operate as expected if the sound input level from a broadcast station is extremely low.
- This function does not work in the VIDEO mode.

TELETEXT LANGUAGE

There are four types of teletext language groups. Set the teletext language group that corresponds to the language of the teletext programme that you want to watch.

1 Choose TELETEXT LANGUAGE, then press the OK or ► button

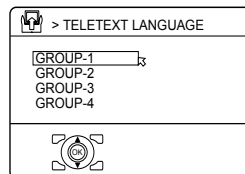

2 Press the ▼/▲ buttons to choose a group

Group	Languages
GROUP-1	Turkish, Hungarian, English, German, French, Italian, Spanish, Portuguese, Greek, Swedish, Finnish
GROUP-2	Polish, Serbian, Croatian, Slovenian, Czech, Slovak, Rumanian, Hungarian, German, French, Italian, Swedish, Finnish
GROUP-3	Russian, Bulgarian, Lettish, Lithuanian, Estonian, Ukrainian, Serbian, Croatian, Slovenian, Czech, Slovak, English, German
GROUP-4	Arabic, Czech, Slovak, Hungarian, English, German, French, Italian, Spanish, Portuguese, Swedish, Finnish

3 Press the OK button to complete the setting

The menu disappears.

- Languages that are not included in the teletext language group that you select will not be displayed properly in the sub-titles of the teletext programme.

HDMI SETTING

This function is used if you have a DVI or HDMI compatible device connected to your TV.

1 Press the ▼/▲ buttons and choose SIZE or AUDIO

- SIZE can only be chosen when the picture signal is VGA or 480p.

2 Press the ◀/▶ buttons and set SIZE or AUDIO

SIZE:

This option adjusts the position when a VGA or 480p picture signal is being displayed on the screen. If the displayed picture is slightly shifted, the position can be adjusted by choosing 1, 2 or AUTO.

AUDIO:

Choose DIGITAL when only connecting with the HDMI cable. Choose ANALOG when a DVI device is connected to the HDMI terminal and the audio output terminal of the DVI device is connected to the IN(HDMI AUDIO) terminal.

Choose AUTO when you want the TV to automatically select DIGITAL or ANALOG.

LAMP TIMER RESET

See “LAMP TIMER RESET” on page 31.

Additional preparation

Connecting external equipment

You can connect many different devices to the TV.
Please read the user manual of each device before setting up.
(Connecting cables are not supplied with this TV.)

- ① AV COMPULINK cable
- ② HDMI cable
- ③ Audio cable (stereo)
- ④ Component video cable
- ⑤ Video cable
- ⑥ S-VIDEO cable
- ⑦ D-SUB (15 pin) cable

Caution

- Turn off all the equipment including the TV, before connecting external equipment.

⇒ : Signal direction

JVC's VCR / DVD player
(AV COMPULINK compatible)



DVD player / DVD recorder
(HDMI compatible)



VCR / DVD recorder
for recording



Back of the TV

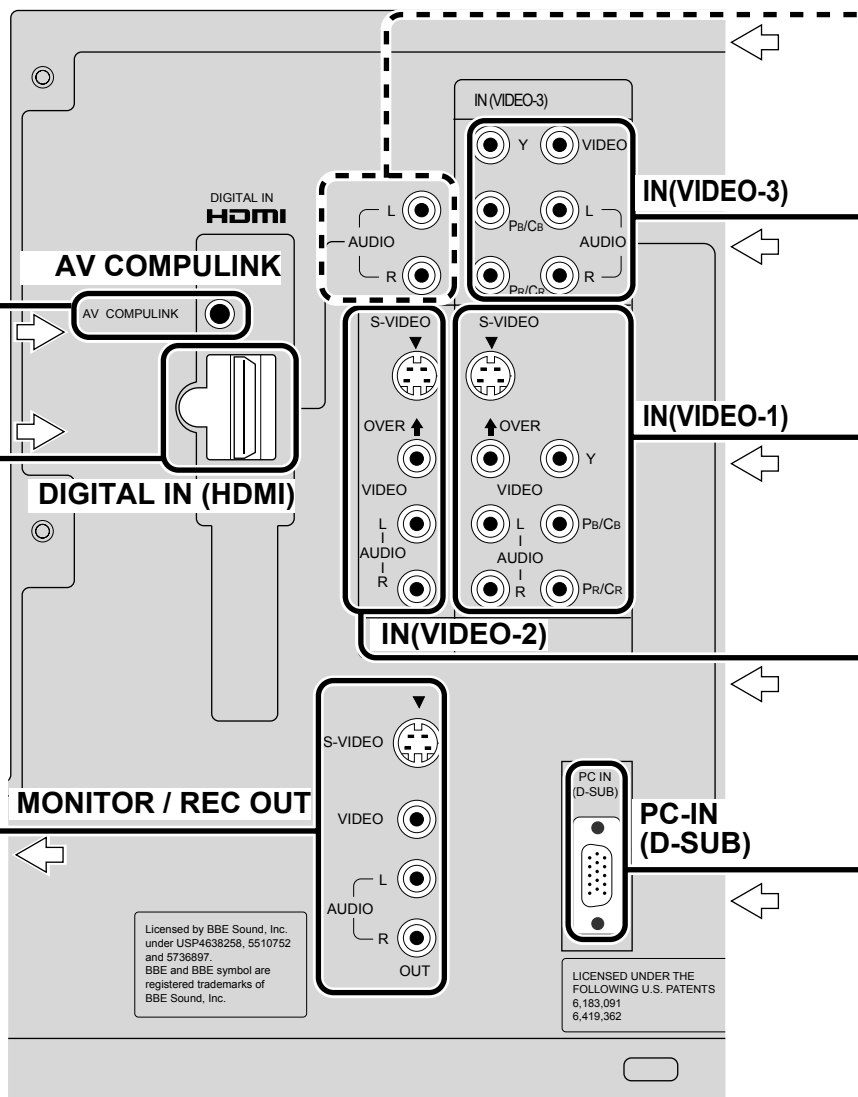

Right side of the TV

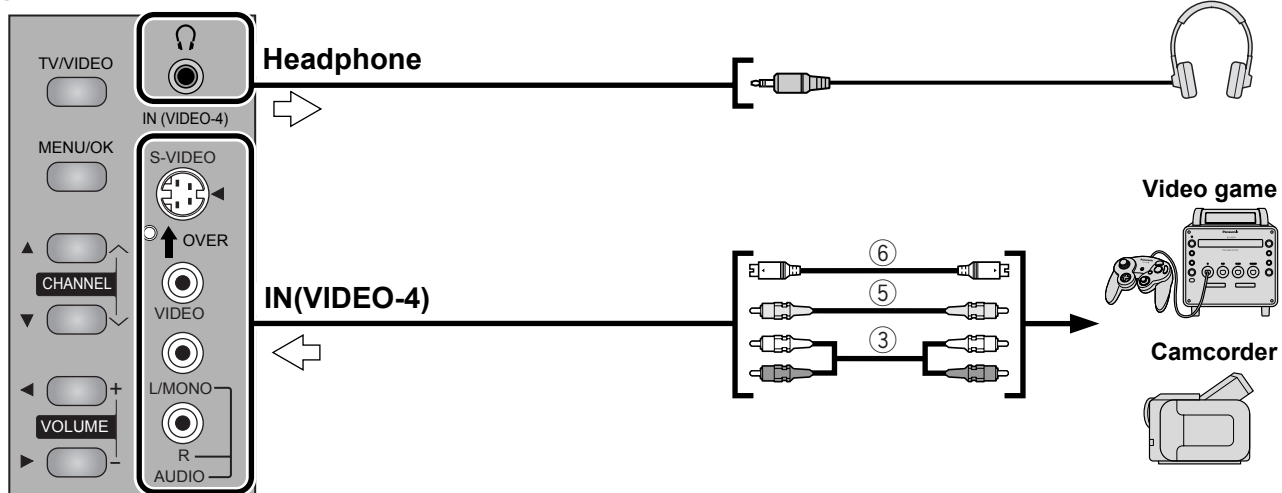

- When you connect S-VIDEO cable to IN(VIDEO-1), IN(VIDEO-2), or IN(VIDEO-4) terminal, S-VIDEO signal has priority over composite video signal.
- When you connect component video cable to IN(VIDEO-1) or IN(VIDEO-3) terminal, you have to set the "VIDEO-1 SETTING/VIDEO-3 SETTING" to "COMPONENT" (See page 23).

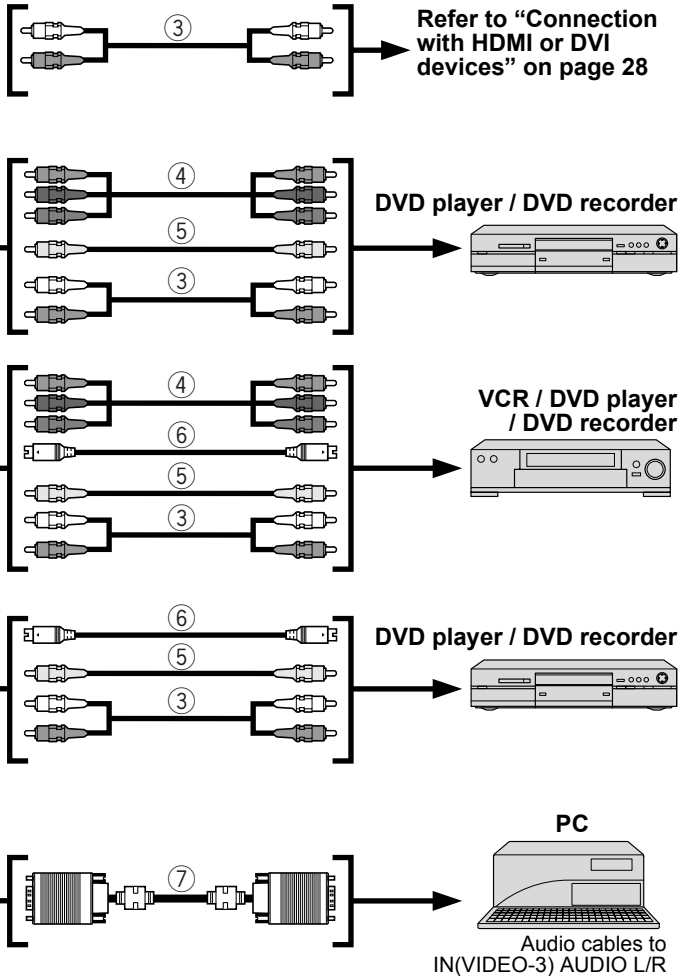

■ **IN(VIDEO-1)**

Watching videos.

Output	Input
—	<ul style="list-style-type: none"> • Component signal / S-VIDEO /Composite signal • Sound L / R

■ **IN(VIDEO-2)**

Watching videos.

Output	Input
—	<ul style="list-style-type: none"> • S-VIDEO /Composite signal • Sound L / R

■ **IN(VIDEO-3)**

Watching videos.

Output	Input
—	<ul style="list-style-type: none"> • Component signal / Composite signal • Sound L / R

■ **IN(VIDEO-4)**

Watching videos.

Output	Input
—	<ul style="list-style-type: none"> • S-VIDEO /Composite signal • Sound L / R

■ **DIGITAL IN**

Connecting HDMI devices.

Output	Input
—	<ul style="list-style-type: none"> • HDMI signal • Sound L / R

- Check for HDMI device compatibility or when connect DVI device to this terminal, refer to "Connection with HDMI or DVI devices" on page 28.

■ **PC-IN (D-SUB)**

Using TV as computer screen.

- When the sound from the computer is connected to VIDEO-3, by choosing external input VIDEO-3 the sound from the computer can be listened to, but the images from the computer cannot be seen.
- Check for PC compatibility, refer to "PC Signals that can be displayed" on page 28.

■ **MONITOR REC OUT**

Recording on VCR or DVD recorder.

Output	Input
<ul style="list-style-type: none"> • S-VIDEO /Composite signal • Sound L / R 	—

■ **AV COMPULINK**

Using JVC's AV COMPULINK feature.

This feature makes playing video tapes or DVDs totally automatic. Simply insert a pre-recorded media into your JVC brand VCR or DVD player and the device will automatically turn on and begin playback. At the same time, using the AV CompuLink, the VCR or DVD player sends a signal to the television telling it to turn on and switch to the proper video input.

- If your JVC brand VCR has "A code/B code remote control switching" (see your VCR's instruction book), using VCR A code will switch the TV to input 1.
- Refer to your DVD or VCR's instruction book for detailed connection information.

Troubleshooting

Severe noise or snow



- Is the TV connected correctly to the aerial ?
- Change the direction of the aerial.
- Is the aerial or its cable damaged ?
→ Consult your retailer.

Patterns, stripes or noise

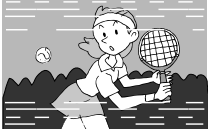

- Is the aerial receiving interference from high-voltage power lines or wireless transmitters ?
→ Consult your retailer.
- Are connected devices too close to the TV ?
→ Insert the minimum distance between the aerial and the cause of interference until the interference is removed.

Ghosting

(Doubling of images)

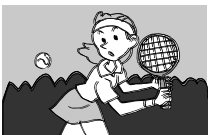

- Are you receiving interference from signals reflected off mountains or buildings ?
→ Adjust the direction of your aerial, or change to a good-quality directional aerial.

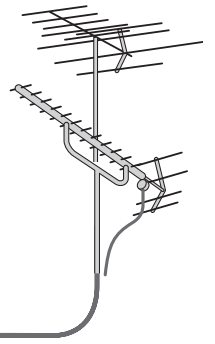
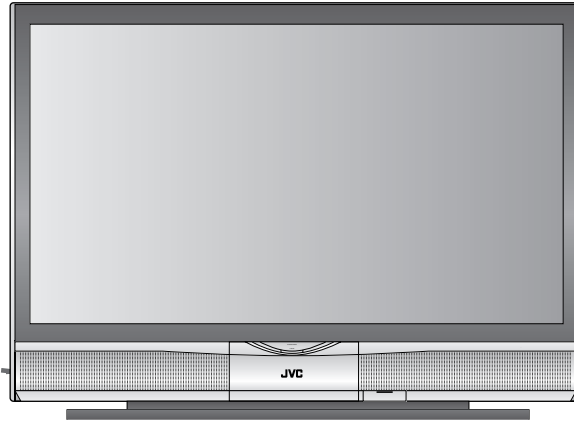

I can't turn it on!

- Is the power cord connected to the AC outlet correctly ?

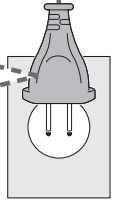

The remote control doesn't work!

- Are the batteries flat ?
- Are you more than 7 metres away from the TV ?
- Is the "VCR/TV/DVD SWITCH" set to "TV" ?
- When viewing teletext, the TV menu bar does not appear.
- Depending on the stability of the signal, there may be a time lag when changing channels.

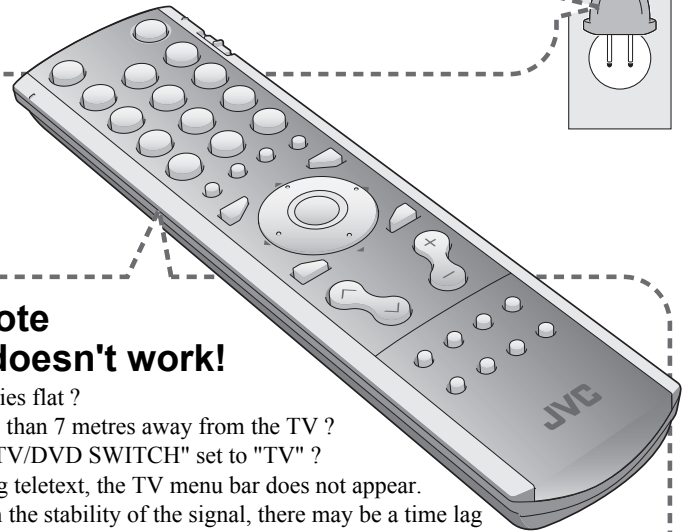

Warning LED Messages

While the power is on, and there is a problem with the TV, the TV changes to warning mode and informs you of the problem using the LED as follows. Then, the power turns off automatically and performs the cooling for approximately 90 seconds.

■ The LAMP LED blinks

Condition: It may be a malfunction of the internal electrical circuits.

To correct: Keep the TV off for a while and then turn the power on again. If the TV goes into warning mode, unplug the TV after the cooling has completed and consult your dealer.

■ The POWER LED blinks

Condition: It may be a malfunction of the internal electrical circuits.

To correct: Keep the TV off for a while and then turn the power on again. If the TV goes into warning mode, unplug the TV after the cool down has completed and consult your dealer.

■ The POWER LED and LAMP LED blink alternately

Condition: The inside temperature rises abnormally or the fan may be blocked.

To correct: Keep the TV off for a while and then turn the power on again. If the TV goes into warning mode, unplug the TV after the cool down has completed and consult your dealer.

■ The POWER LED and LAMP LED blink rapidly simultaneously

Condition: The lamp unit has been installed on a slant and is not flat, or it is not fully inserted into the lamp housing. Or it may be a lamp malfunction.

To correct:

- If this condition occurs soon after replacing the lamp: Reinstall the new lamp unit. Repeat the lamp installation steps, taking care to observe all warnings. Make sure the lamp sits FLAT inside the unit when you reinstall it.
- If this condition occurs except for replacing the lamp: Keep the TV off for a while and then turn the power on again. If the TV goes into warning mode, unplug the TV after the cool down has completed and consult your dealer.

	Problem	Actions	Page
Basics	Remote control stops working.	<ul style="list-style-type: none"> Unplug TV, several minutes later plug it in again. 	—
	Black or white dots appears on the screen	<ul style="list-style-type: none"> Although the HD-ILA element is manufactured with high-precision technology, please understand that some pixels may be lost or permanently displayed. 	—
Picture	Poor picture quality	<ul style="list-style-type: none"> Unnatural colour >>> Adjust COLOUR and BRIGHT. Check your COLOUR SYSTEM. Noise >>> Set to the following functions. PICTURE MODE: STANDARD DIGITAL VNR: AUTO (HIGH) Super DigiPure: MIN Dull picture >>> Set to the following functions. PICTURE MODE: BRIGHT DIGITAL VNR: MIN Super DigiPure: MAX 	15, 17 15, 16 15, 16
	Strange picture when using an external device	<ul style="list-style-type: none"> If the top of the image is distorted, check the video signal quality itself. If movement appears unnatural when receiving a signal from a DVD player, etc. with progressive-scanning, change the output setting of the external device to interlace-scanning. 	— —
Sound	Poor sound	<ul style="list-style-type: none"> Adjust the BASS and TREBLE. If receiving a poor signal in "STEREO / I · II", switch to MONO. Adjust the channel reception using "MANUAL". 	18 18 21
HDMI	Wrong screen size	<ul style="list-style-type: none"> Switch SIZE in HDMI SETTING to "1" or "2". 	23
	No sound	<ul style="list-style-type: none"> Switch AUDIO in HDMI SETTING to ANALOG or DIGITAL. 	23
	Green and distorted screen	<ul style="list-style-type: none"> Wait a little for the signal to stabilize when switching the signal format for an HDMI device. 	—

Problem		Actions	Page
Functions	Some functions do not work	<ul style="list-style-type: none"> It is not a malfunction. Some functions (dark background) in the menu do not work depending on the situation. 	—
	Some inputs cannot be selected in the sub-picture	<ul style="list-style-type: none"> VIDEO-4, VIDEO-5 and PC mode cannot be selected in the sub-picture. 	—

The followings are not malfunctions.

- The television may make a creaking sound if the temperature of the room or the temperature inside the television changes. If there is no problem with the screen or sound, then there is no need to worry.
- The lamp may make a noise when it blows, but this is not dangerous.
- The lamp may make a noise when the power is turned on and a picture is displayed on the screen. This noise is caused when the mercury inside the lamp is heated, and is not a malfunction.
- The still parts of a picture may remain on the screen. This is a characteristic of HD-ILA elements and not a malfunction. The picture will disappear over time.
- The operation of this television is not guaranteed below 0°C. If the power is turned on while the temperature is below 0°C, the picture may be disturbed. Use the television when the temperature is 0°C or higher.
- There is a cooling fan built-in to the television. Please understand that this fan will make some noise when the television is on and while cooling.
- The picture may be temporarily disturbed and noise may be seen on the screen if the power is turned on immediately after it has been turned off. This is not a malfunction.

Technical Information

Connection with HDMI or DVI devices

The HDMI of the TV is compatible with the following video signals.

VGA/60Hz	4:3	576p/50Hz (625p/50Hz)	4:3
480i/60Hz (525i/60Hz)	4:3	576p/50Hz (625p/50Hz)	16:9
480i/60Hz (525i/60Hz)	16:9	720p/50Hz (750p/50Hz)	16:9
480p/60Hz (525p/60Hz)	16:9	720p/60Hz (750p/60Hz)	16:9
576i/50Hz (625i/50Hz)	4:3	1080i/50Hz (1125i/50Hz)	16:9
576i/50Hz (625i/50Hz)	16:9	1080i/60Hz (1125i/60Hz)	16:9

- To connect the DVI device to the HDMI terminal, connect the DVI terminal of the DVI device to the HDMI terminal of the TV with the DVI-HDMI converter cable, and the audio output terminal of the DVI device to the DIGITAL IN AUDIO L/R terminal of the TV with the audio cable. When these connections are made, set AUDIO in HDMI SETTING menu to AUTO or ANALOG. Refer to “HDMI SETTING” on page 23.
- The HDMI terminal is not compatible with the picture signal of a personal computer.

PC Signals that can be displayed

Only the below formats are supported.

Resolution	Vertical frequency (Hz)	Horizontal frequency (kHz)
640 × 480 (VGA)	60.0	31.5
1024 × 768 (XGA)	60.0	42.0

- Apple Macintosh* computers are not supported.

When a picture is not displayed

Check the computer’s refresh rate and set it to 60 Hz. Refer to the computer’s instruction manual. Computers which cannot have their refresh rate set to 60 Hz cannot be used with this unit.

* Apple Macintosh is a registered trademark of Apple Computer, Inc.

CH/CC numbers

When you want to use the INSERT function on page 22, find the CH/CC number corresponding to the Channel number of the TV channel from this table.

- US: The US channel numbers are the channel numbers used in the United States, Philippines, etc.
 CCIR: The CCIR channel numbers are the channel numbers used in the Middle East, Southeast Asia, etc.
 OIRT: The OIRT channel numbers are the channel numbers used in Eastern Europe, Russia, Vietnam, etc.
 AUSTRALIA: The AUSTRALIA channel numbers are the channel numbers used in Australia, etc.

CH	Channel			
	US	CCIR	OIRT	AUSTRALIA
CH02	US-2	E2	R1	AU-0
CH03	US-3	E3		AU-1
CH04	US-4	E4	R2	AU-2
CH05	US-5	E5	R6	AU-6
CH06	US-6	E6	R7	AU-7
CH07	US-7	E7	R8	AU-8
CH08	US-8	E8	R9	AU-9
CH09	US-9	E9		
CH10	US-10	E10	R10	AU-10
CH11	US-11	E11	R11	AU-11
CH12	US-12	E12	R12	
CH13	US-13			
CH14	US-14, W+29			
CH15	US-15, W+30			
CH16	US-16, W+31			
CH17	US-17, W+32			
CH18	US-18, W+33			
CH19	US-19, W+34			
CH20	US-20, W+35			
CH21	US-21, W+36	E21		
CH22	US-22, W+37	E22		
CH23	US-23, W+38	E23		
CH24	US-24, W+39	E24		
CH25	US-25, W+40	E25		
CH26	US-26, W+41	E26		
CH27	US-27, W+42	E27		
CH28	US-28, W+43	E28		
CH29	US-29, W+44	E29		
CH30	US-30, W+45	E30		
CH31	US-31, W+46	E31		
CH32	US-32, W+47	E32		
CH33	US-33, W+48	E33		
CH34	US-34, W+49	E34		
CH35	US-35, W+50	E35		
CH36	US-36, W+51	E36		
CH37	US-37, W+52	E37		
CH38	US-38, W+53	E38		
CH39	US-39, W+54	E39		
CH40	US-40, W+55	E40		
CH41	US-41, W+56	E41		
CH42	US-42, W+57	E42		
CH43	US-43, W+58	E43		
CH44	US-44, W+59	E44		
CH45	US-45, W+60	E45		
CH46	US-46, W+61	E46		
CH47	US-47, W+62	E47		
CH48	US-48, W+63	E48		
CH49	US-49, W+64	E49		
CH50	US-50, W+65	E50		
CH51	US-51, W+66	E51		
CH52	US-52, W+67	E52		
CH53	US-53, W+68	E53		
CH54	US-54, W+69	E54		
CH55	US-55, W+70	E55		
CH56	US-56, W+71	E56		
CH57	US-57, W+72	E57		
CH58	US-58, W+73	E58		
CH59	US-59, W+74	E59		
CH60	US-60, W+75	E60		
CH61	US-61, W+76	E61		
CH62	US-62, W+77	E62		
CH63	US-63, W+78	E63		
CH64	US-64, W+79	E64		
CH65	US-65, W+80	E65		
CH66	US-66, W+81	E66		
CH67	US-67, W+82	E67		
CH68	US-68, W+83	E68		
CH69	US-69, W+84	E69		

CC	Channel			
	US	CCIR	OIRT	AUSTRALIA
CC01		S-1		AU-5
CC02		S-2		
CC03		S-3		
CC04		S-4		
CC05		S-5		
CC06		S-6		AU-5A
CC07		S-7		
CC08		S-8		
CC09		S-9		
CC10		S-10		
CC11		S-11		
CC12		S-12		
CC13		S-13		
CC14	A	S-14		
CC15	B	S-15		
CC16	C	S-16		
CC17	D	S-17		
CC18	E	S-18		
CC19	F	S-19		
CC20	G	S-20		
CC21	H	S-21		
CC22	I	S-22		
CC23	J	S-23		
CC24	K	S-24		
CC25	L	S-25		
CC26	M	S-26		
CC27	N	S-27		
CC28	O	S-28		
CC29	P	S-29		
CC30	Q	S-30		
CC31	R	S-31		
CC32	S	S-32		
CC33	T	S-33		
CC34	U	S-34		
CC35	V	S-35		
CC36	W	S-36		
CC37	W+1	S-37		
CC38	W+2	S-38		
CC39	W+3	S-39		
CC40	W+4	S-40		
CC41	W+5	S-41		
CC42	W+6			
CC43	W+7			
CC44	W+8			
CC45	W+9			
CC46	W+10			
CC47	W+11			
CC48	W+12			
CC49	W+13			
CC50	W+14			
CC51	W+15			
CC52	W+16			
CC53	W+17			
CC54	W+18			
CC55	W+19			
CC56	W+20			
CC57	W+21			
CC58	W+22			
CC59	W+23			
CC60	W+24			
CC61	W+25			
CC62	W+26			
CC63	W+27			
CC64	W+28			
CC75		X		
CC76		Y	R3	
CC77		Z	R4	AU-3
CC78		Z+1	R5	
CC79		Z+2		AU-4
CC95	A-5			
CC96	A-4			
CC97	A-3			
CC98	A-2			
CC99	A-1			

Appendix

Changing the Lamp

WARNING!

It is very important that you **NEVER TOUCH THE GLASS SURFACE OF THE NEW LAMP**. Touching the glass surface will deposit oils from your hand onto the lamp surface. When the lamp heats up to its operating temperature, the oil will cause a difference in temperature on the lamp surface that will likely cause the lamp to break.

Replace the lamp with **part number TS-CL110U only!** The television is designed to work specifically with this lamp. Using a different lamp, or a third-party manufacturer's lamp could cause a malfunction and or damage to the television.

This television uses a 110-Watt high-pressure mercury lamp to project images onto the television screen. When the lamp nears the end of its operating life, you may notice the picture becoming dark. When the picture begins to darken, or the lamp burns out, it is time to replace the lamp. The following instructions will tell you how to safely replace the lamp.

WARNING!

Under operating conditions, THE LAMP WILL GET EXTREMELY HOT AND WILL CAUSE SEVERE BURNS IF TOUCHED.

Before attempting to replace the lamp, make sure the television has completely run through its cooling cycle. Turn the power off and wait until the LAMP LED blinks very slowly and turns off completely. Unplug the TV. If you feel any warmth as you place your hand near the lamp, DO NOT TOUCH IT. Wait until the lamp has completely cooled before attempting to replace it. After turning the power off, wait at least 1 hour or more.

NEVER attempt to replace the lamp with the television plugged into a wall outlet. Attempting to replace the lamp with the TV plugged in could lead to a severe electrical shock.

Do not keep the TV on for more than 24 hours consecutively. There is the possibility of the life of the lamp being shortened.

The life of the lamp changes depending on the atmospheric temperature and altitude in which the TV is being used.

Please read these instructions fully before attempting to replace the lamp. If you feel unsure about replacing the lamp yourself, call a service technician.

Replacement Lamp Kit

Before replacing the lamp, you will need to purchase a replacement kit, part number TS-CL110U. To purchase this kit, consult your dealer.

The replacement kit will include the following:

1 High-Pressure Mercury Lamp 1 Instruction Manual

Because the lamp contains a small amount of mercury, it cannot be disposed of with normal trash.

Lamp Message

LAMP NEEDS TO BE REPLACED. REFER TO OWNER'S MANUAL FOR REPLACEMENT INSTRUCTIONS.

AFTER REPLACING THE LAMP, PLEASE RESET TIMER IN THE TV MENU.

PRESS OK, IF YOU DO NOT WANT TO SEE THIS MESSAGE AGAIN.

If this message appears when you turn the TV on, you need to replace the lamp. See "How to Replace the Lamp" on next page how to replace the lamp.

- This message will appear every time you turn on the TV when the lamp needs to be replaced. Press the OK button to make the message disappear, or replace the lamp.

How to Replace the Lamp

Please read these instructions fully before attempting to replace the lamp. If you feel unsure about replacing the lamp yourself, call a service technician. Please observe all safety warnings.

1 Turn off the television.

Press the POWER button on the remote control or TV front panel. Wait until the picture has closed and the LAMP LED on the front panel has stopped blinking indicating the lamp cool down is complete.

WARNING: The cool-down process cools the lamp from its operating temperature. This does not mean that the lamp will now be cool enough to handle safely. We strongly recommend you wait at least one hour before proceeding.

2 Unplug the television.

Disconnect the power cord from the AC outlet. Make sure that the LAMP LED light has stopped blinking before you unplug the set. Never attempt to replace the lamp with the television plugged in.

3 Remove the lamp cover.

The lamp is located behind the lamp cover on the left side of the television. To access the lamp you will need to remove the lamp cover. First, loosen the screw located on the lamp cover using your fingers. Once the screw has been loosened, gently pull the knob towards you and the panel will come away from the television. Set it aside.

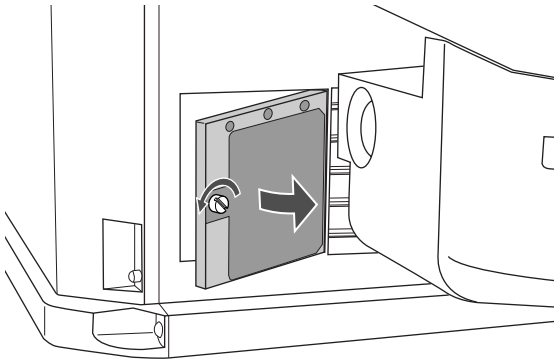

WARNING: DO NOT attempt to remove the assembly until the lamp has fully cooled. If you feel any heat near the lamp, STOP and wait until the lamp has FULLY COOLED.

NEVER attempt to remove the lamp with the television plugged into an outlet.

DO NOT DROP the used lamp. The inside of the lamp is under pressure. Dropping or other hard shocks could cause the lamp to shatter.

ALWAYS recycle the used lamp. Because the lamp contains a small amount of mercury, it cannot be thrown away with regular trash. Follow the recycling instructions included with the Lamp Replacement Kit.

4 Remove the lamp unit.

Using a Philips head type screwdriver (cross-head type), loosen the two screws fastening the lamp unit. When the screws have been loosened, remove the lamp by raising the handle and gently sliding the unit straight towards you. Place it carefully in the recycling packaging.

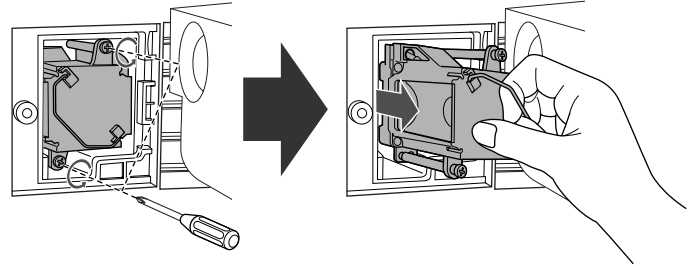

5 Install the new lamp unit.

Holding the handle attached to the new lamp unit, slide and push the new lamp straight into the television and back into the lamp housing area. **Do not forget to re-tighten the two screws.**

- Do not touch the lamp surface. Fingerprint or other stains may cause the unit to brake.
- If the lamp does not sit securely in the TV (flat in the lamp housing area), it won't turn on. Make sure the lamp sits securely and flat in the housing area.

6 Re-install the lamp cover.

Insert the lamp cover in the right concaves and close the lamp cover. Because the lamp cover has a role to help prevent the danger of an electrical shock, tighten the screw using your fingers.

LAMP TIMER RESET

The lamp replacement message will appear when you need to change the lamp. After you replace the lamp, you need to reset the timer which is built into your television.

1 Choose LAMP TIMER RESET in the SET UP menu, then press the OK or ► button (see page 14)

The following message will appear.

PRESS OK TO RESET THE LAMP TIMER.

2 Press OK button while the above message appears on the television screen

The lamp timer has now been reset and the following message will blink.

THE LAMP TIMER IS RESET SUCCESSFULLY.

- You can use the LAMP TIMER RESET only after replacing the lamp.

Specifications

Model	HD-Z70RX5	HD-Z56RX5
Type	HD-ILA Device Projection	
Broadcasting systems	B, G, I, D, K, K1, M	
Colour systems	PAL, SECAM, NTSC 3.58/4.43 MHz	
Channels and frequencies	VHF low channel (VL) = 46.25 to 168.25 MHz VHF high channel (VH) = 175.25 to 463.25 MHz UHF channel (U) = 471.25 to 863.25 MHz • Receives cable channels in mid band (X to Z+2, S1 to S10), super band (S11 to S20) and hyper band (S21 to S41).	
Sound-multiplex systems	NICAM (B/G, I, D/K) system, A2 (B/G, D/K) system	
Languages displayed by teletext	Please see the table in the description "TELETEXT LANGUAGE" on page 23.	
Teletext systems	FLOF (Fastext), WST (World Standard System)	
Power requirements	110 - 240 V AC, 50/60 Hz	
Power consumption	187 W (Standby: 2.5 W)	187 W (Standby: 2.5 W)
Projection Source	110W High-Pressure Mercury Lamp	
Screen size	Viewable area 178 cm (measured diagonally)	Viewable area 142 cm (measured diagonally)
Audio output	Rated Power output: 10 W + 10 W	
Speakers	10 cm round × 2	
VIDEO-1 terminal	RCA connector × 3, S VIDEO connector × 1, Component connector × 1 • Video input, S VIDEO (Y/C) input, Component video (Y, Cb/Pb, Cr/Pr) input and Audio L/R inputs are available. • 480i (525i), 480p (525p), 576i (625i), 576p (625p), 1080i (1125i), 720p (750p) signals are available.	
VIDEO-2 terminal	RCA connector × 3, S VIDEO connector × 1 • Video input, S VIDEO (Y/C) input and Audio L/R inputs are available.	
VIDEO-3 terminal	RCA connector × 3, Component connector × 1 • Video input, Component video (Y, Cb/Pb, Cr/Pr) input and Audio L/R inputs are available. • 480i (525i), 480p (525p), 576i (625i), 576p (625p), 1080i (1125i), 720p (750p) signals are available.	
VIDEO-4 terminal	RCA connector × 3, S VIDEO connector × 1 • Video input, S VIDEO (Y/C) input and Audio L/R inputs are available.	
DIGITAL IN terminal	HDMI connector × 1, RCA connector × 2 • Digital video input, digital audio input and Audio L/R inputs are available. (Refer to page 28 for details.)	
MONITOR OUT terminal	RCA connectors × 3, S VIDEO connector × 1 • Video output, S VIDEO (Y/C) output and Audio L/R outputs are available. • Output level 0.5 Vrms.	
PC IN (D-SUB) terminal	Analogue RGB D-SUB (15 pin) × 1 • PC signal is available. Refer to page 28 for details of the signals which can be input.	
AV COMPULINK jack	Stereo mini-jack (3.5 mm in diameter)	
Headphone jack	Stereo mini-jack (3.5 mm in diameter)	
Dimensions (W × H × D)	1626 mm × 1167 mm × 519 mm	1318 mm × 968 mm × 439 mm
Weight	72 kg	42 kg
Accessories	Remote control unit × 1 (RM-C1835) AA/R6 dry cell battery × 2 High-Pressure Mercury Lamp (TS-CL110C) × 1	

We may change the design and specifications without notice.

Pictures displayed on the screen using this TV's ZOOM functions should not be shown for any commercial or demonstration purpose in public places (cafes, hotels, etc.) without the consent of the owners of copyright of the original picture sources, as this would be an infringement of copyright.



JVC

Free Manuals Download Website

<http://myh66.com>

<http://usermanuals.us>

<http://www.somanuals.com>

<http://www.4manuals.cc>

<http://www.manual-lib.com>

<http://www.404manual.com>

<http://www.luxmanual.com>

<http://aubethermostatmanual.com>

Golf course search by state

<http://golfingnear.com>

Email search by domain

<http://emailbydomain.com>

Auto manuals search

<http://auto.somanuals.com>

TV manuals search

<http://tv.somanuals.com>