



HOME THEATER SOUND SYSTEM

TH-BS7

—Consists of AX-THBS7, SP-THBS7F and SP-THBS7W



Thank you for purchasing a JVC product. Before operation, please read the instructions carefully.

For customer use:
Enter below the Model No. and Serial No. which are located either on the rear, bottom or side of the cabinet. Retain this information for future reference.

Model No. _____
Serial No. _____

INSTRUCTIONS GVT0290-017A[J/C]
0909WMKMDWJMM

© 2009 Victor Company of Japan, Limited

CAUTION
To reduce the risk of electrical shocks, fire, etc.:
1. Do not remove screws, covers or cabinet.
2. Do not expose this appliance to rain or moisture.

ATTENTION
Afin d'éviter tout risque d'électrocution, d'incendie, etc.:
1. Ne pas enlever les vis ni les panneaux et ne pas ouvrir le coffret de l'appareil.
2. Ne pas exposer l'appareil à la pluie ni à l'humidité.

CAUTION (AX-THBS7)
The ⏻ button in any position does not disconnect the mains line. Disconnect the mains plug to shut the power off completely (the ⏻ symbol goes off). The MAINS plug or an appliance coupler is used as the disconnect device, the disconnect device shall remain readily operable.
• When the System is on standby, the ⏻ symbol lights red.
• When the System is turned on, the ⏻ symbol goes off.
The power can be remote controlled.

ATTENTION (AX-THBS7)
La touche ⏻ , dans n'importe quelle position, ne déconnecte pas le système du secteur. Déconnectez la fiche de secteur pour mettre l'appareil complètement hors tension (Le symbole ⏻ s'éteint). La fiche secteur ou un coupleur est utilisé comme dispositif de déconnexion de l'appareil, et l'appareil déconnecté doit être prêt à être utilisé.
• Quand le système est en attente, le symbole ⏻ est allumé en rouge.
• Quand le système est sous tension, le symbole ⏻ s'éteint.
L'alimentation peut être télécommandée.

CAUTION (SP-THBS7W)
The power supply to the subwoofer is linked to the center unit. Disconnect the mains plug to shut the power off completely (the STANDBY/ON lamp goes off). The MAINS plug or an appliance coupler is used as the disconnect device, the disconnect device shall remain readily operable.
• When the System is on standby, the STANDBY/ON lamp lights red.
• When the System is turned on, the STANDBY/ON lamp lights blue.

ATTENTION (SP-THBS7W)
L'alimentation du caisson de grave est reliée à l'unité centrale. Déconnectez la fiche secteur pour mettre l'appareil complètement hors tension (le témoin STANDBY/ON s'éteint). La fiche secteur ou un coupleur est utilisé comme dispositif de déconnexion de l'appareil, et l'appareil déconnecté doit être prêt à être utilisé.
• Quand le système est en attente, le témoin STANDBY/ON est allumé en rouge.
• Quand l'appareil est sous tension, le témoin STANDBY/ON est allumé en bleu.

Introduction

Notes on handling

Important cautions
Installation of the System
• Select a place which is level, dry, and neither too hot nor too cold; between 5°C and 35°C.
• Leave sufficient distance between the System and the TV.
• Do not use the System in a location near heat sources, or in a place subject to direct sunlight, excessive dust, or vibration.
• Install the System in a location with adequate ventilation to prevent the internal heat buildup.
• The manufacturer accepts absolutely no liability for any accidents or damage resulting from inadequate assembly or mounting, insufficient strength of attachment, misuse or abuse, or natural disasters.

Power cord
• Do not handle the power cord with wet hands.
• A small amount of power is always consumed while the power cord is connected to the wall outlet.
• Do not pull on the cord to unplug the power cord. When unplugging the power cord, always grasp and pull the plug so as not to damage the cord.
To prevent malfunctions of the System
• There are no user-serviceable parts inside. If anything goes wrong, unplug the power cord and consult your dealer.
• Do not insert any metallic objects or liquids into the System.
• Do not place anything on top of the System. Doing so may cause the System to fall, causing malfunctioning and/or injury.

Safety precautions
Avoid moisture, water, and dust
Do not place the System in moist or dusty places.
Avoid high temperatures
Do not expose the System to direct sunlight and do not place it near any heating devices.
When you are away
When away on holiday or for other reasons for an extended period of time, disconnect the power cord from the wall outlet.
Do not block the vents
Blocking the vents may damage the System.

Warnings, Cautions and Others / Mises en garde, précautions et indications diverses

For U.S.A.

The lightning flash with arrowhead symbol, within an equilateral triangle, is intended to alert the user to the presence of uninsulated "dangerous voltage" within the product's enclosure that may be of sufficient magnitude to constitute a risk of electric shock to persons.

The exclamation point within an equilateral triangle is intended to alert the user to the presence of important operating and maintenance (servicing) instructions in the literature accompanying the appliance.

Pour les Etats-Unis

Le symbole de l'éclair à l'intérieur d'un triangle équilatéral est destiné à alerter l'utilisateur sur la présence d'une "tension dangereuse" non isolée dans le boîtier du produit. Cette tension est suffisante pour provoquer l'électrocution de personnes.

Le point d'exclamation à l'intérieur d'un triangle équilatéral est destiné à alerter l'utilisateur sur la présence d'opérations d'entretien importantes au sujet desquelles des renseignements se trouvent dans le manuel d'instructions.

For Canada
THIS DIGITAL APPARATUS DOES NOT EXCEED THE CLASS B LIMITS FOR RADIO NOISE EMISSIONS FROM DIGITAL APPARATUS AS SET OUT IN THE INTERFERENCE-CAUSING EQUIPMENT STANDARD ENTITLED "DIGITAL APPARATUS," ICES-003 OF THE DEPARTMENT OF COMMUNICATIONS.

Pour le Canada
CET APPAREIL NUMÉRIQUE RESPECTE LES LIMITES DE BRUITS RADIOÉLECTRIQUES APPLICABLES AUX APPAREILS NUMÉRIQUES DE CLASSE B PRÉSCRITES DANS LA NORME SUR LE MATÉRIEL BROUILLEUR; "APPAREILS NUMÉRIQUES", NMB-003 ÉDICTÉE PAR LE MINISTRE DES COMMUNICATIONS.

For U.S.A.
WARNING
TO PREVENT FIRE OR SHOCK HAZARDS, DO NOT EXPOSE THIS APPARATUS TO RAIN OR MOISTURE.

Pour les Etats-Unis
AVERTISSEMENT
POUR PRÉVENIR LES RISQUES D'INCENDIE OU DE CHOCS ÉLECTRIQUES, NE PAS EXPOSER CE APPAREIL À LA PLUIE OU À L'HUMIDITÉ.

For AX-THBS7, SP-THBS7F and SP-THBS7W
This device compiles with RSS-210 of Industry Canada Rules. Operation is subject to the following two conditions: (1) this device may not cause interference, and (2) this device must accept any interference, including interference that may cause undesired operation of the device.

Pour AX-THBS7, SP-THBS7F et SP-THBS7W
Cet appareil est conforme au règlement CNR-210 de l'industrie du Canada. L'utilisation de ce dispositif est autorisée seulement aux conditions suivantes: (1) il ne doit pas produire de brouillage et (2) l'utilisateur du dispositif doit être prêt à accepter tout brouillage radioélectrique reçu, même si ce brouillage est susceptible de compromettre le fonctionnement du dispositif.

CAUTION
Battery shall not be exposed to excessive heat such as sunshine, fire or the like.

ATTENTION
Les piles ne doivent en aucun cas être exposées à une chaleur excessive (lumière du soleil, feu, etc.).

Do not use another AC adaptor to connect this model.
N'utilisez aucun autre ADAPTATEUR SECTEUR pour connecter ce modèle.

For AX-THBS7, SP-THBS7F and SP-THBS7W
This device complies with Part 15 of the FCC Rules. Operation is subject to the following two conditions: (1) This device may not cause harmful interference, and (2) this device must accept any interference received, including interference that may cause undesired operation.
Changes or modifications not expressly approved by the manufacturer for compliance could void the user's authority to operate the equipment.

Pour AX-THBS7, SP-THBS7F et SP-THBS7W
Cet appareil est conforme à la partie 15 des règles de la FCC (Federal Communications Commission). Le fonctionnement est sujet aux deux conditions suivantes : (1) Cet appareil ne peut pas causer d'interférences nuisibles, et (2) cet appareil doit accepter toute interférence reçue, y compris des interférences qui peuvent causer un mauvais fonctionnement.
Tout changement ou modification non expressément approuvés par le fabricant pour conformité peut annuler l'autorité de l'utilisateur d'utiliser l'appareil.

For U.S.A.
Caution: Changes or modifications not expressly approved by party responsible for compliance could void the user's authority to operate the equipment.
Note: This equipment has been tested and found to comply with the limits for a Class B digital device, pursuant to Part 15 of the FCC Rules. These limits are designed to provide reasonable protection against harmful interference in a residential installation. This equipment generates, uses and can radiate radio frequency energy and, if not installed and used in accordance with the instructions, may cause harmful interference to radio communications. However, there is no guarantee that interference will not occur in a particular installation. If this equipment does cause harmful interference to radio or television reception, which can be determined by turning the equipment off and on, the user is encouraged to try to correct the interference by one or more of the following measures:
– Reorient or relocate the receiving antenna.
– Increase the separation between the equipment and receiver.
– Connect the equipment into an outlet on a circuit different from that to which the receiver is connected.
– Consult the dealer or an experienced radio/TV technician for help.

Pour les Etats-Unis
Attention : Les changements ou les modifications qui ne sont pas explicitement approuvés par la partie responsable de l'observance pourraient mettre fin au droit de l'utilisateur d'utiliser le matériel.
Remarque : Cet appareil a été testé et il s'est avéré conforme aux limites applicables à un appareil numérique de classe B, en vertu de la Partie 15 des Règles de la FCC. Ces limites sont conçues de manière à assurer une protection raisonnable contre les interférences nuisibles dans une installation résidentielle. Cet appareil produit, utilise et peut émettre une énergie de haute fréquence et, s'il n'est pas installé et utilisé en conformité avec les instructions, il peut causer des interférences nuisibles aux communications radio. Il n'y a, toutefois, aucune garantie que des interférences ne se produiront pas dans une installation particulière. Si cet appareil cause effectivement des interférences nuisibles à la réception de la radio ou de la télévision, ce qu'on peut établir en mettant l'appareil en marche et à l'arrêt, nous encourageons l'utilisateur à tenter de corriger l'interférence par une ou plusieurs des mesures suivantes :
– réorienter ou déplacer l'antenne de réception ;
– accroître la séparation entre l'appareil et le récepteur ;
– brancher l'appareil dans une prise ou un circuit autre que celui auquel le récepteur est branché ;
– consulter un vendeur ou un technicien radio/TV expérimenté pour obtenir de l'aide.

CAUTION
• Do not block the ventilation openings or holes. (If the ventilation openings or holes are blocked by a newspaper or cloth, etc., the heat may not be able to get out.)
• Do not place any naked flame sources, such as lighted candles, on the apparatus.
• When discarding batteries, environmental problems must be considered and local rules or laws governing the disposal of these batteries must be followed strictly.
• Do not expose this apparatus to rain, moisture, dripping or splashing and that no objects filled with liquids, such as vases, shall be placed on the apparatus.

ATTENTION
• Ne bloquez pas les orifices ou les trous de ventilation. (Si les orifices ou les trous de ventilation sont bloqués par un journal un tissu, etc., la chaleur peut ne pas être évacuée correctement de l'appareil.)
• Ne placez aucune source de flamme nue, telle qu'une bougie, sur l'appareil.
• Lors de la mise au rebut des piles, veuillez prendre en considération les problèmes de l'environnement et suivre strictement les règles et les lois locales sur la mise au rebut des piles.
• N'exposez pas cet appareil à la pluie, à l'humidité, à un égouttement ou à des éclaboussures et ne placez pas des objets remplis de liquide, tels qu'un vase, sur l'appareil.

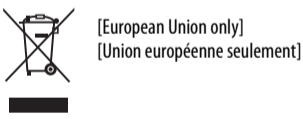
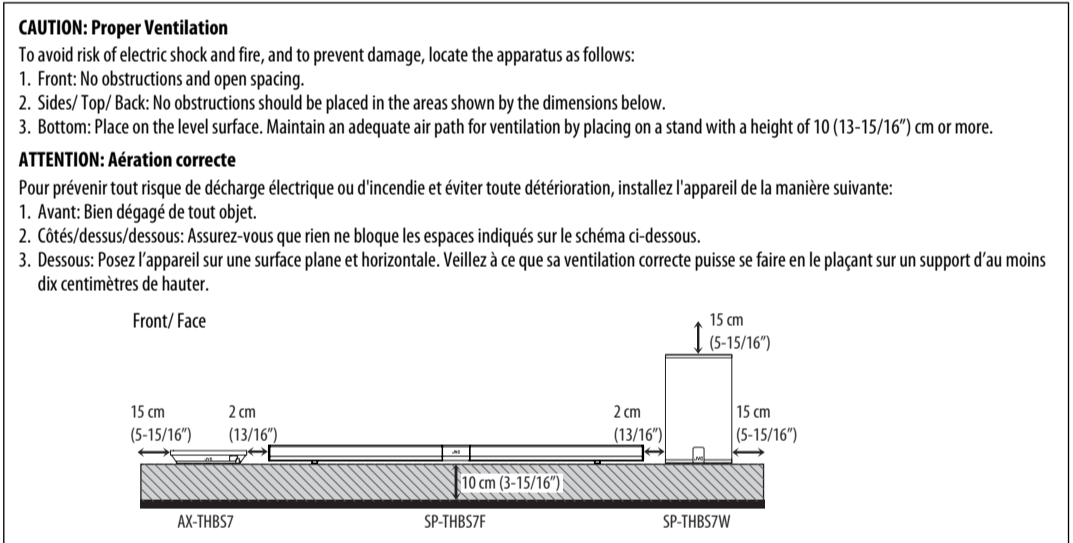

Specifications

Center unit (AX-THBS7)	Impedance:	3 Ω
Audio section	Frequency Range:	45 Hz to 5 kHz
Output power:	Sound Pressure Level:	82 dB/W-m
	Power Requirements:	AC 230 V ~, 50 Hz
	Power Consumption:	30 W (during operation) 0.8 W (in Standby mode)
Analog Input:	Dimensions (W × H × D):	215 mm × 352 mm × 254 mm (8-1/2" × 13-7/8" × 10")
Digital Input*:	Mass:	5 kg (11.1 lbs)
General		
Power Source (DC IN):	DC 19 V = 3.37 A	
AC adaptor (AA-R1902):	Input: AC 110 - 240 V ~, 1.5 A - 0.9 A, 50/60 Hz Output: DC 19 V = 3.37 A	
Dimensions (W × H × D):	186 mm × 31 mm × 300 mm (7-3/8" × 1-1/4" × 11-13/16")	
Mass:	0.73 kg (1.7 lbs)	
	* Corresponding to Linear PCM, Dolby Digital, and DTS (with sampling frequency—32 kHz, 44.1 kHz, 48 kHz)	
Main speakers (SP-THBS7F)		
Type:	1-way Acoustic Suspension Type (Magnetically-shielded Type)	
Speaker unit:	9.5 cm × 1.0 cm (3-3/4" × 3/8") Dome × 4	
Power Handling Capacity:	20 W	
Impedance:	4 Ω	
Frequency Range:	Front speakers: 110 Hz to 40 kHz Center/Surround speakers: 115 Hz to 40 kHz	
Sound Pressure Level:	Front speakers: 78 dB/W-m Center/Surround speakers: 79 dB/W-m	
Dimensions (W × H × D):	900 mm × 36.7 mm × 53 mm (35-7/16" × 1-1/2" × 2-1/8")	
Mass:	1.6 kg (3.6 lbs)	
Powered Subwoofer (SP-THBS7W)		
Output power	100 W, RMS at 3 Ω at 1 kHz, with 10% total harmonic distortion	
Type:	1-way Bass-Reflex Type	
Speaker unit:	16 cm (6-9/16") cone × 1	
Power Handling Capacity:	100 W	

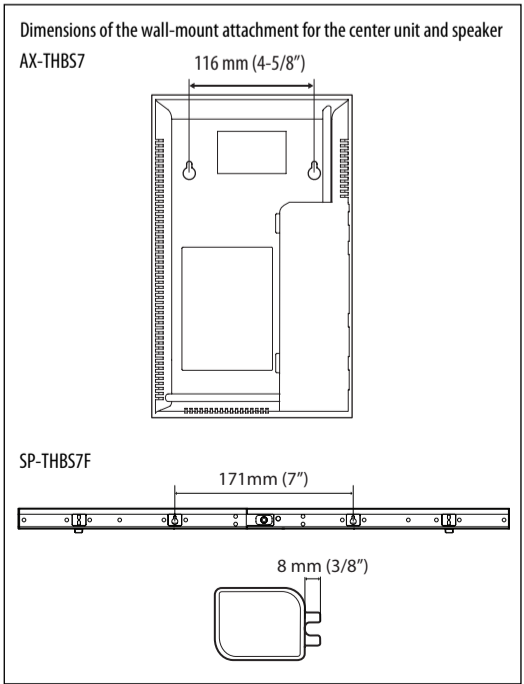

Designs & specifications are subject to change without notice.

• Manufactured under license from Dolby Laboratories. Dolby, and the double-D symbol are trademarks of Dolby Laboratories.
• Manufactured under license under U.S. Patent numbers: 5,451,942; 5,956,674; 5,974,380; 5,978,762; 6,487,535 and other U.S. and worldwide patents issued and pending. DTS and DTS Digital Surround are registered trademarks and the DTS logos and Symbol are trademarks of DTS, Inc. © 1996-2008 DTS, Inc. All Rights Reserved.

DO NOT connect the power cord until all other connections have been made.

Prepare the Remote Control

When you use the remote control for the first time, pull out the insulation sheet.

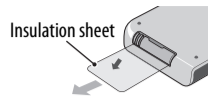

If the range or effectiveness of the remote control decreases, replace the battery.

To Replace the Battery in the Remote Control

Insert the battery into the remote control by matching the polarities (+ and -) correctly.

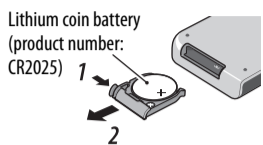

1 Pinch the side of the battery case.

2 Pull out the battery case and insert the battery by matching the polarities.

NOTE

- Store the battery in a place where children cannot reach. If a child accidentally swallows the battery, consult a doctor immediately.
- To prevent the battery from overheating, cracking, or starting a fire:
 - Do not recharge, short, disassemble or heat the battery, or dispose of it in a fire.
 - Do not leave the battery with other metallic materials.
 - Wrap the battery with tape and insulate when throwing away or saving it.
 - Do not poke the battery with tweezers or similar tools.
- Dispose of the battery in the proper manner, according to federal, state, and local regulations.

CAUTION:

Danger of explosion if battery is incorrectly replaced. Replace only with the same or equivalent type.

For USA-California Only

This product contains a CR Coin Cell Lithium Battery which contains Perchlorate material—special handling may apply. See www.dtsc.ca.gov/hazardouswaste/perchlorate

Speaker layout

Install the speakers on a flat and level surface to ensure the best sound quality.

- The sound may be affected depending on the location in which you install them. To improve the sound, adjust the location and orientation of the speakers.
- If you install the speakers near the TV, color distortion may occur. To prevent this, turn off the TV's main power or unplug it before installing the speakers. Wait at least 30 minutes before turning on the TV's main power again. If the TV is still affected, move the speakers further away.

Assembling the speaker

Before you install the speaker, assemble it.

- Take care not to pinch your fingers between the units.

1 Slide the right unit into the left unit.

2 Press the knob on the rear of the right unit.

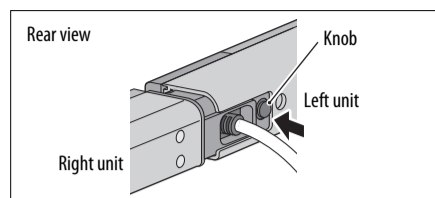

3 Insert the right unit completely until you hear a clicking sound.

- The speaker has projections on the back, between which you can fit the cord to hold it in place out of sight.

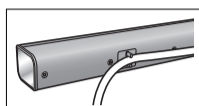

Connecting the speaker cord

Connect the speaker cord to the center unit as illustrated.

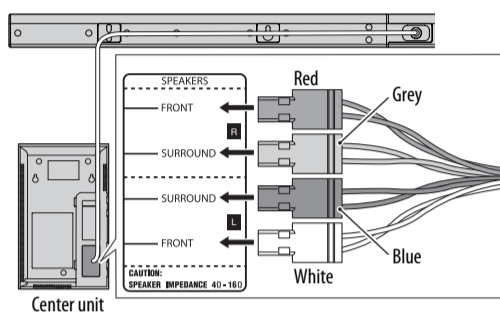

CAUTION

- If you connect any speakers other than those supplied for the System, be sure to use speakers of the same speaker impedance (SPEAKER IMPEDANCE) as that indicated on the rear of the center unit.
- DO NOT connect more than one speaker cord to one speaker terminal.

When installing on the floor

Attach the supplied foot to the speaker as illustrated below.

- You can choose the foot type—flat type (× 5) or slanted type (× 2).

Peel off the release paper and attach the feet to the bottom of the speaker.

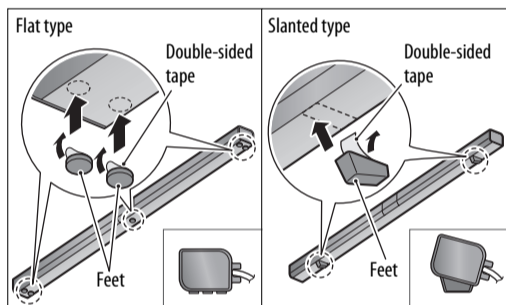

When installing on the wall

You can install the center unit and speaker on the wall.

Ex.: Speaker

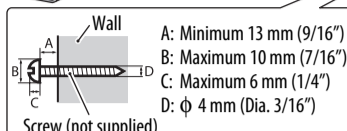
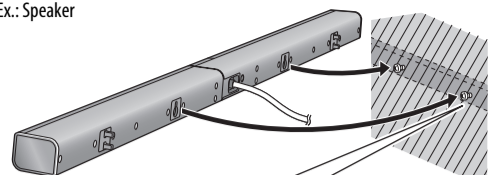

For installing the center unit

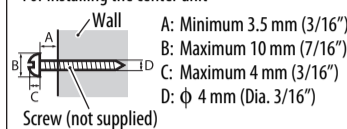

CAUTION

- The center unit weighs approximately 0.73 kg (1.7 lbs) and speaker weighs approximately 1.6 kg (3.6 lbs). Sufficient care must be taken when installing it on the wall to prevent any accidents caused by its falling off.
- Use screws which are compatible with the strength and material of the pillar or wall to prevent the units from falling off.
- Do not install the center unit and speaker onto a plywood or plasterboard wall; otherwise, they will fall and sustain damage.
- When installing the center unit and speaker on the wall;
 - Be sure to have them installed on the wall by qualified personnel.
 - Care must be taken when selecting a location for installation on the wall. Injury to personnel or damage to equipment may result if the installed unit interfere with daily activities.
 - AC adaptor should not be hanging/put above of any other items. It is acceptable to place the AC adaptor on the flat floor only.
 - Recommended mounting surface: Wooden studs. If the mount is to be installed on any surface other than wooden studs, use suitable hardware (which is commercially available).

Connecting external components

You can connect an analog component to the ANALOG IN terminal and digital components to the OPTICAL DIGITAL IN terminals.

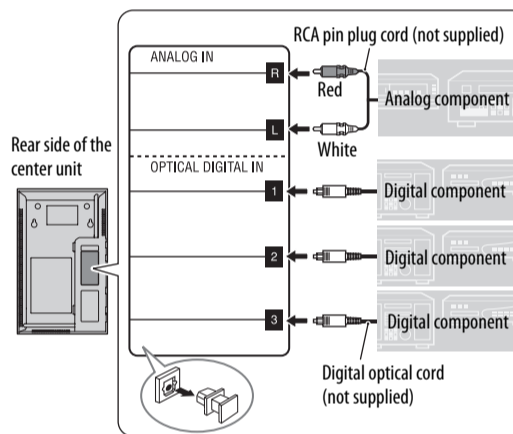

Connecting the power cord

- Connect the supplied AC adaptor to the DC IN jack on the center unit. Then connect the supplied AC power cord to the AC adaptor, and plug it in a wall outlet.
- Plug in the power cord of the subwoofer to a wall outlet.

NOTE

- Disconnect the power cord before cleaning or moving the speakers.

Setting up the subwoofer

This System is equipped with a wireless subwoofer. When you use it for the first time, activate the wireless pairing. Refer to the supplied information sheet—"Activate wireless pairing."

NOTE

- The wireless pairing is not canceled even after the power cord has been pulled out.

Using the core filter

Attach the provided core filters to the power cord and the external components cord, then the core filters reduce interference.

1 Release the stopper of the core filter.



2 Run the cord through the core filter, and wind the cord firmly once inside the cutout of the core filter as shown in the illustration.

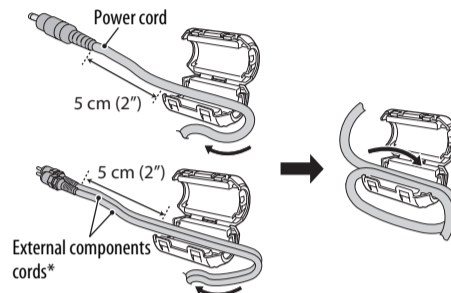

* You can wind 2 external components cords together.

3 Close the core filter until it clicks shut.

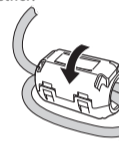

CAUTION

- Do not damage the cord by applying excessive force when winding.

Selecting the display setting

You can install the center unit vertically or horizontally.

On the front panel, two sets of button names are equipped. Select the appropriate set of button names to illuminate according to your installation method.

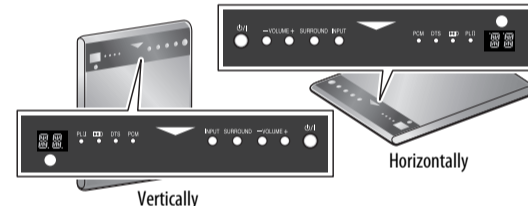

Press DISPLAY SETTING to select between the two sets.

Operations



Basic operation

Turning on/off the power

Press $\odot/1$.

- You can also use the power button on the front panel.

NOTE

- The subwoofer is also turned on/off.
- A small amount of power is consumed even when the power is turned off (standby mode). During standby mode, the $\odot/1$ symbol on the front panel lights red. Unplug the power cord from the wall outlet to turn the power off completely.
- You can also turn on the System by pressing one of the input buttons (DIGITAL 1, DIGITAL 2, DIGITAL 3 or ANALOG).

Selecting the input source

Press one of the input buttons: DIGITAL 1, DIGITAL 2, DIGITAL 3 or ANALOG.

D1 (DIGITAL 1), D2 (DIGITAL 2), D3 (DIGITAL 3) or AN (ANALOG) appears on the display.

- You can also use the input button on the front panel.

Adjusting the volume

Press VOL +/- (0 to 40).

- You can also use the volume buttons on the front panel.

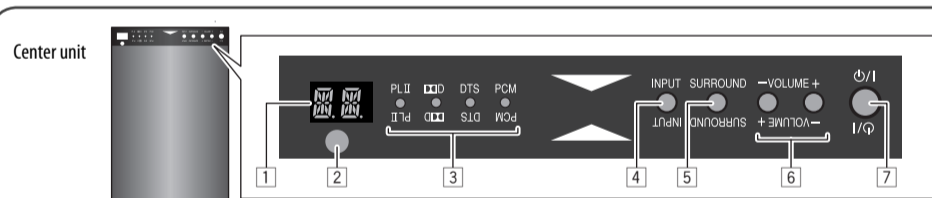

Buttons and lamps on the front panel

- Display**
Shows the volume level, selected input source, surround mode, etc.
- Remote sensor**
Receives the signal from the remote control.
- Audio signal format lamps**
Shows the audio signal format of the incoming signal. Each lamp lights when;
 - PL II (DOLBY PROLOGIC II):
 - Surround is activated with an analog input source selected.
 - Surround is activated and a digital input source with 2 channel audio format is selected.
 - D1: A Dolby Digital signal comes in.
 - D2: A DTS signal comes in.
 - PCM: A Linear PCM signal comes in.
- Input button**
Selects an input source: "DIGITAL 1," "DIGITAL 2," "DIGITAL 3" or "ANALOG."
- SURROUND button**
Selects a surround mode: "SURROUND 1," "SURROUND 2" or SURROUND OFF.
- Volume buttons**
Adjusts the volume within the range of 0 to 40.
- $\odot/1$ (power) button**
Turns on/off the System.
 - The $\odot/1$ symbol lights red while the System is turned off.

CAUTION

- Set the volume to the minimum level before starting any source. If the volume is set to a high level, the sudden blast of sound may damage your hearing and blow out the speakers.

Turning off the sound temporarily

Press FADE MUTING.

- To restore the sound, press the button again or adjust the volume.

Making sound clearer (only for Dolby Digital and DTS)

You can enjoy low level recorded sound clearly even at a low volume level—Dynamic Range Compression. It has two setting levels.

Press DRC.

- Each time you press the button, the effect changes as follows: OF (off) \Rightarrow MD (middle) \Rightarrow MX (maximum).

Changing the display brightness

Press DIMMER.

- Each time you press the button, the LED brightness changes as follows: normal \Rightarrow dim \Rightarrow off.

Adjusting the output level

You can adjust the output level within the range of -6 dB to +6 dB.

Press SPEAKER LEVEL +/- corresponding.

- SUBWOOFER: Adjusts the output level of the subwoofer.
- CENTER: Adjusts the output level of the center channel signal.
- SURROUND: Adjusts the output level of the front surround channel signal.

Using the surround mode

You can listen to a more realistic sound than stereo sound by using surround. Available surround modes are as follows:

- surround 1: Suitable for the reproduction of multi-channel sources.
- surround 2: Suitable for the reproduction of any stereo music sources.

Press SURROUND MODE.

- Each time you press the button, the surround mode changes as follows: surround 1 (S1 appears on the display when selected) \Rightarrow surround 2 (S2) \Rightarrow off (OF).

Troubleshooting

If you have a problem with this System, check this list for a possible solution before calling for service.

POWER

Power does not come on.

- The power cord is not inserted securely. Plug it in securely.

REMOTE CONTROL

The remote control does not work.

- The battery is exhausted. Replace the battery.
- Sunlight is shining directly on the remote sensor. Hide the remote sensor from direct sunlight.
- The path between the remote control and the remote sensor on the front panel is blocked.
- Point the remote control at the remote sensor on the front panel.
- Signals cannot reach the remote sensor. Move closer to the center unit.
- Pull out the insulation sheet.
- The display setting is different from the installation method. Change the setting.

SOUND

Sounds are sometimes interrupted.

- The radio wave connection between the center unit and subwoofer may be interrupted. Change the location and orientation of the speakers.

No sound from speakers.

- The sound has been turned off temporarily. Press FADE MUTING on the remote control or adjust the volume.
- The speaker cables are not connected correctly or are loose. Check the connections.

No sound from the subwoofer.

- The wireless connections have not been activated correctly. Check the connection.

Radio wave reflections

The subwoofer is connected directly by radio waves which are reflected by walls, furniture and buildings. If the subwoofer cannot receive the waves properly, move the subwoofer to obtain better reception. Radio wave reception may also be interrupted by people moving between the units.

Free Manuals Download Website

<http://myh66.com>

<http://usermanuals.us>

<http://www.somanuals.com>

<http://www.4manuals.cc>

<http://www.manual-lib.com>

<http://www.404manual.com>

<http://www.luxmanual.com>

<http://aubethermostatmanual.com>

Golf course search by state

<http://golfingnear.com>

Email search by domain

<http://emailbydomain.com>

Auto manuals search

<http://auto.somanuals.com>

TV manuals search

<http://tv.somanuals.com>