

JVC

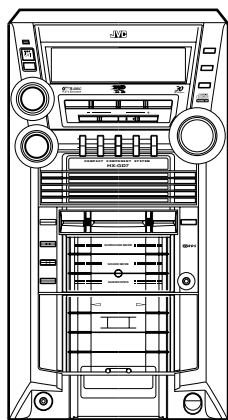

COMPACT COMPONENT SYSTEM

CA-HXGD7 CA-HXGD8



CA-HXGD7

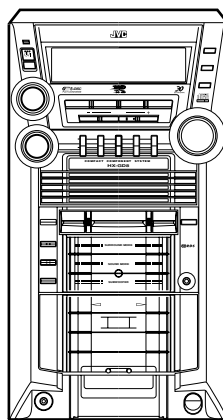

CA-HXGD8



AV COMPU LINK

INSTRUCTIONS

Warnings, Cautions and Others

IMPORTANT for the U.K.

DO NOT cut off the mains plug from this equipment. If the plug fitted is not suitable for the power points in your home or the cable is too short to reach a power point, then obtain an appropriate safety approved extension lead or consult your dealer.

BE SURE to replace the fuse only with an identical approved type, as originally fitted.

If nonetheless the mains plug is cut off ensure to remove the fuse and dispose of the plug immediately, to avoid a possible shock hazard by inadvertent connection to the mains supply.

If this product is not supplied fitted with a mains plug then follow the instructions given below:

IMPORTANT:

DO NOT make any connection to the terminal which is marked with the letter E or by the safety earth symbol or coloured green or green-and-yellow.

The wires in the mains lead on this product are coloured in accordance with the following code:

Blue : Neutral
Brown : Live

As these colours may not correspond with the coloured markings identifying the terminals in your plug proceed as follows:

The wire which is coloured blue must be connected to the terminal which is marked with the letter N or coloured black.

The wire which is coloured brown must be connected to the terminal which is marked with the letter L or coloured red.

IF IN DOUBT - CONSULT A COMPETENT ELECTRICIAN.

CAUTION— \odot /I **STANDBY/ON** button!

Disconnect the mains plug to shut the power off completely. The \odot /I (STANDBY/ON) button in any position does not disconnect the mains line. The power can be remote controlled.

CAUTION

To reduce the risk of electrical shocks, fire, etc.:

1. Do not remove screws, covers or cabinet.
2. Do not expose this appliance to rain or moisture.

IMPORTANT FOR LASER PRODUCTS

1. CLASS 1 LASER PRODUCT
2. **CAUTION:** Do not open the top cover. There are no user serviceable parts inside the unit; leave all servicing to qualified service personnel.
3. **CAUTION:** Visible and invisible laser radiation when open and interlock failed or defeated. Avoid direct exposure to beam.
4. **REPRODUCTION OF LABEL: CAUTION LABEL, PLACED INSIDE THE UNIT.**

CAUTION : Visible and invisible laser radiation when open and interlock failed or defeated. AVOID DIRECT EXPOSURE TO BEAM.	ADVARSEL : Synlig og usynlig laserstråling når maskinen er åben eller interlocken fejler. Undgå direkte eksponering til stråling.	WARNING : Synlig och osynlig laserstråling när den öppnas och spärren är urkopplad. Beträkta ej strålen.	VARO : Avattassa ja suojalukitus ohitettuna tai virallisena oletuksena näkyvä ja näkymättömälle lasersäteilylle. Vältä silmien kohdistamista suoraan lähteeseen.
---	--	---	---

CAUTION

- Do not block the ventilation openings or holes. (If the ventilation openings or holes are blocked by a newspaper or cloth, etc., the heat may not be able to get out.)
- Do not place any naked flame sources, such as lighted candles, on the apparatus.
- When discarding batteries, environmental problems must be considered and local rules or laws governing the disposal of these batteries must be followed strictly.
- Do not expose this apparatus to rain, moisture, dripping or splashing and that no objects filled with liquids, such as vases, shall be placed on the apparatus.

Caution: Proper Ventilation

To avoid risk of electric shock and fire, and to prevent damage, locate the apparatus as follows:

1. Front: No obstructions and open spacing.
2. Sides/ Top/ Back: No obstructions should be placed in the areas shown by the dimensions below.
3. Bottom: Place on the level surface. Maintain an adequate air path for ventilation by placing on a stand with a height of 10 cm or more.

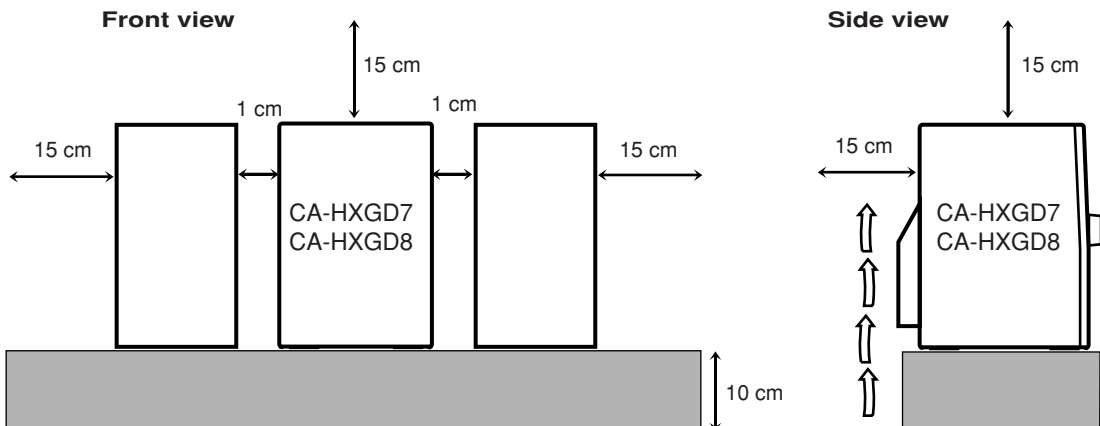

Contents

Introduction	2	Advanced Disc Operations	28
Precautions	2	Programming the Playing Order—Program Play.....	28
How to Read This Manual	2	Playing at Random—Random Play.....	29
Getting Started	3	Playing Repeatedly.....	30
Step 1: Unpack	3	Prohibiting Disc Ejection—Child Lock	30
Step 2: Prepare the Remote Control	3	On-Screen Disc Operations	31
Step 3: Hook Up	4	About the On-screen Bar.....	31
Selecting the Video Signal	7	Operations Using the On-screen Bar.....	32
Before Operating the System	8	Operations on the CONTROL Screen.....	34
Playable Disc Types	8	Advanced Tape Operations	36
Parts Index.....	9	Recording on a Tape	36
About the Display Indication	10	Synchronized Disc Recording.....	37
Daily Operations—Playback	12	Timer Operations	38
Canceling the Demonstration	12	Setting the Timer.....	38
Listening to the Radio	13	Timer Priority.....	39
Playing Back a Disc	14	Set up Menu Operations	40
Playing Back a Tape.....	16	Operating Procedure.....	40
Daily Operations—Sound&Other Adjustments	17	■ LANGUAGE Set up Menu	41
Adjusting the Volume	17	■ PICTURE Set up Menu	41
Reinforcing the Bass Sound.....	17	■ AUDIO Set up Menu	42
Selecting the Sound Modes	18	■ OTHERS Set up Menu	43
Creating Your Own Sound Modes—User Mode	18	Restricting the Review—Parental Lock.....	44
Selecting 3D PHONIC Mode.....	19	Operating the TV	46
Presetting Automatic DVD Video		Operating TV.....	46
Sound Increase Level	19	Additional Information	47
Changing the Scanning Mode	19	Learning More about This System.....	47
Changing the Picture Tone	19	Troubleshooting	50
Turning On or Off the Key-Touch Tone	20	Maintenance	51
Changing the Display Brightness.....	20	Language Code List	52
Saving the Power Consumption		Country/Area codes list for Parental Lock.....	53
while on Standby (Ecology Mode).....	20	OPTICAL DIGITAL OUTPUT Signals	54
Setting the Clock	21	Specifications	55
Turning Off the Power Automatically	21		
Advanced Radio Operations	22		
Receiving FM Stations with RDS	22		
Searching for a Program by PTY Codes	22		
Switching Temporarily to a Program Type of			
Your Choice Automatically.....	23		
Unique DVD/VCD Operations	25		
Selecting the Sound Track.....	25		
Selecting the Subtitle Language.....	26		
Selecting a View Angle.....	26		
Selecting a Still Pictures on a DVD Audio	26		
Playing Back a Bonus Group on a DVD Audio.....	27		
Special Picture Playback	27		

Introduction

Precautions

Installation

- Install in a place which is level, dry and neither too hot nor too cold—between 5°C and 35°C.
- Install the System in a location with adequate ventilation to prevent internal heat buildup in the System.



DO NOT install the System in a location near heat sources, or in a place subject to direct sunlight, excessive dust or vibration.

- Leave sufficient distance between the System and the TV.
- Keep the speakers away from the TV to avoid interference with TV.

Power sources

- When unplugging the System from the wall outlet, always pull on the plug, not the AC power cord.



DO NOT handle the AC power cord with wet hands.

Moisture condensation

Moisture may condense on the lenses inside the System in the following cases:

- After starting to heat the room
 - In a damp room
 - If the System is brought directly from a cold to a warm place
- Should this occur, the System may malfunction. In this case, leave the System turned on for a few hours until the moisture evaporates, unplug the AC power cord, then plug it in again.

Internal heat

- A cooling fan is mounted on the rear panel to prevent heat buildup inside the unit.



For safety, observe the following carefully:

- Make sure there is good ventilation around the unit. Poor ventilation could overheat and damage the unit.
- DO NOT block the cooling fan and the ventilation openings or holes. If they are blocked by a newspaper or cloth, etc., the heat may not be able to get out.

Others

- Should any metallic object or liquid fall into the System, unplug the AC power cord and consult your dealer before operating any further.



DO NOT disassemble the System since there are no user serviceable parts inside.

- If you are not going to operate the System for an extended period of time, unplug the AC power cord from the wall outlet.

If anything goes wrong, unplug the AC power cord and consult your dealer.

How to Read This Manual

To make the explanations in this manual as simple and easy-to-understand as possible, we have adapted the following methods:

- Button and control operations are explained as listed in the table below. In this manual, the operations using the remote control is mainly explained; however, you can use the buttons and controls on the main unit if they have the same (or similar) name and marks.
- **Some related tips and notes are explained later in the sections “Learning More about This System” and “Troubleshooting,” but not in the same section explaining the operations (INFO indicates that the content has some informations).** If you want to know more about the functions, or if you have a doubt about the function, go to these sections and you will find your answer there.

	Indicates that you press the button briefly .
	Indicates that you press the button briefly and repeatedly until an option you want is selected.
	Indicates that you press one of the buttons.
	Indicates that you press and hold the button for a specified period. <ul style="list-style-type: none"> • The number inside the arrow indicates the period of press (in this example, 2 seconds). • If no number is inside the arrow, press and hold until the entire procedure is complete or until you get a result you want.
	Indicates that you turn the control toward the specified direction(s).

	Indicates that this operation is only possible using the remote control.
	Indicates that this operation is only possible using the buttons and controls on the main unit.

Getting Started

Step 1: Unpack the package and check the accessories.



Step 1: Unpack

After unpacking, check to be sure that you have all the following items. The number in parentheses indicates the quantity of each piece supplied.

- FM antenna (1)
- AM loop antenna (1)
- Remote control (1)
- Batteries (2)
- Core filter (1)

If any item is missing, consult your dealer immediately.

Step 2: Prepare the Remote Control

Insert the batteries into the remote control by matching the polarity (+ and -) correctly.

Step 2: Prepare the remote control.

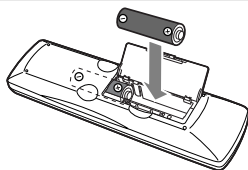

1

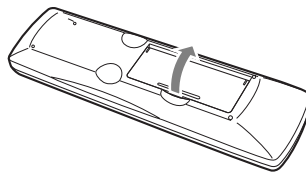

2

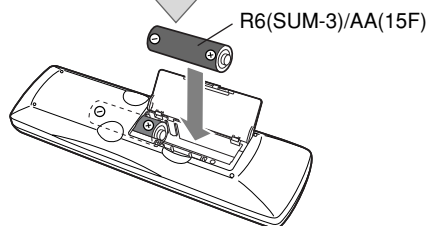

3

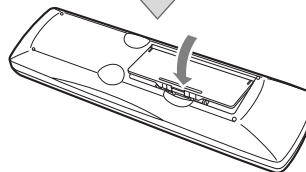

Step 3: Hook up the components such as AM/FM antennas, speakers, etc. (see pages 4 to 7).

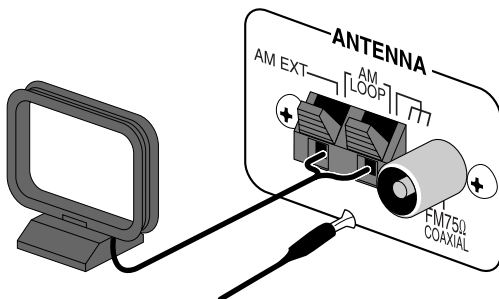

Finally plug the AC power cord.
Now you can operate this System.

- DO NOT use an old battery together with a new one.
- DO NOT use different types of batteries together.
- DO NOT expose batteries to heat or flame.
- DO NOT leave the batteries in the battery compartment when you are not going to use the remote control for an extended period of time. Otherwise, the remote control will be damaged from battery leakage.



Step 3: Hook Up

If you need more detailed information, see page 6.

Turn the power off to all components before connections.

Illustrations of the input/output terminals below are typical examples. When you connect other components, refer also to their manuals since the terminal names actually printed on the rear may vary.

AM loop antenna (supplied)

Turn it until the best reception is obtained.

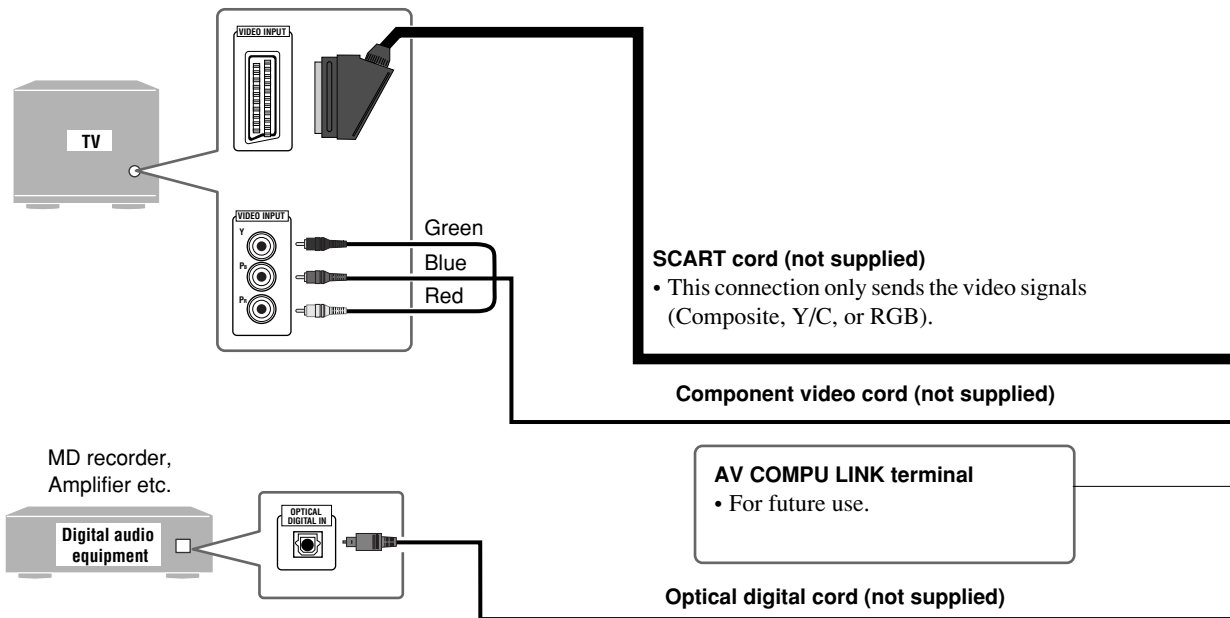
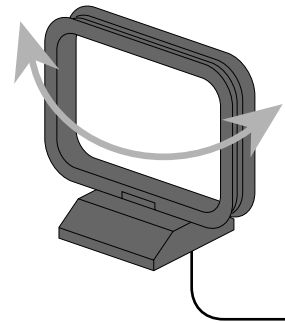

SCART cord (not supplied)

- This connection only sends the video signals (Composite, Y/C, or RGB).

Component video cord (not supplied)

AV COMPU LINK terminal

- For future use.

Optical digital cord (not supplied)

To a wall outlet
Plug the AC power cord only after all connections are complete.

For better FM/AM reception

Outdoor FM antenna (not supplied)

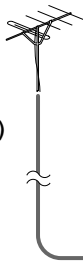

AM loop antenna
Keep it connected.



Vinyl-covered wire (not supplied)

Extend it horizontally.

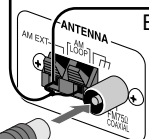

Disconnect the supplied FM antenna, and connect to an outdoor FM antenna using a 75 Ω wire with coaxial type connector (IEC or DIN45325).

* This illustration uses SP-HXGD7 as speakers.

FM antenna (supplied)

Extend it so that you can obtain the best reception.

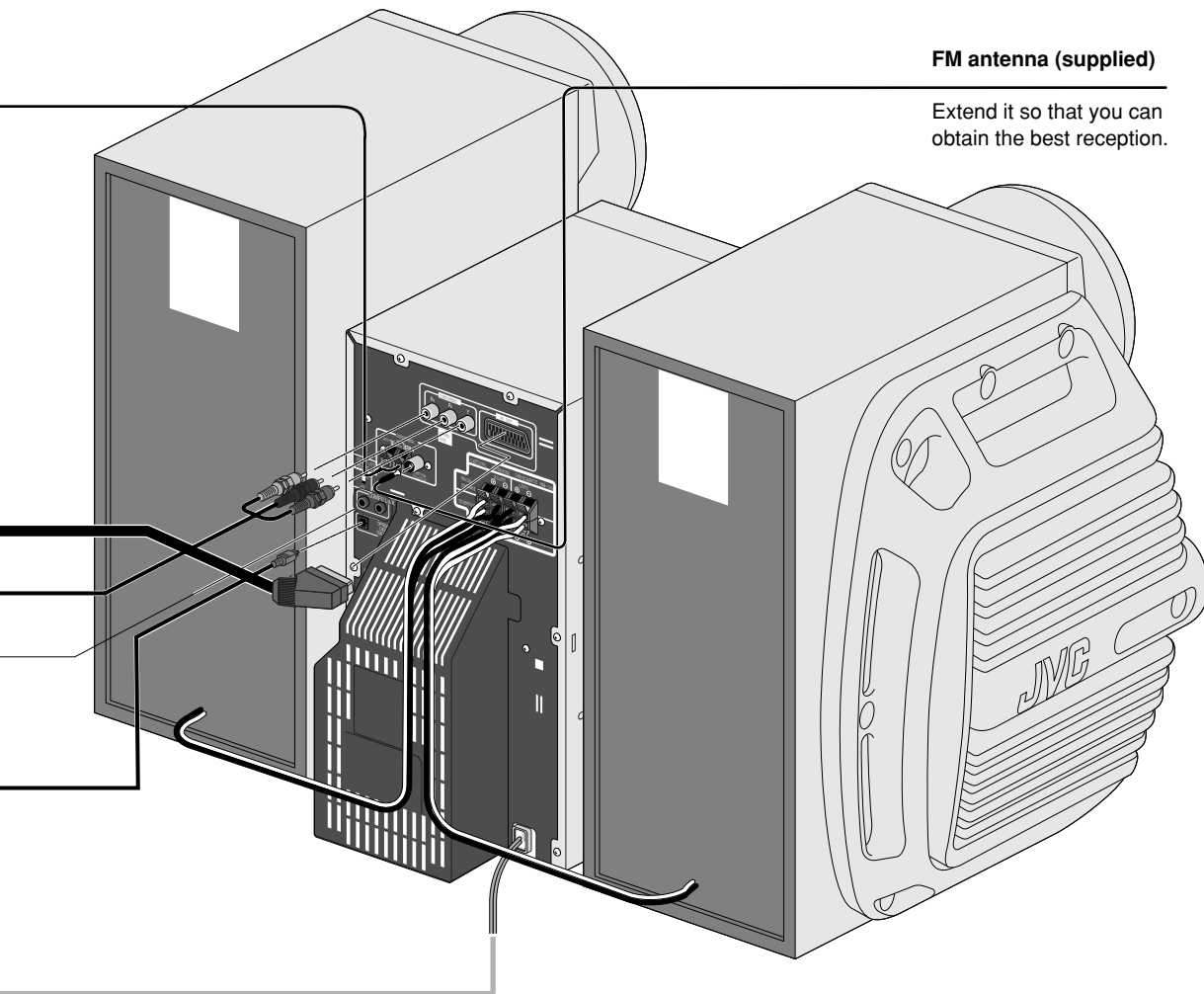

To assemble and connect the AM loop antenna

To assemble the AM loop antenna

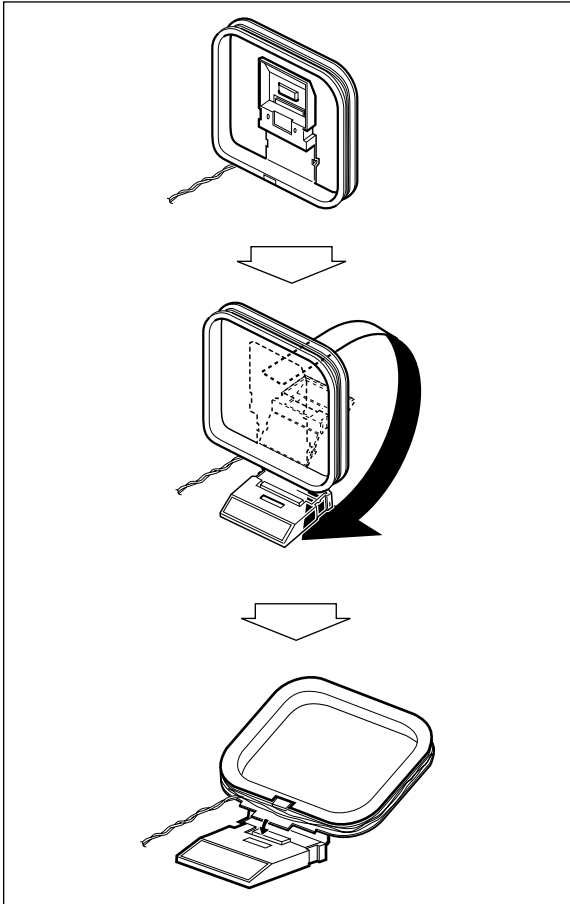

To connect the AM loop antenna cords

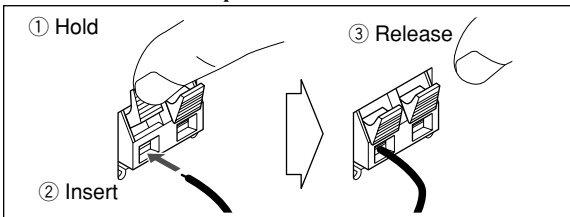

- If the AM loop antenna wire or speaker cords are covered with vinyl, remove the vinyl to expose the tip of the antenna by twisting the vinyl.
- Make sure the antenna conductors do not touch any other terminals, connecting cords and power cord. Also, keep the antennas away from metallic parts of the System, connecting cords, and the AC power cord. This could cause poor condition.

To connect the speaker cords

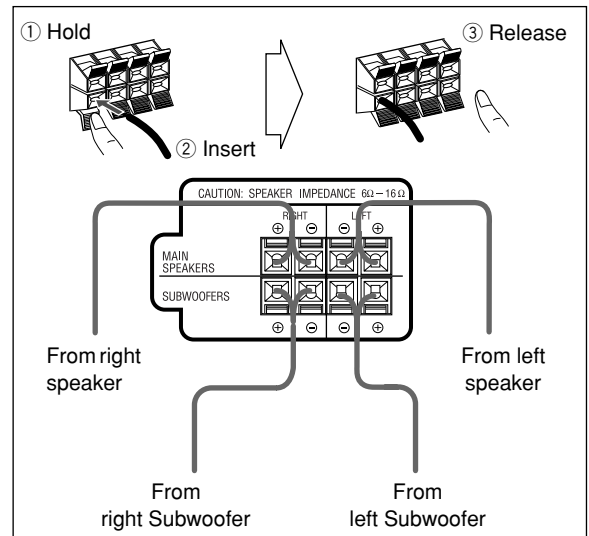

- When connecting the speaker cords, match the polarity of the speaker terminals: (+) to (+) and (-) to (-).

Speaker	Terminal color	
	(+)	(-)
Main speakers	Blue	Black
Subwoofers	Red	Black

- Use only speakers with the same speaker impedance as indicated by the speaker terminals on the rear of the unit.



- DO NOT connect more than one speaker to each terminal.
- DO NOT push or pull the speakers as this will damage the foot spacers at the bottom of the speakers.



To connect digital audio

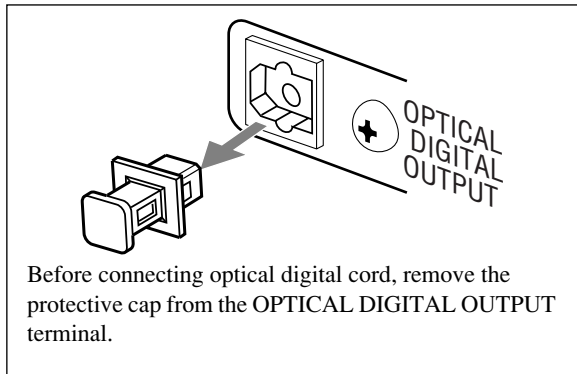

To connect other equipment

By using an stereo mini plug cord (not supplied), you can connect equipment with analog audio output jacks such as an MD player, a TV, etc.

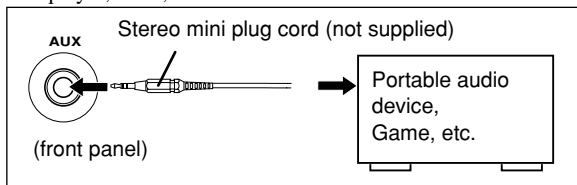

If the audio output on the other equipment is not stereo mini plug type, use a plug adapter to convert the stereo mini plug to the corresponding plug of the audio output.

IMPORTANT

Always set volume to MIN when connecting or disconnecting the other equipment.



DO NOT plug in any equipment until all connections are complete.

Selecting the Video Signal

When connecting a TV, you can use either one of the video output terminals—COMPONENT or AV OUT.

After connecting the TV, set the video signal type correctly for your TV.

- Make sure the unit is not yet turned on. If it is already turned on, turn off then on again so that the selector setting becomes active.

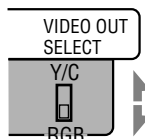

Y/C Select for sending S-Video signals through the AV OUT terminal or for sending component video signals through the COMPONENT jacks.

RGB Select for sending the composite video signals or RGB signals through the AV OUT terminal.

Before Operating the System

Playable Disc Types

This unit has been designed to play back the following discs:

Disc Type	Mark (Logo)
DVD Video	
DVD Audio	
Video CD (VCD)	 Video CD
Super Video CD (SVCD)	 
Audio CD	
CD-R	The System can play back CD-R or CD-RW recorded in the Audio CD, Video CD, SVCD, MP3, WMA, and JPEG formats.
CD-RW	
DVD-R	The System can play back DVD-R or DVD-RW recorded in the video format.
DVD-RW	

In addition to the above discs, this system can play back audio data recorded on CD Text, CD-G (CD Graphics), and CD-Extra.

- The following discs cannot be played back: DVD-ROM, DVD-RAM, DVD+R, DVD+RW, CD-I (CD-I Ready), CD-ROM, Photo CD, etc. Playing back these discs will generate noise and damage the speakers.
- In this manual, “file” and “track” are interchangeably used for MP3/WMA/JPEG operations.

Note on Region Code

DVD players and DVDs have their own Region Code numbers. This unit can play back only DVDs recorded with the PAL color system whose Region Code numbers include “2.”

EX.:



If a DVD with the improper Region Code numbers is loaded, “REGION ERR” appears on the display and playback will not start.

Audio formats

The System can play back the following digital audio formats.

- LPCM (Linear PCM)
- DIGITAL (Dolby Digital)
- DTS (Digital Theater Systems)
- MPEG (MPEG Multichannel)
- MLP (Meridian Lossless Packing)

When playing a multi-channel encoded DVD, the System properly converts these multi-channel signals into 2 channels, and emits the downmixed sound from the speakers.

To enjoy the powerful sound of these multi-channel encoded DVDs, connect a proper decoder or an amplifier with a proper built-in decoder to the OPTICAL DIGITAL OUTPUT terminal on the rear.

IMPORTANT: Before playing a disc, make sure of the following...

- Turn on the TV and select an appropriate input mode on the TV to view the pictures or on-screen displays on the TV screen.
- For disc playback, you can change the initial setting to your preference. See “Set up Menu Operations” on page 40.

If “” appears on the TV screen when you press a button, the disc cannot accept the operation you have tried to do, or data required for that operation is not recorded on the disc.

- Manufactured under license from Dolby Laboratories. “Dolby”, “Pro Logic”, “MLP Lossless”, and the double-D symbol are trademarks of Dolby Laboratories.
- “DTS” and “DTS 2.0+DIGITAL OUT” are trademarks of Digital Theater Systems, Inc.

This product incorporates copyright protection technology that is protected by method claims of certain U.S. patents and other intellectual property rights owned by Macrovision Corporation and other rights owners. Use of this copyright protection technology must be authorized by Macrovision Corporation, and is intended for home and other limited viewing uses only unless otherwise authorized by Macrovision Corporation. Reverse engineering or disassembly is prohibited.

“CONSUMERS SHOULD NOTE THAT NOT ALL HIGH DEFINITION TELEVISION SETS ARE FULLY COMPATIBLE WITH THIS PRODUCT AND MAY CAUSE ARTIFACTS TO BE DISPLAYED IN THE PICTURE. IN CASE OF 525 OR 625 PROGRESSIVE SCAN PICTURE PROBLEMS, IT IS RECOMMENDED THAT THE USER SWITCH THE CONNECTION TO THE ‘STANDARD DEFINITION’ OUTPUT. IF THERE ARE QUESTIONS REGARDING OUR TV SET COMPATIBILITY WITH THIS MODEL 525p AND 625p DVD PLAYER, PLEASE CONTACT OUR CUSTOMER SERVICE CENTER.”

Parts Index

Refer to the pages to see how to use the buttons and controls.

Remote control

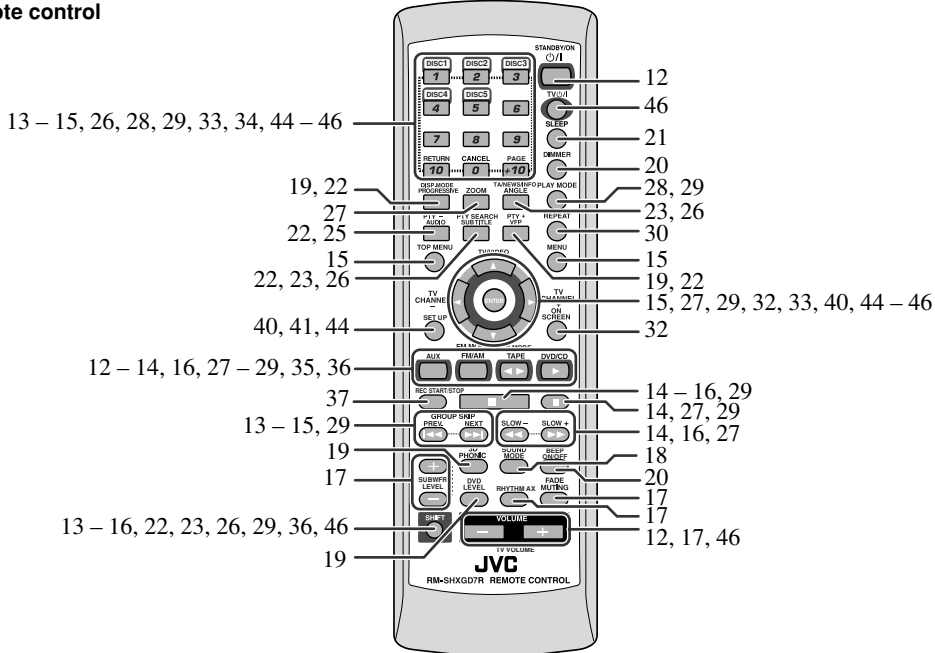

Main unit

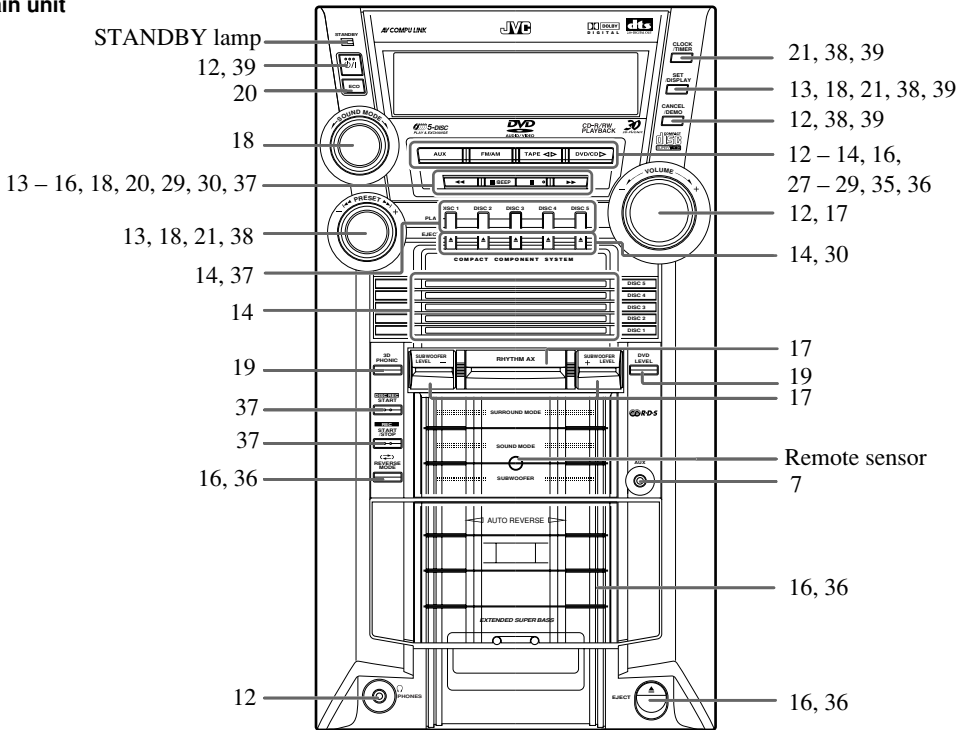

About the Display Indication

The indications on the display teach you a lot of things while you are operating the System.

Before operating the System, be familiar with when and how the indicator illuminates on the display.

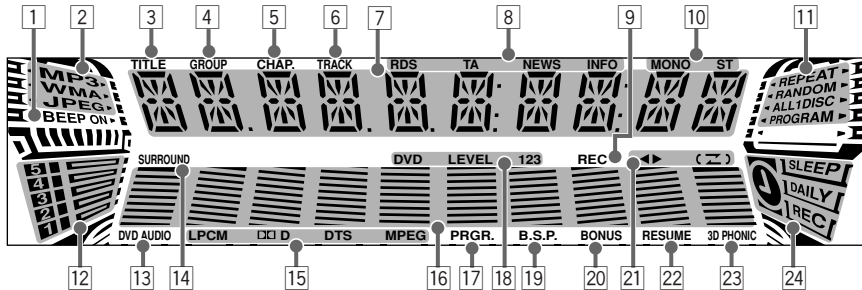

Indications on the main display

- While listening to radio:



- While selecting "TAPE" or "AUX IN":

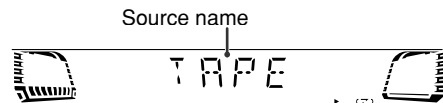

- While playing a disc:

DVD Video:

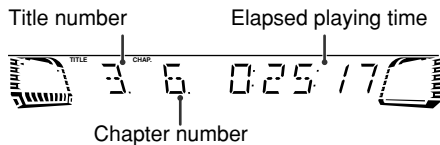

- While disc play is stopped:

DVD Video:

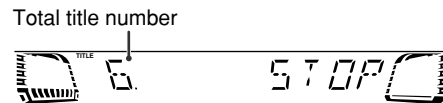

DVD Audio:

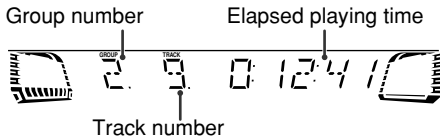

DVD Audio:



SVCD/VCD/CD:

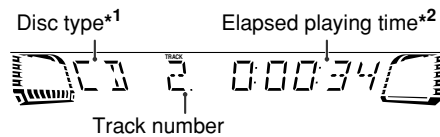

SVCD/VCD/CD:

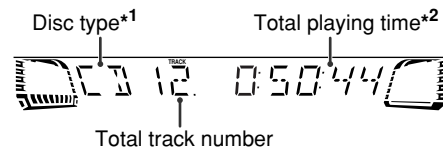

MP3*3/WMA*3/JPEG:

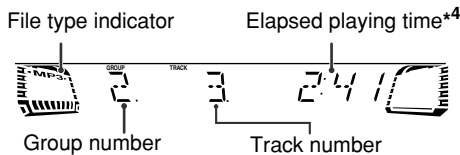

MP3/WMA/JPEG:

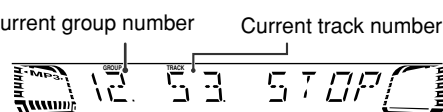







*1 Disc type is displayed with the following abbreviation: "SV (SVCD)", "VD (VCD)", "CD (CD)".

*2 While activating PBC function, "PBC" appears on the display instead of the playing time.

*3 When you start playing an MP3/WMA track, the track name (and ID3 Tag) will be shown before the elapsed playing time appears.

*4 While playing back a JPEG disc, "JPEG" appears on the display instead of the elapsed playing time.

- 1 BEEP ON indicator
- Lights when key-touch tone is activated.
- 2 File type indicators
- MP3: lights while playing back an MP3 track.
 - WMA: lights while playing back a WMA track.
 - JPEG: lights while playing back a JPEG file.
- 3 TITLE indicator
- Lights to indicate the title number when the source is DVD Video.
 - Lights to indicate the group title or track title when the source is an MP3/WMA disc.
- 4 GROUP indicator
- Lights to indicate the group number when the source is DVD Audio or MP3/WMA disc.
- 5 CHAP. indicator
- Lights to indicate the chapter number when the source is DVD Video.
- 6 TRACK indicator
- Lights to indicate the track number when the source is a disc (except for DVD Video).
- 7 Main display
- 8 RDS (Radio Data System) indicators
- RDS: lights when an FM station sending RDS signals is tuned in.
 - TA/NEWS/INFO—Program type (PTY) indicator:
 - Lights to indicate the currently selected program type for PTY Standby Reception.
 - Flashes when a program is automatically tuned in with PTY Standby Reception.
- 9 REC indicator
- Flashes while recording.
- 10 FM reception indicators
- MONO: lights while receiving an FM stereo station in monaural.
 - ST (stereo): lights while an FM stereo station with sufficient signal strength is tuned in.
- 11 Disc operation indicators
- REPEAT: lights when Repeat Play mode is activated.
 - RANDOM: lights when Random Play is activated.
 - ALL 1 DISC:
 - ALL: lights when All Disc Repeat is activated.
 - 1: lights when One Track/Chapter/Step Repeat is activated.
 - 1 DISC: lights when One Disc Repeat is activated.
 - PROGRAM: lights when Program Play mode is activated.
- 12 Disc indicators
- Each indicator shows the status of a disc placed on each corresponding disc tray (DISC1 – DISC5).
 - Lights up when a disc is loaded.
 - Goes off when the unit detects there is no disc loaded on the disc tray.
- 13 DVD AUDIO indicator
- Lights when DVD Audio is detected.
- 14 SURROUND indicator
- Lights when the Surround mode is activated.
- 15 Source signal indicators
- LPCM: lights when a source signal is linear PCM.
 -  D: lights when a source signal is Dolby Digital.
 - DTS: lights when a source signal is DTS Surround.
 - MPEG: lights when a source signal is MPEG multichannel.
- 16 Audio level indicator
- 17 PRGR. indicator
- Lights when the progressive scanning mode is selected.
- 18 DVD LEVEL 123 indicators
- Lights when the DVD Video is detected.
- 19 B.S.P. indicator
- Lights when browsable still picture on DVD Audio is available (see page 26).
- 20 BONUS indicator
- Lights when DVD Audio with bonus group is detected (see page 27).
- 21 Tape operation indicators
-  (tape direction):
 - Lights to indicate the current tape running direction.
 - Flashes slowly during playback and recording.
 - Flashes quickly while rewinding a tape.
 - Flashes intermittently while locating the beginning of a recording.
 -  (reverse mode):
 - : tape play continues endlessly.
 - : tape play stops at the end of one side.
- 22 RESUME indicator
- Lights when the Resume function is activated (see page 14).
- 23 3D PHONIC indicator
- Lights when 3D PHONIC is activated (see page 19).
- 24 Timer indicators
- : lights when Sleep Timer is working or Daily Timer or Recording Timer stands by or is working or setting.
 - SLEEP: flashes when the Sleep Timer is activated.
 - DAILY: lights when the Daily Timer stands by; flashes while working or setting.
 - REC: lights when the Recording Timer stands by; flashes while working or setting.

Daily Operations—Playback

In this manual, the operation using the remote control is mainly explained; however, you can use the buttons and controls on the main unit if they have the same (or similar) name and marks.

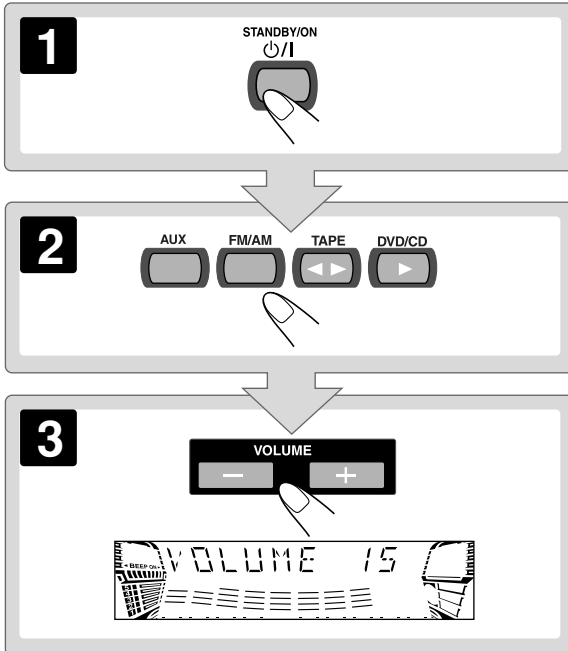
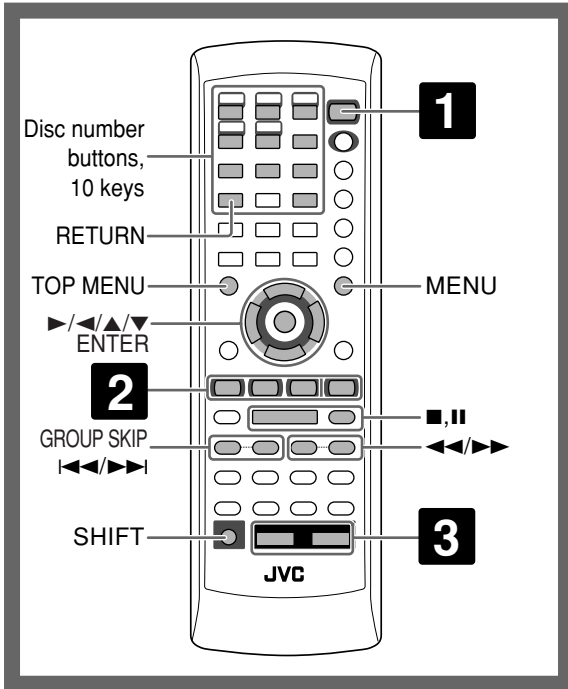

1 Turn on the power.

The STANDBY lamp on the main unit goes off.

- Without pressing O/I (STANDBY/ON), the System also turns on by pressing one of the source select buttons in the next step.

2 Select the source.

Playback automatically starts if the selected source is ready to start playback.

- If you press AUX, start playback source on the external component.

3 Adjust the volume.

4 Operate the target source as explained later.

To turn off (stand by) the system

The STANDBY lamp on the main unit lights in red.

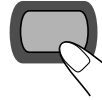

- A small amount of power is always consumed even while on standby.

For private listening

Connect a pair of headphones to the PHONES jack on the main unit. The sound will no longer come out of the speakers. Be sure to turn down the volume before connecting or putting the headphones.

- Disconnecting the headphones will activate the speakers again.



DO NOT turn off (stand by) the System with the volume set to an extremely high level; Otherwise, the sudden blast of sound can damage your hearing, speakers and/or headphones when you turn on the System or start playback.

Canceling the Demonstration

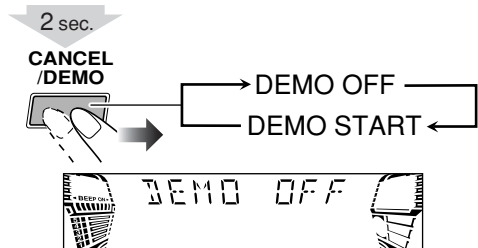

Listening to the Radio INFO

To select the band (FM/AM)

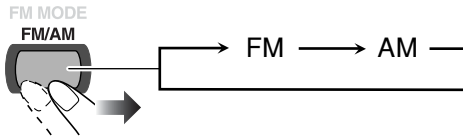

To tune in to a station

While FM or AM is selected...

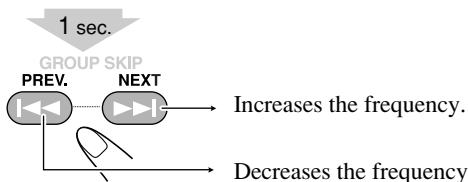

When a station (frequency) with sufficient signal strength is tuned in, the frequency search stops.

- When you repeatedly press the button, the frequency changes step by step.
- You can also use ◀▶ buttons on the main unit.

To stop searching manually, press either button.

If the received FM station is hard to listen Remote ONLY

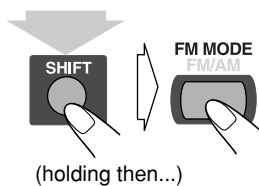

The MONO indicator lights on the display. Reception will improve though stereo effect is lost—monaural reception mode.

To restore the stereo effect, press the button again (the MONO indicator goes off).

To preset Stations Main Unit ONLY

You can preset 30 FM and 15 AM stations.

- 1 Tune in to a station you want to preset, then enter into the presetting mode.

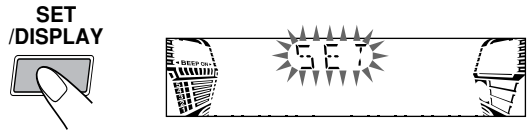

- 2 Select a preset number for the station you store.

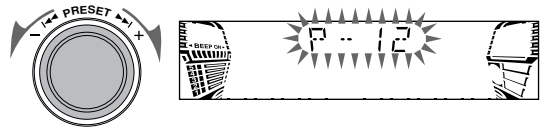

- 3 Store the station.



To turn in to a Preset Station

- 1 Select the band (FM or AM).

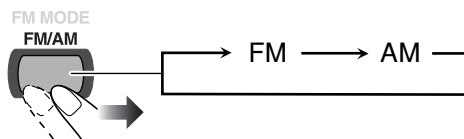

- 2 Select a preset number for the station you store.

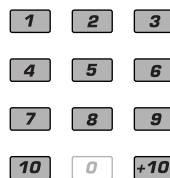

Examples:

- To select preset number 5, press 5.
- To select preset number 15, press +10, then 5.
- To select preset number 30, press +10, +10, then 10.

- You can also use the PRESET +/- control on the main unit.

Playing Back a Disc INFO

Before operating a disc, be familiar how a disc is recorded.

- DVD Video comprises of “Titles” which includes “Chapters,” DVD Audio/MP3/WMA comprise of “Groups” which includes “Tracks,” and CD/SVCD/VCD comprise of only “Tracks.”

For JPEG playback, see “Operations on the CONTROL Screen” on page 34.

To insert discs

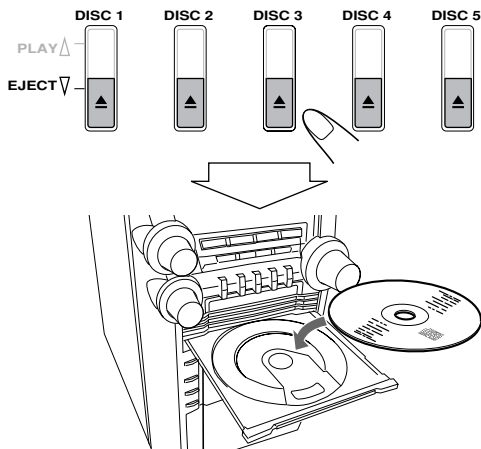

- When using an 8 cm disc, place it on the inner circle of the disc tray.

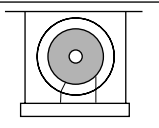

To close the disc tray, press the same again.

- If you press DVD/CD , disc tray closes automatically and playback starts.
- When you press for the next tray you want to place another disc onto, the first disc tray automatically closes and then next tray comes out.

To start:	To pause:	To stop:
	To release it, press DVD/CD .	

While playing DVD/SVCD/VCD: This System can store the stop point, and when you start playback again by pressing DVD/CD , it starts from the position where you have stopped—Resume Play. (RESUME indicator lights up when you stop playback.)

To stop completely while Resume is activated, press twice. (To cancel Resume, see “RESUME” on page 43.)

On-screen guide icons

- During disc playback, the following icons may appear for a while on the TV screen:

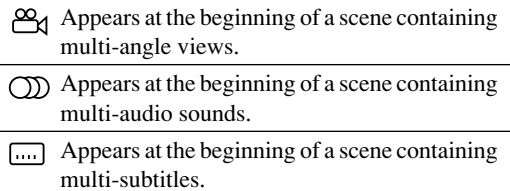

- The following icons will be also shown on the TV screen to indicate your current operation.



- To deactivate the on-screen guide icons, see “ON SCREEN GUIDE” on page 43.

To select a playback disc

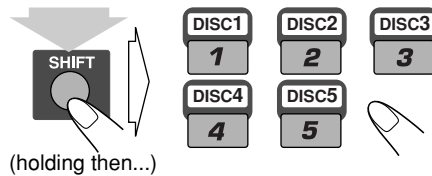

(holding then...)

- You can also use the disc number play buttons on the unit.

To select a title/group Remote ONLY

While playing a disc...

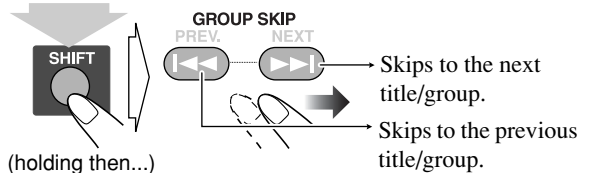

(holding then...)

- Skips to the next title/group.
- Skips to the previous title/group.

To select a chapter/track

While playing...

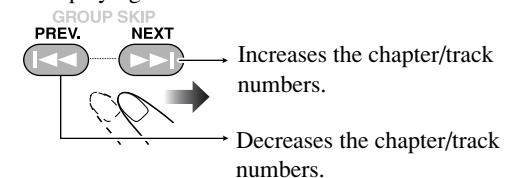

- Increases the chapter/track numbers.
- Decreases the chapter/track numbers.

To locate a particular portion

While playing a disc except WMA/MP3...



- No sound comes out while searching on DVD/SVCD/VCD.

To return to normal playback, press DVD/CD .

To select an item directly



You can select a title/chapter/track directly and start playback.

For DVD Video, you can select a **title before starting playback**, while you can select a **chapter after starting playback**.

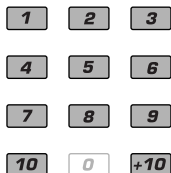

Examples:

To select number 5, press 5.

To select number 15, press +10, then 5.

To select number 30, press +10, +10, then 10.

To play back by using the disc menu



You can operate the disc play—DVD and SVCD/VCD with Playback Control (PBC)—using the disc menu shown on the TV screen.

- When an SVCD or VCD with PBC is detected, “PBC” appears on the display instead of the playing time.

■ For DVD Video/DVD Audio:

1 Show the disc menu.

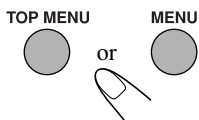

2 Select an item on the disc menu.

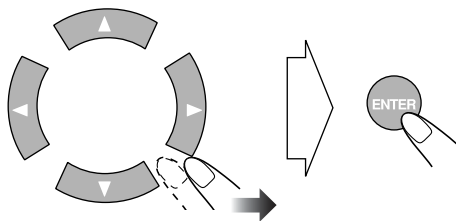

- With some discs, you can also select items by entering the number using the 10 keys.

■ For SVCD/VCD with PBC:

While playing a disc with PBC, “PBC” appears on the display.

When disc menu appears on the TV screen, select an item on the menu. Playback of the selected item starts.

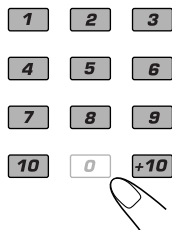

Examples:

To select number 5, press 5.

To select number 15, press +10, then 5.

To select number 30, press +10, +10, then 10.

To move to the next or previous page of the current menu:

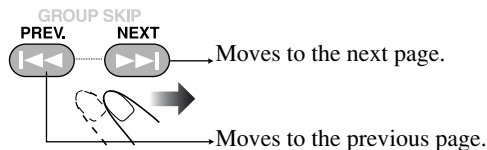

To return to the previous menu:

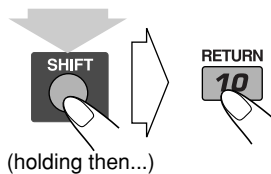

To cancel PBC

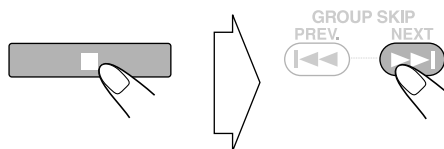

You can also cancel PBC function by pressing the number button to select a track.

To reactivate PBC, press ■, then press |◀◀.

Playing Back a Tape

To insert a tape

You can play back type I tapes.

- The use of C-120 or longer tape is not recommended.

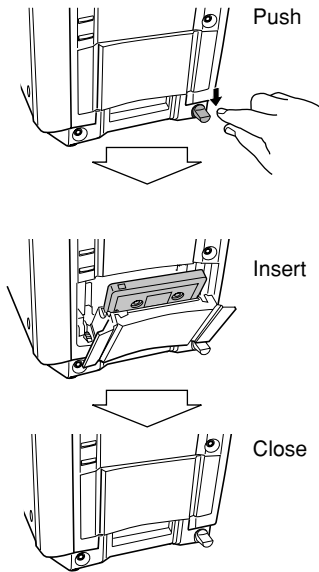

To reverse the tape automatically

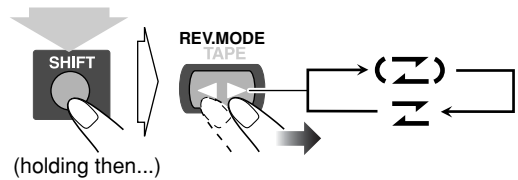

- You can also use REVERSE MODE button on the unit.

	Tape is automatically reversed, and playback repeats until you stop it.
	Tape will not be reversed. When the current side of the tape reaches its end, playback stops.

To locate the beginning or next of a recording—Music Scan

During play, designate where the recording you want is located—specify how many recordings need to be skipped on the tape.

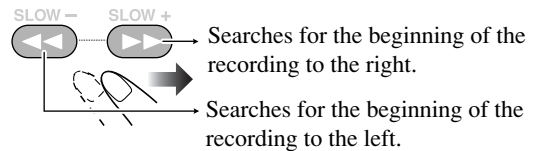

- You can also use buttons on the remote control.

To start:	To stop:
To rewind tape:	
Before or after play...	
	→ Rewinds the tape to the right.
	→ Rewinds the tape to the left.
• You can also use buttons on the remote control.	

To change the tape running direction

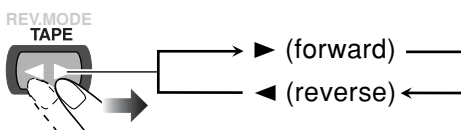

Daily Operations—Sound&Other Adjustments

Remote Control

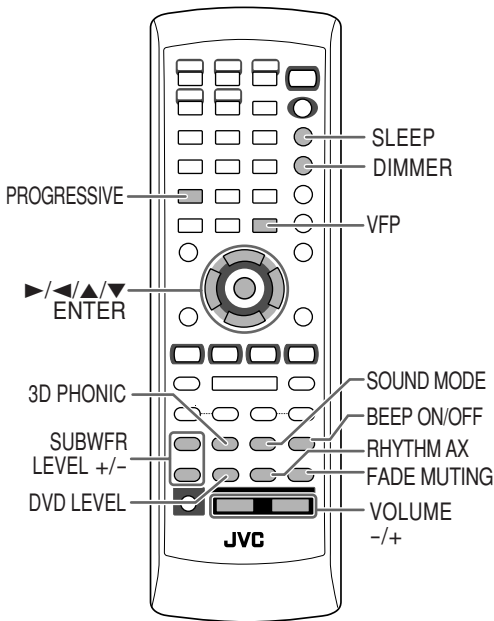

Main unit

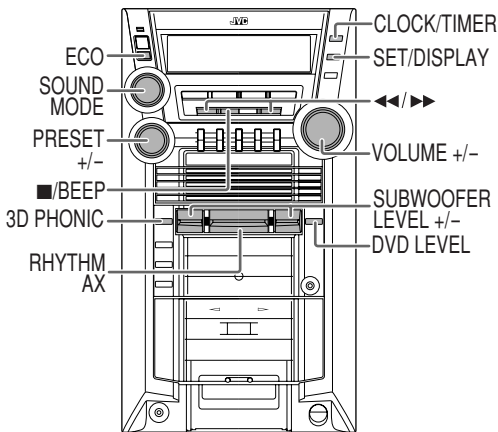

Adjusting the Volume

INFO

The volume level can be adjusted in 32 steps (VOLUME MIN, VOLUME 1 – VOLUME 30, VOLUME MAX).

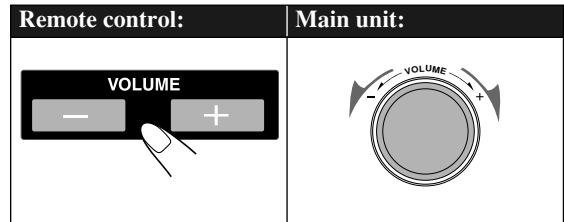

To drop the volume in a moment



FADE
MUTING



To restore the volume, press again, or adjust the volume level.

Reinforcing the Bass Sound

INFO

To adjust the subwoofer level gradually

You can select the subwoofer level from level 0 (minimum) to level 2 (maximum).

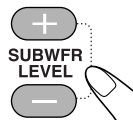

To emphasize rhythm feeling—RHYTHM AX

This function emphasizes bass attack feeling, and also changes the subwoofer level.

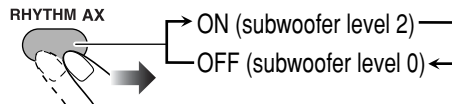

Selecting the Sound Modes INFO

You can select one of the preset Sound Modes.

Remote control:

Main unit:

Surround modes*	
DANCE	Increases resonance and bass.
HALL	Adds depth and brilliance to the sound.
STADIUM	Adds clarity and spreads the sound, as in an outdoor stadium.
SEA (Sound Effect Amplifier) modes	
ROCK	Boosts low and high frequency. Good for acoustic music.
POP	Good for vocal music.
CLASSIC	Good for classical music.
User modes	
USER 1/2/3	Your individual mode stored in memory. See the next column "Creating Your Own Sound Modes—User Mode."
OFF	No Sound Mode effect (FLAT).

* Surround elements are added to the SEA elements to create being-there feeling in your room.

Creating Your Own Sound Modes—User Mode INFO

You can create your own Sound Modes to make sounds suit your taste. The changed settings can be stored as the USER 1, USER 2 and USER 3 modes.

1 Select one of the preset Sound Modes.

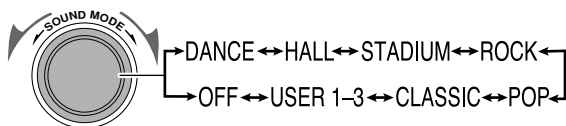

• If you want to add surround elements into your Sound Mode, select one of the Surround modes.

2 Enter into the SEA Control Mode.

• You can enter the SEA Control Mode only while the Sound Mode appears on the display.

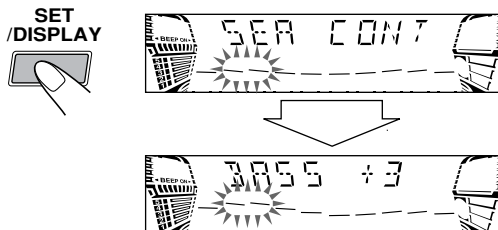

3 Adjust the SEA pattern.

① Select one of the tone—BASS or TRE.

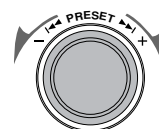

② Adjust the level of the selected tone.

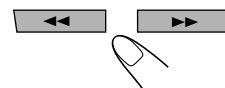

• You can adjust the bass and treble level from -3 to +3.

③ Repeat steps ① and ② to adjust the level of the other tone.

④ Finish the SEA pattern setting.

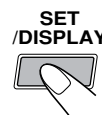

4 Select one of the User modes in which you want to store yougt.



5 Finish the setting.

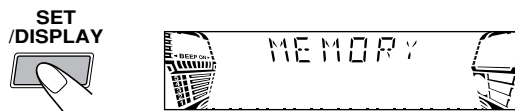

Selecting 3D PHONIC Mode (INFO)

While playing...

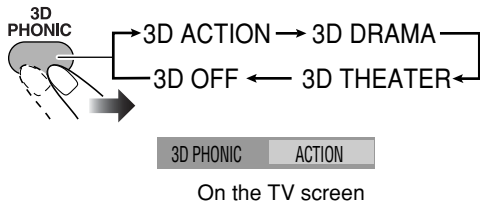

3D ACTION	Suitable for action movies and sports programs.
3D DRAMA	Creates natural and warm sound. Enjoy movies in a relaxed mood.
3D THEATER	Enjoy sound effects like in a major theater.

Presetting Automatic DVD Video Sound Increase Level (Remote ONLY)

The DVD Video sound is sometimes recorded at a lower level than for other discs and sources. You can set the increase level for the currently loaded DVD Video, so you do not have to adjust the volume every time you change the source.

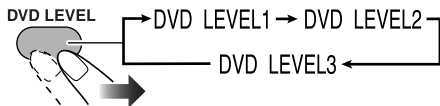

As the number increases, sound level also increases.

Changing the Scanning Mode (Remote ONLY) (INFO)

This System supports progressive scanning. If you connect a progressive TV through the COMPONENT jacks, you can enjoy a high quality picture from the built-in DVD player by selecting "PROGRESSIV."

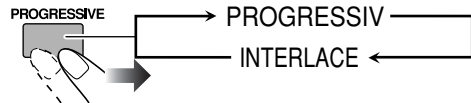

PROGRESSIV	Progressive scanning. For a progressive TV. <ul style="list-style-type: none"> This mode is effective only when "Y/C" is selected as the video signal (see page 7).
INTERLACE	Interlaced scanning. For a conventional TV.

- PRGR. indicator lights on when progressive scanning mode is selected.

Changing the Picture Tone (Remote ONLY) (INFO)

While showing a playback picture on the TV, you can select the preset picture tone, or adjust it and store your own taste.

To select a preset picture tone

1 Activate VFP.

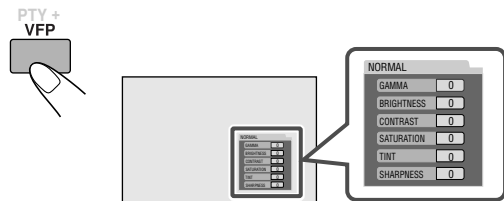

On the TV screen

2 Select a preset picture tone.

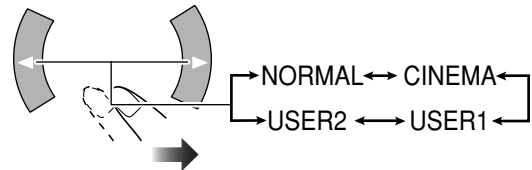

NORMAL	Normally select this.
CINEMA	Suitable for a movie source.
USER1/USER2	You can adjust parameters and can store the settings (see page 20) .

To adjust the picture tone

1 Select "USER1" or "USER2."

- Follow steps 1 and 2 explained on page 19.

2 Select a parameter you want to adjust.

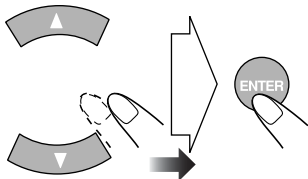

GAMMA	Adjust if the neutral color is bright or dark. The brightness of dark and bright portions is maintained (-3 to +3).
BRIGHTNESS	Adjust if the picture is bright or dark as a whole (-8 to +8).
CONTRAST	Adjust if the far and near position is unnatural (-7 to +7).
SATURATION	Adjust if the picture is whitish or blackish (-7 to +7).
TINT	Adjust if the human skin color is unnatural (-7 to +7).
SHARPNESS	Adjust if the picture is indistinct (-8 to +8).

3 Adjust the parameter.

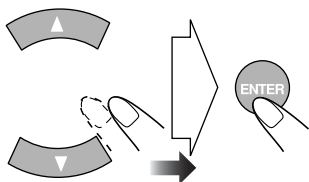

4 Repeat steps 2 to 3 to adjust other parameters.

5 Finish setting.

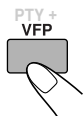

Turning On or Off the Key-Touch Tone

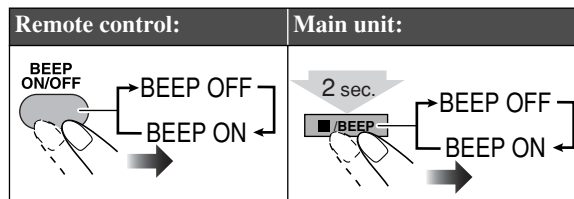

Changing the Display Brightness



You can dim the display window.

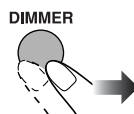

Saving the Power Consumption while on Standby (Ecology Mode)



You can save the power consumption while the unit is turned off (on standby).

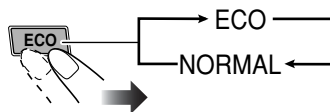

When you turn off the System with Ecology Mode activated, "ECO" flashes on the display for a few seconds, and the clock time will not be shown while the System is turned off.

Setting the Clock



INFO

Without setting the built-in clock, you cannot use Daily/Recording Timers (see page 38) and Sleep Timer (see next column).

- To exit from the clock setting, press CLOCK/TIMER as required.
- To go back to the previous step, press CANCEL/DEMO.

1 Activate clock setting mode.

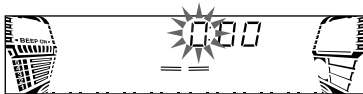

- If you have already adjusted the clock before, press the button repeatedly until the clock setting mode is selected.

2 Adjust the hour.

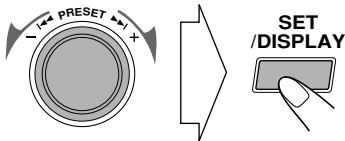

3 Adjust the minute.

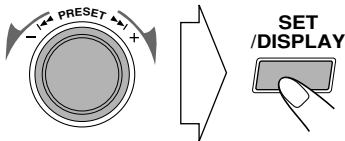

Now the built-in clock starts working.

To check the current time during play

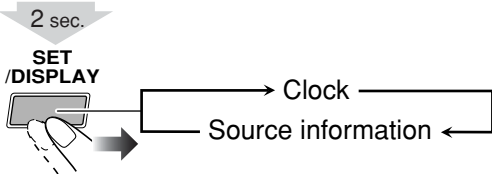

Turning Off the Power



Automatically

INFO

With Sleep Timer, you can fall asleep listening to music.

- You can set Sleep Timer only while the System is turned on.

1 Specify the time (in minutes).

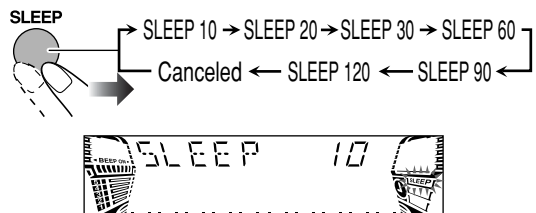

2 Wait until the set time goes off.

To check the time remaining until the shut-off time



- If you press the button repeatedly, you can change the shut-off time.

Advanced Radio Operations

Remote control

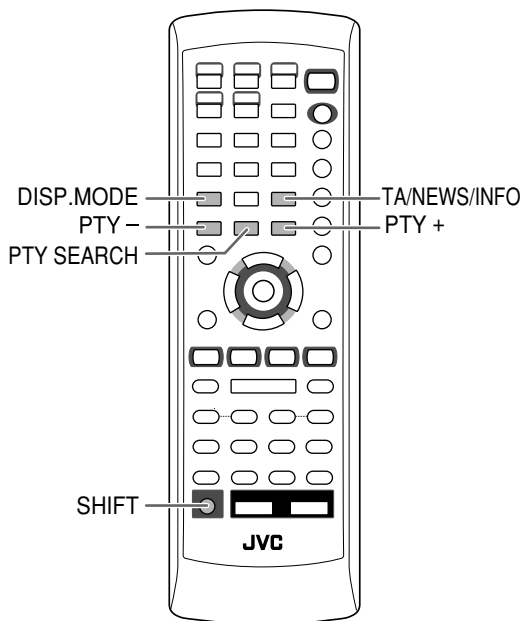

To show the RDS information

While listening to an FM station...

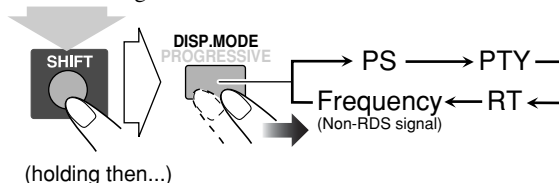

PS	Station names is displayed. "NO PS" will appear if no signal is sent.
PTY	The broadcast program type is displayed. "NO PTY" will appear if no signal is sent.
RT	Text messages the station sends is displayed. "NO RT" will appear if no signal is sent.

Searching for a Program by

PTY Codes



You can locate a particular kind of program from the preset channels (see page 13) by specifying the PTY codes.

To search for a program using the PTY codes

1 While listening to an FM station...

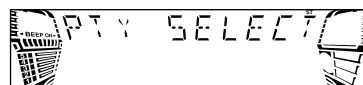
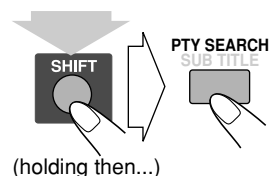

2 Select a PTY code.

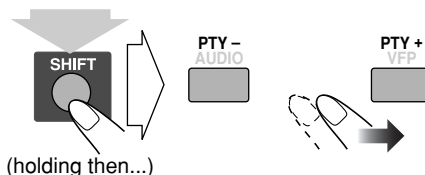

• For details about each PTY code, see page 24.

Receiving FM Stations with RDS



Radio Data System (RDS) allows FM stations to send an additional signal along with their regular program signals.

- When tuned to an FM station which provides the RDS service, the RDS indicator lights on the display.

This System can receive the following types of RDS signals.

PS (Program Service)	Shows commonly known station names.
PTY (Program Type)	Shows types of broadcast programs.
RT (Radio Text)	Shows text messages the station sends.
Enhanced Other Networks	Provides the information about the types of the programs broadcast by the RDS stations of the different networks.

3 Start searching.

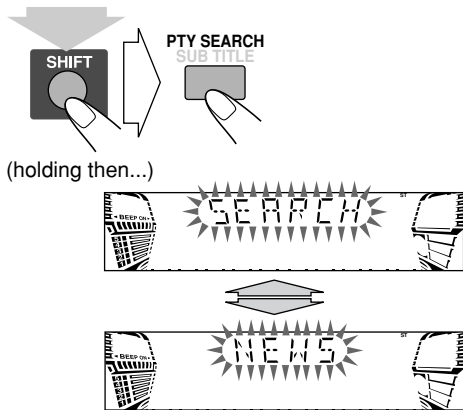

Ex. When "NEWS" is selected

The receiver searches 30 preset FM stations, stops when it finds the one you have selected, and tunes in to that station.

- If no program is found, "NOT FOUND" appears on the display.
- To stop searching any time during search, press PTY SEARCH (while holding SHIFT).

To continue searching after it stops on an unwanted station

While the indications on the display are flashing, press PTY SEARCH again (while holding SHIFT).

Switching Temporarily to a Program Type of Your Choice Automatically



The Enhanced Other Networks function allows the System to switch temporarily to a preset FM station broadcasting a program of your choice (TA, NEWS, or INFO).

- This function works while listening to an FM station providing the required signals.

While listening to an FM station, select the program type.

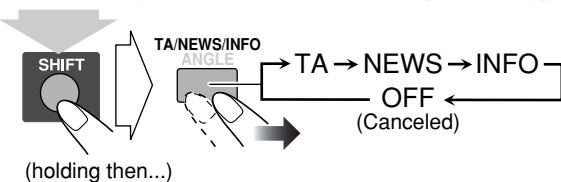

(holding then...)

TA	Traffic announcement in your area
NEWS	News
INFO	Program the purpose of which is to impart advice in the widest sense
OFF	The function is canceled. The PTY code indicator (TA/NEWS/INFO) goes off.

How the Enhanced Other Networks function actually works:

CASE 1

If a station is not broadcasting the program of your choice

The System continues tuning in to the current station.



When a station broadcasting the program of your choice, the System automatically switches to the station. The PTY code indicator starts flashing.



When the program is over, the System goes back to the previously tuned station, but the function still remains active (the indicator stops flashing and remains lit).

CASE 2

If a station is broadcasting the program of your choice

The System automatically switches to the station. The PTY code indicator starts flashing.



When the program is over, the System goes back to the previously tuned station, but the function still remains active (the indicator stops flashing and remains lit).

CASE 3

If the station currently tuned in is broadcasting the program of your choice

The PTY code indicator starts flashing.



When the program is over, the indicator stops flashing (the function still remains active).



Description of the PTY codes

NEWS	News.
AFFAIRS	Topical program expanding or enlarging upon the news—debate, or analysis.
INFO	Programs the purpose of which is to impart advice in the widest sense.
SPORT	Programs concerned with any aspect of sports.
EDUCATE	Educational programs.
DRAMA	All radio plays and serials.
CULTURE	Programs concerning any aspect of national or regional culture, including language, theater, etc.
SCIENCE	Programs about natural sciences and technology.
VARIED	Used for mainly speech-based programs such as quizzes, panel games, and personality interviews.
POP M	Commercial music of current popular appeal.
ROCK M	Rock music.
EASY M	Current contemporary music considered to be “easy-listening.”
LIGHT M	Instrumental music, and vocal or choral works.
CLASSICS	Performances of major orchestral works, symphonies, chamber music, etc.
OTHER M	Music which is not fitting into any of the other categories.
WEATHER	Weather reports and forecasts.
FINANCE	Stock market reports, commerce, trading, etc.
CHILDREN	Programs targeted at a young audience.
SOCIAL	Programs about sociology, history, geography, psychology, and society.
RELIGION	Religious programs.

PHONE IN	Involving members of the public expressing their views either by phone or at a public forum.
TRAVEL	Travel information.
LEISURE	Programs about recreational activities.
JAZZ	Jazz music.
COUNTRY	Songs which originate from, or continue the musical tradition of the American Southern States.
NATION M	Current popular music of the nation or region in that country’s language.
OLDIES	Music from the so-called “golden age” of popular music.
FOLK M	Music which has its roots in the musical culture of a particular nation.
DOCUMENT	Programs concerning factual matters, presented in an investigative style.
TEST	Broadcasts for testing emergency broadcast equipment or unit.
ALARM	Emergency announcement.

Classification of the PTY codes for some FM stations may be different from the above list.

Unique DVD/VCD Operations

Remote Control

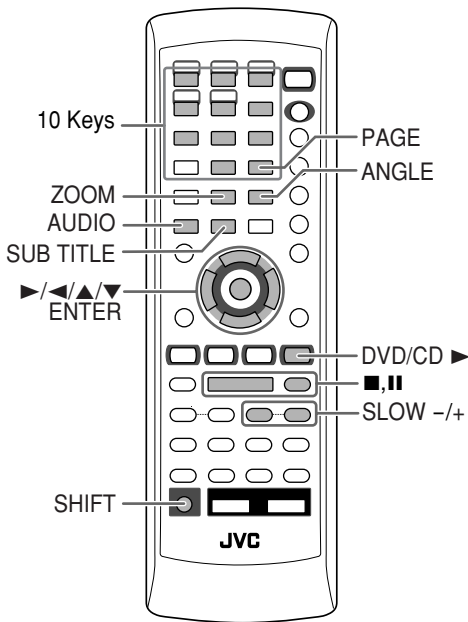

Selecting the Sound Track



INFO

For DVD Video: While playing back a chapter containing audio languages, you can select the language to listen to.

For DVD Audio: While playing back a track containing audio channels, you can select the audio channel to listen to.

For SVCD/VCD: When playing back a track, you can select the audio channel to play.

- You can also select the audio track using the on-screen bar (see page 31).

While playing a DVD Video...



Ex.:

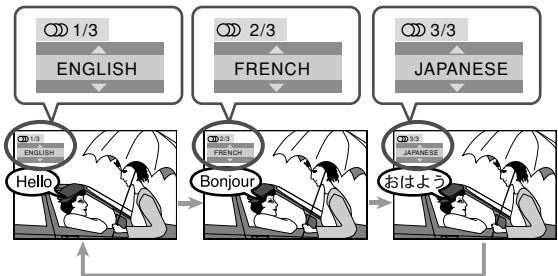

While playing an SVCD or VCD...

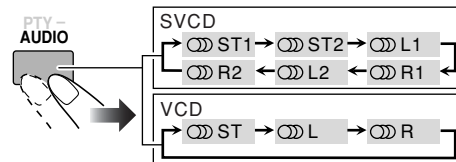

ST1/ST2/ST To listen to normal stereo (2 channel) playback.

L1/L2/L To listen to the left audio channel.

R1/R2/R To listen to the right audio channel.

- SVCD can have 4 audio channels. SVCD usually uses these 4 channels to record two 2-channel recordings (ST1/ST2).

Selecting the Subtitle Language

For DVD Video: While playing back a chapter (of DVD Video) containing subtitles in different languages, you can select the subtitle language to display on the TV screen.

For SVCD: While playing, you can select the subtitles even if no subtitles are recorded on the disc.

- You can also select the subtitle language using the on-screen bar (see page 31).

While playing a DVD Video...

1 Display the subtitle selection window.

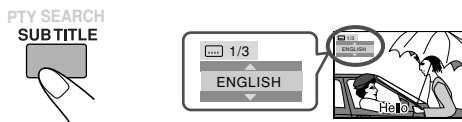

2 Select the subtitle language.

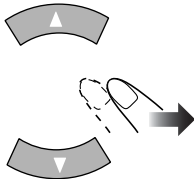

Ex.:

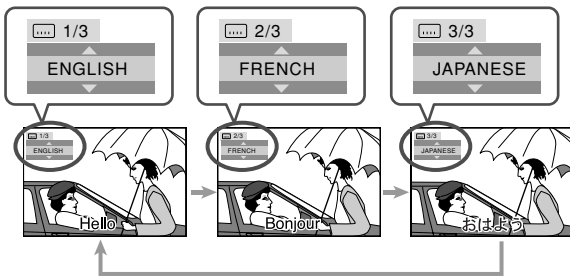

While playing an SVCD...

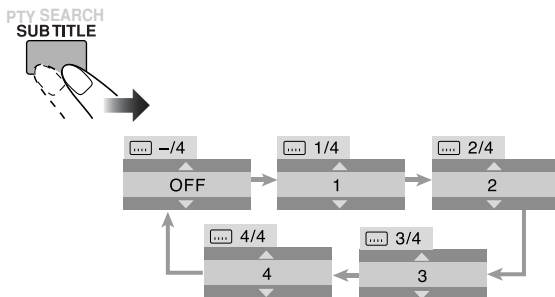

Selecting a View Angle

While playing back a chapter (of DVD Video) containing multi-view angles, you can view the same scene from different angles.

- You can also select the view angle using the on-screen bar (see page 31).

While playing back or paused...



Ex.:

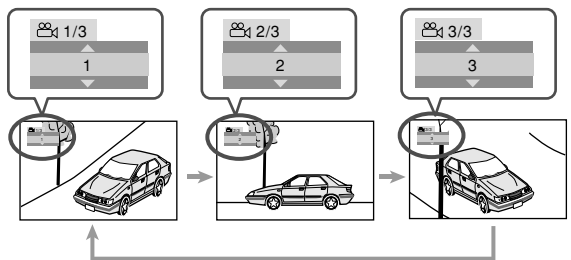

Selecting a Still Pictures on a DVD Audio

While playing back a track (of DVD Audio) linked to browsable still pictures (B.S.P.), you can select the still picture (turn the page) to be shown on the TV screen.

- If a track is linked to browsable still pictures (B.S.P.), they are usually shown in turn automatically during playback.
- You can also select the page using the on-screen bar (see page 31).

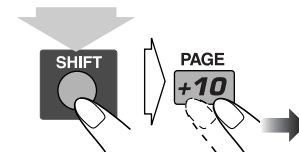

(holding then...)

Each time you press the button, the still picture changes one after another (if available).

Playing Back a Bonus Group on a DVD Audio



Some DVD Audios have a special group called “bonus group” whose contents are not open to the public.

- To play back a bonus group, you have to enter the specific “key number” (a kind of password) for the bonus group. The way of getting the key number depends on the disc.

1 Select the bonus group.

- The bonus group is usually recorded as the last group (for example, if a disc contains 4 groups including a bonus group, “group 4” is the bonus group).
- For how to select the group, see “To select a title/group” on page 14.

2 Enter the key number.

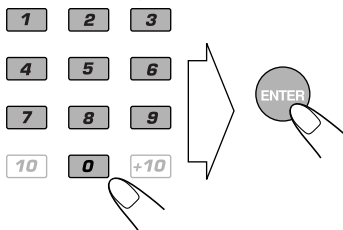

3 Follow the interactive instruction shown on the TV screen.

To cancel the key number entry, press **■** or change to another source.

Special Picture Playback



Still picture playback

To start still picture playback:	To resume normal playback:
While playing... 	

Frame-by-frame playback

1 While playing...

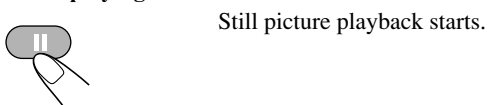

2 Advance the still picture frame by frame.



To resume normal playback, press DVD/CD ►.

Slow-motion playback

1 While playing...



Still picture playback starts.

2 Select slow motion speed.

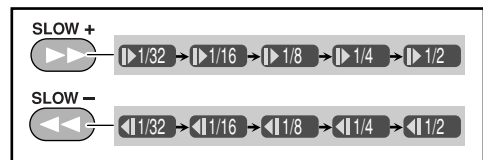
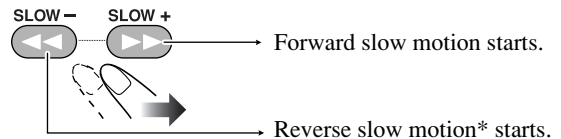

*Only for DVD Video.

To resume normal playback, press DVD/CD ►.

Zoom



1 While playing back...

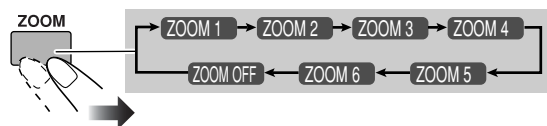

As the number increases, magnification also increases.

2 Move the zoomed-in position.

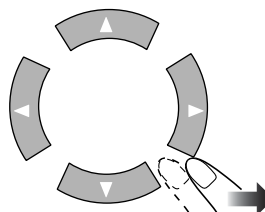

To resume normal playback, press ZOOM repeatedly until “ZOOM OFF” appears on the TV screen.

Advanced Disc Operations

Remote Control

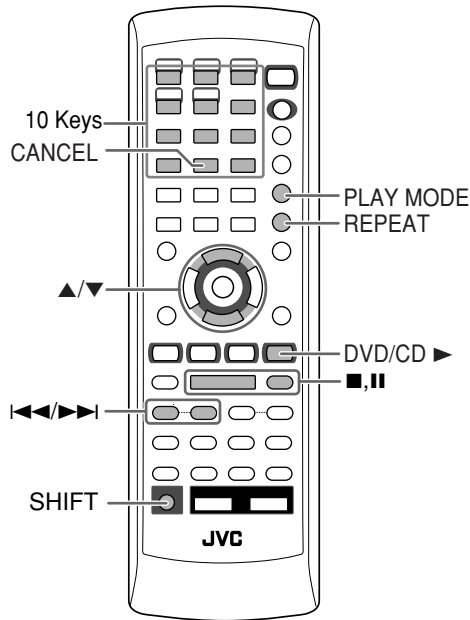

Main unit

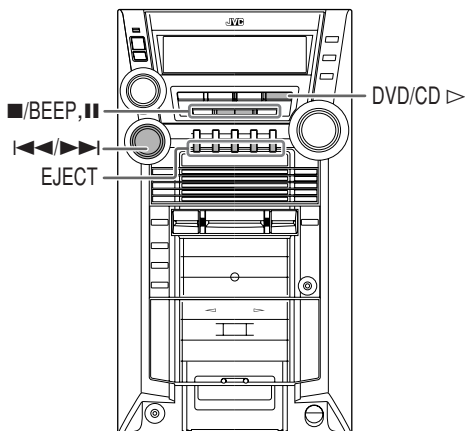

Programming the Playing Order

—Program Play

You can arrange the playing order of the tracks (up to 99) before you start playback.

1 Before starting playback, activate Program Play.

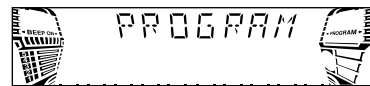
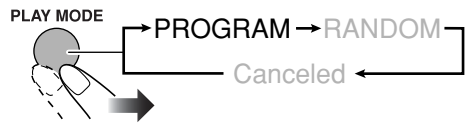

On the display

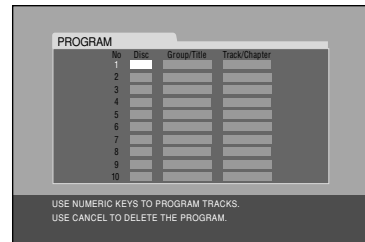

On the TV screen

2 Select chapters or tracks you want for Program Play.

• For DVD/MP3/WMA:

- ① Select a disc number.
- ② Select a title or group number.
- ③ Select a chapter or track number.

• For SVCD/VCD/CD:

- ① Select a disc number.
- ② Select a track number.

To enter the numbers:

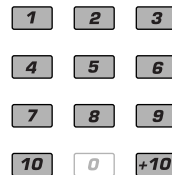

Examples:

To enter number 5, press 5.
To enter number 15, press +10, then 5.
To enter number 30, press +10, +10, then 10.

3 Repeat the above step 2 until you finish what you want to program.

4 Start playback.



Playback starts in the order you have programmed.

To skip a track:	To pause:	To stop:
	<p>To release, press DVD/CD ►.</p>	

To check the programmed contents



Before or after playback...

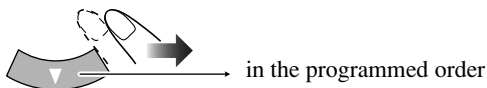
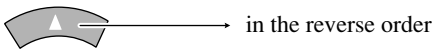

To modify the program



Before or after playback...

To erase the last step:	To erase the entire program:
<p>(holding then...)</p>	<p>You can also use ■/BEEP button on the unit.</p>
To add steps in the program: Repeat step 2 on page 28.	

To exit from Program Play

Before or after playback...

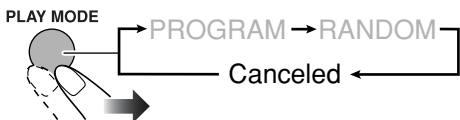

Playing at Random



—Random Play



You can play the contents of all tracks at random.

1 Before starting playback, activate Random Play.

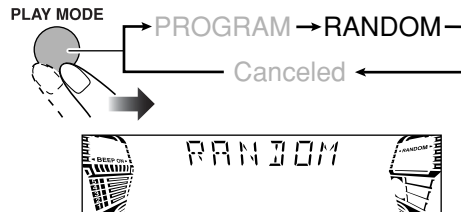

2 Start playback.



Playback starts in a random order. Random Play ends when all chapters/tracks are played.

To skip:	To pause:	To stop:
<p>To go to the beginning of the current track, press ◀◀.</p>	<p>To release, press DVD/CD ►.</p>	

To exit from Random Play

Before or after playback...

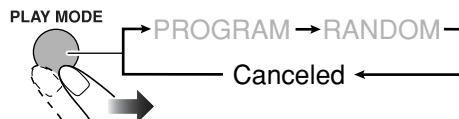

Playing Repeatedly



- You can also select the repeat mode using the on-screen bar (see page 32).

Repeat Play

You can repeat playback.

• For DVD Video:

While playing...

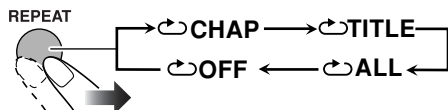

Before starting playback...

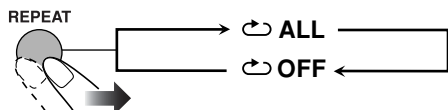

• For DVD Audio:

While playing or before playback...

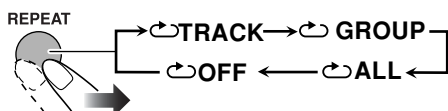

• For MP3/WMA:

While playing or before playback...

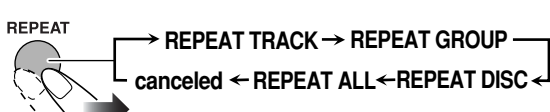

• For CD/SVCD/VCD:

While playing (without PBC for SVCD/VCD) or before playback...

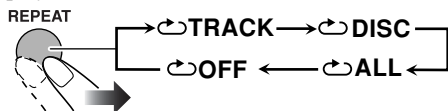

• For Program Play mode:

While playing or before playback...

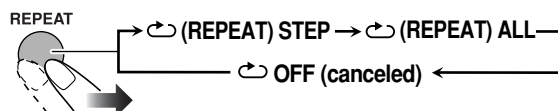

• For Random Play mode:

While playing or before playback...

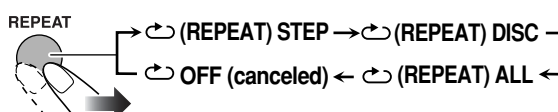

CHAP	Repeats the current chapter.
TITLE	Repeats the current title.
ALL	Repeats all discs or all programmed tracks.
TRACK	Repeats the current track.
GROUP	Repeats the current group.
DISC	Repeats the current disc.
STEP	Repeats the current track.
OFF	Selects to cancel Repeat Play mode.

Prohibiting Disc Ejection



Child Lock

INFO

You can lock the disc trays so that no one can eject the loaded disc.

- This operation is possible only when the source is the disc player.

While the disc trays are closed...

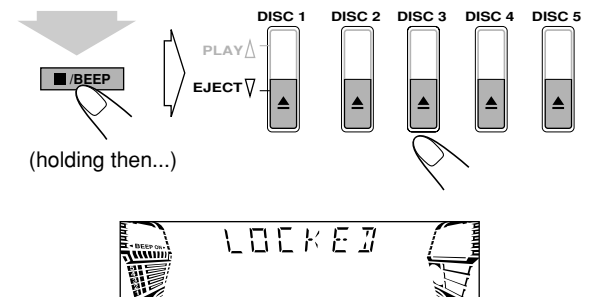

To cancel the prohibition, repeat the same procedure. "UNLOCKED" appears on the display.

On-Screen Disc Operations

Remote control

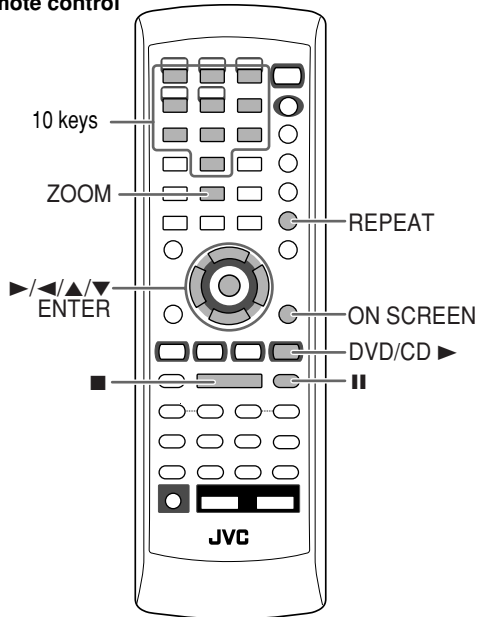

On-screen bars

DVD Video

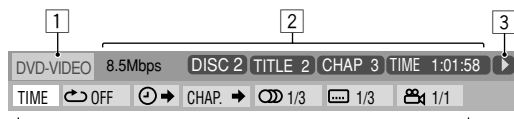

DVD Audio

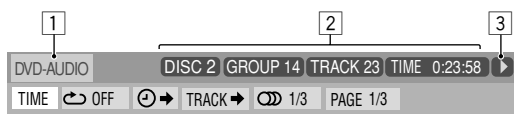

SVCD



VCD

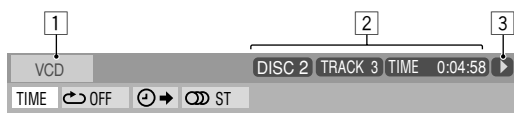

CD



About the On-screen Bar

You can check the information on disc (except for MP3/WMA/JPEG disc) and use some functions through the on-screen bar.

On-screen bar

Ex.: While playing a DVD Video

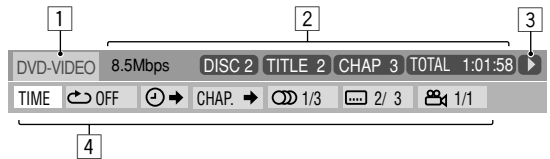

1 Disc type

2 Playback information

Indication	Meanings
Mbps	Current transfer rate (Megabits per second)
DISC 2	Current disc
TITLE 2	Current title
CHAP 3	Current chapter
GROUP 1	Current group
TRACK 14	Current track
TOTAL 1:25:58	Time indications

3 Playback conditions

Indication	Meanings
▶	Playback
⏪ / ⏩	Forward/Reverse search
⏪ / ⏩	Forward/Reverse slow-motion
⏸	Pause
■	Stop

4 Operation icons (on the pull-down menu)

Indication	Meanings
TIME	Select to change the time indication (see also page 32).
↺	Select to repeat playback (see also pages 30, 32 and 33).
⏪ →	Select for time search (see also page 33).
CHAP. →	Select for chapter search (see also page 34).
TRACK →	Select for track search (see also page 34).
⏸ 1/3	Select to change the audio language or channel (see also page 25).
📄 1/3	Select to change subtitle language (see also page 26).
📺 1/3	Select to change the view angle (see also page 26).
PAGE 1/15	Select to change the page (see also page 26).

Operations Using the On-screen Bar

Basic operation procedure through the on-screen bar is as follows:

Ex.: Selecting a subtitle (French) for DVD Video

While a disc is selected as the source...

1 Display the on-screen bar with the pull-down menu.

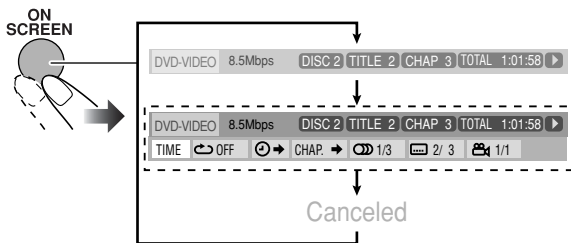

2 Select (highlight) the item you want.

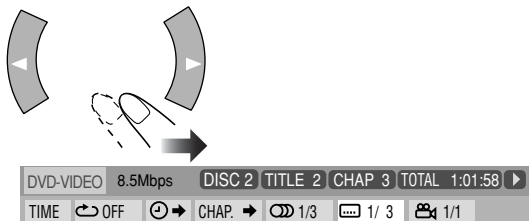

3 Display the pop-up window.



4 Select the desired option in the pop-up window.

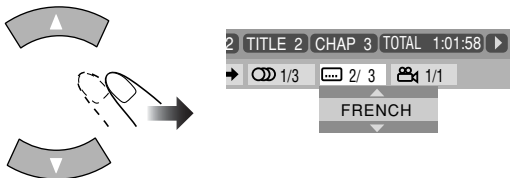

5 Finish the setting.

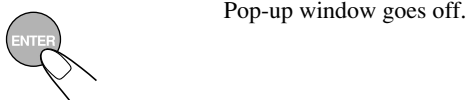

To erase the on-screen bar

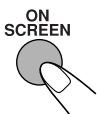

Changing the time information

You can change the time information in the on-screen bar and the display window on the main unit.

1 Display the on-screen bar with the pull-down menu.



2 Make sure [TIME] is selected (highlighted).

3 Change the time indication.

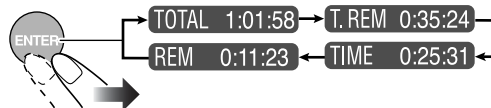

TOTAL	Elapsed disc time.
T.REM	Remaining disc time.
TIME	Elapsed playing time of the current chapter/track.
REM	Remaining time of the current chapter/track.

To erase the on-screen bar



Repeat Play

• See also page 30.

1 While playing a disc (without PBC for SVCD/VCD), display the on-screen bar with the pull-down menu.

2 Select [OFF].

3 Display the pop-up window.



4 Select the repeat mode you want.

ALL	Repeats all discs.
A-B	Repeats a desired portion (see page 33).
TITLE	Repeats the current title.
GROUP	Repeats the current group.
DISC	Repeats the disc.
CHAPTER	Repeats the current chapter.
TRACK*	Repeats the current track.
OFF	Cancels Repeat Play.

* During Program Play or Random Play, "STEP" appears.

• Repeat modes depend on the current playback disc. Refer to page 30.

5 Finish the setting.



Pop-up window goes off.

To cancel Repeat Play, select “OFF” in step 4.

To erase the on-screen bar



A-B Repeat

- 1 While playing, display the on-screen bar with the pull-down menu.
- 2 Select .
- 3 Display the pop-up window.



4 Select “A-B”.



5 Select the start point (A).

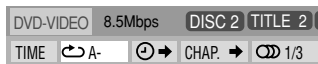

6 Select the end point (B).



A-B Repeat starts. The selected portion plays repeatedly. Before pressing ENTER, you can search for the end point using .

Time Search

You can move to a particular point by specifying the elapsed playing time from the beginning.

- 1 While playing (without PBC for SVCD/VCD), display the on-screen bar with the pull-down menu.
 - Except for DVD: Time Search can be used before starting playback.
- 2 Select .
- 3 Display the pop-up window.



4 Enter the time.

You can specify the time in hours/minutes/seconds.

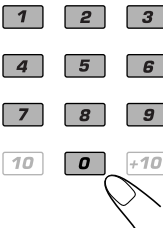

Examples:

To move to a point of 1 (hours): 02 (minutes): 00 (seconds), press 1, 0, 2, 0, then 0.

To move to a point of 54 (minutes): 00 (seconds), press 0, 5, 4, 0, then 0.

- It is always required to enter the hour digit (even “0” hour), but it is not required to enter trailing zeros (the last two digits in the examples above).
- To correct a misentry, press cursor to erase the last entry.

5 Finish the setting.



The System starts playing from the specified time.

To erase the on-screen bar



Chapter/Track Search

You can search for the chapter (DVD Video) or track (DVD Audio) number to play.

- 1 While playing, display the on-screen bar with the pull-down menu.
- 2 Select **CHAP. →** or **TRACK →**.
- 3 Display the pop-up window.



- 4 Enter the desired chapter/track number.

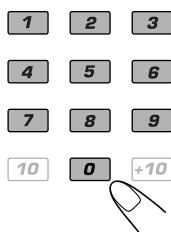

Examples:

To select chapter/track 5, press 5.

To select chapter/track 15, press 1, then 5.

To select chapter/track 30, press 3, then 0.

- To correct a misentry, press the 10 keys until the desired number shown in the pop-up window.

- 5 Finish the setting.



The System starts playing the searched chapter or track.

To erase the on-screen bar



Operations on the CONTROL Screen



INFO

The CONTROL screen automatically appears on the TV screen when you load an MP3, WMA, or JPEG disc. You can search for and play the desired tracks through the CONTROL screen.

- If both types of files (MP3/WMA files and JPEG files) are recorded on a disc, select the file type to play (see page 42).

CONTROL screen
Ex.: When the MP3 disc is loaded.

- 1 Current group number/total group number
- 2 Current group
- 3 Group list
- 4 Current track
- 5 Track information (ID3 Tag Version 1.0: only for MP3/WMA)
- 6 Repeat Play setting
- 7 Elapsed playing time of the current track (only for MP3/WMA)
- 8 Operation mode icon
- 9 Current track number/total number of tracks in the current group (total number of tracks on the loaded disc)
- 10 Highlight bar
- 11 Track list

To move the highlight bar between group list and track list

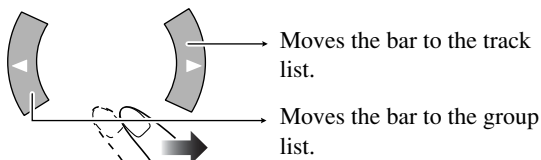

To select a group/track in the list

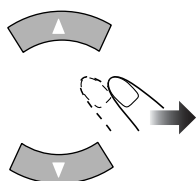

Move the highlight bar to a desired item.

- If you move the highlight bar while playing back an MP3/WMA disc, the selected track starts playback automatically.

To start playback

For MP3/WMA:	
	Playback starts with the selected track. <ul style="list-style-type: none"> • Pressing DVD/CD ► also starts playback.
For JPEG:	
	The selected track (still picture) is displayed until you change it.
	Slide-show playback starts. Each track (still picture) is shown on the screen for a few seconds, then changes one after another.

- Once you start playing back a JPEG track, the CONTROL screen goes off.
- To cancel slide-show, and display the current still picture, press **II**.

To stop playback

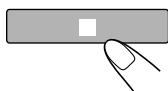

To repeat slide-show for JPEG

Before starting playback...

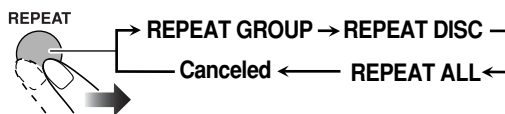

GROUP	Repeats the current group.
DISC	Repeats the current disc.
ALL	Repeats all discs.

- For Repeat Play of MP3/WMA, see page 30.

To zoom in the still picture

1 During playback is paused...

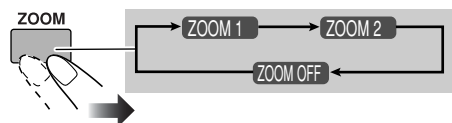

As the number increases, magnification also increases.

2 Move the zoomed-in position.

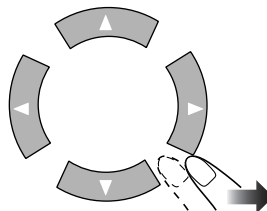

To resume normal playback, press ZOOM repeatedly until "ZOOM OFF" appears on the TV screen.

Advanced Tape Operations

Remote Control

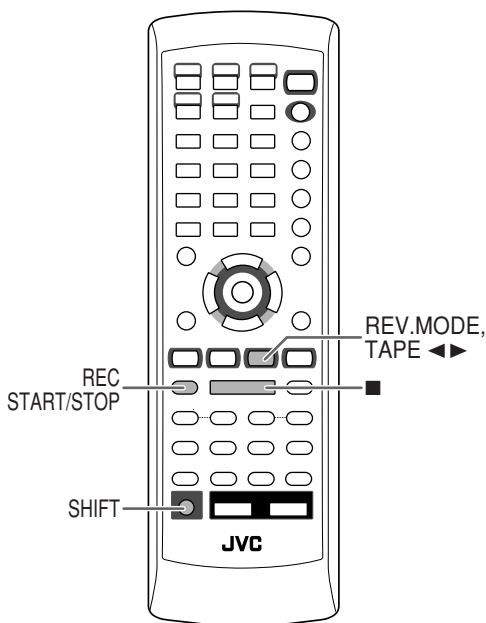

Main unit

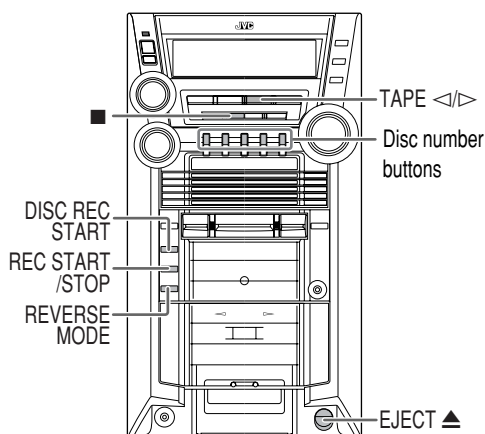

IMPORTANT

It may be unlawful to record or play back copyrighted material without the consent of the copyright owner.

Recording on a Tape

INFO

You can use type I tapes for recording.

- To play a tape, see page 16.

1 Insert a recordable cassette.

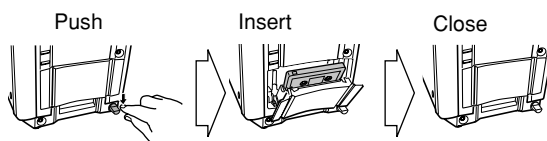

2 Check the tape running direction and Reverse Mode settings on the display.

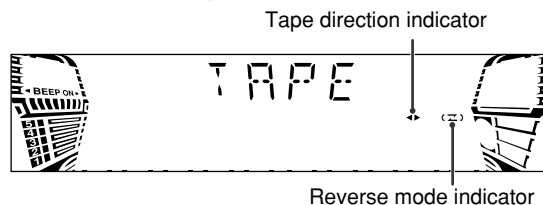

To change the direction

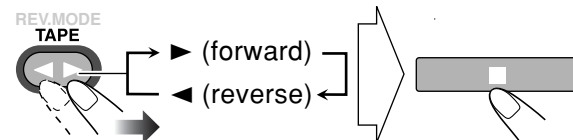

Change the Reverse mode if necessary.

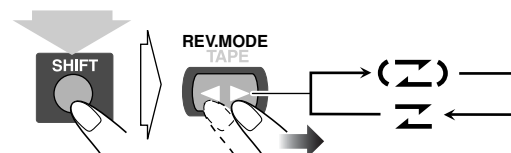

(holding then...)

- You can also use REVERSE MODE button on the unit.

(Z)	To record on both sides. • When using Reverse Mode, start recording in the forward (▶) direction.
Z	To record on only one side.

3 Start playing the source—“FM,” “AM,” “DVD/CD,” or “AUX.”

- When recording a disc, you can also use “Synchronized Disc Recording” (see the next column).

4 Start recording.

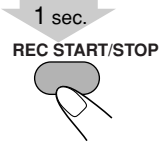

To stop recording

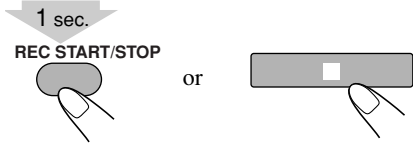

4 Start recording.



The System automatically creates 4-second blanks between the tunes recorded on the tapes.

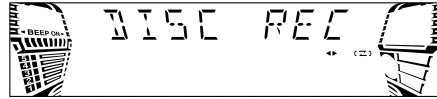

- When either disc play or recording ends, both disc player and the cassette deck stop at the same time.

To stop recording

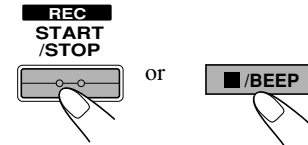

Synchronized Disc Recording



INFO

You can start and stop both disc play and tape recording at the same time.

1 Load a disc and insert a recordable cassette.

2 Select a disc.

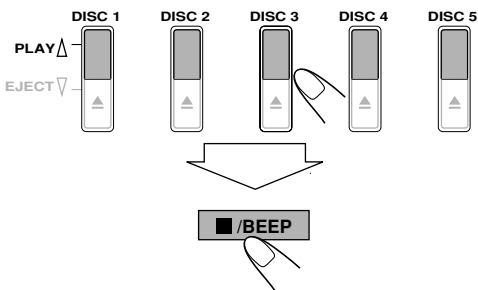

For recording desired tracks on discs:

You can program tracks to record from plural discs with your preferred order.

- Select Program Play (and make a program (see page 28)) without starting playback.

To record without creating a 4-second blank

- 1 Press DVD/CD ►, then press II.
- 2 Press ◀◀ to go back to the beginning of the track.
- 3 Start recording.

To protect your recording

Cassettes have two small tabs on the back to protect from unexpected erasure or re-recording.

To protect your recording, remove these tabs.



To re-record on a protected tape, cover the holes with adhesive tape.

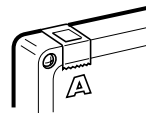

3 Check the tape running direction and Reverse Mode settings on the display.

- See step 2 of “Recording on a Tape” on page 36.

Timer Operations

Main unit

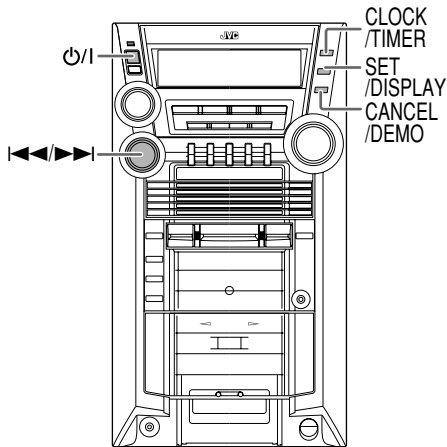

Setting the Timer



INFO

Using Daily Timer, you can wake up with your favorite song. On the other hand, with Recording Timer, you can make a tape of a radio broadcast automatically.

- To correct a misentry during the process, press CANCEL/DEMO. You can return to the previous step.

1 Select one of the timer setting modes (TIMER (ON)) you want to set—Daily Timer or Recording Timer.

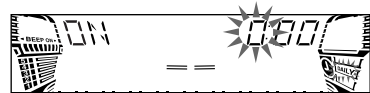
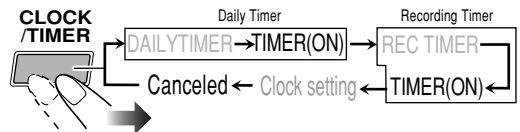

Ex.: When Daily timer setting mode is selected.

2 Make the timer setting as you want.

Repeat the procedure until you finish setting in the following order:

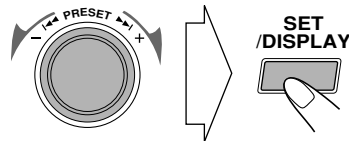

- 1 Set the hour then minute for on-time.
- 2 Set the hour then minute for off-time.
- 3 For Daily Timers: Select the playback source—“TUNER-FM,” “TUNER-AM,” “DISC,” “TAPE” or “AUX IN.”

For Recording Timer: Select the playback source—“TUNER-FM” or “TUNER-AM.”



Ex.: When “TUNER-FM” is selected.

- 4 Select a preset station for “TUNER-FM” and “TUNER-AM,” or select a disc, group and track number for “DISC.”

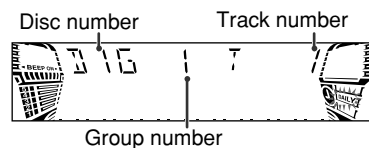

Ex.: When “DISC” is selected.

⑤ **For Daily Timers:**

- You can select the volume level (“VOLUME 5,” “VOLUME 10,” “VOLUME 15” and “VOLUME --”). If you select “VOLUME --,” the volume is set to the last level when the system has been turned off.

3 Turn off the System (on standby) if you have set the timer with the System turned on.



How Daily Timer actually works

Once the Daily Timer has been set, the timer (⏰) indicator and DAILY indicator are lit on the display. Daily Timer is activated at the same time everyday until the timer is turned off manually (see the next column).

When the on-time comes

The System turns on, tunes in to the specified station or starts playing the specified source, and sets the volume level to the preset level.

When the off-time comes

The System stops playback, and turns off (stands by).
 • The timer setting remains in memory until you change it.

How Recording Timer actually works

When Recording Timer has been set, Timer (⏰) indicator and the REC indicator are lit on the display. Recording Timer works only once.

When the on-time comes

The System turns on, tunes in to the specified station, sets the volume level to “VOLUME MIN,” and starts recording.

When the off-time comes

The System stops recording, and turns off (stands by).
 • The timer setting remains in memory until you change it.

Even if the System is power on condition and selected other source, Recording Timer will be activated.

To turn off the Timer after its setting is done

You can turn off the timer after it has been set.

- Since Daily Timer is activated at the same time everyday, you may need to cancel it on some particular days.

1 Select the timer (DAILYTIMER or REC TIMER) you want to cancel.

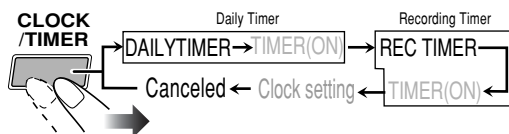

2 Turn off the selected timer.

CANCEL / DEMO



- The timer (⏰) indicator goes off.

To turn on the timer again, repeat the step 1 and press SET/DISPLAY.

SET / DISPLAY



Timer Priority

INFO

Since each timer can be set separately, you may wonder what happens if the setting for these timers overlaps.

- Recording Timer has priority over the Daily Timer and Sleep Timer (see page 21).

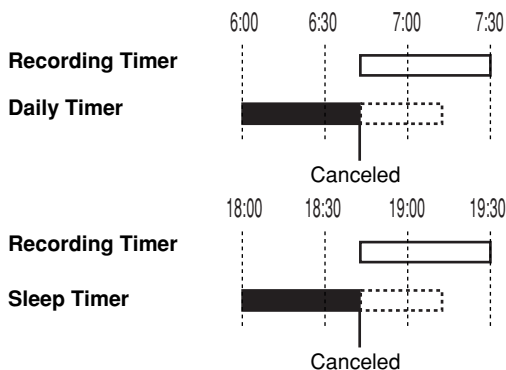

Set up Menu Operations

Remote control

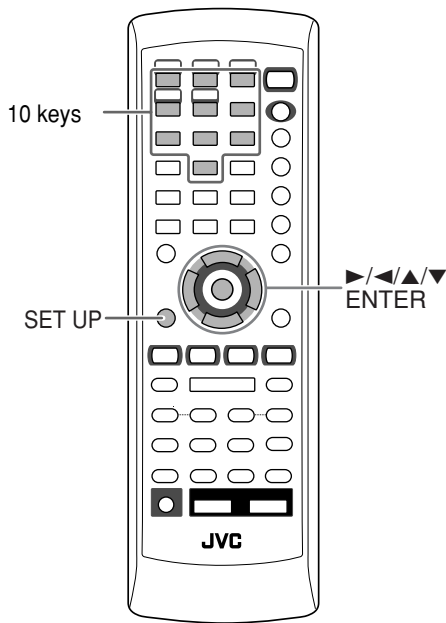

Set up Menu Icons

The icon for the selected Set up Menu will be highlighted.

Ex.: LANGUAGE Set up Menu is selected.

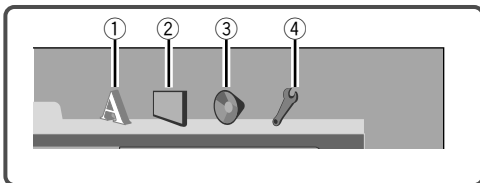

- ① LANGUAGE Set up Menu
- ② PICTURE Set up Menu
- ③ AUDIO Set up Menu
- ④ OTHERS Set up Menu

Operating Procedure



You can use the Set up Menus only when a disc is selected as the source and its playback is not yet started.

Ex.: Selecting "STILL PICTURE" for "FILE TYPE":

1 Show the set up menu.

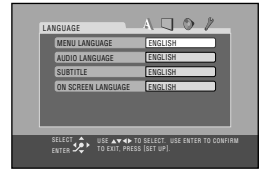

2 Select one of the set up menus.

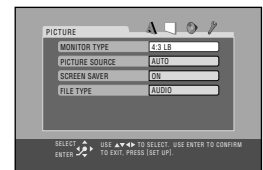
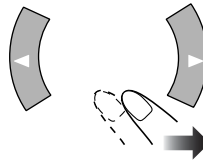

3 Select the item you want to adjust.

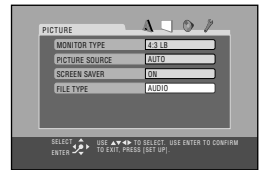
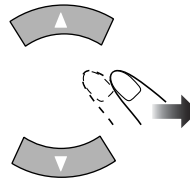

4 Display the pop-up window.

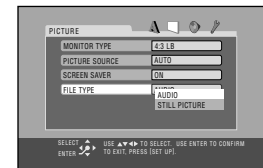

5 Select the desired option in the pop-up window.

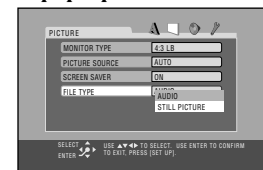
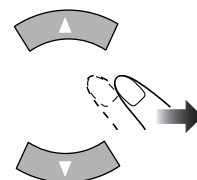

6 Finish the setting.



- 7 Repeat steps 3 to 4 to set other items on the same Set up Menu.
Repeat steps 2 to 4 to set other items on another Set up Menu.

To finish the Set up Menu

SET UP



■ LANGUAGE Set up Menu

INFO

You can select the initial languages for disc playback. You can also select the language shown on the TV screen while operating this System.

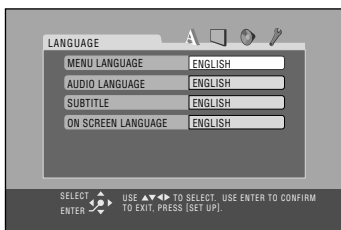

MENU LANGUAGE

Some discs have multiple menu languages. Select from—ENGLISH, SPANISH, FRENCH, CHINESE, GERMAN, ITALIAN, JAPANESE, AA – ZU (see “Language Code List” on page 52).

AUDIO LANGUAGE

Some discs have multiple audio languages. Select from—ENGLISH, SPANISH, FRENCH, CHINESE, GERMAN, ITALIAN, JAPANESE, AA – ZU (see “Language Code List” on page 52).

SUBTITLE

Some discs have multiple subtitle languages. Select from—ENGLISH, SPANISH, FRENCH, CHINESE, GERMAN, ITALIAN, JAPANESE, AA – ZU (see “Language Code List” on page 52) or “OFF (no subtitle).”

ON SCREEN LANGUAGE

Select one of the languages shown on the TV from—ENGLISH, FRENCH, and GERMAN.

■ PICTURE Set up Menu

INFO

You can select the desired options concerning a picture or monitor screen.

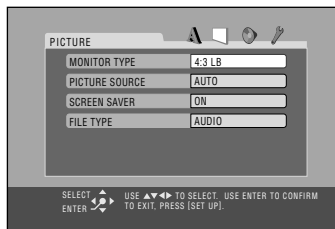

MONITOR TYPE

You can select the monitor type of your TV when you play DVD Video recorded with aspect ratio of 16:9.

Select one of the following:

16:9 (Wide television conversion):

Select when the aspect ratio of your TV is 16:9 (wide TV) and when the TV has the screen size adjustment function.

4:3 LB (Letter Box):

Select when the aspect ratio of your TV is 4:3 (conventional TV). While viewing a wide screen picture, the black bars appear on the top and the bottom of the screen.

4:3 PS (Pan Scan):

Select when the aspect ratio of your TV is 4:3 (conventional TV). While viewing a wide screen picture, the black bars do not appear; however, the left and right edges of the pictures will not be shown on the screen.

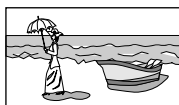

Ex.: 16:9

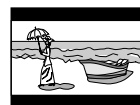

Ex.: 4:3 LB

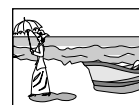

Ex.: 4:3 PS

PICTURE SOURCE

You can obtain optimal picture quality by selecting an appropriate option—picture source type (either video source or film source).

Select one of the following:

AUTO: Normally select this.
When playing back a disc containing both video and film sources, the System automatically changes the processing to match it to the picture type (film or video source) of the current chapter.

FILM: To play a film source disc.

VIDEO: To play a video source disc.

SCREEN SAVER

You can activate or deactivate screen saver while operating the built-in disc player.

Select one of the following:

ON: The pictures on the TV becomes dark when no operation is done for about 5 minutes.

OFF: To cancel the screen saver.

FILE TYPE

If both audio tracks (MP3 or WMA files) and still picture (JPEG files) are recorded on a disc, you can select which to play.

Select one of the following:

AUDIO: To play MP3/WMA files.

STILL PICTURE: To play JPEG files.

AUDIO Set up Menu

INFO

You can adjust the sound settings of the System.



DIGITAL AUDIO OUTPUT

When using the digital output terminal on the rear, set this correctly according to the connected component.

Select one of the following:

PCM ONLY: To connect to a linear PCM digital equipment such as an MD recorder.

DOLBY DIGITAL /PCM: To connect to a Dolby Digital decoder or an amplifier with a built-in Dolby Digital decoder.

STREAM/PCM: To connect to a DTS decoder or an amplifier with a built-in DTS decoder.

- See also “OPTICAL DIGITAL OUTPUT Signals” on page 54.

DOWN MIX

When playing a multi-channel DVD, the System converts the signals into 2 channels.

Downmix setting is effective for the speaker output (and digital audio output if “DIGITAL AUDIO OUTPUT” is set to “PCM ONLY”) from this System.

Select one of the following:

DOLBY To connect an amplifier with the Dolby

SURROUND: Pro Logic decoder.

STEREO: To connect a conventional stereo amplifier, receiver, MD player, TV, etc.

D. RANGE COMPRESSION

You can compress the dynamic range (the difference between the loudest sound and the softest sound) to enjoy a powerful sound even at a low volume level when listening to Dolby Digital software. This is useful at night.

- The effectiveness varies depends on a software.

Select one of the following:

AUTO: To enjoy powerful sounds with full dynamic range.

ON: Best for watching a movie at a low volume level.

AV COMPULINK MODE

This function is equipped for future use.

- Keep this setting to the initial setting (**DVD1**) for this System.

PARENTAL LOCK

Select this to enter the PARENTAL LOCK submenu. See the section that follows.

■ OTHERS Set up Menu

INFO

You can change some other convenient functions.

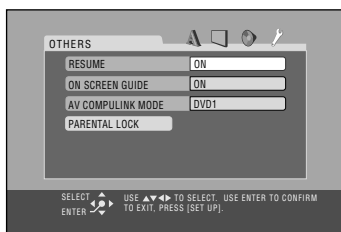

RESUME

You can activate or deactivate Resume for disc playback (see page 14).

Select one of the following:

ON: To activate Resume.

OFF: To cancel Resume.

ON SCREEN GUIDE

You can activate or deactivate the on-screen guide icons (see page 14).

- When recording the picture on a VCR, select "OFF" to avoid recording the guide icons on your video tape.

Select one of the following:

ON: To activate the on-screen guide icons.

OFF: To cancel the on-screen guide icons.

Restricting the Review

Parental Lock

You can restrict playback of DVD Video containing violent scenes and those unsuitable for your family members. Once you have set the rating level, such violent scenes (for which a higher level than you set is assigned) may be skipped or changed to another scene (depending on how the disc is programmed).

To set Parental Lock

Set the rating level—Level 1 (most restrictive) to Level 8 (least restrictive).

1 Display the Set up Menu.

SET UP

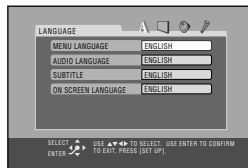

2 Select the OTHERS Set up Menus.

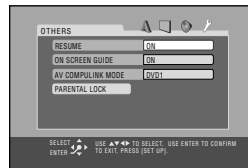
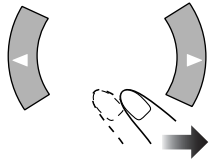

3 Select "PARENTAL LOCK."

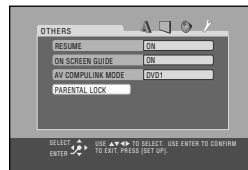
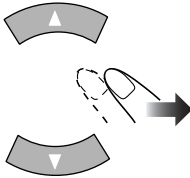

4 Enter the PARENTAL LOCK submenu.



5 Select "COUNTRY CODE," then display the pop-up window.

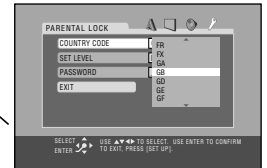
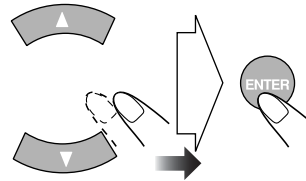

6 Select the country code of your area.

- See "Country/Area codes list for Parental Lock" on page 53 to find your country code.

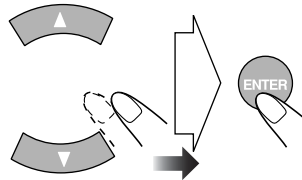

7 Select "SET LEVEL," then display the pop-up window.

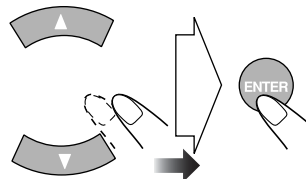

8 Set the rating level (NONE, 8 – 1).

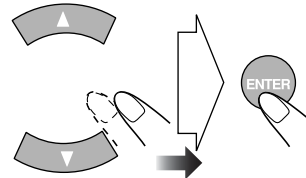

The System automatically enters password entry mode.

9 Enter any 4-digit number for your password.

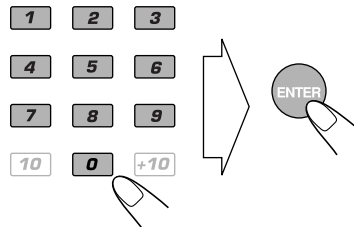

10 Finish the setting.

SET UP



To change the setting

1 Display the PARENTAL LOCK sub menu.

- Follow steps 1 to 4 of “To set Parental Lock”.



“PASSWORD” is automatically selected.

- You cannot select any item other than “EXIT” until you enter the correct password.

2 Enter your password.

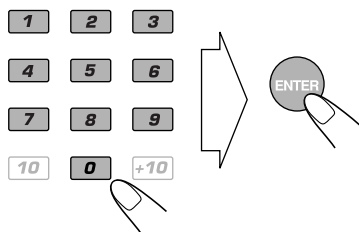

- If you enter a wrong password, “-----” appears again.
- If you enter a wrong password three times, “EXIT” is automatically selected. In this case, press ENTER to exit from the PARENTAL LOCK submenu.
- If you forget your password, enter “8888.”

3 Change the settings.

- Follow steps 5 to 8 of “To set Parental Lock”.

4 Enter your password again.

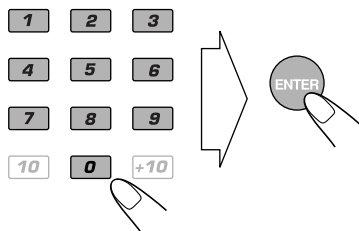

- If you want to change a password, enter a new four digit number in this step.

To release Parental Lock temporarily

When you set a strict rating level, some discs may not be played back at all. When you try to play such a disc, the following screen appears on the TV screen.

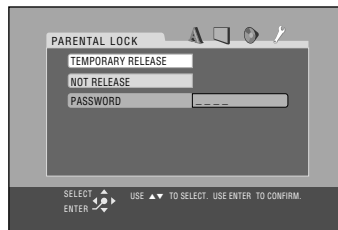

1 Select “TEMPORARY RELEASE,” then ENTER.

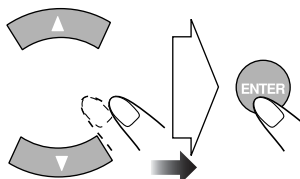

“PASSWORD” is automatically selected.

- If you do not play back such a disc, select “NOT RELEASE,” then ENTER. Then eject the disc.

2 Enter your password.

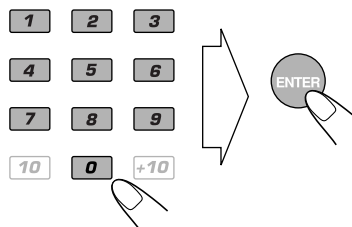

- If you enter a wrong password three times, “NOT RELEASE” is automatically selected. In this case, press ENTER. Then eject the disc.

Operating the TV

Remote control

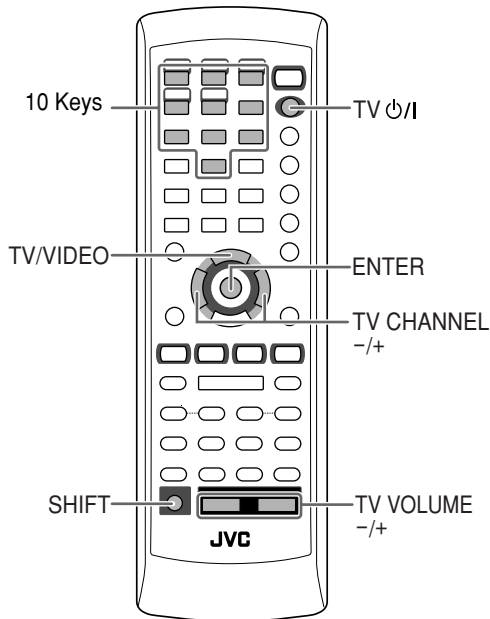

Manufacture's code			
Manufacture	Code number	Manufacture	Code number
JVC	01	Nordmende	13,14,18,26,27,28
Akai	02,05	Okano	09
Blaupunkt	03	Orion	15
Daewoo	10,31,32	Panasonic	16,17
Fenner	04,31,32	Philips	10
Fisher	05	Saba	13,14,18,26,27,28
Grundig	06	Samsung	10,19,32
Hitachi	07,08	Sanyo	05
Inno-Hit	09	Schneider	02,05
Irradio	02,05	Sharp	20
Magnavox	10	Sony	21,22,23,24,25
Mitsubishi	11,33	Telefunken	13,14,18,26,27,28
Miver	03	Thomson	13,14,18,26,27,28,30
Nokia	12,34	Toshiba	29

Operating TV



You can operate the JVC's or other manufacturers' TV using this remote control.

1 Keep pressing the button until the following steps are complete.

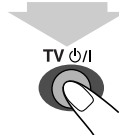

2 Enter the code setting mode.



3 Enter the 2-digit manufacture's code number.

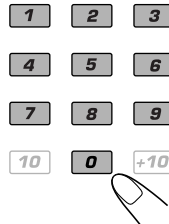

4 Release TV ON/OFF.

To operate the TV

To turn on or off the TV:



To select the input mode (either TV or VIDEO):

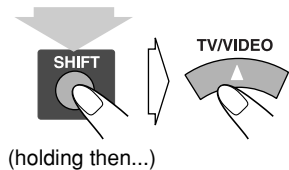

To adjust TV volume:

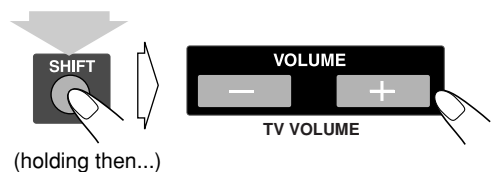

To select the TV channel:

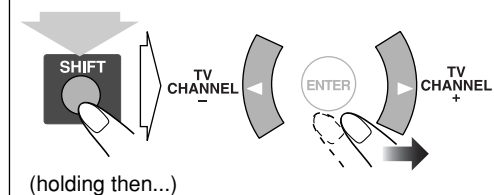

Additional Information

Learning More about This System ● ● ●

Before Operating the System (see pages 8 to 11)

Playable Disc Types:

• About audio format

- **Linear PCM:** Uncompressed digital audio, the same format used for CDs and most studio masters.
- **Dolby Digital:** Compressed digital audio, developed by Dolby Laboratories, which enables multi-channel encode to create the realistic surround sound.
- **DTS (Digital Theater Systems):** Compressed digital audio, developed by Digital Theater Systems, Inc., which enables multi-channel like Dolby Digital. As the compression ratio is lower than for Dolby Digital, it provides wider dynamic range and better separation.
- When playing back a DVD Audio disc recorded by MLP (Meridian Lossless Packing; a lossless audio compression system that can completely recreate the PCM signal), the signals recognized as the linear PCM signal, however, no indicator lights up in the display window.

Daily Operations—Playback (see pages 12 to 16)

Listening to the Radio:

- If you store a new station into an occupied preset number, the previously stored station in that number will be erased.
- When you unplug the AC power cord or if a power failure occurs, the preset stations will be erased in a few days. If this happens, preset the stations again.

Playing Back a Disc:

- On some DVD, SVCD, or VCD discs, the actual operations may be different from what is explained in this manual, due to the programming and disc structure; such differences are not a malfunction of this System.
- Some DVD Audios prohibit downmix. When you play back such a disc, “LR ONLY” appears on the display and the System plays back the left front and right front signals.
- For MP3/WMA/JPEG playback...
 - MP3/WMA/JPEG discs are required a longer readout time than regular CDs. (It depends on the complexity of the group/file configuration.)
 - Some MP3/WMA/JPEG files cannot be played back and will be skipped. This results from their recording processes and conditions.
 - When making MP3/WMA discs, use ISO 9660 Level 1 or Level 2 for the disc format.
 - This system can play back MP3/WMA/JPEG files with the extension code <.mp3>, <.wma> or <.jpg> (regardless of the letter case—upper/lower).
 - It is recommended that you make each MP3/WMA file at a sampling rate of 44.1 kHz and at bit rate of 128 kbps. This System cannot play back files made at bit rate of less than 64 kbps.

- When discs* in more than one tray are loaded on the disc trays, they are played in sequence as follows:

Ex.: When DISC 2 is pressed:

DISC 2⇒DISC 3⇒DISC 4⇒DISC 5⇒DISC 1
(then stops)

- * When no disc is loaded on the tray, that disc number is skipped.

Daily Operations—Sound&Other Adjustments

(see pages 17 to 21)

Adjusting the Volume:

- Be sure to turn down the volume before connecting or putting the headphones.

Reinforcing the Bass Sound:

- RHYTHM AX function also affects the sound through the headphones.
- While listening with the headphones, you cannot adjust the subwoofer level.
- RHYTHM AX function and subwoofer level setting does not affect recording.
- You can adjust the subwoofer level while RHYTHM AX is on.
- The subwoofer lamp changes brightness according to the subwoofer level.

Selecting the Sound Modes:

- The sound mode lamp and Surround mode lamp change brightness according to selecting Sound mode.

Creating Your Own Sound Modes—User Mode:

- When you unplug the AC power cord or if a power failure occurs, the USER mode settings will be erased in a few days. If this happens, set the USER Modes again.

Selecting 3D PHONIC Mode:

- While you use the headphones, 3D PHONIC mode is canceled temporary.
- 3D PHONIC setting is also applied to the optical digital output signals through the OPTICAL DIGITAL OUTPUT terminal.

Changing the Scanning Mode:

- To enjoy the progressive video picture, connect a TV with the progressive video input using component video cord.
- Do not change the progressive scanning mode in the following cases:
 - When your TV does not support the progressive video input.
 - When you have not connected your TV to the unit using a component video cord.

Changing the Picture Tone:

- If no operation is done for about 10 seconds, the VFP setting screen disappears.

Setting the Clock:

- “0:00” will flash on the display until you set the clock.
- The clock may gain or lose 1 to 2 minutes per month. If this happens, reset the clock.

Turning Off the Power Automatically:

- If you turn off the System, Sleep Timer is canceled.

Advanced Radio Operations (see pages 22 to 24)

Receiving FM Stations with RDS:

- If the System takes time to show the RDS information—PS, PTY, RT signals, “WAIT” will appear while searching.

Unique DVD/VCD Operations (see pages 25 to 27)

Selecting the Sound Track:

- On some DVD Videos, you cannot change audio languages while playing back.

Playing Back a Bonus Group on a DVD Audio:

- You cannot select a track in the bonus group for Program Play.

Special Picture Playback:

- During slow-motion playback, no sound will be reproduced.
- While zoomed in, the picture may look coarse.

Advanced Disc Operations (see pages 28 to 30)

Programming the Playing Order—Program Play:

- While programming steps...
Your entry will be ignored if you have tried to program an item number that does not exist on the disc (for example, selecting track 14 on a disc that only has 12 tracks). Such entries are ignored, and are erased from the program.
- For SVCD/VCD/CD, if the disc is not in current tray, the System may prompt for the group number entry as well, however, during playback, system will ignore these entries.
- You cannot use Program Play and Random Play for JPEG discs.

Playing at Random—Random Play:

- Random Play cannot be used on some DVD discs.

Prohibiting Disc Ejection—Child Lock:

- If you try to eject discs while Child Lock is in use, “LOCKED” appears to inform you that the disc trays are locked.

On-Screen Disc Operations (see pages 31 to 35)

Operations Using the On-screen Bar:

- **A-B Repeat:**
 - A-B Repeat cannot be used on some DVDs.
 - For DVD Video, A-B Repeat is possible only within the same title.
 - For DVD Audio/SVCD/VCD/CD, A-B Repeat is possible only within the same track.

Operations on the CONTROL Screen:

- For JPEG files playback...
 - It is recommended that you record a file at 640 x 480 resolution. (If a file has been recorded at a resolution of more than 640 x 480, it will take a long time to be shown.)
 - This System can play only baseline JPEG files*. Progressive JPEG files* or lossless JPEG files* cannot be played.
 - * Baseline JPEG format: Used for digital cameras, web, etc.
 - Progressive JPEG format: Used for web.
 - Lossless JPEG format: An old type and rarely used now.
- This unit may not play back JPEG files properly which are recorded by the devices other than digital still camera.
- During Slide-show playback, zoom cannot be operated.

Advanced Tape Operations (see pages 36 and 37)

Recording on a Tape:

- The recording level is automatically set correctly. Thus, you can adjust the sound you are actually listening to without affecting the recording level.
- There is leader tape which cannot be recorded onto at the start and the end of cassette tapes. Thus, when recording discs or radio broadcasts, wind the leader tape first to ensure that the recording will be made without any music part lost.
- If no cassette is inserted, “NO TAPE” appears on the display. If a protected tape has been inserted, “NO REC” appears on the display.
- When using Reverse Mode for recording, start recording in the forward (▶) direction first; otherwise, recording will stop when only one side (reverse) of the tape is recorded.
- You cannot change source during recording.

Synchronized Disc Recording:

- While recording, you cannot use ▶▶/◀◀, ▶▶/◀◀, DVD LEVEL, 3D PHONIC and source buttons.
- You can adjust volume control and sound setting (subwoofer level, RHYTHM AX, Sound mode) but the settings do not affect the recording sound.
- Everything on the disc goes onto the tape in the order on the disc, or according to the order you have made for Program Play.
- You cannot use Synchronized Recording with Repeat Play (Repeat Play will be canceled).
- When recording starts, “DISC REC” appears on the display and the REC (recording) indicator flashes.
- When the tape reaches its end in the forward direction (▶) during recording, the last song will be re-recorded at the beginning of the reverse side (◀).
- When the tape reaches its end in the reverse side (◀) during recording, recording stops even though the entire disc is not entirely recorded.

Timer Operations (see pages 38 to 39)

Setting the Timer:

- If you do not specify the preset station or track number correctly while setting a timer, the currently selected station or the first track will be played when timer is activated.
- When you unplug the AC power cord or if a power failure occurs, the timer will be canceled. You need to set the clock first, then the timer again.
- Without stopping the recording, you cannot change the source after Recording Timer starts recording.
- If you set DVD Video as the source, Daily Timer will not work correctly.

Timer Priority:

- If you set the Sleep Timer after Daily Timer starts playing the selected source, Daily Timer is canceled.
- If you set the Sleep Timer after Recording Timer starts recording, Recording Timer is canceled, but recording continues until Sleep Timer shuts off the power.

Set up Menu Operations (see pages 40 to 45)

LANGUAGE Set up Menu:

- When the language you have selected for MENU LANGUAGE, AUDIO LANGUAGE, or SUBTITLE is not recorded on a disc, the original language is used as the initial language.

PICTURE Set up Menu—MONITOR TYPE:

- Even if “4:3 PS” is selected, the screen size may become 4:3 letter box with some DVD Videos. This depends on how the discs are recorded.
- When you select “16:9” for a picture whose aspect ratio is 4:3, the picture slightly changes due to the process for converting the picture width.

AUDIO Set up Menu—DOWN MIX:

- This setting is not effective when DTS multi-channel software is played back.

OTHERS Set up Menu—ON SCREEN GUIDE:

- The set up menu and on-screen bar will be displayed (and recorded) even though this function is set to “OFF.” Subtitles and the information for zooming in always appear on the display regardless of this setting.

Troubleshooting

If you are having a problem with your System, check this list for a possible solution before calling for service.

General:

Adjustments or settings are suddenly canceled before you finish.

⇒ There is a time limit. Repeat procedure again.

Operations are disabled.

⇒ The built-in microprocessor may malfunction due to external electrical interference. Unplug the AC power cord and then plug it back in.

Unable to operate the System from the remote control.

⇒ The path between the remote control and the remote sensor on the System is blocked.

⇒ The batteries are exhausted.

No sound is heard.

⇒ Speaker connections are incorrect or loose.

⇒ Headphones are connected.

No picture appears on the screen.

⇒ The video cord/SCART cord connections are incorrect or loose.

No picture is displayed on the TV screen, the picture is blurred, or the picture is divided into two parts.

⇒ The System is connected to a TV which does not support progressive video input.

The left and right edges of the picture are missing on the screen.

⇒ Select "4:3 LB" for "MONITOR TYPE" (see page 41).

Radio Operations:

Hard to listen to broadcasts because of noise.

⇒ Antennas connections are incorrect or loose.

⇒ The AM loop antenna is too close to the System.

⇒ The FM antenna is not properly extended and positioned.

Disc Operations:

The disc does not play.

⇒ The disc is placed upside down. Place the disc with the label side up.

⇒ Parental Lock is in use (see page 44).

ID3 Tag on an MP3 disc cannot be shown.

⇒ There are two types of ID3 Tag—Version 1 and Version 2. This System can only show ID3 Tag Version 1.

MP3 groups and tracks are not played back as you expect.

⇒ The playing order is determined when the disc was recorded. It depends on the writing application.

MP3/WMA or JPEG files are not played back.

⇒ The inserted disc may include both type of tracks (MP3/WMA files and JPEG files). In this case, you can only play back the files selected by the "FILE TYPE" setting (see page 42).

⇒ You have changed the "FILE TYPE" setting after you inserted a disc. In this case, reload the disc.

The disc sound is discontinuous.

⇒ The disc is scratched or dirty.

No subtitle appears on the display though you have selected the initial subtitle language.

⇒ Some DVDs are programmed to always display no subtitle initially. If this happens, press SUB TITLE after starting play (see page 26).

Audio language is different from the one you have selected as the initial audio language.

⇒ Some DVDs are programmed to always use the original language initially. If this happens, press AUDIO after starting play (see page 25).

The disc tray does not open or close.

⇒ The AC power cord is not plugged in.

⇒ Child Lock is in use (see page 30).

Tape Operations:

The Cassette holder cannot be opened.

⇒ Power supply from the AC power cord has been cut off while tape was running. Turn on the System.

Recordings:

Impossible to record.

⇒ Small tabs on the back of the cassette are removed. Cover the holes with adhesive tape.

Timer operations:

Daily Timer does not work.

⇒ The System has been turned on when the on-time comes. Timer starts working only when the System is turned off.

Maintenance

To get the best performance of the System, keep your discs, tapes, and mechanism clean.

Handling discs

- Remove the disc from its case by holding it at the edge while pressing the center hole lightly.
- Do not touch the shiny surface of the disc, or bend the disc.
- Put the disc back in its case after use to prevent warping.
- Be careful not to scratch the surface of the disc when placing it back in its case.
- Avoid exposure to direct sunlight, temperature extremes, and moisture.

To clean the disc:

- Wipe the disc with a soft cloth in a straight line from center to edge.

Handling cassette tapes

- If the tape is loose in its cassette, take up the slack by inserting a pencil in one of the reels and rotate it.
 - If the tape is loose, it may get stretched, cut, or caught in the cassette.
- Be careful not to touch the tape surface.
- Avoid the following places to store the tape—in dusty places, in direct sunlight or heat, in moist areas, on a TV or speaker, or near a magnet.

To keep the best recording and playback sound quality:

- Use a cotton swab moistened with alcohol to clean the heads, capstans, and pinch rollers.
- Use a head demagnetizer (available at electronics and audio shops) to demagnetize the heads (when the System turned off).

Cleaning the System

- Stains should be wiped off with a soft cloth. If the System is heavily stained, wipe it with a cloth soaked in water-diluted neutral detergent and wrung well, then wipe clean with a dry cloth.
- Since the System may deteriorate in quality, become damaged or get its paint peeled off, be careful about the following:
 - DO NOT wipe it with a hard cloth.
 - DO NOT wipe it strong.
 - DO NOT wipe it with thinner or benzine.
 - DO NOT apply any volatile substance such as insecticides to it.
 - DO NOT allow any rubber or plastic to remain in contact for a long time.

Language Code List

AA	Afar
AB	Abkhazian
AF	Afrikaans
AM	Ameharic
AR	Arabic
AS	Assamese
AY	Aymara
AZ	Azerbaijani
BA	Bashkir
BE	Byelorussian
BG	Bulgarian
BH	Bihari
BI	Bislama
BN	Bengali, Bangla
BO	Tibetan
BR	Breton
CA	Catalan
CO	Corsican
CS	Czech
CY	Welsh
DA	Danish
DZ	Bhutani
EL	Greek
EO	Esperanto
ET	Estonian
EU	Basque
FA	Persian
FI	Finnish
FJ	Fiji
FO	Faroese
FY	Frisian
GA	Irish
GD	Scots Gaelic
GL	Galician
GN	Guarani
GU	Gujarati
HA	Hausa
HI	Hindi
HR	Croatian
HU	Hungarian
HY	Armenian
IA	Interlingua
IE	Interlingue
IK	Inupiak
IN	Indonesian
IS	Icelandic
IW	Hebrew
JI	Yiddish

JW	Javanese
KA	Georgian
KK	Kazakh
KL	Greenlandic
KM	Cambodian
KN	Kannada
KO	Korean (KOR)
KS	Kashmiri
KU	Kurdish
KY	Kirghiz
LA	Latin
LN	Lingala
LO	Laothian
LT	Lithuanian
LV	Latvian, Lettish
MG	Malagasy
MI	Maori
MK	Macedonian
ML	Malayalam
MN	Mongolian
MO	Moldavian
MR	Marathi
MS	Malay (MAY)
MT	Maltese
MY	Burmese
NA	Nauru
NE	Nepali
NL	Dutch
NO	Norwegian
OC	Occitan
OM	(Afan) Oromo
OR	Oriya
PA	Panjabi
PL	Polish
PS	Pashto, Pushto
PT	Portuguese
QU	Quechua
RM	Rhaeto-Romance
RN	Kirundi
RO	Rumanian
RU	Russian
RW	Kinyarwanda
SA	Sanskrit
SD	Sindhi
SG	Sangho
SH	Serbo-Croatian
SI	Singhalese
SK	Slovak

SL	Slovenian
SM	Samoan
SN	Shona
SO	Somali
SQ	Albanian
SR	Serbian
SS	Siswati
ST	Sesotho
SU	Sundanese
SV	Swedish
SW	Swahili
TA	Tamil
TE	Telugu
TG	Tajik
TH	Thai
TI	Tigrinya
TK	Turkmen
TL	Tagalog
TN	Setswana
TO	Tonga
TR	Turkish
TS	Tsonga
TT	Tatar
TW	Twi
UK	Ukrainian
UR	Urdu
UZ	Uzbek
VI	Vietnamese
VO	Volapuk
WO	Wolof
XH	Xhosa
YO	Yoruba
ZU	Zulu

Country/Area codes list for Parental Lock

AD	Andorra
AE	United Arab Emirates
AF	Afghanistan
AG	Antigua and Barbuda
AI	Anguilla
AL	Albania
AM	Armenia
AN	Netherlands Antilles
AO	Angola
AQ	Antarctica
AR	Argentina
AS	American Samoa
AT	Austria
AU	Australia
AW	Aruba
AZ	Azerbaijan
BA	Bosnia and Herzegovina
BB	Barbados
BD	Bangladesh
BE	Belgium
BF	Burkina Faso
BG	Bulgaria
BH	Bahrain
BI	Burundi
BJ	Benin
BM	Bermuda
BN	Brunei Darussalam
BO	Bolivia
BR	Brazil
BS	Bahamas
BT	Bhutan
BV	Bouvet Island
BW	Botswana
BY	Belarus
BZ	Belize
CA	Canada
CC	Cocos (Keeling) Islands
CF	Central African Republic
CG	Congo
CH	Switzerland
CI	Côte d'Ivoire
CK	Cook Islands
CL	Chile
CM	Cameroon
CN	China
CO	Colombia
CR	Costa Rica
CU	Cuba
CV	Cape Verde
CX	Christmas Island
CY	Cyprus
CZ	Czech Republic
DE	Germany
DJ	Djibouti

DK	Denmark
DM	Dominica
DO	Dominican Republic
DZ	Algeria
EC	Ecuador
EE	Estonia
EG	Egypt
EH	Western Sahara
ER	Eritrea
ES	Spain
ET	Ethiopia
FI	Finland
FJ	Fiji
FK	Falkland Islands (Malvinas)
FM	Micronesia (Federated States of)
FO	Faroe Islands
FR	France
FX	France, Metropolitan
GA	Gabon
GB	United Kingdom
GD	Grenada
GE	Georgia
GF	French Guiana
GH	Ghana
GI	Gibraltar
GL	Greenland
GM	Gambia
GN	Guinea
GP	Guadeloupe
GQ	Equatorial Guinea
GR	Greece
GS	South Georgia and the South Sandwich
GT	Guatemala
GU	Guam
GW	Guinea-Bissau
GY	Guyana
HK	Hong Kong
HM	Heard Island and McDonald Islands
HN	Honduras
HR	Croatia
HT	Haiti
HU	Hungary
ID	Indonesia
IE	Ireland
IL	Israel
IN	India
IO	British Indian Ocean Territory
IQ	Iraq
IR	Iran (Islamic Republic of)
IS	Iceland
IT	Italy
JM	Jamaica

JO	Jordan
JP	Japan
KE	Kenya
KG	Kyrgyzstan
KH	Cambodia
KI	Kiribati
KM	Comoros
KN	Saint Kitts and Nevis
KP	Korea, Democratic People's Republic of
KR	Korea, Republic of
KW	Kuwait
KY	Cayman Islands
KZ	Kazakhstan
LA	Lao People's Democratic Republic
LB	Lebanon
LC	Saint Lucia
LI	Liechtenstein
LK	Sri Lanka
LR	Liberia
LS	Lesotho
LT	Lithuania
LU	Luxembourg
LV	Latvia
LY	Libyan Arab Jamahiriya
MA	Morocco
MC	Monaco
MD	Moldova, Republic of
MG	Madagascar
MH	Marshall Islands
ML	Mali
MM	Myanmar
MN	Mongolia
MO	Macau
MP	Northern Mariana Islands
MQ	Martinique
MR	Mauritania
MS	Montserrat
MT	Malta
MU	Mauritius
MV	Maldives
MW	Malawi
MX	Mexico
MY	Malaysia
MZ	Mozambique
NA	Namibia
NC	New Caledonia
NE	Niger
NF	Norfolk Island
NG	Nigeria
NI	Nicaragua
NL	Netherlands
NO	Norway

NP	Nepal
NR	Nauru
NU	Niue
NZ	New Zealand
OM	Oman
PA	Panama
PE	Peru
PF	French Polynesia
PG	Papua New Guinea
PH	Philippines
PK	Pakistan
PL	Poland
PM	Saint Pierre and Miquelon
PN	Pitcairn
PR	Puerto Rico
PT	Portugal
PW	Palau
PY	Paraguay
QA	Qatar
RE	Réunion
RO	Romania
RU	Russian Federation
RW	Rwanda
SA	Saudi Arabia
SB	Solomon Islands
SC	Seychelles
SD	Sudan

SE	Sweden
SG	Singapore
SH	Saint Helena
SI	Slovenia
SJ	Svalbard and Jan Mayen
SK	Slovakia
SL	Sierra Leone
SM	San Marino
SN	Senegal
SO	Somalia
SR	Suriname
ST	Sao Tome and Principe
SV	El Salvador
SY	Syrian Arab Republic
SZ	Swaziland
TC	Turks and Caicos Islands
TD	Chad
TF	French Southern Territories
TG	Togo
TH	Thailand
TJ	Tajikistan
TK	Tokelau
TM	Turkmenistan
TN	Tunisia
TO	Tonga
TP	East Timor
TR	Turkey

TT	Trinidad and Tobago
TV	Tuvalu
TW	Taiwan
TZ	Tanzania, United Republic of
UA	Ukraine
UG	Uganda
UM	United States Minor Outlying Islands
US	United States
UY	Uruguay
UZ	Uzbekistan
VA	Vatican City State (Holy See)
VC	Saint Vincent and the Grenadines
VE	Venezuela
VG	Virgin Islands (British)
VI	Virgin Islands (U.S.)
VN	Vietnam
VU	Vanuatu
WF	Wallis and Futuna Islands
WS	Samoa
YE	Yemen
YT	Mayotte
YU	Yugoslavia
ZA	South Africa
ZM	Zambia
ZR	Zaire
ZW	Zimbabwe

OPTICAL DIGITAL OUTPUT Signals

DIGITAL AUDIO OUTPUT	Output Signals		
	STREAM/PCM	DOLBY DIGITAL/PCM	PCM ONLY
Playback disc			
DVD Video			
with 48 kHz, 16/20/24 bit Linear PCM		48 kHz, 16 bit Linear PCM*	
with 96 kHz, Linear PCM		48 kHz, 16 bit Linear PCM	
with Dolby Digital	Dolby Digital bitstream		48 kHz, 16 bit Linear PCM
with DTS Digital Surround	DTS bitstream	48 kHz, 16 bit Linear PCM	
DVD Audio			
with 48/96/192 kHz, 16/20/24 bit Linear PCM		48 kHz, 16 bit Linear PCM	
with 44.1/88.2/176.4 kHz, 16/20/24 bit Linear PCM		44.1 kHz, 16 bit Linear PCM	
with Dolby Digital	Dolby Digital bitstream		48 kHz, 16 bit Linear PCM
with DTS Digital Surround	DTS bitstream	48 kHz, 16 bit Linear PCM	
SVCD, VCD, CD	44.1 kHz, 16 bit Linear PCM*/48 kHz, 16 bit Linear PCM*		
CD with DTS Digital Surround	DTS bitstream	44.1 kHz, 16 bit Linear PCM	
MP3/WMA disc	32/44.1/48 kHz, 16 bit Linear PCM		

* While playing some DVDs, digital signals may be emitted at 20 bits or 24 bits (at their original bit rate) through the OPTICAL DIGITAL OUTPUT terminal if the discs are not copy-protected.

Specifications

CA-HXGD7

Amplifier section

Output Power:

SUBWOOFERS: 100 W per channel, min. RMS, driven into 6 Ω at 63 Hz with no more than 10% total harmonic distortion.

MAIN SPEAKERS: 40 W per channel, min. RMS, driven into 6 Ω at 1 kHz with no more than 10% total harmonic distortion.

Audio input sensitivity/impedance

(Measured at 1 kHz, with tape recording signal 300 mV)

AUX: 300 mV/47 k Ω

Digital output:

OPTICAL DIGITAL OUTPUT:

-21 dBm to -15 dBm (660 nm \pm 30 nm)

VIDEO OUT:

Color system: PAL

AV OUT (composite): 1 V(p-p)/75 Ω

(S-VIDEO): Y (luminance) 1 V(p-p)/75 Ω

C (chrominance, burst)
0.286 V(p-p)/75 Ω

(RGB): 0.7 V(p-p)/75 Ω

COMPONENT: (Y) 1 V(p-p)/75 Ω

(Interlace/Progressive) (P_B/P_R) 0.7 V(p-p)/75 Ω

Speaker Terminals: 6 Ω – 16 Ω (main speakers)

6 Ω – 16 Ω (subwoofers)

Others:

AV COMPU LINKx2 (ϕ 3.5)

Tuner section

FM tuning range: 87.50 MHz – 108.00 MHz

AM (MW) tuning range: 522 kHz – 1 629 kHz

Disc player section

Playable disc: DVD Video/DVD Audio/CD/VCD/SVCD

CD-R/CD-RW (recorded in Audio CD/
Video CD/ Super Video CD/ MP3/ WMA/
JPEG format)

DVD-R/DVD-RW (recorded in video
format)

Dynamic range: 90 dB

Horizontal resolution: 500 lines

Wow and flutter: Immeasurable

Cassette deck section

Frequency response

Normal (type I): 50 Hz – 14 000 Hz

Wow and flutter: 0.15% (WRMS)

General

Power requirement: AC 230 V \sim , 50 Hz

Power consumption: 185 W (at operation)
25 W (on standby with ECOLOGY
mode off)

1.4 W (on standby with ECOLOGY
mode on)

Dimensions (approx.): 205 mm x 370 mm x 432 mm
(W/H/D)

Mass (approx.): 10.5 kg

Supplied Accessories

See page 3.

Design and specifications are subject to change without notice.

CA-HXGD8

Amplifier section

Output Power:

SUBWOOFERS: 140 W per channel, min. RMS, driven into 6 Ω at 63 Hz with no more than 10% total harmonic distortion.

MAIN SPEAKERS: 60 W per channel, min. RMS, driven into 6 Ω at 1 kHz with no more than 10% total harmonic distortion.

Audio input sensitivity/impedance

(Measured at 1 kHz, with tape recording signal 300 mV)

AUX: 300 mV/47 k Ω

Digital output:

OPTICAL DIGITAL OUTPUT:

-21 dBm to -15 dBm (660 nm \pm 30 nm)

VIDEO OUT:

Color system: PAL

AV OUT (composite): 1 V(p-p)/75 Ω

(S-VIDEO): Y (luminance) 1 V(p-p)/75 Ω

C (chrominance, burst)

0.286 V(p-p)/75 Ω

(RGB): 0.7 V(p-p)/75 Ω

COMPONENT: (Y) 1 V(p-p)/75 Ω

(Interlace/Progressive) (Pb/Pr) 0.7 V(p-p)/75 Ω

Speaker Terminals: 6 Ω – 16 Ω (main speakers)

6 Ω – 16 Ω (subwoofers)

Others:

AV COMPU LINKx2 (ϕ 3.5)

Tuner section

FM tuning range: 87.50 MHz – 108.00 MHz

AM (MW) tuning range: 522 kHz – 1 629 kHz

Disc player section

Playable disc: DVD Video/DVD Audio/CD/VCD/SVCD

CD-R/CD-RW (recorded in Audio CD/
Video CD/ Super Video CD/ MP3/ WMA/
JPEG format)

DVD-R/DVD-RW (recorded in video
format)

Dynamic range: 90 dB

Horizontal resolution: 500 lines

Wow and flutter: Immeasurable

Cassette deck section

Frequency response

Normal (type I): 50 Hz – 14 000 Hz

Wow and flutter: 0.15 % (WRMS)

General

Power requirement: AC 230 V \sim , 50 Hz

Power consumption: 230 W(at operation)

25 W (on standby with ECOLOGY
mode off)

1.4 W (on standby with ECOLOGY
mode on)

Dimensions (approx.): 205 mm x 370 mm x 432 mm

(W/H/D)

Mass (approx.): 11 kg

Supplied Accessories

See page 3.

Design and specifications are subject to change without notice.

SAFETY INSTRUCTIONS

“SOME DOS AND DON'TS ON THE SAFE USE OF EQUIPMENT”

This equipment has been designed and manufactured to meet international safety standards but, like any electrical equipment, care must be taken if you are to obtain the best results and safety is to be assured.

☆☆

Do read the operating instructions before you attempt to use the equipment.

Do ensure that all electrical connections (including the mains plug, extension leads and interconnections between pieces of equipment) are properly made and in accordance with the manufacturer's instructions. Switch off and withdraw the mains plug when making or changing connections.

Do consult your dealer if you are ever in doubt about the installation, operation or safety of your equipment.

Do be careful with glass panels or doors on equipment.

☆☆

DON'T continue to operate the equipment if you are in any doubt about it working normally, or if it is damaged in any way—switch off, withdraw the mains plug and consult your dealer.

DON'T remove any fixed cover as this may expose dangerous voltages.

DON'T leave equipment switched on when it is unattended unless it is specifically stated that it is designed for unattended operation or has a standby mode.

Switch off using the switch on the equipment and make sure that your family know how to do this. Special arrangements may need to be made for infirm or handicapped people.

DON'T use equipment such as personal stereos or radios so that you are distracted from the requirements of traffic safety. It is illegal to watch television whilst driving.

DON'T listen to headphones at high volume as such use can permanently damage your hearing.

DON'T obstruct the ventilation of the equipment, for example with curtains or soft furnishings. Overheating will cause damage and shorten the life of the equipment.

DON'T use makeshift stands and **NEVER** fix legs with wood screws—to ensure complete safety always fit the manufacturer's approved stand or legs with the fixings provided according to the instructions.

DON'T allow electrical equipment to be exposed to rain or moisture.

ABOVE ALL

- **NEVER** let anyone, especially children, push anything into holes, slots or any other opening in the case—this could result in a fatal electrical shock.

- **NEVER** guess or take chances with electrical equipment of any kind—it is better to be safe than sorry!



Free Manuals Download Website

<http://myh66.com>

<http://usermanuals.us>

<http://www.somanuals.com>

<http://www.4manuals.cc>

<http://www.manual-lib.com>

<http://www.404manual.com>

<http://www.luxmanual.com>

<http://aubethermostatmanual.com>

Golf course search by state

<http://golfingnear.com>

Email search by domain

<http://emailbydomain.com>

Auto manuals search

<http://auto.somanuals.com>

TV manuals search

<http://tv.somanuals.com>