

JVC



DVD DIGITAL CINEMA SYSTEM

TH-D7

Consists of XV-THD7, SP-THD7W,
SP-THD7F, SP-THD7C and SP-THD7S

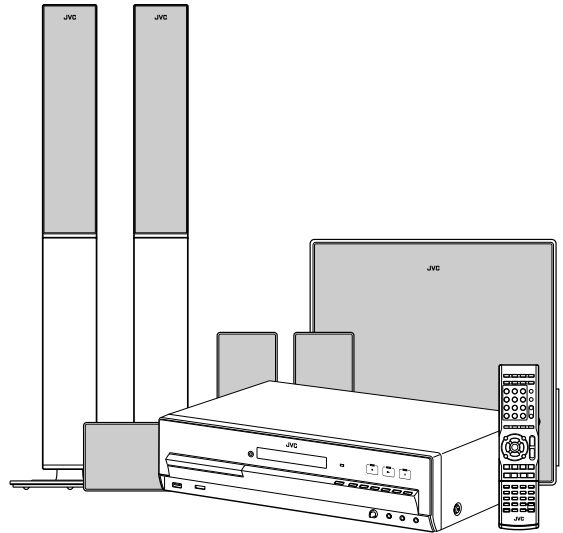

TH-D5

Consists of XV-THD5, SP-THD5W,
SP-THD5F, SP-THD5C and SP-THD5S

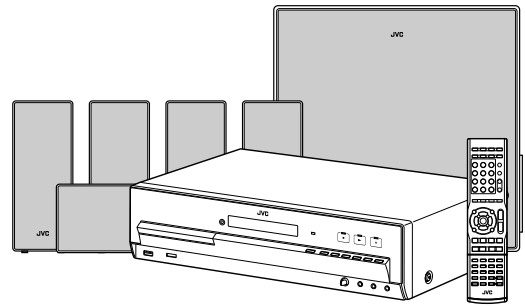

HDMI



MPEG-4
ASF PLAYBACK

Digital Direct Progressive Scan

INSTRUCTIONS

LVT1704-011B
[US,UW,UG,UX,UA]

Warnings, Cautions and Others

CAUTION — ϕ /I button!

Disconnect the mains plug to shut the power off completely (the STANDBY lamp goes off). When installing the apparatus, ensure that the plug is easily accessible.

The ϕ /I button in any position does not disconnect the mains line.

- When the system is on standby, the STANDBY lamp lights red.
- When the system is turned on, the STANDBY lamp goes off.

The power can be remote controlled.

CAUTION

To reduce the risk of electrical shocks, fire, etc.:

1. Do not remove screws, covers or cabinet.
2. Do not expose this appliance to rain or moisture.

CAUTION

- Do not block the ventilation openings or holes. (If the ventilation openings or holes are blocked by a newspaper or cloth, etc., the heat may not be able to get out.)
- Do not place any naked flame sources, such as lighted candles, on the apparatus.
- When discarding batteries, environmental problems must be considered and local rules or laws governing the disposal of these batteries must be followed strictly.
- Do not expose this apparatus to rain, moisture, dripping or splashing and that no objects filled with liquids, such as vases, shall be placed on the apparatus.

CAUTION:

Excessive sound pressure from earphones or headphones can cause hearing loss.

IMPORTANT FOR LASER PRODUCTS

1. CLASS 1 LASER PRODUCT
2. **CAUTION:** Do not open the top cover or cabinet. There are no user serviceable parts inside the unit; leave all servicing to qualified service personnel.
3. **CAUTION:** Visible and/or invisible class 1M laser radiation when open. Do not view directly with optical instruments.
4. REPRODUCTION OF LABEL: CAUTION LABEL, PLACED INSIDE THE UNIT.

CAUTION VISIBLE AND/OR INVISIBLE CLASS 1M LASER RADIATION WHEN OPEN. DO NOT VIEW DIRECTLY WITH OPTICAL INSTRUMENTS. IEC60825-1:2001 (EN)	ATTENTION RAYONNEMENT LASER VISIBLE ET/OU INVISIBLE DE CLASSE 1M UNE FOIS OUVERT. NE PAS REGARDER DIRECTEMENT AVEC DES INSTRUMENTS OPTIQUES. (FR)	AVISO RADIACION LASER DE CLASE 1M VISIBLE Y/O INVISIBLE CUANDO ESTA ABIERTO. NO MIRAR DIRECTAMENTE CON INSTRUMENTAL OPTICA. (ES)	WARNING SYNLIG OCH/ELLER OSYNLIG LASERSTRÅLNING, KLASS 1M, NÅR DENNA DEL ÄR ÖPPNAD. BETRÄKTA EJ STRÅLEN MED OPTISKA INSTRUMENT. (SWE)	注意 この装置は目視 及び赤外線不可視 のクラス1M レーザー放射が 出ます。 光学器械で直接 見ないでください。 (JPN)	CAUTION VISIBLE AND/OR INVISIBLE CLASS 1 LASER RADIATION WHEN OPEN. DO NOT STARE INTO BEAM. FDA 21 CFR 101.10 LW4493-025A
--	---	---	--	---	---

CAUTION! — TH-D7 only

To avoid personal injury or accidentally dropping the unit, have two persons unpack, carry, and install the unit.



SP-THD7: 36 kg

Caution: Proper Ventilation

To avoid risk of electric shock and fire and to protect from damage, place the apparatus on a level surface. The minimal clearances are shown below:

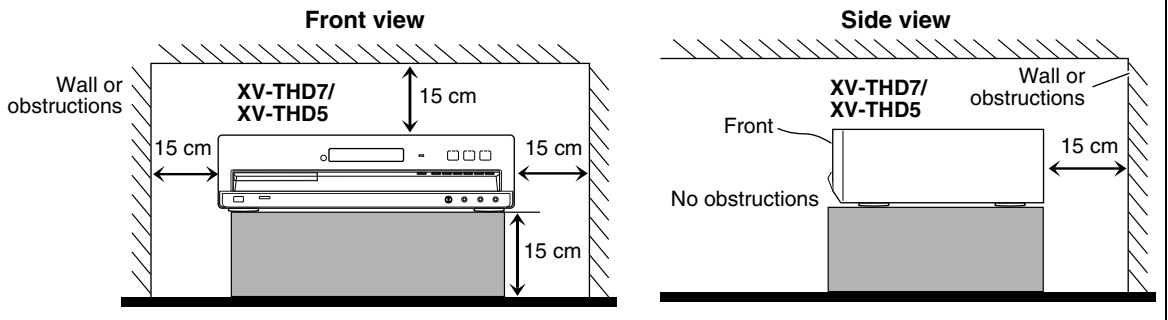

[European Union only]



How to read this manual

- Illustrations and button names of the TH-D7 are mainly used for explanation.
- The following icons and illustrations are used to make the explanations simple and easy-to-understand.

















Icons for System operations	
	Operations from the center unit
	Operations from the remote control
	The function can be operated from the on-screen bar ( 23).
Icons for the references and notes	
	Reference page for the function/operation
	Caution for the function/operation
	Note for the function/operation
	Tip for the function/operation
Icons for operating information	
	The function is available while playing.
	The function is available while paused.
	The function is available while stopped.
	There is a time limit on performing the target operation.
Illustrations for button operations	
	Press the button briefly.
	Press the button repeatedly.
	Press and hold the button.
	Press button (A), then press button (B).
	Press button (B) while holding button (A).

Table of contents

Before using this System	2
Playable discs/devices/files	3
Playable disc types	3
Playable digital devices	3
Playable file types	4
Getting started	5
Checking the supplied accessories	5
Putting batteries into the remote control	5
Setting the voltage selector	5
Connecting the speakers and subwoofer	5
Speaker layout	7
Connecting the AM and FM antennas	8
Connecting a TV	8
Connecting external components	9
Connecting the AC power cord	10
Basic and common operations	11
Sound and monitor settings	13
Sound settings and adjustments	13
Setting the audio input for external components	14
Selecting the color system and scanning mode	15
iPod playback	16
Disc/file playback	17
Basic playback	17
Using the disc menu	19
Locating a desired scene or song	19
Changing the playback mode	20
Advanced operations	21
Special playback for DVD Audio	22
Operation from the TV screen	23
Personal settings	25
Tuner operations	28
Setting the AM tuner interval spacing	28
Manual tuning	28
Preset tuning	28
Selecting the FM reception mode	28
Karaoke operations	29
Basic procedure for Karaoke	29
Selecting the audio channel	30
Sound adjustments for Karaoke	30
Reserving Karaoke songs	30
Operating external components	31
Setting the manufacturer's code	31
Operating external components	31
References	32
Manufacturer's code list	32
Language code list	32
Messages and icons shown on the TV	33
Troubleshooting	33
Specifications	35

Before using this System

Precautions

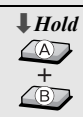
There are no user-serviceable parts inside. If anything goes wrong, unplug the power cord and consult your dealer.

Notes on installing the System

- Select a location which is level, dry and neither too hot nor too cold between 5°C and 35°C.
- Do not install the System in a location subject to vibrations.
- Do not put heavy objects on the System.

Avoid moisture, water, dust, and high temperatures

- Do not install the System in moist or dusty locations.
- If water gets inside the System, turn off the power and remove the plug from the wall outlet, then consult your dealer. Using the System in this state may cause a fire or electrical shock.
- Do not expose the System to direct sunlight or place it near a heating device.

To prevent malfunctions or damage to the System

- Do not insert any metallic objects, such as wires, hairpins, coins, etc. into the System.
- Do not block the vents.

Notes on the power cord

- When you are away on travel or otherwise for an extended period of time, remove the plug from the wall outlet. A small amount of power is always consumed while the power cord is connected to the wall outlet.
- When unplugging the System from the wall outlet, always pull the plug, not the power cord.
- Disconnect the power cord before cleaning or moving the System.
- Do not modify, twist or pull the power cord, or put anything heavy on it. Doing so may cause fire, electric shock, or other accidents.

About copyright laws

Observe the copyright laws in your country before recording from original sources. Recording of copyrighted material may infringe copyright laws.

About the copyguard system

The discs are protected by the copyguard system. When connecting the System to a TV via a VCR, or to a TV with a built-in VCR, the copyguard system activates and distortion of the picture may occur.

Notes on installing and using the speakers

- Place the speakers and subwoofer on a flat and level surface.
 - The speakers are magnetically shielded to avoid color distortions on TVs. If the color on a TV is distorted, perform the following procedure:
 - Turn off the TV's main power switch or unplug it before installing the speakers. Then wait at least 30 minutes before turning on the TV's main power switch again.
- Some TVs may still be affected even though you have followed the above procedure. If this happens, move the speakers away from the TV.
- The subwoofer is not magnetically shielded. To avoid color distortion, do not place it near the TV or monitor.
 - When moving the speakers and subwoofer, do not pull the speaker cords. Doing so may cause the speakers and/or subwoofer to fall over, causing damage or injury.
 - When installing the speakers on a wall, be sure to have them installed by qualified personnel. DO NOT install the speakers on a wall by yourself.
 - Do not lean against the speakers, as they could fall down or break, possibly causing an injury. Be especially careful that children do not lean against them.

About the adjustment of volume

Always set the volume to the minimum level before starting any source. If the volume is set at a high level, the sudden blast of sound could permanently damage your hearing and/or blow out the speakers.

To clean the System

- Use a soft cloth. Follow the relevant instructions on the use of chemically-coated cloths.
- If the System is heavily stained, apply a small amount of water or neutral detergent to the cloth and wipe clean, then wipe with a dry cloth.
- Do not use benzene, thinner or other organic solvents and disinfectants. These may cause deformation or discoloring.

Playable discs/devices/files

- ❗ Some discs/files may require operations that differ from those explained in this manual.
- ❗ Some discs/devices/files may not be recognized or played back correctly due to their characteristics.

Playable disc types

Type of disc	Types of media
DVD Video	<ul style="list-style-type: none"> • Discs on the market • DVD-R/-R DL/-RW • +R/+RW • DualDisc* (DVD side only)
DVD Audio	<ul style="list-style-type: none"> • Discs on the market • DVD-R/-R DL/-RW • +R/+RW
Super Video CD (SVCD)/Video CD (VCD)	<ul style="list-style-type: none"> • Discs on the market • CD-R/-RW
Audio CD	<ul style="list-style-type: none"> • Discs on the market • CD Text (Audio part only) • CD-R/-RW
A disc recorded in the DVD VR format	<ul style="list-style-type: none"> • DVD-R/-RW
Audio/video files on a disc (📀📺 4)	<ul style="list-style-type: none"> • DVD-R/-R DL/-RW in UDF Bridge format • CD-R/-RW in ISO 9660 format

- ❗ This System accommodates the PAL and NTSC system.
- ❗ It is possible to play back finalized +R/+RW (DVD Video format only) discs. "DVD" lights on the display when a +R/+RW disc is loaded.
- ❗ DVD-R/-RW: This System does not support "multi-border" discs.
- ❗ CD-R/-RW:
 - This System supports "multi-session" discs (up to 20 sessions).
 - This System cannot play "packet write" discs.

Unplayable discs—unwarranted

Playing back the following discs generates noise and damages the speakers.

- DVD-ROM, DVD-RAM, DualDisc* (non-DVD side)
- CD-ROM, CD-I (CD-I Ready), Photo CD, SACD
- Unfinalized discs (except DVD VR)
- Discs with an irregular shape or discs with tape, stickers or paste on either the label side or playback side
- Warped, dirty, or scratched discs

* *The Non-DVD side of a "DualDisc" does not comply with the "Compact Disc Digital Audio" standard. Therefore, the use of Non-DVD side of a DualDisc on this product may not be recommended.*

Region code of DVD Video

DVD Video players and DVD Video discs have their own Region Code numbers. This System can play back DVD Video discs whose Region Code numbers include the System's Region Code, which is indicated on the rear panel.

Ex.: For the countries of the Middle East



For the countries of Southeast Asia



For the countries of Central and South America



Playable digital devices

JVC bears no responsibility for any loss of data in an iPod and/or USB mass storage class device while using this System.

iPod

iPod model	AUDIO	VIDEO
iPod nano 1GB/2GB/4GB	√	
iPod nano (2nd Generation) 2GB/4GB/8GB	√	
iPod mini 4GB/6GB	√	
iPod (4th Generation) 20GB/40GB	√	
iPod photo (4th Generation) 20GB/30GB/40GB/60GB	√	√ *
iPod video (5th Generation) 30GB/60GB/80GB	√	√

* Only still pictures are available.

- ❗ If the iPod does not play correctly, update your iPod software to the latest version. For details about updating your iPod, check on the Apple web site <<http://www.apple.com>>.

- iPod is a trademark of Apple Inc., registered in the U.S. and other countries.

USB mass storage class device

A USB flash memory device, hard disk drive, multimedia card reader, digital camera, etc. can be used with this System through a USB connection.

- ✔ This System is compatible with USB 2.0 Full Speed.
- ✔ This System cannot recognize a USB mass storage class device whose rating exceeds 5 V/500 mA.

Playable file types

The following files in a disc or a USB mass storage class device can be played back.

Type of file	Playable files	Extensions
Audio	MP3	<.mp3>
	WMA	<.wma>
	WAV	<.wav>
Picture	JPEG	<.jpg>, <.jpeg>
Movie	ASF	<.asf>
	MPEG-1	<.mpg>, <.mpeg>
	MPEG-2	<.mpg>, <.mpeg>, <.mod>
	DivX (6.x, 5.x, 4.x and 3.11)	<.divx>, <.div>, <.avi>

- ✔ If a file on a USB mass storage class device exceeds the following conditions, it may not be played back correctly:
 - Maximum data transfer rate: 2 Mbps
 - Maximum frame rate: 30 fps for progressive
 - Maximum file size: 2 GB
- ✔ The System recognizes up to 150 tracks (files) per group, and 99 groups per disc/device. The total number of tracks (files) that the System can detect is 4000.

Information about the recording conditions for the files on a disc/device

MP3/WMA files

- The System supports MP3/WMA files recorded at a bit rate of 32 – 320 kbps and a sampling frequency of 16 kHz, 22.05 kHz, 24 kHz*, 32 kHz, 44.1 kHz or 48 kHz.
- It is recommended to record each file at a sample rate of 44.1 kHz and at a data transfer rate of 128 (96*) kbps.

* For WMA only

WAV files

- The System supports WAV files recorded at a quantization rate of 8 bit or 16 bit and a sampling frequency of 8 kHz, 11.025 kHz, 12 kHz, 16 kHz, 22.05 kHz, 24 kHz, 32 kHz, 44.1 kHz or 48 kHz.
- It is recommended to record each file at a sample rate of 44.1 kHz and at a quantization rate of 16 bit Linear PCM.

JPEG files

- It is recommended to record a file at 640 x 480 resolution. (If a file has been recorded at a resolution of more than 640 x 480, it will take a longer time to be displayed.)
- This System can only play baseline JPEG files.

ASF files

- The System supports MPEG-4 files with the following conditions:
File format: ASF
Visual profile: MPEG-4 SP (Simple Profile)
Audio CODEC: G.726
Max. picture size: 352 x 288 (CIF)
Max. bit rate: 384 kbps

MPEG1/MPEG2 files

- The stream format should conform to the MPEG system/program stream.
- 720 x 576 pixels (25 fps)/720 x 480 pixels (30 fps) is recommended for the highest resolution.
- This System also supports resolutions of 352 x 576/480 x 576/352 x 288 pixels (25 fps) and 352 x 480/480 x 480/352 x 240 pixels (30 fps).
- The file format should be MP@ML (Main Profile at Main Level)/SP@ML (Simple Profile at Main Level)/MP@LL (Main Profile at Low Level).
- Audio streams should conform to MPEG1 Audio Layer-2 or MPEG2 Audio Layer-2.

DivX files

- The System supports DivX files whose resolution is 720 x 480 pixels or less (30 fps), and 720 x 576 pixels or less (25 fps).
- Audio stream should conform to Dolby Digital (including multi-channel) or MPEG1 Audio Layer-3 (MP3).
- The System does not support GMC (Global Motion Compression).
- Files encoded in the interlaced scanning mode may not be played back correctly.

Getting started

Checking the supplied accessories

If anything is missing, contact your dealer immediately.

- Remote control (x 1)
- Batteries (x 2)
- FM antenna (x 1)
- AM loop antenna (x 1)
- Composite video cord (x 1)
- AC plug adapter (x 1) (not supplied for the countries of the Middle East and Thailand)
- Connection cable for iPod (x 1)
- Stand for iPod (x 1)
- Speaker cords
 - TH-D7: 4 m (x 4), 10 m (x 2)
 - TH-D5: 3 m (x 4), 8 m (x 2)
- Feet
 - TH-D7: For surround speakers (x 8)
 - TH-D5: For front and surround speakers (x 16)
- Screws (TH-D7 only): M5 x 115 mm (x 6), M4 x 25 mm (x 4)

Putting batteries into the remote control

R03 (UM-4)/AAA (24F) type dry-cell batteries (supplied)

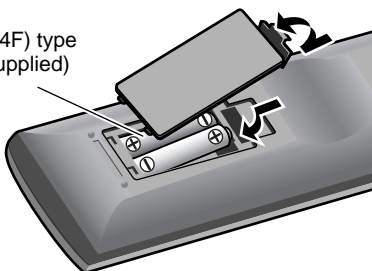

- ⚠ Do not expose batteries to heat or flame.
- ✔ If the range or effectiveness of the remote control decreases, replace both batteries.

Setting the voltage selector

Before plugging in, set the correct voltage for your area with the voltage selector switch on the rear of the center unit.

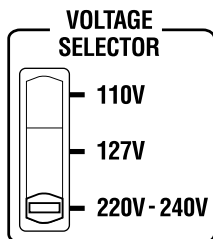

Ex.: When setting to “220V-240V”

Connecting the speakers and subwoofer

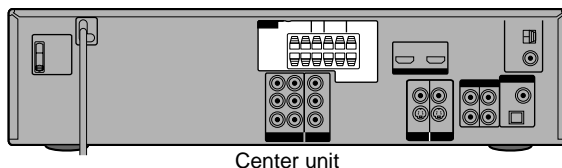

Center unit

Connecting the speakers and the subwoofer to the System

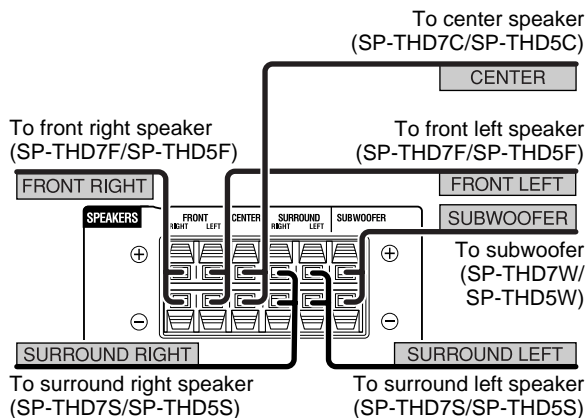

Connecting the speaker cords

Connect the speaker cords both to the center unit and to each speaker.

On the center unit:

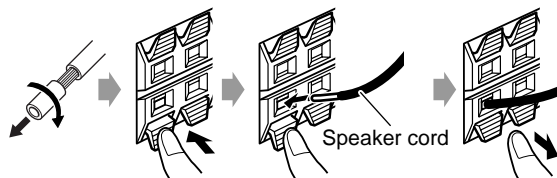

On the speaker:

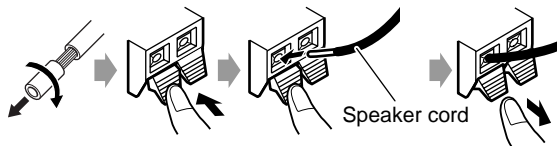

- Connect the black cords to the ⊖ terminals.
- Connect the white cords to the ⊕ terminals.

Do not connect the power cord until all other connections have been made.

- ❶ If you connect speakers other than those supplied for the System, use speakers of the same speaker impedance (SPEAKER IMPEDANCE) indicated on the rear of the center unit.
- ❷ DO NOT connect more than one speaker to one speaker terminal.
- ❸ TH-D7 only:
 - You can install the front speakers on the wall. When installing them on the wall, do not attach the stands and base plates.
 - When installing the front speakers on the floor, they are to be assembled before use (see below).

■ Assembling the front speakers —TH-D7 only

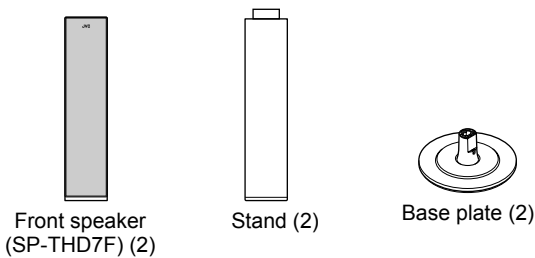

Assembled speakers:

You can assemble the front speakers either with or without stands.

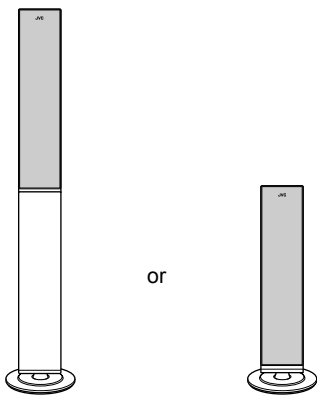

Before assembling:

- ❶ Take care not to drop any component part while assembling; otherwise, it may cause an injury or damage to the floor.
- ❷ Prepare a Phillips screwdriver (not supplied).

1 When assembling a speaker with stand:

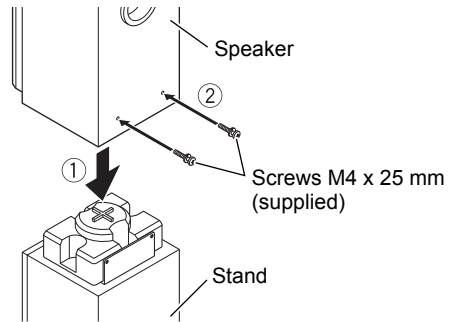

When assembling a speaker without stand:

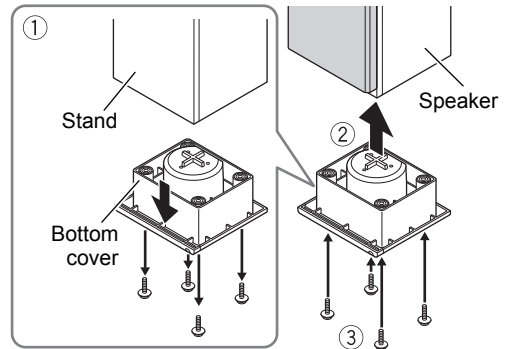

Detach the bottom cover and the screws (M4 x 30 mm) from the stand, then attach them to the bottom of the speaker.

2

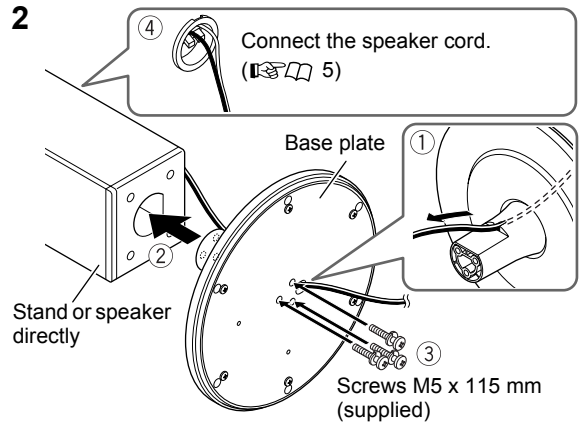

- ❶ When holding a speaker, always grasp the lower portion.

Getting started

Speaker layout

You can enjoy surround sound by placing the speakers as illustrated (Speaker layout A or B).

Speaker layout A

✔ Select "S.SP K R" as the speaker position mode for this layout. (📖 13)

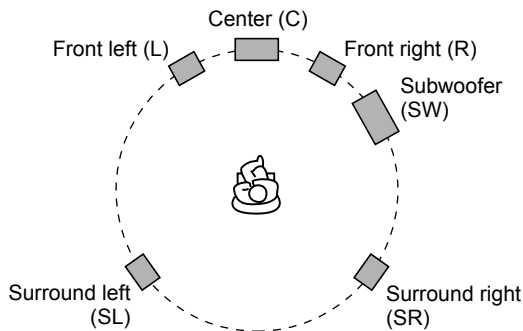

✔ To obtain the best possible surround sound from this System, place all the speakers except the subwoofer at the same distance from the listening position. If it is impossible, adjust the delay time from DELAY menu. (📖 27)

Speaker layout B

✔ Select "S.SP K F" as the speaker position mode for this layout. (📖 13)

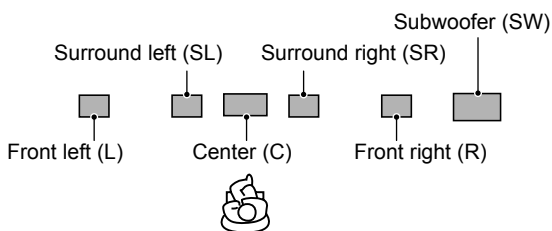

- ✔ Place the surround speakers close to the center speaker.
- ✔ It is recommended to place the surround speakers horizontally (see the right column).

When placing the speakers horizontally

Lay the speakers horizontally so that the JVC logos are positioned as illustrated below.

Ex.:

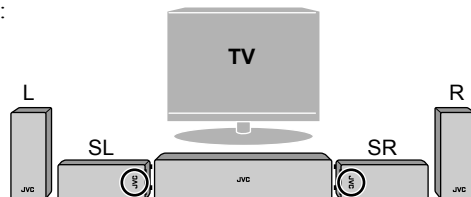

TH-D5 only: you can also lay the front speakers as illustrated below.

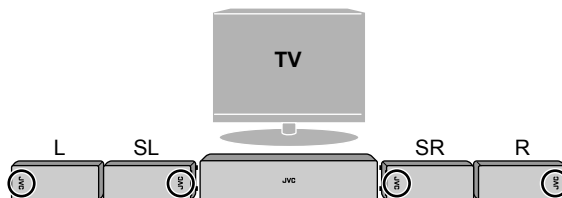

✔ TH-D7: Do not lay down the front speakers horizontally.

✔ You can turn the JVC logos to make them legible.



Attaching the feet

When placing the speakers horizontally, attach the feet to the bottom of the speakers as illustrated.

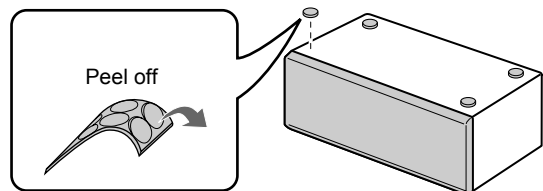

Do not connect the power cord until all other connections have been made.

Connecting the AM and FM antennas

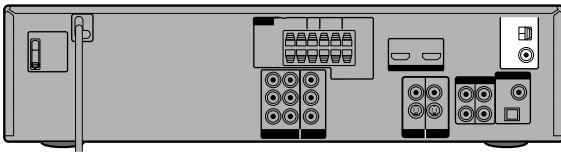

- ✔ Make sure the antenna conductors do not touch any other terminals, connecting cords or power cords.

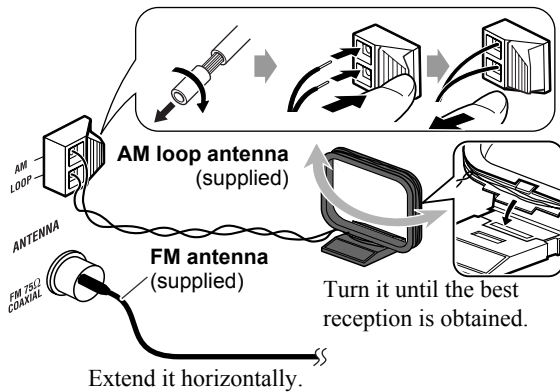

For better FM reception

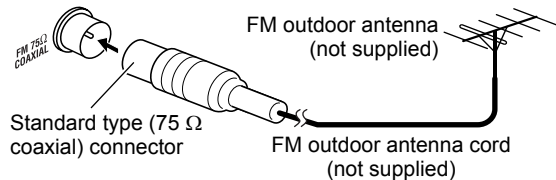

Connecting a TV

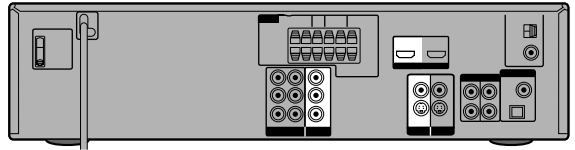

Connect the TV to the appropriate video out jacks to view the playback picture.

- ✔ The picture quality order is as follows:
HDMI > Component video > S-video > Composite video
- ✔ Make the following settings after connecting the TV:
 - Color system and scanning mode (📖 15)
 - MONITOR TYPE (📖 26)

Connection using the HDMI terminal

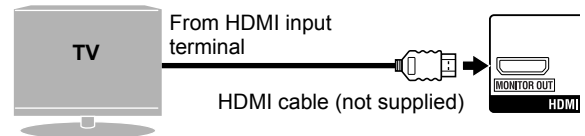

- ✔ You can make the following settings for the TV when the HDMI connection is used:
 - HDMI DVI COLOR (📖 26)
 - HDMI OUT (📖 26)
 - HDMI AUDIO OUT (📖 26)
 - DOWN MIX (📖 26)*
- ✔ Use a certified HDMI cable, which has the HDMI logo.
- ✔ You can use a monitor with a DVI terminal by connecting with a DVI-HDMI conversion cable.
- ✔ When you play HDCP (High-Bandwidth Digital Content Protection) source, it takes a few seconds for the sound and picture to be transmitted to the speakers and TV while the confirmation process is completed.
- ✔ On some TVs, no sound may come out during playback of sources such as DVD Audio even when the HDMI AUDIO OUT setting is "ON" (📖 26).

* This setting is available only when the speaker position mode is set to "S.SPK F" (📖 13).

Continued on the next page

Getting started

Connection using the component video jacks

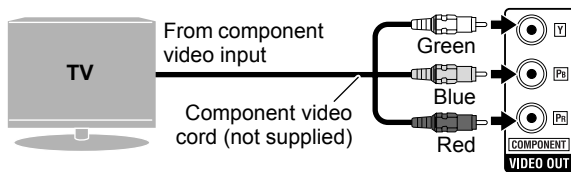

- Do not connect the TVs via both the COMPONENT jacks and HDMI MONITOR OUT terminal at the same time.
- For the BNC connection, use a plug adapter (not supplied).

Connection using the S-video or composite video jack

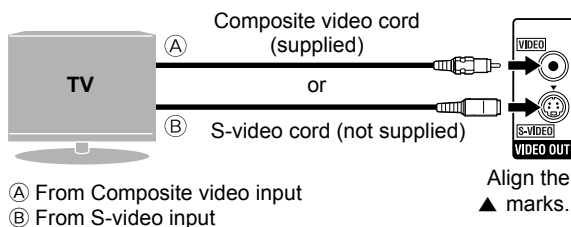

- A From Composite video input
- B From S-video input

Connecting external components

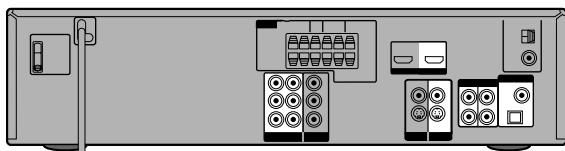

Connection for "VIDEO1"—TH-D7

- Select "VIDEO1" as the source (see page 12) for playing a component connected as follows.

Video connection

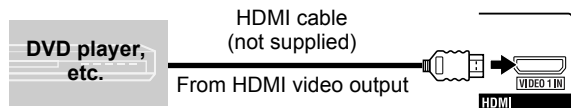

- To view a video from the external component connected as above, connect a TV via the HDMI MONITOR OUT terminal. (see page 8)
- No sound signal comes into HDMI VIDEO 1 IN terminal. Make audio connection to listen to the sound (see the right column).

Audio connection

Connecting a digital component

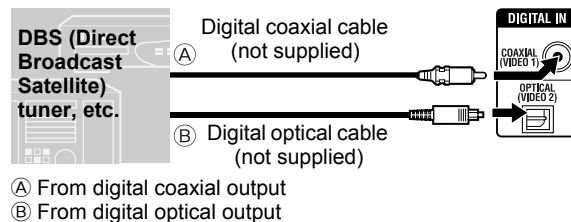

- A From digital coaxial output
- B From digital optical output

- The initial setting for the audio input setting is "COAX." When using OPTICAL terminal, change the setting to "OPT" before playing back. (see page 14)

Connecting an analog component

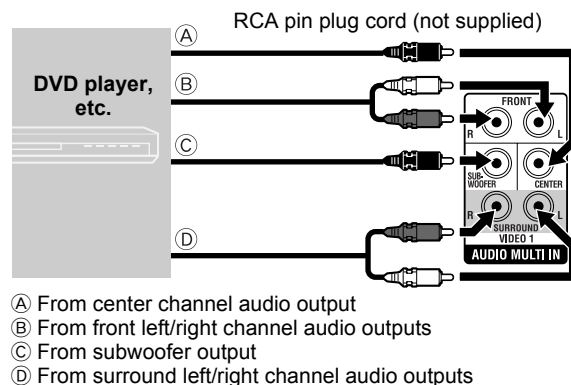

- A From center channel audio output
- B From front left/right channel audio outputs
- C From subwoofer output
- D From surround left/right channel audio outputs

- To listen to the sound from AUDIO MULTI IN jacks, perform the following procedure:
 - Place the speakers by following "Speaker layout A" (see page 7).
 - Select "S.SPK R" as the speaker position mode. (see page 13)
- Select "5.1CH" as the audio input setting before playing back. (see page 14)

Connection for "VIDEO2"—TH-D7

- Select "VIDEO2" as the source (see page 12) for playing a component connected as follows.

Video connection

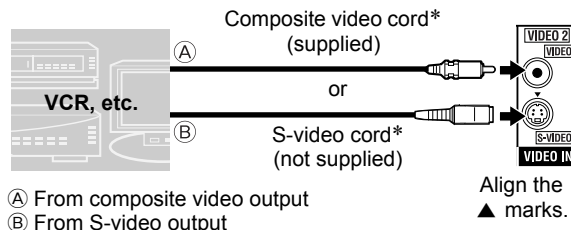

- A From composite video output
- B From S-video output

* Connect an external component with the same kind of cable as the one used to connect the TV. (see the left column)

Do not connect the power cord until all other connections have been made.

Audio connection

Connecting a digital component

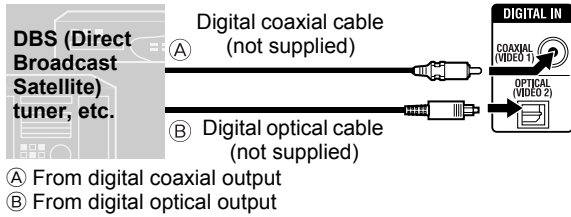

- ⓐ From digital coaxial output
 - ⓑ From digital optical output
- ✔ The initial setting for the audio input setting is “OPT.” When using COAXIAL jack, change the setting to “COAX” before playing back. (📖 14)

Connecting an analog component

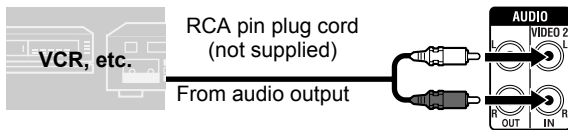

- ✔ Select “2CH” as the audio input setting before playing back. (📖 14)

Connecting a cassette recorder

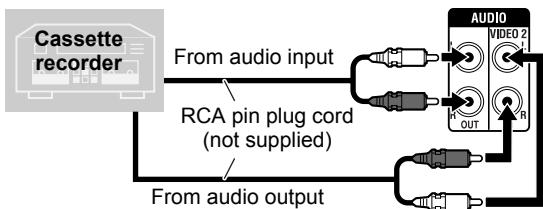

- ✔ The surround mode affects the signals emitted from the AUDIO OUT jacks. When recording on to a tape, set the surround mode to “OFF.” (📖 14)
- ✔ When “5.1CH” is selected as the audio input setting for “VIDEO1,” only the left and right audio signals are emitted.

Connection for “VIDEO”—TH-D5

- ✔ Select “VIDEO” as the source (📖 12) for playing a component connected as follows.

Video connection

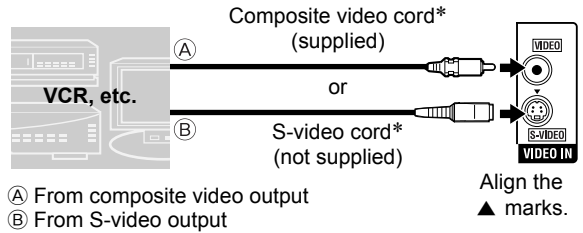

- ⓐ From composite video output
- ⓑ From S-video output

* Connect an external component with the same kind of cable as the one used to connect the TV. (📖 9)

Audio connection

Connecting a digital component

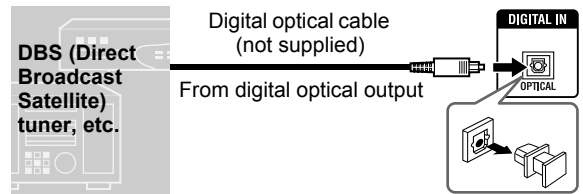

- ✔ Select “OPT” as the audio input setting before playing back. (📖 14)

Connecting an analog component

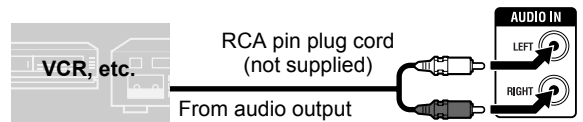

- ✔ Select “2CH” as the audio input setting before playing back. (📖 14)

Connecting the AC power cord

Plug in the System only after all the connections have been completed.

- ✔ If the AC outlets do not match the AC plugs, use the supplied AC plug adapter (not supplied for the countries of the Middle East).

Available video output terminals for each source

Terminal \ Source	DVD USB	iPod	VIDEO2 (TH-D7) VIDEO (TH-D5)	VIDEO1 (TH-D7 only)
HDMI	√			√
COMPONENT	√			
S-VIDEO	√	√	√	
VIDEO (Composite video)	√	√	√	

Basic and common operations

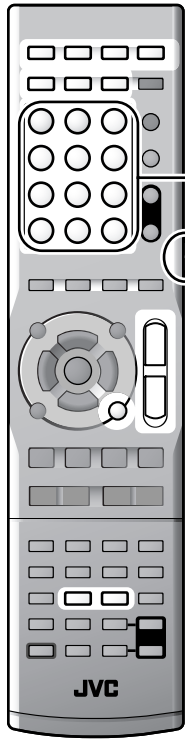

How to use the number buttons

To select 3: Press 3.
 To select 10: Press 10.
 To select 14: Press ≥ 10 , 1, then 4.
 To select 24: Press ≥ 10 , 2, then 4.
 To select 40: Press ≥ 10 , 4, then 0.
 To select 114: Press ≥ 10 , ≥ 10 , 1, then 4.

Set the remote control mode before operation.



Point at the remote sensor directly.

Listening with headphones

When the headphones are connected, the System automatically deactivates the speakers and cancels the surround mode (14) temporarily.

- “H.PHONE” appears on the display.

Be sure to turn down the volume before connecting or putting on the headphones.



STANDBY lamp:

- Goes off when the System is turned on.
- Lights when the System is turned off.

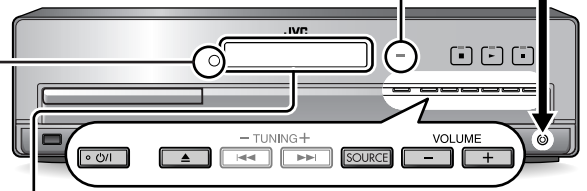

Display

To change the display brightness

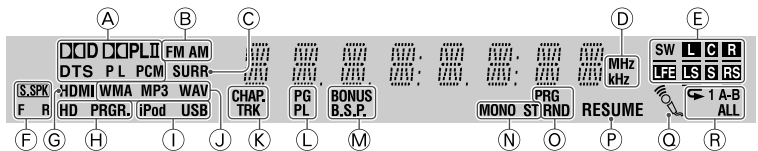

- (A) Digital audio signal format indicators
- (B) Tuner band indicators (28)
- (C) Lights when one of the surround modes is activated. (14)
- (D) Frequency unit indicators for FM/AM
- (E) Source signal and speaker signal indicators
 - L** (front left), **C** (center), **R** (front right), **LFE** (low frequency effect), **LS** (surround left), **RS** (surround right), **S** (monaural surround): Light when the signal comes in for the digital input or when the System is ready to receive the signal for the analog input.
 - SW** (subwoofer): Always lights.
 - _**: Lights while reproducing the channel's sound through the corresponding speaker.
- (F) Speaker position mode indicators (13)
- (G) Lights when both the System and the TV (with HDMI connection) are ready to communicate each other.
- (H) Scanning mode indicators (15)
 - HD**: Lights when the System is emitting high-definition video signals (720p or 1080i).
 - PRGR.**: Lights when the progressive scanning mode is activated.
- (I) Digital device indicators
- (J) File type indicators
- (K) Lights when the chapter (**CHAP.**) or track (**TRK**) number is displayed.
- (L) Lights when selecting a program number (**PG**) or playlist number (**PL**) of a DVD VR disc by using TITLE/GROUP. (19)
- (M) Special playback indicators for DVD Audio (22)
 - BONUS**: Lights when a bonus group is detected.
 - B.S.P.**: Lights when browsable still pictures are detected.
- (N) FM reception mode indicators (28)
 - MONO**: Lights when receiving an FM stereo station in monaural.
 - ST**: Lights when receiving an FM stereo station with sufficient signal strength is tuned in.
- (O) Lights during program play (**PRG**) or random play (**RND**). (20)
- (P) Lights when the System memorizes the position where the playback is interrupted. (18)
- (Q) Lights when the Karaoke function is activated. (29, 30)
- (R) Repeat mode indicators (20, 23)

■ Turning the power on or off

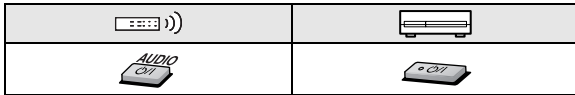

To turn off the System by using the sleep timer

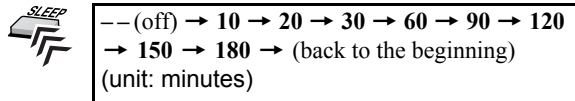

To check the remaining time, press the button once.

■ Selecting the source

To do		Indication	
Play back a disc		DVD	17
Play back a file on a USB mass storage class device		USB	17
Play back an iPod		iPod	16
Listen to an FM or AM station		FM or AM	28
Play back an external component • TH-D7: VIDEO1/ VIDEO2 • TH-D5: VIDEO		VIDEO1*	31
		VIDEO2*	31
		VIDEO*	31

To select the source from the center unit



* Make sure that the appropriate audio input setting have been made for the source (VIDEO1/VIDEO2 or VIDEO).
(14).

■ Adjusting the volume

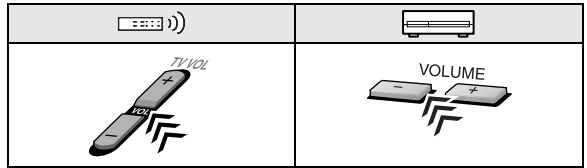

To turn off the volume instantly

"MUTING" appears on the display.

To restore the volume, press the button again, or adjust the volume level.

■ Prohibiting disc ejection

- 1 Turn off the System.
- 2 Lock the disc tray.

+ "LOCKED" appears on the display.
(On the center unit)

To unlock the disc tray, perform the above procedure again. "UNLOCKED" appears on the display.

Sound and monitor settings



Set the remote control mode before operation.

AUDIO \rightarrow TV \rightarrow VCR/DBS \rightarrow



- As the speaker position mode is changed, the following settings are also changed automatically:
 - The output level settings of the speakers and of subwoofer (see below) are initialized.
 - The surround mode (📖 14) is set to "AUTO SUR."

Adjusting the output level of the speakers and subwoofer

1 The items you can adjust differ depending on the selected speaker position mode (see the left column).



- When the speaker position mode is "S.SP K R":

FRNT L \rightarrow FRNT R \rightarrow CENTER \rightarrow SURR L \rightarrow SURR R \rightarrow SUBWFR \rightarrow (back to the beginning)

- When the speaker position mode is "S.SP K F":

CENTER \rightarrow SURR \rightarrow SUBWFR \rightarrow (back to the beginning)

Sound settings and adjustments

Selecting the speaker position mode

Select the speaker position mode according to your speaker layout (📖 7).

1 Turn off the System. (📖 12)

2 \downarrow Hold



S . S P K R

3 Select the appropriate speaker position mode according to your speaker layout (📖 7).



<p>S.SP K R (Surround speaker: Rear)</p>	<p>For speaker layout A</p> <ul style="list-style-type: none"> The S.SP K R indicator lights on the display.
<p>S.SP K F (Surround speaker: Front)</p>	<p>For speaker layout B</p> <ul style="list-style-type: none"> The S.SP K F indicator lights on the display.

2 Adjust the output level.



- Different output level settings can be stored for the following two groups of sources:

- TH-D7: DVD, USB, IPod, VIDEO1*¹ and VIDEO2
- TH-D5: DVD, USB, IPod and VIDEO
- TH-D7: FM, AM and VIDEO1*²
- TH-D5: FM and AM

You can also make adjustments from the LEVEL menu (📖 27) when the speaker position mode is "S.SP K R."

*¹With "COAX" or "OPT" selected as the audio input setting (📖 14)

*²With "5.1CH" selected as the audio input setting (📖 14)

Adjusting the bass and treble sounds

1	TRE	Adjusts the treble sound
	BASS	Adjusts the bass sound

2 Adjust the level.



Using the surround mode



Select one of the available surround modes.



The surround modes you can select depend on the playback source and the selected speaker position mode (13). For details on each surround mode, see “Available surround modes” on the right column.

- During 2-channel playback with “S.SPK R” speaker position mode:

AUTO SUR → MOVIE → MUSIC → STADIUM → ALL ST → OFF → (back to the beginning)

When the source is “FM” or “AM,” you can only select “ALL ST.”

- During multi-channel playback with “S.SPK R” speaker position mode:

AUTO SUR → currently selected mode* **→ OFF →** (back to the beginning)

* When “AUTO SUR” is selected, the System automatically selects a proper multi-channel surround mode, such as “DOLBY D (Dolby Digital)” or “DTS (DTS Digital Surround).”

- During playback with “S.SPK F” speaker position mode:

AUTO SUR → MOVIE → WIDE/2CH → SUPER W → OFF → (back to the beginning)

When the source is “FM” or “AM,” the surround mode cannot be activated.

To check the surround mode currently selected, press SURROUND once.

- TH-D7 only: When the source is “VIDEO1” with “5.1CH” selected as the audio input setting (see the right column), the surround mode setting is ineffective. All incoming signals are emitted through the corresponding speakers. “MULTI CH” appears on the display.
- During playback of ASF, MPEG-2 or MPEG-1 files, the surround mode setting is ineffective.
- During playback of DivX, the surround mode setting is effective only for multi-channel files with “S.SPK R” selected as the speaker position mode.
- For DVD Audio, when “LR ONLY” appears on the display, activate the surround mode for the multi-channel reproduction.
- While the Karaoke function (29) is in use, the surround mode is canceled.

Available surround modes

Surround mode for “S.SPK R”	
AUTO SUR (Auto Surround)	Selects an appropriate surround mode according to the incoming signals
MOVIE (Dolby Pro Logic II Movie)	For movie sources
MUSIC (Dolby Pro Logic II Music)	For music sources
STADIUM	Adds clarity and spreads the sound, as if in an outdoor stadium
ALL ST (All Channel Stereo)	Reproduces a larger stereo sound field using all the activated speakers
OFF (Off)	Deactivates surround mode
Surround mode for “S.SPK F”	
AUTO SUR (Auto Surround)	Selects an appropriate surround mode according to the incoming signals
MOVIE	For movie or multi-channel music sources
WIDE/2CH	For 2-channel music sources
SUPER W (Super Wide)	Reproduces broader sound field
OFF (Off)	Deactivates surround mode

Setting the audio input for external components

Set the audio input of the external component for “VIDEO1/VIDEO2” (TH-D7) or “VIDEO” (TH-D5).



1

2 Select “AIN. (audio input).”



AIN. 2 : 2 CH
Item*¹ Current setting



3 TH-D7 only: Select a source you want to set the audio input for.



AIN.1:	For “VIDEO1”
AIN.2:	For “VIDEO2”

Continued on the next page

4 Select an appropriate audio input according to the audio connection. (📖 9)

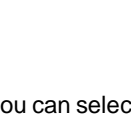
	2CH	For connection via the AUDIO IN jacks
	5.1CH	For connection via the AUDIO MULTI IN jacks
	COAX	For connection via the COAXIAL jack
	OPT	For connection via the OPTICAL terminal

✔ You can select the following settings for each source (underlined items are the initial settings for each source):

- “VIDEO1”: 5.1CH*², COAX*³ and OPT*³
- “VIDEO2”: 2CH, COAX*³ and OPT*³
- “VIDEO”: 2CH and OPT

✔ If your System is the TH-D7, make the audio input setting for both “VIDEO1” and “VIDEO2.”

*¹ “AIN.1.” or “AIN.2.” appears for TH-D7, and “AIN.” for TH-D5.

*² TH-D7 only: When the speaker position mode is set to “S.SP K F,” “5.1CH” cannot be selected.

*³ TH-D7 only: It is not possible to select the same audio input setting for “VIDEO1” and “VIDEO2.” For example, when “COAX” is assigned to “VIDEO1,” it cannot be selected for “VIDEO2.” When the item you want cannot be selected, see “Troubleshooting” for details. (📖 34)

Selecting the color system and scanning mode

Select the color system and scanning mode for the sources “DVD” and “USB” according to the type of TV and to connection method.



✔ To use the progressive scanning mode, connect a TV supporting progressive video signals to the HDMI MONITOR OUT terminal or COMPONENT jacks.

(📖 8)

1 Select “DVD” or “USB” as the source.

(📖 12)

2 Hold SCAN MODE

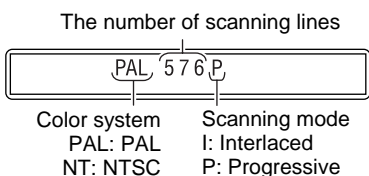

3 Select an appropriate color system and scanning mode, then confirm the selection.



- When connecting the TV via the HDMI MONITOR OUT terminal, the following items are selectable: **AUTO, PAL 576P, PAL 720P, PAL 1080I, NT 480P, NT 720P and NT 1080I**
– Normally select “AUTO.”

✔ When “AUTO” is selected, the System automatically emits the video signal to get the best picture quality on your TV.

✔ The HD indicator lights when the System is emitting “720P” (PAL/NT) or “1080I” (PAL/NT) video signals.

- When connecting the TV via COMPONENT jacks, S-VIDEO or VIDEO jack, the following items are selectable:

PAL 576I, PAL 576P, NT 480I and NT 480P

– When connecting the TV via the S-VIDEO or VIDEO jack, selecting a progressive scanning mode does not affect the picture.

✔ If another TV is connected through the HDMI MONITOR OUT terminal, you cannot change the color system and scanning mode for the TV connected through the COMPONENT jacks, S-VIDEO or VIDEO jack.

✔ You can get better picture quality in the progressive scanning than in the interlaced scanning.

✔ When the color system and/or scanning mode does not correspond to that of the TV, the picture is not displayed normally.

iPod playback

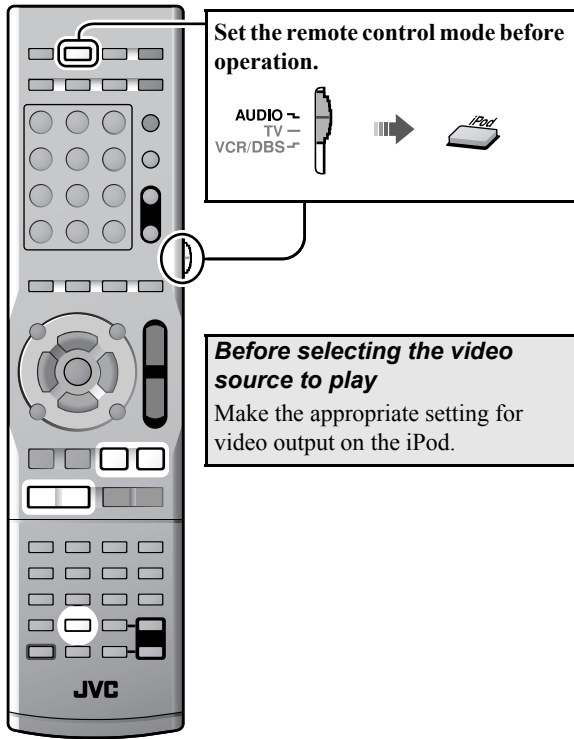

Play/pause/search/skip

To do		
Start playback		
Pause		
Fast-forward/fast-reverse search within the current track		
Skip to the next/previous item*		

* Operate on your iPod to skip to the next/previous item while playing back a video.

- The iPod enters sleep mode when you turn off the System or select another source.
- To show still pictures in the iPod, play them back in slide-show mode on the iPod.

- ❗ DO NOT connect or disconnect the iPod when the System is turned on.
- ❗ DO NOT touch the iPod terminal pins or the connector pins.
- ❗ When the iPod is not charged through the System, the iPod may not be turned on from the System.
- ❗ If the sound is distorted when audio sources with high recording levels are played, you are recommended to deactivate the equalizer on your iPod.
- ❗ To view a video/picture from the iPod on the TV, connect the System to the TV via the composite or S-video jacks. (📖 9)
- ❗ You cannot send any data to your iPod from the System.
- ❗ To disconnect the iPod cable from the iPod, press the buttons on the sides, then pull it out.
- 💡 The iPod battery is charged only when "iPod" is selected as the source.

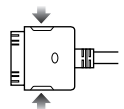

Starting playback

- ❗ Be sure to reduce the volume on the System to the minimum level before connecting an iPod. Adjust the volume after playback has started.

1 Connect an iPod while the System is turned off.

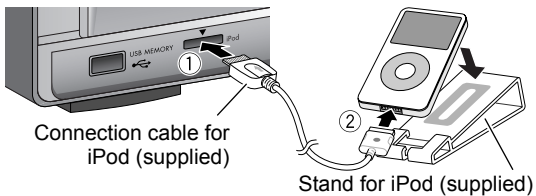

- Connect the plug with the arrow-mark side facing up.

2 Turn on the System, then select "iPod" as the source. (📖 12)

"CONNECT" appears on the display. If an iPod is not connected firmly, "NO CONNE" appears.

3 Start playing the iPod.



- Press ► (play button) again if the iPod does not start playback.

If the iPod which is not listed in "Playable digital devices" (📖 3) is connected, the iPod may not be operated from the System. In this case, deactivate the iPod battery charge function so that the iPod may be operated, but the iPod cannot be charged through the System.

To deactivate the battery charge function

↓ Hold "P.OFF" appears on the display.

To use the battery charge function, perform the above procedure again. "P.ON" appears on the display.

Disc/file playback

The following icons show the available disc/file types for the target function:



Initial settings

Make the following settings before playing back discs/files.

- Color system and scanning mode (15)
- MONITOR TYPE (26)
- ON SCREEN LANGUAGE (25)

Set the remote control mode before operation.

For disc playback

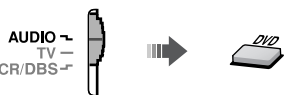

For playback of a file on a USB mass storage class device



Operating the touch sensor panel

You can operate the playback control buttons on the center unit simply by touching them. When you touch any one of these buttons, it lights briefly in blue.

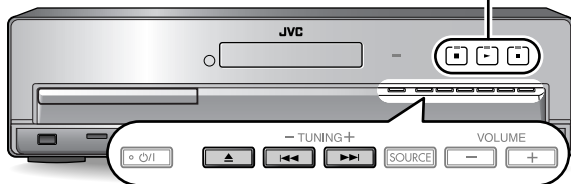

⚠ If a still picture is displayed for about 5 minutes, the System automatically dims the screen (screen saver function). You can deactivate the screen saver function. (26)

⚠ When several types of files (music, picture or movie) are recorded on a disc or device, select the file type you want to play. (26)

⚠ For messages and icons shown on the display, see "Messages and icons shown on the TV" (33).

Basic playback

Playing back a disc

1 Select "DVD" as the source. (12)

2 (On the center unit)

3 Place a disc on the tray.

Label side up

When placing an 8 cm disc

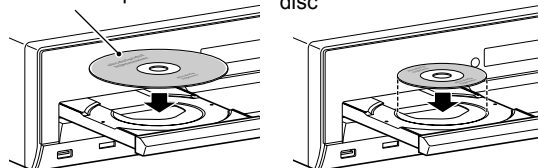

4 Start playback.

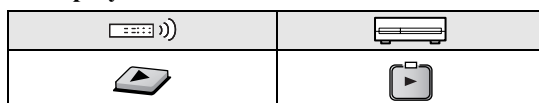

- JPEG: Slide-show starts.
- MP3/WMA/WAV: The file control display appears on the TV. (24)

Playing back a file on a USB mass storage class device

1 Connect a USB mass storage class device while the System is turned off.

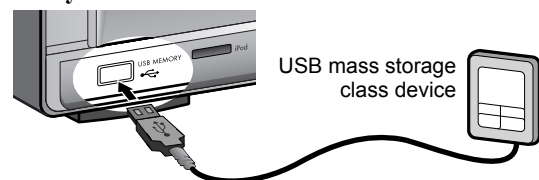

2 Turn on the System, then select "USB" as the source. (12)

Playback starts automatically.

Press (play button) to start playback if the file is not played back automatically.

- JPEG: Slide-show starts.
- MP3/WMA/WAV: The file control display appears on the TV. (24)

- ❗ DO NOT connect or disconnect the device when the System is turned on.
- ❗ You cannot connect a computer to the USB MEMORY terminal of the System.
- ❗ DO NOT connect the device through a USB hub.
- ❗ iPod does not play through the USB MEMORY terminal. When iPod is connected to the USB MEMORY terminal, "RESTRICT" appears on the display.
- ❗ This System may not play back some USB mass storage class devices and does not support DRM (Digital Rights Management).
- ❗ When connecting with a USB cable, use the shielded cable whose length is less than 1 m.

Play/stop/pause/search

To do		
Start playback		
Stop playback		
Pause		
Fast-forward/fast-reverse search*1		

*1 To return to normal playback, press (play button).

*2 Pressing and holding also fast-forwards/fast-reverses tracks or files.

Resume function

The System memorizes the position where the playback has been interrupted by one of the following operations:

- Pressing once
- Turning off the power (12)
- Changing the source (12)

DVD VIDEO	DVD AUDIO	DVD VR
VCD	SVCD	CD
MP3 WMA WAV	JPEG	ASF
MPEG 1	MPEG 2	DivX

To resume playback, press (play button) or the corresponding source button.

To clear the memorized position, press twice.

- Opening the disc tray or disconnecting the USB mass storage class device also clears the memorized position.

❗ This function does not work in program play and random play. (20)

💡 You can deactivate the resume function. (27)

Changing the playback information



Each time you press the button, the playback information alternates between "type A" and "type B" on the display as follows:

Ex.: When a DVD Video disc is played back

Information type A

DCID	SURR	2 4	1: 2 3: 3 1	SV	MP3	WMA	ASF	DivX
		CHAP						
		Chapter number	Time information*1					

Information type B

DCID	SURR	T 1 5	C 2 4	SV	MP3	WMA	ASF	DivX
		Title number	Chapter number					

Disc/file type	Information type A	Information type B
DVD VIDEO	Chapter number with time information*1	Title (T) number and chapter (C) number
DVD VR		Program (PG) number/Playlist (PL) number and chapter (C) number
VCD SVCD CD	Track number with time information*1 *2	_____
DVD AUDIO ASF MPEG 2		MP3 WMA WAV MPEG 1 DivX
JPEG	File number	Group (G) number and file (F) number

*1 For DVD Video, DVD Audio, DVD VR, VCD, SVCD or CD, you can change the time information mode (23). For MP3, WMA, WAV, ASF, MPEG1, MPEG2 or DivX, elapsed playing time is shown.

*2 While playing a VCD or SVCD with PBC (19), only track number is displayed.

Disc/file playback

Using the disc menu

For DVD Video/DVD Audio



- For a DVD Video disc For a DVD Audio disc

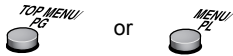

- Select the desired item, then confirm the selection.



For some discs, you can also select items by using the number buttons.

For VCD/SVCD with PBC



The Play Back Control function (PBC) allows you to operate the VCD/SVCD using menus.

Select the number of the desired item while the menu is displayed on the TV.*



- To move to the next or previous page of the current menu



- To return to the previous menu



To perform playback without PBC

- While playback is stopped, select the desired track by using the number buttons.*
- While playback is stopped, select the desired track by pressing ►► repeatedly, then press ► (play button).

To activate the PBC function, press TOP MENU(/PG) or MENU(/PL).

While playing back a VCD or SVCD with PBC (“PBC” appears on the display), some functions such as time search, do not work.

* For details on using the number buttons, see “How to use the number buttons” (11).

Locating a desired scene or song

- Selecting the beginning of a desired scene or song

To do		Disc/file												
Skip chapter/track/file		<table border="1"> <tr><td>DVD VIDEO</td><td>DVD AUDIO</td><td>DVD VR</td></tr> <tr><td>VCD</td><td>SVCD</td><td>CD</td></tr> <tr><td>MP3 WMA WAV</td><td>JPEG</td><td>ASF</td></tr> <tr><td>MPEG 1</td><td>MPEG 2</td><td>DivX</td></tr> </table>	DVD VIDEO	DVD AUDIO	DVD VR	VCD	SVCD	CD	MP3 WMA WAV	JPEG	ASF	MPEG 1	MPEG 2	DivX
DVD VIDEO	DVD AUDIO	DVD VR												
VCD	SVCD	CD												
MP3 WMA WAV	JPEG	ASF												
MPEG 1	MPEG 2	DivX												
Select the chapter/track/file number*3 *4		<table border="1"> <tr><td>DVD VIDEO</td><td>DVD AUDIO</td><td>DVD VR</td></tr> <tr><td>VCD</td><td>SVCD</td><td>CD</td></tr> <tr><td>MP3 WMA WAV</td><td>JPEG</td><td>ASF</td></tr> <tr><td>MPEG 1</td><td>MPEG 2</td><td>DivX</td></tr> </table>	DVD VIDEO	DVD AUDIO	DVD VR	VCD	SVCD	CD	MP3 WMA WAV	JPEG	ASF	MPEG 1	MPEG 2	DivX
DVD VIDEO	DVD AUDIO	DVD VR												
VCD	SVCD	CD												
MP3 WMA WAV	JPEG	ASF												
MPEG 1	MPEG 2	DivX												
Select the title/program or playlist/group number*3 • Enter the number while “--” is flashing on the display		<table border="1"> <tr><td>DVD VIDEO</td><td>DVD AUDIO</td><td>DVD VR</td></tr> <tr><td>VCD</td><td>SVCD</td><td>CD</td></tr> <tr><td>MP3 WMA WAV</td><td>JPEG</td><td>ASF</td></tr> <tr><td>MPEG 1</td><td>MPEG 2</td><td>DivX</td></tr> </table>	DVD VIDEO	DVD AUDIO	DVD VR	VCD	SVCD	CD	MP3 WMA WAV	JPEG	ASF	MPEG 1	MPEG 2	DivX
DVD VIDEO	DVD AUDIO	DVD VR												
VCD	SVCD	CD												
MP3 WMA WAV	JPEG	ASF												
MPEG 1	MPEG 2	DivX												

The features above may not work for some discs/files.

*1 For DVD Video, DVD VR, VCD, and SVCD discs, this function is not available while playback is stopped.

*2 For DVD Video and DVD VR discs, you can select a title/program while playback is stopped.

*3 For details on using the number buttons, see “How to use the number buttons” (11).

*4 When selecting the chapter/track/file number from the on-screen bar, see “Using the on-screen bar” (23).

- Selecting the desired position of a scene or song

To do		Disc/file												
Move the playback position back by 10 seconds (one-touch replay)*1 *2		<table border="1"> <tr><td>DVD VIDEO</td><td>DVD AUDIO</td><td>DVD VR</td></tr> <tr><td>VCD</td><td>SVCD</td><td>CD</td></tr> <tr><td>MP3 WMA WAV</td><td>JPEG</td><td>ASF</td></tr> <tr><td>MPEG 1</td><td>MPEG 2</td><td>DivX</td></tr> </table>	DVD VIDEO	DVD AUDIO	DVD VR	VCD	SVCD	CD	MP3 WMA WAV	JPEG	ASF	MPEG 1	MPEG 2	DivX
DVD VIDEO	DVD AUDIO	DVD VR												
VCD	SVCD	CD												
MP3 WMA WAV	JPEG	ASF												
MPEG 1	MPEG 2	DivX												
Skip in approximately 5-minute intervals*1		<table border="1"> <tr><td>DVD VIDEO</td><td>DVD AUDIO</td><td>DVD VR</td></tr> <tr><td>VCD</td><td>SVCD</td><td>CD</td></tr> <tr><td>MP3 WMA WAV</td><td>JPEG</td><td>ASF</td></tr> <tr><td>MPEG 1</td><td>MPEG 2</td><td>DivX</td></tr> </table>	DVD VIDEO	DVD AUDIO	DVD VR	VCD	SVCD	CD	MP3 WMA WAV	JPEG	ASF	MPEG 1	MPEG 2	DivX
DVD VIDEO	DVD AUDIO	DVD VR												
VCD	SVCD	CD												
MP3 WMA WAV	JPEG	ASF												
MPEG 1	MPEG 2	DivX												

*1 This function works only within the same title/program/file.

*2 This function is not available during repeat play.

Changing the playback mode

Program play and random play cannot be used for a USB mass storage class device.

Programming the playing order—program play

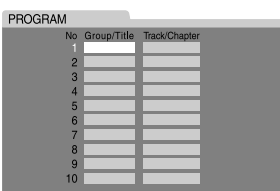
1  

PROGRAM

No	Group/Title	Track/Chapter
1		
2		
3		
4		
5		
6		
7		
8		
9		
10		

Program window

DVD VIDEO	DVD AUDIO	DVD VR
VCD	SVCD	CD
MP3 WMA WAV	JPEG	ASF
MPEG 1	MPEG 2	DivX

2 Select the desired chapters/ tracks.

- For DVD Video, DVD Audio, MP3 and WMA: Enter a title/group number, then a chapter/track number.*
- For VCD, SVCD and CD: Enter a track number.*



To clear the programs

One by one All programs at once



3

To check the program contents



To return to normal playback



Press the button repeatedly until both the program window and **RANDOM** disappear from the TV.

- ✔ To program the tracks in the bonus group on a DVD Audio disc, perform the “Playing back a bonus group” procedure (11 22) before operation.
- ✔ You can program up to 99 steps.

* For details on using the number buttons, see “How to use the number buttons” (11 11).

Playing at random—random play

1  **RANDOM**

2 

DVD VIDEO	DVD AUDIO	DVD VR
VCD	SVCD	CD
MP3 WMA WAV	JPEG	ASF
MPEG 1	MPEG 2	DivX

To return to normal playback



Press the button repeatedly until both the program window and **RANDOM** disappear from the TV.

- ✔ To play the tracks in the bonus group on a DVD Audio disc during random play, perform the “Playing back a bonus group” procedure (11 22) before operation.













Playing repeatedly—repeat play



The repeat modes you can select depend on the playback discs/files.



DVD VIDEO	DVD AUDIO	DVD VR
VCD	SVCD	CD
MP3 WMA WAV	JPEG	ASF
MPEG 1	MPEG 2	DivX

On the display	On the TV	Meaning
	 REPEAT GROUP	Repeat current group
	 REPEAT TITLE	Repeat current title
	 REPEAT PG	Repeat current program
	 REPEAT PL	Repeat current playlist
 ALL	 REPEAT ALL	Repeat all titles/ programs/tracks/files
	 TRACK,  STEP REPEAT TRACK, REPEAT STEP	Repeat current track
	 CHAP,  STEP	Repeat current chapter
No indication	 OFF	Repeat mode is deactivated

✔ You can repeat the desired part from the on-screen bar (A-B repeat). (11 23)

✔ For VCD and SVCD discs, this function is available only when PBC (11 19) is deactivated.

✔ This function is not available while playing back reserved songs for Karaoke (11 30).

* For DVD Video and DVD VR discs, this function is not available while playback is stopped.

Disc/file playback

Advanced operations

Changing the language/sound/scene angle

To do		Disc/file												
<p>Select the subtitle language*¹ *²</p> <p>1/3 ENGLISH</p> <ul style="list-style-type: none"> To show/hide the subtitle, press SUBTITLE. 		<table border="1"> <tr><td>DVD VIDEO</td><td>DVD AUDIO</td><td>DVD VR</td></tr> <tr><td>VCD</td><td>SVCD</td><td>CD</td></tr> <tr><td>MP3 WMA WAV</td><td>JPEG</td><td>ASF</td></tr> <tr><td>MPEG 1</td><td>MPEG 2</td><td>DivX</td></tr> </table>	DVD VIDEO	DVD AUDIO	DVD VR	VCD	SVCD	CD	MP3 WMA WAV	JPEG	ASF	MPEG 1	MPEG 2	DivX
DVD VIDEO	DVD AUDIO	DVD VR												
VCD	SVCD	CD												
MP3 WMA WAV	JPEG	ASF												
MPEG 1	MPEG 2	DivX												
<p>Select the audio language*²/audio channel</p> <p>1/3 ENGLISH</p>		<table border="1"> <tr><td>DVD VIDEO</td><td>DVD AUDIO</td><td>DVD VR</td></tr> <tr><td>VCD</td><td>SVCD</td><td>CD</td></tr> <tr><td>MP3 WMA WAV</td><td>JPEG</td><td>ASF</td></tr> <tr><td>MPEG 1</td><td>MPEG 2</td><td>DivX</td></tr> </table>	DVD VIDEO	DVD AUDIO	DVD VR	VCD	SVCD	CD	MP3 WMA WAV	JPEG	ASF	MPEG 1	MPEG 2	DivX
DVD VIDEO	DVD AUDIO	DVD VR												
VCD	SVCD	CD												
MP3 WMA WAV	JPEG	ASF												
MPEG 1	MPEG 2	DivX												
<p>Select the view angle</p> <p>1/3 1</p>		<table border="1"> <tr><td>DVD VIDEO</td><td>DVD AUDIO</td><td>DVD VR</td></tr> <tr><td>VCD</td><td>SVCD</td><td>CD</td></tr> <tr><td>MP3 WMA WAV</td><td>JPEG</td><td>ASF</td></tr> <tr><td>MPEG 1</td><td>MPEG 2</td><td>DivX</td></tr> </table>	DVD VIDEO	DVD AUDIO	DVD VR	VCD	SVCD	CD	MP3 WMA WAV	JPEG	ASF	MPEG 1	MPEG 2	DivX
DVD VIDEO	DVD AUDIO	DVD VR												
VCD	SVCD	CD												
MP3 WMA WAV	JPEG	ASF												
MPEG 1	MPEG 2	DivX												

For DVD Audio, the functions take effect for the moving picture part only.

¹For DVD VR and SVCD discs, the subtitle indication appears and can be changed by performing the above procedure even if no subtitles are recorded.

²Some subtitle or audio languages are abbreviated in the pop-up window. See "Language code list" (32).

Special picture playback

To do		Disc/file												
<p>Play back frame by frame</p>		<table border="1"> <tr><td>DVD VIDEO</td><td>DVD AUDIO</td><td>DVD VR</td></tr> <tr><td>VCD</td><td>SVCD</td><td>CD</td></tr> <tr><td>MP3 WMA WAV</td><td>JPEG</td><td>ASF</td></tr> <tr><td>MPEG 1</td><td>MPEG 2</td><td>DivX</td></tr> </table>	DVD VIDEO	DVD AUDIO	DVD VR	VCD	SVCD	CD	MP3 WMA WAV	JPEG	ASF	MPEG 1	MPEG 2	DivX
DVD VIDEO	DVD AUDIO	DVD VR												
VCD	SVCD	CD												
MP3 WMA WAV	JPEG	ASF												
MPEG 1	MPEG 2	DivX												
<p>Play back in slow-motion*¹</p>		<table border="1"> <tr><td>DVD VIDEO</td><td>DVD AUDIO</td><td>DVD VR</td></tr> <tr><td>VCD</td><td>SVCD</td><td>CD</td></tr> <tr><td>MP3 WMA WAV</td><td>JPEG</td><td>ASF</td></tr> <tr><td>MPEG 1</td><td>MPEG 2</td><td>DivX</td></tr> </table>	DVD VIDEO	DVD AUDIO	DVD VR	VCD	SVCD	CD	MP3 WMA WAV	JPEG	ASF	MPEG 1	MPEG 2	DivX
DVD VIDEO	DVD AUDIO	DVD VR												
VCD	SVCD	CD												
MP3 WMA WAV	JPEG	ASF												
MPEG 1	MPEG 2	DivX												
<p>Enlarge the picture*² *³</p> <ul style="list-style-type: none"> Change the scene magnification, then move the zoomed-in area. 		<table border="1"> <tr><td>DVD VIDEO</td><td>DVD AUDIO</td><td>DVD VR</td></tr> <tr><td>VCD</td><td>SVCD</td><td>CD</td></tr> <tr><td>MP3 WMA WAV</td><td>JPEG</td><td>ASF</td></tr> <tr><td>MPEG 1</td><td>MPEG 2</td><td>DivX</td></tr> </table>	DVD VIDEO	DVD AUDIO	DVD VR	VCD	SVCD	CD	MP3 WMA WAV	JPEG	ASF	MPEG 1	MPEG 2	DivX
DVD VIDEO	DVD AUDIO	DVD VR												
VCD	SVCD	CD												
MP3 WMA WAV	JPEG	ASF												
MPEG 1	MPEG 2	DivX												

To return to normal playback

- While playing back frame by frame or in slow-motion, press ► (play button).
- While zooming in the picture, select "OFF" by pressing ZOOM repeatedly while holding SHIFT.

For DVD Audio, the functions take effect for the moving picture part only.

¹For DVD Video and DVD Audio, reverse slow-motion is also available by pressing ◀ SLOW repeatedly.

²For JPEG files, you can zoom in only during pause.

³On some files, using cursor (►/◀/▼/▲) cannot move the zoomed-in area during playback.

Adjusting the picture quality (VFP)

You can adjust the picture mode.

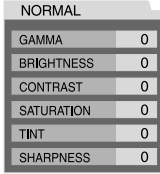
1  

NORMAL	
GAMMA	0
BRIGHTNESS	0
CONTRAST	0
SATURATION	0
TINT	0
SHARPNESS	0

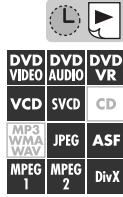

2 Select the desired preset, then finish the setting.



NORMAL	Normally select this.
CINEMA	Suitable for movies
USER1/ USER2	You can adjust parameters that affect picture appearance. (See below.)

To adjust the picture tone

- 1 Select "USER1" or "USER2" (see above).
- 2 Select a parameter, then confirm the selection.

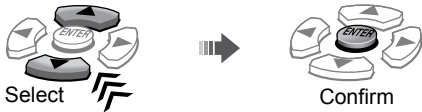

GAMMA	Controls the brightness of the neutral color
BRIGHTNESS	Controls the brightness of the entire picture
CONTRAST	Controls the contrast
SATURATION	Controls the color depth
TINT	Controls the tint
SHARPNESS	Controls the sharpness

3 Adjust the parameter, then confirm the selection.



4 Repeat steps 2 and 3 to adjust others.

5

When connecting the TV to the HDMI MONITOR OUT terminal (8), the VFP setting has no effect.

Special playback for DVD Audio

Playing back a bonus group

Some DVD Audio discs have a "bonus group." To play back a bonus group, you have to enter the specific "key number" (a password).

1 Select a bonus group.

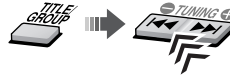

The key number entry screen appears.
On the TV On the display

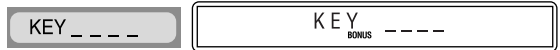

2 Enter the key number, then confirm the entry.



When the key number is accepted, playback starts and the BONUS indicator goes off.

- If playback does not start, enter correct key number again.

To clear the key number entry



Selecting browsable still pictures

While playing back a track linked to browsable still pictures (B.S.P), you can select the still pictures (turn the page).

- If a track is linked to browsable still pictures, they are usually shown automatically during playback.

Select the desired still picture.

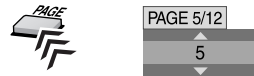

Disc/file playback

Operation from the TV screen

Using the on-screen bar

You can use various functions from the on-screen bar.

Basic operation procedure

1

Ex.: Status bar

Function bar*

2 Select the desired item (see the right column), then confirm the selection.



After confirming the selection...

- When the pull-down menu appears, select the desired item by pressing cursor ▲/▼ repeatedly, then confirm the selection by pressing ENTER.

Ex.:

- When a number-entry box appears, enter the number by using the number buttons (0-9), then confirm the entry by pressing ENTER.

Ex.:

To correct a misentry:

- setting: press cursor ◀ repeatedly to clear the misentry, then re-enter the number.
- setting: re-enter the number.

- When changing the time information mode () , select the desired item by pressing ENTER repeatedly.

To clear the on-screen bar



- The contents of the on-screen bar differ according to the type of discs/files.

* During playback of ASF, MPEG-1, MPEG-2 or DivX files, the function bar does not appear.

On-screen bar functions

	<p>Selects the time information mode shown on the display and the status bar.</p> <p>TIME*¹: Elapsed time of chapter/track</p> <p>REM*¹: Remaining time of chapter/track</p> <p>TOTAL: Elapsed time of title (DVD Video)/group (DVD Audio)/program (DVD VR)/disc (VCD/CD/SVCD)</p> <p>T.REM: Remaining time of title (DVD Video)/group (DVD Audio)/program (DVD VR)/disc (VCD/CD/SVCD)</p>
	<p>Selects repeat mode.</p> <p> / / / / / / / / :</p> <p>See also “Playing repeatedly—repeat play” (19).</p> <p> : Repeats the desired part (A-B repeat).*²</p> <p>After selecting this, select the beginning point (A) by pressing ENTER, then the end point (B) by pressing ENTER again.</p>
	Specifies the playback point by the time.
	Specifies a chapter to play back from.
	Specifies a track to play back from.
	Selects the audio language or audio channel during playback.
	Selects the subtitle language during playback.
	Selects the desired scene angle in a multi-angle part during playback.
	Selects the desired browsable still picture.

*¹ Not available for DVD VR discs

*² A-B repeat is not available in the following cases:

- Between the different titles/programs of DVD Video or DVD VR discs.
- During program play or random play.
- During the playback of VCD or SVCD with PBC (19) activated.

Using the file control display

- The file control display appears in the following cases.
 - Audio files: Always appears.
 - Movie and picture files: When TOP MENU(/PG) or MENU(/PL) is pressed or playback is stopped.

DVD VIDEO	DVD AUDIO	DVD VR
VCD	SVCD	CD
MP3 WMA WAV	JPEG	ASF
MPEG 1	MPEG 2	DivX

Using the program list/playlist (for DVD VR)



Program list

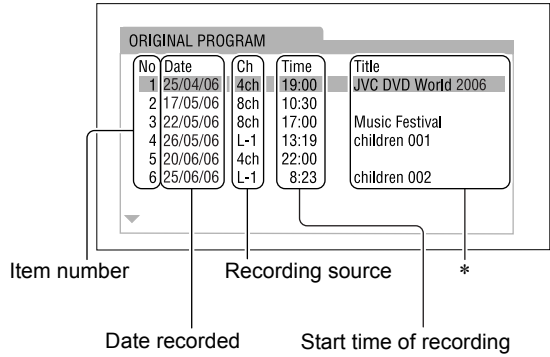

Playlist

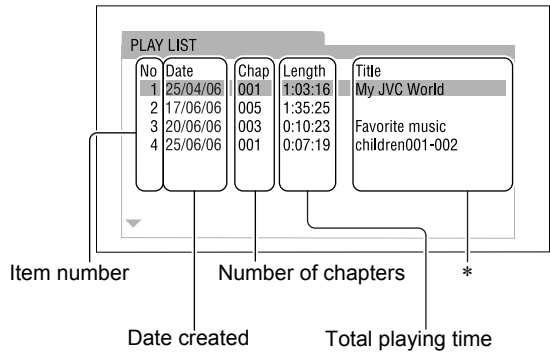

File control display

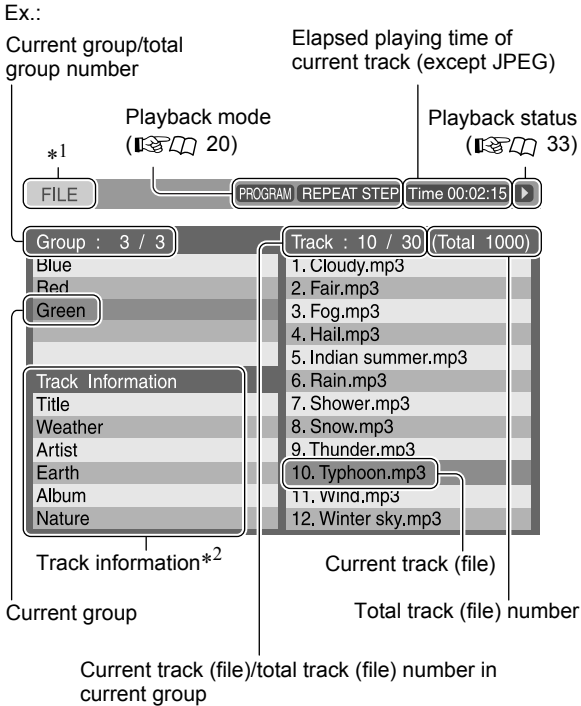

* The title may not be displayed depending on the recording equipment.

To play back the desired track/file

Select a desired group/track/file, then start playback.

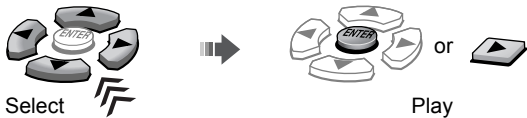

- For JPEG:
 - To start a slide-show from the selected file, press ► (play button).
 - To play the selected file only, press ENTER.

*1 When the source is "DVD," "FILE" appears, and when the source is "USB," "USB" appears.

*2 For MP3/WMA/WAV only.

To play back the desired item

1 To display the program list

To display the playlist



The System starts playing the first item.

2 Select the desired item.



3



Personal settings

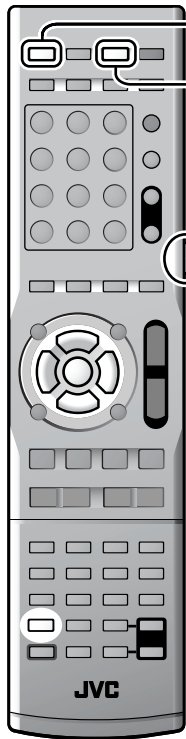

Set the remote control mode before operation.

For disc playback

AUDIO \leftarrow TV \leftarrow VCR/DBS \leftarrow 

For playback of a file on a USB mass storage class device

AUDIO \leftarrow TV \leftarrow VCR/DBS \leftarrow 

You can change the settings of the System according to your preferences and playing environment.



1 

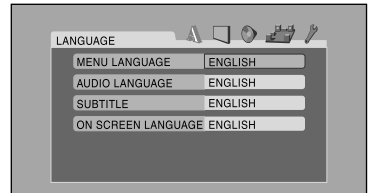

2 Select the menu.



3 Select the item, then confirm.



Repeat this procedure until all the options have been confirmed.



To close the setup screen



Language menu (LANGUAGE)

MENU LANGUAGE	Select the language for the DVD/DivX menu.	 See "Language code list" (32) for the code of each language, such as "AA," etc.
AUDIO LANGUAGE	Select the language for the audio language.	
SUBTITLE	Select the language for the subtitle language.	
ON SCREEN LANGUAGE	Select the language for the screen.	

Picture menu (PICTURE)

MONITOR TYPE	<p>Select 16:9 wide-screen playback to fit on your monitor. For wide TV: 16:9 NORMAL/16:9 MULTI NORMAL: For fixed 16:9 wide TV 16:9 AUTO/16:9 MULTI AUTO: For ordinary wide TV</p> <p>For conventional (4:3) TV: 4:3 LB/4:3 MULTI LB 4:3 PS/4:3 MULTI PS</p> <div style="display: flex; justify-content: space-around; align-items: center;">   </div> <ul style="list-style-type: none"> When selecting “MULTI” options as the monitor type for the multi-color system TV, the System emits PAL or NTSC video signal according to the disc/file, regardless of the color system setting (📖 15).
PICTURE SOURCE	<p>Select the source type of the disc/file contents when selecting the progressive scanning mode (📖 15). AUTO: Normally select this. FILM: For a film source movie VIDEO: For a video source movie</p>
SCREEN SAVER	<p>Activate (ON) or deactivate (OFF) the screen saver function.</p>
FILE TYPE	<p>Select the file type to play when several types of files are recorded on a disc/device. AUDIO: For audio files STILL PICTURE: For picture files VIDEO: For movie files</p>
HDMI DVI COLOR	<p>Select the picture appearance for a TV with an HDMI connection. STANDARD: No effect applied. ENHANCE: Select when you need automatic picture adjustment.</p>
HDMI OUT	<p>Select the type of video signal output from the HDMI MONITOR OUT terminal. AUTO: Normally select this. RGB: Select this when no picture appears on the TV with “AUTO.”</p>

Audio menu (AUDIO)

DOWN MIX	<p>This menu is available only when the speaker position mode is set to “S.SPK F” (📖 13). Select the audio signal output to the TV connected to the HDMI MONITOR OUT terminal. DOLBY SURROUND: For the TV equipped with Dolby Pro Logic decoder STEREO: For ordinary TV</p>
D. RANGE COMPRESSION	<p>You can enjoy powerful audio even at low volume level while playing Dolby Digital software. AUTO: Select this to apply the compression only to the multi-channel software (except 1-channel and 2-channel sources). ON: Select this to always apply the compression.</p>
HDMI AUDIO OUT	<p>This setting is effective only for the source “DVD” or “USB.” Select whether the System emits the audio signal from the HDMI MONITOR OUT terminal (ON) or not (OFF). • For selecting whether the external component emits the audio signal through its HDMI terminal, make the setting on the external component.</p>

Underlined items are the initial settings.



Speaker setting menu (SPK.SETTING)

SPK.SETTING menu is available only when the speaker position mode is set to "S.SPK R" (🔧📖 13).

LEVEL	Adjust the output level of each speaker while monitoring the test tone. FRONT LEFT/RIGHT SPEAKER, CENTER SPEAKER, SURROUND RIGHT/LEFT SPEAKER: Select the speaker, then adjust the output level. TEST TONE: Turns on/off the test tone.
DELAY	Adjust the delay time of the speakers. FRONT LEFT/RIGHT SPEAKER, CENTER SPEAKER, SURROUND RIGHT/LEFT SPEAKER: Select the speaker, then adjust the distance from the listening position to the speakers. <ul style="list-style-type: none"> • 1 ms increase (or decrease) in delay time corresponds to about 30 cm decrease (or increase) in distance. • Set to 0 ms for the furthest speaker from your position as the basis for the delay time setting.
SUBWOOFER	Make the subwoofer settings. LEVEL: Adjust the output level of the subwoofer. CROSS OVER: Select an appropriate crossover frequency according to the size of the cone speaker unit built into the small speaker connected. <ul style="list-style-type: none"> • 120Hz: Select this when the cone speaker unit size is 8 cm or more. • 150Hz: Select this when the cone speaker unit size is between 6 cm and 8 cm. • 200Hz: Select this when the cone speaker unit size is 5 cm or less.

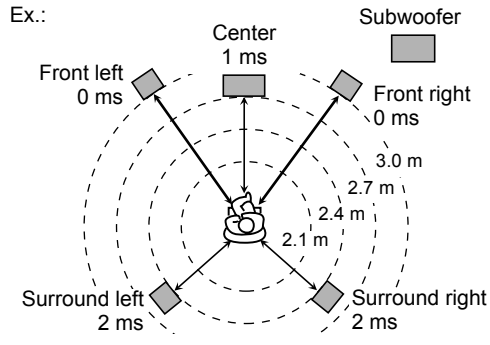

Other setting menu (OTHERS)

RESUME	Activate (<u>ON</u>) or deactivate (OFF) the resume function.
ON SCREEN GUIDE	Activate (<u>ON</u>) or deactivate (OFF) the on-screen guide icons.
DivX REGISTRATION	The System has its own Registration Code for DivX playback. You can confirm the code of your System. <ul style="list-style-type: none"> • Once you play back a DivX file created by using the Registration Code, the System's code is overwritten by a totally different new one for copyright protection purposes.

Tuner operations

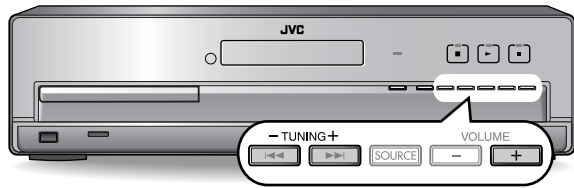
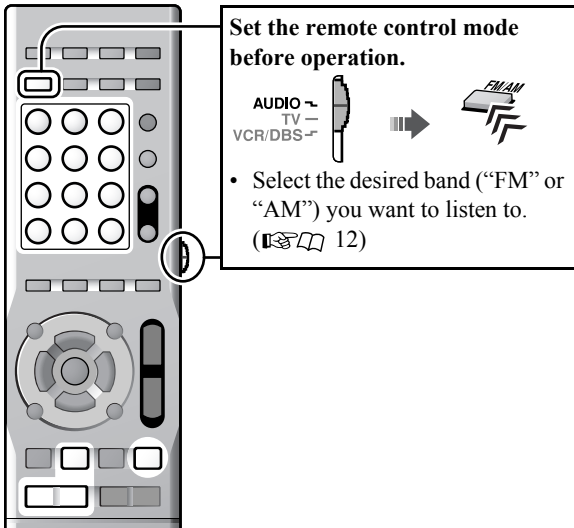

- You can also tune in to a station automatically. Press and hold TUNING +/TUNING - until the station search starts. The system automatically tunes in the first-found station of sufficient signal strength.
- You can also tune in to the station by pressing cursor ▲/▼.

Preset tuning

You can preset 30 FM stations and 15 AM stations.

Storing the preset stations

- Tune in to the station you want to preset.**
- MEMORY** “_ _” flashes on the display. Perform the next step while “_ _” is flashing.
- Select a preset number, then store the station to that number.**



Enter a preset number*

- * “STORED” appears on the display.

Tuning in to a preset station

Select a preset number.*



- You can also select a preset number by pressing PRESET UP or PRESET DOWN.

* For details on using the number buttons, see “How to use the number buttons” (11).

Setting the AM tuner interval spacing

Some countries space AM stations 9 kHz apart, and some countries use 10 kHz spacing.

You can only change the AM tuner interval spacing while selecting “AM” as the band.

- This operation is available when the System is turned off.

To Change the interval spacing into 10 kHz	To Change the interval spacing into 9 kHz
<p>↓ Hold</p> <p>TUNING+ + VOLUME</p> <p>(On the center unit)</p>	<p>↓ Hold</p> <p>- TUNING + VOLUME</p> <p>(On the center unit)</p>

Manual tuning

Tuning in to a station

Selecting the FM reception mode

When the stereo FM program currently tuned in is noisy, you can change the FM reception mode to improve the reception.

AUTO	Normally select this. <ul style="list-style-type: none"> When a stereo station is tuned in, the ST indicator lights on the display.
MONO	Select to improve reception. (You will lose the stereo effect.)

Karaoke operations

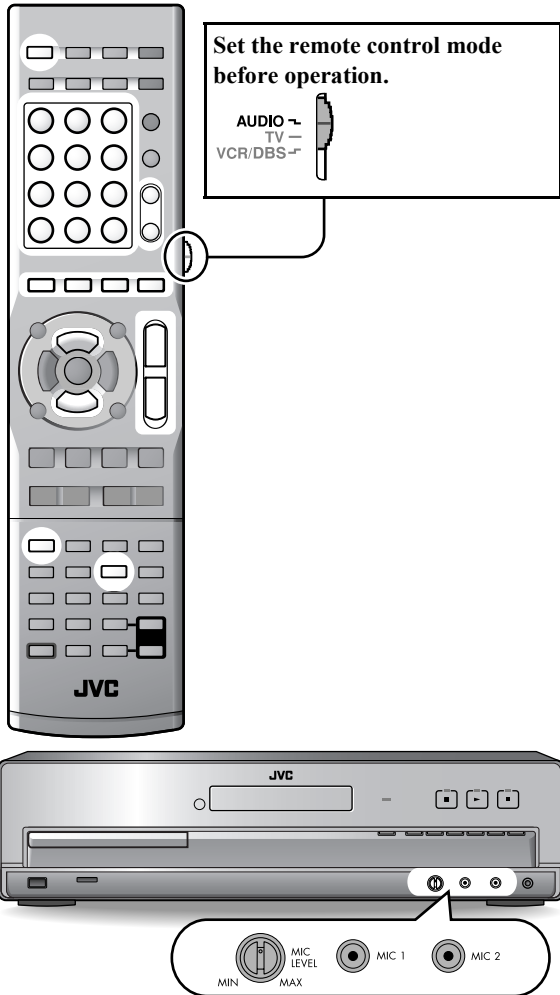

- ⚠ Always set MIC LEVEL to MIN when connecting or disconnecting the microphone.
- ⚠ Do not keep the microphones connected while they are not in use.

Basic procedure for Karaoke

- 1 Connect the microphone(s) to the MIC 1 or/and MIC 2 jack on the center unit.

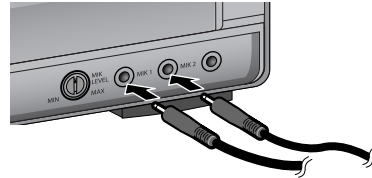

DVD VIDEO	DVD AUDIO	DVD VR
VCD	SVCD	CD
MP3 WMA WAV	JPEG	ASF
MPEG 1	MPEG 2	DivX

- 2 Select "DVD" as the source.
- 3 Activate the Karaoke function.

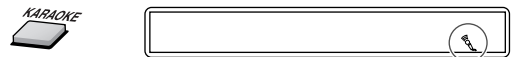

- 4 Start playing a disc.
 - You can select the audio channel for a disc. See "Selecting the audio channel" (📖 30).
 - For the sound adjustment for Karaoke, see "Sound adjustments for Karaoke" (📖 30).
- 5 Sing into the microphone.
- 6 Adjust the microphone's volume and System's volume.

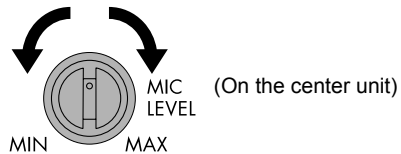

- For the adjustment of the System's volume, see "Adjusting the volume" (📖 12).
 - To deactivate the Karaoke function, press KARAOKE again. The 🎤 indicator goes off.
- ⚠ No sound through the microphone is heard from the speakers while the disc is not played back, but when the headphones are connected, the sound will come out of the headphones. (For TH-D7, the sound through the microphone will come out of the component connected through the AUDIO OUT jacks whether the disc is being played back or not.)
 - ⚠ While the Karaoke function is in use, the surround mode is canceled.
 - ⚠ The Karaoke function is canceled when you start playing back DVD Audio, DVD VR, JPEG, ASF, MPEG-1, MPEG-2 or DivX.

Selecting the audio channel

The audio channel can be selectable with most of the Karaoke discs.



DVD VIDEO	DVD AUDIO	DVD VR
VCD	SVCD	CD
MP3 WMA WAV	JPEG	ASF
MPEG 1	MPEG 2	DivX

Each time you press AUDIO, the audio channel changes as follows:

- Example for a VCD:
 - ST: To listen to L (left) and R (right) audio channels.
 - L: To listen to L (left) audio channel.
 - R: To listen to R (right) audio channel.

Sound adjustments for Karaoke

The following items can be adjustable when the Karaoke function is activated.

DVD VIDEO	DVD AUDIO	DVD VR
VCD	SVCD	CD
MP3 WMA WAV	JPEG	ASF
MPEG 1	MPEG 2	DivX

Reducing the voice recorded on a disc/file—voice masking



“V. MASK” appears on the display.

To restore the voice, press the button again.

- The voice may not be reduced enough with some discs/files.

Shifting the pitch of the playback sound—key control



You can shift the pitch of the playback sound from -6 to +6.

For DVD Video/VCD/SVCD/CD:

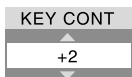

For MP3/WMA:



- Select “0” to return to the normal playback.
- The setting is applied only to the current title/track/file.
- Depending on the type of the recorded source (such as DTS Digital Surround software, etc.), you may not be able to shift the pitch.

Applying an echo to your voice—echo



ECHO 1 → ECHO 2 → ECHO 3
→ ECHO OFF (canceled) →
(back to the beginning)

- As the number increases, the effect will be emphasized.

Reserving Karaoke songs

You can reserve the songs up to 12.

1



No	Gr/Tt	Tr/Chap
1		
2		
3		
4		
5		

Reservation list

DVD VIDEO	DVD AUDIO	DVD VR
VCD	SVCD	CD
MP3 WMA WAV	JPEG	ASF
MPEG 1	MPEG 2	DivX

2 Select the desired chapters/tracks/files.

- For VCD, SVCD and CD: Enter a track number.*
- For discs/files other than above: Enter a title/group number, then a chapter/track/file number.*



3 Repeat step 2 to reserve the rest of your selection.

To clear a reserved song



Select



Clear

To add a song



Select the position to add a song



Enter the chapter/track/file number

4 Start playback.

The reservation list goes off when you press RESERVE. To show the list, press the button again.

- You can additionally reserve a song after the song currently played back. To reserve a song, stop playback and perform the procedure in step 2 above, then start playback.

- When you start playing back the reserved songs, make sure the reservation list appears on the TV screen; otherwise, you cannot start playback.

* For details on using the number buttons, see “How to use the number buttons” (11).

Operating external components

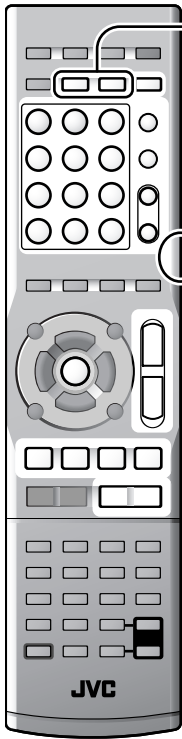

Set the remote control mode before operation.

For TV



For DBS tuner or CATV converter

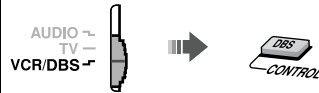

For VCR



Preparation

Make the audio input setting before operation. (14)

Operating external components

Set the remote control mode before operating each external component (see the left column).

Operating the TV

⏻ TV	Turns the power on and off
TV VOL +/-	Adjusts the volume
TV/VIDEO	Selects the input mode (either TV or VIDEO)
CH +/-	Changes the channels
1-10, 0, ≥ 10 (100+)	Selects the channels
TV RETURN	Alternates between the previously selected channel and the current channel

Operating the DBS tuner or CATV converter

⏻ VCR/DBS	Turns the power on and off
CH +/-	Changes the channels
1-10, 0, ≥ 10 (100+)	Selects the channels

Operating the VCR

⏻ VCR/DBS	Turns the power on and off
▶ (play button)	Starts playback
■	Stops playback
⏸	Pauses
▶▶	Fast-forwards the tape
◀◀	Rewinds the tape
REC	Press this button together with ▶ (play button) to start recording or together with ⏸ to enter recording-pause.
CH +/-	Changes the TV channels
0 - 9	Selects the TV channels

Setting the manufacturer's code

Before operating external components from the remote control, set the manufacturer's code.

- 1 Set the remote control mode (see above).
- 2 Press and hold ⏻ for the target component until the setting is finished.

For TV	For DBS tuner or CATV converter	For VCR



- 3 Enter the manufacturer's code.

See "Manufacturer's code list" for the manufacturer's code. (32)



- 4 Release ⏻.

- ✓ If there is more than one code listed for the corresponding brand, try each one until you enter the correct one.
- ✓ Reset the codes after replacing batteries of the remote control.

References

Manufacturer's code list

TV

JVC	01*	Samsung	12
Hitachi	10	Sanyo	13, 14
Magnavox	02	Sharp	06
Mitsubishi	03	Sony	07
Panasonic	04, 11	Toshiba	08
Philips	15	Zenith	09
RCA	05		

DBS tuner or CATV converter

Echostar	21
G.I.	01*, 02, 03, 04, 05, 06, 07, 08
Hamlin	15, 16, 17, 18
Jerrold	01, 02, 03, 04, 05, 06, 07, 08
Pioneer	13, 14
RCA	19
Scientific Atlanta	09, 10
Sony	20
Zenith	11, 12

VCR

JVC	01*, 02, 03	Philips	09
Emerson	11, 26	RCA	05, 06
Fisher	29	Samsung	24
Funai	10, 14, 15, 16	Sanyo	21, 22, 23
Gold Star	12	Sharp	27, 28
Hitachi	04	Shintom	30
Mitsubishi	13	Sony	18, 19, 20
NEC	25	Zenith	08
Panasonic	07, 17		

* Initial setting

⚠ Manufacturers' codes are subject to change without notice.









Language code list

AA	Afar	IW	Hebrew	RO	Rumanian
AB	Abkhazian	JI	Yiddish	RW	Kinyarwanda
AF	Afrikaans	JW	Javanese	SA	Sanskrit
AM	Ameharic	KA	Georgian	SD	Sindhi
AR	Arabic	KK	Kazakh	SG	Sangho
AS	Assamese	KL	Greenlandic	SH	Serbo-Croatian
AY	Aymara	KM	Cambodian		
AZ	Azerbaijani	KN	Kannada	SI	Singhalese
BA	Bashkir	KO	Korean (KOR)	SL	Slovenian
BE	Byelorussian			SM	Samoan
BG	Bulgarian	KS	Kashmiri	SN	Shona
BH	Bihari	KU	Kurdish	SO	Somali
BI	Bislama	KY	Kirghiz	SQ	Albanian
BN	Bengali, Bangla	LA	Latin	SR	Serbian
		LN	Lingala	SS	Siswati
BO	Tibetan	LO	Laothian	ST	Sesotho
BR	Breton	LT	Lithuanian	SU	Sundanese
CA	Catalan	LV	Latvian, Lettish	SV	Swedish
CO	Corsican			SW	Swahili
CY	Welsh	MG	Malagasy	TA	Tamil
DA	Danish	MI	Maori	TE	Telugu
DZ	Bhutani	MK	Macedonian	TG	Tajik
EL	Greek	ML	Malayalam	TH	Thai
EO	Esperanto	MN	Mongolian	TI	Tigrinya
ET	Estonian	MO	Moldavian	TK	Turkmen
EU	Basque	MR	Marathi	TL	Tagalog
FA	Persian	MS	Malay (MAY)	TN	Setswana
FI	Finnish	MT	Maltese	TO	Tonga
FJ	Fiji	MY	Burmese	TR	Turkish
FO	Faroese	NA	Nauru	TS	Tsonga
FY	Frisian	NE	Nepali	TT	Tatar
GA	Irish	NL	Dutch	TW	Twí
GD	Scots Gaelic	NO	Norwegian	UK	Ukrainian
GL	Galician	OC	Occitan	UR	Urdu
GN	Guarani	OM	(Afan) Oromo	UZ	Uzbek
GU	Gujarati			VI	Vietnamese
HA	Hausa	OR	Oriya	VO	Volapuk
HI	Hindi	PA	Panjabi	WO	Wolof
HR	Croatian	PS	Pashto, Pushto	XH	Xhosa
HY	Armenian			YO	Yoruba
IA	Interlingua	PT	Portuguese	ZU	Zulu
IE	Interlingue	QU	Quechua		
IK	Inupiak	RM	Rhaeto-Romance		
IN	Indonesian				
IS	Icelandic	RN	Kirundi		

References

Messages and icons shown on the TV

OPEN/CLOSE	Opening or closing the disc tray
NOW READING	Reading the disc/file information
READING INDEX...	Reading the DivX file
REGION CODE ERROR!	The Region Code of the DVD Video disc does not match the code the System supports. (📖 3)
NO DISC	No disc or an unfinalized disc is loaded.
NO USB DEVICE	No USB mass storage class device is loaded.
CANNOT PLAY THIS DISC	An unplayable disc is loaded.
CANNOT PLAY THIS DEVICE	An unplayable USB mass storage class device is connected.
RESTRICTED DEVICE	iPod is connected to the USB MEMORY terminal.
NOT SUPPORT	The file cannot be played back.

	The operation is unacceptable.
	Playback
	Pause
	Fast-forward/fast-reverse
	Forward/reverse slow-motion playback
	The scene contains multi-audio languages.
	The scene contains multi-subtitle languages.
	The scene contains multi-angle views.

🔧 You can change the setting so that the on-screen guide icons do not appear on the TV. (📖 27)

Troubleshooting

Power does not come on.

➔ The power plug is not inserted securely. Plug it in securely.

Unable to operate the System from the remote control.

➔ The path between the remote control and the remote sensor on the center unit is blocked.
➔ The batteries are exhausted.

No sound is heard.

➔ The speaker connections and/or audio cord connections are incorrect or loose. (📖 5, 9)
➔ Headphones are connected.

The sound is distorted.

➔ The speaker layout (📖 7) does not match the speaker position mode (📖 13).

No picture appears on the TV.

➔ The video cord connections are incorrect or loose. (📖 8 – 10)

The picture does not fit the TV.

➔ The monitor type is not set correctly. (📖 26)

No picture is displayed on the TV, the picture is blurred, or the picture is divided into two parts.

➔ Inappropriate color system and scanning mode is selected. (📖 15)

No picture is displayed on the TV or no sound comes out through the HDMI connection.

➔ The connected TV is not HDCP-compatible. (“HDCP ERR” appears on the display.)
➔ Disconnect the HDMI cable and connect it again, or use a shorter cable.

Video and audio are distorted.

- ➔ The disc is scratched or dirty.
- ➔ Audio/video files have not been properly copied on to the USB mass storage class device.
- ➔ A VCR is connected between the center unit and the TV. Connect the center unit and TV directly. (📖 8, 9)

Unable to select the item you want when setting the audio input for “VIDEO1” or “VIDEO2” (TH-D7 only).

- ➔ The setting is used to the other source. Change the setting of the other source to any other temporarily and use the setting to the target source. After that change the setting of the other source if needed.
Ex.: When changing the setting as follows:
 - For “VIDEO1”: from “COAX” to “OPT”
 - For “VIDEO2”: from “OPT” to “COAX”
 1. Select “2CH” for “VIDEO2.”
 2. Select “OPT” for “VIDEO1.”
 3. Select “COAX” for “VIDEO2.”

VCD/SVCD operation cannot be performed.

- ➔ Some functions do not work for VCDs/SVCDs when the PBC function is used.

No sound is heard from the external components, or the video and audio do not match.

- ➔ The selected audio input is not appropriate. Select the audio input to match the component connected. (📖 14)

The iPod does not play even though “CONNECT” appears on the display.

- ➔ The battery of the iPod is exhausted. Leave the iPod connected for at least 10 minutes.

The iPod cannot be operated from the System.

- ➔ The iPod battery charge function is deactivated. (📖 16)
- ➔ The iPod is not compatible with the System. Check the compatibility. (📖 3)

iPod is not charged.

- ➔ The source is not “iPod.”
- ➔ The iPod battery charge function is deactivated. (📖 16)

The broadcast is hard to hear because of noise.

- ➔ Antenna connections are incorrect or loose. (📖 8)
- ➔ The AM loop antenna is too close to the System.
- ➔ The FM Antenna is not properly extended and positioned. (📖 8)

- This product incorporates copyright protection technology that is protected by U.S. patents and other intellectual property rights. Use of this copyright protection technology must be authorized by Macrovision, and is intended for home and other limited viewing uses only unless otherwise authorized by Macrovision. Reverse engineering or disassembly is prohibited.
- “CONSUMERS SHOULD NOTE THAT NOT ALL HIGH DEFINITION TELEVISION SETS ARE FULLY COMPATIBLE WITH THIS PRODUCT AND MAY CAUSE ARTIFACTS TO BE DISPLAYED IN THE PICTURE. IN CASE OF 525 OR 625 PROGRESSIVE SCAN PICTURE PROBLEMS, IT IS RECOMMENDED THAT THE USER SWITCH THE CONNECTION TO THE ‘STANDARD DEFINITION’ OUTPUT.
IF THERE ARE QUESTIONS REGARDING OUR TV SET COMPATIBILITY WITH THIS MODEL 525p AND 625p DVD PLAYER, PLEASE CONTACT OUR CUSTOMER SERVICE CENTER.”
- USE OF THIS PRODUCT IN ANY MANNER THAT COMPLIES WITH THE MPEG-4 VISUAL STANDARD IS PROHIBITED, EXCEPT FOR USE BY A CONSUMER ENGAGING IN PERSONAL AND NON-COMMERCIAL ACTIVITIES.
- DivX, DivX Ultra Certified, and associated logos are trademarks of DivX, Inc. and are used under license.
- Official DivX® Ultra Certified product
- Plays all versions of DivX® video (including DivX® 6) with enhanced playback of DivX® media files and the DivX® Media Format
- Microsoft and Windows Media are either registered trademarks or trademarks of Microsoft Corporation in the United States and/or other countries.
- DVD Logo is a trademark of DVD Format/Logo Licensing Corporation.
- Manufactured under license from Dolby Laboratories. “Dolby”, “Pro Logic”, “MLP Lossless”, and the double-D symbol are trademarks of Dolby Laboratories.
- “DTS” and “DTS Digital Surround” are registered trademarks of DTS, Inc.
- HDMI, the HDMI logo and High-Definition Multimedia Interface are trademarks or registered trademarks of HDMI Licensing LLC.
- HDCP is the abbreviation of “High-bandwidth Digital Content Protection,” and is the high-reliable copy control technology licensed by Digital Content Protection, LLC.

References

Specifications

Center unit (XV-THD7/XV-THD5)

Output power

Front:
140 W per channel, RMS at 4 Ω at 1 kHz, with 10 % total harmonic distortion.

Center:
130 W, RMS at 4 Ω at 1 kHz, with 10 % total harmonic distortion.

Surround:
130 W per channel, RMS at 4 Ω at 1 kHz, with 10 % total harmonic distortion.

Subwoofer:
140 W, RMS at 4 Ω at 100 Hz, with 10 % total harmonic distortion.

Audio section

Digital Input*
DIGITAL IN
OPTICAL: -21 dBm to -15 dBm (660 nm ±30 nm)

Only for XV-THD7
COAXIAL: 0.5 V(p-p)/75 Ω
Analog input:
For XV-THD7:
VIDEO 2 AUDIO IN
For XV-THD5:
AUDIO IN

Analog output:
Only for XV-THD7:
AUDIO OUT

Video section

Video System: PAL/NTSC
Horizontal Resolution: 500 lines
Signal-to-Noise Ratio: 64 dB
Video Output Level
Composite: 1.0 V(p-p)/75 Ω
S-video-Y: 1.0 V(p-p)/75 Ω
S-video-C: For PAL: 0.3 V(p-p)/75 Ω
For NTSC: 0.286 V(p-p)/75 Ω
Component-Y: 1.0 V(p-p)/75 Ω
Component-PB/PR: 0.7 V(p-p)/75 Ω
Video Input Sensitivity/Impedance
(VIDEO IN for XV-THD5/VIDEO 2 IN for XV-THD7)
Composite: 1.0 V(p-p)/75 Ω
S-video-Y: 1.0 V(p-p)/75 Ω
S-video-C: For PAL: 0.3 V(p-p)/75 Ω
For NTSC: 0.286 V(p-p)/75 Ω

HDMI

HDMI Input (VIDEO 1 IN) (Only for XV-THD7):
PASS THROUGH (up to 225 MHz)
HDMI Output (MONITOR OUT):
For PAL: 576p/720p/1080i
For NTSC: 480p/720p/1080i

USB storage

USB Specification: Compatible with USB 2.0 Full Speed
Compatible Device: Mass Storage Class
Compatible File System: FAT16, FAT32
Bus Power Supply: Max. 500 mA

Tuner section

Tuner Range
FM: 87.50 MHz to 108.00 MHz
AM:
At 10 kHz intervals
For Saudi Arabia: 530 kHz to 1 600 kHz
For the other countries: 530 kHz to 1 710 kHz
At 9 kHz intervals
For Saudi Arabia: 531 kHz to 1 602 kHz
For the other countries: 531 kHz to 1 710 kHz

General

Power Requirements:
AC 110 V/127 V/220 V - 240 V ~, 50/60 Hz
(selectable with the voltage selector)

Power Consumption: 160 W (during operation)
4.0 W (in standby mode)

Dimensions (W × H × D): 435 mm × 115 mm × 270 mm
Mass: 6.8 kg

* Corresponding to Linear PCM, Dolby Digital, and DTS Digital Surround (with sampling frequency — 32 kHz, 44.1 kHz, 48 kHz)

Subwoofer

For SP-THD7W (TH-D7)

Type: Bass-Reflex Type
Speaker: 20 cm cone × 1
Power Handling Capacity: 140 W
Impedance: 4 Ω
Frequency Range: 28 Hz to 200 Hz
Sound Pressure Level: 75 dB/W-m
Dimensions (W × H × D): 353.5 mm × 351 mm × 248 mm
Mass: 8.5 kg

For SP-THD5W (TH-D5)

Type: Bass-Reflex Type
Speaker: 16 cm cone × 1
Power Handling Capacity: 140 W
Impedance: 4 Ω
Frequency Range: 30 Hz to 200 Hz
Sound Pressure Level: 75 dB/W-m
Dimensions (W × H × D): 353.5 mm × 351 mm × 174 mm
Mass: 6.3 kg

■ Satellite speakers (For TH-D7)

Front speakers (SP-THD7F)

Type: 2-Way 3-Speaker Bass-Reflex Type (Magnetically Shielded Type)

Speaker: 8 cm cone × 2
3 cm dome × 1

Power Handling Capacity: 140 W

Impedance: 4 Ω

Frequency Range: 75 Hz to 20 000 Hz

Sound Pressure Level: 83 dB/W·m

Dimensions (W × H × D):
280 mm × 1 100 mm × 280 mm (with stand)
280 mm × 594 mm × 280 mm (without stand)

Mass: 8.9 kg each (with stand)
6.5 kg each (without stand)

Center speaker (SP-THD7C)

Type: 1-Way 2-Speaker Bass-Reflex Type (Magnetically Shielded Type)

Speaker: 8 cm cone × 2

Power Handling Capacity: 140 W

Impedance: 4 Ω

Frequency Range: 75 Hz to 20 000 Hz

Sound Pressure Level: 84 dB/W·m

Dimensions (W × H × D): 435 mm × 100 mm × 118 mm

Mass: 2.2 kg

Surround speakers (SP-THD7S)

Type: 1-Way Bass-Reflex Type (Magnetically Shielded Type)

Speaker: 8 cm cone × 1

Power Handling Capacity: 140 W

Impedance: 4 Ω

Frequency Range: 75 Hz to 20 000 Hz

Sound Pressure Level: 77 dB/W·m

Dimensions (W × H × D): 98.5 mm × 215 mm × 118 mm

Mass: 1.0 kg each

■ Satellite speakers (For TH-D5)

Front speakers (SP-THD5F)

Type: 1-Way Bass-Reflex Type (Magnetically Shielded Type)

Speaker: 8 cm cone × 1

Power Handling Capacity: 140 W

Impedance: 4 Ω

Frequency Range: 90 Hz to 20 000 Hz

Sound Pressure Level: 80 dB/W·m

Dimensions (W × H × D): 98.5 mm × 214.5 mm × 93.5 mm

Mass: 1.0 kg each

Center speaker (SP-THD5C)

Type: 1-Way 2-Speaker Bass-Reflex Type (Magnetically Shielded Type)

Speaker: 8 cm cone × 2

Power Handling Capacity: 140 W

Impedance: 4 Ω

Frequency Range: 90 Hz to 20 000 Hz

Sound Pressure Level: 84 dB/W·m

Dimensions (W × H × D): 435 mm × 99 mm × 93.5 mm

Mass: 2.0 kg

Surround speakers (SP-THD5S)

Type: 1-Way Bass-Reflex Type (Magnetically Shielded Type)

Speaker: 8 cm cone × 1

Power Handling Capacity: 140 W

Impedance: 4 Ω

Frequency Range: 90 Hz to 20 000 Hz

Sound Pressure Level: 76 dB/W·m

Dimensions (W × H × D): 98.5 mm × 214.5 mm × 93.5 mm

Mass: 0.85 kg each

Dimensions of the wall-mount attachment on the center and surround speakers:

SP-THD7C/SP-THD5C

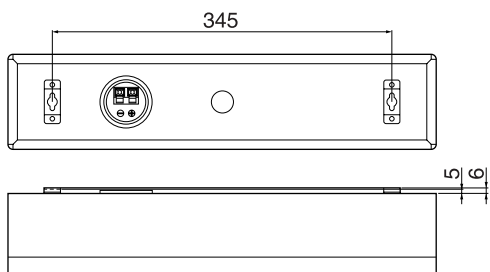

SP-THD7S/SP-THD5S

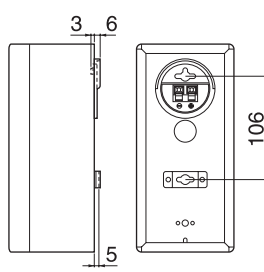

Unit: mm

Designs and specifications are subject to change without notice.

Mains (AC) Line Instruction

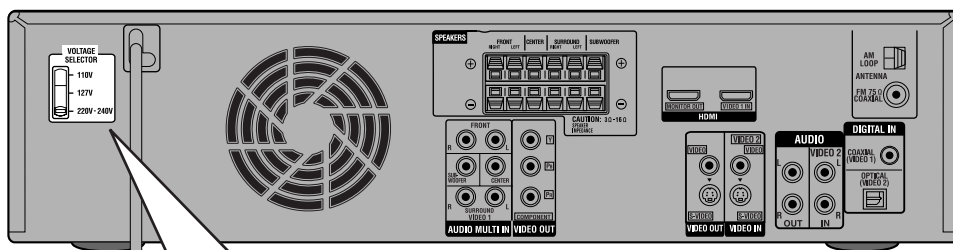

VOLTAGE SELECTOR

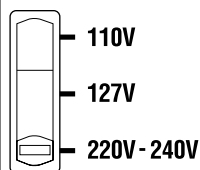

CAUTION for mains (AC) line

BEFORE PLUGGING IN, do check that your mains (AC) line voltage corresponds with the position of the voltage selector switch provided on the outside of this equipment and, if different, reset the voltage selector switch, to prevent from a damage or risk of fire/electric shock.

JVC

Free Manuals Download Website

<http://myh66.com>

<http://usermanuals.us>

<http://www.somanuals.com>

<http://www.4manuals.cc>

<http://www.manual-lib.com>

<http://www.404manual.com>

<http://www.luxmanual.com>

<http://aubethermostatmanual.com>

Golf course search by state

<http://golfingnear.com>

Email search by domain

<http://emailbydomain.com>

Auto manuals search

<http://auto.somanuals.com>

TV manuals search

<http://tv.somanuals.com>