

JVC



MICRO COMPONENT SYSTEM

UX-GB9DAB

—Consists of CA-UXGB9DAB and SP-UXGB9DAB

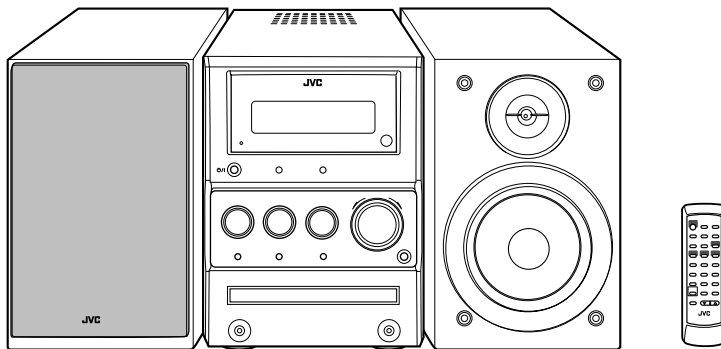

COMPACT
disc
DIGITAL AUDIO

MP3
PLAYBACK

Radio Data System

DAB
Digital Audio Broadcasting

INSTRUCTIONS

GVT0172-001A
[B]

Warnings, Cautions and Others

IMPORTANT for the U.K.

DO NOT cut off the mains plug from this equipment. If the plug fitted is not suitable for the power points in your home or the cable is too short to reach a power point, then obtain an appropriate safety approved extension lead or consult your dealer.

BE SURE to replace the fuse only with an identical approved type, as originally fitted.

If nonetheless the mains plug is cut off ensure to remove the fuse and dispose of the plug immediately, to avoid a possible shock hazard by inadvertent connection to the mains supply.

If this product is not supplied fitted with a mains plug then follow the instructions given below:

IMPORTANT:

DO NOT make any connection to the terminal which is marked with the letter E or by the safety earth symbol or coloured green or green-and-yellow.

The wires in the mains lead on this product are coloured in accordance with the following code:

Blue: Neutral
Brown: Live

As these colours may not correspond with the coloured markings identifying the terminals in your plug proceed as follows:

The wire which is coloured blue must be connected to the terminal which is marked with the letter N or coloured black.

The wire which is coloured brown must be connected to the terminal which is marked with the letter L or coloured red.

IF IN DOUBT - CONSULT A COMPETENT ELECTRICIAN.

CAUTION— button!

Disconnect the mains plug to shut the power off completely (the STANDBY lamp goes off). When installing the apparatus, ensure that the plug is easily accessible. The  button in any position does not disconnect the mains line.

- When the unit is on standby, the STANDBY lamp lights red.
 - When the unit is turned on, the STANDBY lamp goes off.
- The power can be remote controlled.

CAUTION

To reduce the risk of electrical shocks, fire, etc.:

1. Do not remove screws, covers or cabinet.
2. Do not expose this appliance to rain or moisture.

IMPORTANT FOR LASER PRODUCTS

1. CLASS 1 LASER PRODUCT
2. **CAUTION:** Do not open the top cover. There are no user serviceable parts inside the unit; leave all servicing to qualified service personnel.
3. **CAUTION:** Visible and/or invisible class 1M laser radiation when open. Do not view directly with optical instruments.
4. REPRODUCTION OF LABEL: CAUTION LABEL, PLACED INSIDE THE UNIT.

CAUTION VISIBLE AND/OR INVISIBLE CLASS 1M LASER RADIATION WHEN OPEN, DO NOT VIEW DIRECTLY WITH OPTICAL INSTRUMENTS. IEC60825-1:2001	ATTENTION RAYONNEMENT LASER VISIBLE ET/OU INVISIBLE DE CLASSE 1M UNE FOIS OUVERT NE PAS REGARDER DIRECTEMENT AVEC DES INSTRUMENTS OPTIQUES. (EN6)	LASER RADIACION LASER DE CLASE 1M VISIBLE Y/O INVISIBLE CUANDO ESTA ABIERTO, NO MIRAR DIRECTAMENTE CON INSTRUMENTAL OPTICA. (EN7)	WARNING SYNLIG OCH/ELLER OSYNLIG LASERSTRÅLNING, KLASS 1M, NÅR DENNA RE. ÅR ÖPPNAD. BETRÄKTA EJ STRÅLEN MED OPTISKA INSTRUMENT. (EN8)	注意 レーザー光と電磁 放射/赤外線等類 のクラス1M レーザー放射が 発生す 光学観望で電望 しないでください。 (EN9)	CAUTION VISIBLE AND/OR INVISIBLE CLASS II LASER RADIATION WHEN OPEN, DO NOT STARE INTO BEAM FDA 21 CFR (EN6) LVA4603-003A
--	--	--	--	---	---

CAUTION

- Do not block the ventilation openings or holes. (If the ventilation openings or holes are blocked by a newspaper or cloth, etc., the heat may not be able to get out.)
- Do not place any naked flame sources, such as lighted candles, on the apparatus.
- When discarding batteries, environmental problems must be considered and local rules or laws governing the disposal of these batteries must be followed strictly.
- Do not expose this apparatus to rain, moisture, dripping or splashing and that no objects filled with liquids, such as vases, shall be placed on the apparatus.

Dear Customer,

This apparatus is in conformance with the valid European directives and standards regarding electromagnetic compatibility and electrical safety.

European representative of Victor Company of Japan Limited is:

JVC Technology Centre Europe GmbH
P.O. Box 10 05 52
61145 Friedberg
Germany

Caution: Proper Ventilation

To avoid risk of electric shock and fire, and to prevent damage, locate the apparatus as follows:

1. Front: No obstructions and open spacing.
2. Sides/Top/Back: No obstructions should be placed in the areas shown by the dimensions below.
3. Bottom: Place on the level surface. Maintain an adequate air path for ventilation by placing on a stand with a height of 10 cm or more.

Front view

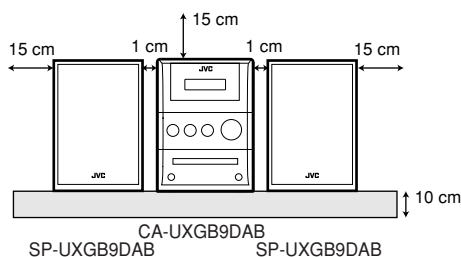

Side view

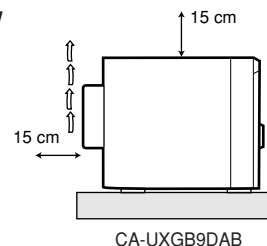

Information for Users on Disposal of Old Equipment

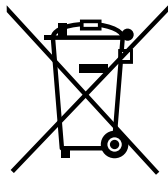

Attention:

This symbol is only valid in the European Union.

[European Union]

This symbol indicates that the electrical and electronic equipment should not be disposed as general household waste at its end-of-life. Instead, the product should be handed over to the applicable collection point for the recycling of electrical and electronic equipment for proper treatment, recovery and recycling in accordance with your national legislation.

By disposing of this product correctly, you will help to conserve natural resources and will help prevent potential negative effects on the environment and human health which could otherwise be caused by inappropriate waste handling of this product. For more information about collection point and recycling of this product, please contact your local municipal office, your household waste disposal service or the shop where you purchased the product.

Penalties may be applicable for incorrect disposal of this waste, in accordance with national legislation.

(Business users)

If you wish to dispose of this product, please visit our web page www.jvc-europe.com to obtain information about the take-back of the product.

[Other Countries outside the European Union]

If you wish to dispose of this product, please do so in accordance with applicable national legislation or other rules in your country for the treatment of old electrical and electronic equipment.

Introduction

Precautions

Installation

- Install in a place which is level, dry and neither too hot nor too cold—between 5°C and 35°C.
- Install the System in a location with adequate ventilation to prevent internal heat buildup inside the System.



DO NOT install the System in a location near heat sources, or in a place subject to direct sunlight, excessive dust or vibration.

- Leave sufficient distance between the System and the TV.
- Keep the speakers away from the TV to avoid interference with the TV.

Power sources

- When unplugging the System from the wall outlet, always pull on the plug, not the AC power cord.



DO NOT handle the AC power cord with wet hands.

Moisture condensation

Moisture may condense on the lenses inside the System in the following cases:

- After starting to heat the room
- In a damp room
- If the System is brought directly from a cold to a warm place

Should this occur, the System may malfunction. In this case, leave the System turned on for a few hours until the moisture evaporates, unplug the AC power cord, then plug it in again.

Others

- Should any metallic object or liquid fall into the System, unplug the AC power cord and consult your dealer before operating any further.



DO NOT disassemble the System since there are no user serviceable parts inside.

- If you are not going to operate the System for an extended period of time, unplug the AC power cord from the wall outlet.

If anything goes wrong, unplug the AC power cord and consult your dealer.

How to Read This Manual

- Button and control operations are explained in the table below.
- Some related tips and notes are explained later in the sections “Learning More about This System” and “Troubleshooting,” but not in the same section explaining the operations (**INFO** indicates that the content has some information).

	Indicates that you press the button briefly .
	Indicates that you press the button briefly and repeatedly until an option you want is selected.
	Indicates that you press one of the buttons.
	Indicates that you press and hold the button for specified seconds. <ul style="list-style-type: none"> • The number inside the arrow indicates the period of press (in this example, 2 seconds). • If no number is inside the arrow, press and hold until the entire procedure is complete or until you get a result you want.
	Indicates that you turn the control toward the specified direction(s).

	Indicates that this operation is only possible using the remote control.
	Indicates that this operation is only possible using the buttons and controls on the main unit.

Contents

Introduction	1
Connections	3
Before Operating the System.....	6
Daily Operations—Playback	7
Listening to the Radio	8
Playing Back a Disc	8
Playing Back a Portable Audio Device.....	9
Daily Operations—Sound&Other Adjustments... 	10
Adjusting the Volume	10
Adjusting the Sound.....	10
Changing the Display Brightness.....	11
Adjusting the Audio Input Level	11
Setting the Clock.....	11
Turning Off the Power Automatically	11
Radio Data System Operations	12
Changing the Display Mode	12
Searching for a Program by PTY Codes.....	12
Switching Temporarily to a Program of Your Choice	
Automatically	13
Description of the PTY codes for Radio Data System.....	13
DAB Operations.....	14
Listening to a Service.....	14
Presetting Services	15
Changing the Display Mode	16
Searching for a Service by PTY Codes.....	16
Switching Temporarily to a Service of Your Choice	
Automatically	17
Description of the PTY codes for DAB.....	17
Advanced Disc Operations.....	18
Programming the Playing Order—Program Play	18
Playing at Random—Random Play	19
Playing Repeatedly—Repeat Play	19
Prohibiting Disc Ejection—Child Lock.....	19
Timer Operations	20
Setting the Timer.....	20
Timer Priority.....	21
Additional Information	22
Learning More about This System.....	22
Troubleshooting	23
Maintenance	23
Specifications	24
Parts Index.....	24

Connections

Supplied accessories

After unpacking, check to be sure that you have all the following items:

- DAB antenna (1)
- Remote control (1)
- FM antenna (1)
- Batteries (2)
- AM loop antenna (1)

If any item is missing, consult your dealer immediately.

Do not connect the AC power cord until all other connections have been made.

Rear view

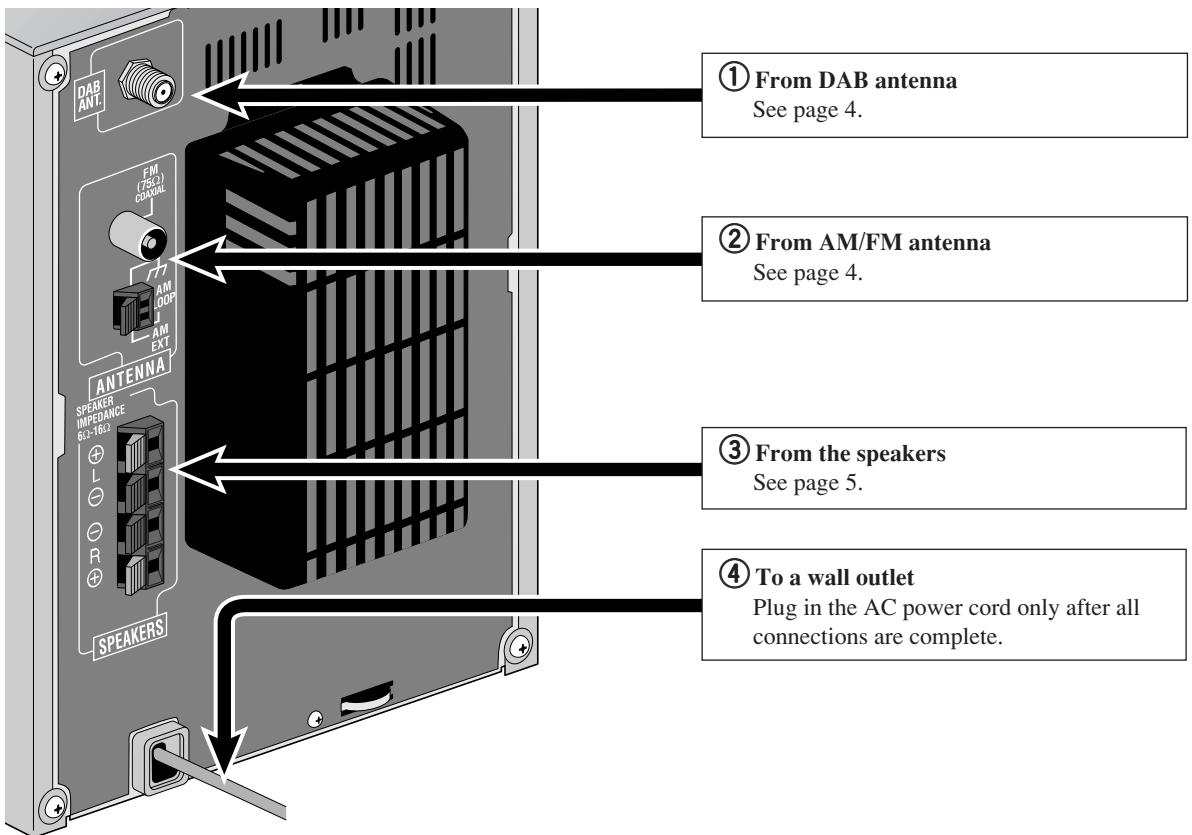

Front view



① DAB antenna

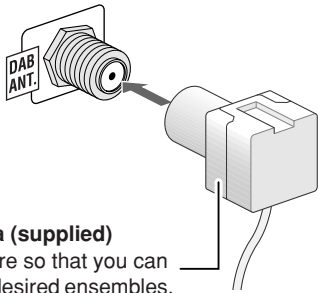

DAB antenna (supplied)
Extend the wire so that you can receive your desired ensembles.

For the better DAB reception

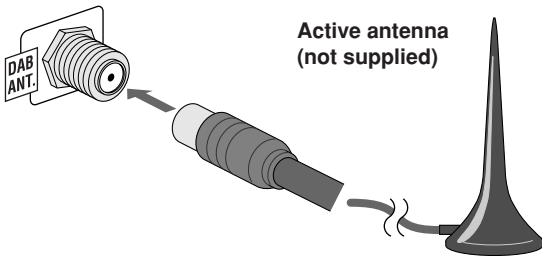

Active antenna (not supplied)

- See also “To improve DAB reception” on page 15.

② AM/FM antenna

To assemble the AM loop antenna

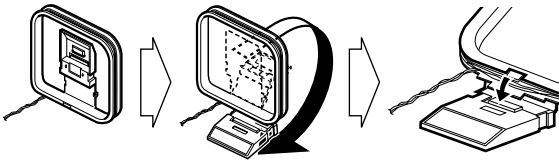

To connect the AM loop antenna

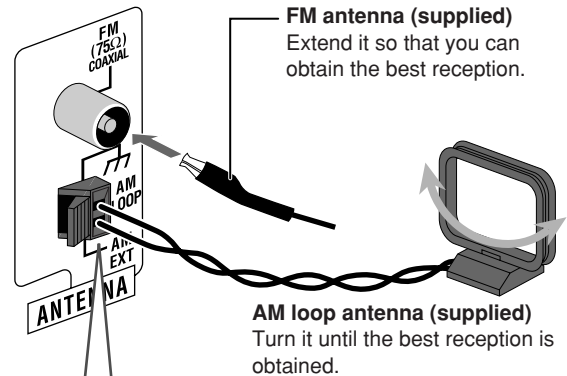

FM antenna (supplied)
Extend it so that you can obtain the best reception.

AM loop antenna (supplied)
Turn it until the best reception is obtained.

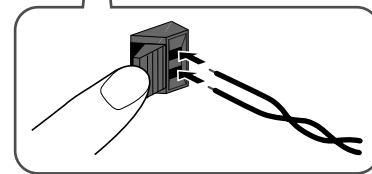

- If the AM loop antenna wire is covered with vinyl, remove the vinyl to expose the tip of the antenna by twisting the vinyl.

For the better AM/FM reception

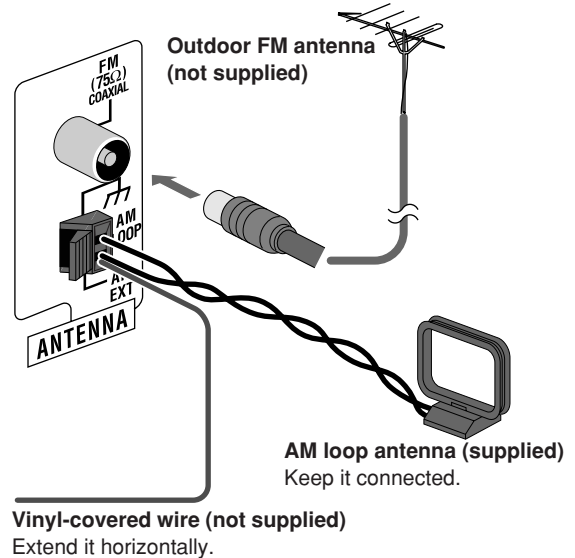

Outdoor FM antenna (not supplied)

AM loop antenna (supplied)
Keep it connected.

Vinyl-covered wire (not supplied)
Extend it horizontally.

- Disconnect the supplied FM antenna, and connect to an outdoor FM antenna using a 75 Ω wire with coaxial type connector (IEC or DIN45325).
- Make sure the antenna conductors do not touch any other terminals, connecting cords, or the power cord. Also, keep the antennas away from metallic parts of the System, connecting cords, and the AC power cord. This could cause poor reception.

③ Speakers

To connect the speaker cords

Make sure that both speakers are connected correctly and firmly.

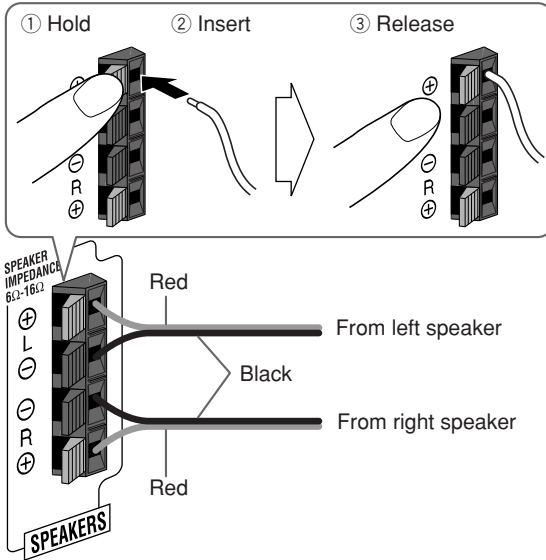

- When connecting the speaker cords, match the polarity of the speaker terminals: red cord to (+) and black cord to (-).
- If the speaker cords are covered with vinyl, remove the vinyl to expose the tip of the speaker cord by twisting the vinyl.



- DO NOT connect more than one speaker to each terminal.
- DO NOT allow the conductor of the speaker cords to be in touch with the metallic parts of the System.

To remove the speaker grilles:

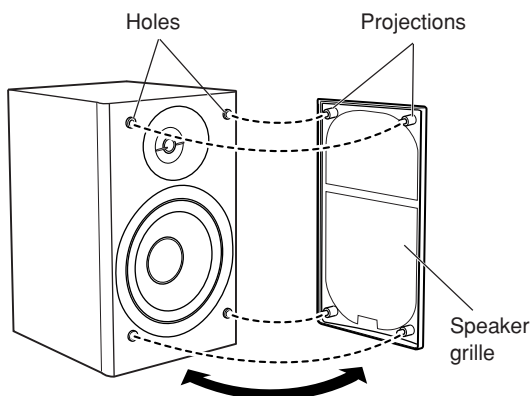

To connect a portable audio device

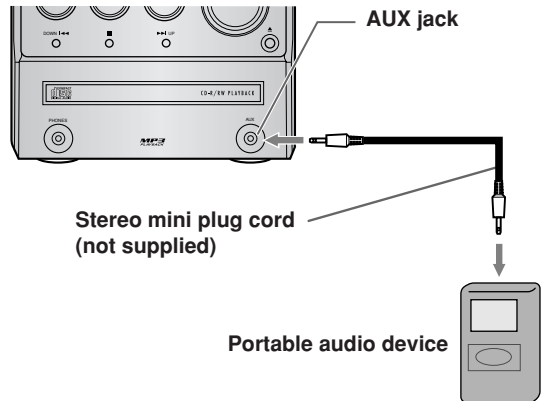

- By using QP Link (Quick Portable Link), you can easily start playing back a portable audio device on this unit. See page 9 for details.
- If an external device is not equipped with a stereo mini plug audio output, use a plug adapter to convert the stereo mini plug to the corresponding plug of the audio output.

Preparing the remote control

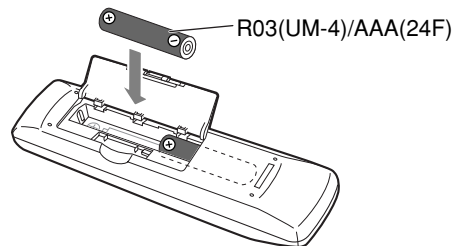

- Dispose of batteries in the proper manner, according to federal, state, and local regulations.



DO NOT recharge, short, disassemble, heat the battery or dispose of it in a fire.

When using the remote control

Point the top of the remote control toward the remote sensor as directly as possible. If you operate it from a diagonal position, the operating range (approx. 5 m) may be shorter.

Before Operating the System

The indications on the display tell you a lot of things while you are operating the System. Before operating the System, be familiar with when and how the indicator illuminates on the display.

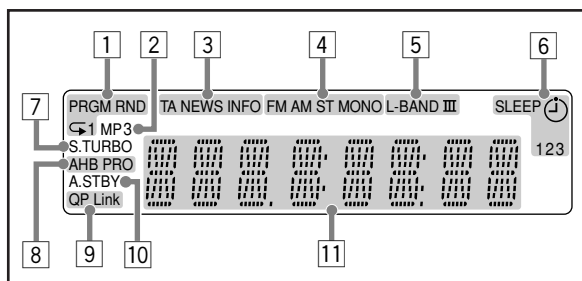

Indications on the main display

- While listening to radio:
- While selecting AUX:

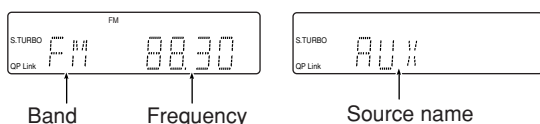

- While listening to DAB:

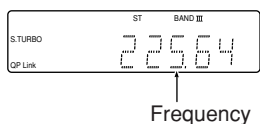

- While playing a CD/MP3*:

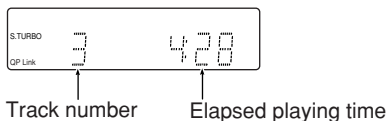

- While disc play is stopped:

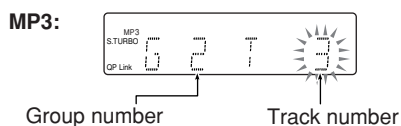
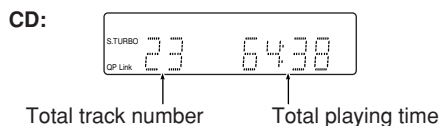

* When you start or stop playing an MP3 disc, the group (folder) number, group (folder) name, track (file) number, track (file) name (and ID3 Tag) will be shown before the elapsed playing time appears.

- Disc operation indicators
 - PRGM (Program Play): lights when Program Play mode is activated.
 - RND (Random Play): lights when Random Play mode is activated.
 - Repeat Play:
 - 1: lights when One Track Repeat is activated.
 - : lights when All Track Repeat or One Group Repeat is activated.
- MP3 indicator
 - Lights when an MP3 track is detected.
- TA/NEWS/INFO—Program type (PTY) indicators
 - Lights to indicate the currently selected program type for PTY Standby Reception.
 - Flashes when a program is automatically tuned in with PTY Standby Reception.
- Radio reception indicators
 - FM: lights while receiving an FM stereo station.
 - ST (stereo): lights while an FM stereo station or a DAB service with sufficient signal strength is tuned in.
 - MONO: lights while receiving an FM stereo station in monaural.
 - AM: lights while receiving an AM station.
- DAB reception indicators
 - L-BAND: lights while receiving a DAB ensemble in L-Band.
 - BAND III: lights while receiving a DAB ensemble in Band III.
- Timer indicators
 - : lights when Daily Timer is on standby; flashes while working or being set.
 - 1/2/3: lights when a Daily Timer (1, 2, or 3) is on standby; flashes while working or being set.
 - SLEEP: lights when Sleep Timer is activated.
- S.TURBO (Sound Turbo) indicator
 - Lights when Sound Turbo is activated.
- AHB PRO (Active Hyper Bass Pro) indicator
 - Lights when AHB Pro is activated.
- QP Link (Quick Portable Link) indicator
 - Lights when QP Link is activated.
- A.STBY (Auto Standby) indicator
 - Lights when Auto Standby is activated.
 - Flashes for about 3 minutes before Auto Standby turns the System off.
- Main display

Daily Operations—Playback

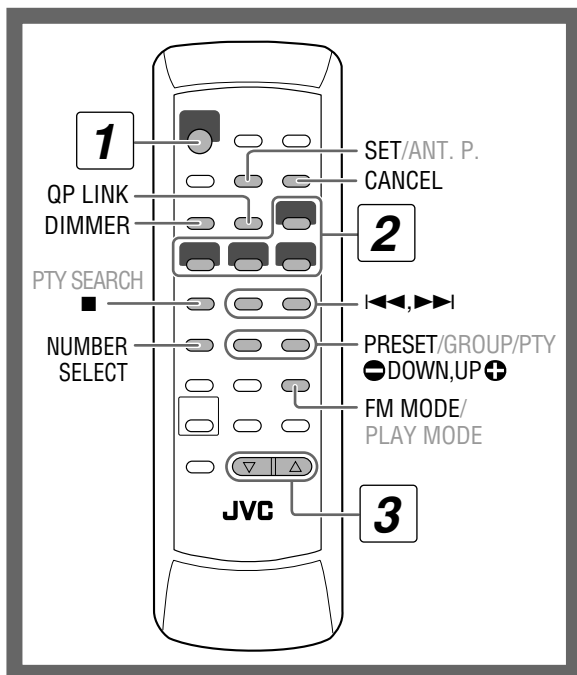

In this manual, the operations using the remote control are explained mainly; however, you can use the buttons and controls on the main unit if they have the same (or similar) name and symbol.

1 Turn on the power.

The STANDBY lamp on the main unit turns off.

Without pressing STANDBY/ON /I...

- The System turns on by pressing one of the source buttons.
- The System turns on and activates the AUX source by starting playback on an external device when QP Link is activated. (See page 9 for details.)

2 Select the source.

Playback automatically starts if the selected source is ready.

3 Adjust the volume.

4 Operate the target source as explained later.

To turn off (standby) the unit



The STANDBY lamp on the main unit lights in red.

- A small amount of power is always consumed even while on standby.

You can reduce power consumption by pressing DIMMER to turn the display off while on standby.

- When the display is turned off, QP Link does not work.

For private listening

Connect a pair of headphones to the PHONES jack on the main unit. The sound will no longer come out of the speakers. **Be sure to turn down the volume before connecting or putting on the headphones.**

- Disconnecting the headphones will activate the speakers again.



DO NOT turn off (standby) the System with the volume set to an extremely high level; otherwise, the sudden blast of sound can damage your hearing, speakers and/or headphones when you turn on the System or start playback.

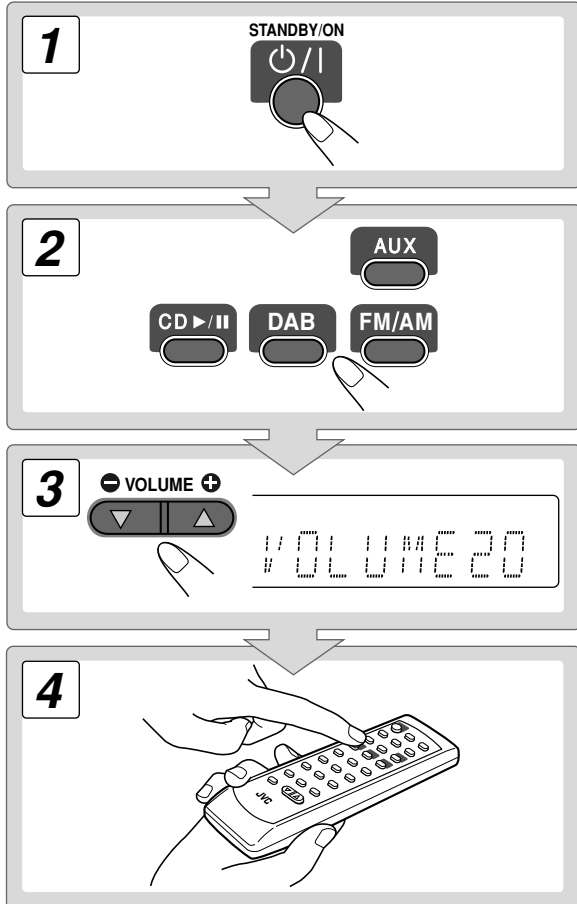

Listening to the Radio **INFO**

- For DAB operations, see page 14.

To select the band (FM or AM)

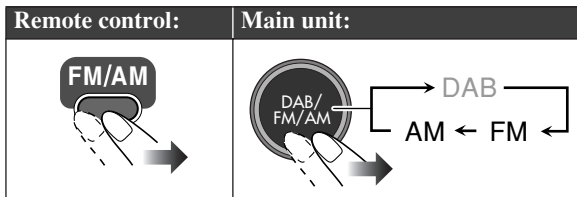

To tune in to a station

While FM or AM is selected...

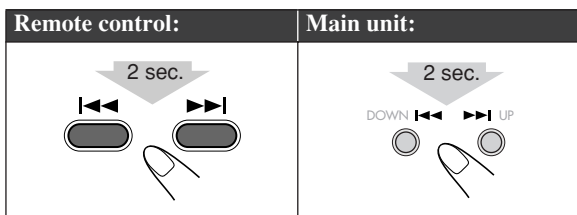

Frequency starts changing on the display.

When a station (frequency) with sufficient signal strength is tuned in, the frequency stops changing.

- When you repeatedly press the button, the frequency changes step by step.

To stop searching manually, press or .

If the FM station has poor reception **Remote ONLY**

**FM MODE/
PLAY MODE**



The MONO indicator lights on the display. Reception will improve though stereo effect is lost—Monaural reception mode.

To restore the stereo effect, press the button again (the MONO indicator disappears).

To preset the stations **Remote ONLY**

You can preset 30 FM and 15 AM stations.

1 Tune in to a station you want to preset.

- You can also store the monaural reception mode for FM preset stations if selected (see above).

2 Activate the preset number entry mode.

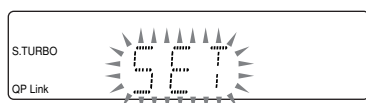

- Finish the following process while the indication on the display is flashing.

3 Select a preset number for the station you store.

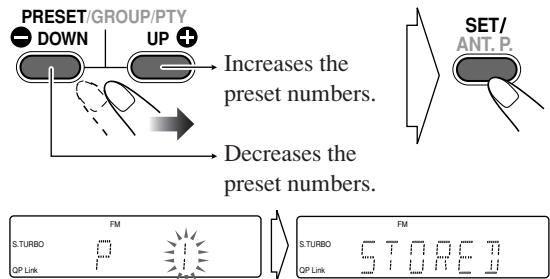

To tune in to a preset station **Remote ONLY**

After selecting the band, select the preset number for the preset station.

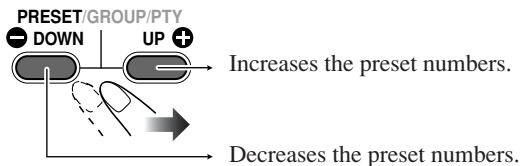

Playing Back a Disc **INFO**

This System can play back the following discs—regular CD and CD-R/CD-RW (recorded either in the audio CD or MP3 format).

To insert a disc

You can insert a disc while playing another source.

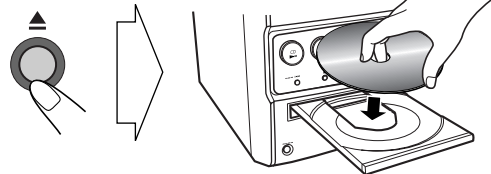

To close the disc tray, press again.

- If you press CD /II, disc tray closes automatically and playback starts.

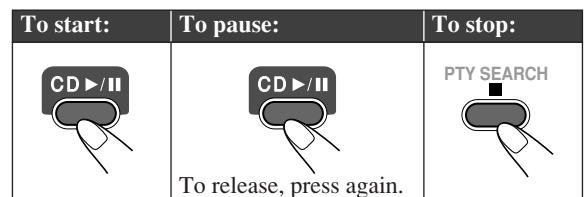

To select a track

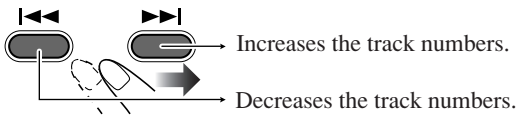

To select a group (MP3 only)

1 While disc play is stopped, activate the group select mode.

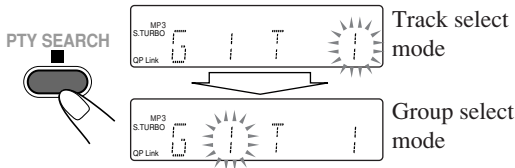

2 Select a group number.

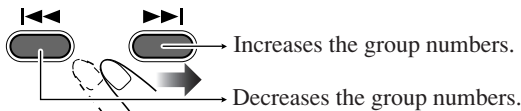

Group number and group name appear.

To locate a particular portion

While playing a disc, press and hold until the portion you want is reached.

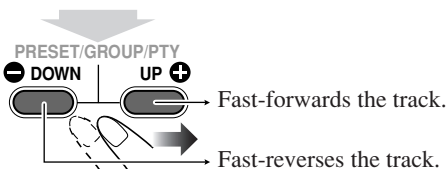

To locate a track directly

1 Activate the track number entry mode.

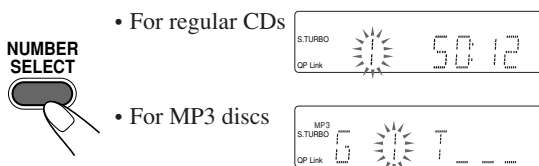

2 Enter a track number you want to play back.

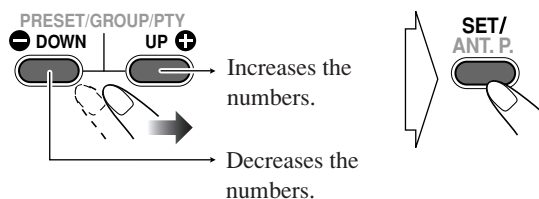

To select track numbers on an MP3 disc, enter the number in three digits. Refer to the following examples: When selecting track 24...

- ① Press SET to skip the first digit.
- ② Select "2" for the second digit pressing UP or DOWN button repeatedly, then press SET.
- ③ Select "4" for the last digit pressing UP or DOWN button repeatedly, then press SET or CD ►/■.

If you enter a track number that does not exist on the MP3 disc...

- During playback, your entry will be ignored and playback will continue with the current track.
- While playback is stopped, disc playback will remain at the first track in the first group until you press CD ►/■, then playback will start.

- To go back a step, press CANCEL.

Playing Back a Portable Audio Device



By using QP Link (Quick Portable Link), you can easily start playing back a portable audio device connected to the AUX jack.

- Make sure to set the volume of your portable audio device loud enough so that the System can detect the sound signal.

To activate QP Link

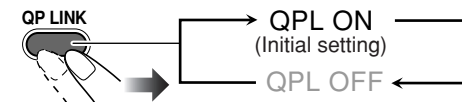

When QP Link is activated, connecting a portable device to the AUX jack and starting playback performs the following:

- While listening to another source...
 - Changes the source to AUX automatically. (If you change from AUX to another source, QP Link will be canceled.)
- While the System is on standby...
 - Turns on the System and activates the AUX source automatically (except when the display is turned off).

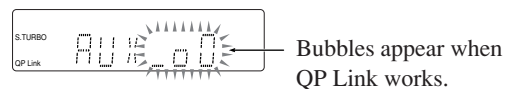

While QP Link plays back the device...

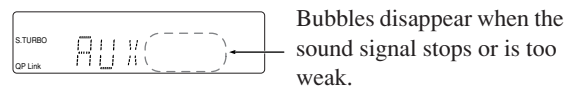

Daily Operations—Sound&Other Adjustments

Remote control

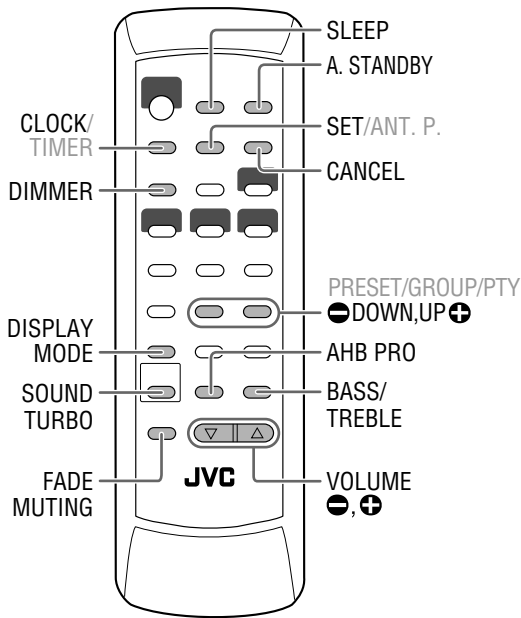

Main unit

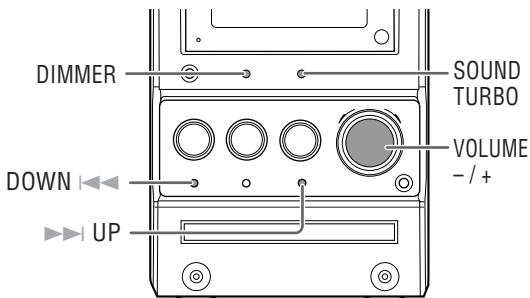

To drop the volume in a moment 



To restore the volume, press again, or adjust the volume level.

Adjusting the Sound

To emphasize the sound—Sound Turbo

This function emphasizes the sound.

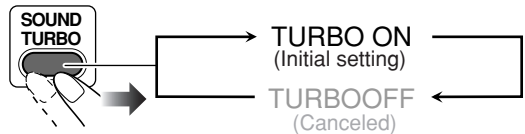

To reinforce the bass sound—AHB Pro



You can reinforce the bass sound to maintain rich, full bass at low volume—Active Hyper Bass Pro.

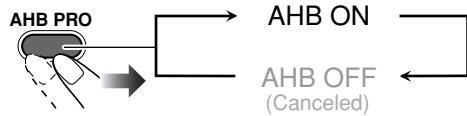

- You can activate AHB Pro only while Sound Turbo is canceled.

To adjust the tone—Bass/Treble

You can adjust the bass and treble level from -3 to +3.

To adjust the bass

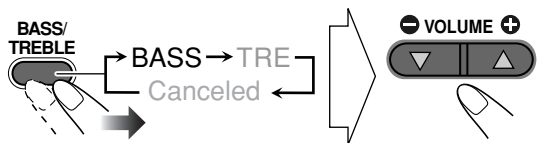

To adjust the treble

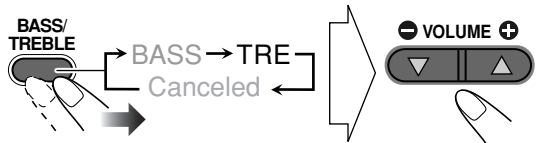

Adjusting the Volume

The volume level can be adjusted between “VOL MIN” and “VOLUME 1” – “VOLUME 40 (VOL MAX).”

Remote control:



Main unit:

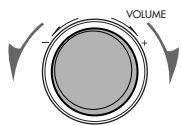

Changing the Display Brightness

You can dim the display window.



DIM 1	Dims the display and the illumination on the main unit.
DIM 2	Dims the display more than DIM 1 and turns off the illumination on the main unit.

Adjusting the Audio Input Level

Remote ONLY

If the sound from a component connected to the AUX jack is too loud or is too quiet, you can change the audio input level through the AUX jack (without changing the volume level). While AUX is selected as a source...

2 sec.

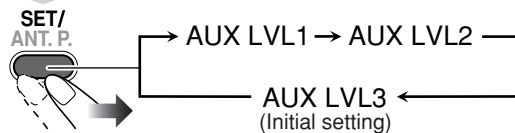

AUX LVL 1	Select this when the sound is too loud.
AUX LVL 2	AUX Level 2 is preset at the intermediate level between Level 1 and 3.
AUX LVL 3	Select this when the sound is too quiet.

Setting the Clock

Remote ONLY

INFO

Without setting the built-in clock, you cannot use Daily Timers (see page 20) or Sleep Timer.

- To exit from the clock setting, press CLOCK as required.
- To go back a step, press CANCEL.

1 Activate the clock setting mode.

CLOCK/TIMER



- If you have already adjusted the clock before, press the button repeatedly until the clock setting mode is selected.

2 Adjust the hour, then the minute.

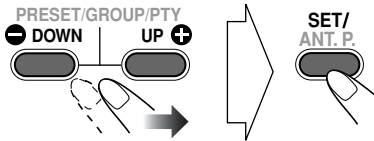

Now the built-in clock starts working.

To check the current time during play

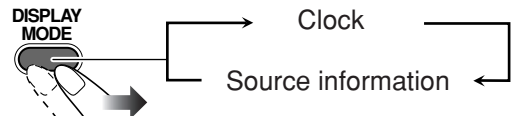

- For the display modes of Radio Data System, see page 12.
- For the display modes of DAB, see page 16.

Turning Off the Power Automatically

Remote ONLY

Auto Standby

2 sec.



When Auto Standby is in use, the A.STBY indicator lights on the display.

The A.STBY indicator starts flashing:

- When disc playback stops
- When the sound signal from the AUX jack stops or is too weak

The System will turn off (on standby) automatically if no operation is done for about 3 minutes while the indicator is flashing.

Sleep Timer

You can set the unit to turn off after a certain period of time.

1 Specify the time (in minutes).

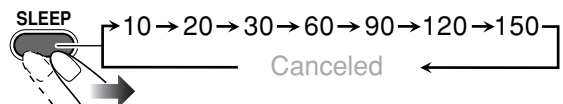

2 Wait until the set time disappears.

To check the time remaining until the shut-off time

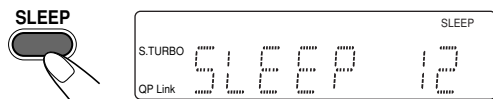

- If you press the button repeatedly, you can change the shut-off time.

Radio Data System Operations INFO

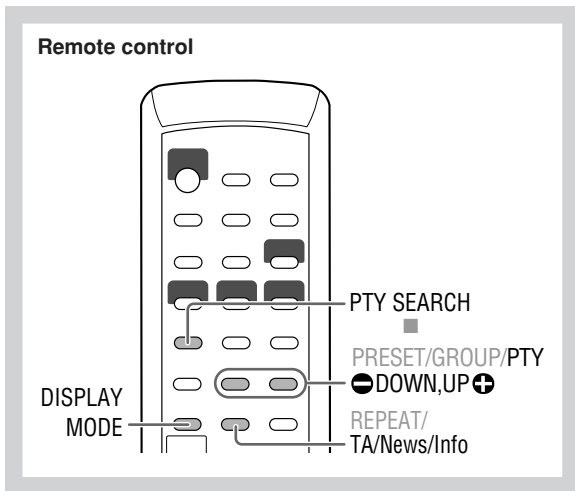

Searching for a Program by PTY Codes

You can locate a particular kind of program from the preset channels (see page 8) by specifying the PTY codes.

To search for a program using the PTY codes

1 While listening to an FM station...

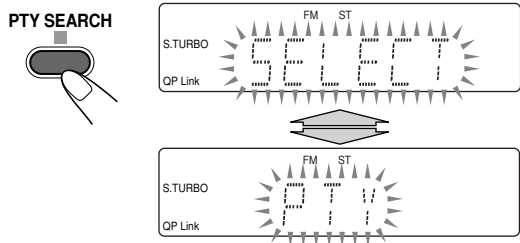

2 Select a PTY code.

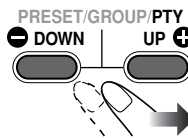

- For details about each PTY code, see page 13.

3 Start searching.

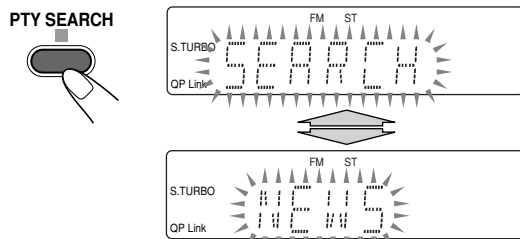

Ex. When "NEWS" is selected

The receiver searches 30 preset FM stations, stops when it finds the one you have selected, and tunes in to that station.

- If no program is found, "NOTFOUND" appears on the display.
- To stop searching any time during search, press PTY SEARCH.

To continue searching after it stops on an unwanted station

While the indications on the display are flashing...



Receiving FM stations with Radio Data System

Radio Data System allows FM stations to send an additional signal along with their regular program signals. This System can receive the following types of Radio Data System signals.

PS (Program Service)	Shows commonly known station names.
PTY (Program Type)	Shows types of broadcast programs.
RT (Radio Text)	Shows text messages the station sends.
Enhanced Other Networks	Provides the information about the types of the programs broadcast by the Radio Data System stations of the different networks.

Changing the Display Mode

While listening to an FM station...

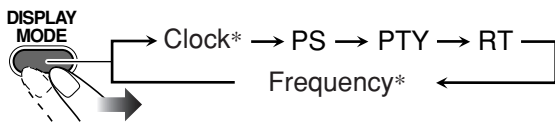

PS	Station names are displayed. "NO PS" will appear if no signal is sent.
PTY	The broadcast program type is displayed. "NO PTY" will appear if no signal is sent.
RT	Text messages the station sends are displayed. "NO RT" will appear if no signal is sent.

* Non Radio Data System signal.

Switching Temporarily to a Program of Your Choice Automatically



The Enhanced Other Networks function allows the System to switch temporarily to a preset FM station broadcasting a program of your choice (TA, NEWS, or INFO).

- This function works while listening to an FM station providing the required signals.

While listening to an FM station, select the program type.

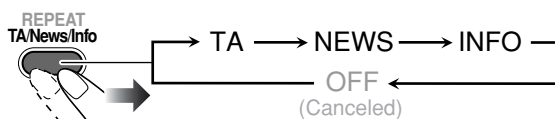

TA	Traffic announcement in your area
NEWS	See the right column.
INFO	

How the Enhanced Other Networks function works:

CASE 1

If a station is not broadcasting the program of your choice

The System continues tuning in to the current station.

When a station starts broadcasting the program of your choice, the System automatically switches to that station. The PTY code indicator starts flashing.

When the program is over, the System goes back to the previously tuned station, but the function still remains active (the indicator stops flashing and remains lit).

CASE 2

If a station is broadcasting the program of your choice

The System automatically switches to the station. The PTY code indicator starts flashing.

When the program is over, the System goes back to the previously tuned station, but the function still remains active (the indicator stops flashing and remains lit).

CASE 3

If the station currently tuned in is broadcasting the program of your choice

The PTY code indicator starts flashing.

When the program is over, the indicator stops flashing (the function still remains active).

Description of the PTY codes for Radio Data System

NEWS:	News.
AFFAIRS:	Topical program expanding or enlarging upon the news—debate, or analysis.
INFO:	Programs the purpose of which is to impart advice in the widest sense.
SPORT:	Programs concerned with any aspect of sports.
EDUCATE:	Educational programs.
DRAMA:	All radio plays and serials.
CULTURE:	Programs concerning any aspect of national or regional culture, including language, theater, etc.
SCIENCE:	Programs about natural sciences and technology.
VARIED:	Used for mainly speech-based programs such as quizzes, panel games and personality interviews.
POP M:	Commercial music of current popular appeal.
ROCK M:	Rock music.
EASY M:	Current contemporary music considered to be "easy-listening".
LIGHT M:	Instrumental music, and vocal or choral works.
CLASSICS:	Performances of major orchestral works, symphonies, chamber music, etc.
OTHER M:	Music not fitting into any of the other categories.
WEATHER:	Weather reports and forecasts.
FINANCE:	Stock Market reports, commerce, trading etc.
CHILDREN:	Programs targeted at a young audience.
SOCIAL:	Programs about sociology, history, geography, psychology and society.
RELIGION:	Religious programs.
PHONE IN:	Involving members of the public expressing their views either by phone or at a public forum.
TRAVEL:	Travel information.
LEISURE:	Programs about recreational activities.
JAZZ:	Jazz music.
COUNTRY:	Songs which originate from, or continue the musical tradition of the American Southern States.
NATION M:	Current popular music of the nation or region in that country's language.
OLDIES:	Music from the so-called "golden age" of popular music.
FOLK M:	Music which has its roots in the musical culture of a particular nation.
DOCUMENT:	Programs concerning factual matters, presented in an investigative style.
TEST:	Broadcasts for testing emergency broadcast equipment or unit.
ALARM:	Emergency announcement.
NONE:	No program type, undefined program, or difficult to categorize into particular types.

- Classification of the PTY codes for some FM stations may be different from the above list.

DAB Operations

Remote control

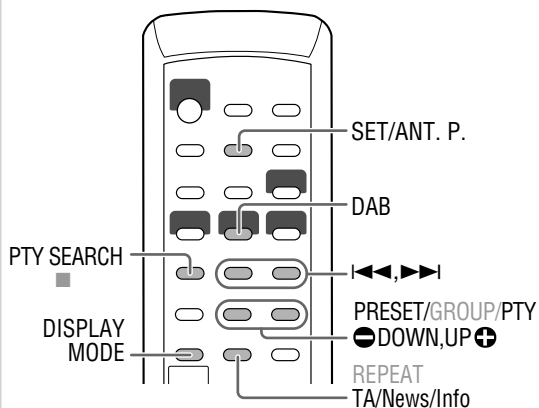

Main unit

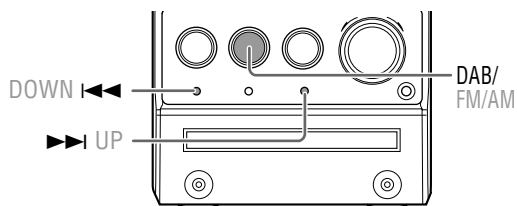

What is DAB system?

DAB (Digital Audio Broadcasting) is one of the digital radio broadcasting systems available today. It can deliver digital quality sound without any annoying interference or signal distortion. Furthermore, it can carry text, pictures and data. In contrast to FM broadcast, where each program is transmitted on its own frequency, DAB combines several programs (called "services") to form one "ensemble." "Primary services" (main radio stations) are sometimes accompanied by "secondary services" to broadcast additional programs.

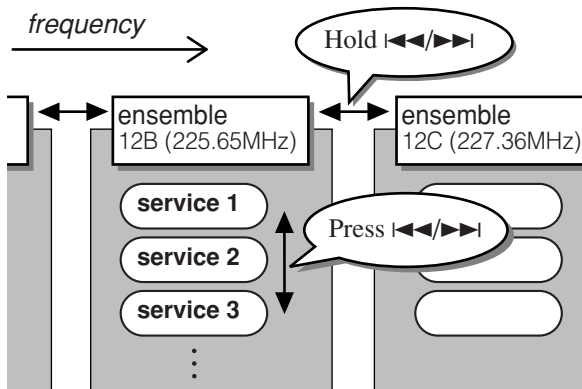

Caution:

Electrostatic discharge from your body may cause noise from the speakers and you cannot hear the broadcast. If this happens, turn off the System (on standby), then turn it on again.

Listening to a Service

1 Select DAB.

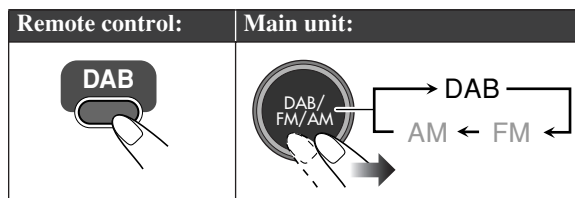

- When you change the source to DAB for the first time after plugging in the AC power cord, the System automatically scans the DAB bands for available ensembles (see the next page).

2 Select an ensemble.

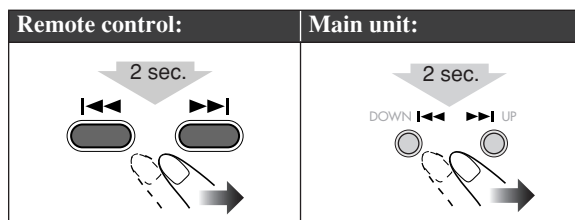

You can choose from the ensembles found by the ensemble scanning.

To choose from all the ensembles, see "To tune in to all the ensembles" on the next page.

3 Select a service (either primary or secondary) you want to listen to.

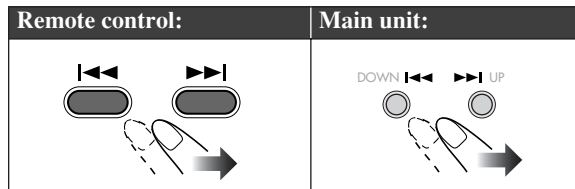

Ex.

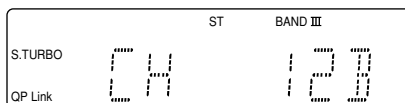

- When the signal is strong enough, the ST indicator lights on the display.

To scan for ensembles

With the ensemble scanning function, the System scans the DAB bands to pick out available ensembles under your receiving condition.

- When you change the source to DAB for the first time after plugging in the AC power cord, the System automatically performs the scanning.

To perform the ensemble scanning manually

When you moved your System or adjusted the antenna position, perform the scanning manually.



When the scanning is complete, the System starts playing the first service of the lowest-frequency ensemble found.

To tune in to all the ensembles

You can tune in to every ensemble regardless of the signal status.

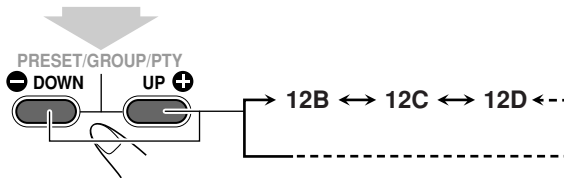

The frequency changes every second, going through all the DAB ensembles.

Press and hold the button until the desired ensemble is reached.

To improve DAB reception

With the supplied DAB antenna, you may not be able to receive L-Band ensembles depending on your reception condition. You can improve the reception of both L-Band and Band III ensembles by connecting an active antenna (see page 4) and supplying electricity to the antenna.

While on standby (Display ON)...

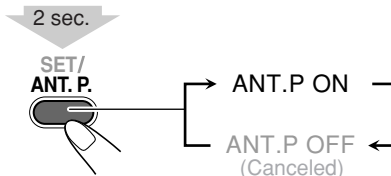

Presetting Services

You can preset 30 services in memory.

- 1 Tune in to an ensemble, then select a service you want to preset.
- 2 Activate the preset number entry mode.

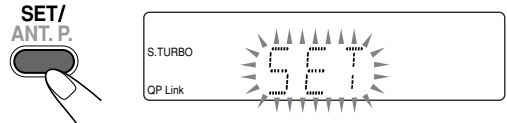

- 3 Select a preset number for the service you store.

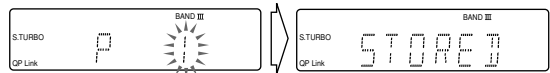
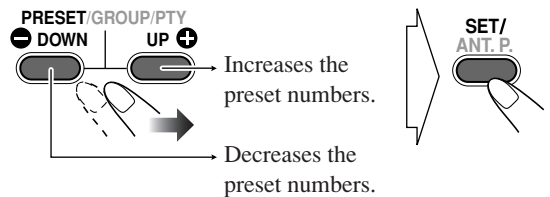

- You can only preset primary services. If you select a secondary service to store, its primary service is stored instead.

To tune in to a preset service

After selecting DAB as the source, select the preset number for the preset station.

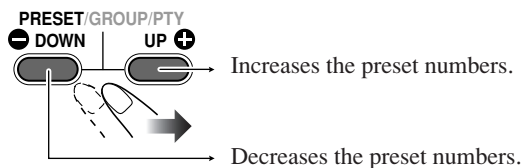

Changing the Display Mode Remote ONLY >>> INFO

While listening to a DAB service...

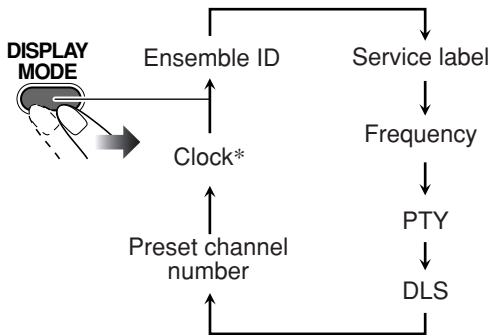

Service label	“NOSIGNAL” will appear if no signal is sent.
PTY	The broadcast program type is displayed. “NONE” will appear if no signal is sent.
DLS	Dynamic Label Segment (text messages the station sends) is displayed. “NO TEXT” will appear if no signal is sent.

* Non DAB signal.

Searching for a Service by PTY Codes Remote ONLY >>>

You can locate a particular kind of program from among all the services you can receive by specifying PTY codes.

1 While listening to a DAB service...

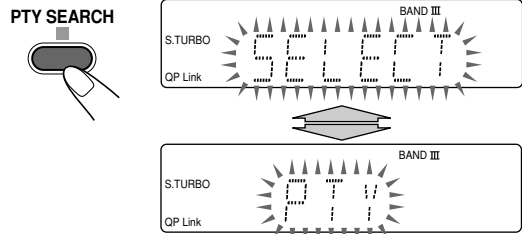

2 Select a PTY code.

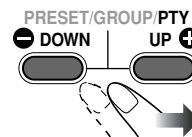

• For details about each PTY code, see page 17.

3 Start searching.

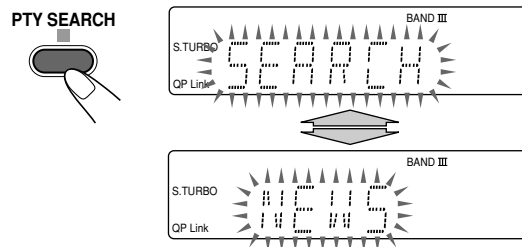

Ex. When “NEWS” is selected

The receiver searches all the available ensembles, stops when it finds a program of the selected PTY code, and switches to that service.

- If no program is found, “NOTFOUND” appears on the display.
- To stop searching any time during search, press CANCEL.

To continue searching after it stops on an unwanted service

While the PTY code is flashing on the display for 10 seconds, press PTY SEARCH again.

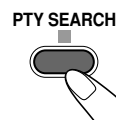

Switching Temporarily to a Service of Your Choice Automatically



PTY Standby Reception function allows the System to switch temporarily to a DAB service broadcasting a program of your choice (TA, NEWS, or INFO).

- This function works while listening to a service providing the required signals.
- PTY Standby Reception works using both Dynamic PTY and Static PTY.

While listening to a DAB service, select the program type.

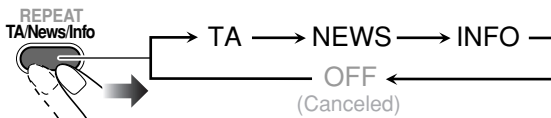

TA	Traffic announcement in your area
NEWS	See the right column.
INFO	

How PTY Standby Reception function works:

It works in the same way as the Enhanced Other Networks function. See page 13.

Description of the PTY codes for DAB

NEWS:	News.
AFFAIRS:	Topical program expanding or enlarging upon the news—debate, or analysis.
INFO:	Programs the purpose of which is to impart advice in the widest sense.
SPORT:	Programs concerned with any aspect of sports.
EDUCATE:	Educational programs.
DRAMA:	All radio plays and serials.
ARTS:	Programs concerning any aspect of national or regional culture, including language, theater, etc.
SCIENCE:	Programs about natural sciences and technology.
TALK:	Used for mainly speech-based programs such as quizzes, panel games and personality interviews.
POP M:	Commercial music of current popular appeal.
ROCK M:	Rock music.
EASY M:	Current contemporary music considered to be “easy-listening”.
CLASSICL:	Instrumental music, and vocal or choral works.
CLASSICM:	Performances of major orchestral works, symphonies, chamber music, etc.
OTHER M:	Music not fitting into any of the other categories.
WEATHER:	Weather reports and forecasts.
FINANCE:	Stock Market reports, commerce, trading etc.
CHILDREN:	Programs targeted at a young audience.
FACTUAL:	Programs about sociology, history, geography, psychology and society.
RELIGION:	Religious programs.
PHONE IN:	Involving members of the public expressing their views either by phone or at a public forum.
TRAVEL:	Travel information.
LEISURE:	Programs about recreational activities.
JAZZ:	Jazz music.
COUNTRY:	Songs which originate from, or continue the musical tradition of the American Southern States.
NATION M:	Current popular music of the nation or region in that country’s language.
OLDIES:	Music from the so-called “golden age” of popular music.
FOLK M:	Music which has its roots in the musical culture of a particular nation.
DOCUMENT:	Programs concerning factual matters, presented in an investigative style.

Advanced Disc Operations

Remote control

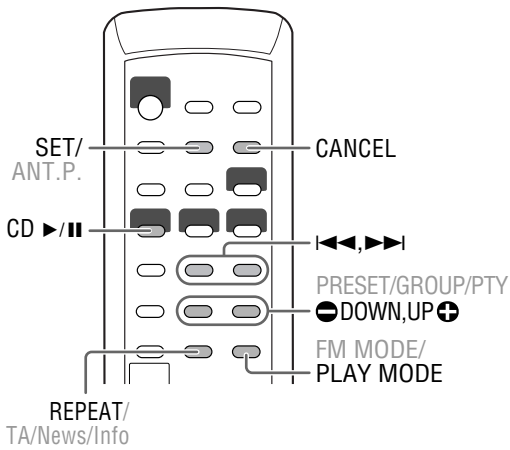

Main unit

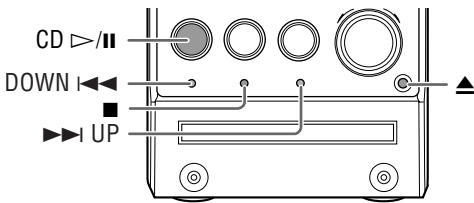

2 Select track numbers you want for Program Play.

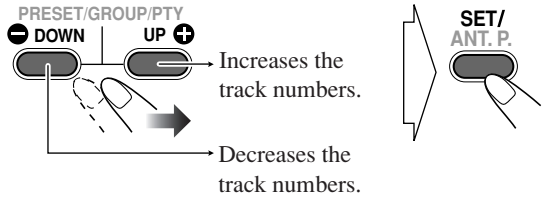

• For regular CDs

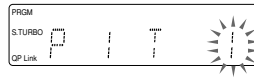

• For MP3 discs



To select track numbers on an MP3 disc, enter the number in three digits. Refer to the following examples:
When selecting track 24...

- ① Press SET to skip the first digit.
- ② Select "2" for the second digit pressing UP or DOWN button repeatedly, then press SET.
- ③ Select "4" for the last digit pressing UP or DOWN button repeatedly, then press SET.

3 Start playback.



The tracks you have selected are played back in the order you have programmed.

Programming the Playing Order

Program Play



You can arrange the playing order of the tracks (up to 99) before you start playback.

1 Before starting playback, activate Program Play.

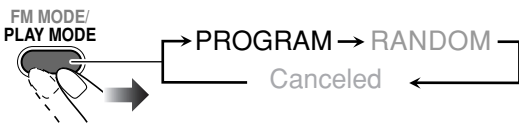

To check the programmed contents

Before playback or while playback is stopped...

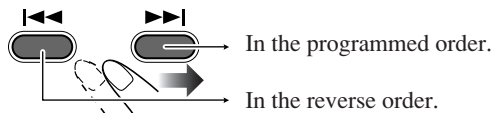

To modify the program

Before playback or while playback is stopped...

To erase the last track:	To erase the entire program:
To add tracks in the program:	
Repeat step 2.	

To exit from Program Play

Before playback or while playback is stopped...

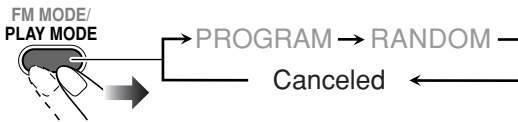

- Exiting from Program Play erases the stored program.

Playing at Random—Random Play

You can play all tracks at random.

1 Before starting playback, activate Random Play.

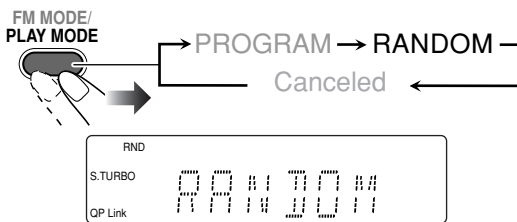

2 Start playback.



Playback starts in random order.
Random Play ends when all tracks have been played.

To exit from Random Play

Before playback or while playback is stopped...



Playing Repeatedly—Repeat Play

You can repeat playback.

While a regular CD is loaded...

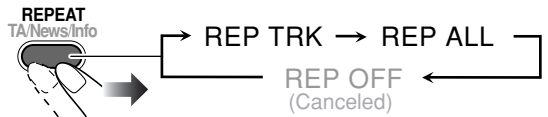

While an MP3 disc is loaded...

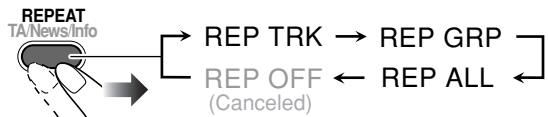

REP TRK	Repeats the current (or specified) track—One Track Repeat.
REP ALL	Repeats the disc or all programmed tracks—All Track Repeat.
REP GRP	Repeats the current group—One Group Repeat (MP3 only).

Prohibiting Disc Ejection—Child Lock

You can lock the disc tray so that no one can eject the loaded disc.

- This is possible while the System is on standby.

While on standby...

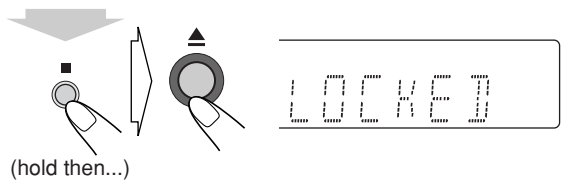

To cancel the prohibition, repeat the same procedure.
“UNLOCKED” appears on the display.

Timer Operations INFO

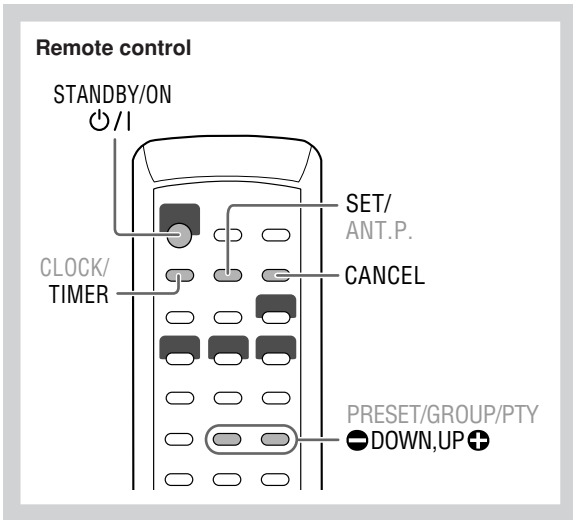

Setting the Timer

Using Daily Timer, you can wake up with your favorite music.

- You can store three Daily Timer settings; however, you can activate only one timer at a time.
- To exit from the timer setting, press TIMER as required.
- To correct a misentry during the process, press CANCEL.
- You can return to the previous step.

Daily Timer initial settings when shipped from the factory

- Daily 1: ON Time (6:00)/Source (TUNER)/ Volume level (8)
- Daily 2: ON Time (7:00)/Source (TUNER)/ Volume level (8)
- Daily 3: ON Time (10:00)/Source (TUNER)/ Volume level (8)

- 1 Select one of the timer setting modes you want to set— Daily 1 ON time, Daily 2 ON time, or Daily 3 ON time.

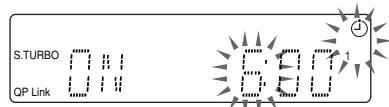
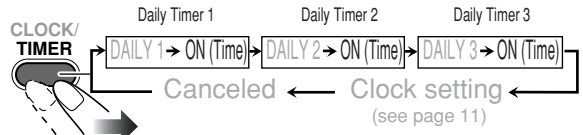

Ex. When Daily Timer 1 setting mode is selected

- When the clock has not been adjusted, pressing TIMER makes the System enter the clock setting mode.

- 2 Make the Daily timer setting as you want.

- 1 Set the hour then the minute for on-time.

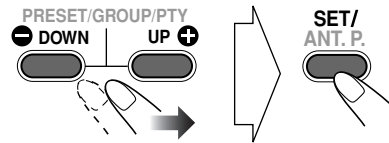

- 2 Select the playback source—“TUNER,” “CD,” “DAB,” or “AUX.”

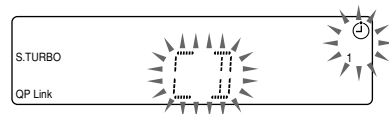
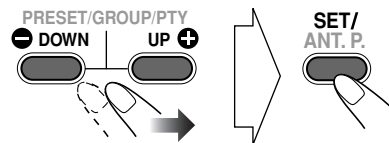

- 3 Select the volume level.

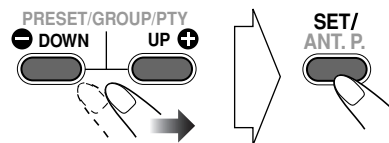

- You can select the volume level (“VOLUME 1” to “VOLUME 40” and “VOLUME --”). If you select “VOLUME --,” the volume is set to the last level when the unit has been turned off.

Continued on the next page...

3 Turn off the unit (on standby).



How Daily Timer works

Once the Daily Timer has been set, the timer indicator (⊕) and timer number indicator (1/2/3) are lit on the display. Daily Timer is activated at the same time everyday until the timer is turned off manually (see the next column) or another Daily Timer is activated.

When the on-time comes

The System turns on, tunes in to the last received station/ service or start playing the loaded disc, and increases the volume level gradually to the preset level.

About one hour after playback starts, the System stops playback, and turns off (standby) automatically.

- The timer setting remains in memory until you change it.
- Without canceling the Daily Timer, you can change the source or adjust the volume after Daily Timer starts playback.

To turn off the Timer after its setting is done

Since Daily Timer is activated at the same time everyday, you may need to cancel it on some particular days.

1 Select the Timer you want to cancel.

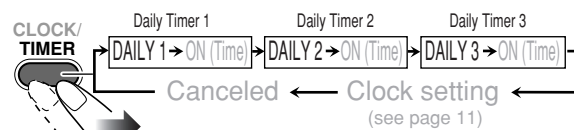

Ex. When Daily Timer 1

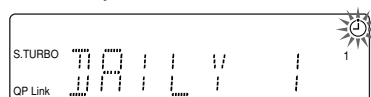

2 Turn off the selected Timer.

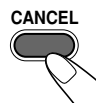

To turn on the Timer again, repeat step 1 above and press in step 2...



Timer Priority

If you set the Sleep Timer after Daily Timer starts playing the selected source, Daily Timer is canceled.

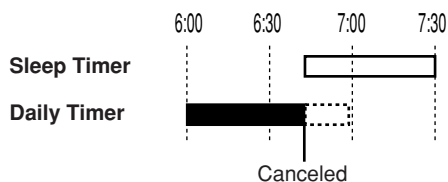

Additional Information

Learning More about This System ● ● ●

Daily Operations—Playback (see pages 7 to 9)

Listening to the Radio:

- If you store a new station into an occupied preset number, the previously stored station in that number will be erased.
- When you unplug the AC power cord or if a power failure occurs, the preset stations will be erased in a few days. If this happens, preset the stations again.

Playing Back a Disc:

- When using an 8 cm disc, place it on the inner circle of the disc tray.
- This System cannot play “packet write” discs.
- For MP3 playback...
 - MP3 discs require a longer readout time than regular CDs. (It depends on the complexity of the group/file configuration.)
 - Some MP3 files cannot be played back and will be skipped. This results from their recording processes and conditions.
 - When making MP3 discs, use ISO 9660 Level 1 or Level 2 for the disc format.
 - This System can play back MP3 files with the extension code <.mp3> (regardless of the letter case—upper/lower).
 - It is recommended that you make each MP3 file at a sampling rate of 44.1 kHz and at a bit rate of 128 kbps. This System cannot play back files made at a bit rate of less than 64 kbps.
 - Playback order of MP3 tracks may be different from what you have intended when recording (see below). If a folder does not include MP3 tracks, they are ignored.
 - This System plays back MP3 tracks as follows.

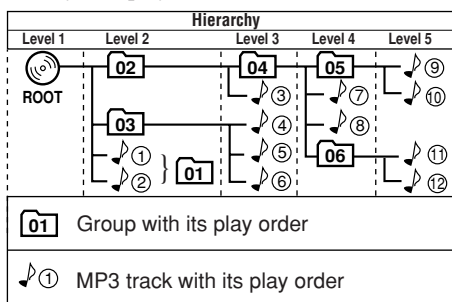

- This System can recognize up to 999 tracks in a disc. Also, the System can recognize up to 256 tracks per group and up to 99 groups in a disc.

- Even if a folder contains no playable files, the folder is also counted in the total folder number.
- Playable files which do not belong to any groups are handled as Group 1.

Playing Back a Portable Audio Device:

- When QP Link fails due to a weak sound signal from the AUX jack, Auto Standby may turn the System off even if you can hear the sound from the speakers. In such cases, adjust the volume level of the component louder so that the System can detect the sound signal properly.
- Changing from AUX to another source while QP Link works will deactivate QP Link temporarily. In this case, the following reactivate QP Link:
 - Pressing QP LINK on the remote control
 - Unplugging the component from the AUX jack, then plugging it in again
- If you press STANDBY/ON \odot /I to turn the System off or if preset Timer turns the System off while QP Link works, the System will deactivate QP Link temporarily. In such cases, the following reactivate QP Link:
 - When the sound signal from the AUX jack stops or is too weak for about 30 seconds after the System is turned off
 - When you turn on the power again
- QP Link may start working when you just plug in the component to the AUX jack or unplug it. This is not a malfunction.

Daily Operations—Sound&Other Adjustments (see pages 10 and 11)

Adjusting the Volume:

- Be sure to turn down the volume before connecting or putting on the headphones.

Adjusting the Sound:

- This function also affects the sound through the headphones.

Setting the Clock:

- “0:00” will flash on the display until you set the clock.
- The clock may gain or lose 1 to 2 minutes per month. If this happens, reset the clock.

Radio Data System Operations (see pages 12 and 13)

- If the System takes time to show the Radio Data System information—PS, PTY, RT signals, “PS,” “PTY,” or “RT” will appear while searching.

DAB Operations (see pages 14 to 17)

Presetting Services:

- If you store a new service into an occupied preset number, the previously stored service in that number will be erased.
- When you unplug the AC power cord or if a power failure occurs, the preset services will be erased in a few days. If this happens, preset the services again.

Changing the Display Mode:

- The time shown on the display is based on the built-in clock of the System, not on the information sent through DAB.

Advanced Disc Operations (see pages 18 and 19)

Programming the Playing Order—Program Play:

- You cannot specify a group number of an MP3 disc for Program Play.
- If you try to program the 100th track, “FULL” appears on the display.

Timer Operations (see pages 20 and 21)

- When you unplug the AC power cord or if a power failure occurs, the timer will be canceled. You need to set the clock first, then the timer again.

Troubleshooting

If you are having a problem with your System, check this list for a possible solution before calling for service.

General:

Adjustments or settings are suddenly canceled before you finish.

⇒ There is a time limit. Repeat the procedure again.

Operations are disabled.

⇒ The built-in microprocessor may malfunction due to external electrical interference. Unplug the AC power cord and then plug it back in.

Unable to operate the System from the remote control.

⇒ The path between the remote control and the remote sensor on the System is blocked.

⇒ The batteries are exhausted.

No sound is heard.

⇒ Speaker connections are incorrect or loose.

⇒ Headphones are connected.

Radio Operations:

Hard to hear broadcasts because of noise.

⇒ Antennas connections are incorrect or loose.

⇒ The AM loop antenna is too close to the System.

⇒ The FM antenna is not properly extended and positioned.

DAB Operations:

Cannot receive an ensemble.

⇒ Your area is not covered by the ensemble.

⇒ The DAB antenna is not properly extended or positioned.

Adjust the antenna and try the ensemble scanning again.

⇒ Connect an active antenna (not supplied).

Disc Operations:

The disc does not play.

⇒ The disc is placed upside down. Place the disc with the label side up.

ID3 Tag on an MP3 disc cannot be shown.

⇒ There are two types of ID3 Tag—Version 1 and Version 2. This System can only show ID3 Tag Version 1.

MP3 groups and tracks are not played back as you expect.

⇒ The playing order is determined when the disc was recorded. It depends on the writing application.

The disc sound is discontinuous.

⇒ The disc is scratched or dirty.

The disc tray does not open or close.

⇒ The AC power cord is not plugged in.

⇒ Child Lock is in use (see page 19).

Timer Operations:

Daily Timer does not work.

⇒ The System has been turned on when the on-time comes. Timer starts working only when the System is turned off.

Maintenance

To get the best performance of the System, keep your discs and mechanism clean.

Handling discs

- When removing the disc from its case, hold it at the edge while pressing the center hole lightly.
- Do not touch the shiny surface of the disc, or bend the disc.
- Put the disc back in its case after use to prevent warping.
- Be careful not to scratch the surface of the disc.
- Avoid exposure to direct sunlight, extreme temperature, and moisture.

To clean the disc:

- Wipe the disc with a soft cloth in a straight line from center to edge.

Cleaning the System

- Stains should be wiped off with a soft cloth. If the System is heavily stained, wipe it with a cloth soaked in water-diluted neutral detergent and wrung well, then wipe clean with a dry cloth.
- Since the System may deteriorate in quality, become damaged or have its paint peeled off, be careful about the following:
 - DO NOT wipe it with a hard cloth.
 - DO NOT wipe it forcefully.
 - DO NOT wipe it with thinner or benzine.
 - DO NOT apply any volatile substance such as insecticides to it.
 - DO NOT allow any rubber or plastic to remain in contact for a long time.

Specifications

Amplifier section

Output Power:

60 W (30 W + 30 W) at 6 Ω (10% THD)

Speakers/Impedance: 6 Ω – 16 Ω

Audio Input AUX: 500 mV/50 kΩ (at “AUX LVL 1”)

250 mV/50 kΩ (at “AUX LVL 2”)

125 mV/50 kΩ (at “AUX LVL 3”)

Tuner section

FM tuning range: 87.50 MHz – 108.00 MHz

AM (MW) tuning range: 522 kHz – 1 629 kHz

DAB tuning range:

Band III: 174.928 MHz – 239.200 MHz

L-Band: 1 452.960 MHz – 1 490.624 MHz

CD player section

Dynamic range: 88 dB

Signal-to-noise ratio: 93 dB

Wow and flutter: Immeasurable

Speakers

Speaker units: 10 cm cone x 1 + 1.5 cm dome x 1

Impedance: 6 Ω

Dimensions (approx.): 140 mm x 231 mm x 195 mm
(W/H/D)

Mass (approx.): 1.7 kg each

Supplied Accessories

See page 3.

General

Power requirement: AC 230 V ~ , 50 Hz

Power consumption: 60 W (at operation)

11 W (on standby/display on)

0.95 W (on standby/display off)

Dimensions (approx.): 165 mm x 231 mm x 328 mm
(W/H/D)

Mass (approx.): 4.1 kg

Parts Index

Refer to the pages to see how to use the buttons and controls.

Remote control

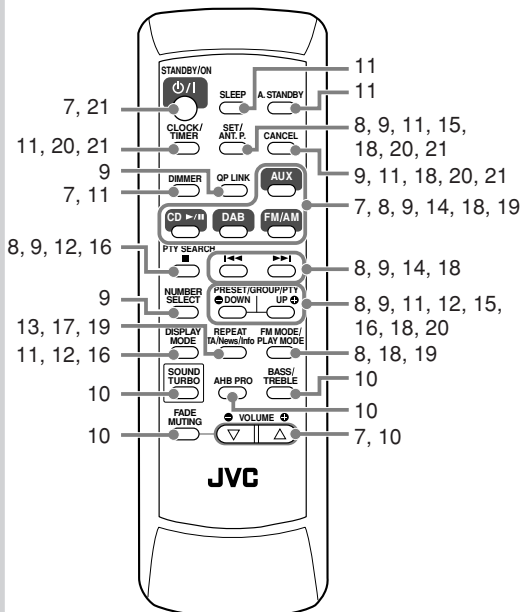

Main unit

Remote sensor

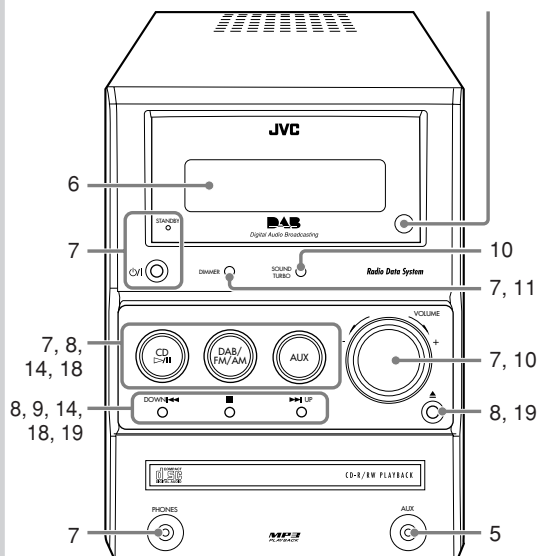

SAFETY INSTRUCTIONS

“SOME DOS AND DON'TS ON THE SAFE USE OF EQUIPMENT”

This equipment has been designed and manufactured to meet international safety standards but, like any electrical equipment, care must be taken if you are to obtain the best results and safety is to be assured.

Do read the operating instructions before you attempt to use the equipment.

Do ensure that all electrical connections (including the mains plug, extension leads and interconnections between pieces of equipment) are properly made and in accordance with the manufacturer's instructions. Switch off and withdraw the mains plug when making or changing connections.

Do consult your dealer if you are ever in doubt about the installation, operation or safety of your equipment.

Do be careful with glass panels or doors on equipment.

DON'T continue to operate the equipment if you are in any doubt about it working normally, or if it is damaged in any way—switch off, withdraw the mains plug and consult your dealer.

DON'T remove any fixed cover as this may expose dangerous voltages.

DON'T leave equipment switched on when it is unattended unless it is specifically stated that it is designed for unattended operation or has a standby mode.

Switch off using the switch on the equipment and make sure that your family know how to do this. Special arrangements may need to be made for infirm or handicapped people.

DON'T use equipment such as personal stereos or radios so that you are distracted from the requirements of traffic safety. It is illegal to watch television whilst driving.

DON'T listen to headphones at high volume as such use can permanently damage your hearing.

DON'T obstruct the ventilation of the equipment, for example with curtains or soft furnishings. Overheating will cause damage and shorten the life of the equipment.

DON'T use makeshift stands and NEVER fix legs with wood screws—to ensure complete safety always fit the manufacturer's approved stand or legs with the fixings provided according to the instructions.

DON'T allow electrical equipment to be exposed to rain or moisture.

ABOVE ALL

- NEVER let anyone, especially children, push anything into holes, slots or any other opening in the case—this could result in a fatal electrical shock.;
- NEVER guess or take chances with electrical equipment of any kind—it is better to be safe than sorry!

JVC



Free Manuals Download Website

<http://myh66.com>

<http://usermanuals.us>

<http://www.somanuals.com>

<http://www.4manuals.cc>

<http://www.manual-lib.com>

<http://www.404manual.com>

<http://www.luxmanual.com>

<http://aubethermostatmanual.com>

Golf course search by state

<http://golfingnear.com>

Email search by domain

<http://emailbydomain.com>

Auto manuals search

<http://auto.somanuals.com>

TV manuals search

<http://tv.somanuals.com>