

JVC

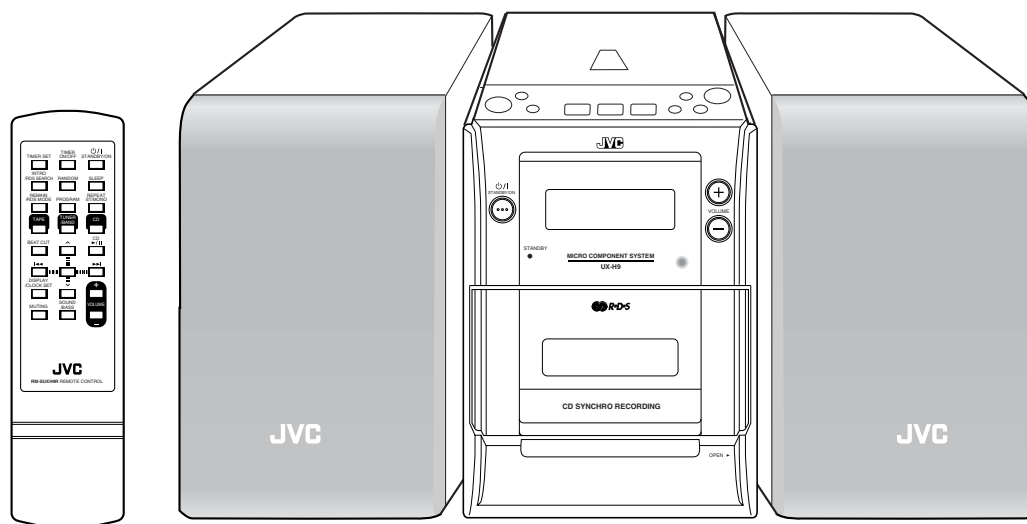

MICRO COMPONENT SYSTEM

UX-H9

 —Consists of CA-UXH9 and SP-UXH9

COMPACT
disc
DIGITAL AUDIO



INSTRUCTIONS

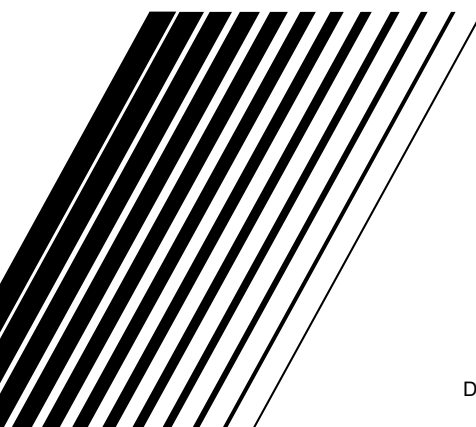

LVT1115-003B
[B]

Warnings, Cautions and Others

IMPORTANT for the U.K.

DO NOT cut off the mains plug from this equipment. If the plug fitted is not suitable for the power points in your home or the cable is too short to reach a power point, then obtain an appropriate safety approved extension lead or consult your dealer.

BE SURE to replace the fuse only with an identical approved type, as originally fitted.

If nonetheless the mains plug is cut off ensure to remove the fuse and dispose of the plug immediately, to avoid a possible shock hazard by inadvertent connection to the mains supply.

If this product is not supplied fitted with a mains plug then follow the instructions given below:

IMPORTANT:

DO NOT make any connection to the terminal which is marked with the letter E or by the safety earth symbol or coloured green or green-and-yellow.

The wires in the mains lead on this product are coloured in accordance with the following code:

Blue : Neutral
Brown : Live

As these colours may not correspond with the coloured markings identifying the terminals in your plug proceed as follows:

The wire which is coloured blue must be connected to the terminal which is marked with the letter N or coloured black.

The wire which is coloured brown must be connected to the terminal which is marked with the letter L or coloured red.

IF IN DOUBT - CONSULT A COMPETENT ELECTRICIAN.

CAUTION— / I STANDBY/ON button!

Disconnect the mains plug to shut the power off completely (all lamps and indications go off). The  / I STANDBY/ON button in any position does not disconnect the mains line.

- When the unit is on standby, the STANDBY lamp lights red.
- When the unit is turned on, the STANDBY lamp goes off.

The power can be remote controlled.

CAUTION

To reduce the risk of electrical shocks, fire, etc.:

1. Do not remove screws, covers or cabinet.
2. Do not expose this appliance to rain or moisture.

IMPORTANT FOR LASER PRODUCTS

REPRODUCTION OF LABELS

① CLASSIFICATION LABEL ON EXTERIOR SURFACE

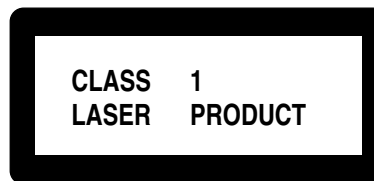

② WARNING LABEL INSIDE THE UNIT

CAUTION: Invisible laser radiation when open and interlock failed or defeated. AVOID DIRECT EXPOSURE TO BEAM. (e)

ADVARSEL: Usynlig laserstråling ved åbning, når sikkerhedsafbrydere er ude af funktion. Undgå udsættelse for stråling. (d)

WARNING: Osynlig laserstråling når denne del är öppenad och spärren är urkopplad. Betrakta ej strålen. (s)

VARO: Avattaessa ja suo-
jalukitus ohitettaessa olet
alttiina näkymättömälle
lasersäteilylle. Älä katso
säteeseen. (f)

1. CLASS 1 LASER PRODUCT

2. **CAUTION:** Invisible laser radiation when open and interlock failed or defeated. Avoid direct exposure to beam.
3. **CAUTION:** Do not open the top cover. There are no user serviceable parts inside the Unit; leave all servicing to qualified service personnel.

CAUTION

- Do not block the ventilation openings or holes.
(If the ventilation openings or holes are blocked by a newspaper or cloth, etc., the heat may not be able to get out.)
- Do not place any naked flame sources, such as lighted candles, on the apparatus.
- When discarding batteries, environmental problems must be considered and local rules or laws governing the disposal of these batteries must be followed strictly.
- Do not expose this apparatus to rain, moisture, dripping or splashing and that no objects filled with liquids, such as vases, shall be placed on the apparatus.

Caution: Proper Ventilation

To avoid risk of electric shock and fire, and to prevent damage, locate the apparatus as follows:

1 Front:

No obstructions and open spacing.

2 Sides/ Top/ Back:

No obstructions should be placed in the areas shown by the dimensions below.

3 Bottom:

Place on the level surface. Maintain an adequate air path for ventilation by placing on a stand with a height of 10 cm or more.

Front view

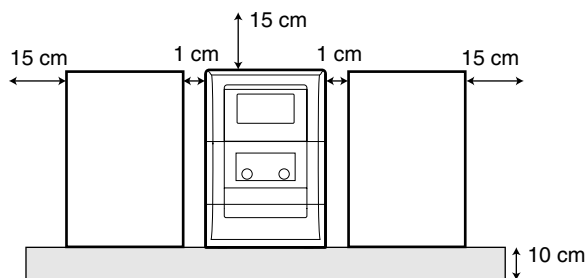

UX-H9

Side view

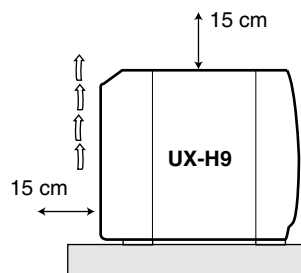

SAFETY INSTRUCTIONS

“SOME DOS AND DON'TS ON THE SAFE USE OF EQUIPMENT”

This equipment has been designed and manufactured to meet international safety standards but, like any electrical equipment, care must be taken if you are to obtain the best results and safety is to be assured.

Do read the operating instructions before you attempt to use the equipment.

Do ensure that all electrical connections (including the mains plug, extension leads and interconnections between pieces of equipment) are properly made and in accordance with the manufacturer's instructions. Switch off and withdraw the mains plug when making or changing connections.

Do consult your dealer if you are ever in doubt about the installation, operation or safety of your equipment.

Do be careful with glass panels or doors on equipment.

DON'T continue to operate the equipment if you are in any doubt about it working normally, or if it is damaged in any way—switch off, withdraw the mains plug and consult your dealer.

DON'T remove any fixed cover as this may expose dangerous voltages.

DON'T leave equipment switched on when it is unattended unless it is specifically stated that it is designed for unattended operation or has a standby mode.

Switch off using the switch on the equipment and make sure that your family know how to do this.

Special arrangements may need to be made for infirm or handicapped people.

DON'T use equipment such as personal stereos or radios so that you are distracted from the requirements of traffic safety. It is illegal to watch television whilst driving.

DON'T listen to headphones at high volume as such use can permanently damage your hearing.

DON'T obstruct the ventilation of the equipment, for example with curtains or soft furnishings.

Overheating will cause damage and shorten the life of the equipment.

DON'T use makeshift stands and NEVER fix legs with wood screws — to ensure complete safety always fit the manufacturer's approved stand or legs with the fixings provided according to the instructions.

DON'T allow electrical equipment to be exposed to rain or moisture.

ABOVE ALL

- NEVER let anyone, especially children, push anything into holes, slots or any other opening in the case -this could result in a fatal electrical shock.;
- NEVER guess or take chances with electrical equipment of any kind
- it is better to be safe than sorry!

Introduction

We would like to thank you for purchasing one of our JVC products. Before operating this unit, read this manual carefully and thoroughly to obtain the best possible performance from your unit, and retain this manual for future reference.

About This Manual

This manual is organized as follows:

- **This manual mainly explains operations using the buttons on the remote control. You can use the buttons both on the remote control and on the unit for the same operations if they have the same or similar names (or marks), unless mentioned otherwise.**
- Basic and common information that is the same for many functions is grouped in one place, and is not repeated for each procedure. For instance, we do not repeat the information about turning on/off the unit, setting the volume, changing the sound effects, and others, which are explained in the section “Basic and Common Operations” on pages 8 and 9.
- The following symbols are used in this manual:



Gives you warning and caution to prevent damage or risk of fire/electric shock. In addition, we put information here about conditions which will prevent getting the best possible performance from the unit.



Gives you information and hints you need to know.

Precautions

Installation

- Install in a place which is level, dry and neither too hot nor too cold—between 5°C and 35°C.
- Install the unit in a location with adequate ventilation to prevent internal heat buildup.
- Leave sufficient distance between the unit and the TV.
- Keep the speakers away from the TV to avoid interference with TV.



DO NOT install the unit in a location near heat sources, or in a place subject to direct sunlight, excessive dust or vibration.

Power sources

- When unplugging the unit from the wall outlet, always pull on the plug, not the AC power cord.



DO NOT handle the AC power cord with wet hands.

Moisture condensation

Moisture may condense on the lenses inside the unit in the following cases:

- After starting to heat the room.
- In a damp room.
- If the unit is brought directly from a cold to a warm place. Should this occur, the unit may malfunction. In this case, leave the unit turned on for a few hours until the moisture evaporates, unplug the AC power cord, then plug it in again.

Others

- Should any metallic object or liquid fall into the unit, unplug the AC power cord and consult your dealer before operating any further.
- If you are not going to operate the unit for an extended period of time, unplug the AC power cord from the wall outlet.



DO NOT disassemble the unit since there are no user serviceable parts inside.

If anything goes wrong, unplug the AC power cord and consult your dealer.

Contents

Location of the Buttons and Controls	3
Main unit	3
Remote Control	5
Getting Started	6
Unpacking	6
Putting the Batteries into the Remote Control	6
Connections	6
Basic and Common Operations	8
Setting the Clock	8
Turning On the Power	8
Selecting the Source	8
Adjusting the Volume	9
Selecting the Sound Modes	9
Reinforcing the Bass Sound	9
Listening to FM and AM (MW) Broadcasts	10
Tuning in to a Station	10
Presetting Stations	11
Tuning in to a Preset Station	11
Receiving FM Stations with RDS	12
Changing the RDS Information	12
Searching for Programs by PTY Codes (PTY Search)	12
Playing Back Discs	13
Playing Back the Entire Disc—Normal Play	13
Basic Disc Operations	14
Programming the Track Playing Order—Program Play	14
Playing at Random—Random Play	15
Repeating Tracks —Repeat Play	15
Playing only Introductions—Intro Play	15
Displaying the Remaining Time during Playback	15
Playing Back Tapes	16
Playing Back a Tape	16
Recording	17
Recording from the Radio	17
Recording Discs—Disc Synchronized Recording	18
Using the Timers	19
Using the Daily Timer	19
Using the Sleep Timer	20
Maintenance	21
Troubleshooting	22
Specifications	22

Location of the Buttons and Controls

Become familiar with the buttons and controls on your unit.

Main Unit

Top view

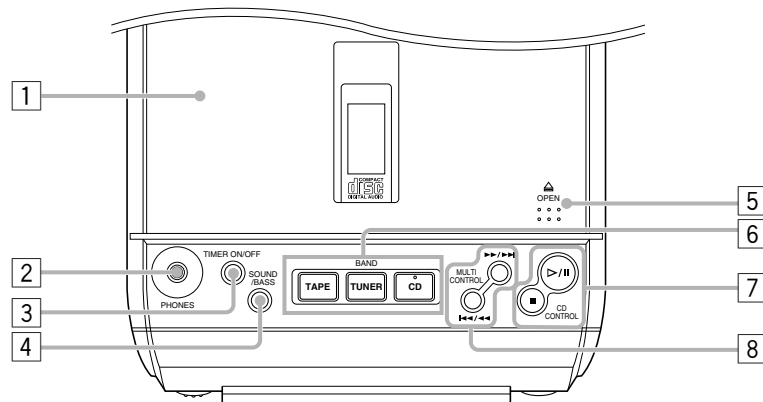

Front view

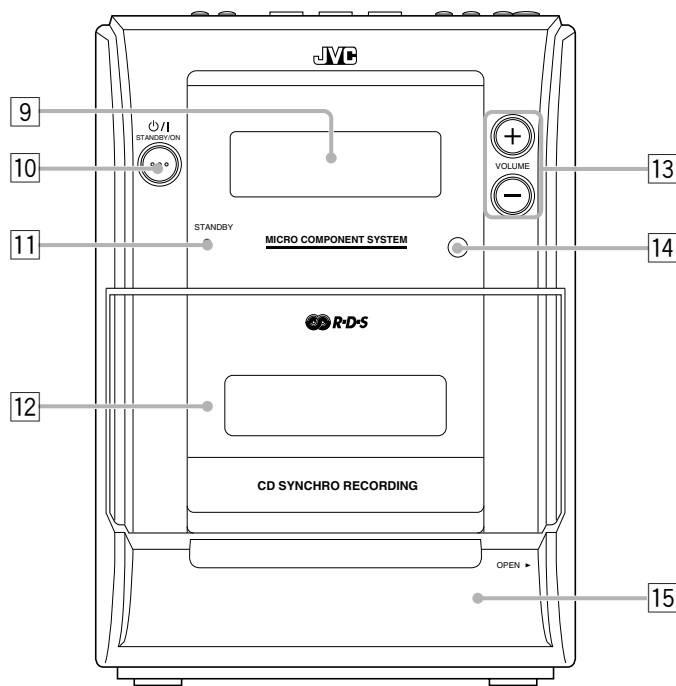

Inside the front cover

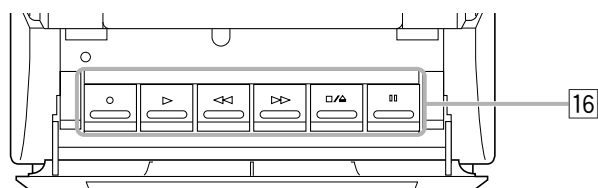

Display window on the front panel

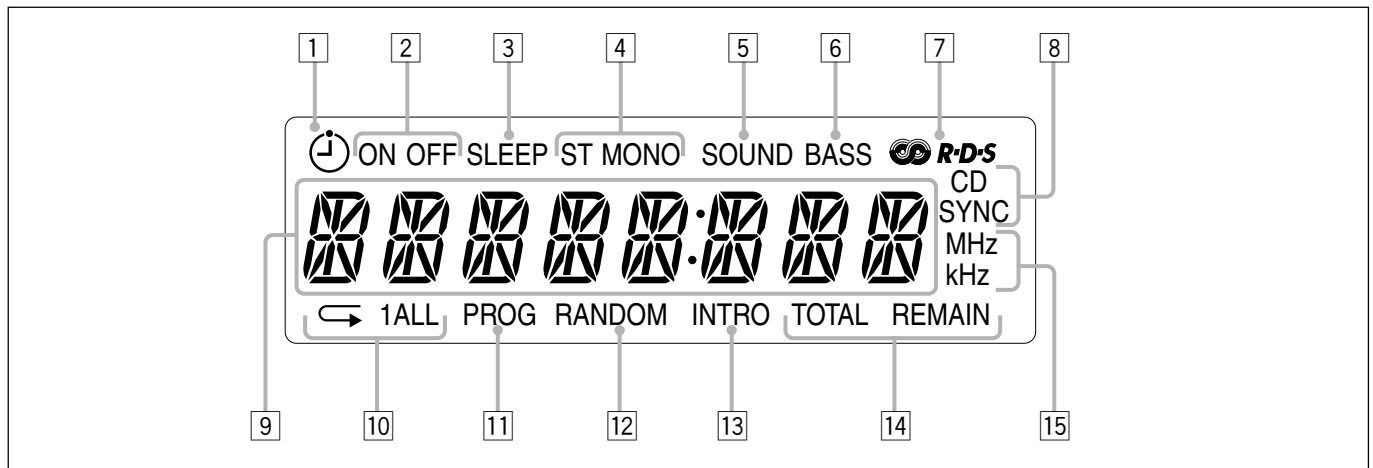

See pages in parentheses for details.

Main unit

- 1 Disc cover (13)
- 2 PHONES jack (9)
- 3 TIMER ON/OFF button (20)
- 4 SOUND/BASS button (9)
- 5 ▲ OPEN (disc cover open) (13, 14)
- 6 Source buttons
 - TAPE, TUNER/BAND, CD
 Pressing one of these buttons also turns on the unit.
- 7 CD CONTROL buttons (13, 14)
 - ▷/||, ■
- 8 MULTI CONTROL buttons
 - ▶▶/▶▶|, |◀◀/◀◀
- 9 Display window
- 10 ⏻/I STANDBY/ON button (8, 20)
- 11 STANDBY lamp (8)
- 12 Cassette holder (16)
- 13 VOLUME + / - buttons (9)
- 14 Remote sensor (5)
- 15 Front cover (16)
- 16 Tape operation buttons (16 – 18)
 - ○ (recording), ▷ (play), ◀◀ (fast backward), ▶▶ (fast forward), ◻/△ (stop/cassette holder open), || (pause)

Display window

- 1 ⏻ (timer) indicator
- 2 ON/OFF (timer on-time/off-time) indicators
- 3 SLEEP indicator
- 4 FM mode indicators
 - ST (stereo), MONO
- 5 SOUND indicator
- 6 BASS indicator
- 7 RDS indicator
- 8 CD SYNC (syncro) indicator
- 9 Main display
 - Shows the source name and other information.
- 10 Repeat indicators
 - ↶, 1, ALL
- 11 PROG (program) indicator
- 12 RANDOM indicator
- 13 INTRO indicator
- 14 Time indicators
 - TOTAL, REMAIN
- 15 Frequency indicators
 - MHz, kHz

To open the front cover

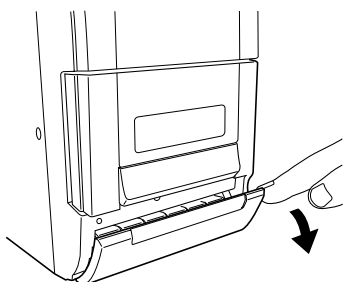

Remote Control

See pages in parentheses for details.

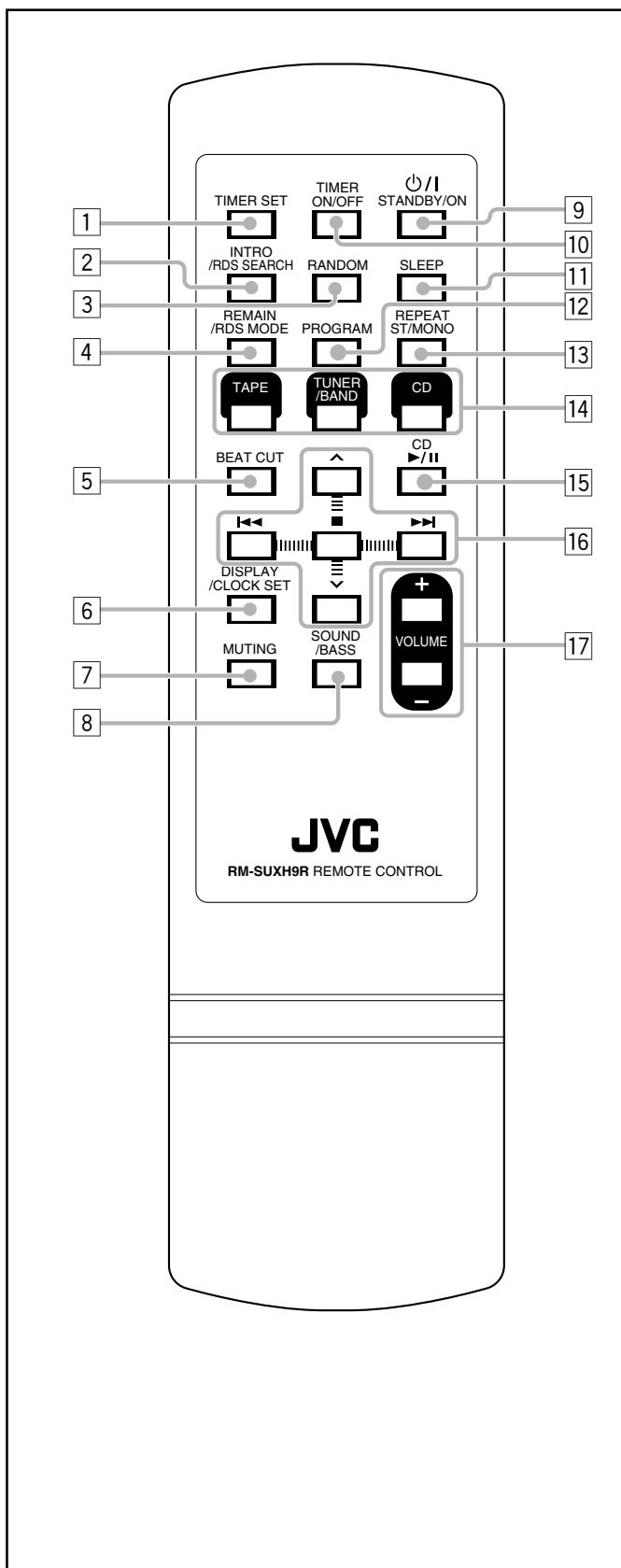

- 1 TIMER SET button (19, 20)
- 2 INTRO/RDS SEARCH button (12, 15)
- 3 RANDOM button (15)
- 4 REMAIN/RDS MODE button (12, 15)
- 5 BEAT CUT button (10, 17)
- 6 DISPLAY/CLOCK SET button (8)
- 7 MUTING button (9)
- 8 SOUND/BASS button (9)
- 9 \odot /I STANDBY/ON button (8, 20)
- 10 TIMER ON/OFF button (20)
- 11 SLEEP button (20)
- 12 PROGRAM button (8, 11, 14, 19, 20)
- 13 REPEAT ST/MONO button (10, 15)
- 14 Source buttons
 - TAPE, TUNER/BAND, CD

Pressing one of these buttons also turns on the unit.
- 15 CD \blacktriangleright /|| button (13, 14)
- 16 Multi control buttons
 - \wedge , \vee
 - \blacktriangleleft , \blacksquare , \blacktriangleright
- 17 VOLUME + / - buttons (9)

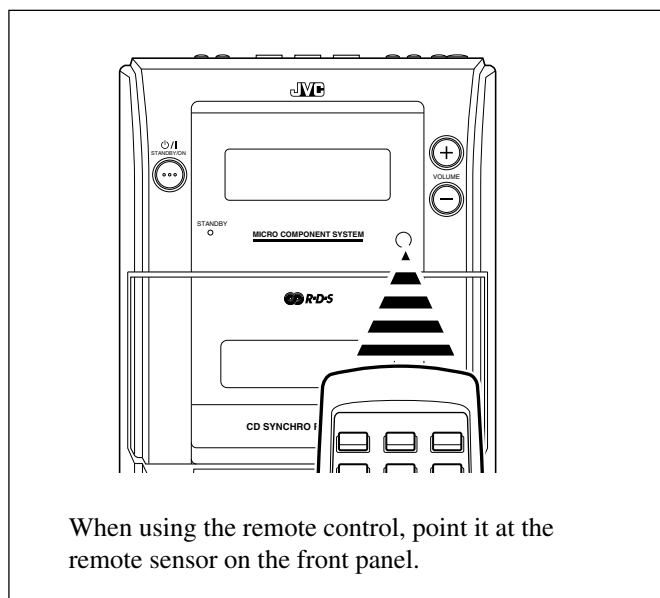

Unpacking

After unpacking, check to be sure that you have all the following items.

The number in parentheses indicates the quantity of each piece supplied.

- AM (MW) loop antenna (1)
- Remote control (1)
- Batteries (2)

If any item is missing, consult your dealer immediately.

Putting the Batteries into the Remote Control

Insert the batteries—R03(UM-4)/AAA(24F)—into the remote control by matching the polarity (+ and -) on the batteries with the + and - marking on the battery compartment.

When the remote control can no longer operate the unit, replace both batteries at the same time.

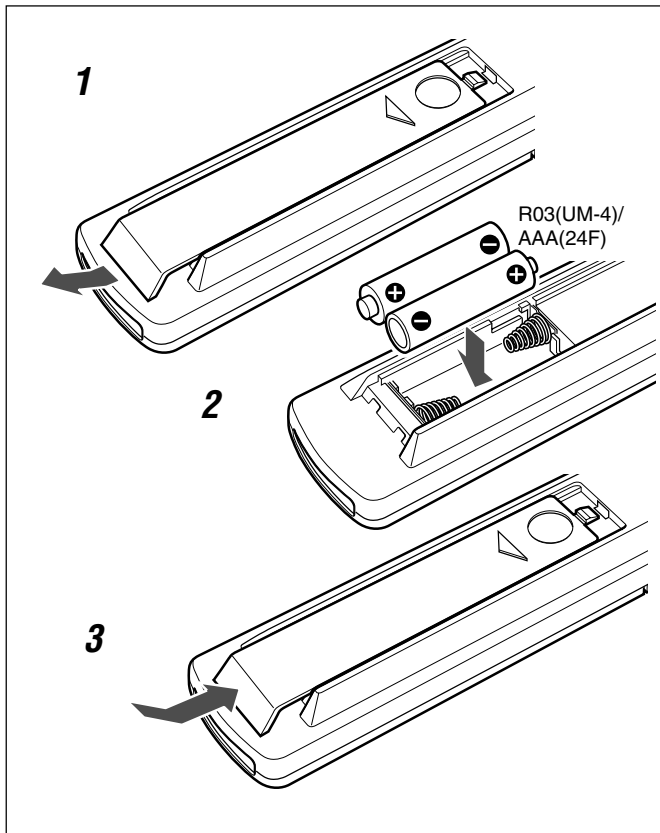

- DO NOT use an old battery together with a new one.
- DO NOT use different types of batteries together.
- DO NOT expose batteries to heat or flame.
- DO NOT leave the batteries in the battery compartment when you are not going to use the remote control for an extended period of time. Otherwise, the remote control will be damaged from battery leakage.

Connections

To connect speakers

You can connect the speakers using the speaker cords.

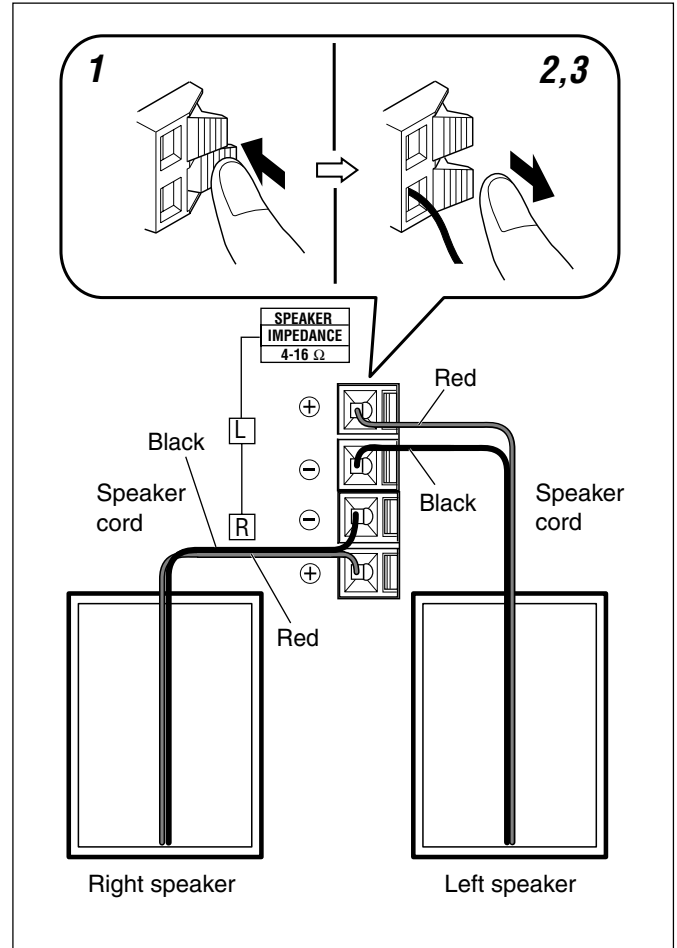

1 Hold the clamp of the speaker terminal.

2 Insert the end of the speaker cord into the terminal.

Match the polarity of the speaker terminals: red (+) to red (+) and black (-) to black (-).

3 Release your finger from the clamp.

IMPORTANT:

- Use only speakers with the same speaker impedance as indicated by the speaker terminals on the rear of the unit.
- DO NOT connect more than one speaker to one speaker terminal.

To connect AM (MW) and FM antennas

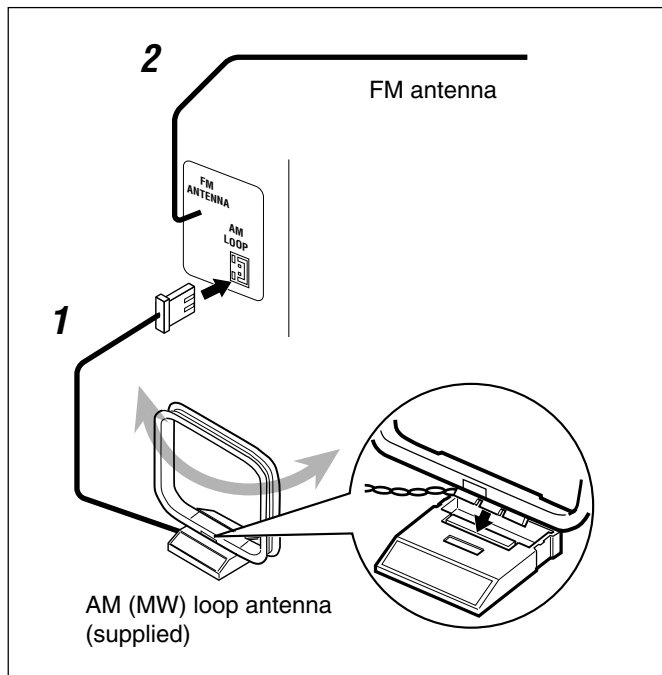

NOW you are ready to plug in the unit.

IMPORTANT:

Be sure to check that all connections have been made before plugging in the power cord.

1 Connect the supplied AM (MW) loop antenna to the AM LOOP terminal.

Place the antenna away from the unit and adjust its position for the best reception.

2 Adjust the position for the FM antenna for the best reception.



For better reception of both FM and AM (MW)

- Make sure the antenna conductors do not touch any other terminals or connecting cords.
- Keep the antennas away from metallic parts of the unit, connecting cords, and the AC power cord.

Setting the Clock

Before operating the unit any further, first set the unit's clock. When you plug in the power cord, "0:00" starts flashing on the display.



You can set the clock when the unit is either turned on or in standby mode.

On the remote control ONLY:



1 When the unit is in standby mode, press and hold PROGRAM until the hour indication starts flashing.



- When the unit is on, press DISPLAY/CLOCK SET to enter clock mode, then press and hold PROGRAM.

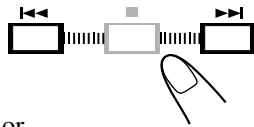

2 Press  or  to adjust the hour, then press PROGRAM.



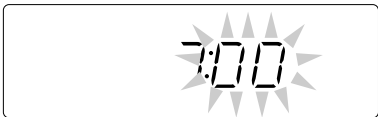

- When you press and hold  or , the hour indication changes continuously.

The minute indication start flashing.

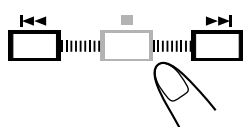

3 Press  or  to adjust the minute, then press PROGRAM.



- When you press and hold  or , the minute indication changes continuously.

The built-in clock starts.

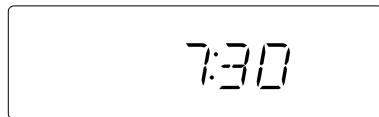

- **When you unplug the AC power cord or if a power failure occurs**

The clock is reset to "0:00" right away. If this happens, set the clock again.

- **The clock may gain or lose 1 to 2 minutes per month**

If this happens, reset the clock.

To show the clock when the unit is turned on

On the remote control ONLY:

Press DISPLAY/CLOCK SET.

- Each time you press the button, the display changes the clock indication and the normal indication alternately.



To change the clock

Repeat steps 1 to 3 of the procedure "Setting the Clock."

Turning On the Power

To turn on the unit, press /I STANDBY/ON.

The STANDBY lamp on the unit goes off.

- When you press the source button—TAPE, TUNER/BAND and CD, the unit automatically turns on.



To turn off the unit (standby), press /I STANDBY/ON again.

The STANDBY lamp on the unit lights red.

- "0:00" flashes on the display until you set the built-in clock. After setting the clock, the clock time will appear on the display while the unit is on standby.
- A little power is always consumed even while the unit is in standby mode.

To switch off the power supply completely, unplug the AC power cord from the AC outlet.



When you unplug the AC power cord or if a power failure occurs

The clock is reset to "0:00" right away. If this happens, set the clock again.

Selecting the Source

To select the source, press TAPE, TUNER/BAND, or CD.



- When you select TAPE or CD as the source, playback does not start automatically.



To operate the tuner (FM or AM (MW)), see pages 10 – 12.

To operate the CD player, see pages 13 – 15.

To operate the tape deck, see page 16.

To record on a tape, see pages 17 and 18.

Adjusting the Volume

You can adjust the volume level only while the unit is turned on. The volume level can be adjusted between “VOL MIN,” “VOL 1” – “VOL 39,” and “VOL MAX.”

- The volume level has no effect on recording.

To increase the volume, press VOLUME +.

To decrease the volume, press VOLUME –.

- When you press and hold either button, you can change the volume level continuously.

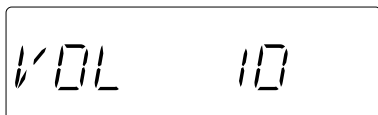

To turn off the sound temporarily

On the remote control ONLY:

Press **MUTING**.

The volume level turn down and “MUTING” starts flashing on the display.



To restore the sound, press **MUTING** again.

- Adjusting the volume level also cancels the muting.



For private listening

Connect a pair of headphones to the PHONES jack. No sound comes out of the speakers. Be sure to turn down the volume before connecting or putting on the headphones.



DO NOT turn off (standby) the unit with the volume set to an extremely high level; Otherwise, the sudden blast of sound can damage your hearing, speakers and/or headphones when you turn on the unit or start playing any source. REMEMBER you cannot adjust the volume level while the unit is in standby mode.

Selecting the Sound Modes

You can select one of the 4 sound modes.

- This function also affects the sound from headphones.
- This function only affects the playback sound, and does not affect your recording.

To select the sound modes, press **SOUND/BASS** repeatedly.

- Each time you press the button, the sound mode changes as follows:



POP: More presence in the vocals and midrange.

CLASSIC: Enriched sound with fine treble and ample bass.

ROCK: Powerful sound emphasizing treble and bass.

JAZZ: Accented lower frequencies for jazz-type music.

FLAT: Equalizer effect is canceled.

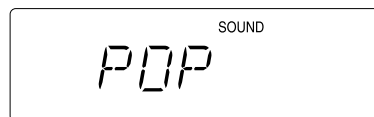

When the sound mode is activated, the **SOUND** indicator lights up on the display.

Reinforcing the Bass Sound

The richness and fullness of the bass sound is clearly maintained regardless of how low you set the volume—Hyper Bass Sound.

- This function also affects the sound from headphones.
- This function only affects the playback sound, and does not affect your recording.

To get the effect, press and hold **SOUND/BASS** until “HBS ON” appears and the **BASS** indicator lights up on the display.

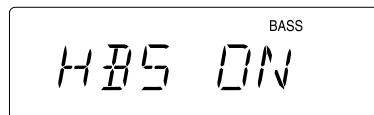

- Each time you press and hold the button, the effect alternates on (“HBS ON”) and off (“HBS OFF”).

To cancel the effect, press and hold **SOUND/BASS** again until “HBS OFF” appears and the **BASS** indicator goes off.

Listening to FM and AM (MW) Broadcasts

Tuning in to a Station

1 Press TUNER/BAND to select either “FM” or “AM.”

The unit automatically turns on and tunes in to the previously received station—either FM or AM (MW).

- Each time you press the button, the band alternates between FM and AM (MW).



FM 87.50 MHz



2 Press and hold >>> or <<< (or >>>/>>> or <<</<<< on the unit) for more than 1 second.

- >>> (>>>/>>>):
Increases the frequencies.
- <<< (<<</<<<):
Decreases the frequencies.

The unit starts searching for stations and stops when a station of sufficient signal strength is tuned in.

- If an FM program is broadcast in stereo, the ST (stereo) indicator lights up on the display (only when the reception is good).

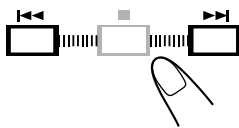

To stop during searching, press >>> or <<< (or >>>/>>> or <<</<<< on the unit).



When you repeatedly press >>> or <<< (or >>>/>>> or <<</<<< on the unit)

The frequency changes step by step.

To change the FM reception mode

On the remote control ONLY:

When an FM stereo broadcast is hard to receive or noisy, press REPEAT ST/MONO so that the MONO indicator lights up on the display. Reception will improve.



To restore the stereo effect, press REPEAT ST/MONO again so that the MONO indicator goes off. In stereo mode, you can hear stereo sound when a stereo program is broadcast.

To reduce the beat—Beat Cut

On the remote control ONLY:

If the beats are heard while listening a broadcast, press BEAT CUT.

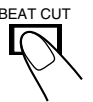

Presetting Stations

You can preset 20 FM and 20 AM (MW) stations manually.

In some cases, test frequencies have been already stored for the tuner since the factory examined the tuner preset function before shipment. This is not a malfunction. You can preset the stations you want into memory by following the presetting method.

- There is a time limit in doing the following steps. If the setting is canceled before you finish, start again from step 2.

On the remote control ONLY:

1 Tune in to the station you want to preset.

- See “Tuning in to a Station” on page 10.

2 Press PROGRAM.

The PROG (program) indicator and “00” start flashing on the display.



3 Press ^ or v to select a preset number.

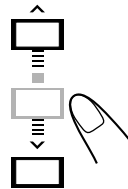
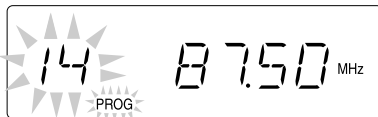

4 Press PROGRAM again.

The PROG indicator and the selected preset number stop flashing.



5 To preset more stations, repeat steps 1 to 4 above, allocating a different preset number to each station.

- Storing a new station on an already assigned number erases the previously stored one.



When you unplug the AC power cord or if a power failure occurs

The preset stations will remain in the unit.

Tuning in to a Preset Station

On the remote control ONLY:

1 Press TUNER/BAND to select either “FM” or “AM.”

The unit automatically turns on and tunes in to the previously received station—either FM or AM (MW).

- Each time you press the button, the band alternates between FM and AM (MW).



2 Press ^ or v to select a preset number.

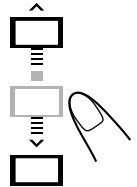

Receiving FM Stations with RDS

RDS (Radio Data System) allows FM stations to send an additional signal along with their regular program signals. For example, the stations send their station names, as well as information about what type of program they broadcast, such as sports or music, etc.

When tuned in to an FM station which provides the RDS service, the RDS indicator lights up on the display. With the unit, you can receive the following types of RDS signals.

PS (Program Service):

Shows commonly known station names.

PTY (Program Type):

Shows types of broadcast programs.

TEXT (Radio Text):

Shows text messages the station sends.



More about RDS

- Some FM and AM (MW) stations do not provide RDS signals.
- RDS services vary among FM RDS stations. For details on RDS services in your area, check with local radio stations.
- RDS may not work correctly if the received station is not transmitting the signals properly or if the signal strength is weak.

Changing the RDS Information

You can see RDS information on the display while listening to an FM station.

On the remote control ONLY:

Press REMAIN/RDS MODE.

- Each time you press the button, the display changes to show the following information:

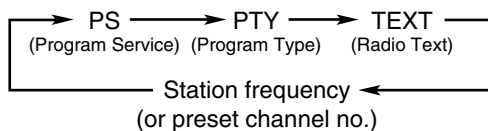

- **If no PS, PTY, or TEXT signals are sent by a station** "NO PS," "NO PTY," or "NO TEXT" appears on the display.
- **On the characters displayed** When the display shows PS, PTY or TEXT signals:
 - The display shows upper case letters only.
 - The display cannot show accented letters; for example, "A" may represent accented "A's" like "Á, Â, Ã, Ä, Å and Ä."

Searching for Programs by PTY Codes (PTY Search)

One of the advantages of RDS is that you can locate a particular kind of program by specifying the PTY codes.

- For details on the PTY codes, see below.
- There is a time limit in doing the following steps. If the setting is canceled before you finish, start over from step 1.

On the remote control ONLY:

1 Press INTRO/RDS SEARCH until the PTY code you want appears on the display.



- Each time you press the button, the PTY codes change as follows:

NEWS → AFFAIRS → INFO → SPORT → EDUCATE → DRAMA → CULTURE → SCIENCE → VARIED → POP M → ROCK M → EASY M → LIGHT M → CLASSICS → OTHER M → (back to the beginning)

2 Press ►► or ◀◀.

The unit searches FM stations, stops when it finds the one you have selected, and tunes in that station.

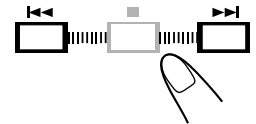

- If no program is found, the unit returns to the last received station.

To stop searching any time during the process, press INTRO/RDS SEARCH while searching.

Description of the PTY codes:

NEWS:	News.
AFFAIRS:	Topical program expanding or enlarging upon the news—debate, or analysis.
INFO:	Program the purpose of which is to impart advice in the widest sense.
SPORT:	Program concerned with any aspect of sports.
EDUCATE:	Educational programs.
DRAMA:	All radio plays and serials.
CULTURE:	Programs concerning any aspect of national or regional culture, including language, theater, etc.
SCIENCE:	Programs about natural sciences and technology.
VARIED:	Used for mainly speech-based programs such as quizzes, panel games and personality interviews.
POP M:	Commercial music of current popular appeal.
ROCK M:	Rock music.
EASY M:	Current contemporary music considered to be "easy-listening."
LIGHT M:	Instrumental music, and vocal or choral works.
CLASSICS:	Performances of major orchestral works, symphonies, chamber music, etc.
OTHER M:	Music not fitting into any of the other categories.

Classification of the PTY codes for some FM stations may be different from the above list on this page.

Playing Back Discs

This unit has been designed to play back the following discs—CD, CD-R, and CD-RW.

When playing a CD-R or CD-RW

User-edited CD-Rs (CD-Recordable) and CD-RWs (CD-ReWritable) can be played only if they are already “finalized.”

- Usually you can play back your original CD-Rs or CD-RWs recorded in music CD format. However, sometimes they may not play depending on their characteristics or recording conditions.
- Before playing CD-Rs or CD-RWs, read their instructions or cautions carefully.
- Some CD-Rs or CD-RWs may not play on this unit because of their disc characteristics, damage or stain on them, or if the player’s lens is dirty.
- CD-RWs may require a longer readout time. This is because the reflectance of CD-RWs is lower than for regular discs.

General notes

In general, you will have the best performance by keeping your discs and the mechanism clean.

- Store discs in their cases, and keep them in cabinets or on shelves.
- Keep the unit’s disc trays closed when not in use.

Continued use of irregular shape discs (heart-shape, octagonal, etc.) can damage the unit.



Playing Back the Entire Disc—Normal Play

1 Press **OPEN** on the unit.

The disc cover opens.

- You can insert a disc while listening to another source.

2 Place a disc correctly with its label side up.

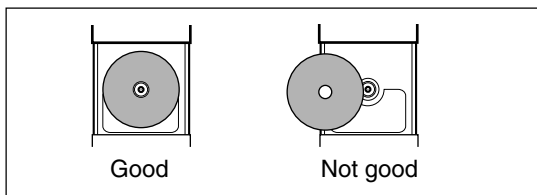

3 Close the disc cover gently.

4 Press **CD**.

The unit automatically turns on and the source changes to the CD player. After loading the disc, total track number and total playing time appear on the display.

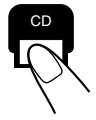

Total track number Total playing time

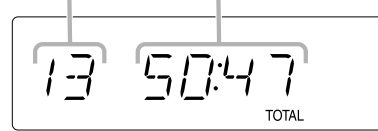

5 Press **CD ▶/||**.

The first track of the disc starts playing.



Current track number



Elapsed playing time

- The disc automatically stops when the last track has finished playing.

To stop playing, press **■**.

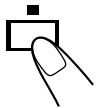

To remove the disc, press **OPEN** on the unit.



- If the disc cannot be read correctly (because it is scratched, for example) or an unreadable CD-R or CD-RW is inserted Playback will not start.
- If no disc is inserted “NO DISC” appears on the display.



DO NOT try to open the disc cover by hand as it will be damaged.

Basic Disc Operations

While playing a disc, you can do the following operations.

To stop playing for a moment

During play, press CD ►/||.

While pausing, the elapsed playing time flashes on the display.



To resume playing, press CD ►/|| again.

To go to another track

Before or during play, press ►► or ◀◀ repeatedly.

- ►►: Skips to the beginning of the next or succeeding tracks.
- ◀◀: Goes back to the beginning of the current or previous tracks.

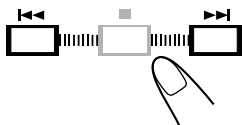

To locate a particular point in a track

During play, press and hold ►► or ◀◀.

- ►►: Fast-forwards the tracks.
- ◀◀: Fast-reverses the tracks.

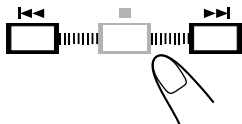

Programming the Track Playing Order —Program Play

You can arrange the order in which tracks play before you start playing. You can program up to 60 tracks.

On the remote control ONLY:

1 Place a disc.

- If the current source is not the CD player, press CD.

2 Press PROGRAM.

The PROG (program) indicator starts flashing on the display.

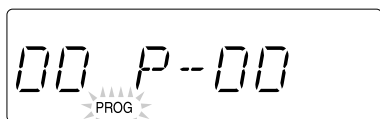

- If a program has been stored in memory, the program is called up.

3 Press ►► or ◀◀ to select the track number, then press PROGRAM.

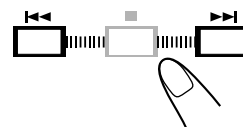

Track number Program step number

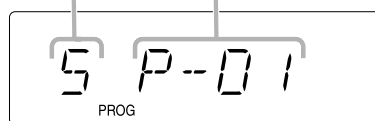

4 Repeat step 3 to program other tracks you want.

5 Press CD ►/||.

The tracks are played in the order you have programmed.



If you try to program a 61st track "FULL" will appear on the display.

To stop playing, press ■.

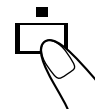

To check the program contents

Press PROGRAM repeatedly in stop mode. The program number and track number are displayed in succession.



To modify the program

Press PROGRAM repeatedly in stop mode to select the number which you want to change the track, then repeat step 3 above.



To clear the program

Press ■ in stop mode. The PROG indicator disappears from the display.

- Pressing ▲ OPEN to open the disc cover will also erase the programmed tracks.

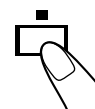

Playing at Random—Random Play

You can play the tracks at random.

On the remote control ONLY:

Press **RANDOM** before or during playing.

The **RANDOM** indicator lights up on the display.

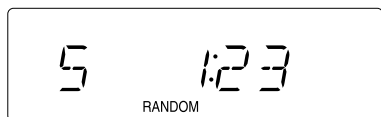

To exit from **Random Play**, press **RANDOM** again. The **RANDOM** indicator goes off.



- It is not possible to activate the random play function during Program Play.

Repeating Tracks—Repeat Play

You can have all the tracks, the program or individual track currently playing, repeat as many times as you like.

On the remote control ONLY:

Press **REPEAT ST/MONO** repeatedly before or during playing.

- Each time you press the button, Repeat Play changes as follows, and the following repeat indicator lights up on the display:

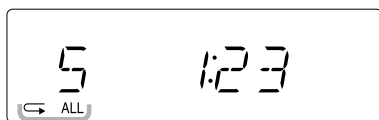
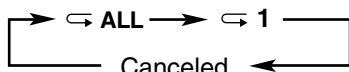

Repeat indicators

- ↶ **ALL**: In Normal Play, repeats all the tracks. In Program Play, repeats all the tracks in the program. In Random Play, repeats all the tracks in random order.
- ↶ **1**: Repeats one track.

To cancel **Repeat Play**, press **REPEAT ST/MONO** repeatedly until the repeat indicator goes off.



- Repeat Play remains in effect even when you select another play mode (Normal, Program, Random, or Intro Play).
- In Random Play, ↶ **1** cannot be selected. If ↶ **1** has been selected when you press **RANDOM**, it is canceled.
- If you select ↶ **1** in Random Play, Random Play is canceled.

Playing only Introductions—Intro Play

You can play only the introductions of the tracks.

On the remote control ONLY:

Press **INTRO/RDS SEARCH**.

The **INTRO** indicator lights up and the first 10-second portion of each track is played back in order.



To cancel **Intro Play**, press **INTRO/RDS SEARCH** again. The **INTRO** indicator goes off.

- Intro Play remains in effect even when you select another play mode (Program or Random Play).

Displaying the Remaining Time during Playback

You can display the remaining time of the current track/disc and the elapsed time of the current track/disc during playing.

On the remote control ONLY:

Press **REMAIN/RDS MODE** repeatedly.

- Each time you press the button, the display changes as follows, and the following indicators light up on the display:

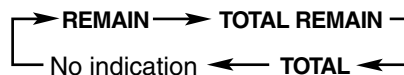

- REMAIN**: Shows the remaining time of the current track.
- TOTAL REMAIN**: Shows the remaining time and track number of the disc.
- TOTAL**: Shows the elapsed time of the disc.
- No indication**: Shows the elapsed time of the current track.

Playing Back Tapes

For Tape operations, use buttons inside the front cover on the unit.

Playing Back a Tape

You can play back type I tapes only.

On the unit ONLY:

1 Open the front cover.

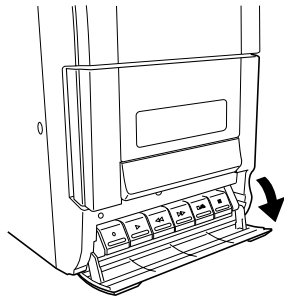

2 Press □/△ (stop/cassette holder open).

The cassette holder opens.

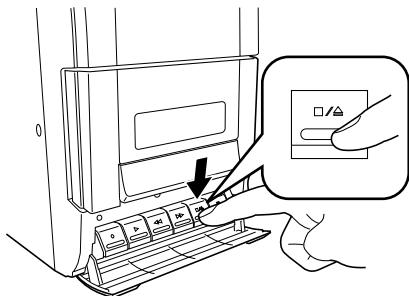

3 Put a cassette in with the exposed part of the tape down.

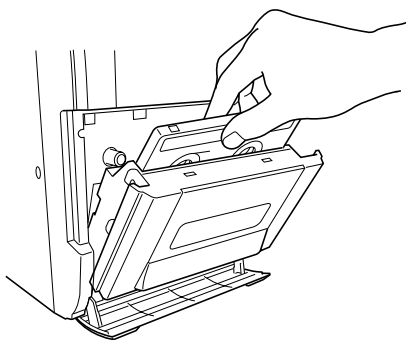

4 Close the cassette holder gently.

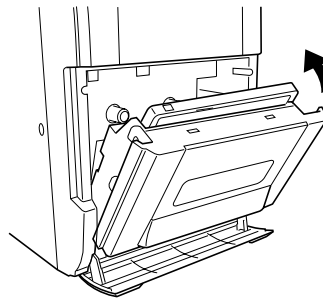

5 Press TAPE.

The unit automatically turns on and the source changes to the tape deck.

- You can select to the tape by pressing TAPE on the remote control.



6 Press ▷ (play).

The tape starts playing.

- When the end of the tape is reached, playing stops.

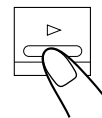

To stop playing, press □/△.

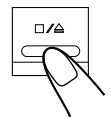

To stop playing for a moment, press ||| (pause).
To resume playing, press ||| again.

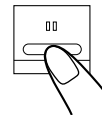

To fast forward or rewind the tape, press ▷▷ or ◀◀.

- The tape stops at the end of the fast forwarding or rewinding. To release the locked button, press □/△.

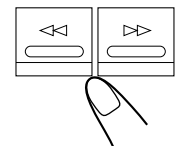

To remove the cassette, press □/△ while playback is stopped.

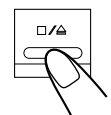

- DO NOT turn off the unit while playing back or recording a tape. The cassette deck or tapes may be damaged.
- The use of C-120 or longer tape is not recommended, since characteristic deterioration may occur and this tape easily jams in the pinch rollers and the capstans.
- This unit is not compatible with type II and type IV tapes.

Recording

IMPORTANT:

- It should be noted that it may be unlawful to re-record pre-recorded tapes, records, or discs without the consent of the owner of copyright in the sound or video recording, broadcast or cable program and in any literary, dramatic, musical, or artistic embodied therein.
- The recording level is automatically set correctly, so it is not affected by the other sound settings. Thus, during recording you can adjust the sound you are actually listening to without affecting the recording level.
- If recordings you have made have excessive noise or static, the unit may be too close to a TV. Increase the distance between the TV and the unit.
- You can only use type I tape for recording.



- DO NOT turn off the unit while playing back or recording a tape. The cassette deck or tapes may be damaged.
- DO NOT use type II and type IV tapes since the unit is not compatible with such tapes.
- The use of C-120 or longer tape is not recommended, since characteristic deterioration may occur and this tape easily jams in the pinch rollers and the capstans.



At the start and end of cassette tapes

There is leader tape which cannot be recorded onto. Thus, when recording from discs, FM/AM broadcasts, or external equipment, wind the leader tape first to ensure that the recording will be made without losing any music.

To protect your recordings

Cassettes have two small tabs on the back to protect against unexpected erasure or re-recording.

To protect your recording, remove these tabs.

To re-record on a protected tape, cover the holes with adhesive tape.

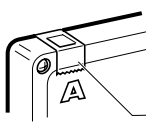

Adhesive tape

Recording from the Radio

On the unit ONLY:

1 Put a recordable cassette in with the exposed part of the tape down.

- See also page 16.

2 Close the cassette holder gently.

3 Press **TUNER/BAND** to select either “FM” or “AM.”

- When recording from discs, see “Recording Discs—Disc Synchronized Recording” on page 18.

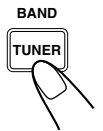

4 Tune in to the station you want to record.

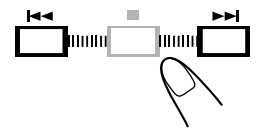

5 Press **○** (recording).

- ○ and ▷ lock down, and the recording starts.

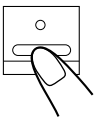

You cannot press ○ in the following cases:

- If no cassette is inserted.
- If a protected tape is inserted.

To stop recording for a moment, press **⏸** (pause).

To resume recording, press **⏸** again.

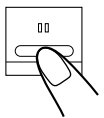

To stop recording, press **□/△**.

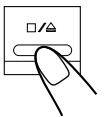

To remove the cassette, press **□/△** while recording is stopped.

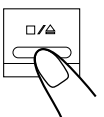

To record an AM (MW) station—Beat Cut

On the remote control ONLY:

While recording an AM (MW) broadcast, beats may be heard (which are never heard when listening to the broadcast without recording it). If this occurs, press **BEAT CUT** repeatedly, while recording, until the beats are reduced.

- Each time you press the button, the display changes alternates “BEAT 01” and “BEAT 02.”



Recording Discs

—Disc Synchronized Recording

You can start disc play and recording at the same time.

On the unit ONLY:

1 Put a recordable cassette in with the exposed part of the tape down.

- See also page 16.

2 Close the cassette holder gently.

3 Press CD select the CD player as the source.

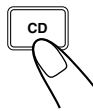

4 Press O (recording).

The CD SYNC indicator appears on the display and the CD starts playback automatically and the recording starts.

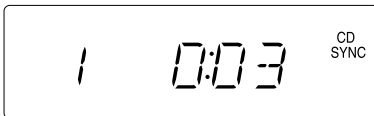
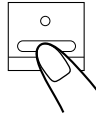

- When the end of the tape is reached, recording stops and the CD player is paused.
- If you press O while playing back the CD, the CD player return to the beginning of that track and the track is recorded on the tape.



You cannot press O in the following cases:

- If no cassette is inserted.
- If a protected tape is inserted.

To stop recording for a moment, press ⏏.

The recording is paused, but the CD playback does not stop.

To resume recording, press ⏏ again.

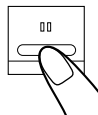

To stop recording, press □/△.

The recording stops and the CD playback is paused.



To remove the cassette, press □/△ while recording is stopped.



Using the Timers

Daily Timer and Sleep Timer are available.

- Before using these timers, make sure the built-in clock is set correctly (see page 8).

Using the Daily Timer

You can set the Daily Timer when the unit is either turned on or in standby mode.

How the Daily Timer actually works

When the on-time comes, the unit automatically turns on and then the off-time comes, the unit automatically turns off (standby).

- Once the timer has been set, it will be activated at the same time everyday until the timer is turned off and the timer setting remains in memory until you change it.

Before you start...

When using "TUNER" as the source to play, make sure to select the desired station before turning off the power.

- There is a time limit in doing the following steps. If the setting is canceled before you finish, start again from step 1.

On the remote control ONLY:

1 Press TIMER SET.

The ⌚ (timer) and the ON (on-time) indicators flash and the on-time setting appears on the display.

If you do not need to change the on-time setting, go to step 3.

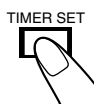

2 Press PROGRAM to set the on-time you want the unit to turn on.

The hour indication starts flashing on the display.

- 1) Press ►► or ◀◀ to set the hour, then press PROGRAM.
- 2) Press ►► or ◀◀ to set the minute, then press PROGRAM.

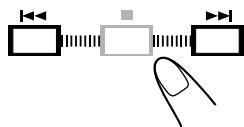

3 Press TIMER SET.

The ⌚ (timer) and the OFF (off-time) indicators flash and the off-time setting appears on the display.

If you do not need to change the off-time setting, go to step 5.

- If you change the on-time setting, the off-time setting changes to "--:--". You need to set the off-time setting.

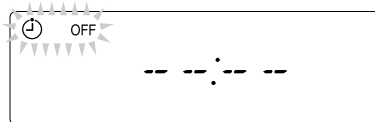

4 Press PROGRAM to set the off-time you want the unit to turn off.

The hour indication starts flashing on the display.

- 1) Press ►► or ◀◀ to set the hour, then press PROGRAM.
- 2) Press ►► or ◀◀ to set the minute, then press PROGRAM.

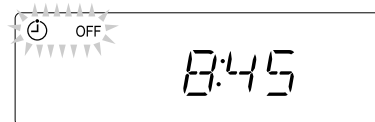

5 Press TIMER SET.

The ⌚ (timer) indicator flashes and the source name appears on the display.

If you do not need to change the source, go to step 7.

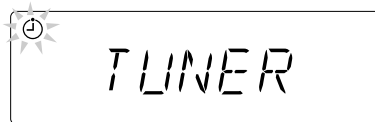

6 Press PROGRAM to select the source to play.

The source name starts flashing on the display.

- Press ►► or ◀◀ to select "CD" or "TUNER," then press PROGRAM.

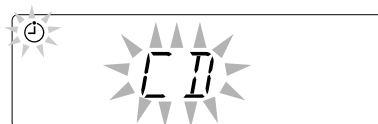

7 Press **TIMER SET**.

The display changes normal indication and exit the timer setting mode.

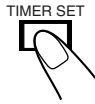

8 Press **TIMER ON/OFF** to activate the daily timer mode.

Each time you press the button, the Daily Timer alternates on and off.

While activating the Daily Timer, the ⏰ (timer) indicator lights up on the display.

- You can activate the Daily Timer by pressing **TIMER ON/OFF** on the unit.



9 Press **⏻/I STANDBY/ON** to turn off the unit if the unit is on.

To deactivate the timer temporarily, press **TIMER ON/OFF** until the ⏰ (timer) indicator goes off.



To activate and change the timer, repeat steps **1** to **8** on pages 19 and 20.

- To activate the timer again without changing the setting, press **TIMER ON/OFF** until the ⏰ (timer) indicator lights up on the display.



If the unit is already turned on when the timer on-time comes

The timer does not work.



When you unplug the AC power cord or if a power failure occurs

The timer will be canceled. You need to set the clock first, then set the timer again.

Using the Sleep Timer

With the Sleep Timer, you can fall asleep to your favorite music or radio program.

- You can set the Sleep Timer only when the unit is turned on.

How the Sleep Timer actually works

The unit automatically turns off after the specified length of time passes.

On the remote control ONLY:

1 Press **SLEEP**.

The **SLEEP** indicator lights up on the display.



- Each time you press the button, the length of time changes as follows:

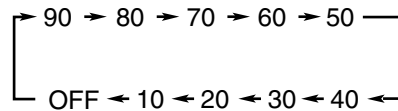

2 Wait for about 5 seconds after specifying the length of time.

To check the remaining time until shut-off time, press **SLEEP** once. The remaining time until shut-off time appears for about 5 seconds.

To change the shut-off time, press **SLEEP** repeatedly until the length of time you want appears.

To cancel the setting, press **SLEEP** repeatedly until "OFF" appears and the **SLEEP** indicator goes off on the display.

- Turning off the unit also cancels the Sleep Timer.



When you set the Sleep Timer after the Daily Timer starts playing the selected source

The unit turns off with either timer having an earlier shut-off time.



If you set the Sleep Timer while playing back or recording a tape

Do not shut the unit off with the Sleep Timer while a tape is running. If the unit turns off while playing back or recording a tape, the cassette deck or tapes may be damaged.

Maintenance

To get the best performance of the unit, keep your discs, tapes and mechanism clean.

General Notes

In general, you will have the best performance by keeping your discs, tapes and the mechanism clean.

- Store discs and tapes in their cases, and keep them in cabinets or on shelves.

Cleaning the unit

• Stains on the unit

Should be wiped off with a soft cloth. If the unit is heavily stained, wipe it with a cloth soaked in water-diluted neutral detergent and wrung well, then wipe clean with a dry cloth.

- **Since the unit may deteriorate in quality, become damaged or have its paint peel off, be careful about the following:**
 - DO NOT wipe it with a rough cloth.
 - DO NOT wipe it too vigorously.
 - DO NOT wipe it with thinner or benzine.
 - DO NOT apply any volatile substance such as an insecticide to it.
 - DO NOT allow any rubber or plastic to remain in contact with it for a long time.

Handling discs



- Remove the disc from its case by holding it at the edge while pressing the center hole lightly.
- Do not touch the shiny surface of the disc, or bend the disc.
- Put the disc back in its case after use to prevent warping.

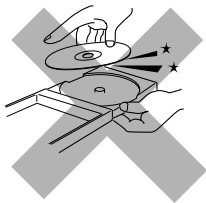

- Be careful not to scratch the surface of the disc when placing it back in its case.
- Avoid exposure to direct sunlight, temperature extremes, and moisture.

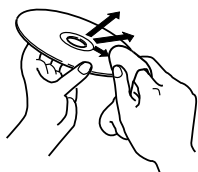

To clean the disc

Wipe the disc with a soft cloth in a straight line from center to edge.



DO NOT use any solvent—such as conventional record cleaner, spray, thinner, or benzine—to clean the disc.

Handling cassette tapes

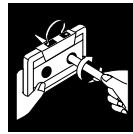

- If the tape is loose in its cassette, take up the slack by inserting a pencil in one of the reels and rotating.
- If the tape is loose, it may get stretched, cut, or caught in the cassette.

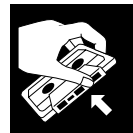

- Be careful not to touch the tape surface.



- Avoid storing tapes in any of the following places:
 - In dusty places
 - In direct sunlight or heat
 - In moist areas
 - On a TV or speaker
 - Near a magnet

To keep the best recording and playback sound quality

You need to clean the heads.

- Clean the heads after every 10 hours of use with a wet-type head cleaning tape (available at electronic and audio shops).

When the head becomes dirty, the following symptoms will occur:

 - Sound quality is reduced.
 - Sound level decreases.
 - Sound drops out.
- Do not play dirty or dusty tapes.
- Do not touch the highly-polished head with any metallic or magnetic tools.

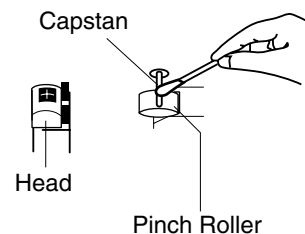

To demagnetize the head

Turn off the unit, and use a head demagnetizer (available at electronic and audio shops).

Troubleshooting

If you are having a problem with your unit, check this list for a possible solution before calling for service.

If you cannot solve the problem from the hints given here, or the unit has been physically damaged, call a qualified person, such as your dealer, for service.

Symptom	Possible Cause	Action
Power does not come on.	The power cord is not connected to an AC outlet.	Insert the plug into the socket.
No sound is heard.	<ul style="list-style-type: none"> • Connections are incorrect or loose. • A pair of headphones is connected. 	<ul style="list-style-type: none"> • Check all connections and make corrections. (See pages 6 and 7.) • Unplug the headphones from the PHONES jack.
Hard to listen to broadcasts because of noise.	<ul style="list-style-type: none"> • Antennas are disconnected. • The AM (MW) loop antenna is too close to the unit. • The FM antenna is not properly extended and positioned. 	<ul style="list-style-type: none"> • Reconnect the antenna correctly and securely. • Change the position and direction of the AM (MW) loop antenna. • Extend FM antenna and orient to the best reception position.
The disc does not play.	The disc is upside down.	Put the disc in with the label side up.
Impossible to record.	Small tabs on the back of the cassette are removed.	Cover the holes with adhesive tape.
Operations are disabled.	The built-in microprocessor has malfunctioned due to external electrical interference.	Unplug the AC power cord then plug it back in.
Unable to operate the unit by the remote control.	<ul style="list-style-type: none"> • The path between the remote control and the remote sensor on the unit is blocked. • The batteries are exhausted. • You are using the remote control too far from the unit. 	<ul style="list-style-type: none"> • Remove the obstruction. • Replace the batteries. (See page 6.) • Signals cannot reach the remote sensor. Move closer to the unit.

Specifications

Design and specifications are subject to change without notice.

Amplifier Section—CA-UXH9

Output Power (IEC 268-3):

10 W (5 W + 5 W) at 4 Ω (10% THD)

Speakers/Impedance: 4 Ω – 16 Ω

Tuner

FM tuning range: 87.50 MHz—108.00 MHz

AM (MW) tuning range: 522 kHz—1 629 kHz

CD player

Dynamic range: 60 dB

Signal-to-noise ratio: 60 dB

Wow and flutter: Immeasurable

Cassette deck

Frequency response:

Normal (type I): 100 Hz—10 000 Hz

Wow and flutter: 0.35 % (WRMS)

General

Power requirement: AC 230 V \sim , 50 Hz

Power consumption: 22 W (at operation)

3.0 W (on standby)

Dimensions (W/H/D) (approx.):

145 mm x 209 mm x 226 mm

Mass (approx.):

2.8 kg

Supplied accessories

See page 6.

Speaker Section—SP-UXH9

Type: Full range bass-reflex type

Speakers: 10 cm cone x1

Power handling capacity: 5 W

Impedance: 4 Ω

Frequency range: 100 Hz to 15 kHz

Dimensions (W/H/D) (approx.):

135 mm x 209 mm x 152 mm

Mass (approx.):

1.3 kg each



Free Manuals Download Website

<http://myh66.com>

<http://usermanuals.us>

<http://www.somanuals.com>

<http://www.4manuals.cc>

<http://www.manual-lib.com>

<http://www.404manual.com>

<http://www.luxmanual.com>

<http://aubethermostatmanual.com>

Golf course search by state

<http://golfingnear.com>

Email search by domain

<http://emailbydomain.com>

Auto manuals search

<http://auto.somanuals.com>

TV manuals search

<http://tv.somanuals.com>