

JVC



COMPACT COMPONENT SYSTEM

FS-B70

—Consists of CA-FSB70 and SP-UXB70

COMPACT
disc
DIGITAL AUDIO

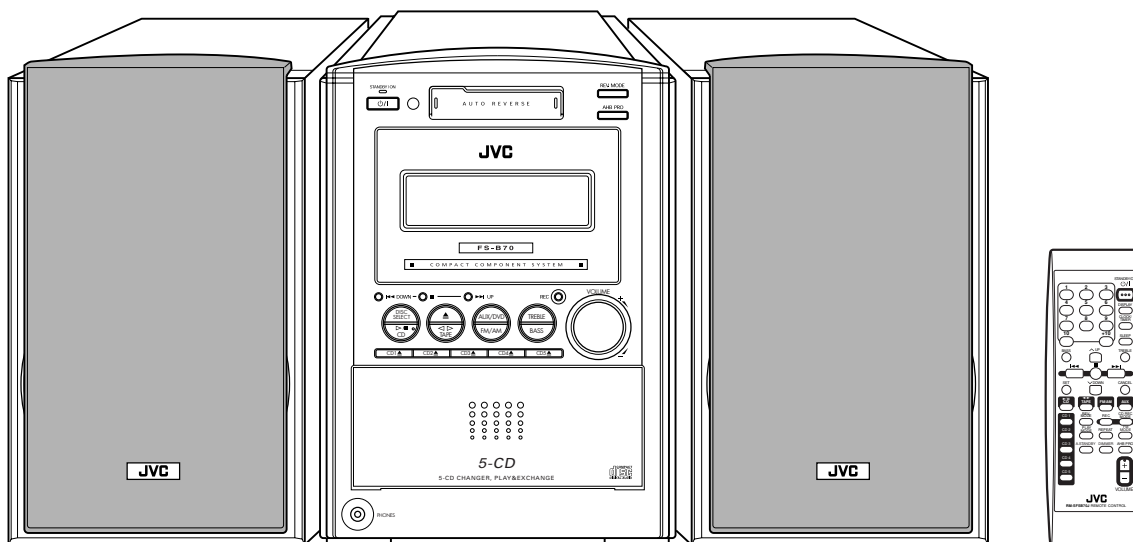

INSTRUCTIONS

For Customer Use:

Enter below the Model No. and Serial No. which are located either on the rear, bottom or side of the cabinet. Retain this information for future reference.

Model No. _____

Serial No. _____

GVT0103-001A
[J]

Warnings, Cautions and Others

Mises en garde, précautions et indications diverses

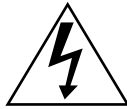

The lightning flash with arrowhead symbol, within an equilateral triangle is intended to alert the user to the presence of uninsulated dangerous voltage within the product's enclosure that may be of sufficient magnitude to constitute a risk of electric shock to persons.



The exclamation point within an equilateral triangle is intended to alert the user to the presence of important operating and maintenance (servicing) instructions in the literature accompanying the appliance.

For U.S.A.

This equipment has been tested and found to comply with the limits for a Class B digital device, pursuant to part 15 of the FCC Rules. These limits are designed to provide reasonable protection against harmful interference in a residential installation.

This equipment generates, uses and can radiate radio frequency energy and, if not installed and used in accordance with the instructions, may cause harmful interference to radio communications. However, there is no guarantee that interference will not occur in a particular installation. If this equipment does cause harmful interference to radio or television reception, which can be determined by turning the equipment off and on, the user is encouraged to try to correct the interference by one or more of the following measures:

Reorient or relocate the receiving antenna.

Increase the separation between the equipment and receiver.

Connect the equipment into an outlet on a circuit different from that to which the receiver is connected.

Consult the dealer or an experienced radio/TV technician for help.

WARNING: TO REDUCE THE RISK OF FIRE OR ELECTRIC SHOCK, DO NOT EXPOSE THIS APPLIANCE TO RAIN OR MOISTURE.

Caution— button!

Disconnect the mains plug to shut the power off completely (the STANDBY/ON lamp goes off). The  button in any position does not disconnect the mains line.

- When the unit is on standby, the STANDBY/ON lamp lights red.
- When the unit is turned on, the STANDBY/ON lamp lights green.

The power can be remote controlled.

Attention—Commutateur !

Déconnectez la prise d'alimentation secteur pour mettre l'appareil complètement hors tension (le témoin STANDBY/ON s'éteint).

L'interrupteur , sur n'importe quelle position, ne peut pas déconnecter l'appareil du secteur.

- Quand l'appareil est en mode de veille, le témoin STANDBY/ON est allumé en rouge.
- Quand l'appareil est sous tension, le témoin STANDBY/ON est allumé en vert.

L'alimentation peut être télécommandée.

CAUTION

To reduce the risk of electrical shocks, fire, etc.:

1. Do not remove screws, covers or cabinet.
2. Do not expose this appliance to rain or moisture.

ATTENTION

Afin d'éviter tout risque d'électrocution, d'incendie, etc.:

1. Ne pas enlever les vis ni les panneaux et ne pas ouvrir le coffret de l'appareil.
2. Ne pas exposer l'appareil à la pluie ni à l'humidité.

Note to CATV system installer:

This reminder is provided to call the CATV system installer's attention to Section 820-40 of the NEC which provides guidelines for proper grounding and, in particular, specifies that the cable ground shall be connected to the grounding system of the building, as close to the point of cable entry as practical.

For Canada/pour le Canada

CAUTION: TO PREVENT ELECTRIC SHOCK, MATCH WIDE BLADE OF PLUG TO WIDE SLOT, FULLY INSERT.

ATTENTION: POUR EVITER LES CHOCS ELECTRIQUES, INTRODUIRE LA LAME LA PLUS LARGE DE LA FICHE DANS LA BORNE CORRESPONDANTE DE LA PRISE ET POUSSER JUSQU'AU FOND.

For Canada/pour le Canada

THIS DIGITAL APPARATUS DOES NOT EXCEED THE CLASS B LIMITS FOR RADIO NOISE EMISSIONS FROM DIGITAL APPARATUS AS SET OUT IN THE INTERFERENCE-CAUSING EQUIPMENT STANDARD ENTITLED "DIGITAL APPARATUS," ICES-003 OF THE DEPARTMENT OF COMMUNICATIONS.

CET APPAREIL NUMERIQUE RESPECTE LES LIMITES DE BRUITS RADIOELECTRIQUES APPLICABLES AUX APPAREILS NUMIRIQUES DE CLASSE B PRESCRITES DANS LA NORME SUR LE MATERIEL BROUILLEUR: "APPAREILS NUMERIQUES", NMB-003 EDICTEE PAR LE MINISTRE DES COMMUNICATIONS.

Introduction

We would like to thank you for purchasing one of our JVC products. Before operating this unit, read this manual carefully and thoroughly to obtain the best possible performance from your unit, and retain this manual for future reference.

About This Manual

This manual is organized as follows:

- This manual mainly explains operations using the buttons on the remote control. You can use the buttons both on the remote control and on the unit for the same operations if they have the same or similar names (or marks), unless mentioned otherwise.
- Basic and common information that is the same for many functions is grouped in one place, and is not repeated for each procedure. For instance, we do not repeat the information about turning on/off the unit, setting the volume, changing the sound effects, and others, which are explained in the section “Basic and Common Operations” on pages 9 to 12.
- The following symbols are used in this manual:



Gives you warning and caution to prevent damage or risk of fire/electric shock. In addition, we put information here about conditions which will prevent getting the best possible performance from the unit.



Gives you information and hints you need to know.

Precautions

Installation

- Install in a place which is level, dry and neither too hot nor too cold—between 5°C (41°F) and 35°C (95°F).
- Install the unit in a location with adequate ventilation to prevent internal heat buildup.
- Leave sufficient distance between the unit and the TV.
- Keep the speakers away from the TV to avoid interference with TV.



DO NOT install the unit in a location near heat sources, or in a place subject to direct sunlight, excessive dust or vibration.

Power sources

- When unplugging the unit from the wall outlet, always pull on the plug, not the AC power cord.



DO NOT handle the AC power cord with wet hands.

Moisture condensation

Moisture may condense on the lenses inside the unit in the following cases:

- After starting to heat the room.
- In a damp room.
- If the unit is brought directly from a cold to a warm place. Should this occur, the unit may malfunction. In this case, leave the unit turned on for a few hours until the moisture evaporates, unplug the AC power cord, then plug it in again.

Others

- Should any metallic object or liquid fall into the unit, unplug the AC power cord and consult your dealer before operating any further.
- If you are not going to operate the unit for an extended period of time, unplug the AC power cord from the wall outlet.



DO NOT disassemble the unit since there are no user serviceable parts inside.

If anything goes wrong, unplug the AC power cord and consult your dealer.

Contents

Location of the Buttons and Controls	3
Front Panel	3
Remote Control	5
Getting Started	6
Unpacking	6
Connecting Antennas	6
Connecting Speakers	7
Connecting Other Equipment	8
Putting the Batteries into the Remote Control	8
Basic and Common Operations	9
Setting the Clock	9
Turning On the Power	10
Adjusting the Volume	11
Reinforcing the Bass Sound	11
Adjusting the Tone	12
Changing the Display Brightness	12
Listening to FM and AM Broadcasts.....	13
Tuning in to a Station	13
Presetting Stations	13
Tuning in to a Preset Station	14
Playing Back Discs on the 5-CD Changer	15
Loading Discs	15
Playing Back All the Discs—Continuous Play	16
Basic Disc Operations	16
Programing the Track Playing Order	
—Program Play	17
Playing at Random—Random Play	18
Repeating Tracks or Discs—Repeat Play	19
Prohibiting Disc Ejection	19
Playing Back Tapes.....	20
Playing Back a Tape	20
Prohibiting Cassette Ejection	20
Recording	21
Recording on a Tape	21
Recording Discs—Disc Synchronized Recording	22
Using the Timers	25
Using the Daily Timer and the Recording Timer	25
Using the Sleep Timer	27
Maintenance.....	28
Troubleshooting	29
Specifications	30

Location of the Buttons and Controls

Become familiar with the buttons and controls on your unit.

Front Panel

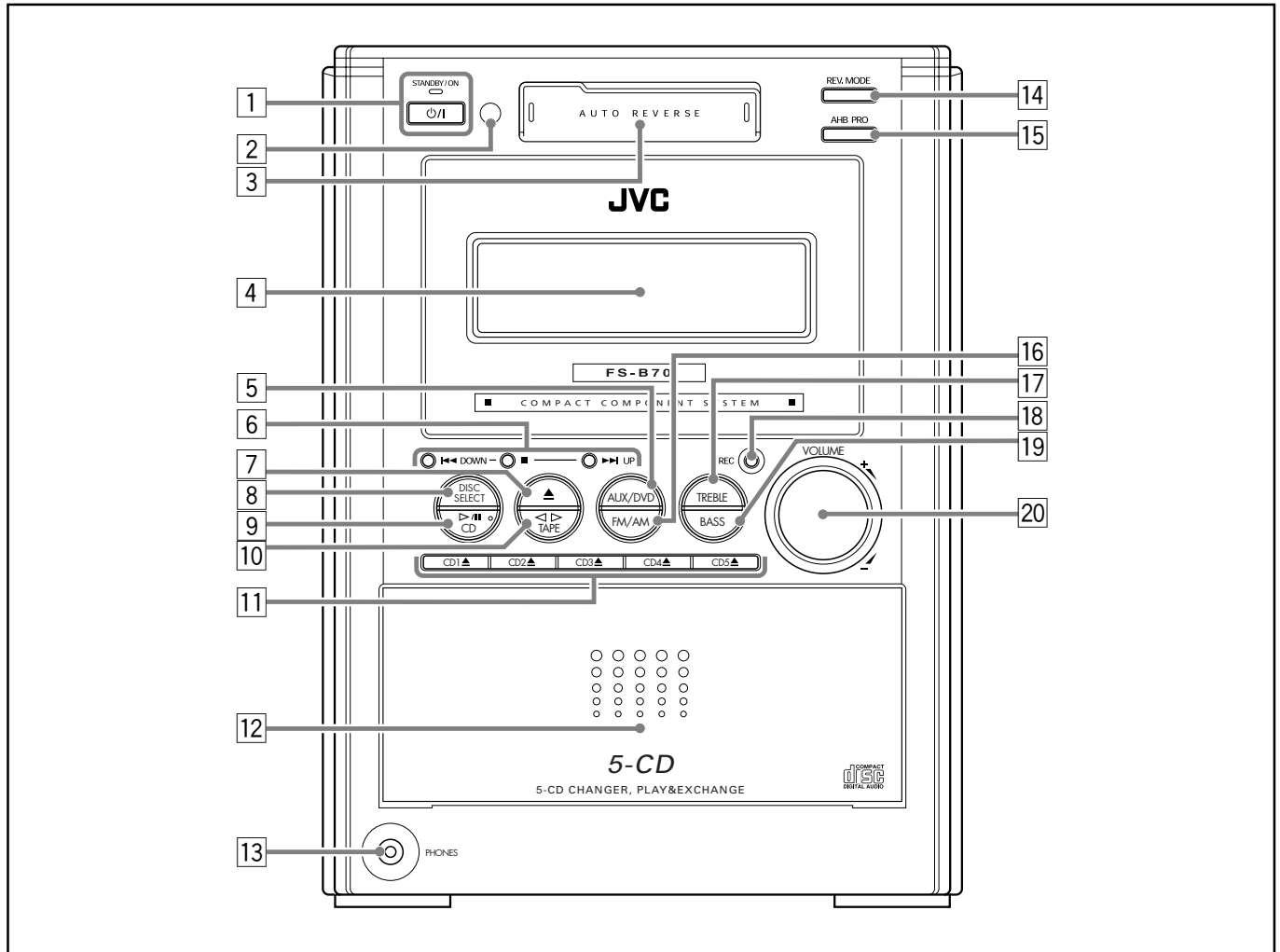

Front panel

See pages in parentheses for details.



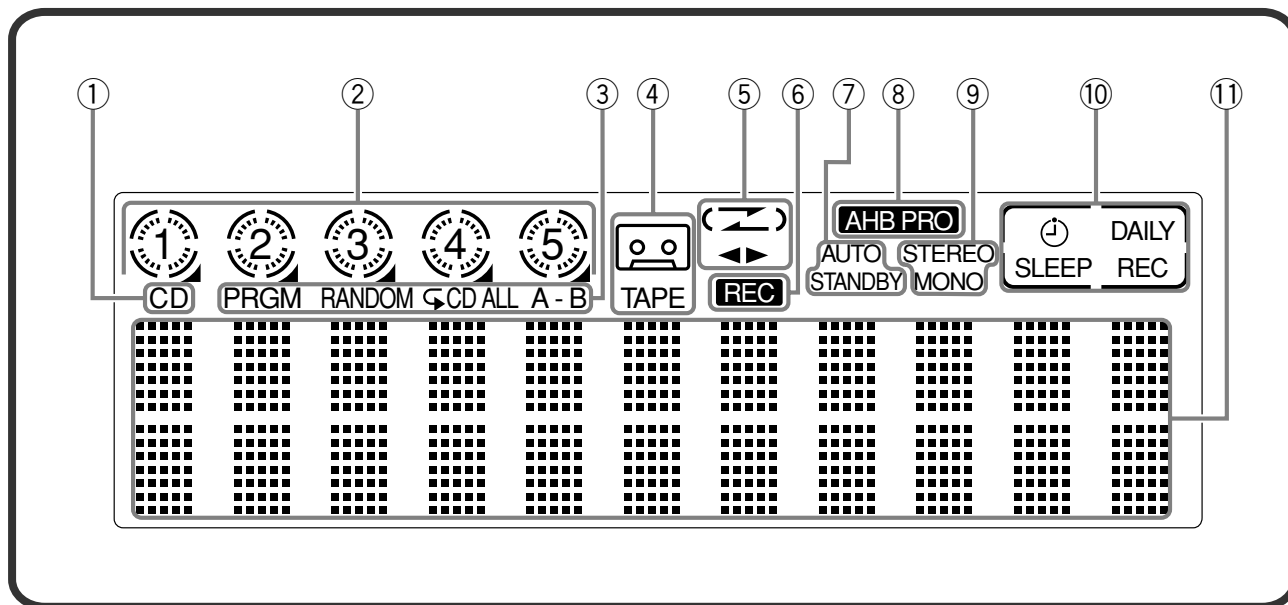

- | | |
|--|--|
| <p>1 ⏻/⏻ (standby/on) button and STANDBY/ON lamp (10, 19, 20, 26)</p> <p>2 Remote sensor (5)</p> <p>3 Cassette compartment (20)</p> <p>4 Display window (4)</p> <p>5 AUX/DVD button (10)</p> <ul style="list-style-type: none"> • Pressing this button also turns on the unit. <p>6 Multi operation buttons
 ⏮ DOWN, ■, and ⏭ UP</p> <p>7 ▲ (tape eject) button (20 – 24)</p> <ul style="list-style-type: none"> • Pressing this button also turns on the unit. <p>8 DISC SELECT button (16, 17, 22, 23)</p> <p>9 ▷/ CD button (10, 16, 22, 23)</p> <ul style="list-style-type: none"> • Pressing this button also turns on the unit. <p>10 ◁▷ TAPE button (10, 20, 21)</p> <ul style="list-style-type: none"> • Pressing this button also turns on the unit. | <p>11 Disc eject buttons (10, 15, 16)
 CD1▲, CD2▲, CD3▲, CD4▲, and CD5▲</p> <ul style="list-style-type: none"> • Pressing one of these buttons also turns on the unit and opens the corresponding disc tray. <p>12 Disc trays compartment (15)</p> <p>13 PHONES jack (11)</p> <p>14 REV.MODE (reverse mode) button (20, 21)</p> <p>15 AHB PRO (Active Hyper Bass Pro) button (11)</p> <p>16 FM/AM button (10, 13, 14)</p> <ul style="list-style-type: none"> • Pressing this button also turns on the unit. <p>17 TREBLE button (12)</p> <p>18 REC (recording) button (21 – 24)</p> <p>19 BASS button (12)</p> <p>20 VOLUME + / – control (11)</p> |
|--|--|

Display window on the front panel



Display window

See pages in parentheses for details.

- ① CD indicator (15)
- ② Disc indicators (15)
- ③ Disc play mode indicators (17 – 19)
 - PRGM (program), RANDOM, and Repeat mode (↶, ↷, CD, ALL, A-B)
- ④ TAPE indicator (20)
 -  indicator (20)
- ⑤ Tape operation indicators (20, 21)
 -   (tape direction) and  (reverse mode)
- ⑥ REC indicator (21 – 24)
- ⑦ AUTO STANDBY indicator (10)
- ⑧ AHB PRO (Active Hyper Bass Pro) indicator (11)
- ⑨ FM mode indicators (13)
 - STEREO and MONO
- ⑩ Timer indicators
 -  (timer) (9, 25, 26)
 - SLEEP (sleep timer) (27)
 - DAILY (daily timer) (9, 25, 26)
 - REC (recording timer) (9, 25, 26)
- ⑪ Main display
 - Shows the source name and other information.

Remote Control

See pages in parentheses for details.

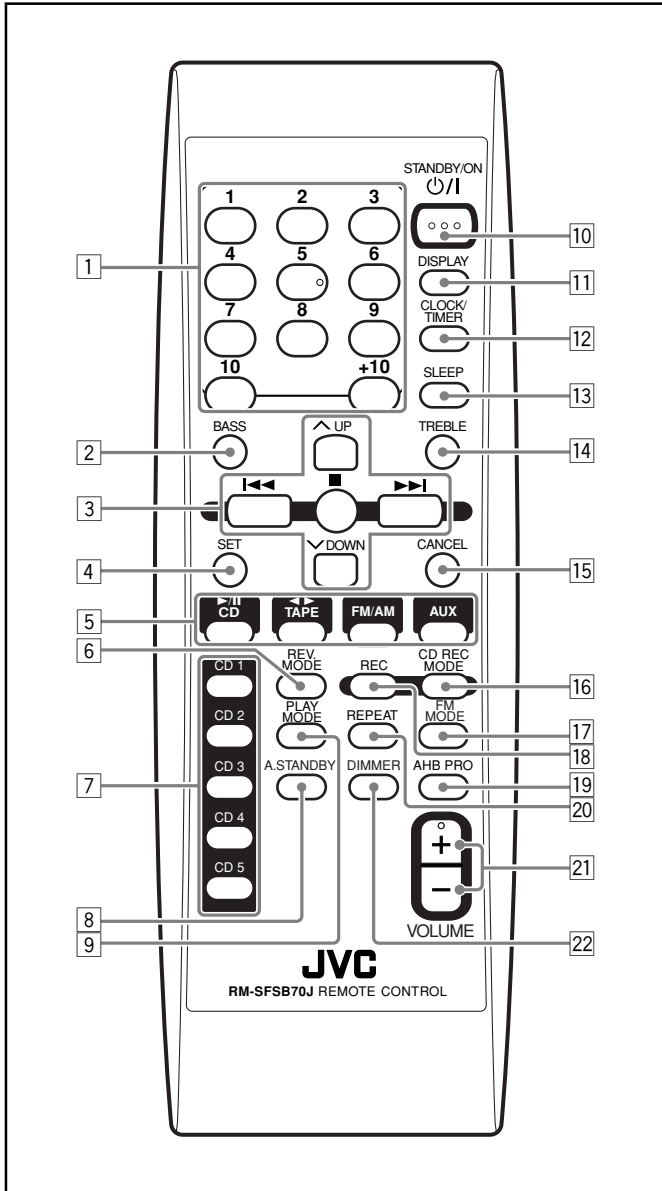

- 1 Number buttons
- 2 BASS button (12)
- 3 Multi operation buttons
 - ^ UP and v DOWN
 - ◀◀, ■, and ▶▶
- 4 SET button (13, 14, 19)
- 5 Source buttons
 - ▶/|| CD, ◀▶ TAPE, FM/AM, and AUX

Pressing one of these buttons also turns on the unit.
- 6 REV.MODE button (20, 21)
- 7 Disc number buttons (10, 16, 17, 22 – 24)
 - CD 1, CD 2, CD 3, CD 4, and CD 5

Pressing one of these buttons also turns on the unit and starts disc play if a disc is ready.
- 8 A.STANDBY (auto standby) button (10)
- 9 PLAY MODE button (17, 18)
- 10 STANDBY/ON ⏻/⏻ button (10, 26)
- 11 DISPLAY button (9)
- 12 CLOCK/TIMER button (9, 25, 26)
- 13 SLEEP button (27)
- 14 TREBLE button (12)
- 15 CANCEL button (18)
- 16 CD REC MODE (disc recording mode) button (22 – 24)
- 17 FM MODE button (13)
- 18 REC (recording) button (21 – 24)
- 19 AHB PRO (Active Hyper Bass Pro) button (11)
- 20 REPEAT button (19)
- 21 VOLUME + / - button (11)
- 22 DIMMER button (12)

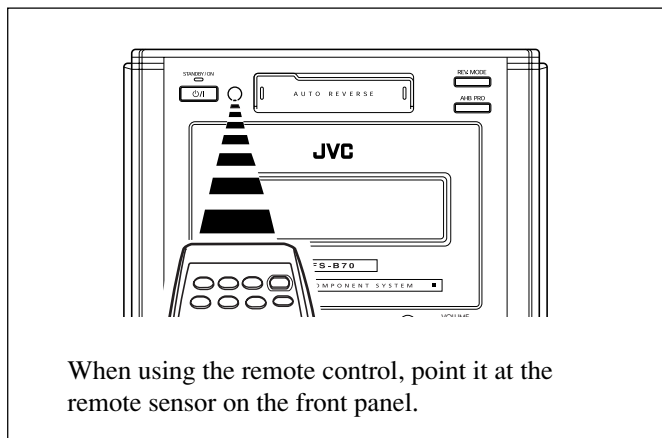

Unpacking

After unpacking, check to be sure that you have all the following items.

The number in parentheses indicates the quantity of each piece supplied.

- FM antenna (1)
- AM loop antenna (1)
- Remote control (1)
- Batteries (2)

If any item is missing, consult your dealer immediately.

Connecting Antennas

FM antenna

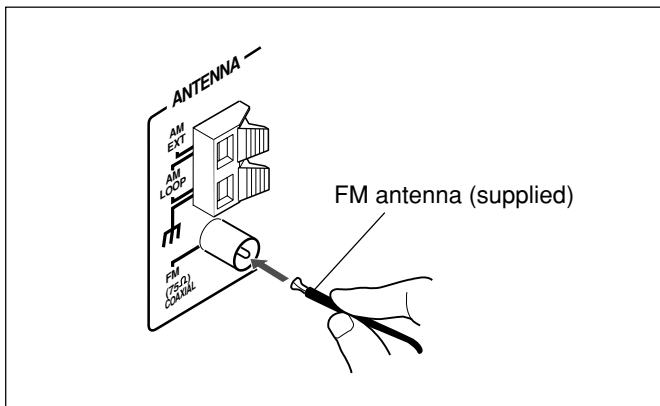

1 Attach the FM antenna to the FM (75 Ω) COAXIAL terminal.

2 Extend the FM antenna.

3 Fasten it up in a position which gives you the best reception, then attach it to the wall, etc.



About the supplied FM antenna

The FM antenna supplied with this unit can be used as a temporary measure. If reception is poor, you can connect an outdoor FM antenna.

To connect an outdoor FM antenna

Before connecting it, disconnect the supplied FM antenna.

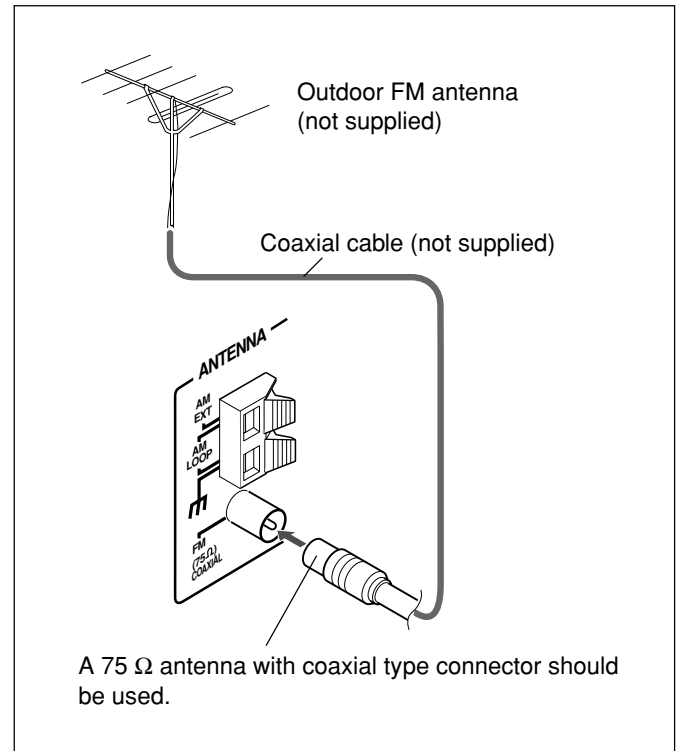

AM antenna

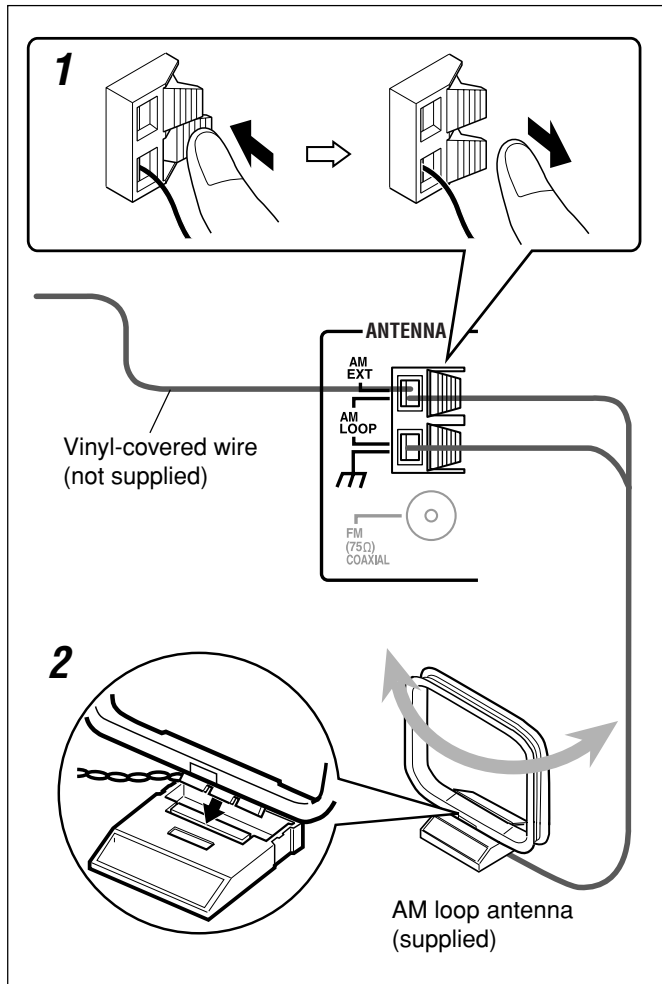

- 1** Connect the AM loop antenna to the AM LOOP terminals as illustrated.
- 2** Turn the AM loop antenna until you have the best reception.

To connect an outdoor AM antenna

When reception is poor, connect a single vinyl-covered wire to the AM EXT terminal and extend it horizontally. The AM loop antenna must remain connected.



For better reception of both FM and AM

- Make sure the antenna conductors do not touch any other terminals or connecting cords.
- Keep the antennas away from metallic parts of the unit, connecting cords, and the AC power cord.

Connecting Speakers

To connect speakers

You can connect the speakers using the speaker cords.

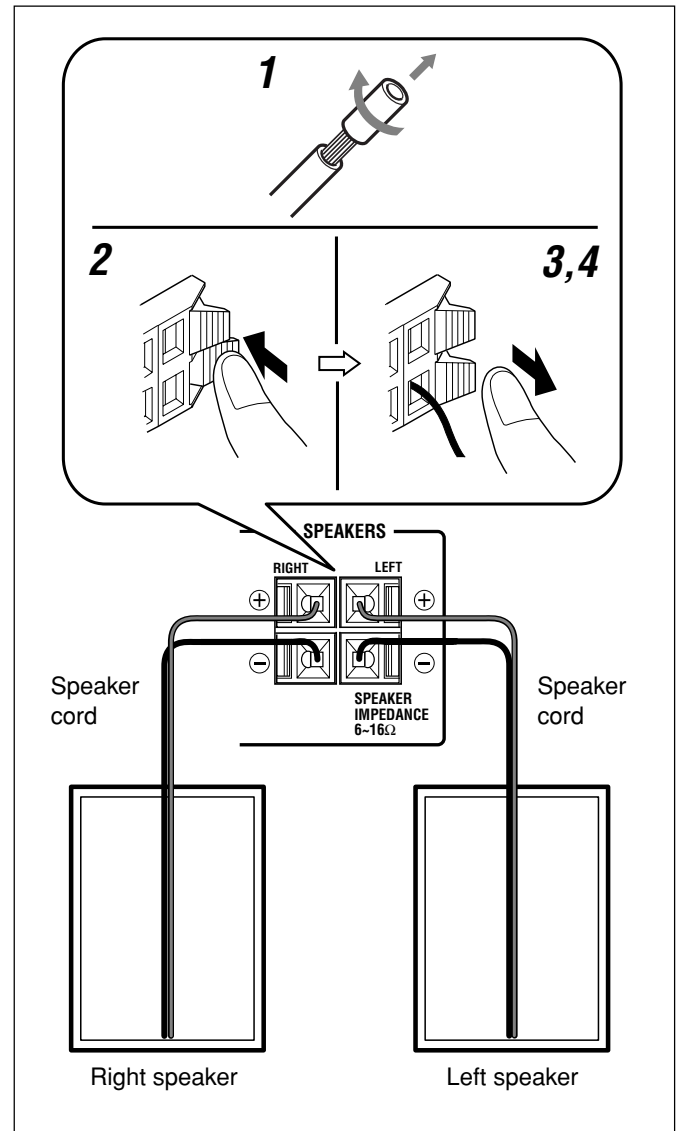

- 1** If the cords are covered with insulation, remove a short section of insulation at the end of each cord by twisting and pulling it off.
- 2** Hold the clamp of the speaker terminal.
- 3** Insert the end of the speaker cord into the terminal.
Match the polarity of the speaker terminals: \oplus to \oplus and \ominus to \ominus .
- 4** Release your finger from the clamp.

IMPORTANT:

- Use only speakers with the same speaker impedance as indicated by the speaker terminals on the rear of the unit.
- DO NOT connect more than one speaker to one speaker terminal.

To remove the speaker grilles

The speaker grilles are removable as illustrated below:

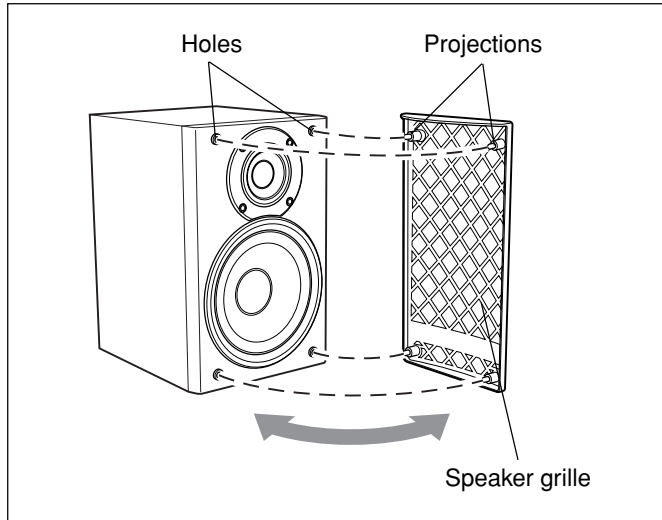

To remove the speaker grille, insert your fingers at the top of the speaker grille, then pull towards you. Also pull the bottom towards you.

To attach the speaker grille, follow the illustration above.

Connecting Other Equipment

You can connect audio equipment—used only as a playback device.



- DO NOT connect any equipment while the power is on.
- DO NOT plug in any equipment until all connections are complete.

To connect audio equipment

Be sure that the plugs of the audio cords are color coded: White plugs and jacks are for left audio signals, and red ones for right audio signals.

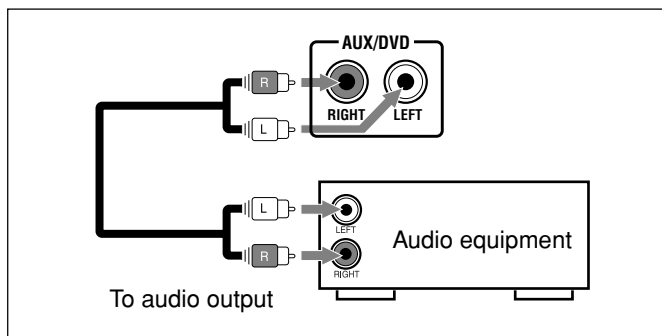

To play the other equipment through this unit, connect between the audio output jacks on the other equipment and AUX/DVD jacks by using audio cords (not supplied).

NOW you are ready to plug in the unit and any other connected equipment.

IMPORTANT:

Be sure to check that all connections have been made before plugging in the power cord.

Putting the Batteries into the Remote Control

Insert the batteries—R6(SUM-3)/AA(15F)—into the remote control by matching the polarity (+ and -) on the batteries with the + and - marking on the battery compartment. When the remote control can no longer operate the unit, replace both batteries at the same time.

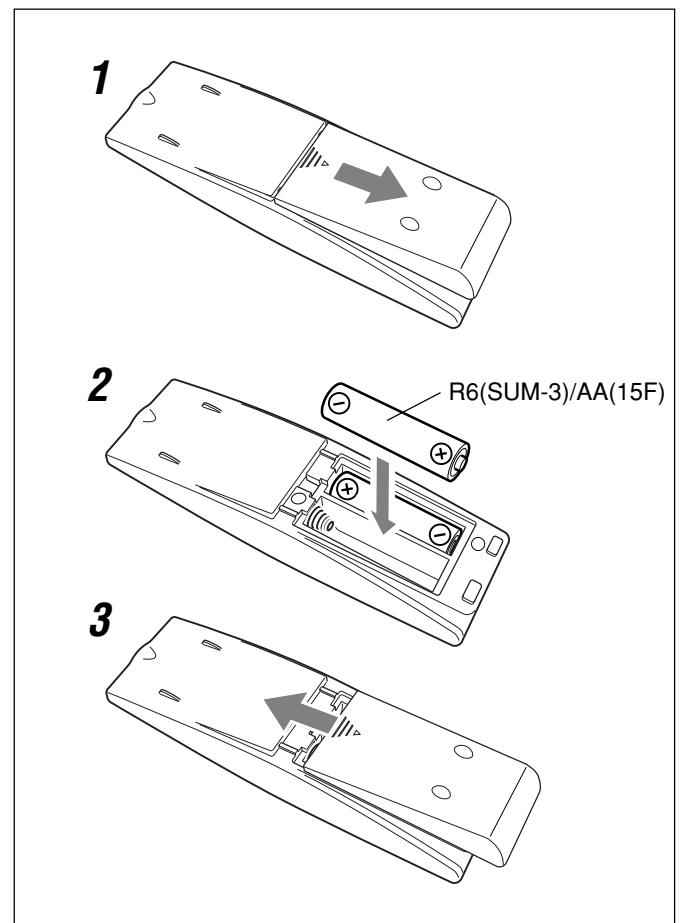

- DO NOT use an old battery together with a new one.
- DO NOT use different types of batteries together.
- DO NOT expose batteries to heat or flame.
- DO NOT leave the batteries in the battery compartment when you are not going to use the remote control for an extended period of time. Otherwise, the remote control will be damaged from battery leakage.

Basic and Common Operations

Setting the Clock

Before operating the unit any further, first set the unit's clock. When you plug in the power cord, "AM 12:00" starts flashing on the display.

You can set the clock when the unit is either turned on or in standby mode.

On the remote control ONLY:

1 Press CLOCK/TIMER.

The hour digits start flashing on the display.

AM 12:00



2 Press ^ UP or v DOWN to adjust the hour, then press CLOCK/TIMER.

The minute digits start flashing.

- When you press and hold ^ UP or v DOWN, the hour digit changes continuously.

PM 7:00

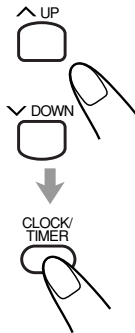

3 Press ^ UP or v DOWN to adjust the minute, then press CLOCK/TIMER.

The built-in clock starts.

PM 7:12



- **When you unplug the power cord or if a power failure occurs**
The clock is reset to "AM 12:00" right away. If this happens, set the clock again.
- **The clock may gain or lose 1 to 2 minutes per month**
If this happens, reset the clock.

To show the clock when the unit is turned on

On the remote control ONLY:

Press DISPLAY.

The clock indication appears on the display.

To return to the normal display, press DISPLAY again.

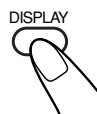

To change the clock

- 1 **Make sure the ☹ (timer) indicator and the timer mode indicator (DAILY or REC) are not lit on the display.**
 - If they are lit, press and hold CLOCK/TIMER until they go off.
- 2 **Press CLOCK/TIMER repeatedly until the unit enters the clock setting mode (the hour digits start flashing on the display).**
First time you press CLOCK/TIMER, the unit enters the timer setting mode. (See page 25.)
- 3 **Repeat steps 2 and 3 of the procedure "Setting the Clock."**
- 4 **Press and hold CLOCK/TIMER again so that the ☹ (timer) indicator and the timer mode indicator (DAILY or REC) go off.**

To turn off the clock indication (power save mode)

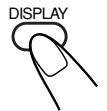

On the remote control ONLY:

Press DISPLAY while the unit is in standby mode. "DISPLAY OFF" appears on the display and the clock indication goes off.





To turn on the clock indication, press DISPLAY again while the unit is in standby mode. "DISPLAY ON" appears on the display.



Turning On the Power

To turn on the unit, press STANDBY/ON  (or  on the unit).

The STANDBY/ON lamp on the unit lights green.

- When you press the source button—/|| CD,  TAPE, FM/AM and AUX (or AUX/DVD on the unit), the unit automatically turns on and starts playback if the source is ready.
- Pressing one of the disc eject buttons (CD1▲ – CD5▲) also turns on the unit. (See page 15.)
- Pressing ▲ (tape eject) also turns on the unit. (See page 20.)
- Pressing one of the disc number buttons (CD 1 – CD 5) on the remote control also turns on the unit and starts playback if discs are on the corresponding disc trays. (See page 16.)



To turn off the unit (standby), press STANDBY/ON  (or  on the unit) again.

The STANDBY/ON lamp on the unit lights red.

- “AM 12:00” flashes on the display until you set the built-in clock. After setting the clock, the clock time will appear on the display while the unit is on standby.
- A little power is always consumed even while the unit is in standby mode.

To switch off the power supply completely, unplug the AC power cord from the AC outlet.



When you unplug the AC power cord or if a power failure occurs

The clock is reset to “AM 12:00” right away, while the tuner preset stations will be erased in a few days.

To turn off the unit automatically (Auto Standby)

Using the Auto Standby function, the unit automatically turns itself off if no sound comes in for more than 3 minutes when “CD” or “TAPE” is selected as the source.

If an operation is done within this 3-minute period, the Auto Standby function is canceled temporarily even though no sound comes in.

- You can also turn off the unit automatically by using the sleep timer. (See page 27.)

On the remote control ONLY:

To activate the Auto Standby function, press A.STANDBY.

The AUTO STANDBY indicator lights up on the display.

- When no sound comes in, the AUTO STANDBY indicator starts flashing on the display. About 5 seconds before the unit turns itself off, “AUTO STANDBY” starts flashing on the display.

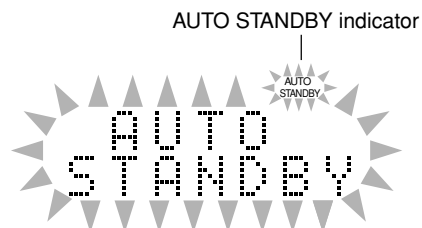

To deactivate the Auto Standby function, press A.STANDBY.

The AUTO STANDBY indicator goes off.

Adjusting the Volume

You can adjust the volume level only while the unit is turned on. The volume level can be adjusted between “VOLUME MIN” and “VOLUME 1” – “VOLUME 40 (VOLUME MAX).”

- The volume level has no effect on recording.

On the remote control:

To increase the volume, press VOLUME +.

To decrease the volume, press VOLUME –.

- When you press and hold either button, you can change the volume level continuously.



On the unit:

To increase the volume, turn the VOLUME + / – control clockwise.

To decrease the volume, turn the VOLUME + / – control counterclockwise.

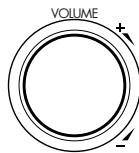

VOLUME 10



For private listening

Connect a pair of headphones to the PHONES jack. No sound comes out of the speakers. Be sure to turn down the volume before connecting or putting on the headphones.



DO NOT turn off (standby) the unit with the volume set to an extremely high level; Otherwise, the sudden blast of sound can damage your hearing, speakers and/or headphones when you turn on the unit or start playing any source. REMEMBER you cannot adjust the volume level while the unit is in standby mode.

Reinforcing the Bass Sound

The richness and fullness of the bass sound is clearly maintained regardless of how low you set the volume —Active Hyper Bass Pro.

- This function also affects the sound from headphones.
- This function only affects the playback sound, and does not affect your recording.

To get the effect, press AHB PRO repeatedly so that “AHB BASS1” or “AHB BASS2” appears on the display.

The **AHB PRO** indicator also lights up on the display.

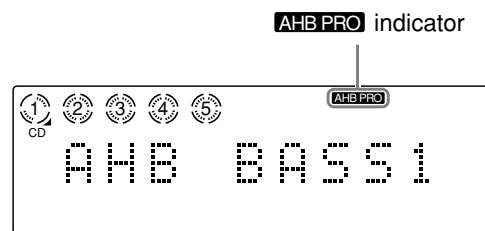

- Each time you press the button, the Active Hyper Bass Pro mode changes as follows:

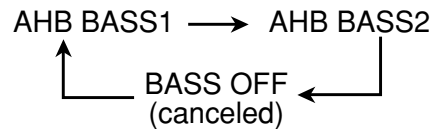

- “AHB BASS2” is more effective than “AHB BASS1.”

To cancel the effect, press AHB PRO repeatedly until “BASS OFF” appears on the display.

The **AHB PRO** indicator goes off.

Adjusting the Tone

You can adjust the bass level (low frequency range) and the treble level (high frequency range) within a range of “-5” to “+5.”

When shipped, each level is set to “+2.”

- This function also affects the sound from headphones.
- This function only affects the playback sound, and does not affect your recording.
- There is a time limit in doing the following steps. If the setting is canceled before you finish, start again from step 1.

On the remote control:

- 1 Press **BASS** to adjust the bass level or press **TREBLE** to adjust the treble level.

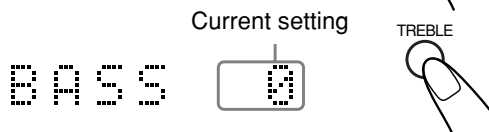

- 2 Press **^ UP** to increase the level or press **∨ DOWN** to decrease the level.



On the unit:

- 1 Press **BASS** to adjust the bass level or press **TREBLE** to adjust the treble level.

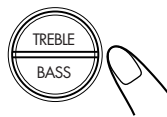

- 2 Press **▶▶ UP** to increase the level or press **◀◀ DOWN** to decrease the level.

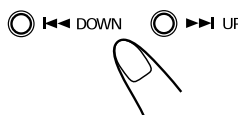

Changing the Display Brightness

You can change the display brightness only while the unit is turned on.

On the remote control ONLY:

Press **DIMMER** while the unit is turned on.

- Each time you press the button, the display brightness changes as follows:



DIMMER 1: The display illumination dims.



DIMMER 2: The display illumination dims and the blue illumination on the display disappears.



DIMMER OFF: The display and blue illumination resumes.



(back to the beginning)



Turning off the unit (standby) sets the display brightness back to “DIMMER OFF.”

Listening to FM and AM Broadcasts

Tuning in to a Station

1 Press FM/AM to select either “FM” or “AM.”

The unit automatically turns on and tunes in to the previously received station—either FM or AM.

- Each time you press the button, the band alternates between FM and AM.

FM 87.5 MHz



2 Press and hold >>> or <<< (or >>> UP or <<< DOWN on the unit) for more than 1 second.

- >>> (>>> UP): Increases the frequencies.
- <<< (<<< DOWN): Decreases the frequencies.

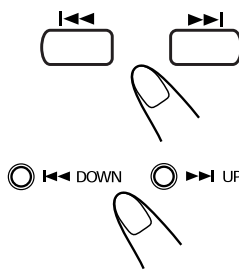

The unit starts searching for stations and stops when a station of sufficient signal strength is tuned in.

- If an FM program is broadcast in stereo, the STEREO indicator lights up on the display (only when the reception is good).

To stop during searching, press >>> or <<< (or >>> UP or <<< DOWN on the unit).



When you repeatedly press >>> or <<< (or >>> UP or <<< DOWN on the unit)

The frequency changes step by step.

To change the FM reception mode

On the remote control ONLY:

When an FM stereo broadcast is hard to receive or noisy, press FM MODE so that the MONO indicator lights up on the display. Reception will improve.

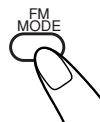

To restore the stereo effect, press FM MODE again so that the MONO indicator goes off. In stereo mode, you can hear stereo sound when a stereo program is broadcast.

Presetting Stations

You can preset 30 FM and 15 AM stations manually.

In some cases, test frequencies have been already stored for the tuner since the factory examined the tuner preset function before shipment. This is not a malfunction. You can preset the stations you want into memory by following the presetting method.

- There is a time limit in doing the following steps. If the setting is canceled before you finish, start again from step 2.

On the remote control ONLY:

1 Press FM/AM to select either “FM” or “AM.”

The unit automatically turns on and tunes in to the previously received station—either FM or AM.

- Each time you press the button, the band alternates between FM and AM.

FM 87.5 MHz



2 Press SET.

“SET” starts flashing on the display.

FM SET 87.5 MHz



3 Press ^ UP or v DOWN to select a preset number.

FM 14 87.5 MHz

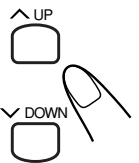

You can also select the preset number by the number buttons.

Ex.: For preset number 5, press 5.

For preset number 15, press +10, then 5.

For preset number 20, press +10, then 10.

For preset number 30, press +10, +10, then 10.

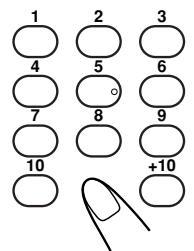

4 Press SET again.

“STORED” appears on the display for a while.

STORED

The tuned station in step 1 is stored in the preset number selected in step 3.

- Storing a new station on an already assigned number erases the previously stored one.



To tune in to a preset station directly using the number buttons

On the remote control ONLY:

Pressing the number button(s) allows you to select the preset number you want.

Ex.: For preset number 5, press 5.

For preset number 15, press +10, then 5.

For preset number 20, press +10, then 10.

For preset number 30, press +10, +10, then 10.

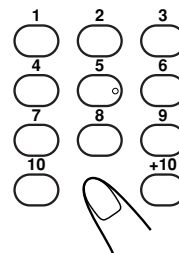

When you unplug the AC power cord or if a power failure occurs

The FM and AM preset stations will be erased in a day. If this happens, preset the stations again.

Tuning in to a Preset Station

On the remote control ONLY:

1 Press FM/AM to select either “FM” or “AM.”

The unit automatically turns on and tunes in to the previously received station—either FM or AM.

- Each time you press the button, the band alternates between FM and AM.



2 Press ^ UP or v DOWN to select a preset number.

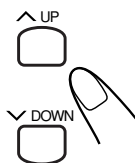

Playing Back Discs on the 5-CD Changer

This unit has been designed to play back the following discs—CD, CD-R, and CD-RW.

When playing a CD-R or CD-RW

User-edited CD-Rs (CD-Recordable) and CD-RWs (CD-ReWritable) can be played only if they are already “finalized.”

- Usually you can play back your original CD-Rs or CD-RWs recorded in music CD format. However, sometimes they may not play depending on their characteristics or recording conditions.
- Before playing CD-Rs or CD-RWs, read their instructions or cautions carefully.
- Some CD-Rs or CD-RWs may not play on this unit because of their disc characteristics, damage or stain on them, or if the player’s lens is dirty.
- CD-RWs may require a longer readout time. This is because the reflectance of CD-RWs is lower than for regular discs.

General notes

- In general, you will have the best performance by keeping your discs and the mechanism clean.
- Store discs in their cases, and keep them in cabinets or on shelves.
 - Keep the unit’s disc trays closed when not in use.

Continued use of irregular shape discs (heart-shape, octagonal, etc.) can damage the unit.



About the disc indicators

Disc number indicator



While playback is stopped.

Current disc indicator



During playback

1

When no disc is on the tray.

- When the current source is “CD,” the CD indicator also lights up on the display.

Loading Discs

On the unit ONLY:

- 1 Press one of the disc eject buttons (CD1▲ – CD5▲) for the disc tray you want to load a disc onto.

The unit automatically turns on and the selected disc tray comes out.



- 2 Place a disc correctly on the circle of the disc tray, with its label side up.

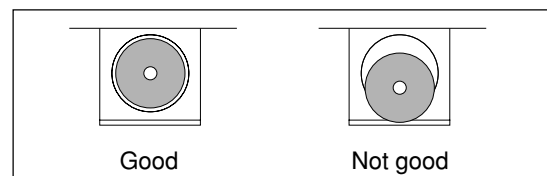
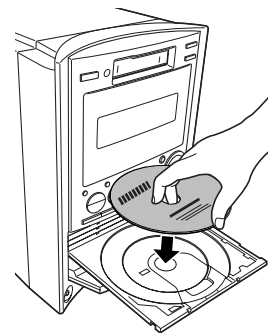

- When using a CD single (8 cm), place it on the inner circle of the disc tray.

- 3 Press the same disc eject button (CD1▲ – CD5▲) you have pressed in step 1.

The disc tray closes.



When loading more than one disc at a time

Press the disc eject button (CD1▲ – CD5▲) for the next tray you want to place a disc onto. The first disc tray automatically closes and the next disc tray comes out.

Playing Back All the Entire Discs —Continuous Play

You can play discs continuously.

1 Load discs into the 5-CD Changer.

2 Select a disc and start playback.

On the remote control:

Press one of the disc number buttons (CD 1 – CD 5).

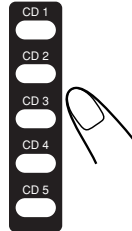

On the unit:

1 Press DISC SELECT repeatedly to select the disc you want.



2 Press  CD.



Playback starts from the first track of the selected disc.

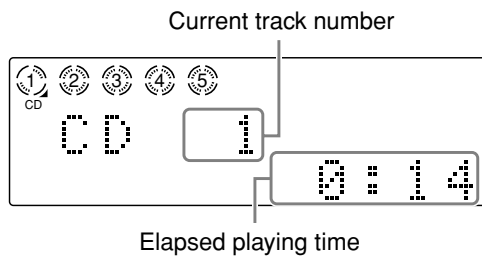

- Without selecting the disc number, pressing  CD starts playing back the currently selected disc.

To stop play for a moment, press  CD.

While pausing, the elapsed playing time flashes on the display.

To resume play, press  CD again.



To stop during play, press .



To remove discs, press the corresponding disc eject buttons (CD1▲ – CD5▲) on the unit.



Disc playback sequence in the 5-CD Changer

When 5 discs are loaded on the disc trays*, they are played in the following sequence:

Ex.: When playback is started from the CD 2 tray:

CD 2 ⇒ CD 3 ⇒ CD 4 ⇒ CD 5 ⇒ CD 1 (then stops)

* If no disc is on the disc tray, 5-CD Changer skips that tray.

To start Continuous Play while a source other than "CD" is selected

On the unit ONLY:

1 Press DISC SELECT while listening to a source other than "CD."



The following indication appears on the display.



- Each time you press the button, the disc tray number changes as follows:

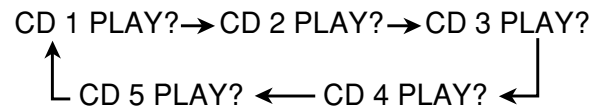

2 Press  CD while the indication in step 1 still remains on the display.

Now the source is changed to "CD" and Continuous Play starts from the selected disc.



Basic Disc Operations

To exchange a disc during playback of another disc

On the unit ONLY:

Press the disc eject buttons (CD1▲ – CD5▲) to eject a disc not currently playing.



If discs are exchanged during playback, playback will stop after playing all newly inserted discs.

To start playing a disc during playback of another disc

On the remote control:

Press one of the disc number buttons (CD 1 – CD 5).

The selected disc starts to play.

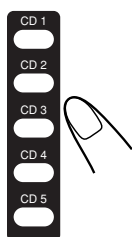

On the unit:

Press DISC SELECT repeatedly.

Each time you press the button, the next disc is selected.



To locate a particular point in a track during play

On the remote control:

Press and hold ►►► or ◄◄◄.

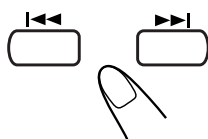

On the unit:

Press and hold ►►► UP or ◄◄◄ DOWN.

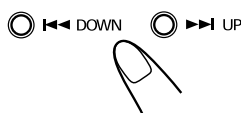

- ►►► (►►► UP): Fast-forwards the tracks.
- ◄◄◄ (◄◄◄ DOWN): Fast-reverses the tracks.

To go to another track

On the remote control:

Press ►►► or ◄◄◄ repeatedly.

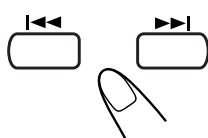

On the unit:

Press ►►► UP or ◄◄◄ DOWN repeatedly.

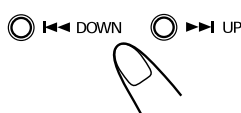

- ►►► (►►► UP): Skips to the beginning of the next or succeeding tracks.
 - You can skip to tracks on the next disc.
- ◄◄◄ (◄◄◄ DOWN): Goes back to the beginning of the current or previous tracks.
 - You cannot skip back to tracks on the previous disc.

To go to another track directly using the number buttons

On the remote control ONLY:

Pressing the number button(s) allows you to start playing the track number on the current disc.

Ex.: For track number 5, press 5.

For track number 15, press +10, then 5.

For track number 20, press +10, then 10.

For track number 30, press +10, +10, then 10.

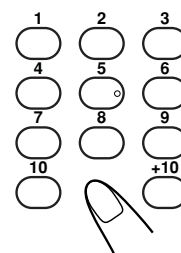

Programming the Track Playing Order —Program Play

You can arrange the order in which the tracks play before you start playing. You can program up to 32 tracks.

- In the Program Play mode, you cannot exchange a disc. (You cannot open the disc trays.)

On the remote control ONLY:

1 Load discs into the 5-CD Changer.

- If the current playing source is not “CD,” press ►/|| CD, then ■ before going to the next step.

2 Press PLAY MODE repeatedly until “CD PROGRAM” appears on the display.

The PRGM indicator also lights on the display.

PRGM indicator



- Each time you press the button, play mode changes as follows:



3 Press one of the disc number buttons (CD 1 – CD 5) to select the disc number you want to play.

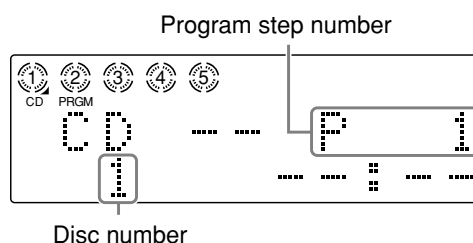

4 Press the number buttons to select a track from the disc selected in the above step.

- For how to use the number buttons, see “To go to another track directly using the number buttons” on the previous page.

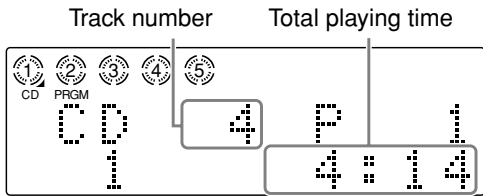
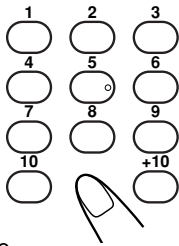

If you try to program a 33rd track “MEMORY FULL” will appear on the display.



When “NO PROGRAM” appears on the display

- You are trying to program a track from an empty tray, or a track number that does not exist on the disc.
- You are selecting the disc that the unit has not read yet.



If the total playing time exceeds 100 minutes

The total playing time on the display will not be shown. “-- : --” will appear.

5 Program other tracks you want.

- To program tracks from the same disc, repeat step 4.
- To program tracks from a different disc, repeat steps 3 and 4.

6 Press ►/|| CD.

The tracks are played in the order you have programmed.



To stop during play, press ■.



To exit from the Program Play mode, before or after play, press PLAY MODE once or twice so that the unit enters another disc playback mode (Random Play or Continuous Play). The PRGM indicator goes off.



- Turning off the unit also cancels Program Play and changes the disc playback mode to Continuous Play.

To check the program contents

Before playing, you can check the program contents by pressing ►►| or |◄◄.

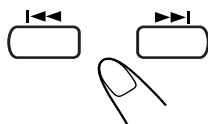

- ►►|: Shows the programmed tracks in the programmed order.
- |◄◄: Shows them in the reverse order.
 - Pressing |◄◄ first time after you have programmed shows the first track in the program.

To modify the program

Before playing, you can erase the last programmed track by pressing CANCEL.

Each time you press the button, the last programmed track is erased from the program.



To add tracks to the program before playing, simply select disc numbers and track numbers you want to add by following steps 3 and 4.

- In the Program Play mode, you cannot exchange a disc to add tracks on another disc to the program. (You cannot open the disc trays.)

Playing at Random—Random Play

The tracks of all loaded discs will play at random.

On the remote control ONLY:

1 Load discs into the 5-CD Changer.

- If the current playing source is not “CD,” press ►/|| CD, then ■ before going to the next step.

2 Press PLAY MODE repeatedly until “CD RANDOM” appears on the display.

The RANDOM indicator also lights on the display.

RANDOM indicator



- Each time you press the button, play mode changes as follows:

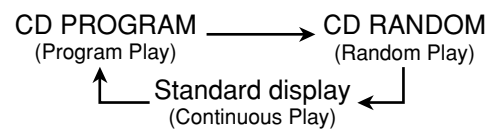

3 Press ►/|| CD.

The tracks are played at random. Random Play stops when all the tracks are played once.



To stop during play, press ■.

- Opening a disc tray also stops and cancels Random Play.

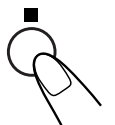

To skip the current track, press ►►|.

- The |◄◄ button does not work during Random Play.

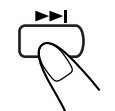

To exit from the Random Play mode, before or after play, press PLAY MODE once or twice so that the unit enters another disc playback mode (Continuous Play or Program Play).



The RANDOM indicator goes off.

- Turning off the unit also cancels Random Play and changes the disc playback mode to Continuous Play.

Repeating Tracks or Discs—Repeat Play

You can repeat each track, each disc, or all discs in the 5-CD Changer as many times as you like. You can also repeat your program.

On the remote control ONLY:

Press REPEAT repeatedly during or before playing.



CD
REPEAT 1

- Each time you press the button, the Repeat Play mode changes and appears on the display as follows:

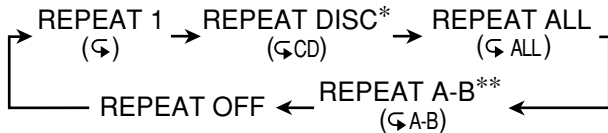

- “REPEAT 1”: Repeats one track.
- “REPEAT DISC”*: Repeats all tracks on one disc.
- “REPEAT ALL”: Repeats all tracks on all discs (continuously or at random), or all tracks in the program.
- “REPEAT A-B”**: Repeats the selected portion. (See the right column.)
- “REPEAT OFF”: Cancels Repeat Play.

* “REPEAT DISC” is not used for Program Play or Random Play.

** “REPEAT A-B” appears only during play.

A-B Repeat Play

While playing, you can select a portion of sound you want to repeat.

- During Program Play (see page 17) or Random Play (see page 18), you cannot perform A-B Repeat Play.

On the remote control ONLY:

1 Press REPEAT repeatedly during play to select “REPEAT A-B.”

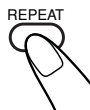

“A” starts flashing.

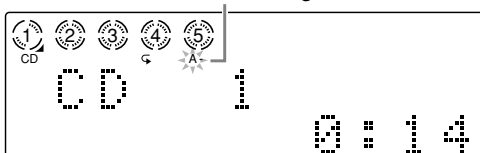

2 Press SET at the starting point from which you want to repeat (point A).



“B” starts flashing.

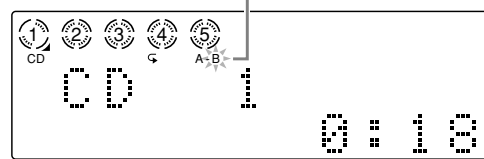

3 Press SET again at the end point to which you want to repeat (point B).



The unit automatically locates point A and starts repeating the portion between points A and B.

To cancel A-B Repeat Play, press REPEAT to select “REPEAT OFF.” A-B Repeat Play is canceled and normal playback continues from that point.



More about A-B Repeat Play

- A-B Repeat Play will be canceled in the following case:
 - When you press ►► or ◀◀.
 - When you press ►/|| CD.
- A-B Repeat Play is possible only within the same disc.

Prohibiting Disc Ejection

You can prohibit disc ejection from the unit and can lock discs—Disc Lock.

You can lock or unlock discs when the unit is either turned on or in standby mode.

On the unit ONLY:

To prohibit disc ejection, while holding ■, press ⏻/I.



“LOCKED” appears on the display for a while, and the loaded discs are locked.

- The loaded cassette is also locked. (See page 20.)

LOCKED

If you try to eject a locked disc, “LOCKED” appears to inform you that the Disc Lock is in use.

To cancel the prohibition and unlock the disc, repeat the above procedure.

“UNLOCKED” appears on the display for a while, and the loaded discs are unlocked.

Playing Back Tapes

Playing Back a Tape

You can play back type I tapes.

1 Insert a cassette into the cassette compartment with the exposed part of the tape facing left.

- When the unit is turned on, the [] and tape operation indicators appear on the display.

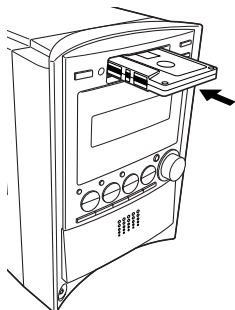

2 Press ◀▶ TAPE.

Playback starts (if the unit is in standby, the unit automatically turns on).

To change the tape direction, press ◀▶ TAPE.

- Each time you press the button, the tape direction changes as follows:

- ▢ : Plays the front side.
- ▣ : Plays the reverse side.

Tape direction and Reverse Mode indicators

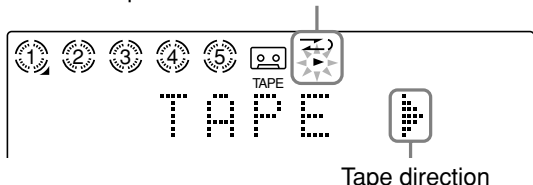

When the tape plays to the end, the deck automatically stops if the reverse mode is set to ◀▶ or ◀▶. (See "To play both sides—Reverse Mode" on the right column.)

To stop during play, press ■.

To fast-wind or rewind the tape, press ◀◀ or ▶▶ (or ▶▶ UP or ◀◀ DOWN on the unit).

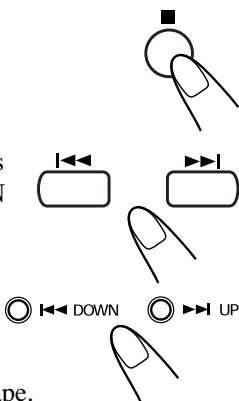

- When the tape direction is ▢
 - ▶▶ (▶▶ UP): Fast-winds the tape.
 - ◀◀ (◀◀ DOWN): Rewinds the tape.
- When the tape direction is ▣
 - ◀◀ (◀◀ DOWN): Fast-winds the tape.
 - ▶▶ (▶▶ UP): Rewinds the tape.

The tape direction indicator (▶ or ◀) starts flashing rapidly on the display.

To remove the cassette, push ▲ on the unit. The [] and tape operation indicators go off.



Pressing ▲ (tape eject) button also turns on the unit.

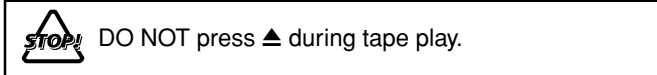

To play both sides—Reverse Mode

You can set the deck to play just one side or both sides of a tape once, or both sides continuously.

Press REV.MODE (reverse mode).

- Each time you press the button, the reverse mode changes as follows:

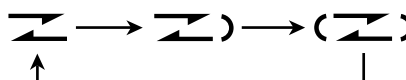

- ▢ : Plays back only one side (front or reverse).
- ▣ : Plays back the front and reverse sides once.
- (▢) : Plays back both front and reverse sides continuously.

STOP!

- The use of C-120 or longer tape is not recommended, since characteristic deterioration may occur and this tape easily jams in the pinch rollers and the capstans.
- You can also play back type II and type IV tapes; however, the sound quality (tone) may not be reproduced properly.

Prohibiting Cassette Ejection

You can prohibit cassette ejection from the unit and can lock the cassette in the cassette compartment—Cassette Lock. You can lock or unlock the cassette when the unit is either turned on or in standby mode.

On the unit ONLY:

To prohibit cassette ejection, while holding ■, press ◻/1.



"LOCKED" appears on the display for a while, and the loaded cassette is locked.

- The loaded discs are also locked. (See page 19.)

LOCKED

If you try to eject a locked cassette, "LOCKED" appears to inform you that the Cassette Lock is in use.

To cancel the prohibition and unlock the cassette, repeat the above procedure.

"UNLOCKED" appears on the display for a while, and the loaded cassette is unlocked.

Recording

IMPORTANT:

- It should be noted that it may be unlawful to re-record pre-recorded tapes, records, or discs without the consent of the owner of copyright in the sound or video recording, broadcast or cable program and in any literary, dramatic, musical, or artistic embodied therein.
- The recording level is automatically set correctly, so it is not affected by the other sound settings. Thus, during recording you can adjust the sound you are actually listening to without affecting the recording level.
- If recordings you have made have excessive noise or static, the unit may be too close to a TV. Increase the distance between the TV and the unit.
- You can only use type I tape for recording.

 DO NOT use type II and type IV tapes since the unit is not compatible with such tapes.

 The use of C-120 or longer tape is not recommended, since characteristic deterioration may occur and this tape easily jams in the pinch rollers and the capstans.



At the start and end of cassette tapes

There is leader tape which cannot be recorded onto. Thus, when recording from discs, FM/AM broadcasts, or external equipment, wind the leader tape first to ensure that the recording will be made without losing any music.

To protect your recordings

Cassettes have two small tabs on the back to protect against unexpected erasure or re-recording.

To protect your recording, remove these tabs.

To re-record on a protected tape, cover the holes with adhesive tape.

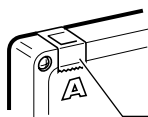

Adhesive tape

Recording on a Tape

1 Insert a recordable cassette into the cassette compartment with the exposed part of the tape facing left.

- See also page 20.

2 Check the recording direction for the tape.

- If the tape direction is not correct, press ◀▶ TAPE twice then ■ to change the tape direction.
- If you want to record on both sides of a tape, see “To record on both sides—Reverse Mode” below.

3 Start playing the source—FM, AM or auxiliary equipment connected to AUX/DVD jacks.

- When recording from discs, see “Recording Discs—Disc Synchronized Recording” on page 22.

4 Press REC (recording).

The REC (recording) indicator lights up on the display and recording starts.

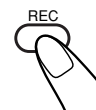

“NO REC” will appear on the display when you press REC in the following cases:

- If no cassette is inserted.
- If a protected tape is inserted.
- If any tray is open when the source is the CD player.

To stop while recording, press ■.



To remove the cassette, press ▲ on the unit.



To record on both sides—Reverse Mode

On the remote control ONLY:

Press REV.MODE (reverse mode) repeatedly so that the Reverse Mode indicator lights up like—Z) or (Z).

- The Reverse Mode indicator lights up on the display like—Z) while recording.
- Make sure that the tape direction is set to the forward (▶) direction before starting to record. Otherwise, recording will stop when only one side (reverse) of the tape is recorded.



To cancel the Reverse Mode, press the button so that the Reverse Mode indicator lights up like—Z .

Recording Discs

—Disc Synchronized Recording

You have three methods to record from discs onto a tape. Using the synchronized recording methods, you can start and stop disc play and recording at the same time.

- **One Disc Synchronized Recording**—Records the entire disc.
- **All Discs Synchronized Recording**—Records all loaded discs continuously (Continuous Play) or at random (Random Play), or the program you have made (Program Play). See page 23.
- **First Track Recording**—Records the first track of each disc. See page 24.
- **One Track Recording**—Records just the track you want during play. See page 24.
- Set the Reverse Mode and the tape direction properly to record on both side of the tape. (See page 21.)



If the front side of the tape ends in the middle of a track, the recording on the reverse side starts from the beginning of that track (if the reverse mode is set to ).

However, when recording in the Random Play mode, recording on the reverse side does not start from the beginning of the track.



“NO REC” will appear on the display when you press REC in the following cases:

- If no cassette is inserted.
- If a protected tape is inserted.
- If any tray is open when the source is the CD player.

One Disc Synchronized Recording

1 Insert a recordable cassette into the cassette compartment with the exposed part of the tape facing left.

2 Load the disc you want to record into the 5-CD Changer.

3 Press the disc number button (CD 1 – CD 5) on the remote control to select the disc you want to record, then press .

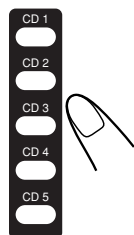

4 Press CD REC MODE on the remote control to select “1 CD.”

Each time you press the button, the recording mode changes as follows:

1 CD → ALL CD → 1ST TRACK

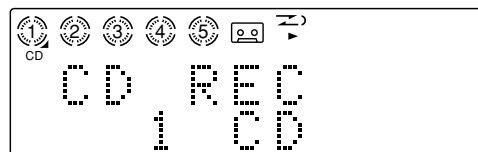

5 Press REC while “1 CD” still remains on the display.

The REC indicator lights up on the display and recording starts.

- Make sure to press the button before “1 CD” goes off; otherwise, recording will start in the All Discs Synchronized Recording mode (see page 23).

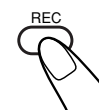
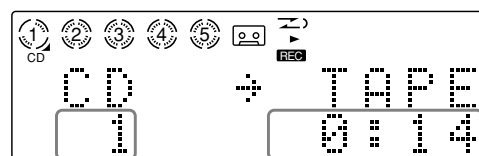

Current track number

Elapsed playing time

When the selected disc is recorded, recording will stop. Both the 5-CD changer and the cassette deck stop automatically.

To stop while recording, press .

The tape stops after 4 seconds.





To remove the cassette, press  on the unit.



When recording a disc

A 4-second blank is automatically made on the tape before each track. To record without the blank, follow the procedure below:

- 1 Load only the disc you want to record into the 5-CD Changer.
- 2 Press DISC SELECT on the unit to select the disc number you have loaded.
- 3 Press  CD on the unit twice so that disc playback is paused.
 - If the pausing position is not “0:00,” you can skip back to “0:00” by pressing  DOWN on the unit.
- 4 Press REC on the unit to start recording. When the disc is recorded, recording will stop.



You cannot exchange a disc while recording another disc.



Pressing CD REC MODE changes the disc playback mode to Continuous Play and cancels the Repeat Play mode.

All Discs Synchronized Recording

1 Insert a recordable cassette into the cassette compartment with the exposed part of the tape facing left.

2 Load discs into the 5-CD Changer.

- You can make a program (see page 17) or select the Random Play mode (see page 18) if you want. In this case, you cannot select the starting disc → go to step 5.

3 Press one of the disc number buttons (CD 1 – CD 5) on the remote control to select the disc you want to start recording from, then press ■.

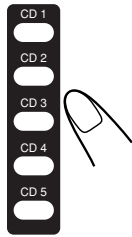

4 Press CD REC MODE on the remote control to select “ALL CD.”

Each time you press the button, The recording mode changes as follows:

1 CD → ALL CD → 1ST TRACK

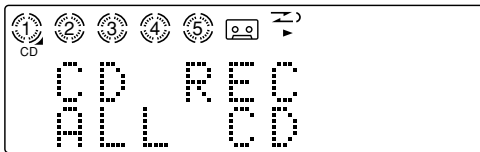

5 Press REC.

The **REC** indicator lights up on the display and recording starts.

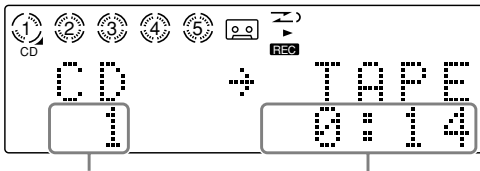

Current track number

Elapsed playing time

To stop while recording, press ■. The tape stops after 4 seconds.

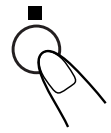

To remove the cassette, press ▲ on the unit.



When recording discs

A 4-second blank is automatically made on the tape before each track. To record without the blank, follow the procedure below:

- Load discs you want to record into the 5-CD Changer.
- Press DISC SELECT on the unit to select the disc number you have loaded.
- Press ▷/|| CD on the unit twice so that disc playback is paused.
 - If the pausing position is not “0:00,” you can skip back to “0:00” by pressing ◀◀ DOWN on the unit.
- Press REC on the unit to start recording.

When all loaded discs are recorded, recording will stop.



You cannot exchange a disc while recording another disc.



Pressing CD REC MODE changes the disc playback mode to Continuous Play and cancels the Repeat Play mode.

First Track Recording

First Track Recording allows you to record the first track of each loaded disc.

1 Insert a recordable cassette into the cassette compartment with the exposed part of the tape facing left.

2 Load discs into the 5-CD Changer.

3 Press one of the disc number buttons (CD 1 – CD 5) on the remote control to select the disc you want to start recording with, then press ■.

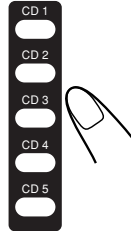

4 Press CD REC MODE on the remote control to select “1ST TRACK.”

Each time you press the button, The recording mode changes as follows:

1 CD → ALL CD → 1ST TRACK

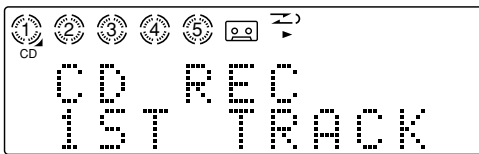

5 Press REC while “1ST TRACK” still remains on the display.

The **REC** indicator lights up on the display and recording starts.

- Make sure to press the button before “1ST TRACK” goes off; otherwise, recording will start in the All Discs Synchronized Recording mode (see page 23).

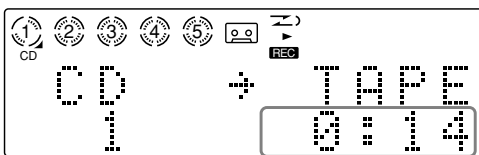

Elapsed playing time

When the first track of the selected disc is recorded, the first track of the next disc will be recorded.

First Track Recording will stop after all the first tracks on the loaded discs are recorded.

Both the 5-CD changer and the cassette deck stop automatically.

To stop while recording, press ■. The tape stops after 4 seconds.



To remove the cassette, press ▲ on the unit.



You cannot exchange a disc while recording another disc.



Pressing CD REC MODE changes the disc playback mode to Continuous Play and cancels the Repeat Play mode.

One Track Recording

This recording method is convenient when you record tracks during play. You can record just the track you want.

1 Insert a recordable cassette into the cassette compartment with the exposed part of the tape facing left.

2 Press REC while playing the track you want to record.

The playback of the track is stopped, and the same track starts playing from the beginning.

This time, the cassette deck starts recording the track.

- After the track is recorded, both the 5-CD changer and the cassette deck stop automatically.

To stop while recording, press ■. The tape stops after 4 seconds.

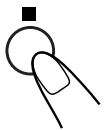

To remove the cassette, press ▲ on the unit.



Using the Timers

Three timers are available—Recording Timer, Daily Timer and Sleep Timer.

- Before using these timers, make sure the built-in clock is set correctly (see page 9).

Using the Daily Timer and the Recording Timer

You can set the timer when the unit is either turned on or in standby mode.

How the timer actually works

When the on-time comes, the unit automatically turns on (the ⌚ (timer) indicator flashes just before the on-time and continues flashing while the timer is operating). Then, when the off-time comes, the unit automatically turns off (standby). The timer setting remains in memory until you change it.

- When the DAILY indicator is lit on the display, the timer acts as the Daily Timer. Once the timer has been set, it will be activated at the same time everyday until the timer is turned off.
- When the REC indicator is lit on the display, the timer acts as the Recording Timer. After the timed-recording finishes, the details of the setting remain stored but the timer is turned off.

Before you start...

When using “TUNER” as the source to play, make sure to select the desired station before turning off the power.

- There is a time limit in doing the following steps. If the setting is canceled before you finish, start again from step 1.

On the remote control ONLY:

1 Press CLOCK/TIMER.

The ⌚ (timer) indicator lights up and the timer mode indicator (DAILY or REC) flashes on the display.

The unit enters the on-time setting mode.

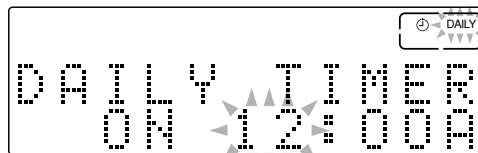

Ex.: When the Daily Timer has been selected the last time.

2 Set the on-time you want the unit to turn on.

- 1) Press ▲ UP or ▼ DOWN to set the hour, then press CLOCK/TIMER.
- 2) Press ▲ UP or ▼ DOWN to set the minute, then press CLOCK/TIMER.

The unit enters the off-time setting mode.

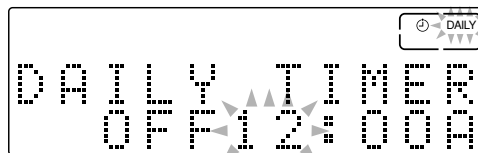
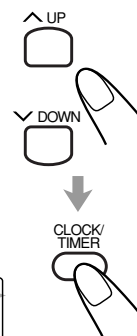

3 Set the off-time you want the unit to turn off.

- 1) Press ▲ UP or ▼ DOWN to set the hour, then press CLOCK/TIMER.
- 2) Press ▲ UP or ▼ DOWN to set the minute, then press CLOCK/TIMER.

The unit enters the source setting mode.

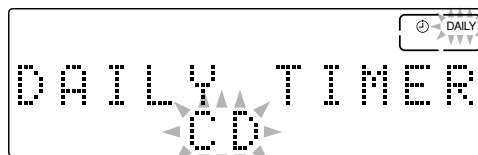
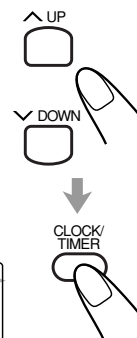

4 Press **^ UP** or **v DOWN** to select the timer mode (the Daily Timer or the Recording Timer) and the source to play, then press **CLOCK/TIMER**.

- Each time you press **^ UP** or **v DOWN**, the timer mode and the source to play change as follows:

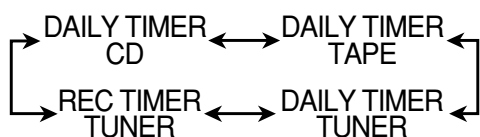

- **“DAILY TIMER CD”**: plays the selected disc or your program. (Daily Timer)
 - Load a disc or make the program.
 - go to step 5.
- **“DAILY TIMER TAPE”**: plays a tape. (Daily Timer)
 - Make sure that the tape is in the cassette deck.
 - Make sure that the tape direction is correct.
 - go to step 6.
- **“DAILY TIMER TUNER”**: tunes in to the last station you have been listening to. (Daily Timer)
 - go to step 6.
- **“REC TIMER TUNER”**: records the last station you have been listening to. (Recording Timer)
 - Put a recordable cassette into the deck.
 - Make sure that the tape direction and the Reverse Mode are correct.
 - go to step 6.

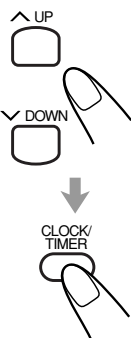

5 When selecting **“DAILY TIMER CD”** in step 4, select the disc number to play or Program Play.

- 1) Press **^ UP** or **v DOWN** to select the disc number or Program Play.
 - Each time you press the button, the indication on the display changes as follows:



- **“CD DISC 1”** – **“CD DISC 5”**: plays the selected disc.
- **“CD PROGRAM”**: plays the program you have made.

- 2) Press **CLOCK/TIMER**.



The unit enters the volume level setting mode.

6 Press **^ UP** or **v DOWN** to set the volume level, then press **CLOCK/TIMER**.

- You can select the volume level between **“VOLUME --”** and **“VOLUME 0”** to **“VOLUME 40.”**
 - If you select **“VOLUME --,”** the volume level is set to the current volume.
- To turn off the volume while the Recording Timer is working, set the volume level to **“VOLUME 0.”**

The selected timer mode indicator (DAILY or REC) stops flashing.

The unit enters the clock setting mode.

7 Adjust the clock if needed.

- See **“Setting the Clock”** on page 9.

8 Press **STANDBY/ON** to turn off the unit if the unit is on.

When the timer turns on the unit, the  (timer) indicator and the selected timer mode indicator (DAILY or REC) start flashing.

To deactivate the timer temporarily, press and hold **CLOCK/TIMER** until the  (timer) indicator and the selected timer mode indicator (DAILY or REC) go off.



To activate and change the timer, repeat steps 1 to 7 on pages 25 and 26.

- Deactivate the timer first in the following cases:
 - If you want to change the Daily Timer setting
 - If you want to change the Recording Timer setting before the Recording Timer works.
- To activate the timer again without changing the setting, press **CLOCK/TIMER** repeatedly until the  (timer) indicator and the selected timer mode indicator (DAILY or REC) light up on the display.



If the unit is already turned on when the timer-on time comes

The timer does not work.



When you unplug the AC power cord or if a power failure occurs

The timer will be canceled. You need to set the clock first, then set the timer again.



When you have selected “CD PROGRAM” in step 5

Do not press **DISPLAY** while the unit is in standby mode to turn off the clock indication (**“DISPLAY OFF”**); otherwise, the program contents is cleared and playback starts in the Continuous Play mode when the timer-on time comes.

Using the Sleep Timer

With the Sleep Timer, you can fall asleep to your favorite music or radio program.

- You can set the Sleep Timer only when the unit is turned on.

How the Sleep Timer actually works

The unit automatically turns off after the specified length of time passes.

On the remote control ONLY:

1 Press SLEEP.

The SLEEP indicator lights up on the display. "SLEEP 10" appears on the display for a while.

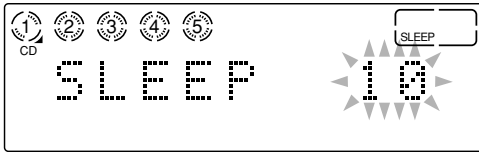

- Each time you press the button, the length of time changes as follows:

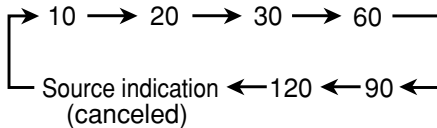

2 Wait for about 5 seconds after specifying the length of time.

To check the remaining time until shut-off time, press SLEEP once. The remaining time until shut-off time appears for about 5 seconds.

To change the shut-off time, press SLEEP repeatedly until the length of time you want appears.

To cancel the setting, press SLEEP repeatedly until the current source indication appears on the display.

The SLEEP indicator goes off.

- Turning off the unit also cancels the Sleep Timer.



If you set the Sleep Timer after the Daily Timer starts playing the selected source

The Daily timer is canceled. The unit turns off when the Sleep Timer shut-off time comes.



You cannot set the Sleep Timer while the Recording Timer is working.



You can also turn off the unit automatically by using the Auto Standby function. (See page 10.)

Maintenance

To get the best performance of the unit, keep your discs, tapes and mechanism clean.

General Notes

In general, you will have the best performance by keeping your discs, tapes and the mechanism clean.

- Store discs and tapes in their cases, and keep them in cabinets or on shelves.

Cleaning the unit

• Stains on the unit

Should be wiped off with a soft cloth. If the unit is heavily stained, wipe it with a cloth soaked in water-diluted neutral detergent and wrung well, then wipe clean with a dry cloth.

- **Since the unit may deteriorate in quality, become damaged or have its paint peel off, be careful about the following:**
 - DO NOT wipe it with a rough cloth.
 - DO NOT wipe it too vigorously.
 - DO NOT wipe it with thinner or benzine.
 - DO NOT apply any volatile substance such as an insecticide to it.
 - DO NOT allow any rubber or plastic to remain in contact with it for a long time.

Handling discs



- Remove the disc from its case by holding it at the edge while pressing the center hole lightly.
- Do not touch the shiny surface of the disc, or bend the disc.
- Put the disc back in its case after use to prevent warping.

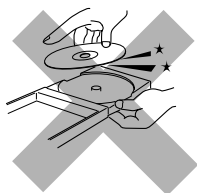

- Be careful not to scratch the surface of the disc when placing it back in its case.
- Avoid exposure to direct sunlight, temperature extremes, and moisture.



To clean the disc

Wipe the disc with a soft cloth in a straight line from center to edge.



DO NOT use any solvent—such as conventional record cleaner, spray, thinner, or benzine—to clean the disc.

Handling cassette tapes



- If the tape is loose in its cassette, take up the slack by inserting a pencil in one of the reels and rotating.
- If the tape is loose, it may get stretched, cut, or caught in the cassette.



- Be careful not to touch the tape surface.



- Avoid storing tapes in any of the following places:
 - In dusty places
 - In direct sunlight or heat
 - In moist areas
 - On a TV or speaker
 - Near a magnet

To keep the best recording and playback sound quality

You need to clean the heads.

- Clean the heads after every 10 hours of use with a wet-type head cleaning tape (available at electronic and audio shops).
When the head becomes dirty, the following symptoms will occur:
 - Sound quality is reduced.
 - Sound level decreases.
 - Sound drops out.
- Do not play dirty or dusty tapes.
- Do not touch the highly-polished head with any metallic or magnetic tools.

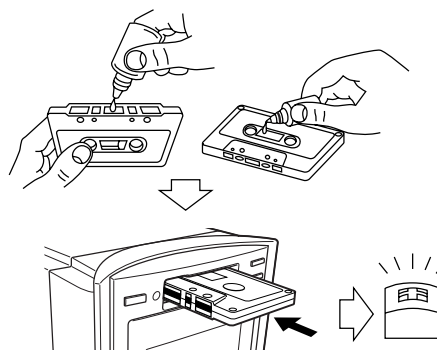

To demagnetize the head

Turn off the unit, and use a head demagnetizer (available at electronic and audio shops).

Troubleshooting

If you are having a problem with your unit, check this list for a possible solution before calling for service.

If you cannot solve the problem from the hints given here, or the unit has been physically damaged, call a qualified person, such as your dealer, for service.

Symptom	Possible Cause	Action
Power does not come on.	The power cord is not connected to an AC outlet.	Insert the plug into the socket.
No sound is heard.	<ul style="list-style-type: none"> • Connections are incorrect or loose. • A pair of headphones is connected. 	<ul style="list-style-type: none"> • Check all connections and make corrections. (See pages 6 to 8.) • Unplug the headphones from the PHONES jack.
Hard to listen to broadcasts because of noise.	<ul style="list-style-type: none"> • Antennas are disconnected. • The AM loop antenna is too close to the unit. • The FM antenna is not properly extended and positioned. 	<ul style="list-style-type: none"> • Reconnect the antenna correctly and securely. • Change the position and direction of the AM loop antenna. • Extend FM antenna and orient to the best reception position.
Loaded discs cannot be ejected.	<ul style="list-style-type: none"> • The AC power cord is not plugged in. • The Disc Lock function is in use. 	<ul style="list-style-type: none"> • Plug in the AC power cord. • Cancel the Disc Lock function. (See page 19.)
The disc does not play.	The disc is upside down.	Put the disc in with the label side up.
Loaded cassette cannot be ejected.	The Cassette Lock function is in use.	Cancel the Cassette Lock function. (See page 20.)
Impossible to record.	Small tabs on the back of the cassette are removed.	Cover the holes with adhesive tape.
Operations are disabled.	The built-in microprocessor has malfunctioned due to external electrical interference.	Unplug the AC power cord then plug it back in.
Unable to operate the unit by the remote control.	<ul style="list-style-type: none"> • The path between the remote control and the remote sensor on the unit is blocked. • The batteries are exhausted. • You are using the remote control too far from the unit. 	<ul style="list-style-type: none"> • Remove the obstruction. • Replace the batteries. (See page 8.) • Signals cannot reach the remote sensor. Move closer to the unit.

Specifications

Amplifier Section—CA-FSB70

Output Power: 74 W per channel, min. RMS, driven into 6 Ω at 1 kHz with no more than 10% total harmonic distortion.

Analog input sensitivity/Impedance (at 1 kHz)

AUX/DVD: 400 mV/48 k Ω

Speakers/Impedance: 6 Ω – 16 Ω

Tuner

FM tuning range: 87.5 MHz—108.0 MHz

AM tuning range: 530 kHz—1 710 kHz

CD player

CD Capacity: 5 CDs

Dynamic range: 87 dB

Signal-to-noise ratio: 90 dB

Wow and flutter: Immeasurable

Cassette deck

Frequency response:

Normal (type I): 60 Hz—14 000 Hz

Wow and flutter: 0.15 % (WRMS)

General

Power requirement: AC 120 V \sim , 60 Hz

Power consumption: 110 W (at operation)

17 W (on standby)

1.1 W (in power save mode)

Dimensions (W/H/D) (approx.):

175 mm x 239.5 mm x 378 mm

(6 ¹⁵/₁₆ in. x 9 ¹/₂ in. x 14 ¹⁵/₁₆ in.)

Mass (approx.):

8 kg (17.7 lbs)

Supplied accessories

See page 6.

Speaker Section—SP-UXB70

Type: 2-way bass-reflex type

Speakers: Woofer 12 cm (4 ³/₄ in.) cone x1

Tweeter 2 cm (¹³/₁₆ in.) dome x1

Power handling capacity: 60 W

Impedance: 6 Ω

Frequency range: 55 Hz to 20 kHz

Sound pressure level: 85 dB/W•m

Dimensions (W/H/D) (approx.):

145 mm x 239.5 mm x 202 mm

(5 ³/₄ in. x 9 ¹/₂ in. x 8 in.)

Mass (approx.):

2.5 kg (5.5 lbs) each

Design and specifications are subject to change without notice.



LIMITED WARRANTY

AUDIO-1

JVC COMPANY OF AMERICA warrants this product and all parts thereof, except as set forth below ONLY TO THE ORIGINAL PURCHASER AT RETAIL to be FREE FROM DEFECTIVE MATERIALS AND WORKMANSHIP from the date of original retail purchase for the period as shown below. ("The Warranty Period")

PARTS	1 YR	LABOR	1 YR
-------	-------------	-------	-------------

THIS LIMITED WARRANTY IS VALID ONLY IN THE FIFTY (50) UNITED STATES, THE DISTRICT OF COLUMBIA AND IN COMMONWEALTH OF PUERTO RICO.

WHAT WE WILL DO:

If this product is found to be defective, JVC will repair or replace defective parts at no charge to the original owner. Such repair and replacement services shall be rendered by JVC during normal business hours at JVC authorized service centers. Parts used for replacement are warranted only for the remainder of the Warranty Period. All products and parts thereof may be brought to a JVC authorized service center on a carry-in basis except for Television sets having a screen size 25 inches and above which are covered on an in-home basis.

WHAT YOU MUST DO FOR WARRANTY SERVICE:

Return your product to a JVC authorized service center with a copy of your bill of sale. For your nearest JVC authorized service center, please call toll free: (800) 537-5722.

If service is not available locally, box the product carefully, preferably in the original carton, and ship, insured, with a copy of your bill of sale plus a letter of explanation of the problem to the nearest JVC Factory Service Center, the name and location of which will be given to you by the toll-free number.

If you have any questions concerning your JVC Product, please contact our Customer Relations Department.

WHAT IS NOT COVERED:

This limited warranty provided by JVC does not cover:

1. Products which have been subject to abuse, accident, alteration, modification, tampering, negligence, misuse, faulty installation, lack of reasonable care, or if repaired or serviced by anyone other than a service facility authorized by JVC to render such service, or if affixed to any attachment not provided with the products, or if the model number or serial number has been altered, tampered with, defaced or removed;
2. Initial installation and installation and removal for repair;
3. Operational adjustments covered in the Owner's Manual, normal maintenance, video and audio head cleaning;
4. Damage that occurs in shipment, due to act of God, and cosmetic damage;
5. Signal reception problems and failures due to line power surge;
6. Video Pick-up Tubes/CCD Image Sensor, Cartridge, Stylus (Needle) are covered for 90 days from the date of purchase;
7. Accessories
8. Batteries (except that Rechargeable Batteries are covered for 90 days from the date of purchase);

There are no express warranties except as listed above.

THE DURATION OF ANY IMPLIED WARRANTIES, INCLUDING THE IMPLIED WARRANTY OF MERCHANTABILITY, IS LIMITED TO THE DURATION OF THE EXPRESS WARRANTY HEREIN.

JVC SHALL NOT BE LIABLE FOR THE LOSS OF USE OF THE PRODUCT, INCONVENIENCE, LOSS OR ANY OTHER DAMAGES, WHETHER DIRECT, INCIDENTAL OR CONSEQUENTIAL (INCLUDING, WITHOUT LIMITATION, DAMAGE TO TAPES, RECORDS OR DISCS) RESULTING FROM THE USE OF THIS PRODUCT, OR ARISING OUT OF ANY BREACH OF THIS WARRANTY. ALL EXPRESS AND IMPLIED WARRANTIES, INCLUDING THE WARRANTIES OF MERCHANTABILITY AND FITNESS FOR PARTICULAR PURPOSE, ARE LIMITED TO THE WARRANTY PERIOD SET FORTH ABOVE.

Some states do not allow the exclusion of incidental or consequential damages or limitations on how long an implied warranty lasts, so these limitations or exclusions may not apply to you. This warranty gives you specific legal rights and you may also have other rights which vary from state to state.

JVC COMPANY OF AMERICA 1700 Valley Road
 DIVISION OF JVC AMERICAS CORP. Wayne, NJ 07470

REFURBISHED PRODUCTS CARRY A SEPARATE WARRANTY, THIS WARRANTY DOES NOT APPLY. FOR DETAILS OF REFURBISHED PRODUCT WARRANTY, PLEASE REFER TO THE REFURBISHED PRODUCT WARRANTY INFORMATION PACKAGED WITH EACH REFURBISHED PRODUCT.

For customer use:

Enter below the Model No. which is located either on the rear, bottom or side of the cabinet. Retain this information for future reference.

Model No. :	Serial No. :
Purchase data :	Name of dealer :

Authorized Service Centers

QUALITY **JVC**[®] SERVICE

HOW TO LOCATE YOUR JVC SERVICE CENTER

TOLL FREE: 1 (800) 537-5722

<http://www.jvc.com>

Dear Customer,

In order to receive the most satisfaction from your purchase, please read the instruction booklet before operating the unit. In the event that repairs are necessary, please call 1 (800)537-5722 for your nearest authorized servicer or visit our website at **www.JVC.com**

Remember to retain your Bill of Sale for Warranty Service.

Do not service the television yourself

Caution

To prevent electrical shock, do not open the cabinet. There are no user serviceable parts inside. Please refer to qualified service personnel for repairs.

Accessories

To purchase accessories for your JVC product, please call toll free: 1 (800)882-2345 or on the web at **www.JVC.com**



JVC



English

Français

COMPACT COMPONENT SYSTEM

SYSTEME DE COMPOSANTS COMPACT

FS-B70

—Consists of CA-FSB70 and SP-UXB70
—Composé du CA-FSB70 et SP-UXB70

COMPACT
disc
DIGITAL AUDIO

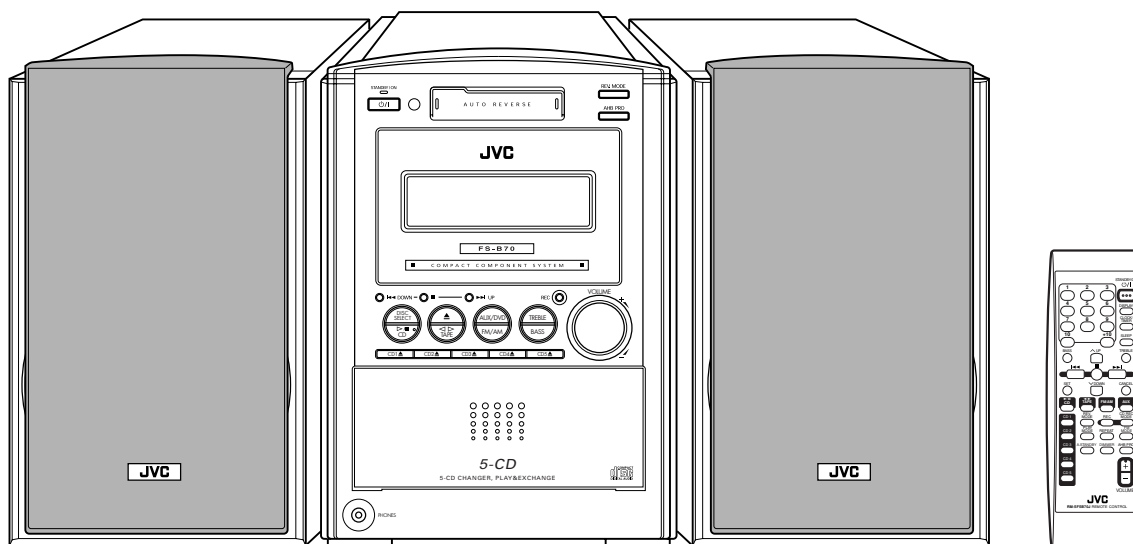

INSTRUCTIONS

MANUEL D'INSTRUCTIONS

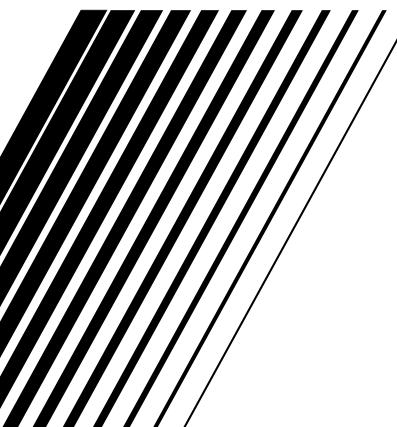

GVT0103-002A
[C]

Warnings, Cautions and Others

Mises en garde, précautions et indications diverses

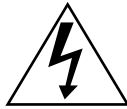

The lightning flash with arrowhead symbol, within an equilateral triangle is intended to alert the user to the presence of uninsulated dangerous voltage within the product's enclosure that may be of sufficient magnitude to constitute a risk of electric shock to persons.



The exclamation point within an equilateral triangle is intended to alert the user to the presence of important operating and maintenance (servicing) instructions in the literature accompanying the appliance.

For U.S.A.

This equipment has been tested and found to comply with the limits for a Class B digital device, pursuant to part 15 of the FCC Rules. These limits are designed to provide reasonable protection against harmful interference in a residential installation.

This equipment generates, uses and can radiate radio frequency energy and, if not installed and used in accordance with the instructions, may cause harmful interference to radio communications. However, there is no guarantee that interference will not occur in a particular installation. If this equipment does cause harmful interference to radio or television reception, which can be determined by turning the equipment off and on, the user is encouraged to try to correct the interference by one or more of the following measures:

Reorient or relocate the receiving antenna.

Increase the separation between the equipment and receiver.

Connect the equipment into an outlet on a circuit different from that to which the receiver is connected.

Consult the dealer or an experienced radio/TV technician for help.

WARNING: TO REDUCE THE RISK OF FIRE OR ELECTRIC SHOCK, DO NOT EXPOSE THIS APPLIANCE TO RAIN OR MOISTURE.

Caution— button!

Disconnect the mains plug to shut the power off completely (the STANDBY/ON lamp goes off). The  button in any position does not disconnect the mains line.

- When the unit is on standby, the STANDBY/ON lamp lights red.
- When the unit is turned on, the STANDBY/ON lamp lights green.

The power can be remote controlled.

Attention—Commutateur !

Déconnectez la prise d'alimentation secteur pour mettre l'appareil complètement hors tension (le témoin STANDBY/ON s'éteint).

L'interrupteur , sur n'importe quelle position, ne peut pas déconnecter l'appareil du secteur.

- Quand l'appareil est en mode de veille, le témoin STANDBY/ON est allumé en rouge.
- Quand l'appareil est sous tension, le témoin STANDBY/ON est allumé en vert.

L'alimentation peut être télécommandée.

CAUTION

To reduce the risk of electrical shocks, fire, etc.:

1. Do not remove screws, covers or cabinet.
2. Do not expose this appliance to rain or moisture.

ATTENTION

Afin d'éviter tout risque d'électrocution, d'incendie, etc.:

1. Ne pas enlever les vis ni les panneaux et ne pas ouvrir le coffret de l'appareil.
2. Ne pas exposer l'appareil à la pluie ni à l'humidité.

Note to CATV system installer:

This reminder is provided to call the CATV system installer's attention to Section 820-40 of the NEC which provides guidelines for proper grounding and, in particular, specifies that the cable ground shall be connected to the grounding system of the building, as close to the point of cable entry as practical.

For Canada/pour le Canada

CAUTION: TO PREVENT ELECTRIC SHOCK, MATCH WIDE BLADE OF PLUG TO WIDE SLOT, FULLY INSERT.

ATTENTION: POUR EVITER LES CHOCS ELECTRIQUES, INTRODUIRE LA LAME LA PLUS LARGE DE LA FICHE DANS LA BORNE CORRESPONDANTE DE LA PRISE ET POUSSER JUSQU'AU FOND.

For Canada/pour le Canada

THIS DIGITAL APPARATUS DOES NOT EXCEED THE CLASS B LIMITS FOR RADIO NOISE EMISSIONS FROM DIGITAL APPARATUS AS SET OUT IN THE INTERFERENCE-CAUSING EQUIPMENT STANDARD ENTITLED "DIGITAL APPARATUS," ICES-003 OF THE DEPARTMENT OF COMMUNICATIONS.

CET APPAREIL NUMERIQUE RESPECTE LES LIMITES DE BRUITS RADIOELECTRIQUES APPLICABLES AUX APPAREILS NUMIRIQUES DE CLASSE B PRESCRITES DANS LA NORME SUR LE MATERIEL BROUILLEUR: "APPAREILS NUMERIQUES", NMB-003 EDICTEE PAR LE MINISTRE DES COMMUNICATIONS.

Introduction

We would like to thank you for purchasing one of our JVC products. Before operating this unit, read this manual carefully and thoroughly to obtain the best possible performance from your unit, and retain this manual for future reference.

About This Manual

This manual is organized as follows:

- This manual mainly explains operations using the buttons on the remote control. You can use the buttons both on the remote control and on the unit for the same operations if they have the same or similar names (or marks), unless mentioned otherwise.
- Basic and common information that is the same for many functions is grouped in one place, and is not repeated for each procedure. For instance, we do not repeat the information about turning on/off the unit, setting the volume, changing the sound effects, and others, which are explained in the section “Basic and Common Operations” on pages 9 to 12.
- The following symbols are used in this manual:



Gives you warning and caution to prevent damage or risk of fire/electric shock. In addition, we put information here about conditions which will prevent getting the best possible performance from the unit.



Gives you information and hints you need to know.

Precautions

Installation

- Install in a place which is level, dry and neither too hot nor too cold—between 5°C and 35°C.
- Install the unit in a location with adequate ventilation to prevent internal heat buildup.
- Leave sufficient distance between the unit and the TV.
- Keep the speakers away from the TV to avoid interference with TV.



DO NOT install the unit in a location near heat sources, or in a place subject to direct sunlight, excessive dust or vibration.

Power sources

- When unplugging the unit from the wall outlet, always pull on the plug, not the AC power cord.



DO NOT handle the AC power cord with wet hands.

Moisture condensation

Moisture may condense on the lenses inside the unit in the following cases:

- After starting to heat the room.
- In a damp room.
- If the unit is brought directly from a cold to a warm place. Should this occur, the unit may malfunction. In this case, leave the unit turned on for a few hours until the moisture evaporates, unplug the AC power cord, then plug it in again.

Others

- Should any metallic object or liquid fall into the unit, unplug the AC power cord and consult your dealer before operating any further.
- If you are not going to operate the unit for an extended period of time, unplug the AC power cord from the wall outlet.



DO NOT disassemble the unit since there are no user serviceable parts inside.

If anything goes wrong, unplug the AC power cord and consult your dealer.

Location of the Buttons and Controls	3
Front Panel	3
Remote Control	5
Getting Started	6
Unpacking	6
Connecting Antennas	6
Connecting Speakers	7
Connecting Other Equipment	8
Putting the Batteries into the Remote Control	8
Basic and Common Operations	9
Setting the Clock	9
Turning On the Power	10
Adjusting the Volume	11
Reinforcing the Bass Sound	11
Adjusting the Tone	12
Changing the Display Brightness	12
Listening to FM and AM Broadcasts.....	13
Tuning in to a Station	13
Presetting Stations	13
Tuning in to a Preset Station	14
Playing Back Discs on the 5-CD Changer	15
Loading Discs	15
Playing Back All the Discs—Continuous Play	16
Basic Disc Operations	16
Programing the Track Playing Order	
—Program Play	17
Playing at Random—Random Play	18
Repeating Tracks or Discs—Repeat Play	19
Prohibiting Disc Ejection	19
Playing Back Tapes.....	20
Playing Back a Tape	20
Prohibiting Cassette Ejection	20
Recording	21
Recording on a Tape	21
Recording Discs—Disc Synchronized Recording	22
Using the Timers	25
Using the Daily Timer and the Recording Timer	25
Using the Sleep Timer	27
Maintenance.....	28
Troubleshooting	29
Specifications	30

Location of the Buttons and Controls

Become familiar with the buttons and controls on your unit.

Front Panel

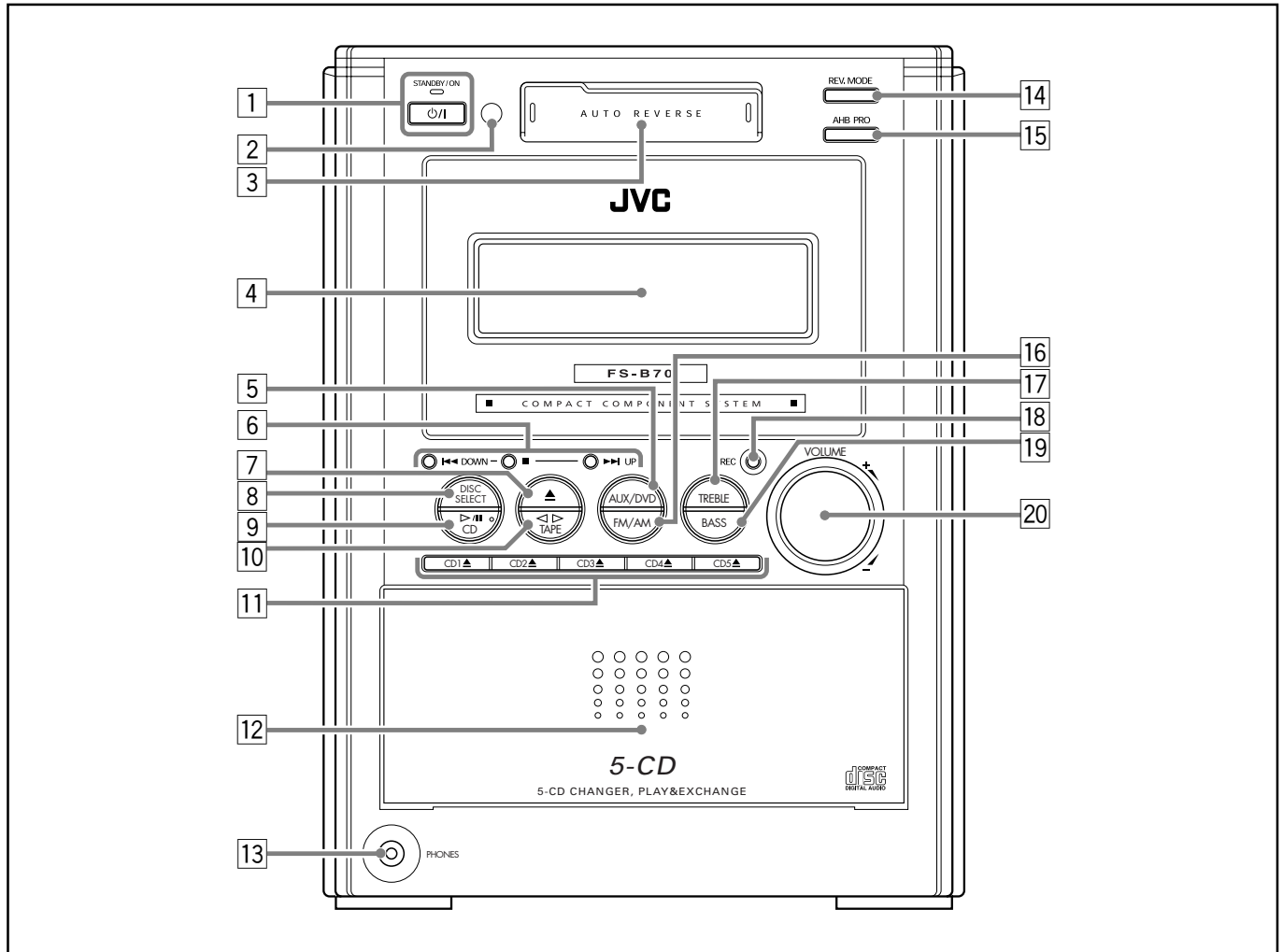

Front panel

See pages in parentheses for details.

- | | |
|--|---|
| <p>1 ⏻/⏻ (standby/on) button and STANDBY/ON lamp (10, 19, 20, 26)</p> <p>2 Remote sensor (5)</p> <p>3 Cassette compartment (20)</p> <p>4 Display window (4)</p> <p>5 AUX/DVD button (10)</p> <ul style="list-style-type: none"> • Pressing this button also turns on the unit. <p>6 Multi operation buttons
⏮ DOWN, ■, and ⏭ UP</p> <p>7 ▲ (tape eject) button (20 – 24)</p> <ul style="list-style-type: none"> • Pressing this button also turns on the unit. <p>8 DISC SELECT button (16, 17, 22, 23)</p> <p>9 ▷/⏻ CD button (10, 16, 22, 23)</p> <ul style="list-style-type: none"> • Pressing this button also turns on the unit. <p>10 ◀▷ TAPE button (10, 20, 21)</p> <ul style="list-style-type: none"> • Pressing this button also turns on the unit. | <p>11 Disc eject buttons (10, 15, 16)
CD1▲, CD2▲, CD3▲, CD4▲, and CD5▲</p> <ul style="list-style-type: none"> • Pressing one of these buttons also turns on the unit and opens the corresponding disc tray. <p>12 Disc trays compartment (15)</p> <p>13 PHONES jack (11)</p> <p>14 REV.MODE (reverse mode) button (20, 21)</p> <p>15 AHB PRO (Active Hyper Bass Pro) button (11)</p> <p>16 FM/AM button (10, 13, 14)</p> <ul style="list-style-type: none"> • Pressing this button also turns on the unit. <p>17 TREBLE button (12)</p> <p>18 REC (recording) button (21 – 24)</p> <p>19 BASS button (12)</p> <p>20 VOLUME + / – control (11)</p> |
|--|---|

Display window on the front panel

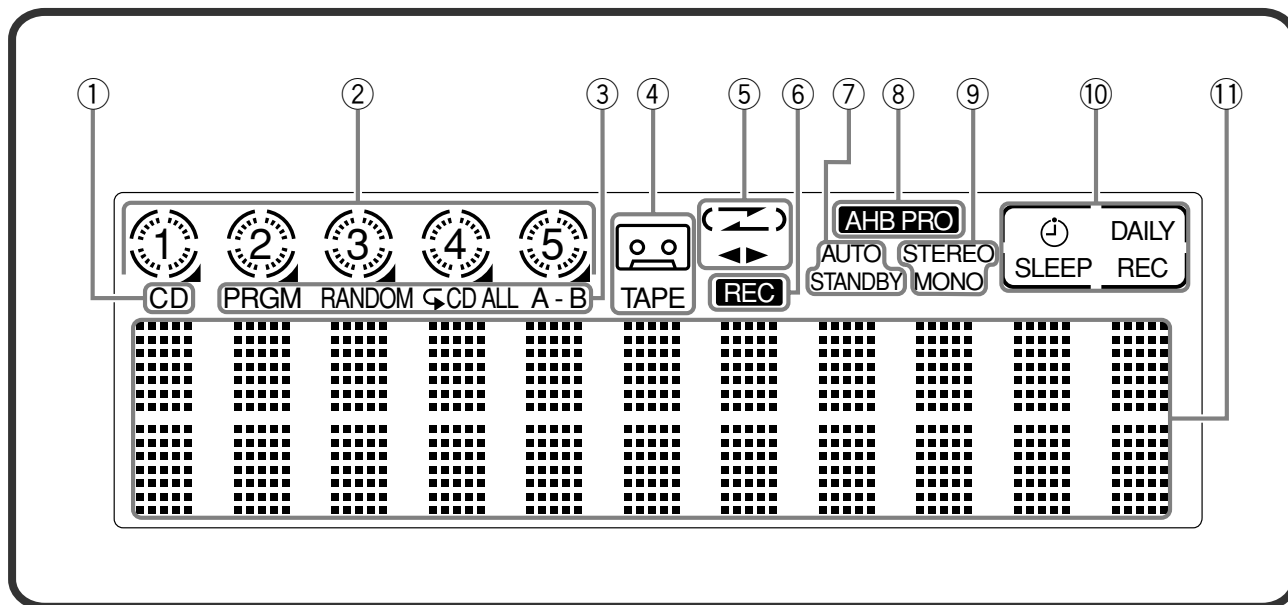

Display window

See pages in parentheses for details.

- ① CD indicator (15)
- ② Disc indicators (15)
- ③ Disc play mode indicators (17 – 19)
 - PRGM (program), RANDOM, and Repeat mode (↵, ↵ CD, ↵ ALL, ↵ A-B)
- ④ TAPE indicator (20)
 -  indicator (20)
- ⑤ Tape operation indicators (20, 21)
 - ◀▶ (tape direction) and ↺ (reverse mode)
- ⑥ REC indicator (21 – 24)
- ⑦ AUTO STANDBY indicator (10)
- ⑧ AHB PRO (Active Hyper Bass Pro) indicator (11)
- ⑨ FM mode indicators (13)
 - STEREO and MONO
- ⑩ Timer indicators
 - ⌚ (timer) (9, 25, 26)
 - SLEEP (sleep timer) (27)
 - DAILY (daily timer) (9, 25, 26)
 - REC (recording timer) (9, 25, 26)
- ⑪ Main display
 - Shows the source name and other information.

Remote Control

See pages in parentheses for details.

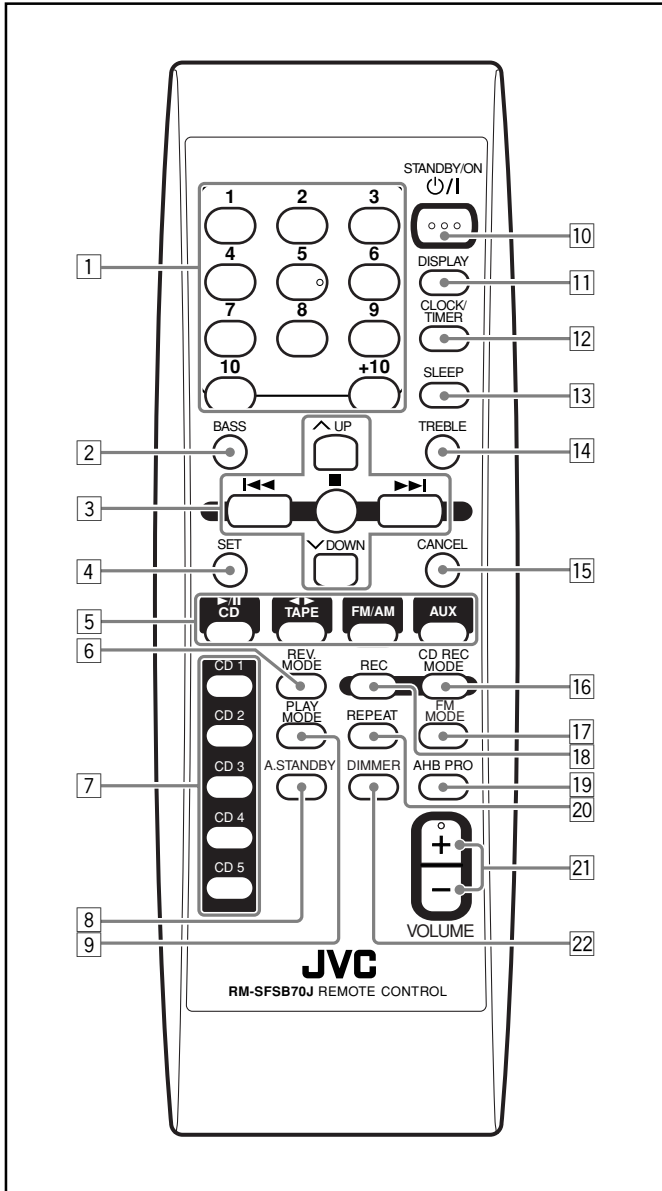

- 1 Number buttons
- 2 BASS button (12)
- 3 Multi operation buttons
 - ▲ UP and ▼ DOWN
 - ◀◀, ■, and ▶▶
- 4 SET button (13, 14, 19)
- 5 Source buttons
 - ▶/|| CD, ◀▶ TAPE, FM/AM, and AUX

Pressing one of these buttons also turns on the unit.
- 6 REV.MODE button (20, 21)
- 7 Disc number buttons (10, 16, 17, 22 – 24)
 - CD 1, CD 2, CD 3, CD 4, and CD 5

Pressing one of these buttons also turns on the unit and starts disc play if a disc is ready.
- 8 A.STANDBY (auto standby) button (10)
- 9 PLAY MODE button (17, 18)
- 10 STANDBY/ON ⏻/⏻ button (10, 26)
- 11 DISPLAY button (9)
- 12 CLOCK/TIMER button (9, 25, 26)
- 13 SLEEP button (27)
- 14 TREBLE button (12)
- 15 CANCEL button (18)
- 16 CD REC MODE (disc recording mode) button (22 – 24)
- 17 FM MODE button (13)
- 18 REC (recording) button (21 – 24)
- 19 AHB PRO (Active Hyper Bass Pro) button (11)
- 20 REPEAT button (19)
- 21 VOLUME + / - button (11)
- 22 DIMMER button (12)

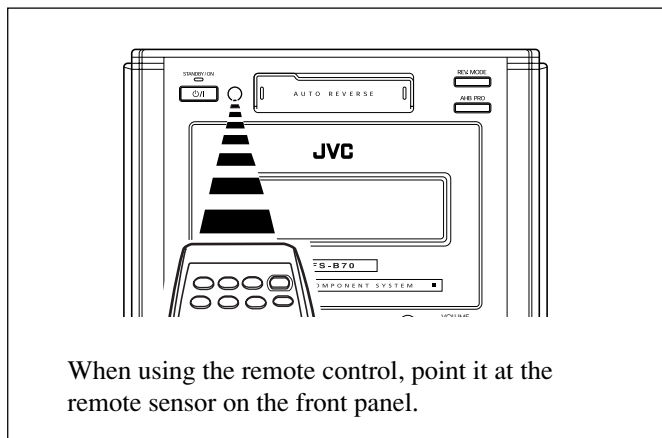

Unpacking

After unpacking, check to be sure that you have all the following items.

The number in parentheses indicates the quantity of each piece supplied.

- FM antenna (1)
- AM loop antenna (1)
- Remote control (1)
- Batteries (2)

If any item is missing, consult your dealer immediately.

Connecting Antennas

FM antenna

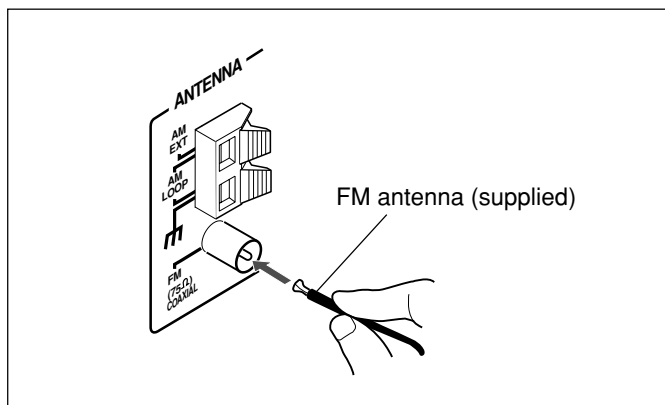

1 Attach the FM antenna to the FM (75 Ω) COAXIAL terminal.

2 Extend the FM antenna.

3 Fasten it up in a position which gives you the best reception, then attach it to the wall, etc.



About the supplied FM antenna

The FM antenna supplied with this unit can be used as a temporary measure. If reception is poor, you can connect an outdoor FM antenna.

To connect an outdoor FM antenna

Before connecting it, disconnect the supplied FM antenna.

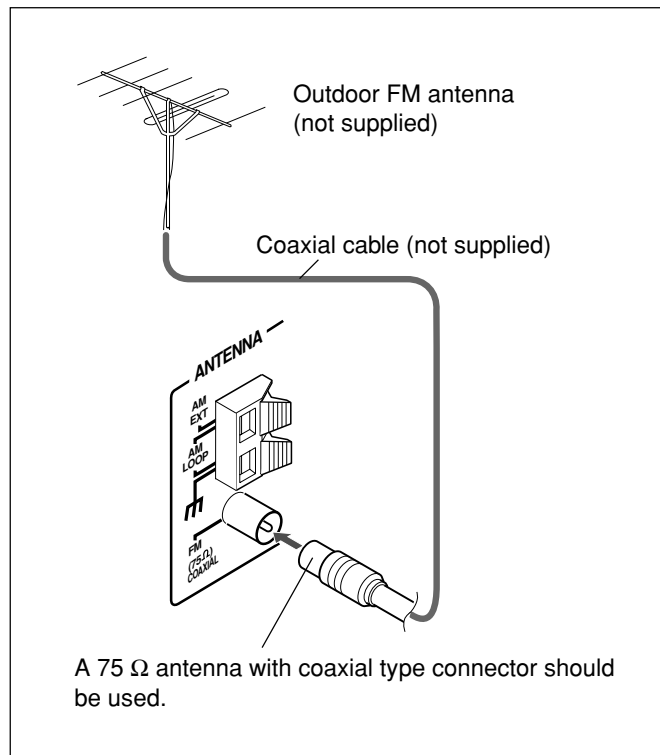

AM antenna

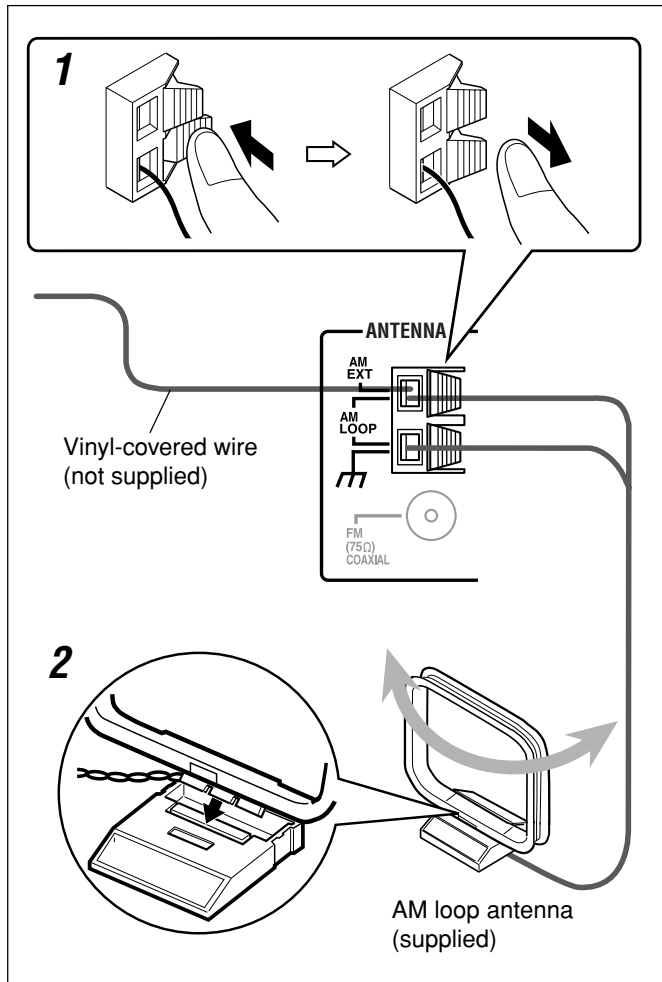

- 1** Connect the AM loop antenna to the AM LOOP terminals as illustrated.
- 2** Turn the AM loop antenna until you have the best reception.

To connect an outdoor AM antenna

When reception is poor, connect a single vinyl-covered wire to the AM EXT terminal and extend it horizontally. The AM loop antenna must remain connected.



For better reception of both FM and AM

- Make sure the antenna conductors do not touch any other terminals or connecting cords.
- Keep the antennas away from metallic parts of the unit, connecting cords, and the AC power cord.

Connecting Speakers

To connect speakers

You can connect the speakers using the speaker cords.

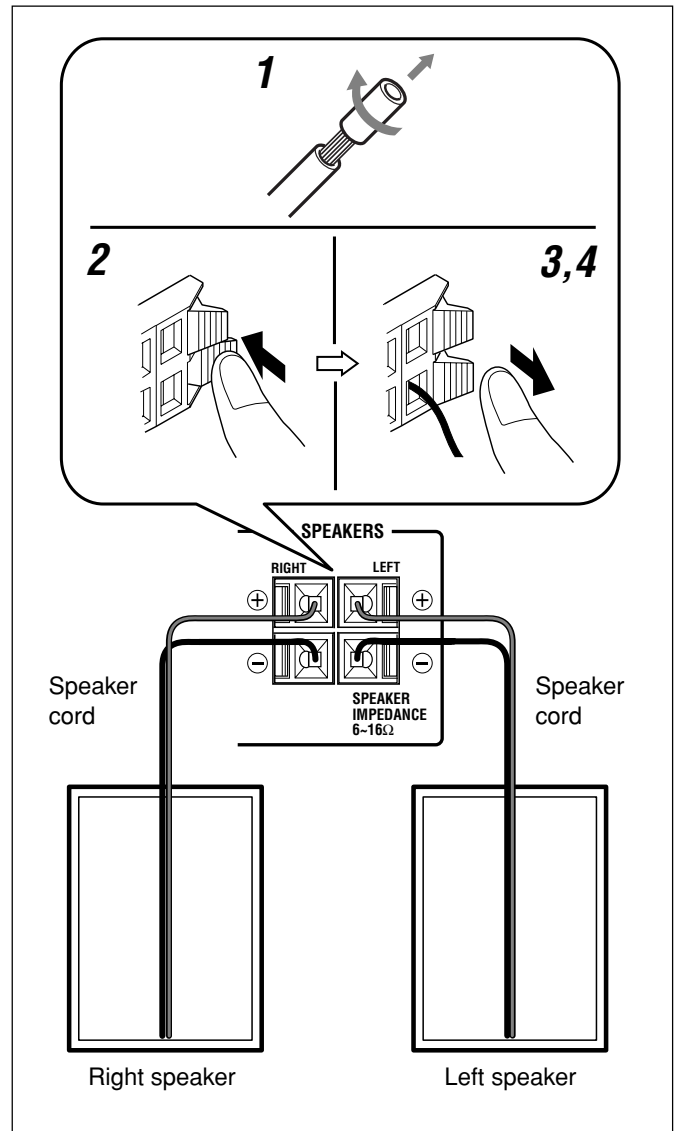

- 1** If the cords are covered with insulation, remove a short section of insulation at the end of each cord by twisting and pulling it off.
- 2** Hold the clamp of the speaker terminal.
- 3** Insert the end of the speaker cord into the terminal.
Match the polarity of the speaker terminals: \oplus to \oplus and \ominus to \ominus .
- 4** Release your finger from the clamp.

IMPORTANT:

- Use only speakers with the same speaker impedance as indicated by the speaker terminals on the rear of the unit.
- DO NOT connect more than one speaker to one speaker terminal.

To remove the speaker grilles

The speaker grilles are removable as illustrated below:

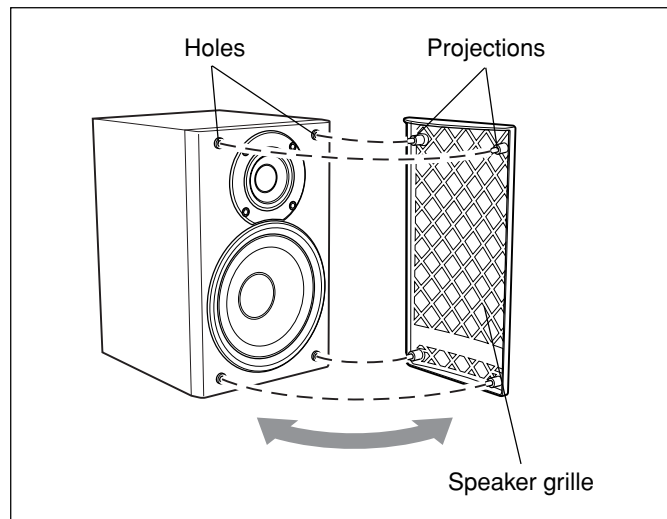

To remove the speaker grille, insert your fingers at the top of the speaker grille, then pull towards you. Also pull the bottom towards you.

To attach the speaker grille, follow the illustration above.

Connecting Other Equipment

You can connect audio equipment—used only as a playback device.



- DO NOT connect any equipment while the power is on.
- DO NOT plug in any equipment until all connections are complete.

To connect audio equipment

Be sure that the plugs of the audio cords are color coded: White plugs and jacks are for left audio signals, and red ones for right audio signals.

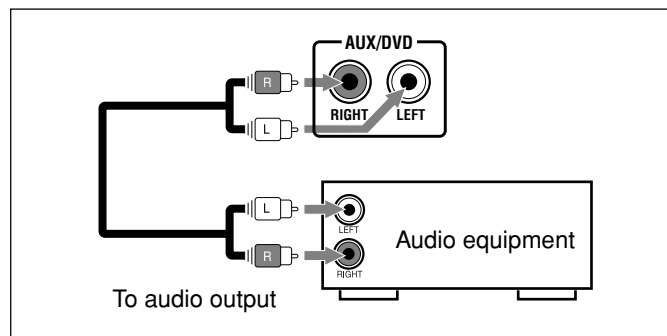

To play the other equipment through this unit, connect between the audio output jacks on the other equipment and AUX/DVD jacks by using audio cords (not supplied).

NOW you are ready to plug in the unit and any other connected equipment.

IMPORTANT:

Be sure to check that all connections have been made before plugging in the power cord.

Putting the Batteries into the Remote Control

Insert the batteries—R6(SUM-3)/AA(15F)—into the remote control by matching the polarity (+ and –) on the batteries with the + and – marking on the battery compartment. When the remote control can no longer operate the unit, replace both batteries at the same time.

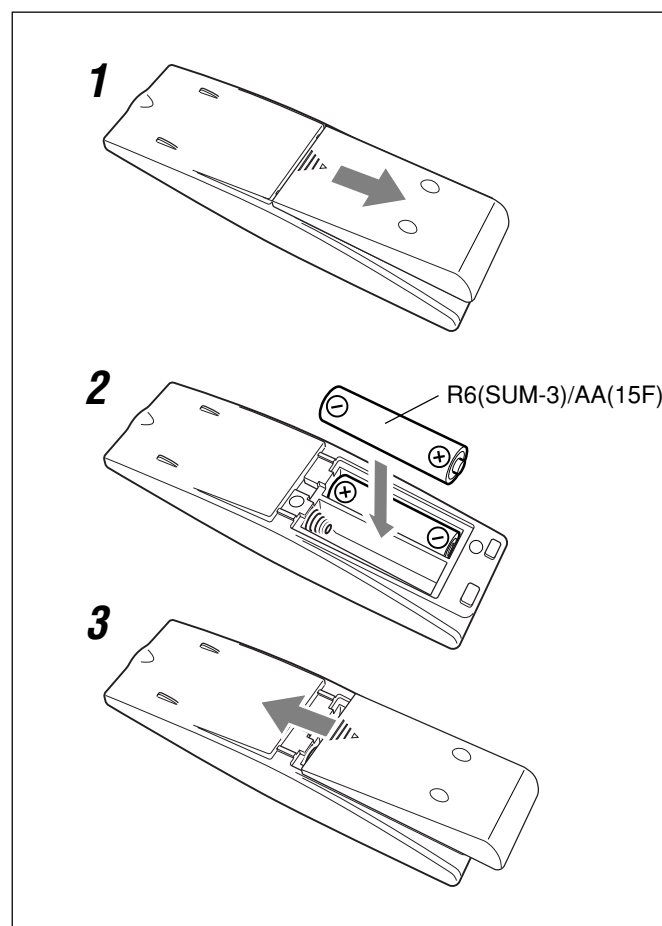

- DO NOT use an old battery together with a new one.
- DO NOT use different types of batteries together.
- DO NOT expose batteries to heat or flame.
- DO NOT leave the batteries in the battery compartment when you are not going to use the remote control for an extended period of time. Otherwise, the remote control will be damaged from battery leakage.

Basic and Common Operations

Setting the Clock

Before operating the unit any further, first set the unit's clock. When you plug in the power cord, "AM 12:00" starts flashing on the display.

You can set the clock when the unit is either turned on or in standby mode.

On the remote control ONLY:

1 Press CLOCK/TIMER.

The hour digits start flashing on the display.

AM 12:00



2 Press ^ UP or v DOWN to adjust the hour, then press CLOCK/TIMER.

The minute digits start flashing.

- When you press and hold ^ UP or v DOWN, the hour digit changes continuously.

PM 7:00

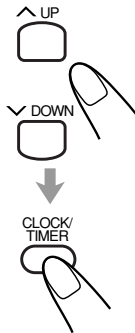

3 Press ^ UP or v DOWN to adjust the minute, then press CLOCK/TIMER.

The built-in clock starts.

PM 7:12



- **When you unplug the power cord or if a power failure occurs**
The clock is reset to "AM 12:00" right away. If this happens, set the clock again.
- **The clock may gain or lose 1 to 2 minutes per month**
If this happens, reset the clock.

To show the clock when the unit is turned on

On the remote control ONLY:

Press DISPLAY.

The clock indication appears on the display.

To return to the normal display, press DISPLAY again.

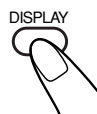

To change the clock

- 1 **Make sure the ☹ (timer) indicator and the timer mode indicator (DAILY or REC) are not lit on the display.**
 - If they are lit, press and hold CLOCK/TIMER until they go off.
- 2 **Press CLOCK/TIMER repeatedly until the unit enters the clock setting mode (the hour digits start flashing on the display).**
First time you press CLOCK/TIMER, the unit enters the timer setting mode. (See page 25.)
- 3 **Repeat steps 2 and 3 of the procedure "Setting the Clock."**
- 4 **Press and hold CLOCK/TIMER again so that the ☹ (timer) indicator and the timer mode indicator (DAILY or REC) go off.**

To turn off the clock indication (power save mode)

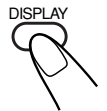

On the remote control ONLY:

Press DISPLAY while the unit is in standby mode. "DISPLAY OFF" appears on the display and the clock indication goes off.





To turn on the clock indication, press DISPLAY again while the unit is in standby mode. "DISPLAY ON" appears on the display.



Turning On the Power

To turn on the unit, press STANDBY/ON  (or  on the unit).

The STANDBY/ON lamp on the unit lights green.

- When you press the source button—/|| CD,  TAPE, FM/AM and AUX (or AUX/DVD on the unit), the unit automatically turns on and starts playback if the source is ready.
- Pressing one of the disc eject buttons (CD1▲ – CD5▲) also turns on the unit. (See page 15.)
- Pressing ▲ (tape eject) also turns on the unit. (See page 20.)
- Pressing one of the disc number buttons (CD 1 – CD 5) on the remote control also turns on the unit and starts playback if discs are on the corresponding disc trays. (See page 16.)



To turn off the unit (standby), press STANDBY/ON  (or  on the unit) again.

The STANDBY/ON lamp on the unit lights red.

- “AM 12:00” flashes on the display until you set the built-in clock. After setting the clock, the clock time will appear on the display while the unit is on standby.
- A little power is always consumed even while the unit is in standby mode.

To switch off the power supply completely, unplug the AC power cord from the AC outlet.



When you unplug the AC power cord or if a power failure occurs

The clock is reset to “AM 12:00” right away, while the tuner preset stations will be erased in a few days.

To turn off the unit automatically (Auto Standby)

Using the Auto Standby function, the unit automatically turns itself off if no sound comes in for more than 3 minutes when “CD” or “TAPE” is selected as the source.

If an operation is done within this 3-minute period, the Auto Standby function is canceled temporarily even though no sound comes in.

- You can also turn off the unit automatically by using the sleep timer. (See page 27.)

On the remote control ONLY:

To activate the Auto Standby function, press A.STANDBY.

The AUTO STANDBY indicator lights up on the display.

- When no sound comes in, the AUTO STANDBY indicator starts flashing on the display. About 5 seconds before the unit turns itself off, “AUTO STANDBY” starts flashing on the display.

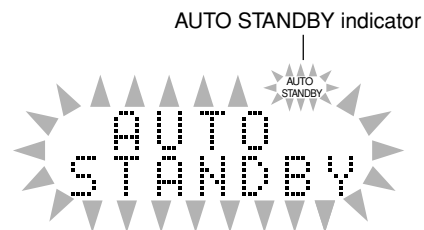

To deactivate the Auto Standby function, press A.STANDBY.

The AUTO STANDBY indicator goes off.

Adjusting the Volume

You can adjust the volume level only while the unit is turned on. The volume level can be adjusted between “VOLUME MIN” and “VOLUME 1” – “VOLUME 40 (VOLUME MAX).”

- The volume level has no effect on recording.

On the remote control:

To increase the volume, press VOLUME +.

To decrease the volume, press VOLUME –.

- When you press and hold either button, you can change the volume level continuously.



On the unit:

To increase the volume, turn the VOLUME + / – control clockwise.

To decrease the volume, turn the VOLUME + / – control counterclockwise.

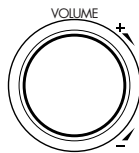

VOLUME 10



For private listening

Connect a pair of headphones to the PHONES jack. No sound comes out of the speakers. Be sure to turn down the volume before connecting or putting on the headphones.



DO NOT turn off (standby) the unit with the volume set to an extremely high level; Otherwise, the sudden blast of sound can damage your hearing, speakers and/or headphones when you turn on the unit or start playing any source. REMEMBER you cannot adjust the volume level while the unit is in standby mode.

Reinforcing the Bass Sound

The richness and fullness of the bass sound is clearly maintained regardless of how low you set the volume —Active Hyper Bass Pro.

- This function also affects the sound from headphones.
- This function only affects the playback sound, and does not affect your recording.

To get the effect, press AHB PRO repeatedly so that “AHB BASS1” or “AHB BASS2” appears on the display.

The **AHB PRO** indicator also lights up on the display.

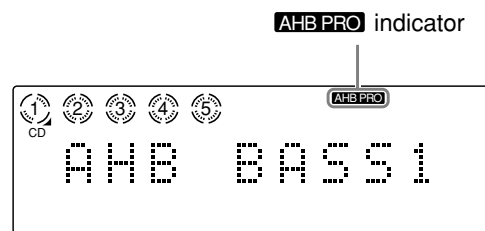

- Each time you press the button, the Active Hyper Bass Pro mode changes as follows:

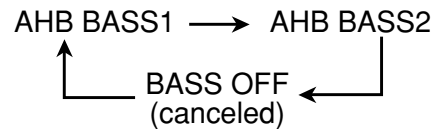

- “AHB BASS2” is more effective than “AHB BASS1.”

To cancel the effect, press AHB PRO repeatedly until “BASS OFF” appears on the display.

The **AHB PRO** indicator goes off.

Adjusting the Tone

You can adjust the bass level (low frequency range) and the treble level (high frequency range) within a range of “-5” to “+5.”

When shipped, each level is set to “+2.”

- This function also affects the sound from headphones.
- This function only affects the playback sound, and does not affect your recording.
- There is a time limit in doing the following steps. If the setting is canceled before you finish, start again from step 1.

On the remote control:

- 1** Press **BASS** to adjust the bass level or press **TREBLE** to adjust the treble level.

Current setting
BASS 0

Ex.: When you select “BASS.”



- 2** Press **^ UP** to increase the level or press **∨ DOWN** to decrease the level.

BASS +2

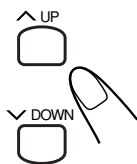

On the unit:

- 1** Press **BASS** to adjust the bass level or press **TREBLE** to adjust the treble level.

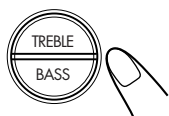

- 2** Press **▶▶ UP** to increase the level or press **◀◀ DOWN** to decrease the level.

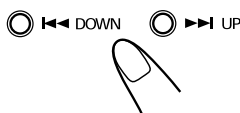

Changing the Display Brightness

You can change the display brightness only while the unit is turned on.

On the remote control ONLY:

Press **DIMMER** while the unit is turned on.

- Each time you press the button, the display brightness changes as follows:



DIMMER 1: The display illumination dims.



DIMMER 2: The display illumination dims and the blue illumination on the display disappears.



DIMMER OFF: The display and blue illumination resumes.



(back to the beginning)



Turning off the unit (standby) sets the display brightness back to “DIMMER OFF.”

Listening to FM and AM Broadcasts

Tuning in to a Station

1 Press FM/AM to select either “FM” or “AM.”

The unit automatically turns on and tunes in to the previously received station—either FM or AM.

- Each time you press the button, the band alternates between FM and AM.

FM 87.5 MHz



2 Press and hold >>> or <<< (or >>> UP or <<< DOWN on the unit) for more than 1 second.

- >>> (>>> UP): Increases the frequencies.
- <<< (<<< DOWN): Decreases the frequencies.

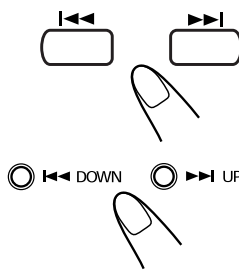

The unit starts searching for stations and stops when a station of sufficient signal strength is tuned in.

- If an FM program is broadcast in stereo, the STEREO indicator lights up on the display (only when the reception is good).

To stop during searching, press >>> or <<< (or >>> UP or <<< DOWN on the unit).



When you repeatedly press >>> or <<< (or >>> UP or <<< DOWN on the unit)

The frequency changes step by step.

To change the FM reception mode

On the remote control ONLY:

When an FM stereo broadcast is hard to receive or noisy, press FM MODE so that the MONO indicator lights up on the display. Reception will improve.



To restore the stereo effect, press FM MODE again so that the MONO indicator goes off. In stereo mode, you can hear stereo sound when a stereo program is broadcast.

Presetting Stations

You can preset 30 FM and 15 AM stations manually.

In some cases, test frequencies have been already stored for the tuner since the factory examined the tuner preset function before shipment. This is not a malfunction. You can preset the stations you want into memory by following the presetting method.

- There is a time limit in doing the following steps. If the setting is canceled before you finish, start again from step 2.

On the remote control ONLY:

1 Press FM/AM to select either “FM” or “AM.”

The unit automatically turns on and tunes in to the previously received station—either FM or AM.

- Each time you press the button, the band alternates between FM and AM.

FM 87.5 MHz



2 Press SET.

“SET” starts flashing on the display.

FM SET 87.5 MHz



3 Press ^ UP or v DOWN to select a preset number.

FM 14 87.5 MHz

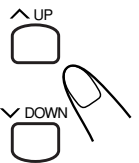

You can also select the preset number by the number buttons.

Ex.: For preset number 5, press 5.

For preset number 15, press +10, then 5.

For preset number 20, press +10, then 10.

For preset number 30, press +10, +10, then 10.

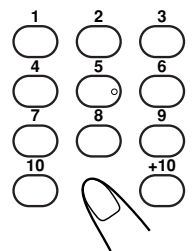

4 Press SET again.

“STORED” appears on the display for a while.

STORED

The tuned station in step **1** is stored in the preset number selected in step **3**.

- Storing a new station on an already assigned number erases the previously stored one.

**To tune in to a preset station directly using the number buttons****On the remote control ONLY:**

Pressing the number button(s) allows you to select the preset number you want.

Ex.: For preset number 5, press 5.

For preset number 15, press +10, then 5.

For preset number 20, press +10, then 10.

For preset number 30, press +10, +10, then 10.

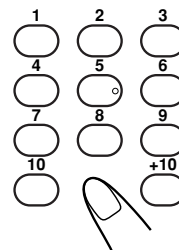

When you unplug the AC power cord or if a power failure occurs

The FM and AM preset stations will be erased in a day. If this happens, preset the stations again.

Tuning in to a Preset Station**On the remote control ONLY:****1 Press FM/AM to select either “FM” or “AM.”**

The unit automatically turns on and tunes in to the previously received station—either FM or AM.

- Each time you press the button, the band alternates between FM and AM.

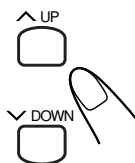
**2 Press ^ UP or v DOWN to select a preset number.**

Playing Back Discs on the 5-CD Changer

This unit has been designed to play back the following discs—CD, CD-R, and CD-RW.

When playing a CD-R or CD-RW

User-edited CD-Rs (CD-Recordable) and CD-RWs (CD-ReWritable) can be played only if they are already “finalized.”

- Usually you can play back your original CD-Rs or CD-RWs recorded in music CD format. However, sometimes they may not play depending on their characteristics or recording conditions.
- Before playing CD-Rs or CD-RWs, read their instructions or cautions carefully.
- Some CD-Rs or CD-RWs may not play on this unit because of their disc characteristics, damage or stain on them, or if the player’s lens is dirty.
- CD-RWs may require a longer readout time. This is because the reflectance of CD-RWs is lower than for regular discs.

General notes

In general, you will have the best performance by keeping your discs and the mechanism clean.

- Store discs in their cases, and keep them in cabinets or on shelves.
- Keep the unit’s disc trays closed when not in use.

Continued use of irregular shape discs (heart-shape, octagonal, etc.) can damage the unit.



About the disc indicators

Disc number indicator



While playback is stopped.

Current disc indicator



During playback

1

When no disc is on the tray.

- When the current source is “CD,” the CD indicator also lights up on the display.

Loading Discs

On the unit ONLY:

- 1 Press one of the disc eject buttons (CD1▲ – CD5▲) for the disc tray you want to load a disc onto.

The unit automatically turns on and the selected disc tray comes out.



- 2 Place a disc correctly on the circle of the disc tray, with its label side up.

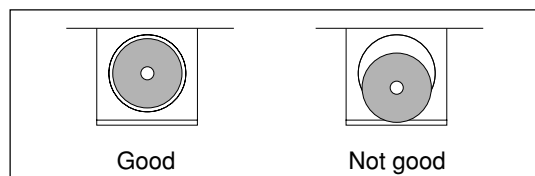
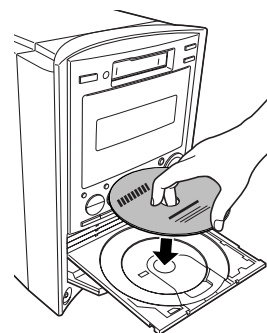

- When using a CD single (8 cm), place it on the inner circle of the disc tray.

- 3 Press the same disc eject button (CD1▲ – CD5▲) you have pressed in step 1.

The disc tray closes.



When loading more than one disc at a time

Press the disc eject button (CD1▲ – CD5▲) for the next tray you want to place a disc onto. The first disc tray automatically closes and the next disc tray comes out.

Playing Back All the Entire Discs —Continuous Play

You can play discs continuously.

1 Load discs into the 5-CD Changer.

2 Select a disc and start playback.

On the remote control:

Press one of the disc number buttons (CD 1 – CD 5).

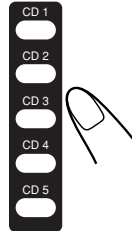

On the unit:

1 Press DISC SELECT repeatedly to select the disc you want.



2 Press ▷/|| CD.



Playback starts from the first track of the selected disc.

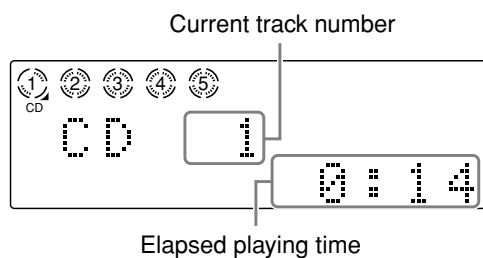

- Without selecting the disc number, pressing ▷/|| CD starts playing back the currently selected disc.

To stop play for a moment, press ▷/|| CD.

While pausing, the elapsed playing time flashes on the display.

To resume play, press ▷/|| CD again.



To stop during play, press ■.



To remove discs, press the corresponding disc eject buttons (CD1▲ – CD5▲) on the unit.



Disc playback sequence in the 5-CD Changer

When 5 discs are loaded on the disc trays*, they are played in the following sequence:

Ex.: When playback is started from the CD 2 tray:

CD 2 ⇒ CD 3 ⇒ CD 4 ⇒ CD 5 ⇒ CD 1 (then stops)

* If no disc is on the disc tray, 5-CD Changer skips that tray.

To start Continuous Play while a source other than "CD" is selected

On the unit ONLY:

1 Press DISC SELECT while listening to a source other than "CD."



The following indication appears on the display.



- Each time you press the button, the disc tray number changes as follows:

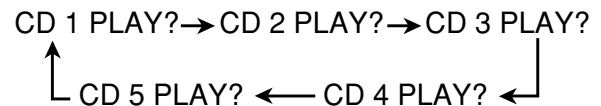

2 Press ▷/|| CD while the indication in step 1 still remains on the display.

Now the source is changed to "CD" and Continuous Play starts from the selected disc.



Basic Disc Operations

To exchange a disc during playback of another disc

On the unit ONLY:

Press the disc eject buttons (CD1▲ – CD5▲) to eject a disc not currently playing.



If discs are exchanged during playback, playback will stop after playing all newly inserted discs.

To start playing a disc during playback of another disc

On the remote control:

Press one of the disc number buttons (CD 1 – CD 5).
The selected disc starts to play.

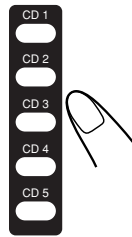

On the unit:

Press DISC SELECT repeatedly.
Each time you press the button, the next disc is selected.



To locate a particular point in a track during play

On the remote control:

Press and hold **▶▶▶** or **◀◀◀**.

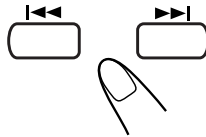

On the unit:

Press and hold **▶▶▶ UP** or **◀◀◀ DOWN**.

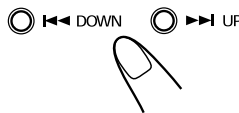

- **▶▶▶ (▶▶▶ UP):** Fast-forwards the tracks.
- **◀◀◀ (◀◀◀ DOWN):** Fast-reverses the tracks.

To go to another track

On the remote control:

Press **▶▶▶** or **◀◀◀** repeatedly.

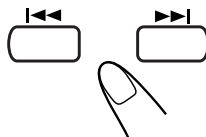

On the unit:

Press **▶▶▶ UP** or **◀◀◀ DOWN** repeatedly.

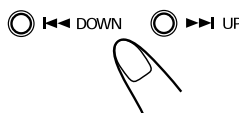

- **▶▶▶ (▶▶▶ UP):** Skips to the beginning of the next or succeeding tracks.
 - You can skip to tracks on the next disc.
- **◀◀◀ (◀◀◀ DOWN):** Goes back to the beginning of the current or previous tracks.
 - You cannot skip back to tracks on the previous disc.

To go to another track directly using the number buttons

On the remote control ONLY:

Pressing the number button(s) allows you to start playing the track number on the current disc.

- Ex.: For track number 5, press 5.
For track number 15, press +10, then 5.
For track number 20, press +10, then 10.
For track number 30, press +10, +10, then 10.

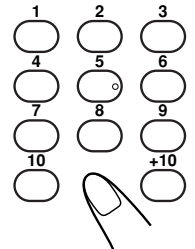

Programing the Track Playing Order —Program Play

You can arrange the order in which the tracks play before you start playing. You can program up to 32 tracks.

- In the Program Play mode, you cannot exchange a disc. (You cannot open the disc trays.)

On the remote control ONLY:

1 Load discs into the 5-CD Changer.

- If the current playing source is not “CD,” press **▶/|| CD**, then **■** before going to the next step.

2 Press PLAY MODE repeatedly until “CD PROGRAM” appears on the display.



The PRGM indicator also lights on the display.

PRGM indicator



- Each time you press the button, play mode changes as follows:

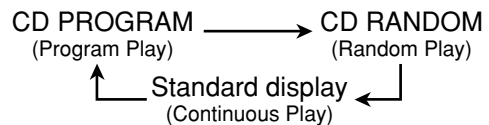

3 Press one of the disc number buttons (CD 1 – CD 5) to select the disc number you want to play.

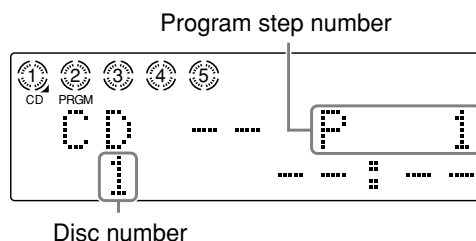

4 Press the number buttons to select a track from the disc selected in the above step.

- For how to use the number buttons, see "To go to another track directly using the number buttons" on the previous page.

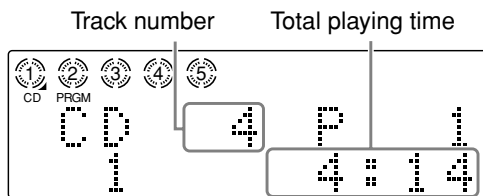
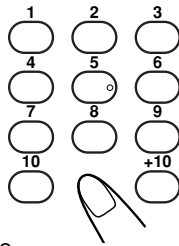

If you try to program a 33rd track "MEMORY FULL" will appear on the display.



When "NO PROGRAM" appears on the display

- You are trying to program a track from an empty tray, or a track number that does not exist on the disc.
- You are selecting the disc that the unit has not read yet.



If the total playing time exceeds 100 minutes

The total playing time on the display will not be shown. "-- : --" will appear.

5 Program other tracks you want.

- To program tracks from the same disc, repeat step 4.
- To program tracks from a different disc, repeat steps 3 and 4.

6 Press ►/|| CD.

The tracks are played in the order you have programmed.



To stop during play, press ■.



To exit from the Program Play mode, before or after play, press PLAY MODE once or twice so that the unit enters another disc playback mode (Random Play or Continuous Play). The PRGM indicator goes off.

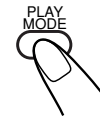

- Turning off the unit also cancels Program Play and changes the disc playback mode to Continuous Play.

To check the program contents

Before playing, you can check the program contents by pressing ►►| or |◄◄.

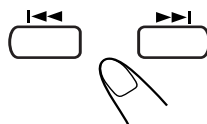

- |: Shows the programmed tracks in the programmed order.
- |◄◄: Shows them in the reverse order.
 - Pressing |◄◄ first time after you have programmed shows the first track in the program.

To modify the program

Before playing, you can erase the last programmed track by pressing CANCEL.

Each time you press the button, the last programmed track is erased from the program.



To add tracks to the program before playing, simply select disc numbers and track numbers you want to add by following steps 3 and 4.

- In the Program Play mode, you cannot exchange a disc to add tracks on another disc to the program. (You cannot open the disc trays.)

Playing at Random—Random Play

The tracks of all loaded discs will play at random.

On the remote control ONLY:

1 Load discs into the 5-CD Changer.

- If the current playing source is not "CD," press ►/|| CD, then ■ before going to the next step.

2 Press PLAY MODE repeatedly until "CD RANDOM" appears on the display.

The RANDOM indicator also lights on the display.

RANDOM indicator



- Each time you press the button, play mode changes as follows:

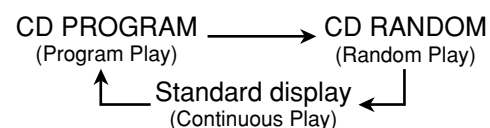

3 Press ►/|| CD.

The tracks are played at random. Random Play stops when all the tracks are played once.



To stop during play, press ■.

- Opening a disc tray also stops and cancels Random Play.

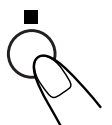

To skip the current track, press ►►|.

- The |◄◄ button does not work during Random Play.

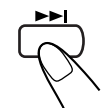

To exit from the Random Play mode, before or after play, press PLAY MODE once or twice so that the unit enters another disc playback mode (Continuous Play or Program Play).



The RANDOM indicator goes off.

- Turning off the unit also cancels Random Play and changes the disc playback mode to Continuous Play.

Repeating Tracks or Discs—Repeat Play

You can repeat each track, each disc, or all discs in the 5-CD Changer as many times as you like. You can also repeat your program.

On the remote control ONLY:

Press REPEAT repeatedly during or before playing.



CD
REPEAT 1

- Each time you press the button, the Repeat Play mode changes and appears on the display as follows:

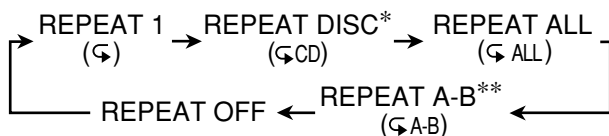

- “REPEAT 1”: Repeats one track.
- “REPEAT DISC”*: Repeats all tracks on one disc.
- “REPEAT ALL”: Repeats all tracks on all discs (continuously or at random), or all tracks in the program.
- “REPEAT A-B”**: Repeats the selected portion. (See the right column.)
- “REPEAT OFF”: Cancels Repeat Play.

* “REPEAT DISC” is not used for Program Play or Random Play.

** “REPEAT A-B” appears only during play.

A-B Repeat Play

While playing, you can select a portion of sound you want to repeat.

- During Program Play (see page 17) or Random Play (see page 18), you cannot perform A-B Repeat Play.

On the remote control ONLY:

1 Press REPEAT repeatedly during play to select “REPEAT A-B.”

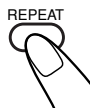

“A” starts flashing.

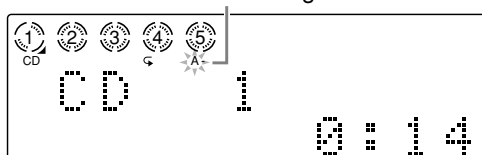

2 Press SET at the starting point from which you want to repeat (point A).



“B” starts flashing.

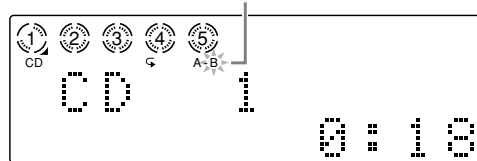

3 Press SET again at the end point to which you want to repeat (point B).



The unit automatically locates point A and starts repeating the portion between points A and B.

To cancel A-B Repeat Play, press REPEAT to select “REPEAT OFF.” A-B Repeat Play is canceled and normal playback continues from that point.



More about A-B Repeat Play

- A-B Repeat Play will be canceled in the following case:
 - When you press ►► or ◀◀.
 - When you press ►/|| CD.
- A-B Repeat Play is possible only within the same disc.

Prohibiting Disc Ejection

You can prohibit disc ejection from the unit and can lock discs—Disc Lock.

You can lock or unlock discs when the unit is either turned on or in standby mode.

On the unit ONLY:

To prohibit disc ejection, while holding ■, press ◻/I.



“LOCKED” appears on the display for a while, and the loaded discs are locked.

- The loaded cassette is also locked. (See page 20.)

LOCKED

If you try to eject a locked disc, “LOCKED” appears to inform you that the Disc Lock is in use.

To cancel the prohibition and unlock the disc, repeat the above procedure.

“UNLOCKED” appears on the display for a while, and the loaded discs are unlocked.

Playing Back Tapes

Playing Back a Tape

You can play back type I tapes.

1 Insert a cassette into the cassette compartment with the exposed part of the tape facing left.

- When the unit is turned on, the [] and tape operation indicators appear on the display.

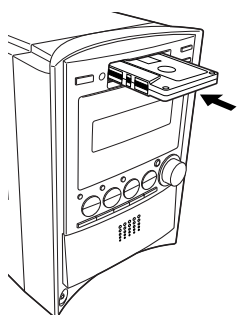

2 Press ◀▶ TAPE.

Playback starts (if the unit is in standby, the unit automatically turns on).

To change the tape direction, press ◀▶ TAPE.

- Each time you press the button, the tape direction changes as follows:
 - ▤ : Plays the front side.
 - ▥ : Plays the reverse side.

Tape direction and Reverse Mode indicators

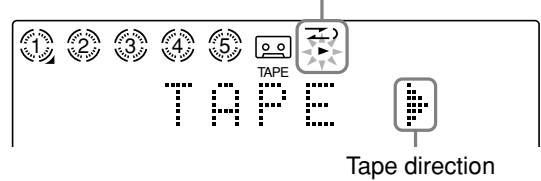

When the tape plays to the end, the deck automatically stops if the reverse mode is set to ▥ or ▥). (See "To play both sides—Reverse Mode" on the right column.)

To stop during play, press ■.

To fast-wind or rewind the tape, press ◀◀ or ▶▶ (or ▶▶| UP or ◀◀| DOWN on the unit).

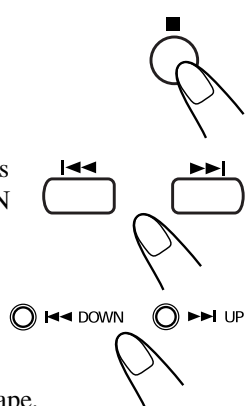

- When the tape direction is ▤
 - ▶▶| (▶▶| UP): Fast-winds the tape.
 - ◀◀| (◀◀| DOWN): Rewinds the tape.
- When the tape direction is ▥
 - ◀◀| (◀◀| DOWN): Fast-winds the tape.
 - ▶▶| (▶▶| UP): Rewinds the tape.

The tape direction indicator (▶ or ◀) starts flashing rapidly on the display.

To remove the cassette, push ▲ on the unit. The [] and tape operation indicators go off.



Pressing ▲ (tape eject) button also turns on the unit.

DO NOT press ▲ during tape play.

To play both sides—Reverse Mode

You can set the deck to play just one side or both sides of a tape once, or both sides continuously.

Press REV.MODE (reverse mode).

- Each time you press the button, the reverse mode changes as follows:

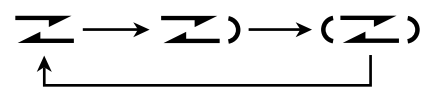

- ▤ : Plays back only one side (front or reverse).
- ▥ : Plays back the front and reverse sides once.
- (▥) : Plays back both front and reverse sides continuously.

- The use of C-120 or longer tape is not recommended, since characteristic deterioration may occur and this tape easily jams in the pinch rollers and the capstans.
- You can also play back type II and type IV tapes; however, the sound quality (tone) may not be reproduced properly.

Prohibiting Cassette Ejection

You can prohibit cassette ejection from the unit and can lock the cassette in the cassette compartment—Cassette Lock. You can lock or unlock the cassette when the unit is either turned on or in standby mode.

On the unit ONLY:

To prohibit cassette ejection, while holding ■, press ◻/|.



"LOCKED" appears on the display for a while, and the loaded cassette is locked.

- The loaded discs are also locked. (See page 19.)

LOCKED

If you try to eject a locked cassette, "LOCKED" appears to inform you that the Cassette Lock is in use.

To cancel the prohibition and unlock the cassette, repeat the above procedure.

"UNLOCKED" appears on the display for a while, and the loaded cassette is unlocked.

Recording

IMPORTANT:

- It may be unlawful to record or play back copyrighted material without the consent of the copyright owner.
- The recording level is automatically set correctly, so it is not affected by the other sound settings. Thus, during recording you can adjust the sound you are actually listening to without affecting the recording level.
- If recordings you have made have excessive noise or static, the unit may be too close to a TV. Increase the distance between the TV and the unit.
- You can only use type I tape for recording.



DO NOT use type II and type IV tapes since the unit is not compatible with such tapes.



The use of C-120 or longer tape is not recommended, since characteristic deterioration may occur and this tape easily jams in the pinch rollers and the capstans.



At the start and end of cassette tapes

There is leader tape which cannot be recorded onto. Thus, when recording from discs, FM/AM broadcasts, or external equipment, wind the leader tape first to ensure that the recording will be made without losing any music.

To protect your recordings

Cassettes have two small tabs on the back to protect against unexpected erasure or re-recording.

To protect your recording, remove these tabs.

To re-record on a protected tape, cover the holes with adhesive tape.

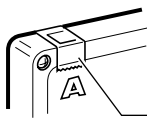

Adhesive tape

Recording on a Tape

1 Insert a recordable cassette into the cassette compartment with the exposed part of the tape facing left.

- See also page 20.

2 Check the recording direction for the tape.

- If the tape direction is not correct, press ◀▶ TAPE twice then ■ to change the tape direction.
- If you want to record on both sides of a tape, see “To record on both sides—Reverse Mode” below.

3 Start playing the source—FM, AM or auxiliary equipment connected to AUX/DVD jacks.

- When recording from discs, see “Recording Discs—Disc Synchronized Recording” on page 22.

4 Press REC (recording).

The **REC** (recording) indicator lights up on the display and recording starts.

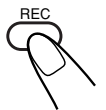

“NO REC” will appear on the display when you press REC in the following cases:

- If no cassette is inserted.
- If a protected tape is inserted.
- If any tray is open when the source is the CD player.

To stop while recording, press ■.

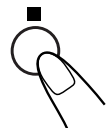

To remove the cassette, press ▲ on the unit.



To record on both sides—Reverse Mode

On the remote control ONLY:

Press REV.MODE (reverse mode) repeatedly so that the Reverse Mode indicator lights up like—Z) or (Z).



- The Reverse Mode indicator lights up on the display like—Z) while recording.
- Make sure that the tape direction is set to the forward (▶) direction before starting to record. Otherwise, recording will stop when only one side (reverse) of the tape is recorded.

To cancel the Reverse Mode, press the button so that the Reverse Mode indicator lights up like—Z .

Recording Discs

—Disc Synchronized Recording

You have three methods to record from discs onto a tape. Using the synchronized recording methods, you can start and stop disc play and recording at the same time.

- **One Disc Synchronized Recording**—Records the entire disc.
- **All Discs Synchronized Recording**—Records all loaded discs continuously (Continuous Play) or at random (Random Play), or the program you have made (Program Play). See page 23.
- **First Track Recording**—Records the first track of each disc. See page 24.
- **One Track Recording**—Records just the track you want during play. See page 24.
- Set the Reverse Mode and the tape direction properly to record on both side of the tape. (See page 21.)



If the front side of the tape ends in the middle of a track, the recording on the reverse side starts from the beginning of that track (if the reverse mode is set to .

However, when recording in the Random Play mode, recording on the reverse side does not start from the beginning of the track.



“NO REC” will appear on the display when you press REC in the following cases:

- If no cassette is inserted.
- If a protected tape is inserted.
- If any tray is open when the source is the CD player.

One Disc Synchronized Recording

1 Insert a recordable cassette into the cassette compartment with the exposed part of the tape facing left.

2 Load the disc you want to record into the 5-CD Changer.

3 Press the disc number button (CD 1 – CD 5) on the remote control to select the disc you want to record, then press .

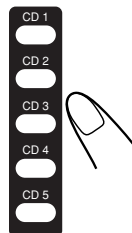

4 Press CD REC MODE on the remote control to select “1 CD.”

Each time you press the button, the recording mode changes as follows:

1 CD → ALL CD → 1ST TRACK

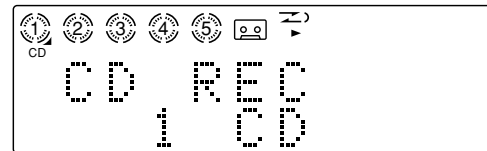

5 Press REC while “1 CD” still remains on the display.

The REC indicator lights up on the display and recording starts.

- Make sure to press the button before “1 CD” goes off; otherwise, recording will start in the All Discs Synchronized Recording mode (see page 23).

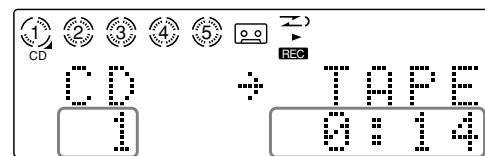

Current track number

Elapsed playing time

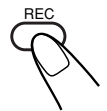

When the selected disc is recorded, recording will stop. Both the 5-CD changer and the cassette deck stop automatically.

To stop while recording, press .

The tape stops after 4 seconds.





To remove the cassette, press  on the unit.



When recording a disc

A 4-second blank is automatically made on the tape before each track. To record without the blank, follow the procedure below:

- 1 Load only the disc you want to record into the 5-CD Changer.
- 2 Press DISC SELECT on the unit to select the disc number you have loaded.
- 3 Press  CD on the unit twice so that disc playback is paused.
 - If the pausing position is not “0:00,” you can skip back to “0:00” by pressing  DOWN on the unit.
- 4 Press REC on the unit to start recording. When the disc is recorded, recording will stop.



You cannot exchange a disc while recording another disc.



Pressing CD REC MODE changes the disc playback mode to Continuous Play and cancels the Repeat Play mode.

All Discs Synchronized Recording

1 Insert a recordable cassette into the cassette compartment with the exposed part of the tape facing left.

2 Load discs into the 5-CD Changer.

- You can make a program (see page 17) or select the Random Play mode (see page 18) if you want. In this case, you cannot select the starting disc → go to step 5.

3 Press one of the disc number buttons (CD 1 – CD 5) on the remote control to select the disc you want to start recording from, then press ■.

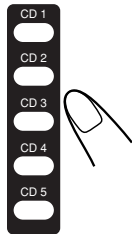

4 Press CD REC MODE on the remote control to select “ALL CD.”

Each time you press the button, The recording mode changes as follows:

1 CD → ALL CD → 1ST TRACK

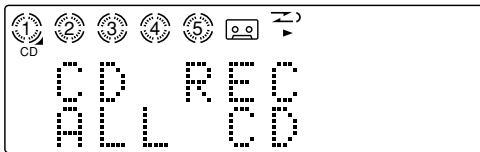

5 Press REC.

The **REC** indicator lights up on the display and recording starts.

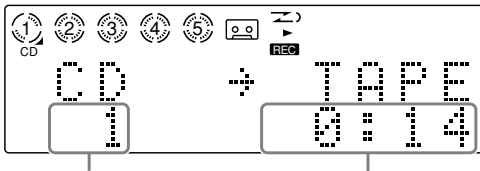

Current track number

Elapsed playing time

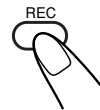

To stop while recording, press ■.
The tape stops after 4 seconds.



To remove the cassette, press ▲ on the unit.



When recording discs

A 4-second blank is automatically made on the tape before each track. To record without the blank, follow the procedure below:

- Load discs you want to record into the 5-CD Changer.
- Press DISC SELECT on the unit to select the disc number you have loaded.
- Press ▷/|| CD on the unit twice so that disc playback is paused.
 - If the pausing position is not “0:00,” you can skip back to “0:00” by pressing ◀◀ DOWN on the unit.
- Press REC on the unit to start recording.

When all loaded discs are recorded, recording will stop.



You cannot exchange a disc while recording another disc.



Pressing CD REC MODE changes the disc playback mode to Continuous Play and cancels the Repeat Play mode.

First Track Recording

First Track Recording allows you to record the first track of each loaded disc.

1 Insert a recordable cassette into the cassette compartment with the exposed part of the tape facing left.

2 Load discs into the 5-CD Changer.

3 Press one of the disc number buttons (CD 1 – CD 5) on the remote control to select the disc you want to start recording with, then press ■.

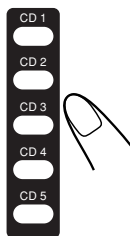

4 Press CD REC MODE on the remote control to select “1ST TRACK.”

Each time you press the button, The recording mode changes as follows:

1 CD → ALL CD → 1ST TRACK

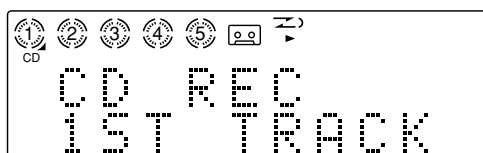

5 Press REC while “1ST TRACK” still remains on the display.

The **REC** indicator lights up on the display and recording starts.

- Make sure to press the button before “1ST TRACK” goes off; otherwise, recording will start in the All Discs Synchronized Recording mode (see page 23).

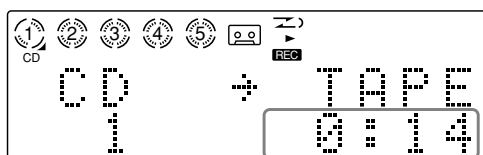

Elapsed playing time

When the first track of the selected disc is recorded, the first track of the next disc will be recorded.

First Track Recording will stop after all the first tracks on the loaded discs are recorded.

Both the 5-CD changer and the cassette deck stop automatically.

To stop while recording, press ■.

The tape stops after 4 seconds.



To remove the cassette, press ▲ on the unit.



You cannot exchange a disc while recording another disc.



Pressing CD REC MODE changes the disc playback mode to Continuous Play and cancels the Repeat Play mode.

One Track Recording

This recording method is convenient when you record tracks during play. You can record just the track you want.

1 Insert a recordable cassette into the cassette compartment with the exposed part of the tape facing left.

2 Press REC while playing the track you want to record.

The playback of the track is stopped, and the same track starts playing from the beginning.

This time, the cassette deck starts recording the track.

- After the track is recorded, both the 5-CD changer and the cassette deck stop automatically.

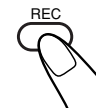

To stop while recording, press ■.

The tape stops after 4 seconds.

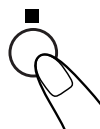

To remove the cassette, press ▲ on the unit.



Using the Timers

Three timers are available—Recording Timer, Daily Timer and Sleep Timer.

- Before using these timers, make sure the built-in clock is set correctly (see page 9).

Using the Daily Timer and the Recording Timer

You can set the timer when the unit is either turned on or in standby mode.

How the timer actually works

When the on-time comes, the unit automatically turns on (the ⌚ (timer) indicator flashes just before the on-time and continues flashing while the timer is operating). Then, when the off-time comes, the unit automatically turns off (standby). The timer setting remains in memory until you change it.

- When the DAILY indicator is lit on the display, the timer acts as the Daily Timer. Once the timer has been set, it will be activated at the same time everyday until the timer is turned off.
- When the REC indicator is lit on the display, the timer acts as the Recording Timer. After the timed-recording finishes, the details of the setting remain stored but the timer is turned off.

Before you start...

When using "TUNER" as the source to play, make sure to select the desired station before turning off the power.

- There is a time limit in doing the following steps. If the setting is canceled before you finish, start again from step 1.

On the remote control ONLY:

1 Press CLOCK/TIMER.

The ⌚ (timer) indicator lights up and the timer mode indicator (DAILY or REC) flashes on the display.

The unit enters the on-time setting mode.

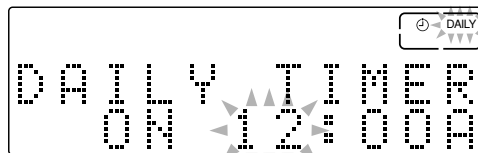

Ex.: When the Daily Timer has been selected the last time.

2 Set the on-time you want the unit to turn on.

- 1) Press ▲ UP or ▼ DOWN to set the hour, then press CLOCK/TIMER.
- 2) Press ▲ UP or ▼ DOWN to set the minute, then press CLOCK/TIMER.

The unit enters the off-time setting mode.

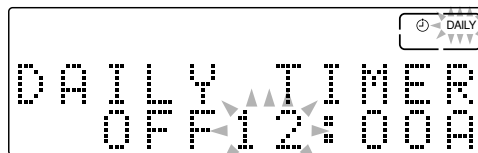
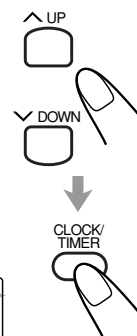

3 Set the off-time you want the unit to turn off.

- 1) Press ▲ UP or ▼ DOWN to set the hour, then press CLOCK/TIMER.
- 2) Press ▲ UP or ▼ DOWN to set the minute, then press CLOCK/TIMER.

The unit enters the source setting mode.

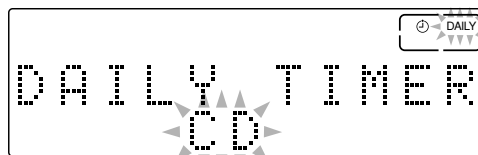
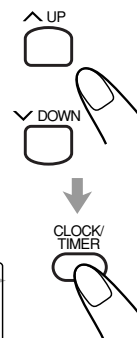

4 Press \wedge UP or \vee DOWN to select the timer mode (the Daily Timer or the Recording Timer) and the source to play, then press CLOCK/TIMER.

- Each time you press \wedge UP or \vee DOWN, the timer mode and the source to play change as follows:

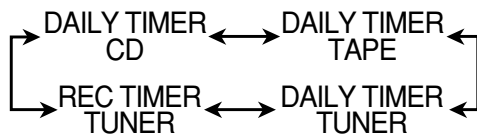

- **“DAILY TIMER CD”**: plays the selected disc or your program. (Daily Timer)
 - Load a disc or make the program.
 - go to step 5.
- **“DAILY TIMER TAPE”**: plays a tape. (Daily Timer)
 - Make sure that the tape is in the cassette deck.
 - Make sure that the tape direction is correct.
 - go to step 6.
- **“DAILY TIMER TUNER”**: tunes in to the last station you have been listening to. (Daily Timer)
 - go to step 6.
- **“REC TIMER TUNER”**: records the last station you have been listening to. (Recording Timer)
 - Put a recordable cassette into the deck.
 - Make sure that the tape direction and the Reverse Mode are correct.
 - go to step 6.

5 When selecting “DAILY TIMER CD” in step 4, select the disc number to play or Program Play.

- Press \wedge UP or \vee DOWN to select the disc number or Program Play.

- Each time you press the button, the indication on the display changes as follows:



- **“CD DISC 1”** – **“CD DISC 5”**: plays the selected disc.
- **“CD PROGRAM”**: plays the program you have made.

- Press CLOCK/TIMER.

The unit enters the volume level setting mode.

6 Press \wedge UP or \vee DOWN to set the volume level, then press CLOCK/TIMER.

- You can select the volume level between “VOLUME --” and “VOLUME 0” to “VOLUME 40.”
- If you select “VOLUME --,” the volume level is set to the current volume.
- To turn off the volume while the Recording Timer is working, set the volume level to “VOLUME 0.”

The selected timer mode indicator (DAILY or REC) stops flashing.

The unit enters the clock setting mode.

7 Adjust the clock if needed.

- See “Setting the Clock” on page 9.

8 Press STANDBY/ON \odot /I to turn off the unit if the unit is on.

When the timer turns on the unit, the \odot (timer) indicator and the selected timer mode indicator (DAILY or REC) start flashing.

To deactivate the timer temporarily, press and hold CLOCK/TIMER until the \odot (timer) indicator and the selected timer mode indicator (DAILY or REC) go off.

To activate and change the timer, repeat steps 1 to 7 on pages 25 and 26.

- Deactivate the timer first in the following cases:
 - If you want to change the Daily Timer setting
 - If you want to change the Recording Timer setting before the Recording Timer works.
- To activate the timer again without changing the setting, press CLOCK/TIMER repeatedly until the \odot (timer) indicator and the selected timer mode indicator (DAILY or REC) light up on the display.



If the unit is already turned on when the timer-on time comes

The timer does not work.



When you unplug the AC power cord or if a power failure occurs

The timer will be canceled. You need to set the clock first, then set the timer again.



When you have selected “CD PROGRAM” in step 5

Do not press DISPLAY while the unit is in standby mode to turn off the clock indication (“DISPLAY OFF”); otherwise, the program contents is cleared and playback starts in the Continuous Play mode when the timer-on time comes.

Using the Sleep Timer

With the Sleep Timer, you can fall asleep to your favorite music or radio program.

- You can set the Sleep Timer only when the unit is turned on.

How the Sleep Timer actually works

The unit automatically turns off after the specified length of time passes.

On the remote control ONLY:

1 Press SLEEP.

The SLEEP indicator lights up on the display. "SLEEP 10" appears on the display for a while.

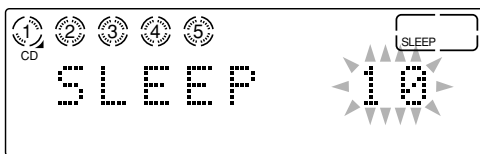

- Each time you press the button, the length of time changes as follows:

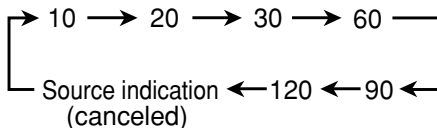

2 Wait for about 5 seconds after specifying the length of time.

To check the remaining time until shut-off time, press SLEEP once. The remaining time until shut-off time appears for about 5 seconds.

To change the shut-off time, press SLEEP repeatedly until the length of time you want appears.

To cancel the setting, press SLEEP repeatedly until the current source indication appears on the display.

The SLEEP indicator goes off.

- Turning off the unit also cancels the Sleep Timer.



If you set the Sleep Timer after the Daily Timer starts playing the selected source

The Daily timer is canceled. The unit turns off when the Sleep Timer shut-off time comes.



You cannot set the Sleep Timer while the Recording Timer is working.



You can also turn off the unit automatically by using the Auto Standby function. (See page 10.)

Maintenance

To get the best performance of the unit, keep your discs, tapes and mechanism clean.

General Notes

In general, you will have the best performance by keeping your discs, tapes and the mechanism clean.

- Store discs and tapes in their cases, and keep them in cabinets or on shelves.

Cleaning the unit

• Stains on the unit

Should be wiped off with a soft cloth. If the unit is heavily stained, wipe it with a cloth soaked in water-diluted neutral detergent and wrung well, then wipe clean with a dry cloth.

- **Since the unit may deteriorate in quality, become damaged or have its paint peel off, be careful about the following:**
 - DO NOT wipe it with a rough cloth.
 - DO NOT wipe it too vigorously.
 - DO NOT wipe it with thinner or benzine.
 - DO NOT apply any volatile substance such as an insecticide to it.
 - DO NOT allow any rubber or plastic to remain in contact with it for a long time.

Handling discs



- Remove the disc from its case by holding it at the edge while pressing the center hole lightly.
- Do not touch the shiny surface of the disc, or bend the disc.
- Put the disc back in its case after use to prevent warping.

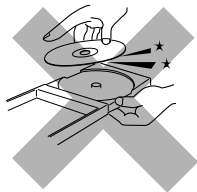

- Be careful not to scratch the surface of the disc when placing it back in its case.
- Avoid exposure to direct sunlight, temperature extremes, and moisture.



To clean the disc

Wipe the disc with a soft cloth in a straight line from center to edge.



DO NOT use any solvent—such as conventional record cleaner, spray, thinner, or benzine—to clean the disc.

Handling cassette tapes

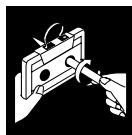

- If the tape is loose in its cassette, take up the slack by inserting a pencil in one of the reels and rotating.
- If the tape is loose, it may get stretched, cut, or caught in the cassette.



- Be careful not to touch the tape surface.



- Avoid storing tapes in any of the following places:
 - In dusty places
 - In direct sunlight or heat
 - In moist areas
 - On a TV or speaker
 - Near a magnet

To keep the best recording and playback sound quality

You need to clean the heads.

- Clean the heads after every 10 hours of use with a wet-type head cleaning tape (available at electronic and audio shops).
When the head becomes dirty, the following symptoms will occur:
 - Sound quality is reduced.
 - Sound level decreases.
 - Sound drops out.
- Do not play dirty or dusty tapes.
- Do not touch the highly-polished head with any metallic or magnetic tools.

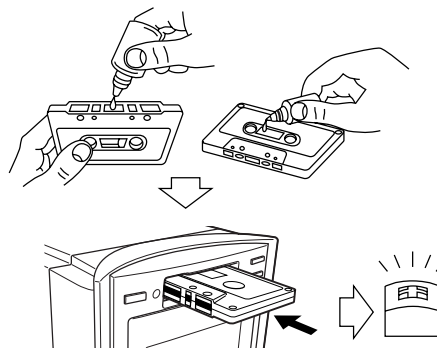

To demagnetize the head

Turn off the unit, and use a head demagnetizer (available at electronic and audio shops).

Troubleshooting

If you are having a problem with your unit, check this list for a possible solution before calling for service.

If you cannot solve the problem from the hints given here, or the unit has been physically damaged, call a qualified person, such as your dealer, for service.

Symptom	Possible Cause	Action
Power does not come on.	The power cord is not connected to an AC outlet.	Insert the plug into the socket.
No sound is heard.	<ul style="list-style-type: none"> • Connections are incorrect or loose. • A pair of headphones is connected. 	<ul style="list-style-type: none"> • Check all connections and make corrections. (See pages 6 to 8.) • Unplug the headphones from the PHONES jack.
Hard to listen to broadcasts because of noise.	<ul style="list-style-type: none"> • Antennas are disconnected. • The AM loop antenna is too close to the unit. • The FM antenna is not properly extended and positioned. 	<ul style="list-style-type: none"> • Reconnect the antenna correctly and securely. • Change the position and direction of the AM loop antenna. • Extend FM antenna and orient to the best reception position.
Loaded discs cannot be ejected.	<ul style="list-style-type: none"> • The AC power cord is not plugged in. • The Disc Lock function is in use. 	<ul style="list-style-type: none"> • Plug in the AC power cord. • Cancel the Disc Lock function. (See page 19.)
The disc does not play.	The disc is upside down.	Put the disc in with the label side up.
Loaded cassette cannot be ejected.	The Cassette Lock function is in use.	Cancel the Cassette Lock function. (See page 20.)
Impossible to record.	Small tabs on the back of the cassette are removed.	Cover the holes with adhesive tape.
Operations are disabled.	The built-in microprocessor has malfunctioned due to external electrical interference.	Unplug the AC power cord then plug it back in.
Unable to operate the unit by the remote control.	<ul style="list-style-type: none"> • The path between the remote control and the remote sensor on the unit is blocked. • The batteries are exhausted. • You are using the remote control too far from the unit. 	<ul style="list-style-type: none"> • Remove the obstruction. • Replace the batteries. (See page 8.) • Signals cannot reach the remote sensor. Move closer to the unit.

Specifications

Amplifier Section—CA-FSB70

Output Power: 74 W per channel, min. RMS, driven into 6 Ω at 1 kHz with no more than 10% total harmonic distortion.

Analog input sensitivity/Impedance (at 1 kHz)

AUX/DVD: 400 mV/48 k Ω

Speakers/Impedance: 6 Ω – 16 Ω

Tuner

FM tuning range: 87.5 MHz—108.0 MHz

AM tuning range: 530 kHz—1 710 kHz

CD player

CD Capacity: 5 CDs

Dynamic range: 87 dB

Signal-to-noise ratio: 90 dB

Wow and flutter: Immeasurable

Cassette deck

Frequency response:

Normal (type I): 60 Hz—14 000 Hz

Wow and flutter: 0.15 % (WRMS)

General

Power requirement: AC 120 V \sim , 60 Hz

Power consumption: 110 W (at operation)

17 W (on standby)

1.1 W (in power save mode)

Dimensions (W/H/D) (approx.):

175 mm x 239.5 mm x 378 mm

Mass (approx.):

8 kg

Supplied accessories

See page 6.

Speaker Section—SP-UXB70

Type: 2-way bass-reflex type

Speakers: Woofer 12 cm cone x1

Tweeter 2 cm dome x1

Power handling capacity: 60 W

Impedance: 6 Ω

Frequency range: 55 Hz to 20 kHz

Sound pressure level: 85 dB/W•m

Dimensions (W/H/D) (approx.):

145 mm x 239.5 mm x 202 mm

Mass (approx.):

2.5 kg each

Design and specifications are subject to change without notice.



Free Manuals Download Website

<http://myh66.com>

<http://usermanuals.us>

<http://www.somanuals.com>

<http://www.4manuals.cc>

<http://www.manual-lib.com>

<http://www.404manual.com>

<http://www.luxmanual.com>

<http://aubethermostatmanual.com>

Golf course search by state

<http://golfingnear.com>

Email search by domain

<http://emailbydomain.com>

Auto manuals search

<http://auto.somanuals.com>

TV manuals search

<http://tv.somanuals.com>