

# JVC



## COMPACT COMPONENT SYSTEM

# FS-X5

Consists of CA-FSX5 and SP-FSX5

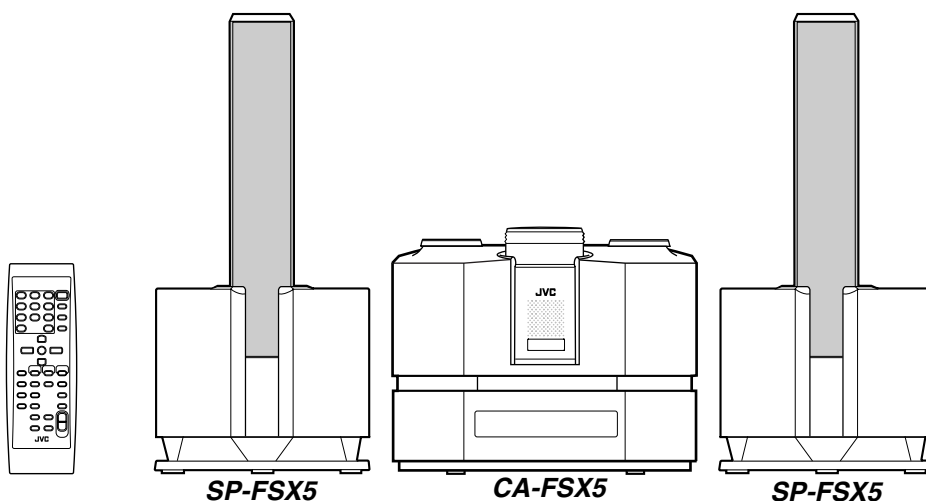

COMPACT  
**disc**  
DIGITAL AUDIO



## INSTRUCTIONS

**For Customer Use:**

Enter below the Model No. and Serial No. which are located either on the rear, bottom or side of the cabinet. Retain this information for future reference.

Model No. \_\_\_\_\_

Serial No. \_\_\_\_\_

LVT1041-002A

[B]

# Warnings, Cautions and Others

## IMPORTANT for the U.K.

DO NOT cut off the mains plug from this equipment. If the plug fitted is not suitable for the power points in your home or the cable is too short to reach a power point, then obtain an appropriate safety approved extension lead or consult your dealer.

**BE SURE** to replace the fuse only with an identical approved type, as originally fitted.

If nonetheless the mains plug is cut off ensure to remove the fuse and dispose of the plug immediately, to avoid a possible shock hazard by inadvertent connection to the mains supply.

If this product is not supplied fitted with a mains plug then follow the instructions given below:

## IMPORTANT:

**DO NOT** make any connection to the terminal which is marked with the letter E or by the safety earth symbol or coloured green or green-and-yellow.

The wires in the mains lead on this product are coloured in accordance with the following code:

Blue :Neutral

Brown :Live

As these colours may not correspond with the coloured markings identifying the terminals in your plug proceed as follows:

The wire which is coloured blue must be connected to the terminal which is marked with the letter N or coloured black.

The wire which is coloured brown must be connected to the terminal which is marked with the letter L or coloured red.

IF IN DOUBT - CONSULT A COMPETENT ELECTRICIAN.

## Caution —STANDBY/ON $\phi$ /I button!

Disconnect the main plug to shut the power off completely. The STANDBY/ON  $\phi$ /I button in any position does not disconnect the main line. The power can be remote controlled.

- When the unit is on standby, the STANDBY/ON indicator lights red.
- When the unit is turned on, the STANDBY/ON indicator lights green.

## IMPORTANT FOR LASER PRODUCTS

### CLASS 1 LASER PRODUCT

#### CAUTION

- 1 Invisible laser radiation when open and interlock failed or defeated. Avoid direct exposure to beam.

#### CAUTION

- 1 Do not open the top cover. There are no user serviceable parts inside the unit; leave all servicing to qualified service personnel.
- 2 Use of controls, adjustments or performance of procedures other than those specified herein may result in hazardous radiation exposure.

#### CAUTION

- 1 Do not block the ventilation openings or holes. (If the ventilation openings or holes are blocked by a newspaper or cloth, etc., the heat may not be able to get out.)
- 2 Do not place any naked flame sources, such as lighted candles, on the apparatus.
- 3 When discarding batteries, environmental problems must be considered and local rules or laws governing the disposal of these batteries must be followed strictly.
- 4 Do not expose this apparatus to rain, moisture, dripping or splashing and that no objects filled with liquids, such as vases, shall be placed on the apparatus.

#### CAUTION

#### ■ About the Internal Cooling Fan

This unit includes an internal cooling fan, so as to allow for high-power operation within a small space.

This fan comes on when the sound level is set high, and may also come on even at low sound levels if the internal temperature rises. To ensure effective fan operation, please leave at least 15cm clearance between the rear of the unit and the wall, and at least 1cm clearance on each side of the unit.

## CAUTION

To reduce the risk of electric shocks, fire, etc.:

- 1 Do not remove screws, covers or cabinet.
- 2 Do not expose this appliance to rain or moisture.

## Caution: Proper Ventilation

To avoid risk of electric shock and fire, and to prevent damage, locate the apparatus as follows:

- 1 Front : No obstructions and open spacing.
- 2 Sides/ Top/ Back : No obstructions should be placed in the areas shown by the dimensions below.
- 3 Bottom : Place on the level surface. Maintain an adequate air path for ventilation by placing on a stand with a height of 10 cm or more.

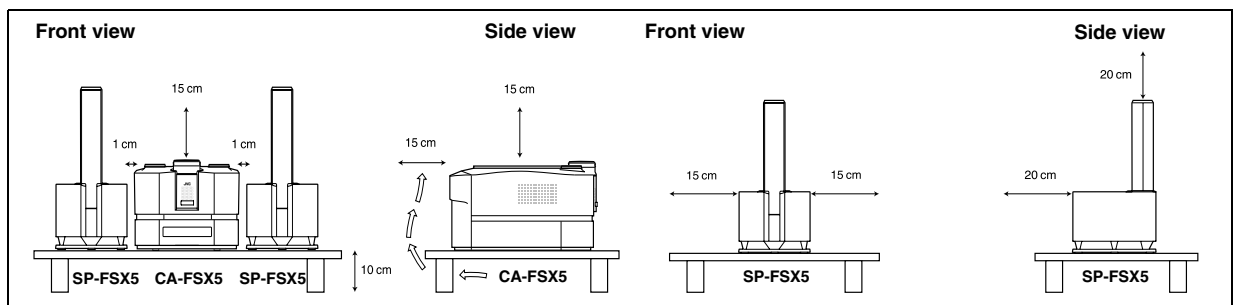

# SAFETY INSTRUCTIONS

## “SOME DOS AND DON'TS ON THE SAFE USE OF EQUIPMENT”

This equipment has been designed and manufactured to meet international safety standards but, like any electrical equipment, care must be taken if you are to obtain the best results and safety is to be assured.

☆☆

Do read the operating instructions before you attempt to use the equipment.

Do ensure that all electrical connections (including the mains plug, extension leads and interconnections between pieces of equipment) are properly made and in accordance with the manufacturer's instructions. Switch off and withdraw the mains plug when making or changing connections.

Do consult your dealer if you are ever in doubt about the installation, operation or safety of your equipment.

Do be careful with glass panels or doors on equipment.

☆☆

DON'T continue to operate the equipment if you are in any doubt about it working normally, or if it is damaged in any way—switch off, withdraw the mains plug and consult your dealer.

DON'T remove any fixed cover as this may expose dangerous voltages.

DON'T leave equipment switched on when it is unattended unless it is specifically stated that it is designed for unattended operation or has a standby mode.

Switch off using the switch on the equipment and make sure that your family know how to do this.

Special arrangements may need to be made for infirm or handicapped people.

DON'T use equipment such as personal stereos or radios so that you are distracted from the requirements of traffic safety. It is illegal to watch television whilst driving.

DON'T listen to headphones at high volume as such use can permanently damage your hearing.

DON'T obstruct the ventilation of the equipment, for example with curtains or soft furnishings.

Overheating will cause damage and shorten the life of the equipment.

DON'T use makeshift stands and NEVER fix legs with wood screws — to ensure complete safety always fit the manufacturer's approved stand or legs with the fixings provided according to the instructions.

DON'T allow electrical equipment to be exposed to rain or moisture.

### ABOVE ALL

- NEVER let anyone, especially children, push anything into holes, slots or any other opening in the case - this could result in a fatal electrical shock.;
- NEVER guess or take chances with electrical equipment of any kind. it is better to be safe than sorry!

# Introduction

Thank you for purchasing the JVC Compact Component System.  
We hope it will be a valued addition to your home, giving you years of enjoyment.  
Be sure to read this instruction manual carefully before operating your new stereo system.  
In it you will find all the information you need to set up and use the system.  
If you have a query that is not answered by the manual, please contact your dealer.

## Features

Here are some of the things that make your System both powerful and simple to use.

- The controls and operations have been redesigned to make them very easy to use, freeing you to just enjoy the music.
  - With JVC's **COMPU PLAY** you can turn on the System and automatically start the Radio or CD Player with a single touch.
- The System incorporates AHB (Active Hyper Bass) PRO circuitry to faithfully reproduce low frequency sound.
- A 45-station preset capability (30 FM and 15 AM (MW)) in addition to auto-seek and manual tuning.
- CD options that include repeat, random and program play.
- Timer functions; Daily Timer and Sleep Timer. The Daily Timer can select one of 10 melodies as a source, in addition to CD, FM, AM (MW) and LINE.
- You can connect various external units, such as an MD recorder.
- The system can play CD-R and CD-RW after they have been **finalized**.
- You can play back your original CD-R or CD-RW recorded in Music CD format. (However they may not be played back depending on their characteristics or recording conditions.)



## How This Manual Is Organized

- Basic information that is the same for many different functions - e.g. setting the volume - is given in the section 'Basic Operations', and not repeated under each function.
- The names of buttons/controls and display messages are written in all capital letters: e.g. FM/AM, "CD NO DISC".
- System functions are written with an initial capital letter only: e.g. Normal Play.

Use the table of contents to look up specific information you require.

We have enjoyed making this manual for you, and hope it serves you in enjoying the many features built into your System.

## WARNINGS

- **DO NOT PUT ANYTHING ON THE CD DOOR. IF THE SYSTEM IS OPERATED WITH SOMETHING PUT ON THE CD DOOR, IT WILL BE DAMAGED WHEN YOU TRY TO OPEN THE CD DOOR.**
- **NEVER REMOVE THE CD DOOR FROM THE UNIT. SERIOUS INJURY MAY OCCUR IF THE SYSTEM IS OPERATED WITHOUT THE CD DOOR.**

## IMPORTANT CAUTIONS

### 1 Installation of the System

- Select a place which is level, dry and neither too hot nor too cold. (Between 5°C and 35°C)
- Leave sufficient distance between the System and a TV.
- Do not use the System in a place subject to vibrations.

### 2 Power cord

- Do not handle the power cord with wet hands!
- Some power is always consumed as long as the power cord is connected to the wall outlet.
- When unplugging the System from the wall outlet, always pull the plug, not the power cord.

### 3 Malfunctions, etc.

- There are no users serviceable parts inside. In case of system failure, unplug the power cord and consult your dealer.
- Do not insert any metallic object into the System.
- Do not insert your hand between the CD door and the main body when the CD door is being closed.

1

# Table of Contents

<b>Introduction .....</b>	<b>1</b>
Features .....	1
How This Manual Is Organized .....	1
WARNINGS .....	1
IMPORTANT CAUTIONS .....	1
<b>Getting Started .....</b>	<b>4</b>
Accessories .....	4
How To Put Batteries In the Remote Control .....	4
Using the Remote Control .....	4
Connecting the FM Antenna .....	5
Connecting the AM (MW) Antenna .....	6
Connecting the Speakers (SP-FSX5) .....	7
Connecting an External Equipment .....	8
Connecting an MD Recorder, etc (Optical Digital Output) .....	8
COMPU PLAY .....	8
Automatic Power On .....	8
<b>Basic Operations .....</b>	<b>9</b>
Turning the Power On and Off .....	9
Changing the Source .....	9
Adjusting the Brightness (DIMMER - at Power On) .....	10
Power Saving Mode (DIMMER - at Power Off) .....	10
Adjusting the Volume .....	10
Fade-out Muting (FADE MUTING) .....	10
Reinforcing the Bass Sound (Active Hyper Bass Pro.) .....	10
Tone Control (BASS/TREBLE) .....	11
Auto Power Off (A.P.off) .....	11
Entering the Number with the Remote Control (Numeric Keys) .....	11
<b>Using the Tuner .....</b>	<b>12</b>
Tuning In a Station .....	12
Presetting Stations .....	13
To Change the FM Reception Mode .....	13
Beat Cut (AM (MW) Reception) .....	13
Receiving FM Stations with RDS .....	14
<b>Using the CD Player .....</b>	<b>17</b>
To Insert a CD .....	17
To Unload a CD .....	18
Basics of Using the CD Player – Normal Play .....	18
Programming the Playing Order of the Tracks – Program Play .....	18
Random Play .....	19
Repeating Tracks .....	20
CD DOOR LOCK .....	20
<b>Using External Equipments .....</b>	<b>21</b>
Listening to External Equipment .....	21
Changing the Equipment's Name .....	21
Recording the System's Source to External Equipment .....	22
Adjusting the Input Level .....	22
<b>Using the Timers .....</b>	<b>23</b>
Setting the Clock .....	23
Showing the Clock (DISPLAY) .....	24
Correcting the Clock .....	24
Setting the Daily Timer .....	24

# Table of Contents

---

Setting the SLEEP Timer .....	27
Timer Priority .....	27
<b>Troubleshooting.....</b>	<b>28</b>
<b>Care And Maintenance .....</b>	<b>29</b>
<b>Specifications.....</b>	<b>30</b>

# Getting Started

## Accessories

Make sure that you have all of the following items, which are supplied with the System.

- FM Wire Antenna (1)
- AM (MW) Loop Antenna (1)
- Remote Control (1)
- Batteries (2)
- Speaker Cords (4)

If any of these items are missing, contact your dealer immediately.

## How To Put Batteries In the Remote Control

Match the polarity (+ and -) on the batteries with the + and - markings in the battery compartment.

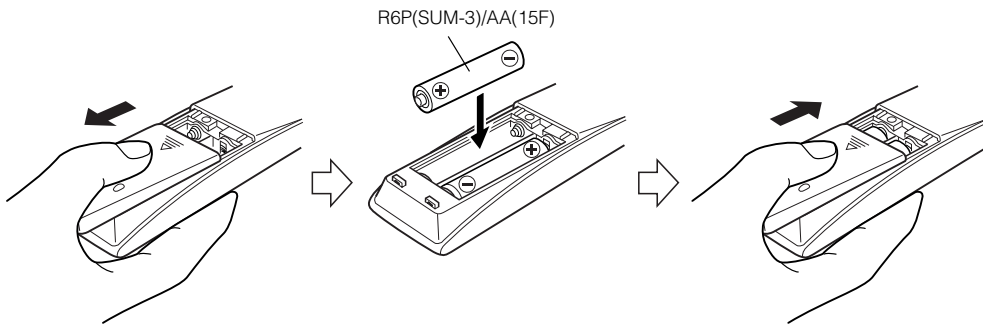

### **CAUTION:**

• Handle batteries properly.

- ❑ To avoid battery leakage or explosion:
  - Remove batteries when the Remote Control will not be used for a long time.
  - When you need to replace the batteries, replace both batteries at the same time with new ones.
  - Do not use an old battery with a new one.
  - Do not use different types of batteries together.

## Using the Remote Control

The Remote Control makes it easy to use many of the functions of the System from a distance of up to 7m away. You need to point the Remote Control at the remote sensor on the System's front panel.

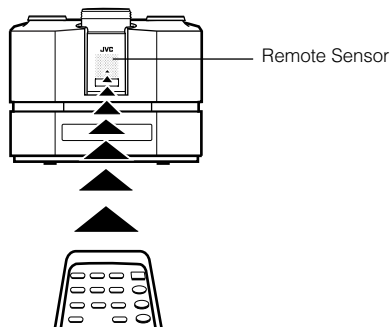

**⚠ CAUTION:**

- Make all connections before plugging the System into an AC power outlet.

**Connecting the FM Antenna**

**Rear Panel of the Center Unit (CA-FSX5)**

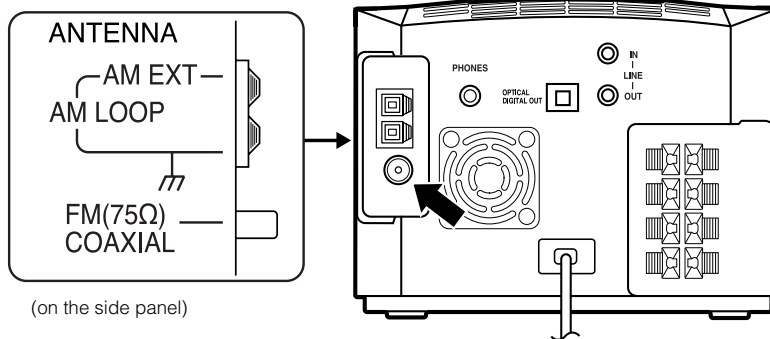

**Using the Supplied Wire Antenna**

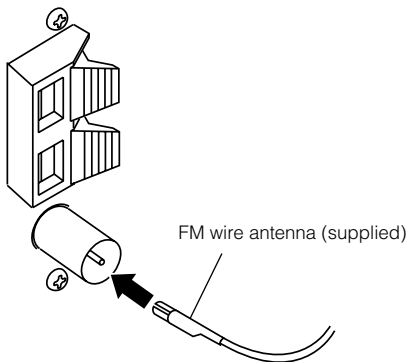

- Fasten it up in the position until you have the best reception.

If reception is poor, connect the outdoor antenna.

**Using the Coaxial Type Connector (Not Supplied)**

A 75-ohm antenna with coaxial type connector (IEC or DIN 45 325) should be connected to the FM 75-ohm COAXIAL terminal.

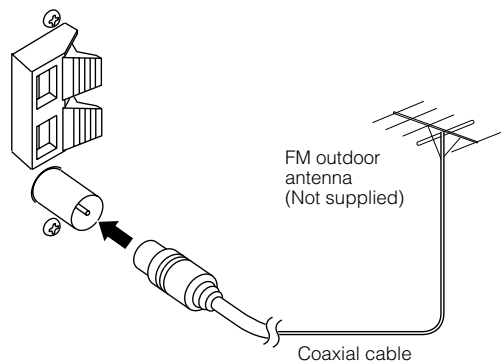

**Note**

- Before attaching a 75 ohm coaxial lead (the kind with a round wire going to an outdoor antenna), disconnect the supplied FM Wire Antenna.



## Connecting the AM (MW) Antenna

### Rear Panel of the Center Unit (CA-FSX5)

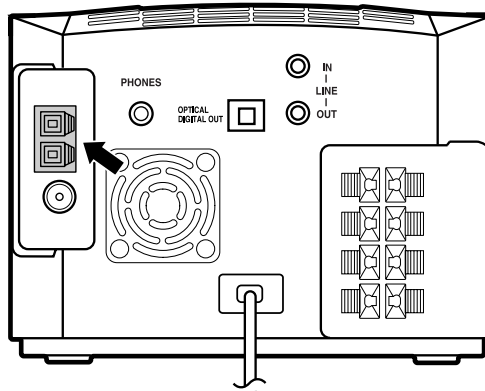

AM (MW) loop antenna (Supplied)

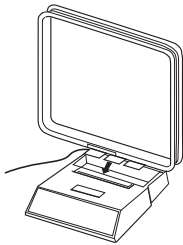

Attach the AM (MW) loop to its base by snapping the tabs on the loop into the slot in the base.

Outdoor single vinyl-covered wire (not supplied)

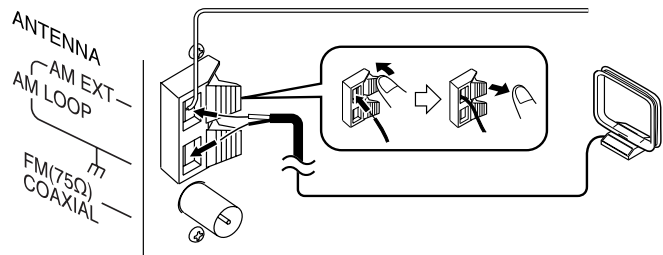

Turn the loop until you have the best reception.

### Notes

- If the AM (MW) loop antenna wire is covered with vinyl, remove the vinyl by twisting it as shown in the diagram.
- Make sure the antenna conductors do not touch any other terminals, connecting cords and power cord. This could cause poor reception.
- If reception is poor, connect an outdoor single vinyl-covered wire to the AM EXT terminal. (Keep the AM (MW) loop antenna connected.)



## Connecting the Speakers (SP-FSX5)

**These speakers are exclusively for this system. Using with other devices will damage the speakers.**

Connect the speaker cords between the speaker terminals of the Unit and those of the Speakers.

- When inserting the speaker wire lead, open the speaker terminal.
- Connect each speaker cord as shown below.

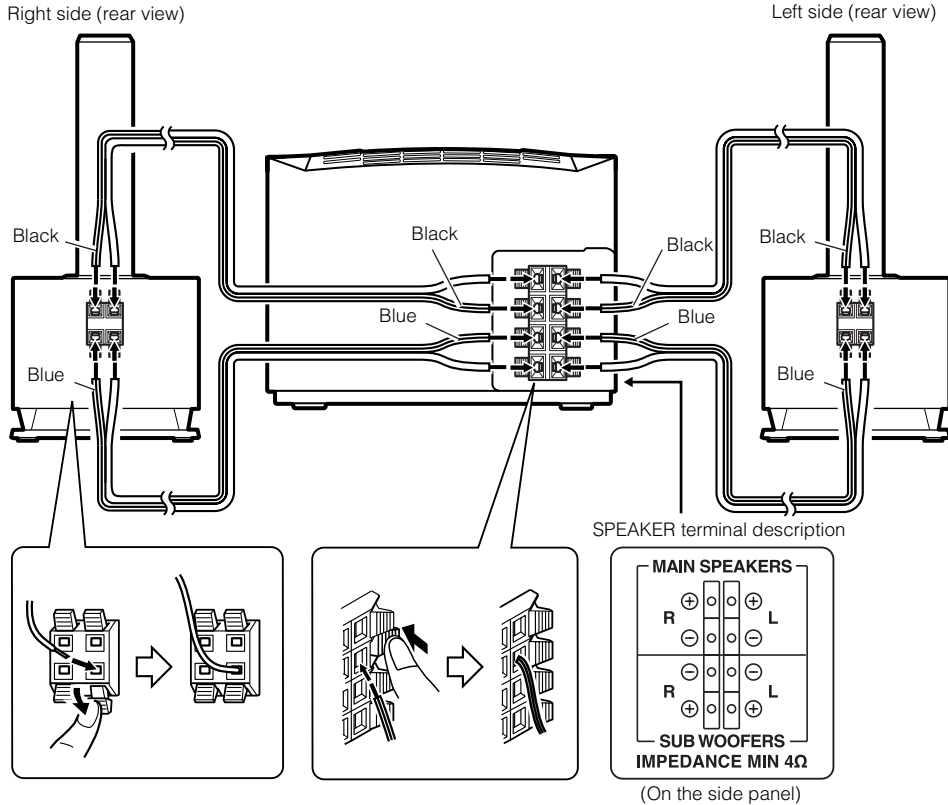

### Notes

- Since both speakers are the same, you can put either one to the right or left side.
- Do not connect other speakers to the Unit. The difference of the load impedance causes failures.
- Do not use the supplied speakers in parallel with other speakers.

### CAUTIONS:

- A TV may display irregular colors if located near the speakers. If this happens, set the speakers away from the TV.
- Handling the speakers  
Do not hold the speaker incorrectly. Otherwise it will be damaged. Also, dropping the speaker can cause injury, or damage to the speaker.

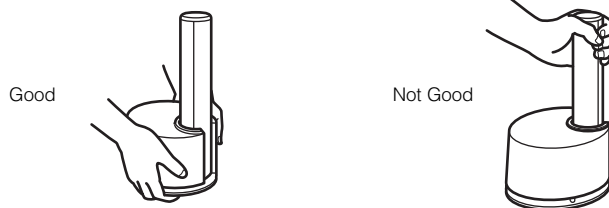

## Connecting an External Equipment

Connect signal cords (not supplied) between the System's LINE IN/OUT terminals and the output/input terminals of the external MD recorder, tape deck, etc. (For the details of connection, please refer to the user's manual of the external equipment.) You can then listen to the external source through the System or record the System's CD player or tuner to the external unit.

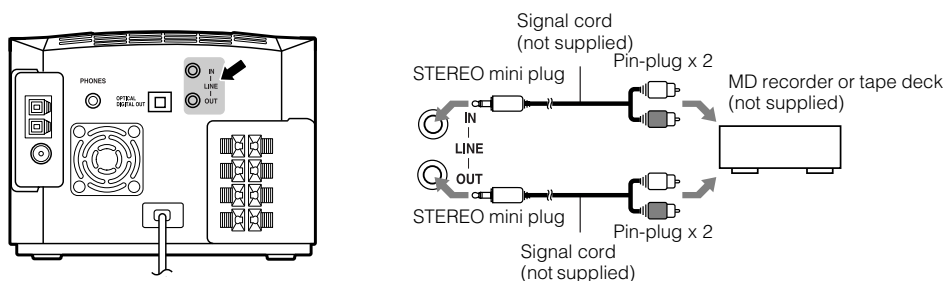

## Connecting an MD Recorder, etc (Optical Digital Output)

Unplug the cap and connect an optical digital cord (not supplied) between the System's OPTICAL DIGITAL OUT terminal and the input terminal of the MD recorder, etc.

You can record the digital output signal from the System's CD Player to the MD recorder, etc.

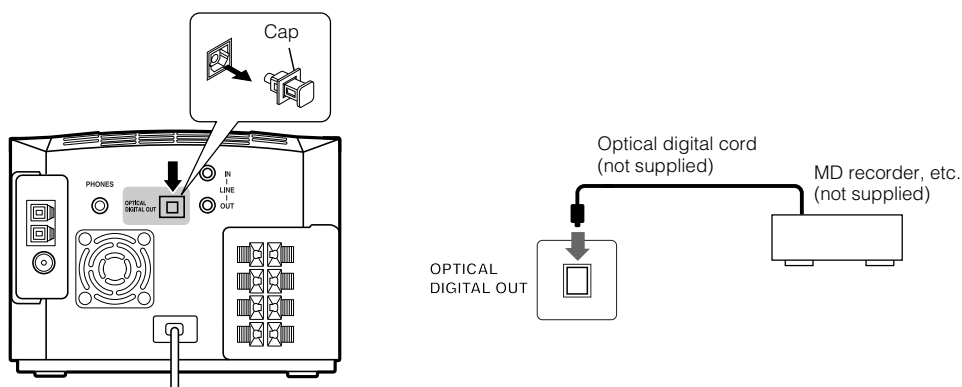

## COMPU PLAY

JVC's COMPU PLAY feature lets you control the most frequently used System functions with a single touch.

With One Touch Operation you can play a CD, turn on the radio, or listen to an external equipment with a single press of the play button for that function. One Touch Operation turns the power on for you, then starts the function you have specified. If the System is not ready (no CD in place), the System still powers on so you can insert a CD.

How One Touch Operation works in each case is explained in the section dealing with that function.

The COMPU PLAY buttons are:

### On the Remote Control

- CD ►/|| button
- FM/AM button
- LINE button

## Automatic Power On

The System automatically turns on with the following operation.

- When you press the ▲ CD button on the Unit or the CD DOOR ▲ button on the Remote Control, the System automatically turns on and the CD door opens to allow CD setting. However, this operation does not change the source to CD.

When you press the STANDBY/ON ⏻ button to turn off the System, the CD door will be automatically closed if it is opened.

# Basic Operations

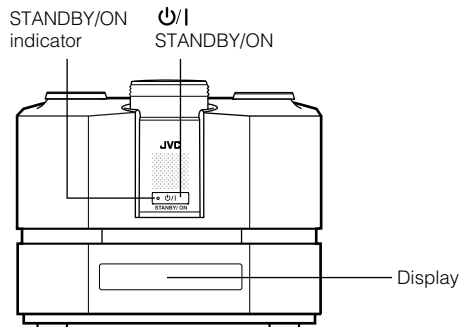
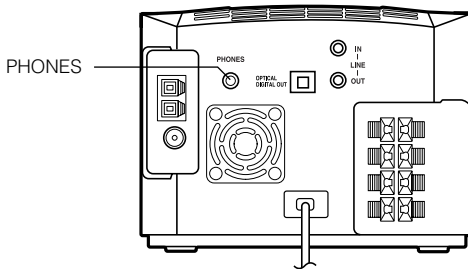
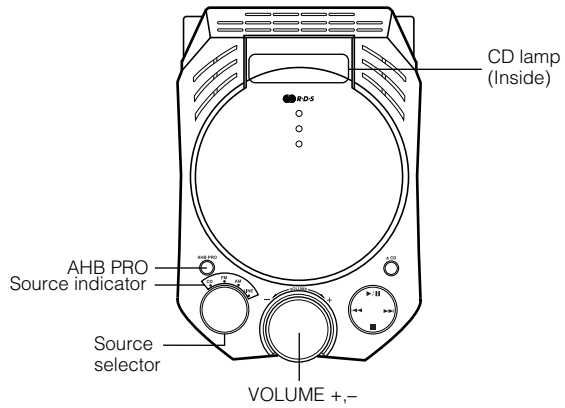
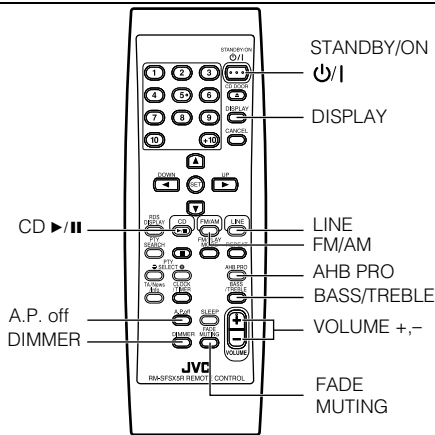

## Turning the Power On and Off

### Turning the System On

Press the **STANDBY/ON  $\mathcal{O}/I$**  button.

The display comes on and "HELLO" is displayed once. The STANDBY/ON indicator lights in **green**.

The System comes on ready to continue in the mode it was in when the power was last turned off.

- For example, if the last thing you were doing was listening to a CD, you are now ready to listen to a CD again. If you wish, you can change to another source.
- If you were listening to the Tuner last, the Tuner comes on playing the station it was last set to.

### Turning the System Off

Press the **STANDBY/ON  $\mathcal{O}/I$**  button again.

"SEE YOU" is displayed and the display goes out, except for the clock display. The STANDBY/ON indicator lights in **red**.

- Some power is always consumed even though power is turned off (called Standby Mode).
- To switch off the System completely, unplug the AC power cord from the wall outlet. When you unplug the AC power cord, the clock will be reset to 0:00.

## Changing the Source

The System has four sound sources, CD, FM, AM (MW) and LINE. Select one of sources you want to listen.

For example, when you want to listen to the CD, select the source "CD".

### On the Unit

Turn the Source selector to select the source you want.

Each time you turn it clockwise or counterclockwise, the source changes as follows.

CD  $\leftrightarrow$  FM  $\leftrightarrow$  AM  $\leftrightarrow$  LINE

The selected source name will appear on the display and the Source indicator on the Unit will light up.

### On the Remote Control

: Press the CD  $\blacktriangleright/\parallel$  button to select the source "CD".

You can listen to the CD. If a CD is inserted, the CD will be played back.

: Press the FM/AM button to select the source "FM" or "AM".

You can listen to the FM or AM (MW) broadcast.

: Press the LINE button to select the source "LINE". You can listen to the music through external equipment.

## Adjusting the Brightness (DIMMER - at Power On)

You can adjust the brightness of the display.

### When the System is Turned On

**At power on**, each time you press the DIMMER button on the Remote Control, the brightness changes as follows:  
DIMMER OFF→DIMMER 1→DIMMER 2→(back to the beginning)

- DIMMER OFF: Bright
- DIMMER 1 : Dark (CD lamp also becomes dark.)
- DIMMER 2 : Darker (CD lamp goes out.)

## Power Saving Mode (DIMMER - at Power Off)

In power saving mode, you can save the power while the System is turned off (Standby Mode).

Each time you press the DIMMER button on the Remote Control at power off, the display alternates as follows.

DISPLAY ON↔DISPLAY OFF

**To enable Power Saving mode**, set to “DISPLAY OFF”.

The display completely turns off to save the power.

**To restore normal power mode**, reset to “DISPLAY ON”. The Clock indicator (⌚) and the clock appear on the display.

## Adjusting the Volume

Turn the VOLUME control on the Unit clockwise to increase the volume or turn it counterclockwise to decrease the volume.

Press the VOLUME + button on the Remote Control to increase the volume or press the VOLUME – button on the Remote Control to decrease the volume.

VOLUME 15

You can adjust the volume level between 0 and 50.

### For private listening

Connect a pair of headphones to the PHONES jack. No sound comes out of the speakers.

Be sure to turn down the volume before connecting or putting on headphones.

### CAUTION:

- **DO NOT** turn off the System with the volume set to an extremely high level; otherwise a sudden blast of sound could damage your hearing, speakers and/or headphones when you turn on the System or start playing any source next time.  
**REMEMBER** you cannot adjust the volume level while the System is in standby mode.

## Fade-out Muting (FADE MUTING)

You can mute the output with one touch operation.

**To mute the output**, press the FADE MUTING button on the Remote Control. Then, “FADE MUTING” blinks and the output will be faded out and becomes 0.

FADE MUTING

**To release muting**, press the FADE MUTING button once again. Then, the output will be faded in to the original level.

### Notes

- Adjusting the volume causes the muting process (fading out to 0) to release.
- If you use the AHB PRO button or the BASS/TREBLE button during muting, the FADE MUTING button does not work to release muting. In this case, turn the VOLUME control on the Unit or the VOLUME+/- button on the Remote Control to newly set the volume.

## Reinforcing the Bass Sound (Active Hyper Bass Pro.)

You can reinforce the bass sound to maintain rich, full bass at low volume. (This effect does not apply to the headphones.)

**To get the effect**, press the AHB PRO button on the Unit or the Remote Control.

“AHB PRO ON” appears and the “BASS” indicator lights up.

**To cancel the effect**, press the AHB PRO button again. “AHB PRO OFF” appears and the “BASS” indicator goes out.

---

### Tone Control (BASS/TREBLE)

---

You can control the tone by changing the bass (low frequency) and treble (high frequency).

#### On the Remote Control

##### 1 Press the BASS/TREBLE button.

Each time you press the button, the Tone Control mode changes as follows.

BASS→TREBLE→Normal display→(back to the beginning)

##### 2 While “BASS” or “TREBLE” appears on the display, press the VOLUME + or - button to adjust the bass or treble level.

You can change the level within the range of -5 to +5. (0: flat)

BASS      +3  
TREBLE    -5

##### 3 Press the BASS/TREBLE button until normal display appears.

Waiting for five seconds will also return the System to the normal display.

---

### Auto Power Off (A.P.off)

---

You can automatically turn off the System when no signal condition continues for three minutes. This function is effective when the source is set to “CD”, but not to “FM”, “AM” or “LINE”.

#### To Enable the A.P.off function (When the source is “CD”)

##### 1 Press the A.P.off button on the Remote Control until “A.P.off SET” appears on the display.

Then, the “A.P.off” indicator lights up on the display.

A.P.off  
A.P.off SET

- Each time you press the button, the display alternates as follows.

A.P.off SET ↔ A.P.off STOP

When no signal condition is detected, the “A.P.off” indicator will start blinking soon.

#### No signal condition:

Source CD:    CD is stopped or no CD is inserted.

When no signal condition continues, “A.P.off 20 sec” (20 seconds left before elapsed time reaches three minutes) appears on the display. The displayed time is counted down and, finally, the System is turned off (Standby mode).

- If a CD is played back, the “A.P.off” indicator stops blinking and stays lit again.
- If you press a button or turn the VOLUME control, three-minute counting down is reset and counting down newly restarts.

#### To disable the A.P.off function

When the source is “CD”, press the A.P.off button on the Remote Control until “A.P.off STOP” appears on the display.

Then, the “A.P.off” indicator goes out.

---

### Entering the Number with the Remote Control (Numeric Keys)

---

You will use the Numeric Keys on the Remote Control to enter numbers for presetting stations, recalling the preset stations, selecting track number, or programming the playing tracks on a CD.

How to enter the number with the Numeric Keys is explained here.

#### Examples:

- To enter number 5, press 5.
- To enter number 10, press 10.
- To enter number 15, press +10 then 5.
- To enter number 20, press +10 then 10.
- To enter number 25, press +10, +10, then 5.

# Using the Tuner

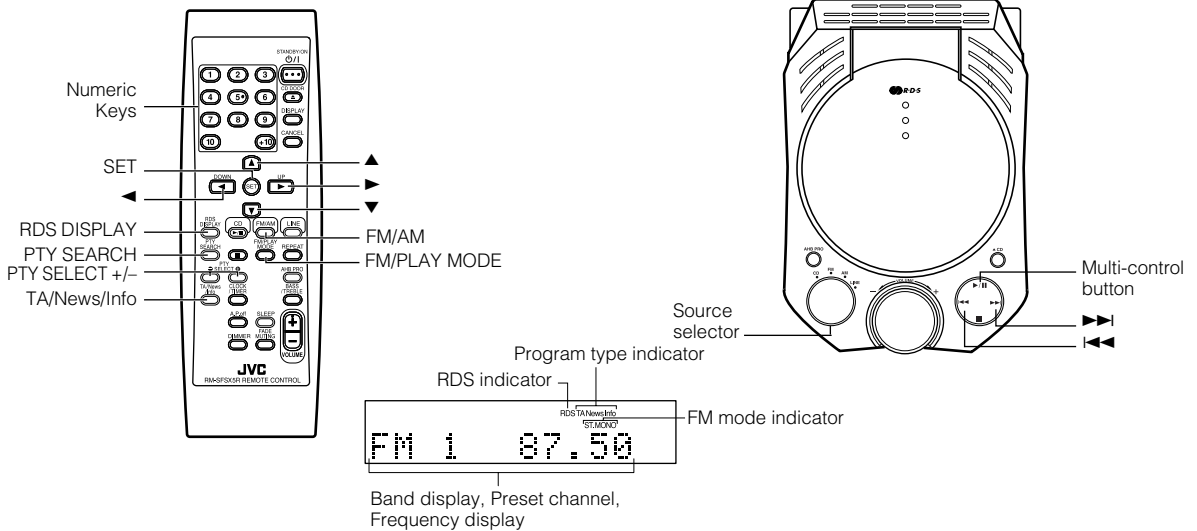

\* When the System is in use, the display shows other items as well.  
For simplicity, we show here only the items described in this section.

You can listen to FM and AM (MW) stations. Stations can be tuned in manually, automatically, or from preset memory storage.

- Before listening to the radio:
  - Make sure that both the FM and AM (MW) antennas are correctly connected. (See pages 5 and 6).

## One Touch Radio

Just press the FM/AM button on the Remote Control to turn on the System and start playing the station you were last tuned to.

- You can switch from any other sound source to the radio by pressing the FM/AM button.

## Tuning In a Station

### 1 Press the FM/AM button.

The Band and Frequency you were last tuned to appear on the display.

(If the last station was selected using the preset number, the preset number appears first.)

Each time you press the button, the band alternates between FM and AM (MW).

- You can also select the band by turning the Source selector on the Unit.

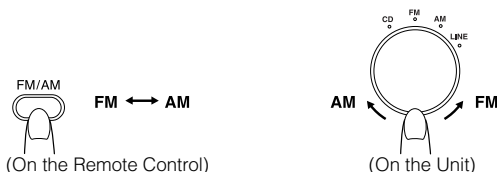

### 2 Select a station using one of the following methods.

#### ● Manual Tuning

Press the ►► or ◀◀ button on the Unit or the ▲ or ▼ button on the Remote Control repeatedly to move from frequency to frequency until you find the station you want.

OR

#### ● Auto Tuning

If you press and hold the ►► or ◀◀ button on the Unit or the ▲ or ▼ button on the Remote Control for one second or more, the frequency changes up, or down, automatically until a station is found.

OR

#### ● Preset Tuning using the Remote Control (Possible only after presetting stations)

Select the desired preset number using the ► or ◀ button on the Remote Control. The display will show the preset number's band and frequency.

- You can also select the desired preset number using the Numeric Keys. See "Entering the Number with the Remote Control" on page 11. (e.g. Press +10, and then 2 for number 12.)

#### Example:

Press the ► button until the preset number "2" appears.

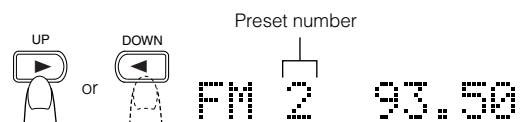

## Presetting Stations

You can preset up to 30 FM stations and up to 15 AM (MW) stations.



- Preset numbers may have been set to factory test frequencies prior to shipment. This is not a malfunction. You can preset the stations you want into memory by following one of the presetting methods below.

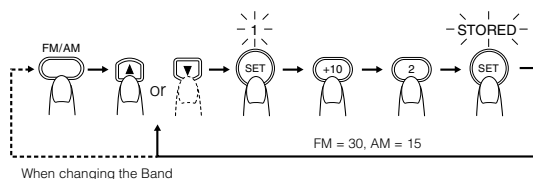

### On the Remote Control

- 1** Select a band by pressing the FM/AM button.
- 2** Press the ▲ or ▼ button to tune in a station.
- 3** Press the SET button.  
Preset number “1” will blink for 5 seconds. Within 5 seconds, proceed to the next step. When the display returns to the one set in step 2 after 5 seconds, press the SET button again.
- 4** Press the Numeric Keys, or the ► or ◀ button within 5 seconds to select the preset number.

**Example:**

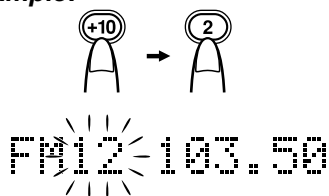

- 5** Press the SET button within 5 seconds.  
“STORED” appears and after 2 seconds, the display returns to the broadcast frequency display.
- 6** Repeat above steps 1 to 5 for each station you want to store in memory with a preset number.

To change the preset stations, repeat the same steps as above.

## CAUTION:

- Even if the system is unplugged or if the power failure occurs, the preset stations will be stored for about 24 hours. However, in case the preset stations are erased, you will need to preset the stations again.

## To Change the FM Reception Mode

When you are tuned into an FM stereo broadcast, the “ST.” indicator lights up and you can hear stereo effects. If an FM stereo broadcast is hard to receive or noisy, you can select Monaural mode. Reception improves, but you lose stereo effect. FM AUTO mode is also useful to suppress static noise between stations.

To enter Monaural mode while receiving an FM broadcast, press the FM/PLAY MODE button on the Remote Control until “FM MONO” appears on the display. Then, the “MONO” indicator lights up. Each time you press the FM/PLAY MODE button, the display alternates between “FM AUTO” and “FM MONO”.



To restore the stereo effect, press the FM/PLAY MODE button on the Remote Control until “FM AUTO” appears on the display. Then, the “MONO” indicator goes out and the “ST.” indicator will light up.

## Beat Cut (AM (MW) Reception)

Switching the Beat Cut mode may reduce beat noise.

Each time you press the FM/PLAY MODE button while receiving an AM (MW) broadcast, the Beat Cut mode changes as follows.

BEAT CUT 1 → BEAT CUT 2 → BEAT CUT 3 →  
BEAT CUT 4 → (back to the beginning)



Set to the position where beat noise is small.

- The best position will differ depending on the AM (MW) broadcast station being received.



- In AM (MW) broadcast, reception sensitivity will be changed by turning the AM (MW) loop antenna. Turn the AM (MW) loop antenna for best reception.



## Receiving FM Stations with RDS

You can use the RDS (Radio Data System) by using the buttons on the Remote Control.

RDS allows FM stations to send additional signals with their regular program signals. For example, the stations send their station names, and information about what type of program they broadcast, such as sports or music, etc. This Unit can receive the following types of RDS signals:

### PS (Program Service):

shows commonly known station names.

### PTY (Program Type):

shows types of broadcast programmes.

### RT (Radio Text):

shows text messages the station sends.

### What information can RDS signals provide?

The display shows RDS signal information that the station sends.

- The RDS indicator lights up when turned to a station that provides RDS information.

## To show the RDS signals on the display

### On the Remote Control

Press the RDS DISPLAY button while listening to an FM station.

Each time you press the button, the display changes to show information in the following order:

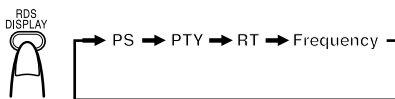

On the Remote Control

### PS (Program Service):

While searching, “WAIT PS” appears on the display. Then, the station name appears. “NO PS” appears if no signal is sent.

### PTY (Program Type):

While searching, “WAIT PTY” appears on the display. Then, the broadcast program type appears. “NO PTY” appears if no signal is sent.

### RT (Radio Text):

While searching, “WAIT RT” appears on the display. Then, a text message sent by the station appears. “NO RT” appears if no signal is sent.

### Station Frequency:

Station frequency (non-RDS service)

## Notes

- Not all FM stations provide RDS signals, nor do all RDS stations provide the same services. If in doubt, check with local radio stations for details on RDS in your area.
- RDS may not work correctly if the received station is not transmitting the signals properly or if the signal strength is weak.
- RDS is not available for AM (MW) broadcasts.

## To search for a program by PTY codes

One of the advantages of the RDS service is that you can locate a particular kind of program by specifying the PTY codes.

### To search for a program using PTY codes:

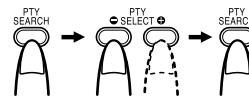

On the Remote Control

### On the Remote Control

#### 1 Press the PTY SEARCH button once while listening to an FM station.

“PTY SELECT” blinks on the display.

#### 2 Select the PTY code using the PTY SELECT + or – button within approx. 7 seconds.

Each time you press the button, the display shows a category in the following order:

None ↔ News ↔ Affairs ↔ Info ↔ Sport ↔ Educate ↔ Drama ↔ Culture ↔ Science ↔ Varied ↔ Pop M ↔ Rock M ↔ Easy M ↔ Light M ↔ Classics ↔ Other M ↔ Weather ↔ Finance ↔ Children ↔ Social ↔ Religion ↔ Phone In ↔ Travel ↔ Leisure ↔ Jazz ↔ Country ↔ Nation M ↔ Oldies ↔ Folk M ↔ Document ↔ TEST ↔ Alarm! ↔ (back to the beginning)

#### 3 Press the PTY SEARCH button within approx. 10 seconds again.

While searching, “SEARCH” and the selected PTY code alternately appears on the display.

The Unit searches 30 preset stations and stops when it finds a station of the category you have selected, then tunes into that station.

## Using the Tuner

To continue searching after the first stop, press the PTY SEARCH button again while the display indications blink.

If no program is found, "NOT FOUND" appears on the display, and the Unit returns to the last received station.

To stop searching at any time during the process, press the PTY SEARCH button to stop search operation.

### Descriptions of the PTY Codes

<b>None:</b>	Undefined
<b>News:</b>	News
<b>Affairs:</b>	Topical programs expanding on the current news or affairs
<b>Info:</b>	Programs on medical service, weather forecasts, etc.
<b>Sport:</b>	Sports events
<b>Educate:</b>	Educational programs
<b>Drama:</b>	Radio plays
<b>Culture:</b>	Programs on national or regional culture
<b>Science:</b>	Programs on natural sciences and technology
<b>Varied:</b>	Other programs like comedies or ceremonies
<b>Pop M:</b>	Pop music
<b>Rock M:</b>	Rock music
<b>Easy M:</b>	Middle-of-the road music (usually called "easy listening")
<b>Light M:</b>	Light music
<b>Classics:</b>	Classical music
<b>Other M:</b>	Other music
<b>Weather:</b>	Weather information
<b>Finance:</b>	Reports on commerce, trading, the Stock Market, etc.
<b>Children:</b>	Entertainment programs for children
<b>Social:</b>	Programs on social activities
<b>Religion:</b>	Programs dealing with any aspect of belief or faith, or the nature of existence or ethics
<b>Phone In:</b>	Programs where people can express their views either by phone or in a public form
<b>Travel:</b>	Programs about travel destinations, package tours, and travel ideas and opportunities
<b>Leisure:</b>	Programs concerned with recreational activities such as gardening, cooking, fishing, etc.
<b>Jazz:</b>	Jazz music
<b>Country:</b>	Country music
<b>Nation M:</b>	Current popular music from another nation region, in that country's language
<b>Oldies:</b>	Classic pop music
<b>Folk M:</b>	Folk music
<b>Document:</b>	Programs dealing with factual matters, presented in an investigative style
<b>TEST:</b>	Test broadcasts
<b>Alarm!:</b>	Emergency broadcasts

## To temporarily switch to a broadcast program of your choice

Enhanced Other Network mode is another convenient RDS service that allows this Unit to switch temporarily to a broadcast program of your choice (TA News and/or Info) from the currently selected station, except if you are listening to a non-RDS station (all AM (MW) stations or some FM stations).

- The Enhanced Other Network function is only applicable to the preset stations. (See page 13.)
- If an FM station does not broadcast Enhanced Other Network mode information, Enhanced Other Network cannot be activated.

### To select a program type



On the Remote Control

## On the Remote Control

### 1 Select the program type by pressing the TA/News/Info button while listening to an FM station.

Each time you press the button, the respective program type indicators light on the display as follows, and the Unit enters Enhanced Other Network standby mode.

**TA → News → Info → TA News → News Info → TA Info → TA News Info → OFF → (back to the beginning)**

<b>TA:</b>	Traffic Announcement
<b>NEWS:</b>	News
<b>INFO:</b>	Programs on medical service, weather forecast, etc.
<b>OFF:</b>	Enhanced Other Network is canceled.

During searching, the selected program type indicator blinks on the display.

To stop listening to the program by Enhanced Other Network, press the TA/News/Info button repeatedly again. So that the program type (TA, News and/or Info) indicator goes off from the display. The Unit exit from Enhanced Other Network standby mode and goes back to the previously selected station.

**Case 1: If there is no station broadcasting the program type you have selected**

The broadcast station being currently heard will continue to be heard.



When a station starts broadcasting the program you have selected, this Unit automatically switches to the station. The program type (TA, News and/or Info) indicator starts blinking.



When the program is over, “END” appears on the display and the Unit goes back to the currently selected station, but the Enhanced Other Network still remains in standby mode.

**Case 2: If there is a station broadcasting the program type you have selected**

This Unit tunes to the station broadcasting the program. The program type (TA, News and/or Info) indicator starts blinking.



When the program is over, “END” appears on the display and the Unit goes back to the currently selected station, but the Enhanced Other Network still remains in standby mode.

**Case 3: If the FM station you are listening to is broadcasting the program type you have selected**

The Unit tunes to the station but the program type (TA, News and/or Info) indicator starts blinking.



When the program is over, “END” appears on the display, the program type (TA, News and/or Info) indicator stops blinking and remains lit, but the Enhanced Other Network still remains in standby mode.

**Alarm function**

If an “Alarm!” (Emergency) signal is received from a station while listening to an RDS station sending the Enhanced Other Network data, the Unit automatically switches to the station broadcasting the “Alarm!” signal.

**Test function**

The TEST signal is used for testing the “Alarm!” signal. Therefore, it makes the Unit work in the same way as the “Alarm!” signal does.

If a TEST signal is received from a station while listening to an RDS station sending the Enhanced Other Network data, the Unit automatically switches to the station broadcasting the TEST signal.

**Notes****More about the Enhanced Other Network function**

- The Enhanced Other Network data sent from some stations may not be compatible with this Unit.
- While listening to a program tuned in by this function, the station does not change even if another network station starts broadcasting a program of the same Enhanced Other Network data.
- While listening to a program tuned in by this function, you can only use the TA/News/Info button and the RDS DISPLAY button as the tuner operation buttons. If you press any other button, “LOCKED!” appears on the display.
- If the station alternate intermittently between the station tuned by this function and the currently tuned station (“WAITING” blinks on the display), press the TA/News/Info button to cancel the function. If you do not press the button, the currently tuned station is received finally (“NOT FOUND” appears this time), and the indication of the Enhanced Other Network data type blinking on the display disappears.

**CAUTION:**

- When the sound alternated intermittently between the station tuned in by the Enhanced Other Network function and the current selected station, cancel the Enhanced Other Network mode. This does not constitute malfunction of the Unit.

# Using the CD Player

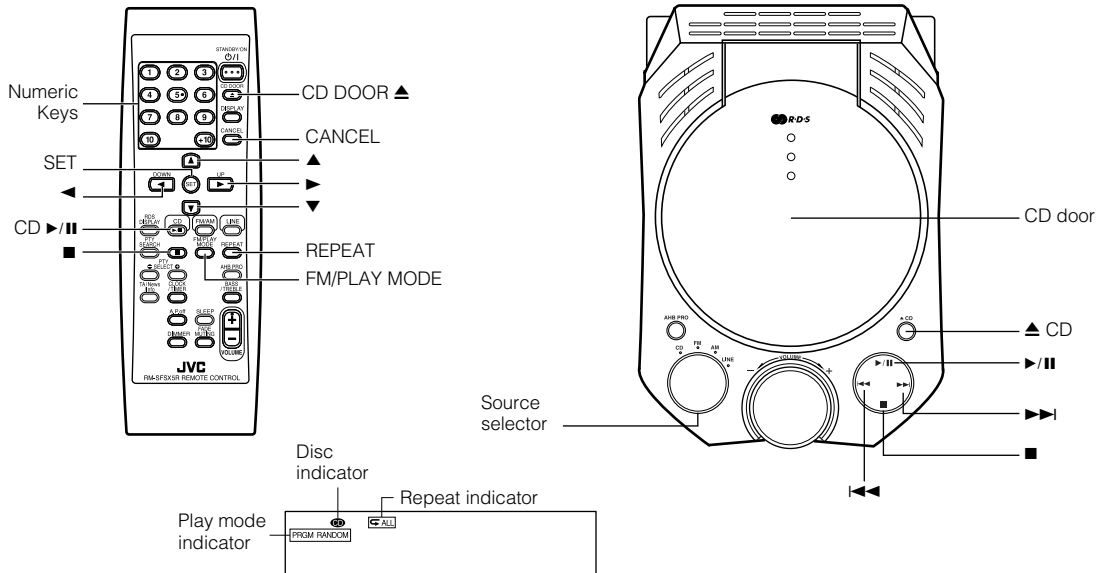

\* When the System is in use, the display shows other items as well.  
For simplicity, we show here only the items described in this section.

You can use Normal, Random, Program or Repeat Play. Repeat Play can repeat all the tracks or just one of the tracks on the CD.

Here are the basic things you need to know to play a CD and locate the different tracks on it.

This Unit has been designed only to playback the following CDs.

- Digital audio CD
- Recordable digital audio CD (CD-R)
- Rewritable digital audio CD (CD-RW)

## When playing a CD-R or CD-RW

You can playback **finalized CD-R or CD-RW recorded music CD format**. (If CD-RW have been recorded in a different format, erase all the data on CD-RW completely before recording on the disc.)

- You can playback CD-R or CD-RW like CD.
- Some CD-R or CD-RW may not be played back on this Unit because of their disc characteristics, damage or stain on them, or if the player lens is dirty.
- The reflection factor of CD-RW is lower than that of other CD, possibly causing CD-RW to take longer to read.
- CD-R and CD-RW of MP3 format are not played back.

## The Quickest Way To Start a CD Is With the One Touch Operation

- Press the CD ►/|| button on the Remote Control.
  - The power is automatically turned on and, if a CD is already inserted, it will start playing from the first track.
  - If no CD is inserted, "CD NO DISC" appears on the display and the CD Player remains in Stop mode.

## To Insert a CD

- 1** Select the source "CD" using the Source selector on the Unit.
- 2** Press the ▲CD button on the Unit or the CD DOOR ▲ button on the Remote Control.  
The CD door opens.
- 3** Place a CD, with its label side up as shown below. Press down on the CD's center until you hear a click.

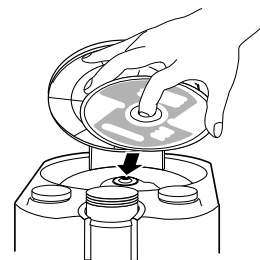

- 4** Press the ▲ CD button on the Unit or the CD DOOR ▲ button on the Remote Control again to close the CD door.  
"CD DOOR CLOSE" appears and then, "CD READING" appears on the display. At that time, Disc indicator (CD) will also be lit on the display.
  - To close the CD door and play the CD, you can just press the ►/|| button on the Unit or the CD ►/|| button on the Remote Control.
- You can place an 8 cm CD without an adaptor.
- If the CD cannot be read correctly (because it is scratched, for example), "CD CAN'T PLAY" appears on the display.

- You can insert a CD while listening to the other source.
  - However, while the CD door is operating (opening or closing), the other source will be muted.

**CAUTION:**

- **DO NOT** try to open or close the CD door by hands as it will be damaged.

**To Unload a CD**

Take out the CD as shown below.

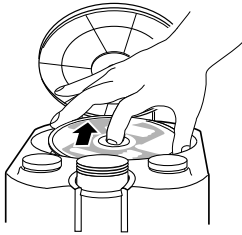

**Basics of Using the CD Player – Normal Play**

**To Play a CD**

- 1** Select the source “CD”.
- 2** Insert a CD.
- 3** Press the ►/|| button on the Unit or the CD ►/|| button on the Remote Control.

The first track of the CD begins playing.

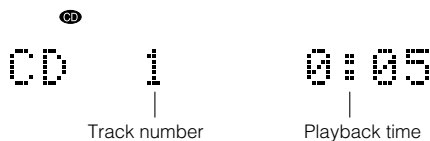

- The CD Player automatically stops when the last track of the CD has finished playing.

To stop playing the CD, press the ■ button. The following information for the CD is displayed.

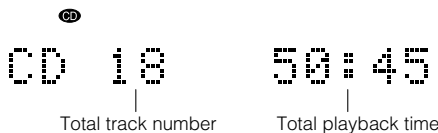

To stop playing and remove the CD, press the ▲ button on the Unit or the CD DOOR ▲ button on the Remote Control to open the CD door.

To pause, press the ►/|| button on the Unit or the CD ►/|| button on the Remote Control. The playback time blinks on the display.

To cancel pause, press the same button again. Play continues from the point where it was paused.

**To Select a Track or Passage within a Track During playback**

Press the ►►| or |◀◀ button on the Unit or the ► or ◀ button on the Remote Control to select the track you want.

- The selected track starts playing.
- Press the ►►| (or ►) button once to skip to the beginning of the next track.
- Press the |◀◀ (or ◀) button to skip to the beginning of the track being played. Press twice quickly to skip to the beginning of the previous track.
- When the ► or ◀ button on the Remote Control is kept pressing, the track continuously skips.
- Press the Numeric Keys to select track number (See page 11).

**In Stop mode**

- Press the ►►| or |◀◀ (or ► or ◀) button to skip the track.
- Hold down the ►►| or |◀◀ (or ► or ◀) button to continuously skip the tracks.

**Search Play**

Holding down the ►►| or |◀◀ button on the Unit or the ▲ or ▼ button on the Remote Control, during playback, will fast forward/backwards the CD so you can quickly find a particular passage in the track you are listening to.

**Programming the Playing Order of the Tracks – Program Play**

You can program up to 32 tracks in any desired order including the same tracks.

- You can only make a program when the CD Player is stopped.

**On the Remote Control**

- 1** Insert a CD.
- 2** Press the CD ►/|| button.
- 3** Press the ■ button to stop the CD.
- 4** Press the FM/PLAY MODE button until “CD PROGRAM” appears.

The System enters the Program Play mode and the “PRGM” indicator lights up.

Each time you press the button, the play mode changes as follows.

CD PROGRAM → CD RANDOM → CD NORMAL → (back to the beginning)

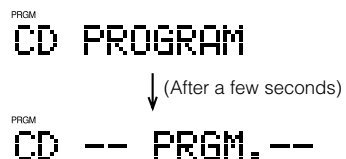

- If already programmed, the track number and preset number of the last programmed track will appear.

### 5 Press the Numeric Keys to enter the track number you want to program (See page 11).

The program order number will be assigned from "1", if nothing is programmed yet.

#### Example:

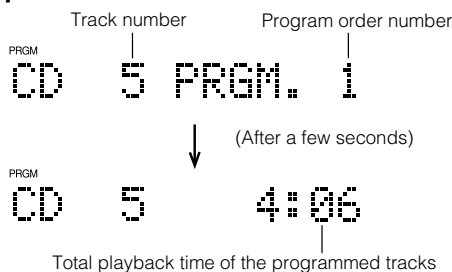

- To delete the last entry, press the CANCEL button.

### 6 Repeat step 5 to program the other tracks.

You can see the total playback time of programmed tracks on the display.

### 7 Press the CD ►/|| button.

The System plays the tracks in the order you have programmed them.

The CD will stop when all of the programmed tracks have been finished playing.

- You can also press the ►/|| button on the Unit.

You can skip to a particular program track by pressing the ► or ◀ button on the Remote Control or the ►►| or |◀◀ button on the Unit during Program Play.

You can perform search play by holding down the ►►| or |◀◀ button on the Unit or the ▲ or ▼ button on the Remote Control during playback.

To stop playing, press the ■ button once.

**To confirm the programmed tracks while the CD player is stopped**, each time you press the ► or ◀ button, the tracks making up the program will successively be displayed in the programmed order.

**To delete all the tracks in the program**, in Stop mode, hold down the CANCEL button until "ALL CLEAR!" appears on the display.

Opening the CD door or turning off the System will clear the programmed tracks and release the Program Play mode.

**To exit the Program Play mode once**, while the CD Player is stopped, press the FM/PLAY MODE button until "CD NORMAL" appears on the display. (The "PRGM" indicator goes out.)

**To re-enter the Program Play mode**, press the FM/PLAY MODE button until "CD PROGRAM" appears on the display. (The "PRGM" indicator lights up.)

### Notes

- If the total playback time of the programmed tracks exceeds 1 hour and 40 minutes, "--:--" will appear on the display.
- If you try to program the 33rd track, "MEMORY FULL" appears on the display for about 2 seconds.

## To Modify the Program

Modify the contents of the program while the CD Player is stopped.

Each time you press the CANCEL button, the last track in the program is deleted. To add new tracks to the end of the program, repeat above step 5.

## Random Play

The tracks will play in no special order when you use this mode.

### 1 In Stop mode, press the FM/PLAY MODE button on the Remote Control until "CD RANDOM" appears.

The "RANDOM" indicator lights up on the display.

Each time you press the button, the play mode changes as follows.

CD PROGRAM → CD RANDOM → CD NORMAL  
→ (back to the beginning)

### 2 Press the CD ►/|| button on the Remote Control.

The tracks are played in random order.

The CD will stop when all the tracks have been finished playing.

- You can also press the ►/|| button on the Unit.

**To skip a track during playback**, press the ►►| (or ►) button to jump to the next track in the random sequence. Press the |◀◀ (or ◀) button to jump back to the start of a track being played.

**To perform search play during playback**, hold down the ►►| (or ▲) or the |◀◀ (or ▼) button.

**To exit the Random Play mode**, while the CD Player is stopped, press the FM/PLAY MODE button until "CD NORMAL" appears on the display. (The "RANDOM" indicator goes out.)

---



## Repeating Tracks



---

You can repeat all tracks or individual track, as many times as you like.

**During playback or in Stop mode, press the REPEAT button on the Remote Control.**

Each time you press the button, the Repeat mode and Repeat indicator change as follows.

**CD REPEAT ALL (  ALL) → CD REPEAT 1 (  )  
→ CD REPEAT OFF → (back to the beginning)**

-  **ALL:** In Normal Play mode, repeats all the tracks.  
In Program Play mode, repeats all the tracks in the program.  
In Random Play mode, repeats all the tracks in random order.
-  : Repeats one track.

**To exit the Repeat mode,** press the REPEAT button until “CD REPEAT OFF” appears and the Repeat indicator on the display goes out.

- Repeat mode remains in effect even when you change the play mode.

---



## CD DOOR LOCK

---

You can prevent unwanted CD ejection by locking the CD door. The CD Player works normally except CD ejection operation.

### Locking the CD door

**1 Turn off the system.**

**2 While pressing down the  button on the Unit, press the  CD button on the Unit.**

“DOOR LOCKED” appears on the display.

DOOR LOCKED

- If you try to open the CD door, “DOOR LOCKED” appears on the display to let you know that the CD door has been locked.

### Unlocking the CD door

Repeat above steps 1 and 2.

“DOOR UNLOCKED” appears on the display.

DOOR UNLOCKED

Now, you can open the CD door normally.

#### Note

- Even after the System is unplugged, the CD door lock condition will be retained for about 24 hours. To unlock the CD door after powering up, you need to perform the unlocking operation.
-

# Using External Equipments

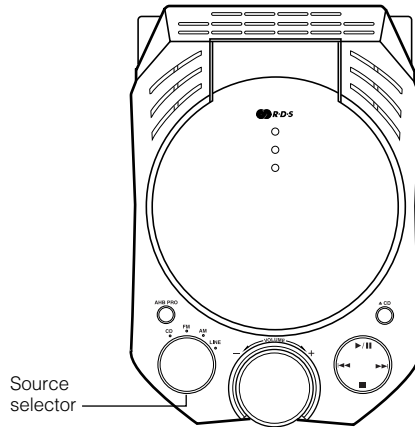
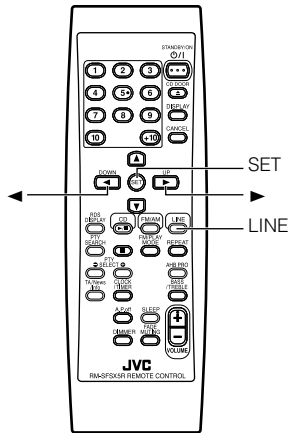

## Listening to External Equipment

You can listen to the external equipment such as MD recorder, tape deck or other auxiliary.

- First make sure that the external equipment is properly connected to the System. (See page 8).

- 1 Set the VOLUME control to the minimum position.**
- 2 Press the LINE button on the Remote Control.**

"LINE" will appear on the display.

L I N E

- You can also select "LINE" using the Source selector on the Unit.

- 3 Start playing the external equipment.**
- 4 Adjust the VOLUME control to the desired listening level.**
- 5 Apply the following sound effects, if you wish.**

- AHB PRO (See page 10.)
- Tone (BASS/TREBLE) (See page 11.)

To exit the source "LINE", select other source (e.g. CD).



- For operation of the external equipment, refer to its Instructions.

## Changing the Equipment's Name

You can change the equipment's name according to the equipment to be used. (At purchase, "LINE" is selected.)

### On the Remote Control

- 1 Press the LINE button to select the source "LINE".**
- 2 Press the LINE button for two seconds or more.**

"NAME CHANGE" blinks on the display.

NAME CHANGE

- 3 While "NAME CHANGE" is blinking, press the SET button.**
- 4 Press the ► or ◀ button repeatedly to select the desired name.**

Each time you press the button, the equipment name changes as follows.

LINE ↔ TAPE ↔ DBS ↔ VCR ↔ TV ↔  
GAME ↔ (back to the beginning)  
DBS (Direct Broadcasting Satellite): For CS/BS

- 5 Press the SET button**

The current name is replaced with new one.  
(When TAPE is selected)

T A P E

- The selected name will appear on the display when you select the source "LINE".



## Recording the System's Source to External Equipment

You can record the System's source to external equipment which is connected to the LINE OUT or OPTICAL DIGITAL OUT terminal of the System, such as tape deck or MD recorder, etc.

- ❑ First make sure that the external equipment is properly connected to the System. (See page 8).
- ❑ When recording a FM or AM (MW) program, use the LINE OUT terminal (not the OPTICAL DIGITAL OUT terminal).

### 1 Play the System's CD Player or tune in to a station.

- ❑ The recording level is not affected by the VOLUME level set by the System. Also it is not affected by the sound effects.



- For operation of the external equipment, refer to its Instructions.

## Adjusting the Input Level

If the sound from the component connected to the LINE IN jacks is too loud or is not loud enough when changing the source to the external component (without adjusting the volume level), you can change the input level through the LINE IN jacks.

### On the Remote Control

#### 1 When the source is "LINE", press and hold the SET button.

INPUT LEVEL1

- If you have changed the source name of the external component, the currently selected source will appear (see page 21).

#### 2 Press the ► or ◀ button to select an appropriate input level.

- Each time you press the button, the input level alternate between "INPUT LEVEL1" and "INPUT LEVEL2".

INPUT LEVEL2

**INPUT LEVEL1:** Select this when the sound is not loud enough.

**INPUT LEVEL2:** Select this when the sound is too loud.

#### 3 Press the SET button to finish the adjustment.

LEVEL2 STORED

- "LEVEL2 STORED" appears on the display.
- The selected input level will be kept in memory until you change it.



The input level is too high.

- Select "INPUT LEVEL2" if the current level is "INPUT LEVEL1".
- If the current level is "INPUT LEVEL2", adjust the output level on the external component.

# Using the Timers

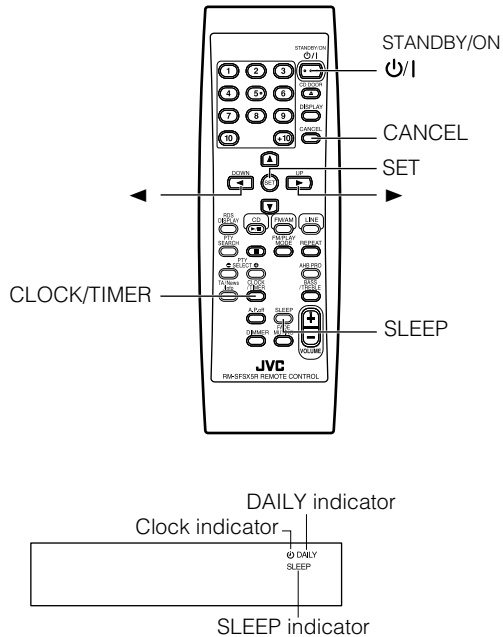

\* When the System is in use, the display shows other items as well.  
For simplicity, we show here only the items described in this section.

The timers let you control listening functions automatically.  
Two types of timers are available:

## DAILY Timer

Use this timer to set wake up everyday to music from any source, including melodies.

## SLEEP Timer

Fall asleep and have your System turn off automatically after a certain length of time.

## Setting the Clock

When you plug the AC power cord into the wall outlet, the time indication "0:00" and the Clock indicator (🕒) blink on the display in standby (System off) mode.

You can set the clock whether the System is on or off (but not in power saving mode (See page 10)).

### Notes

- The clock must be correctly set for the timers to work.
- The clock may gain or lose one to two minutes per month.

## On the Remote Control

### 1 Press the CLOCK/TIMER button.

The hour digit of the time indication blinks on the display, also, the Clock indicator (🕒) blinks.



### Note

- If the clock is already set and the Clock indicator (🕒) is not blinking, press the CLOCK/TIMER button repeatedly until the clock setting display appears on the display. Each time you press the CLOCK/TIMER button, the display changes as follows.  
DAILY ON?/DAILY OFF? → ON (time) → Clock setting display\* → Cancelled → (back to the beginning)  
\*: Select this item!

### 2 Press the ► or ◀ button to set the hour.

Pressing the ► button moves the time forwards and pressing the ◀ button moves it backwards. Holding down the button moves the hour.

**3 Press the SET button.**

The minute digits of the time indication blink on the display.

- To return to the hour setting, press the CANCEL button.

**4 Press the ► or ◀ button to set the minute.****5 Press the SET button.**

“ADJUST OK!” appears on the display. The Clock indicator (⌚) remains lit. Then, the selected time is set and the seconds start counting from 0.

**⚠ CAUTION:**

- If there is a power failure, the clock loses its setting. “0:00” and the Clock indicator (⌚) blinks on the display and the clock must be reset.

**Showing the Clock (DISPLAY)**

You can show the current time on the display.

To display the clock, press the DISPLAY button on the Remote Control.

To return to the normal display, press the same button again.

7 : 00

**Correcting the Clock**

Use the following method to correct any clock shift.

- You can correct the clock whether the System is turned on or off.

**1 Repeatedly press the CLOCK/TIMER button to show the clock on the display.**

Each time you press the button, the display changes as follows.

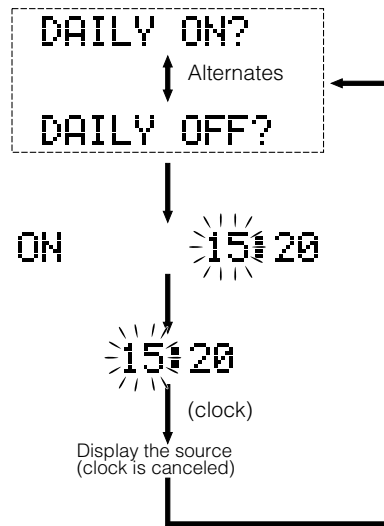
**Example:****2 Perform steps 2 to 5 in “Setting the Clock” on page 23-24.****Notes**

- When the System is in power saving mode, nothing appears on the display. To see the clock, press the DIMMER button on the Remote Control.
- The clock may gain or lose one to two minutes per month.
- If there is a power failure, the clock loses its setting, “0:00” blinks on the display and the clock must be reset. To reset the clock, see “Setting the Clock” on page 23-24.

**Setting the Daily Timer**

Once you have set the Daily Timer, the timer will be activated at the same time every day.

The “DAILY” indicator on the display shows that the Daily Timer you have set is in effect.

You can set the Daily Timer whether the System is on or off (but not in power saving mode (See page 10)).

**Note**

- If you have made a mistake while setting the timer, press the CANCEL button on the Remote Control. However, this does not always cancel the current setting. If the CANCEL button does not work, press the CLOCK/TIMER button on the Remote Control repeatedly until the display returns to the original display, and start from the first step.

## On the Remote Control

### 1 Press the CLOCK/TIMER button repeatedly until "ON (time)" appears on the display.

At this time, "DAILY" indicator blinks on the display. Each time you press the button, the display changes as follows.

DAILY ON?/DAILY OFF? → ON (time)\* → Clock setting display → Cancelled → (back to the beginning)  
\*: Select this item!

The System enters ON-time setting mode, and the current ON time appears on the display and the hour digits blink.

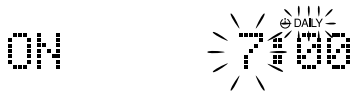

### 2 Setting the ON time (Example: 10:15).

1. Press the ► or ◀ button to set the hour you want the System to come on, then press the SET button. The minute digits of the ON time blink on the display. Pressing the ► button moves the time forwards and pressing the ◀ button moves it backwards. Holding down the button moves the time.

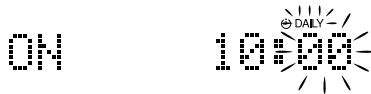

2. Press the ► or ◀ button to set the minute, then press the SET button.

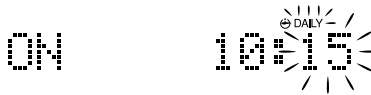

The System enters OFF-time setting mode, and the hour digits blink.

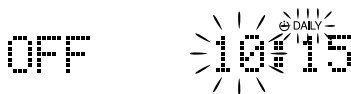

### 3 Setting the OFF time (Example: 13:30).

Note that the same time as the ON time cannot be set.

1. Press the ► or ◀ button to set the hour you want the System to be turned off, then press the SET button. The minute digits of the OFF time blink on the display.

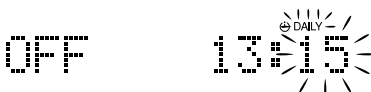

2. Press the ► or ◀ button to set the minute, then press the SET button.

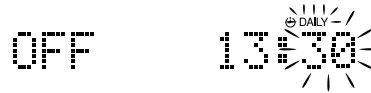

The System enters the Music Source Selecting mode and "FM?" appears on the display.

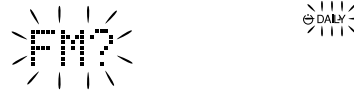

### 4 Selecting the music source.

Press the ► or ◀ button to select the music source you want to listen to, then press the SET button. Each time you press the ► or ◀ button, the display changes as shown below:

FM? ↔ AM? ↔ CD? ↔ LINE?\* ↔ MELODY?  
↔ (back to the beginning)

\*: If the name has been changed, that name (e.g. "TAPE") will appear. (See page 21.)

According to the music source you have selected, the next operation differs.

- FM?** : Tunes in to the specified preset FM station.
- AM?** : Tunes in to the specified preset AM (MW) station.
- CD?** : Plays the specified track on the specified CD.
- LINE?** : Plays an external source.
- MELODY?** : Select one of 10 melodies.

#### Preparation for each music source:

Perform the following operation according to the music source you have selected. Then, the System enters Volume Setting mode.

- **When selecting "FM?" or "AM?"**  
Press the ► or ◀ button to select the preset station number, then press the SET button.
  - If you select the display "- -", the current broadcast station is selected.
- **When selecting "CD?"**  
Press the ► or ◀ button to select the track number you want to start playback, then press the SET button.
  - If you select the display "- -", playback will start from the first track.
- **When selecting "LINE?"**  
Prepare the external equipment so that it will turn on at the ON time set by the System. To allow this, the equipment should have the timer function.
- **When selecting "MELODY?"**  
Press the ► or ◀ button to select one of melodies (MELODY 1-10). Then, the selected melody is played back.

## 5 Setting the volume level.

Press the ► or ◀ button to select the volume level (VOLUME 1-50), then press the SET button.



## 6 Select the FADE function.

Press the ► or ◀ button to select either “FADE” (fades in at power on) or “NoFADE” (does not fade in).

## 7 Press the SET button.

The timer setting is completed, and the “DAILY” indicator stops blinking and remains lit. Each setting you have made appears on the display in the order of ON time, OFF time, music source, volume and fading. Then, the display returns to the display before you set the timer.

## 8 Press the STANDBY/ON button to turn off the System.

The Clock indicator (⌚) and “DAILY” indicator are lit on the display, showing that the Daily Timer is set to on.

**To change the timer setting**, repeat the setting procedure from the beginning.

### When the timer ON-time comes:

The following operation will be automatically repeated every day.

- When the timer ON-time comes, the System automatically turns on. The “DAILY” indicator blinks, and then “DAILY TIMER” and “TIMER STANDBY” alternate for a while. After that, the music source you have set is played. The “DAILY” indicator blinks during timer operation. In the case of MELODY, it’s title scrolls on the display.
- When the timer OFF-time comes, “DAILY TIMER” and “OFF” alternate for a while. Then, the System automatically turns off and the “DAILY” indicator remains lit.

### Selectable Melodies

When you select the melody as the source in step 4, you can use one of the following melodies.

MELODY 1:Twinkle Twinkle Little Star (by W.A.Mozart)

MELODY 2:Grandfather’s Clock (by H.C.Work)

MELODY 3:Csikos Post (by H.Necke)

MELODY 4:Farewell Song (by La chambre de Chopin)

MELODY 5:Canon (by J.Pachelbel)

MELODY 6:Menuett (by J.S.Bach)

MELODY 7:Humoresk (by A.Dvorak)

MELODY 8:Serenade (by J.Haydn)

MELODY 9:Jesus,Joy Of Man’s Desiring (by J.S.Bach)

MELODY10:Ravel’s Bolero (by Ravel)

- When you select the melody as the source, only the title of the selected melody will appear on the display.

### Notes

- When a melody is set for the Daily Timer while playing back the CD, the CD will stop playing.
- In step 4, the selected melody will be played back for your reference. However, if the melody is selected with the System turned off, no melody will be heard.
- During setting the melody, the source cannot be selected with the Source selector on the Unit or the source select button on the Remote Control.
- If the system is already on when the timer ON-time comes, the Daily Timer does not work.

## Turning the Daily Timer On and Off

Once you have set the Daily Timer, it is stored in memory. So, the Daily Timer will be activated at the same time every day until it is canceled.

**To cancel the Daily Timer temporarily:**

### On the Remote Control

- 1 Press the CLOCK/TIMER button repeatedly until the “DAILY ON?/DAILY OFF?” appears on the display.**

The “DAILY” indicator blinks on the display.

- 2 Press the CANCEL button.**

“DAILY OFF” appears and the “DAILY” indicator goes out.

**To activate the canceled Daily Timer:**

### On the Remote Control

- 1 Press the CLOCK/TIMER button repeatedly until the “DAILY ON?/DAILY OFF?” appears on the display.**

The “DAILY” indicator blinks on the display.

- 2 Press the SET button.**

The “DAILY” indicator remains lit. Each setting already made appears on the display in the order of ON time, OFF time, music source, volume, and fading. Then the display returns to the original display.

- “DAILY TIMER/NO SET” appears on the display before you enter the timer setting.

### CAUTION:

- **If the System is unplugged, or a power failure occurs, the timer setting will be lost. You will need to reset the clock first, then the timer.**

## Setting the SLEEP Timer

Use the Sleep Timer to turn the System off after a certain number of minutes when it is playing. By setting the Sleep Timer, you can fall asleep to music and know that your System will turn off by itself rather than play all night.

- You can only set the Sleep Timer when the System is on.

### On the Remote Control

#### 1 During playback a source, press the SLEEP button.

The "SLEEP" indicator lights up on the display.

#### 2 Set the length of time you want the source to play before shutting off.

Each time you press the SLEEP button, the time length changes as follows:

10 → 20 → 30 → 60 → 90 → 120 → OFF → (back to the beginning)



#### 3 Wait for a few seconds.

The display returns to the original one. The display is dimmed (DIMMER 2 mode) and the CD lamp goes out. The System is now set to turn off after the number of minutes you have set.

#### To Confirm the Sleep Time:

When the SLEEP button is pressed, the remaining sleep time is displayed. Wait until the display returns to the original display.

#### To Cancel the SLEEP Timer Setting:

Press the SLEEP button on the Remote Control until "SLEEP OFF" appears and the "SLEEP" indicator goes out on the display.

- Pressing the CLOCK/TIMER button or turning off the System also cancels the SLEEP Timer.



- When the SLEEP button is used without setting the clock, "CLOCK ADJUST!" appears on the display. You need to set the clock beforehand.

## Timer Priority

The timer that will turn off earlier has the priority. You will see the priority from the following examples.

### Example 1

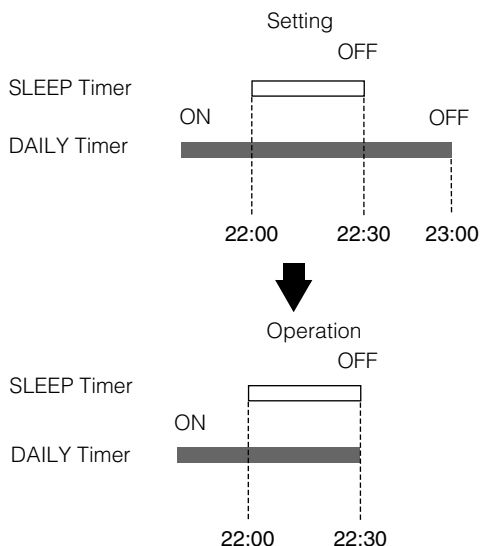

### Example 2

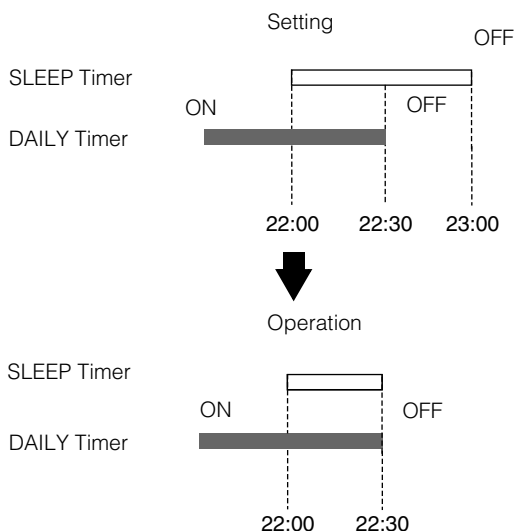

# Troubleshooting

- If you are having a problem with your System, check this list for a possible solution before calling for service.
- If you cannot solve the problem from the hints given here "ERROR!" appears on the display, or the System has been physically damaged, call a qualified person, such as your dealer, for service.

Symptom	Possible Cause	Action
No sound is heard.	<ul style="list-style-type: none"> <li>• Connections are incorrect, or loose.</li> <li>• Headphones are connected.</li> </ul>	<ul style="list-style-type: none"> <li>• Check all connections and make corrections. (See pages 5 to 8.)</li> <li>• Disconnect the headphones.</li> </ul>
Poor radio reception	<ul style="list-style-type: none"> <li>• The antenna is disconnected.</li> <li>• The AM (MW) Loop Antenna is too close to the System.</li> <li>• The FM Wire Antenna is not properly extended and positioned.</li> </ul>	<ul style="list-style-type: none"> <li>• Reconnect the antenna securely.</li> <li>• Change the position and direction of the AM (MW) Loop Antenna.</li> <li>• Extend FM Wire Antenna to the best reception position.</li> </ul>
Stereo effect is lost in FM broadcast.	FM reception mode is changed to "FM MONO".	Press the FM/PLAY MODE button to select "FM AUTO". (See page 13)
The CD skips.	<ul style="list-style-type: none"> <li>• The CD is dirty or scratched.</li> <li>• Track Skip marks are recorded.</li> </ul>	<ul style="list-style-type: none"> <li>• Clean or replace the CD.</li> <li>• This is normal.</li> </ul>
The CD does not play.	<ul style="list-style-type: none"> <li>• The CD is upside down.</li> <li>• Track Skip mark is recorded for the first track of the disc.</li> </ul>	<ul style="list-style-type: none"> <li>• Put the CD in with the label side up.</li> <li>• Wait until the Unit finds a track without a Track Skip mark.</li> </ul>
Unable to operate the Remote Control.	<ul style="list-style-type: none"> <li>• The path between the Remote Control and the sensor on the Unit is blocked.</li> <li>• The batteries have lost their charge.</li> </ul>	<ul style="list-style-type: none"> <li>• Remove the obstruction.</li> </ul>
Operations are disabled.	The built-in microprocessor has malfunctioned due to external electrical interference.	<ul style="list-style-type: none"> <li>• Replace the batteries.</li> </ul> Unplug the System then plug it back in.
"CD NO DISC" appears.	There is no disc loaded.	Insert a disc.
"CD CAN'T PLAY" appears.	<ul style="list-style-type: none"> <li>• You are trying to playback a CD which cannot be played, or there is a problem with the CD.</li> <li>• The disc has been inserted with its label side down.</li> </ul>	<ul style="list-style-type: none"> <li>• Change the disc.</li> </ul>
"CD DOOR ERROR" appears.	The object is blocking the CD door to open.	<ul style="list-style-type: none"> <li>• Remove the disc and insert it with the label side up.</li> </ul> Press the ▲ CD button to close the CD door and remove the object.
When the CD door is operating (opening or closing) while you are listening to FM, AM (MW) or LINE, the source is muted.	This is one of the characteristics of this system.	This is normal.
Some of the CD functions, such as skip or search, do not work correctly.	You are playing an unfinalized disc.	This is normal. If you need to use these functions, finalize the disc. (This Unit cannot finalize CD-R/CD-RW)

# Care And Maintenance

Handle your CDs carefully, and they will last a long time.

## Compact Discs

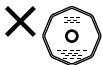

- Only CDs bearing these marks can be used with this System. However, continued use of irregular shape CDs (heart-shape, octagonal, etc.) can damage the System.

- Remove the CD from its case by holding it at the edges while pressing the case's center hole lightly.
- Do not touch the shiny surface of the CD, or bend the CD.

- Put the CD back in its case after use to prevent warping.
- Be careful not to scratch the surface of the CD when placing it back in the case.
- Avoid exposure to direct sunlight, temperature extremes, and moisture.

- A dirty CD may not play correctly. If a CD does become dirty, wipe it with a soft cloth in a straight line from center to edge.

## CAUTION:

- Do not use any solvent (for example, conventional record cleaner, spray thinner, benzene, etc.) to clean a CD.

## General Notes

In general, you will have the best performance by keeping your CDs and the mechanism clean.

- Store CDs in their cases, and keep them in cabinets or on shelves.
- Keep the System's CD door closed when not in use.

## Cleaning the Unit

### Stains on the Unit

Should be wiped off with a soft cloth. If the Unit is heavily stained, wipe it with a cloth soaked in water-diluted neutral detergent and wrung well, then wipe clean with a dry cloth.

- Since the Unit may deteriorate in quality, become damaged or get its paint peeled off, be careful about the followings.

- DO NOT wipe it with a hard cloth.
- DO NOT wipe it strong.
- DO NOT wipe it with thinner or benzene.
- DO NOT apply any volatile substance such as insecticides to it.
- DO NOT allow any rubber or plastic to remain in contact with it for a long time.

## Cleaning the Lens

If the lens in the CD pickup is dirty, dropout, etc., could degrade sound.

Open the CD door and clean the lens as shown.

- Use a blower (available from a camera store) to blow dust off the lens.

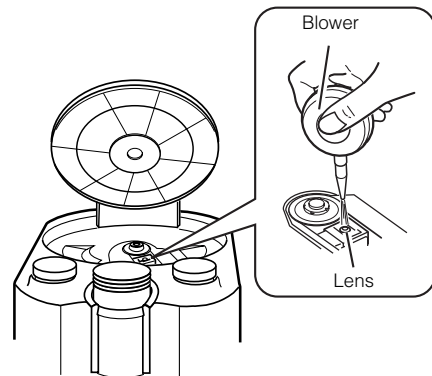

- If there are fingerprints, etc. on the lens, gently wipe clean with a cotton swab.

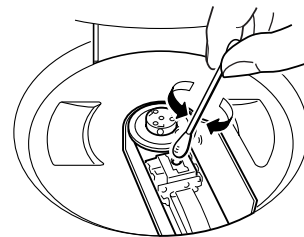

## Moisture Condensation

Moisture may condense on the lens inside the System in the following cases:

- After turning on heating in the room.
- In a damp room.
- If the System is brought directly from a cold to a warm place.

Should this occur, the System may malfunction. In this case, leave the System turned on for a few hours until the moisture evaporates, unplug the AC power cord, and then plug it in again.





# Specifications

## CA-FSX5 Amplifier

Output Power	
Main	:60 W (30 W + 30 W) at 4 $\Omega$ (1 kHz 10% THD)
Sub	:60 W (30 W + 30 W) at 4 $\Omega$ (80 Hz 10% THD)
Input Sensitivity/Impedance (1 kHz)	
LINE IN	:210 mV/51 k $\Omega$ (LEVEL 1) 520 mV/51 k $\Omega$ (LEVEL 2)
Output Sensitivity/Impedance (1 kHz)	
LINE OUT	:600 mV/5.1 k $\Omega$
OPTICAL DIGITAL OUT	:-23 dBm - -15 dBm
Speaker terminals	:MIN. 4 $\Omega$
Phones	:16 $\Omega$ - 1 k $\Omega$

## CD Player

Signal-To-Noise Ratio	:95 dB
Wow And Flutter	:Unmeasurable

## Tuner

FM Tuner	
Tuning Range	:87.50 MHz - 108.00 MHz
AM Tuner	
Tuning Range	:(MW) 522 kHz - 1 629 kHz

## Power Specifications

Power Requirements	:AC 230 V $\sim$ , 50 Hz
Power Consumption	:30 W (power on mode) 2.0 W (on Standby: with display off) 7.0 W (on Standby: with display on)

## Center Unit

Dimensions	:160 mm $\times$ 130 mm $\times$ 242 mm (W/H/D)
Mass	:Approx. 2.3 kg

## Speaker Specifications (each unit)

### SP-FSX5

Type	:2way Bass-reflex type
<b>Main-Speaker</b>	:9.5 cm $\times$ 1 cm Direct drive
Power Handling Capacity	:30 W
Impedance	:4 $\Omega$
<b>Sub-woofer</b>	:9.0 cm cone
Power Handling Capacity	:30 W
Impedance	:4 $\Omega$
Sound Pressure Level	:77 dB/W·m
Cross over frequency	:210 Hz
Frequency Range	:52 Hz $\sim$ 20 000 Hz
Dimensions	:140 mm $\times$ 301.5 mm $\times$ 185 mm (W/H/D)
Mass	:Approx. 2.3 kg each

## Accessories

FM Wire Antenna (1)
AM (MW) Loop Antenna (1)
Remote Control (1)
Batteries (2)
Speaker Cords (4)

*Design and specifications are subject to change without notice.*

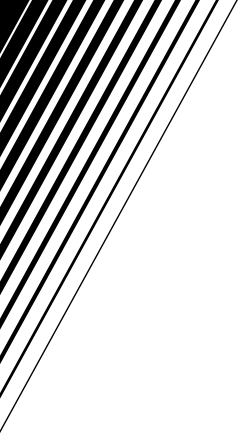

**JVC**  
VICTOR COMPANY OF JAPAN, LIMITED

## Free Manuals Download Website

<http://myh66.com>

<http://usermanuals.us>

<http://www.somanuals.com>

<http://www.4manuals.cc>

<http://www.manual-lib.com>

<http://www.404manual.com>

<http://www.luxmanual.com>

<http://aubethermostatmanual.com>

Golf course search by state

<http://golfingnear.com>

Email search by domain

<http://emailbydomain.com>

Auto manuals search

<http://auto.somanuals.com>

TV manuals search

<http://tv.somanuals.com>