

JVC



English

COMPACT COMPONENT SYSTEM
SISTEMAS DE COMPONENTES COMPACTOS
SISTEMA DE COMPONENTE COMPACTO

Español

CA-HXZ30

CA-HXZ10

Português

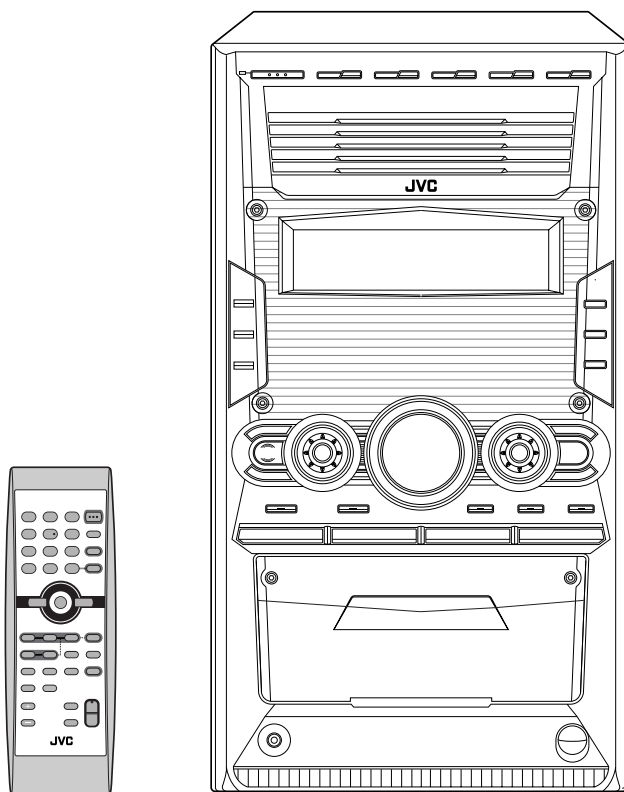

COMPACT
disc
DIGITAL AUDIO

INSTRUCTIONS

MANUAL DE INSTRUCCIONES

INSTRUÇÕES

For Customer Use:

Enter below the Model No. and Serial No. which are located either on the rear, bottom or side of the cabinet. Retain this information for future reference.

Model No. _____

Serial No. _____

GVT0100-012A
[UW, UJ]

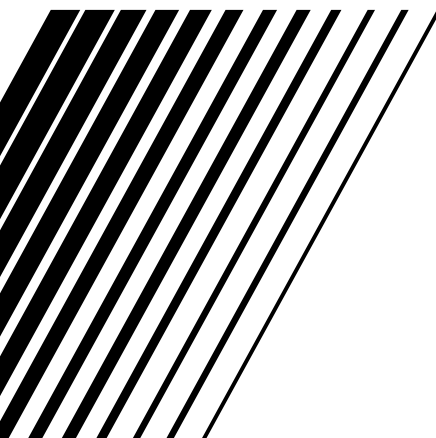

Warnings, Cautions and Others **Avisos, precauciones y otras notas** **Advertências, precauções e outras notas**

Caution— \odot/I (standby/on) button!

Disconnect the mains plug to shut the power off completely (all lamps and indications go off). The \odot/I (standby/on) button in any position does not disconnect the mains line.

- When the unit is on standby, the STANDBY lamp lights red.
 - When the unit is turned on, the STANDBY lamp goes off.
- The power can be remote controlled.

Precaución—botón \odot/I (en espera/encendido)!

Desconecte el enchufe tomacorriente para desconectar la alimentación completamente (se apagan todas las lámparas e indicaciones). Ninguna posición del botón \odot/I (en espera/encendido) conseguirá desconectar la red de alimentación eléctrica.

- Cuando la unidad está en espera, la lámpara STANDBY se enciende en rojo.
- Cuando la unidad está encendida, la lámpara STANDBY se apaga.

La alimentación puede controlarse mediante control remoto.

Precaução—botão \odot/I (standby/on)!

Desligue a ficha da tomada da parede para desligar completamente a alimentação (todas as luzes e indicadores apagam-se). O botão \odot/I (standby/on), quer esteja premido ou solto, não desliga a alimentação principal.

- Quando a unidade estiver em standby, a luz STANDBY fica vermelha.
 - Quando a unidade estiver ligada, a luz STANDBY apaga-se.
- A alimentação pode ser controlada à distância.

Caution

To reduce the risk of electrical shocks, fire, etc.:

1. Do not remove screws, covers or cabinet.
2. Do not expose this appliance to rain or moisture.

Caution

- Do not block the ventilation openings or holes. (If the ventilation openings or holes are blocked by a newspaper or cloth, etc., the heat may not be able to get out.)
- Do not place any naked flame sources, such as lighted candles, on the apparatus.
- When discarding batteries, environmental problems must be considered and local rules or laws governing the disposal of these batteries must be followed strictly.
- Do not expose this apparatus to rain, moisture, dripping or splashing and that no objects filled with liquids, such as vases, shall be placed on the apparatus.

Precaución

Para reducir riesgos de choques eléctricos, incendio, etc.:

1. No extraiga los tornillos, los cubiertas ni la caja.
2. No exponga este aparato a la lluvia o a la humedad.

Precaución

- No obstruya las rendijas o los orificios de ventilación. (Si las rendijas o los orificios de ventilación quedan tapados con un periódico, un trozo de tela, etc., no se podrá disipar el calor).
- No ponga sobre el aparato ninguna llama al descubierto, como velas encendidas.
- Cuando tenga que descartar las pilas, tenga en cuenta los problemas ambientales y observe estrictamente los reglamentos o las leyes locales sobre disposición de las pilas.
- No exponga este aparato a la lluvia, humedad, goteos o salpicaduras. Tampoco ponga recipientes conteniendo líquidos, como floreros, encima del aparato.

Precaução

Para reduzir riscos de choques elétricos, incêndio, etc.:

1. Não remova parafusos e tampas ou desmonte a caixa.
2. Não exponha este aparelho à chuva nem à umidade.

Precaução

- Não obstrua as aberturas e orifícios de ventilação. (Se os orifícios ou aberturas de ventilação estiverem obstruídos por qualquer papel ou tecido, não haverá circulação do ar quente.)
- Não coloque nenhum objeto com chamas, como velas acesas, sobre o aparelho.
- Ao descartar as baterias, leve em consideração os problemas que possam ser causados ao meio ambiente e os regulamentos e leis locais e governamentais sobre recolhimento dessas baterias devem ser rigorosamente seguidos.
- Não exponha este aparelho à chuva, umidade, pingos ou esguichos de água, nem coloque em cima do mesmo qualquer tipo de recipiente que contenha líquidos, como por exemplo vasos.

Caution: Proper Ventilation

To avoid risk of electric shock and fire, and to prevent damage, locate the apparatus as follows:

- 1 Front: No obstructions and open spacing.
- 2 Sides/ Top/ Back: No obstructions should be placed in the areas shown by the dimensions below.
- 3 Bottom: Place on the level surface. Maintain an adequate air path for ventilation by placing on a stand with a height of 10 cm or more.

Precaución: El aparato debe estar bien ventilado

Para evitar posibles riesgos de descargas eléctricas e incendios y prevenir cualquier posible daño, coloque el aparato del modo siguiente:

- 1 Parte delantera: No ponga nada delante, deje el espacio libre.
- 2 Laterales/ parte superior/ parte trasera: No se debería colocar nada en las áreas y las distancias que se detallan a continuación.
- 3 Parte inferior: Coloque el aparato sobre una superficie recta. Debe haber buena circulación de aire; para ello, coloque el aparato sobre una base a una altura mínima de 10 cm.

Precaução: Ventilação adequada

Para evitar riscos de choques elétricos e incêndios, e prevenir avarias, instale o aparelho como segue:

- 1 Parte frontal: Sem obstruções e espaços abertos.
- 2 Partes laterais/ Tampa/ Posterior: Nenhuma obstrução deverá ser colocada entre as áreas cujas dimensões são indicadas abaixo.
- 3 Parte inferior: Instale-o sobre uma superfície plana. Deverá ser mantido espaço suficiente para a ventilação se este for instalado numa posição que tenha uma altura de 10 cm ou mais.

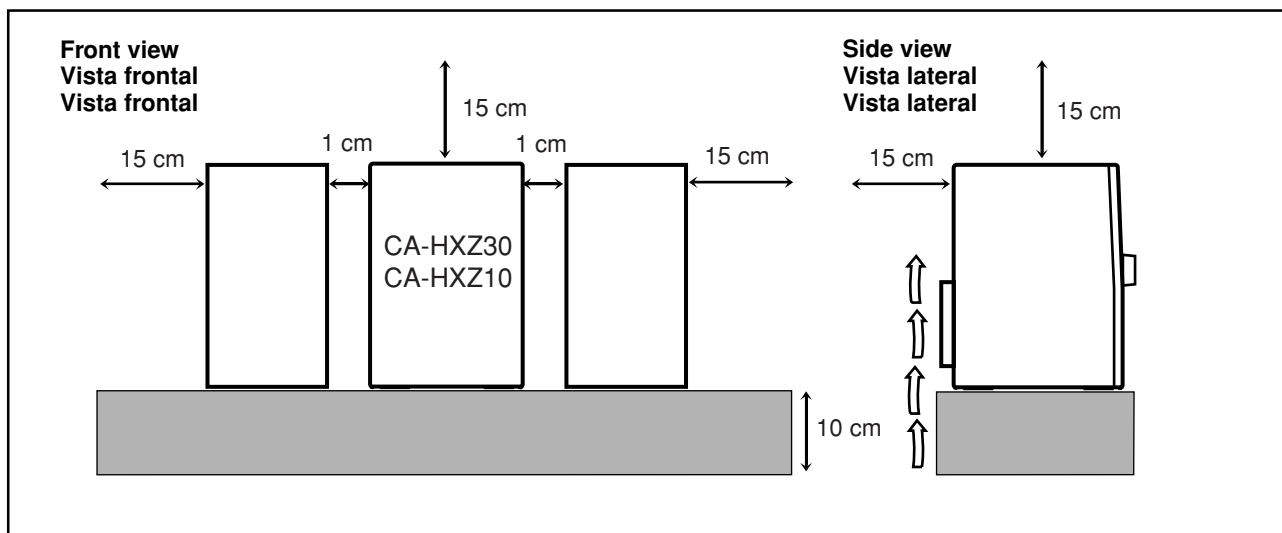

**IMPORTANT FOR LASER PRODUCTS
 IMPORTANTE PARA PRODUCTOS LÁSER
 IMPOTANTE PARA PRODUTOS LASER**

REPRODUCTION OF LABELS / REPRODUCCIÓN DE ETIQUETAS / REPRODUÇÃO DE ETIQUETAS

- | | |
|---|---|
| <p>① CLASSIFICATION LABEL ON EXTERIOR SURFACE</p> <p>① ETIQUETA DE CLASIFICACIÓN SOBRE LA SUPERFICIE EXTERIOR</p> <p>① ETIQUETA DE CLASSIFICAÇÃO LOCALIZADA NA SUPERFÍCIE EXTERNA</p> | <p>② WARNING LABEL INSIDE THE UNIT</p> <p>② ETIQUETA DE ADVERTENCIA DEL INTERIOR DE LA UNIDAD</p> <p>② ETIQUETA DE ADVERTÊNCIA LOCALIZADA NA PARTE INTERNA DA UNIDADE</p> |
|---|---|

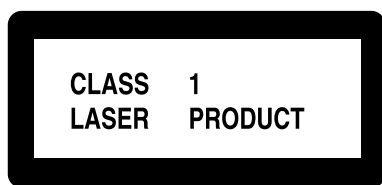

DANGER : Invisible laser radiation when open and interlock failed or defeated. AVOID DIRECT EXPOSURE TO BEAM. (e)

WARNING : Osynlig laserstrålning när denna del är öppnad och spärren är urkopplad. Betrakta ej strålen. (s)

ADVARSEL : Usynlig laserstrålning ved åbning, når sikkerhedsafbrydere er ude af funktion. Undgåudsætelse for stråling. (d)

VARO : Avattaessa ja suojalukitus ohitettaessa olet alttiina näkymättömälle lasersäteilylle. Älä katso säteeseen. (f)

1. CLASS 1 LASER PRODUCT
2. **DANGER**: Invisible laser radiation when open and interlock failed or defeated. Avoid direct exposure to beam.
3. **CAUTION**: Do not open the top cover. There are no user serviceable parts inside the Unit; leave all servicing to qualified service personnel.

1. PRODUCTO LÁSER CLASE 1
2. **PELIGRO**: En el interior hay radiación láser invisible. Evite el contacto directo con el haz.
3. **PRECAUCIÓN**: No abra la tapa superior. En el interior de la unidad no existen piezas reparables por el usuario; deje todo servicio técnico en manos de personal calificado.

1. PRODUTO LASER CLASSE 1
2. **PERIGO**: O laser emite uma radiação invisível que é perigosa, caso o aparelho esteja aberto e a trava inoperante ou danificada. Evite exposição direta ao feixe dos raios.
3. **CUIDADO**: Não abra a caixa do aparelho. Não existem peças reparáveis pelo usuário na parte interna da unidade. Solicite assistência técnica somente a pessoal técnico qualificado.

Introduction

We would like to thank you for purchasing one of our JVC products. Before operating this unit, read this manual carefully and thoroughly to obtain the best possible performance from your unit, and retain this manual for future reference.

About This Manual

This manual is organized as follows:

- **The manual mainly explains operations using the buttons and controls on the unit. You can also use the buttons on the remote control if they have the same or similar names (or marks) as those on the unit. If operation using the remote control is different from that using the unit, it is then explained.**
- Basic and common information that is the same for many functions is grouped in one place, and is not repeated for each procedure. For instance, we do not repeat the information about turning on/off the unit, setting the volume, changing the sound effects, etc., which are explained in the section “Common Operations” on pages 9 to 11.
- The following symbols are used in this manual:



Gives you warning and caution to prevent damage or risk of fire/electric shock. Furthermore, it gives you information about what is not good for obtaining the best possible performance from the unit.



Gives you information and hints you should know.

Precautions

Installation

- Install in a place which is level, dry and neither too hot nor too cold—between 5°C and 35°C.
- Install the unit in a location with adequate ventilation to prevent internal heat buildup in the unit.
- Leave sufficient distance between the unit and the TV.
- Keep the speakers away from the TV to avoid interference with TV.



DO NOT install the unit in a location near heat sources, or in a place subject to direct sunlight, excessive dust or vibration.

Power sources

- When unplugging the unit from the wall outlet, always pull on the plug, not the AC power cord.



DO NOT handle the AC power cord with wet hands.

Moisture condensation

Moisture may condense on the lens inside the unit in the following cases:

- After starting heating in the room
 - In a damp room
 - If the unit is brought directly from a cold to a warm place
- Should condensation occur, the unit may malfunction. In this case, leave the unit turned on for a few hours until the moisture evaporates, unplug the AC power cord, then plug it in again.

Internal heat

A cooling fan is mounted on the rear panel to prevent heat buildup inside the unit.



For safety, observe the following carefully:

- Make sure there is good ventilation around the unit. Poor ventilation could overheat and damage the unit.
- DO NOT block the cooling fan and the ventilation openings or holes. If they are blocked by a newspaper or cloth, etc., the heat may not be able to get out.

Others

- Should any metallic object or liquid fall into the unit, unplug the AC power cord and consult your dealer before operating any further.
- If you are not going to operate the unit for an extended period of time, unplug the AC power cord from the wall outlet.



DO NOT disassemble the unit since there are no user serviceable parts inside.

If anything goes wrong, unplug the AC power cord and consult your dealer.

Location of the Buttons and Controls	3
Front Panel	3
Remote Control	5
Getting Started	6
Supplied Accessories	6
Putting the Batteries into the Remote Control	6
Connecting Antennas	6
Connecting Speakers	7
Connecting Other Equipment	8
Adjusting the Voltage Selector	8
Canceling the Demonstration	8
Common Operations	9
Turning On or Off the Power	9
Setting the Clock	9
Selecting the Sources	9
Adjusting the Volume	10
Reinforcing the Bass Sound	10
Selecting the Sound Modes	10
Creating Your Own Sound Mode—User Mode	11
Turning On or Off the Key-touch Tone	11
Listening to FM and AM Broadcasts	12
Setting the AM Tuner Interval Spacing	12
Tuning in to a Station	12
Presetting Stations	12
Tuning in to a Preset Station	12
Disc Play Introduction	13
Playing Back Discs	15
Loading Discs	15
Playing Back the Entire Discs—Continuous Play ...	15
Basic Disc Operations	16
Programming the Playing Order of the Tracks	
—Program Play	17
Playing at Random—Random Play	18
Repeating Tracks or Discs—Repeat Play	19
Prohibiting Disc Ejection—Tray Lock	19
Playing Back Tapes	20
Playing Back a Tape	20
Locating the Beginning of a Song—Music Scan	20
Recording	21
Recording on a Tape	21
Synchronized Recording	22
Using the Timers	23
Using Daily Timer	23
Using Recording Timer	25
Using Sleep Timer	26
Timer Priority	26
Maintenance	27
Troubleshooting	28
Specifications	29

Location of the Buttons and Controls

Become familiar with the buttons and controls on your unit.

Front Panel

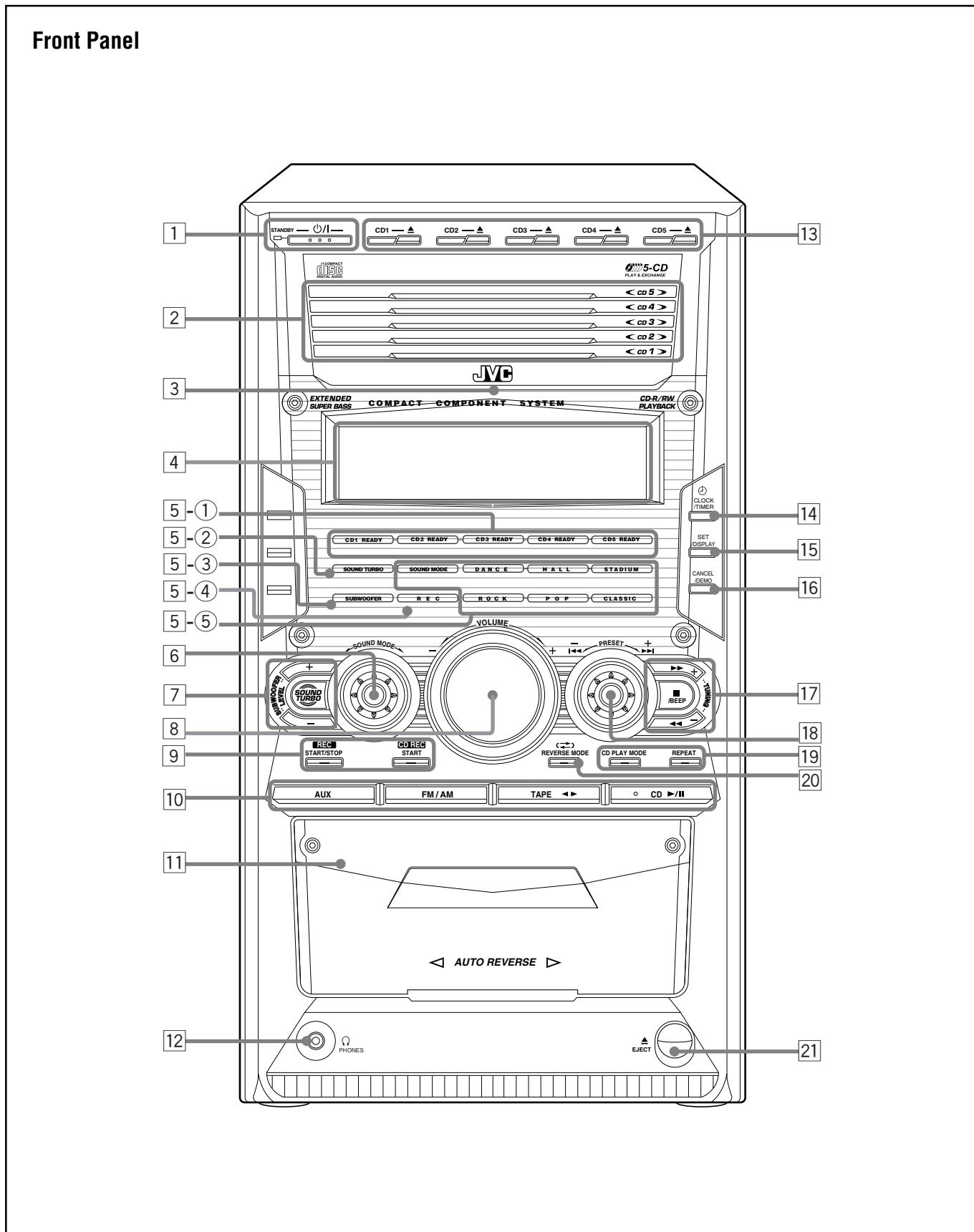

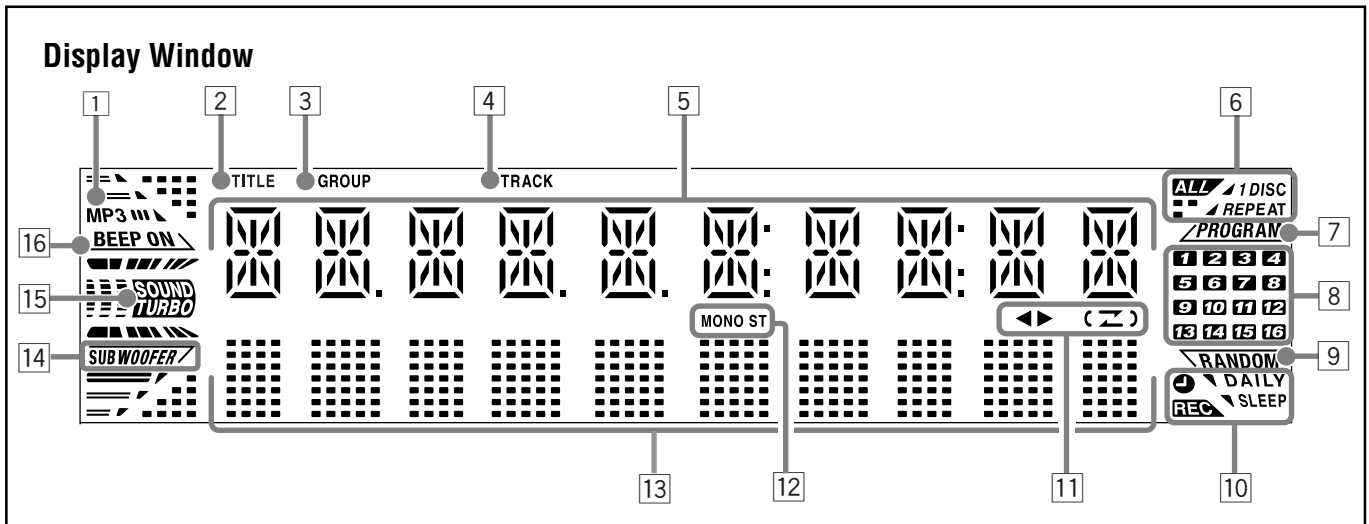

See pages in parentheses for details.

Front Panel

- 1 O/I (standby/on) button and STANDBY lamp (9, 12, 24, 25)
- 2 Disc trays (CD1 – CD5)
- 3 Remote sensor
- 4 Display window
- 5 Indication lamp panel
 - ① CD ready lamps (13)
 - CD1 READY, CD2 READY, CD3 READY, CD4 READY, CD5 READY
 - ② SOUND TURBO lamp (10)
 - ③ SUBWOOFER lamp (10)
 - ④ REC lamp (21, 22)
 - ⑤ Sound mode lamps (10)
 - SOUND MODE
 - Surround mode lamps
DANCE, HALL, STADIUM
 - SEA (Sound Effect Amplifier) mode lamps
ROCK, POP, CLASSIC
- 6 SOUND MODE control (10)
- 7 SUBWOOFER LEVEL + / – buttons (10)
SOUND TURBO button (10)
- 8 VOLUME + / – control (10)
- 9 Recording buttons (21, 22, 25)
 - REC START/STOP, CD REC START
- 10 Source buttons (9)

Pressing one of these buttons also turns on the unit.

 - AUX, FM/AM (12), TAPE \blacktriangleleft / \blacktriangleright (20, 21),
CD \blacktriangleright / \blacksquare (16 – 18, 22)
- 11 Cassette holder (20)
- 12 O PHONES jack (10)
- 13 Disc number buttons (15 – 17, 18, 22) and \blacktriangle (disc tray open/close) buttons (15, 16, 19) (CD1 – CD5)
- 14 O CLOCK/TIMER button (9, 23 – 26)
- 15 SET/DISPLAY button (9, 11, 12, 17, 23 – 26)
- 16 CANCEL/DEMO button (8, 9, 18, 23 – 26)
- 17 TUNING + / – buttons (12)
 - \blacktriangleright / \blacktriangleleft (forward search/reverse search) buttons (11, 16, 20)
 - \blacksquare (stop) button
 - BEEP button (8, 11)

- 18 PRESET + / – control (12)
 - \blacktriangleright / \blacktriangleleft (forward skip/reverse skip) control (9, 11, 16 – 18, 22 – 25)
- 19 Disc play mode buttons (17 – 19)
 - CD PLAY MODE, REPEAT
- 20 \blacktriangleleft / \blacktriangleright REVERSE MODE button (20 – 22)
- 21 \blacktriangle EJECT button for cassette deck (20 – 22)

Display Window

- 1 MP3 indicator
- 2 TITLE indicator
- 3 GROUP indicator
- 4 TRACK indicator
- 5 Main display
 - Shows the source name, frequency, etc.
- 6 REPEAT (ALL/1/DISC) indicators (19)
- 7 PROGRAM indicator (17)
- 8 Disc track number indicators
- 9 RANDOM indicator (18)
- 10 Timer indicators (23 – 26)
 - DAILY (Daily Timer), SLEEP (Sleep Timer),
REC (Recording Timer), O (Timer)
- 11 Tape operation indicators (20 – 22)
 - \blacktriangleleft / \blacktriangleright (tape direction), \blacktriangleleft / \blacktriangleright (Reverse Mode)
- 12 Tuner operation indicators (12)
 - MONO, ST (stereo)
- 13 Audio level indicator

When one of the 6 preset sound modes is activated, this will function as illumination display. For details, see “Selecting the Sound Modes” on pages 10 and 11.
- 14 SUBWOOFER indicator (10)
- 15 SOUND TURBO indicator (10)
- 16 BEEP ON indicator (8, 11)

Remote Control

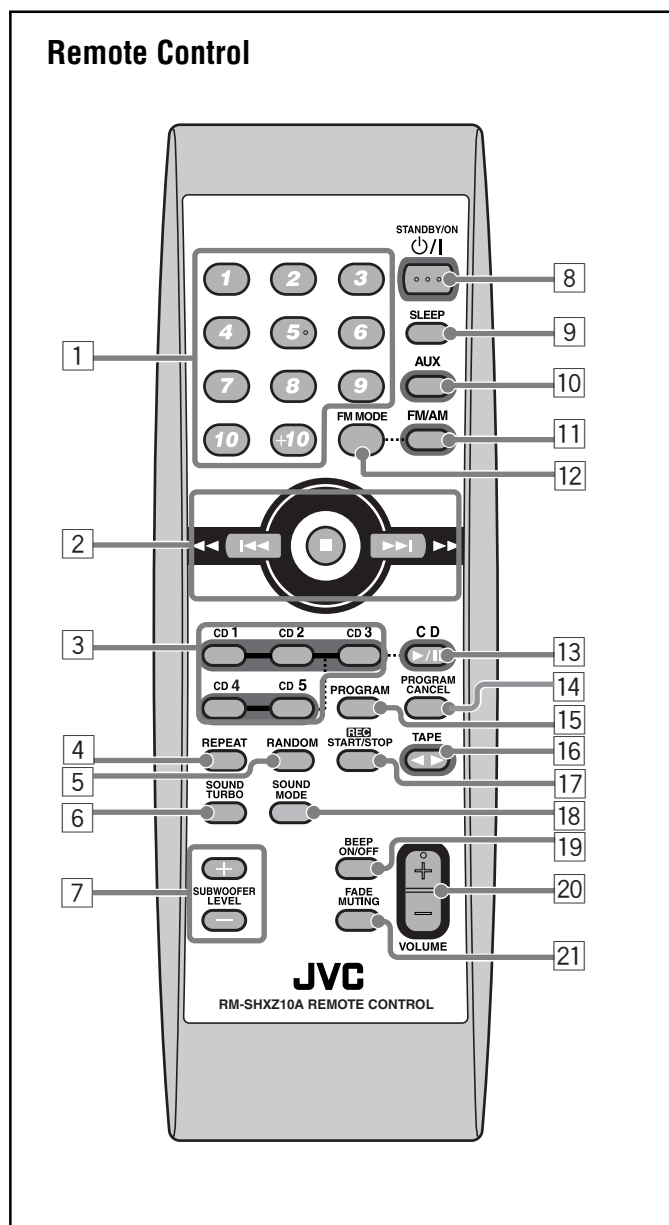

Remote Control

- 1 Number buttons (12, 16, 17)
- 2 ▶▶ (▶▶) (forward skip/forward search) button (12, 16, 18, 20)
◀◀ (◀◀) (reverse skip/reverse search) button (12, 16, 18, 20)
■ (stop) button
- 3 Disc number buttons (CD1 – CD5) (15, 17, 18)
Pressing one of these buttons also turns on the unit.
- 4 REPEAT button (19)
- 5 RANDOM button (18)
- 6 SOUND TURBO button (10)
- 7 SUBWOOFER LEVEL + / – buttons (10)
- 8 STANDBY/ON ϕ /I button (9)
- 9 SLEEP button (26)
- 10 AUX button (9)
Pressing this button also turns on the unit.
- 11 FM/AM button (9, 12)
Pressing this button also turns on the unit.
- 12 FM MODE button (12)
- 13 CD ▶/|| button (9, 16 – 18)
Pressing this button also turns on the unit.
- 14 PROGRAM CANCEL button (18)
- 15 PROGRAM button (17)
- 16 TAPE ◀▶ button (9, 20, 21)
Pressing this button also turns on the unit.
- 17 REC START/STOP button (21)
- 18 SOUND MODE button (10)
- 19 BEEP ON/OFF button (8, 11)
- 20 VOLUME + / – button (10)
- 21 FADE MUTING button (10)

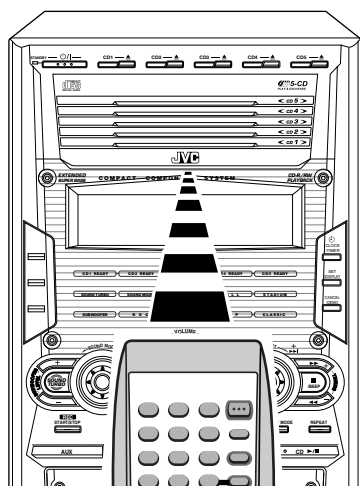

When using the remote control, point it at the remote sensor on the front panel.

Supplied Accessories

Make sure that you have all the following items. The number in parentheses indicates the quantity of each piece supplied.

- AM loop antenna (1)
- FM antenna (1)
- Remote control (1)
- Batteries (2)
- AC plug adaptor (1)

If anything is missing, consult your dealer immediately.

Putting the Batteries into the Remote Control

Insert the batteries—R6(SUM-3)/AA(15F)—into the remote control, by matching the polarity (+ and -) on the batteries with the + and - markings on the battery compartment. When the remote control can no longer operate the unit, replace both batteries at the same time.

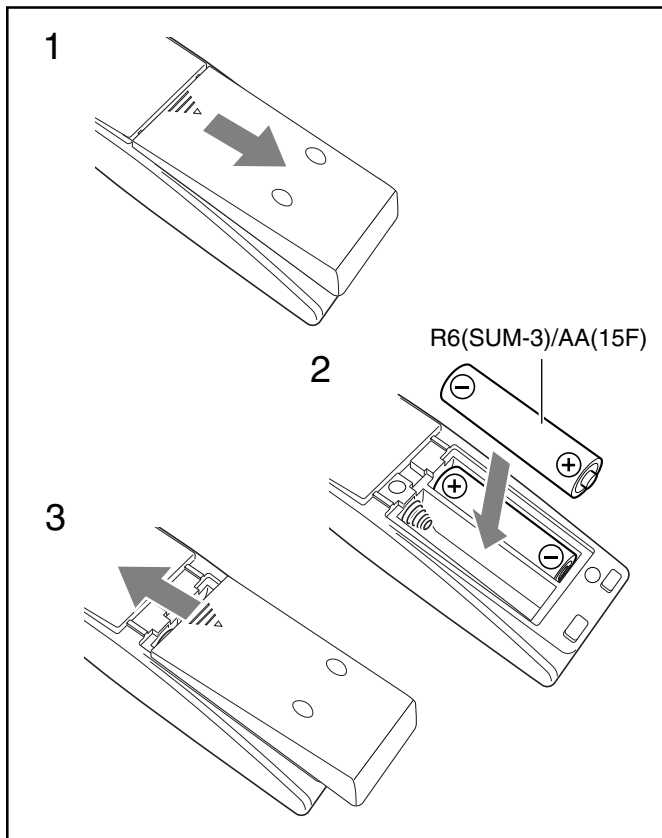

- DO NOT use an old battery together with a new one.
- DO NOT use different types of batteries together.
- DO NOT expose batteries to heat or flame.
- DO NOT leave the batteries in the battery compartment when you are not going to use the remote control for an extended period of time. Otherwise, the remote control will be damaged from battery leakage.



Connecting Antennas

FM antenna

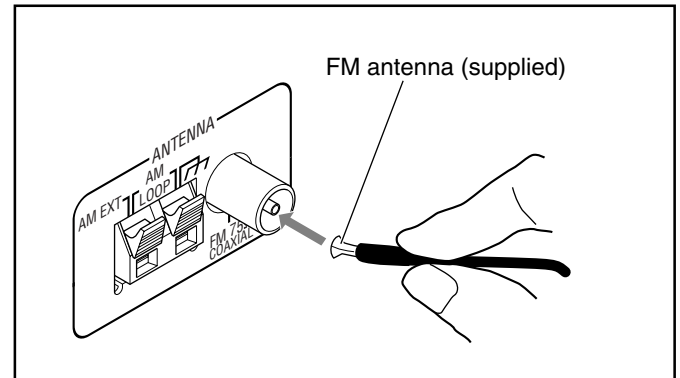

- 1 Attach the FM antenna to the FM 75 Ω COAXIAL terminal.
- 2 Extend the FM antenna.
- 3 Fasten it up in the position which gives you the best reception, then fix it on the wall, etc.



About the supplied FM antenna

The FM antenna supplied with this unit can be used as temporary measure. If reception is poor, you can connect an outdoor FM antenna.

To connect an outdoor FM antenna

Before connecting the antenna, disconnect the supplied FM antenna.

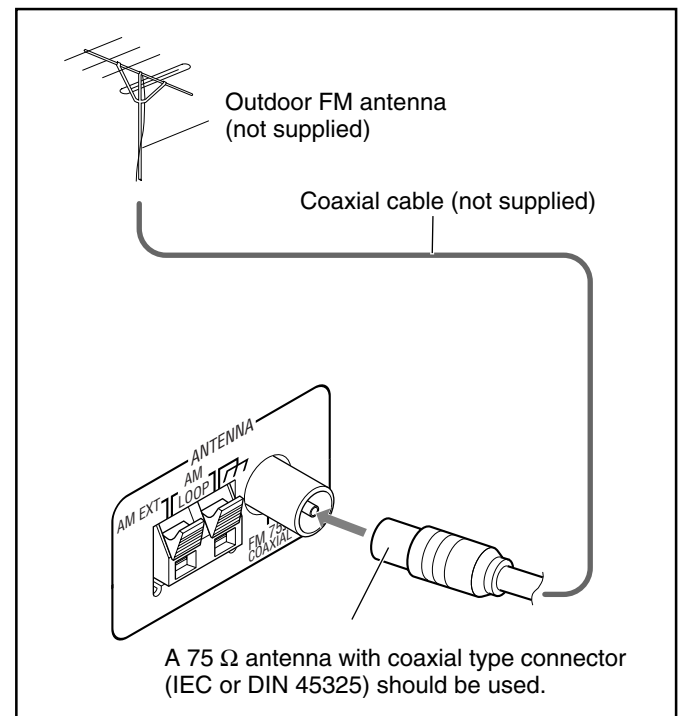

AM antenna

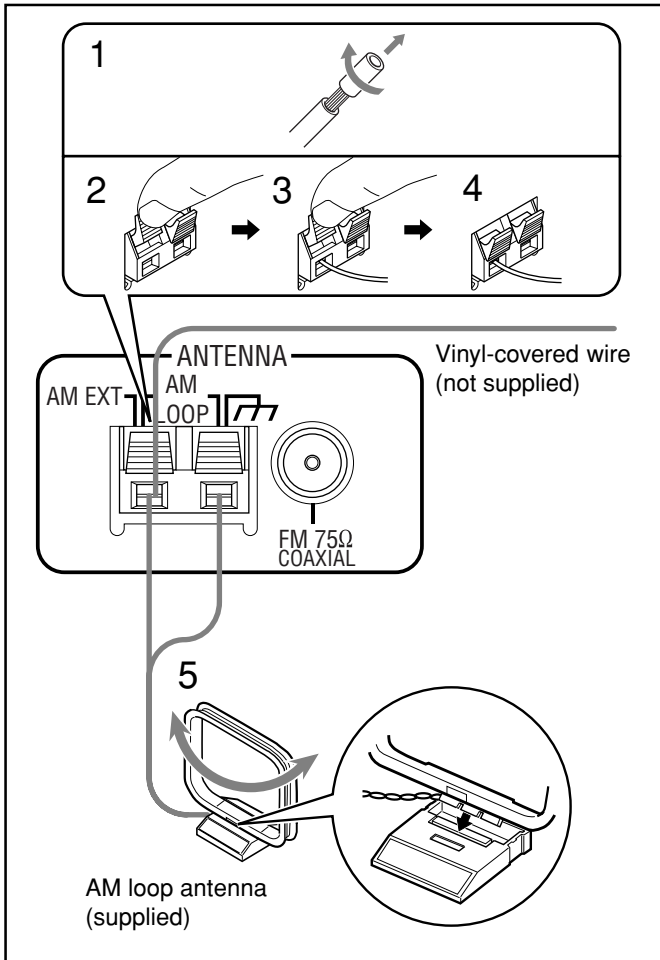

- 1 If the cords are covered with insulation, remove a short section of insulation at the end of each cord by twisting and pulling it off.
- 2 Press and hold the clamp of the AM LOOP terminals on the rear of the unit.
- 3 Insert the AM loop antenna to the AM LOOP terminals as illustrated.
- 4 Release your finger from the clamp.
- 5 Turn the AM loop antenna until you have the best reception.

To connect an outdoor AM antenna

When reception is poor, connect a single vinyl-covered wire to the AM EXT terminal and extend it horizontally. The AM loop antenna must remain connected.



For better reception of both FM and AM

- Make sure the antenna conductors do not touch any other terminals and connecting cords.
- Keep the antennas away from metallic parts of the unit, connecting cords, and the AC power cord.

Connecting Speakers

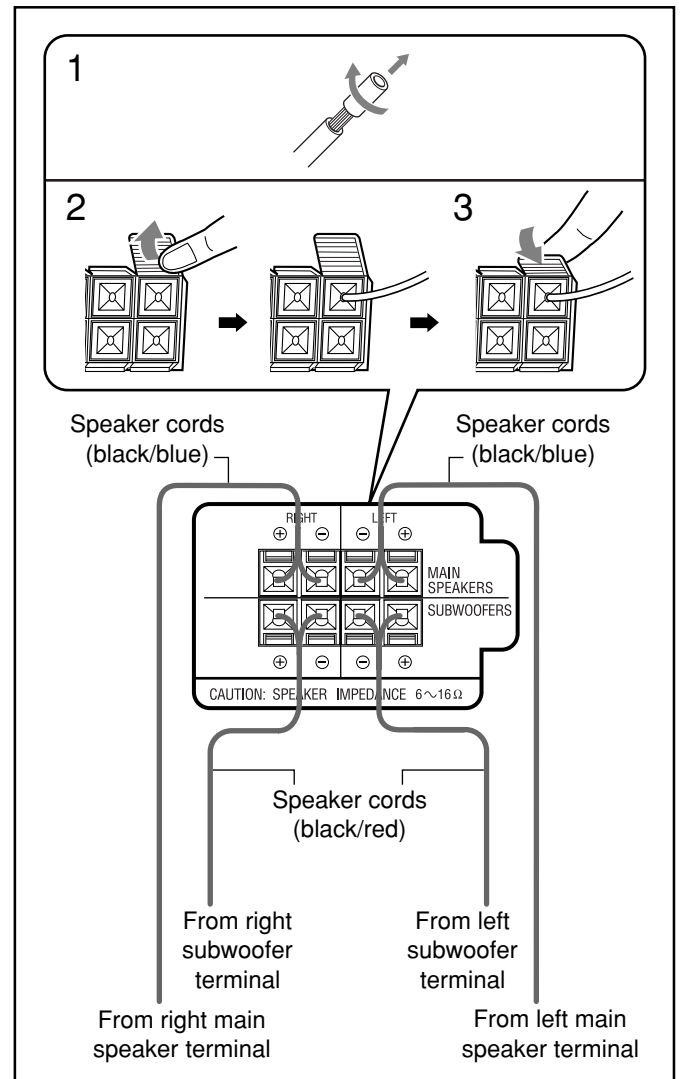

- 1 If the cords are covered with insulation, remove a short section of insulation at the end of each cord by twisting and pulling it off.
- 2 Insert the end of the speaker cord into the terminal as illustrated.
Match the same polarity: (+) to (+) and (-) to (-).
- 3 Close the speaker terminals.

IMPORTANT: Use only speakers with the same speaker impedance as indicated by the speaker terminals on the rear of the unit.



- DO NOT connect more than one speaker to each speaker terminal.
- DO NOT push or pull the speakers as this will damage the foot spacers at the bottom of the speakers.

Connecting Other Equipment

You can connect an external audio component used only as a playback device.



- DO NOT connect any equipment while the power is on.
- DO NOT plug in any equipment until all connections are complete.

To connect an external audio component

Be sure that the plugs of the audio cords are colored: White plugs and jacks are for left audio signals, and red ones for right audio signals.

To play external audio component through this unit, connect between the audio output jacks on the other equipment and AUX jacks by using an audio cord (not supplied).

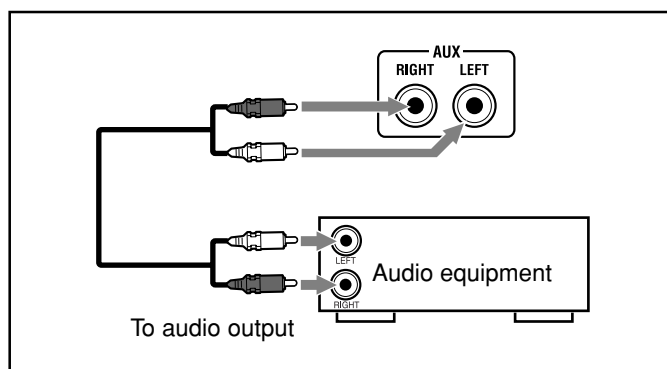

Adjusting the Voltage Selector

Before plugging in the unit, set the correct voltage for your area with the voltage selector on the rear of the unit.

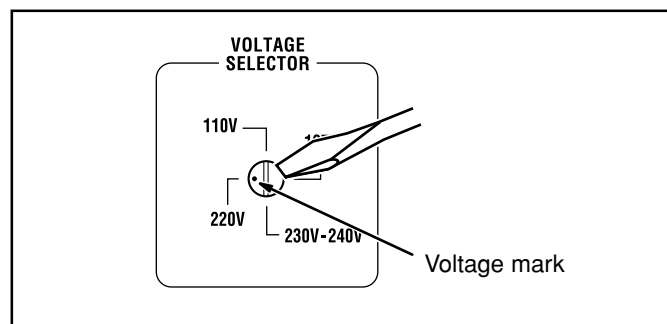

Use a screwdriver to rotate the voltage selector so that the voltage mark is pointing at the same voltage as where you are plugging in the unit. (See the back cover page.)



- DO NOT plug in before setting the voltage selector on the rear of the unit and all connection procedures are complete.

Now, you can plug the AC power cord.

- If the wall outlet does not match the AC plug, use the supplied AC plug adaptor.

IMPORTANT: Be sure to check that all connections are done before plugging the AC power cord into a wall outlet.

Canceling the Demonstration

When connecting the AC power cord to a wall outlet, the unit automatically starts demonstration.

To cancel the demonstration, press and hold CANCEL/DEMO until "DEMO OFF" appears on the display.



- To cancel only beep sounds during the demonstration, press and hold BEEP for more than 2 seconds or press BEEP ON/OFF on the remote control.



The BEEP ON indicator goes off from the display.



When you press other buttons



The demonstration stops temporarily. It will start automatically again (if no operation is done for 2 minutes) unless you cancel it by pressing CANCEL/DEMO.

To start demonstration manually

Press and hold CANCEL/DEMO again until "DEMO START" appears on the display.



Common Operations

Turning On or Off the Power

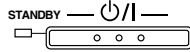
To turn on the unit, press  (or STANDBY/ON  on the remote control) so that the STANDBY lamp goes off.



POWER ON

To turn off the unit (standby), press  (or STANDBY/ON  on the remote control) again so that the STANDBY lamp lights up.

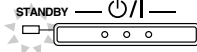

- A little power is always consumed even while the unit is on standby.

To switch off the power supply completely, unplug the AC power cord from the AC outlet.



When you unplug the AC power cord or if a power failure occurs

The clock is reset to “0:00” immediately, while the tuner preset stations (see page 12) will be erased in a few days.

Setting the Clock

Before operating the unit any further, first set the clock built in this unit. “0:00” will flash on the display until you set the clock.

- You can set the clock whether the unit is on or off.

On the unit ONLY:

1 Press CLOCK/TIMER.

The hour digits start flashing on the display.



2 Turn / to adjust the hour, then press SET/DISPLAY.

The minute digits start flashing on the display.

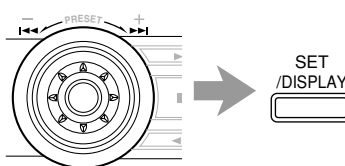

To correct the hour after pressing SET/DISPLAY, press CANCEL/DEMO. The hour digits start flashing again.



3 Turn / to adjust the minutes, then press SET/DISPLAY.

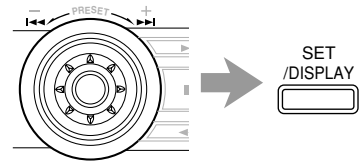

CLOCK OK

To check the clock time while playing a source

Press and hold SET/DISPLAY.

- Each time you press and hold the button, the source indication and the clock time alternate on the display.

To adjust the clock again

If you have set the clock before, press  CLOCK/TIMER repeatedly until the clock setting mode is selected.

- Each time you press the button, the clock/timer setting modes change as follows:

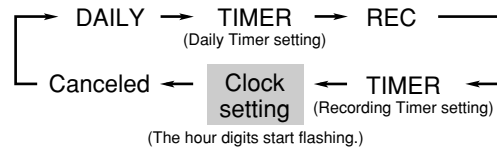





- **When you unplug the AC power cord or if a power failure occurs**



The clock loses its setting and is reset to “0:00.” If this happens, set the clock again.

- **The clock may gain or loss 1 to 2 minutes per month**
If this happens, reset the clock.

Selecting the Sources

Press one of the source buttons—FM/AM, CD , TAPE , and AUX.

When you press one of the source buttons (FM/AM, CD , TAPE , and AUX), the unit turns on and starts playing the source if it is ready.

- To listen to the FM/AM broadcasts, press FM/AM. (See page 12.)
- To play back discs, press CD . (See pages 13 – 19.)
- To play back tapes, press TAPE . (See page 20.)
- To select an external component as the source, press AUX.



Adjusting the Volume

You can adjust the volume level only while the unit is turned on. The volume level can be adjusted in 32 steps (VOLUME MIN, VOLUME 1 – VOLUME 30, and VOLUME MAX). The volume level control does not affect recording.

Turn **VOLUME + / –** clockwise (+) to increase the volume or counterclockwise (–) to decrease it.

When using the remote control, press **VOLUME +** to increase the volume or **VOLUME –** to decrease it.

- When adjusting the volume, the back color on the display changes as increasing/decreasing the level—not lighting ↔ blue ↔ purple ↔ pink ↔ red.

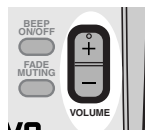
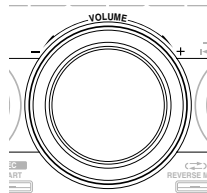

VOLUME 15

To turn off the volume level temporarily

On the remote control ONLY:

Press **FADE MUTING**.

The volume level gradually decreases to “VOLUME MIN.”



To restore the sound, press the button again.

To listen with headphones

Connect a pair of headphones to the PHONES jack on the unit. The sound will no longer come out of the speakers. Disconnecting a pair of headphones from the PHONES jack activates the speakers again.



- DO NOT set the volume to a high level before connecting or putting on headphones.
- DO NOT turn off (standby) the unit with the volume set to an extremely high level; otherwise, a sudden blast of sound can damage your hearing, speakers and/or headphones when you turn on the unit or start playing any source next time. REMEMBER, you cannot adjust the volume level while the unit is off (standby).

Reinforcing the Bass Sound

Changing the subwoofer level

You can select one of the 3 subwoofer levels—LEVEL 0 (MIN LEVEL), LEVEL 1, and LEVEL 2 (MAX LEVEL). This function only affects the playback sound, but does not affect your recording.

Press **SUBWOOFER LEVEL +** to increase the subwoofer level or **SUBWOOFER LEVEL –** to decrease it.

The **SUBWOOFER** indicator lights up on the display.

The **SUBWOOFER** lamp also flashes when LEVEL 1 or LEVEL 2 (MAX LEVEL) is selected. The lamp stops flashing when LEVEL 0 (MIN LEVEL) is selected.

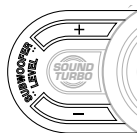

To enjoy heavy sound

You can enjoy heavy sound by using Sound Turbo. This function boosts the low and high frequency sound.

- Activating Sound Turbo cancels the sound mode and/or subwoofer adjustment.

Press **SOUND TURBO**.

The **SOUND TURBO** indicator lights up on the display and the **SOUND TURBO** lamp also flashes. The subwoofer level increases to the maximum level (LEVEL 2).

- Each time you press **SOUND TURBO**, Sound Turbo is turned on (subwoofer LEVEL 2) or off (subwoofer LEVEL 0).



notes If you press **SUBWOOFER + / –** or select a sound mode during activating Sound Turbo

Sound Turbo is canceled.

Selecting the Sound Modes

You can select one of the 6 preset sound modes (3 surround modes and 3 SEA—Sound Effect Amplifier—modes) and 3 user modes. This function only affects the playback sound, but does not affect recording.

To select the sound modes, turn **SOUND MODE** (or press **SOUND MODE** on the remote control) until the sound mode you want appears on the display.

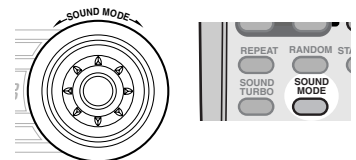

- When one of the sound modes is selected, the lamp for the selected sound mode and the **SOUND MODE** lamp flash.
- When one of the user modes (USER 1, USER 2, or USER 3) is selected, only the **SOUND MODE** lamp flashes.

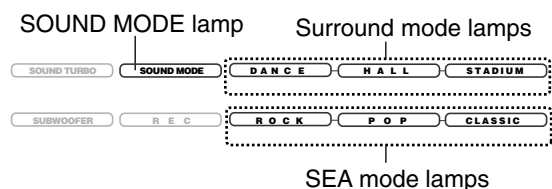

The sound modes change as follows:

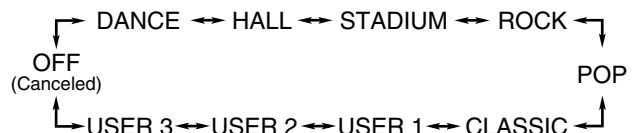

When using the remote control, the sound mode changes only clockwise in the above sequence.

Surround modes*

- DANCE:** Increases resonance and bass.
HALL: Adds depth and brilliance to the sound.
STADIUM: Adds clarity and spreads the sound, as in an outdoor stadium.

SEA (Sound Effect Amplifier) modes

- ROCK:** Boosts low and high frequency. Good for acoustic music.
POP: Good for vocal music.
CLASSIC: Good for classical music.

User modes

USER 1/2/3: Your individual mode stored in memory. See “Creating Your Own Sound Mode—User Mode” below.

OFF: The sound mode is canceled.

* Surround elements are added to the SEA elements to create a being-there feeling in your room.



When you turn on Sound Turbo

The sound mode is canceled.

Creating Your Own Sound Mode—User Mode

You can change the SEA pattern to suit your preference. The SEA pattern can be adjusted using 3 frequency ranges—BASS, MID (middle), and TRE (treble). These changed settings can be stored as the USER 1, USER 2, and USER 3 modes.

- There is a time limit in doing the following steps. If the setting is canceled before you finish, start from step 1 again.

On the unit ONLY:**1 Select one of the preset sound modes.**

- If you want to add surround elements into your SEA pattern, select one of the surround modes (DANCE, HALL, or STADIUM) before starting the procedure below. (See “Selecting the Sound Modes” on page 10.)

2 Press SET/DISPLAY while the selected sound mode is still shown on the display.



SEA CONT



BASS +3

Current level appears.

3 Adjust the SEA pattern.

- 1) Turn ►►/◄◄ to select the frequency range (BASS, MID or TRE).
- 2) Press ►► or ◄◄ to adjust the level (–3 to +3) of the selected frequency range.
- 3) Repeat steps 1) and 2) to adjust the level of the other frequency ranges.

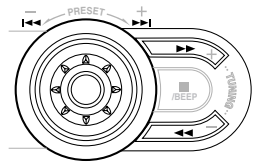
**4 Press SET/DISPLAY again.**

USER 1

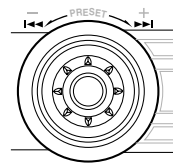

5 Turn ►►/◄◄ to select one of the user modes (USER 1, USER 2, or USER 3) in which you want to store your SEA pattern.

**6 Press SET/DISPLAY again.**

MEMORY

The SEA pattern you have created is stored into the user mode selected in step 5.

To use your own sound mode

Select USER 1, USER 2, or USER 3 mode when using the sound modes. See “Selecting the Sound Modes” on page 10.



When you unplug the AC power cord or if a power failure occurs

The setting will be erased in a few days. If this happens, set the user modes again.

Turning On or Off the Key-touch Tone

If you do not want the key-touch tone to beep each time you press a button or turn a control, you can deactivate it. The BEEP ON indicator goes off from the display.

On the unit:

Press and hold BEEP for more than 2 seconds.

On the remote control:

Press BEEP ON/OFF.

- Each time you press the button, the key-touch tone turns on and off alternately.

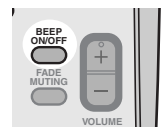

Listening to FM and AM Broadcasts

Setting the AM Tuner Interval Spacing

Some countries space AM stations 10 kHz apart, and some countries use 9 kHz spacing.

- You can only change the AM tuner interval spacing while tuning in to an AM station. (10 kHz is the initial setting.)

On the unit ONLY:

Press **⏻/I** while holding down **■**.

- Each time you press these buttons, the AM tuner interval spacing alternates between 9 kHz and 10 kHz.

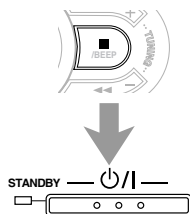

Tuning in to a Station

1 Press FM/AM.

The unit automatically turns on and tunes in to the previously received station (either FM or AM).

- Each time you press the button, the band alternates between FM and AM.

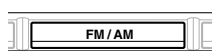

2 Start searching for stations.

On the unit:

Press and hold **TUNING +** or **TUNING -** for more than 1 second.



On the remote control:

Press and hold **▶▶▶ (▶▶▶)** or **◀◀◀ (◀◀◀)** for more than 1 second.



The unit starts searching for stations and stops when a station of sufficient signal strength is tuned in.

- If a program is broadcast in stereo, the ST (stereo) indicator lights up.

To stop searching, press **TUNING +** or **TUNING -** (or **▶▶▶ (▶▶▶) / ◀◀◀ (◀◀◀)** on the remote control).



When you press **TUNING +** or **TUNING -** (or **▶▶▶ (▶▶▶) / ◀◀◀ (◀◀◀)** on the remote control) briefly and repeatedly

The frequency changes step by step.

To change the FM reception mode

On the remote control ONLY:

When an FM stereo broadcast is hard to receive or noisy, press **FM MODE** so that the **MONO** indicator lights up on the display. Reception will improve.

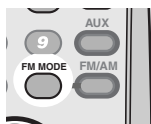

To restore the stereo effect, press **FM MODE** again so that the **MONO** indicator goes off. In this stereo mode, you can hear stereo sounds when a program is broadcast.

Presetting Stations

You can preset 30 FM and 15 AM stations.

In some cases, test frequencies have been already memorized for the tuner since the factory examined the tuner preset function before shipment. This is not a malfunction. You can preset the stations you want into memory by following the presetting method.

- There is a time limit in doing the following steps. If the setting is canceled before you finish, start from step 2 again.

On the unit ONLY:

1 Tune in to the station you want to preset.

- See "Tuning in to a Station."

2 Press SET/DISPLAY.



3 Turn PRESET + / - to select a preset number.

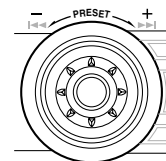

4 Press SET/DISPLAY again.

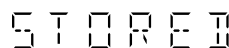

The tuned station in step 1 is stored in the preset number selected in step 3.

- Storing a new station on a number already used erases the previously stored one.



When you unplug the AC power cord or if a power failure occurs

The preset stations will be erased in a few days. If this happens, preset the stations again.

Tuning in to a Preset Station

1 Press FM/AM.

The unit automatically turns on and tunes in to the previously received station (either FM or AM).

- Each time you press the button, the band alternates between FM and AM.

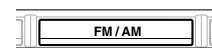

2 Select a preset number.

On the unit:

Turn **PRESET + / -**.

On the remote control:

Press the number buttons.

Ex.: For preset number 5, press 5.

For preset number 15, press +10, then 5.

For preset number 25, press +10, +10, then 5.

For preset number 30, press +10, +10, then 10.

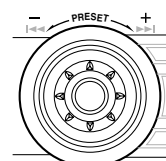

Disc Play Introduction

This unit has been designed to play back the following discs:

- CD (Audio CD)/CD-R (CD-Recordable)/CD-RW (CD-ReWritable)
- MP3 disc (MP3 files recorded on a CD-R or CD-RW)*

When playing a CD-R or CD-RW

User-edited CD-Rs (CD-Recordable) and CD-RWs (CD-ReWritable) can be played back only if they have been “finalized.”

- You can play back your original CD-Rs or CD-RWs recorded in music CD format or in MP3 format. However, they may not be played back depending on their characteristics or recording conditions.
- Before playing back CD-Rs or CD-RWs, read their instructions or cautions carefully.
- Some CD-Rs or CD-RWs may not play back on this unit because of their disc characteristics, damage or stain on them, or if the player’s lens is dirty.
- CD-RWs may require a longer readout time. This is caused by the fact that the reflectance of CD-RWs is lower than for regular discs.

About the CD ready lamps

Each CD ready lamp shows the status of a disc placed on each corresponding disc tray (CD1 – CD5).



- **CD ready lamps light up**
When the disc is loaded and currently selected.
- **CD ready lamps light slightly**
When the disc is loaded, but not currently selected.
- **CD ready lamp flashes**
When the disc is played back or paused.
- **CD ready lamps goes off**
When the unit detects there is no disc loaded on a certain tray. (“NO DISC # (number)” appears on the display.)



If the loaded disc is an MP3 disc

The corresponding CD ready lamp and the MP3 indicator will light up.

*About MP3

MP3 is an abbreviation of Motion Picture Experts Group 1 (or MPEG-1) Audio Layer 3. MP3 is simply a file format with a data compression ratio of 1:10 (128 kbps*). By using MP3 format, one CD-R or CD-RW can contains 10 times as much data volume as a regular CD can.

* Bit rate is the average number of bits that one second of audio data will consume. The basic unit of measurement for bitrate is kbps (1,024 bits per second). To get a better audio quality, choose a higher bit rate. The most popular bit rate for encoding (recording) is 128 kbps.

MP3 disc structure

On an MP3 disc, each song (material) is recorded as a file. Files are grouped into a folder. Folders can also include other folders, creating hierarchical directory layers. (See “How are MP3 files recorded and played back?” on page 14.)

This unit manages files and folders as “tracks” and “groups.” This unit can recognize up to 255 groups per disc (up to 999 tracks). The unit ignores those exceeding the maximum numbers and cannot play them back.



More about MP3 discs

- MP3 discs (either CD-R or CD-RW) require a longer readout time. (It varies due to the complexity of the recording configuration.)
- When making an MP3 disc, select ISO 9660 Level 1 or Level 2 as the disc format.
- This unit does not support multisession recording.
- This unit can play MP3 files only with the following file extensions—“.MP3,” “.Mp3,” “.mP3,” and “.mp3.”
- Files other than MP3 are ignored.
- Some MP3 discs may not be played back because of their disc characteristics or recording conditions.

How are MP3 files recorded and played back?

MP3 “tracks (files)” can be recorded in “group”—folders in PC terminology.

During recording, the tracks and groups can be arranged similarly to the tracks and folders of computer data. “Root” is similar to the root of a tree. Every track and group can be linked to the root.

In compliance with ISO 9660, the maximum allowable depth of nested folders—so called “hierarchy”—is eight (inclusive of the root).

Playback order, track search order, and group search order of the MP3 tracks recorded on a disc are determined by the writing (or encoding) application; therefore, playback order may be different from the one you have intended while recording the groups and the tracks.

The illustration shows an example of how MP3 tracks are recorded on a CD-R or CD-RW, how they are played back and how they are searched for on this unit.

- The numbers in circles next to the MP3 tracks (♪) indicate the playback order and search order of the MP3 tracks. Normally this unit plays back MP3 tracks in the recorded order.
 - The numbers inside the groups indicate the playback order and search order of the groups on an MP3 disc. Normally this unit plays back MP3 tracks in the groups in the recorded order.
- The groups marked with asterisk (*) will be skipped since they do not include any MP3 tracks.

MP3 group/track configuration:

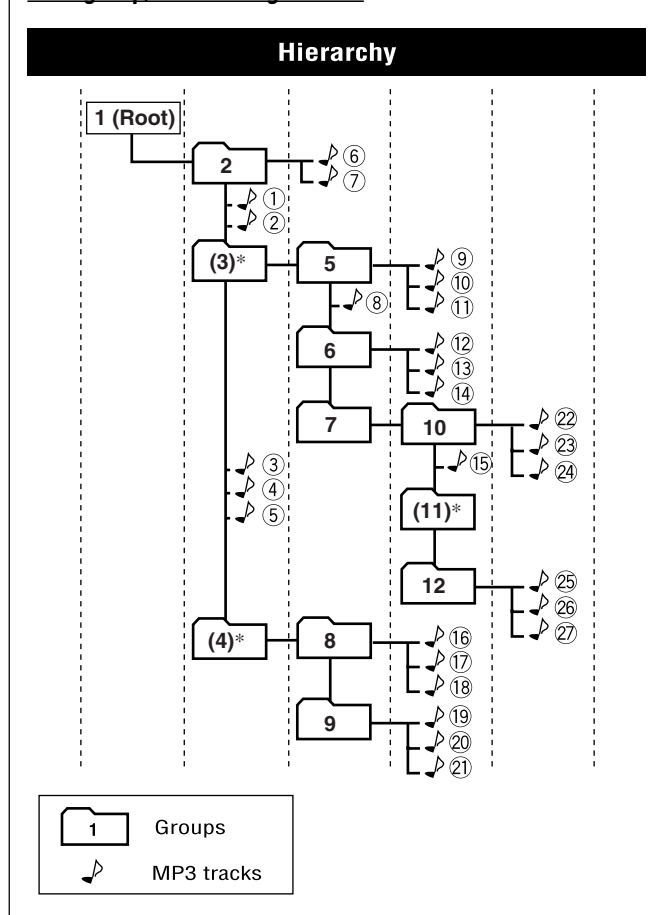

Playing Back Discs

Loading Discs

On the unit ONLY:

1 Press ▲ for the disc tray (CD1 – CD5) you want to load a disc onto.

The unit automatically turns on and the disc tray comes out.

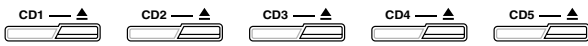

2 Place a disc correctly on the circle of the disc tray, with its label side up.

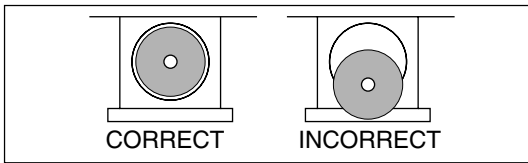

- When using a CD single (8 cm), place it on the inner circle of the disc tray.

3 Press the same ▲ you have pressed in step 1.

The disc tray closes.

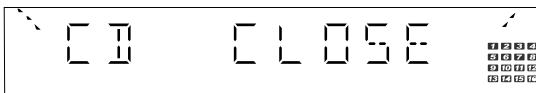

When loading more than one disc

When you press ▲ for the next tray you want to place another disc onto, the first disc tray automatically closes and then the next tray comes out.

Playing Back the Entire Discs—Continuous Play

You can play discs continuously.

- If you start Continuous Play with an MP3 disc, you can select a track to start playback.

■ For audio CDs

1 Load discs.

2 Press one of the corresponding disc number buttons (CD1 – CD5) for the disc you want to play.



The unit searches for the disc, and starts playing with the first track of the selected disc.

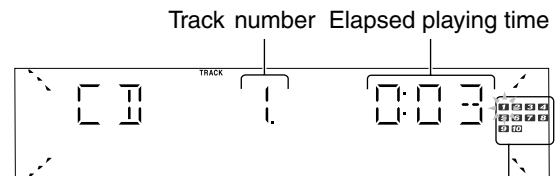

Tracks of the currently playing CD (Track numbers exceeding 16 are not displayed.)

■ For MP3 discs

1 Load discs.

2 Press one of the corresponding disc number buttons (CD1 – CD5) you load discs in step 1.

The unit searches for the disc (it may take time), and starts playing the first track of the disc.

- The MP3 indicator lights up on the display.



3 Press ■.

The group title of the 1st group appears on the display, then the group number starts flashing.

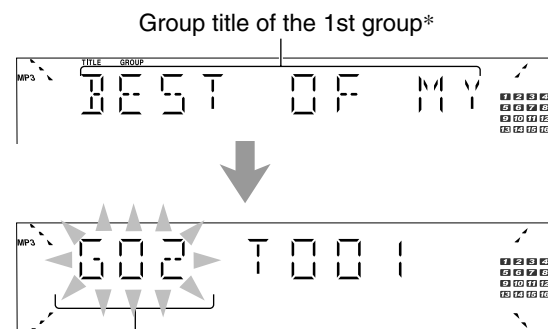

Group number flashes

- * If the entire group title cannot be shown (exceeds 10 characters), the title scrolls.

4 Select a group and track to start playing.

- 1) Turn **▶▶▶** / **◀◀◀** (or press **▶▶▶** (**▶▶▶**) / **◀◀◀** (**◀◀◀**) on the remote control) to select a group you want, then press **CD ▶/||**.
The track number starts flashing.

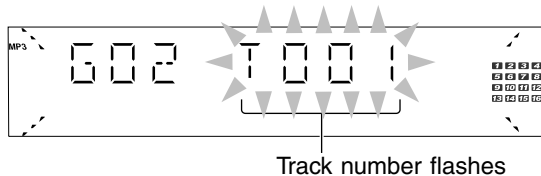
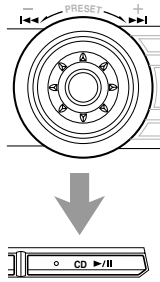

- 2) Turn **▶▶▶** / **◀◀◀** (or press **▶▶▶** (**▶▶▶**) / **◀◀◀** (**◀◀◀**) on the remote control) to select a track you want to start playback with, then press **CD ▶/||**.

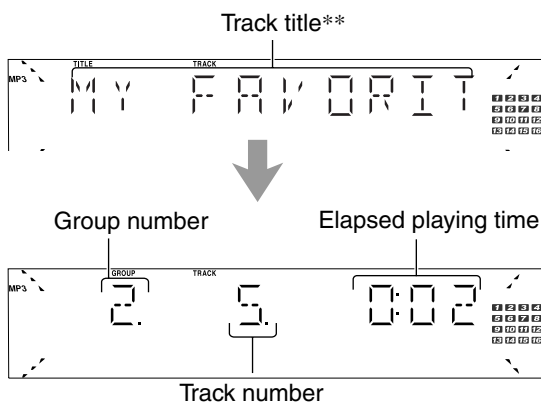

** If the entire track title cannot be shown (exceeds 10 characters), the title scrolls.

Playback starts with the selected track of the selected group.

To stop playing, press ■.

To remove the disc, press ▲ for the corresponding disc tray.

Disc playback sequence

When discs* in more than one tray are loaded on the disc trays, they are played in sequence as follows:

Ex.: When CD2 is pressed:

CD2 ⇒ CD3 ⇒ CD4 ⇒ CD5 ⇒ CD1 (then stops)

* When no disc is loaded on the tray, that disc number is skipped.

Basic Disc Operations

While playing a disc, you can do the following operations.

To exchange discs during playback of another disc

Press **▲** corresponding to a disc (CD1 – CD5), not playing or selected currently, to eject and exchange the disc.



If you exchange discs during play, the current play will not stop until all discs you have exchanged are played.

To stop play for a moment

Press **CD ▶/||**.

While pausing, the elapsed playing time flashes on the display.

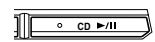

To resume playing, press CD ▶/|| again.

To go to another track

For audio CDs: Before or during play

For MP3 discs: During play

Turn **▶▶▶** / **◀◀◀** (or press **▶▶▶** (**▶▶▶**) / **◀◀◀** (**◀◀◀**) on the remote control).

- **▶▶▶** (or **▶▶▶** (**▶▶▶**)):

Skips to the beginning of the next or succeeding tracks.

- **◀◀◀** (or **◀◀◀** (**◀◀◀**)):

Goes back to the beginning of the current or previous tracks.

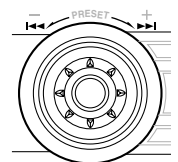

To locate a particular point in a track

During play, press and hold **▶▶** or **◀◀** (or **▶▶▶** (**▶▶▶**) / **◀◀◀** (**◀◀◀**) on the remote control).

- **▶▶** (or **▶▶▶** (**▶▶▶**)): Fast-forwards the disc.

- **◀◀** (or **◀◀◀** (**◀◀◀**)): Fast-reverses the disc.

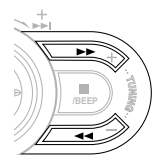

To go to another track directly using the number buttons

On the remote control ONLY:

Pressing the number button(s) before or during play allows you to start playing the track number you want.

Ex.: For track number 5, press 5.

For track number 15, press +10, then 5.

For track number 20, press +10, then 10.

For track number 32, press +10 three times, then 2.

For track number 132, press +10 thirteen times, then 2.



Programming the Playing Order of the Tracks —Program Play

You can arrange the playing order of the tracks before you start playing. **You can program up to 100 tracks.**

- To use Repeat Play (see page 19) for Program Play, press REPEAT after starting Program Play. Only REPEAT 1 and REPEAT ALL can be selected for Program Play.
- There is a time limit in doing the following steps. If the setting is canceled before you finish, start from step 2 again.

1 Load discs.

- If the current playing source is not the CD player, press CD ►/II, then ■ before going to the next step.

2 Activate Program Play.

On the unit:

Press CD PLAY MODE repeatedly until “CD PROGRAM” appears on the display.

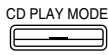

- Each time you press the button, the play mode changes as follows:

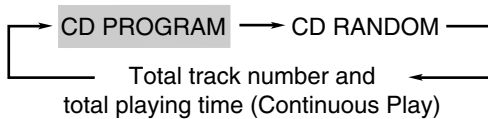

On the remote control:

Press PROGRAM so that “CD PROGRAM” appears on the display.



The PROGRAM indicator lights up on the display.

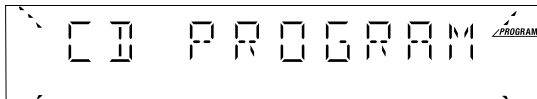

- If a program has been stored in memory, the program is called up.

3 Press one of the disc number buttons (CD1 – CD5) to select the disc you want.

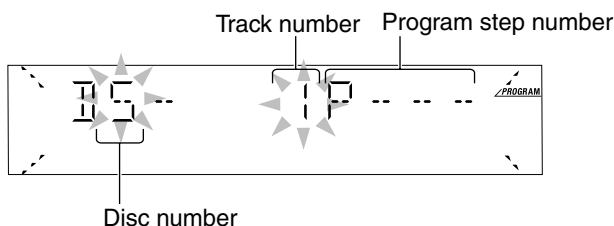
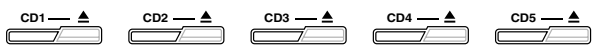

4 Select a track from the selected disc in step 3.

- Program step numbers exceeding 100 cannot be programmed.
- When making programs from MP3 discs, the unit only recognizes tracks like audio CD. You cannot make programs using group numbers.

On the unit:

Turn ►►/|/◄◄ to select the track number, then press SET/DISPLAY.

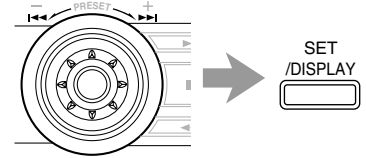

On the remote control:

Press the number buttons.

- For how to use the number buttons, see “To go to another track directly using the number buttons” on page 16.

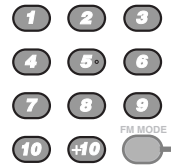

5 Program other tracks you want.

- To program tracks from the same disc, repeat step 4.
- To program tracks from a different disc, repeat steps 3 and 4.

6 Press CD ►/II.

The tracks are played in the order you have programmed.

- If the playing disc is an MP3 disc, the MP3 indicator lights up.

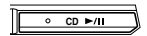

To stop playing, press ■.



To exit from Program Play, press CD PLAY MODE repeatedly until the PROGRAM indicator goes off (or press PROGRAM on the remote control) after playback stops.





- If you try to program a 101st track, “CD FULL” appears on the display.
- If you have tried to program a track from an empty tray, “NO READ # (number)” or “NO DISC # (number)” will appear on the display for 2 seconds.
- If you have tried to program a track number that does not exist, it is ignored.
- If you try to open a disc tray during Program Play, the disc tray does not come out. Open disc trays after canceling Program Play.

To check the program contents

On the remote control ONLY:

Before playing, you can check the program contents by pressing  (▶▶) or .

-  (▶▶) : Shows them in the programmed order.
-  (◀◀) : Shows the programmed tracks in the reverse order.



To modify the program

To erase the last programmed tracks, press CANCEL/DEMO (or press PROGRAM CANCEL on the remote control).

- Each time you press the button, the last programmed track is erased from the program.

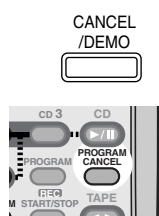

To add tracks into the program before playing, simply select the track numbers you want to add by following step 4 of the programming procedure. If you want to add tracks from another disc, follow steps 3 and 4.

To erase the entire program before or after playing, press  until "CD PROGRAM" appears on the display.

- The program you have made will be erased:
 - when you unplug the AC power cord, or
 - when a power failure occurs.

Playing at Random—Random Play

The tracks of all the loaded discs will be played at random.

- To use Repeat Play (see page 19) for Random Play, press REPEAT after starting Random Play. Only REPEAT 1 and REPEAT ALL can be selected for Random Play.

1 Load a disc.

2 Press the corresponding disc number button (CD1 – CD5) where a disc is loaded in step 1, then press .

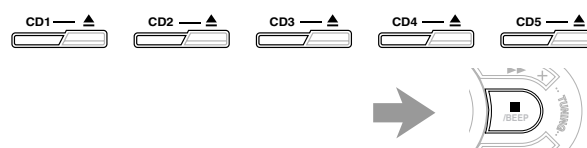

3 Activate Random Play.

On the unit:

Press CD PLAY MODE repeatedly until "CD RANDOM" appears on the display.



- Each time you press the button, the play mode changes as follows:

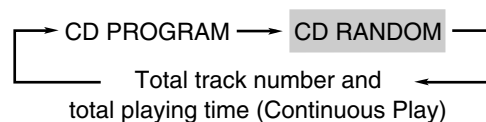

On the remote control:

Press RANDOM so that "CD RANDOM" appears on the display.

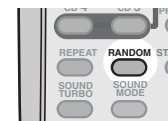





- The RANDOM indicator also lights up on the display.



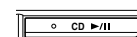

4 Press CD .

The tracks are played randomly.

Random Play ends when all the tracks of the all loaded discs are played once.



To skip the currently playing track, turn  /  to the right (or press  (▶▶) on the remote control).

 If you turn  /  to the left (or press  (◀◀) on the remote control)

You cannot go back to the previous tracks during Random Play.

To stop playing, press .

To exit from Random Play, press CD PLAY MODE repeatedly until the RANDOM indicator goes off (or press RANDOM on the remote control) after playback stops.

Repeating Tracks or Discs—Repeat Play

You can have all the discs, the program or the individual track currently playing repeat as many times as you like.

Press REPEAT during or before play.

- Each time you press the button, Repeat Play mode changes as follows:

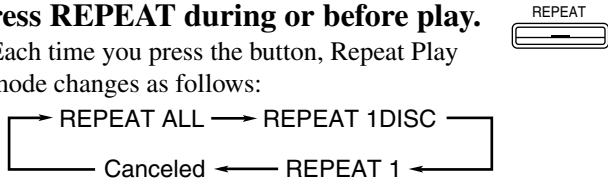

The Repeat Play mode indicators (REPEAT ALL, REPEAT 1DISC or REPEAT 1) light up on the display.

For audio CDs:

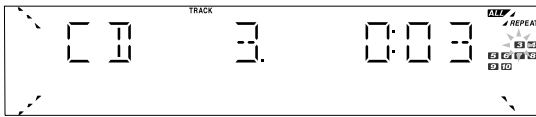

For MP3 discs:

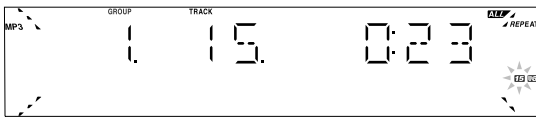

REPEAT ALL: During Continuous Play

Repeats all the tracks on all the loaded discs continuously.

During Program Play

Repeats the program you have made.

During Random Play

Repeats all the tracks of all the loaded discs randomly.

REPEAT 1DISC: Repeats all the tracks on the current disc continuously.

REPEAT 1: Repeats the track currently playing.

To cancel Repeat Play, press REPEAT repeatedly until the Repeat Play mode indicators go off from the display.



“REPEAT 1DISC” cannot be selected for Program Play or Random Play

It is also canceled when you select Program Play or Random Play.

Prohibiting Disc Ejection—Tray Lock

You can prohibit disc ejection from the unit and lock discs.

- This operation is possible only when the source is the CD player.

On the unit ONLY:

To prohibit disc ejection, press ▲ for any disc tray while holding down ■. (If any disc tray is opened, close it first.)

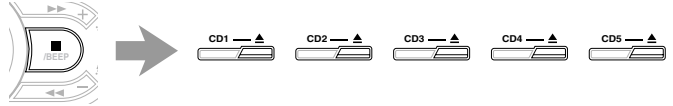

“LOCKED” appears for a while on the display, and all the loaded discs are locked.

LOCKED

To cancel the prohibition and unlock the discs, press ▲ for any disc tray while holding down ■.

“UNLOCKED” appears for a while on the display, and all the loaded discs are unlocked.

UNLOCKED



- If you try to eject discs while Tray Lock is in use, “LOCKED” appears to inform you that the disc trays are locked.
- Each time you press and hold ■ for more than 2 seconds with ▲ to lock or unlock the disc trays, key-touch tone also activates and deactivates (see page 11).

Playing Back Tapes

You can play back type I tapes.

Playing Back a Tape

1 Press **EJECT** for the cassette deck.

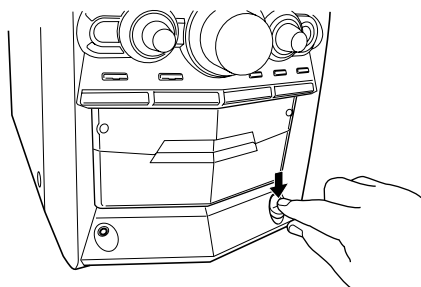

2 Insert a cassette with the exposed part of the tape down.

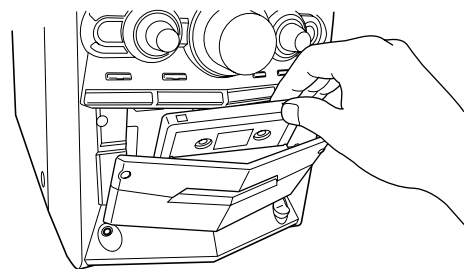

3 Close the cassette holder gently.

4 Press **TAPE** **◀▶**.



The tape play starts and the tape direction indicator (▶ or ◀) starts flashing slowly to indicate the tape's running direction.

- Each time you press the button, the tape direction changes and "REVERSE" appears for a while on the display.
 - ▶ : plays the front side.
 - ◀ : plays the reverse side.
- If no cassette is inserted, "NO TAPE" appears on the display.

When the tape plays to the end, the deck automatically stops if the Reverse Mode is off. (See "To play both sides repeatedly—Reverse Mode.")

To stop playing, press ■.

To fast-wind to the left or to the right, press ▶▶ or ◀◀ (or ▶▶| (▶▶) / |◀◀ (◀◀) on the remote control) while the tape is not running.

The tape direction indicator (▶ or ◀) starts flashing quickly on the display.

To remove the cassette, press ▲ EJECT to open the cassette holder.

To play both sides repeatedly—Reverse Mode

When using Reverse Mode, the tape automatically reverses at the end of one side, starts playing the other side of the tape, and repeats the same process.

On the unit ONLY:

To use Reverse Mode, press (↔) REVERSE MODE so that the Reverse Mode indicator lights up on the display like—(↔).



To cancel Reverse Mode, press the button again so that the Reverse Mode indicator lights up on the display like—◻.

Locating the Beginning of a Song—Music Scan

You can use Music Scan to locate the beginning of a song. Music Scan searches for blank portions that usually separate recorded songs, then plays the next song.

To find the beginning of the current song

During play, press ▶▶ or ◀◀ (or ▶▶| (▶▶) / |◀◀ (◀◀) on the remote control) in the **opposite direction** to the tape play.



The tape direction indicator of the opposite direction to the tape play starts flashing intermittently.

Searching stops automatically at the beginning of the current song, and it starts automatically.

To find the beginning of the next song

During play, press ▶▶ or ◀◀ (or ▶▶| (▶▶) / |◀◀ (◀◀) on the remote control) in the **same direction** as the tape is playing.

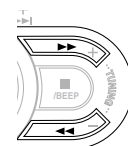

The tape direction indicator of the same direction as the tape is playing starts flashing intermittently.

Searching stops automatically at the beginning of the next song, and the song starts automatically.



Music Scan works by detecting a 4-second long blank between each song, so it will not work well in the following cases

- No blank at the beginning of a song.
- Noise (often caused by much use or poor quality dubbing) which fills the blank.
- Long, very soft passages or pauses in a song.



The use of C-120 or thinner tape is not recommended, since characteristic deterioration may occur and this tape easily jams in the pinch-rollers and the capstans.

Recording

IMPORTANT:

- It may be unlawful to record or play back copyrighted material without the consent of the copyright owner.
- The recording level is automatically set correctly, so it is not affected by the VOLUME, the SUBWOOFER LEVEL, and the SOUND MODE controls, or the SOUND TURBO button. Thus, during recording you can adjust the sound you are actually listening to without affecting the recording level.
- If there are excessive noise or static in the recording you have made, the unit may be too close to a TV. Increase the distance between the TV and the unit.
- You can only use type I tape for recording.

To protect your recording

Cassettes have two small tabs on the back to protect from unexpected erasure or re-recording.

To protect your recording, remove these tabs.

To re-record on a protected tape, cover the holes with adhesive tape.

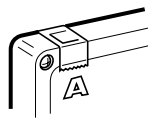

To keep the best recording and playback sound quality

If the heads, capstans, and pinch rollers of the cassette deck become dirty, the following will occur:

- Impaired sound quality
- Discontinuous sound
- Fading
- Incomplete erasure
- Difficulty in recording

To clean the heads, capstans, and pinch rollers

Use a cotton swab moistened with alcohol.

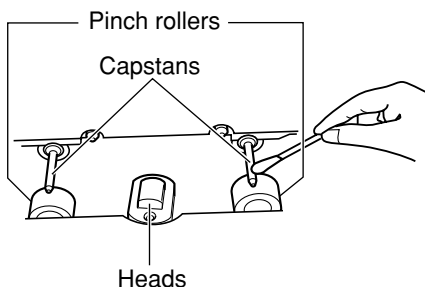

To demagnetize the heads

Turn off the unit, and use a head demagnetizer (available at electronics and audio shops).

Recording on a Tape

- 1 Press **▲ EJECT** and insert a recordable cassette with the exposed part of the tape down.

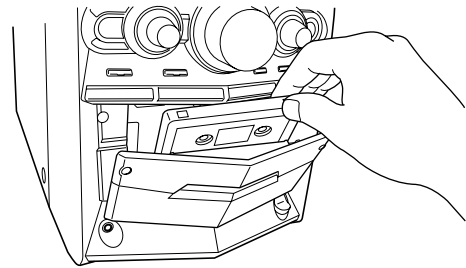

- 2 Close the cassette holder gently.

- If you want to record on both sides of a tape, see "To record on both sides—Reverse Mode."

- 3 Check the tape direction of the cassette deck.

- If the tape direction is not correct, press TAPE **◀▶** twice then **■** to change the tape direction.

- 4 Start playing the source—FM, AM, CD player, or auxiliary equipment connected to AUX jacks.

- When the source is the CD player, you can also use Synchronized Recording—(see page 22).

- 5 Start recording.

On the unit:

Press **REC START/STOP**.

On the remote control:

Press and hold **REC START/STOP** for more than 1 second.

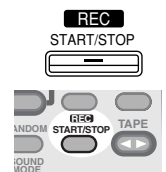

The REC (recording) lamp flashes when recording starts, and the tape direction indicator (▶ or ◀) starts flashing slowly.

- If no cassette is inserted, "NO TAPE" appears on the display. If a protected tape is inserted, "NO REC" appears on the display.

To stop recording immediately, press **REC START/STOP** or **■** (or press and hold **REC START/STOP** on the remote control for more than 1 second).

To remove the cassette, press **▲ EJECT** to open the cassette holder.

To record on both sides—Reverse Mode

On the unit ONLY:

Press **↔** REVERSE MODE so that the Reverse Mode indicator lights up on the display like—**↔**.



- When using the Reverse Mode for recording, start recording in the forward (▶) direction first. Otherwise, recording will stop when only one side (reverse) of the tape is recorded.

To cancel Reverse Mode, press the button again so that the Reverse Mode indicator lights up on the display like—**↔**.

Synchronized Recording

By using Synchronized Recording, you can start and stop both disc play and tape recording at the same time. Everything on the disc goes onto the tape in the order it is on the disc, or according to the order you have made for Program Play.

On the unit ONLY:

- 1 Press **▲ EJECT** and insert a recordable cassette with the exposed part of the tape down.

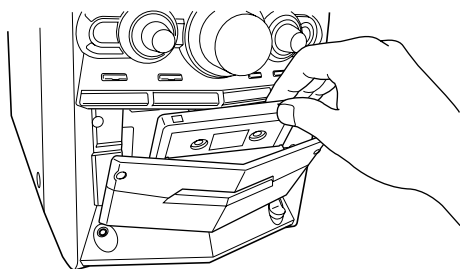

- 2 Load a disc.

- 3 Select a disc.

For audio CDs:

Press the corresponding disc number button (CD1 – CD5) where a disc is loaded in step 2, then press **■**.



For MP3 discs:

You can select a track to start recording with.

- 1) Press the corresponding disc number button (CD1 – CD5) where a disc is loaded in step 2, then press **■**.

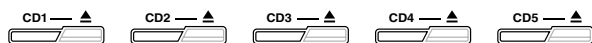

- 2) Turn **▶▶/|/|◀◀** to select the group, then press **CD ▶/||**.

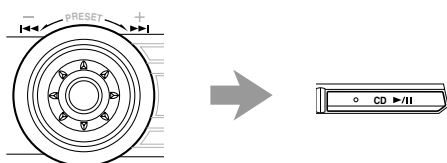

- 3) Turn **▶▶/|/|◀◀** to select the track.

- 4 Press **CD REC START**.

“CD REC” appears on the display and the REC (recording) lamp flashes when recording starts.

The cassette deck starts recording when the CD player starts playing.

When the recording is done, “CD REC FINISHED” scrolls on the display, and the REC (recording) lamp turns off. Both the cassette deck and the CD player stop automatically.



To stop recording, press **■** to create a 4-second blank portion on the recording tape. (Remember a 4-second blank is important when using Music Scan—see page 20.)



To record on both sides—Reverse Mode

On the unit ONLY:

Press **↔** REVERSE MODE so that the Reverse Mode indicator on the display lights up like **↔**.



- When using the Reverse Mode for Synchronized Recording, start recording in the forward (▶) direction first. When the tape reaches its end while recording a song in the forward direction (▶), the last song will be re-recorded at the beginning of the reverse side (◀).

If you start recording on the reverse side (◀) first, recording will stop when only one (reverse) side of the tape is recorded.

To cancel Reverse Mode, press the button again so that the Reverse Mode indicator lights up on the display like **↔**.



When making Sleep Timer settings while doing Synchronized Recording

Set enough time to allow for the disc to finish playing; otherwise, the power will go off before recording is completed.

Using the Timers

There are three timers available—DAILY (Daily Timer), REC (Recording Timer), and SLEEP (Sleep Timer).

- Before using the timers, set the clock built in the unit. (See page 9.)

Using Daily Timer

With Daily Timer, you can wake up to your favorite music or radio program.

- You can set the timers whether the unit is on or off.

How Daily Timer actually works

The unit automatically turns on, sets the volume level to the preset level, and starts playing the specified source when the on-time comes. (“DAILY” and the DAILY indicator on the display flash just before the on-time. The DAILY indicator continues flashing while the timer is operating.) Then, when the off-time comes (“DAILY OFF” appears on the display just before the off-time), the unit automatically turns off (standby).

The Daily Timer works everyday automatically. If you do not want to use the Daily Timer, turn it off. (See “To turn on or off Daily Timer after it has been set” on page 24.) The timer setting remains in memory until you change it.

- There is a time limit in doing the following steps. If the setting is canceled before you finish, start from step 1 again.
- To correct a misentry while setting the timer, press CANCEL/DEMO.

Before you start...

- *When using a disc as the source to play:*
 - Make sure there is a disc on the selected disc tray.
- *When using a tape as the source to play:*
 - Make sure that a tape is in the cassette deck.
 - Make sure that the tape direction is correct.
- *When using an external component as the source to play:*
 - Set the timer equipped on the external component to the same time.

On the unit ONLY:

- 1 Press  **CLOCK/TIMER** repeatedly until “DAILY” appears on the display.



The  (Timer) indicator lights up and the DAILY (Daily Timer) indicator also starts flashing on the display.



- Each time you press the button, the timer setting modes change as follows:

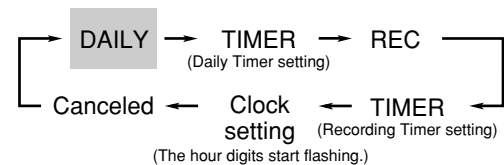





- 2 Press  **CLOCK/TIMER** again.

“TIMER” appears for about 2 seconds, then the unit enters on-time setting mode.





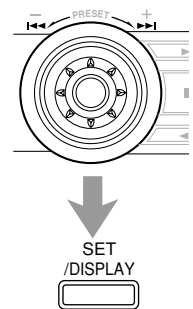

- 3 Set the on-time you want the unit to turn on at.

- 1) Turn /  to set the hour, then press SET/DISPLAY.
- 2) Turn /  to set the minute, then press SET/DISPLAY. “SET” appears for about 1 second, then the unit enters off-time setting mode.



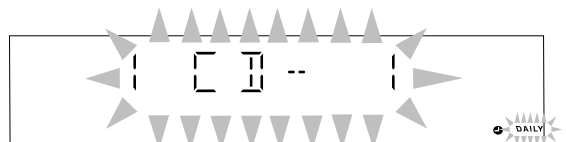

- 4 Set the off-time you want the unit to turn off (standby) at.

- 1) Turn /  to set the hour, then press SET/DISPLAY.
- 2) Turn /  to set the minute, then press SET/DISPLAY. “SET” appears for about 1 second, then the unit enters source selecting mode.





5 Turn |/| to select the source to play, then press SET/DISPLAY.

“SET” appears for about 1 second.
 • As you turn |/|, the source changes as follows:







- TUNER FM: tunes in to a specified preset FM station. → **Go to step 6.**
- TUNER AM: tunes in to a specified preset AM station. → **Go to step 6.**
- 1 CD-- 1: plays from a specified track of a specified disc. → **Go to step 6.**
- TAPE: plays a tape in the cassette deck. → **Go to step 7.**
- AUX IN: plays an external source. → **Go to step 7.**

6 When selecting “TUNER FM” or “TUNER AM”

Turn |/| to select the preset station number, then press SET/DISPLAY.
 The unit enters volume setting mode.

When selecting “1 CD-- 1”

- 1) Turn |/| to select the disc number, then press SET/DISPLAY.
 “SET” appears for about 1 second.
- 2) Turn |/| to set the track number, then press SET/DISPLAY.
 “SET” appears for about 1 second, then the unit enters volume setting mode.

7 Turn |/| to set the volume level.

• The volume level changes as follows:

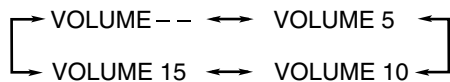
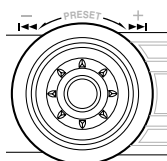

• If you select “VOLUME --,” the volume is set to the last level when the unit has been turned off.

8 Press SET/DISPLAY to complete the Daily Timer setting.



The DAILY (Daily Timer) indicator stops flashing and remains lit. “OK ✓” appears on the display for about 2 seconds.

The settings you have done are shown on the display in sequence for your confirmation.

9 Press  to turn off the unit (standby) if you have set the Daily Timer with the unit turned on.

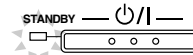

- **If the unit is turned on before the on-time comes** Daily Timer does not work.
- **Even if you unplug the AC power cord or if a power failure occurs** Once you set the timer, the timer setting may remain stored in memory in a few days. Check whether the timer setting still remains or not.

To turn on or off Daily Timer after it has been set

1 Press  CLOCK/TIMER repeatedly until “DAILY” appears on the display.



The DAILY (Daily Timer) indicator starts flashing on the display and the  (Timer) indicator remains lit.

2 To turn off the Daily Timer, press CANCEL/DEMO.



The DAILY (Daily Timer) and the  (Timer) indicators go off from the display (“DAILY OFF” appears for a while).
 The Daily Timer is canceled, but the setting for the Daily Timer remains in memory.

— Or —

To turn on the Daily Timer, press SET/DISPLAY.



“OK ✓” appears on the display for about 2 seconds.

The settings you have done are shown on the display in sequence for your confirmation.

Using Recording Timer

With Recording Timer, you can make a tape of a radio broadcast automatically.

- You can set the timers whether the unit is on or off.

How Recording Timer actually works

The unit automatically turns on, tunes in to the specified station, sets the volume level to "VOLUME MIN," and starts recording when the on-time comes. ("REC" and the REC indicator on the display flash just before the on-time. The REC indicator continues flashing while the timer is operating). Then, when the off-time comes ("REC OFF" appears on the display just before the off-time), the unit automatically turns off (standby).

The timer setting remains in memory until you change it.

- There is a time limit in doing the following steps. If the setting is canceled before you finish, start from step 2 again.
- To correct a mistake while setting the timer, press CANCEL/DEMO.

On the unit ONLY:

1 Insert a recordable cassette with the exposed part of the tape down.

2 Press CLOCK/TIMER repeatedly until "REC" appears on the display.

The  (Timer) indicator lights up and the REC (Recording Timer) indicator also starts flashing on the display.



- Each time you press the button, the timer setting modes change as follows:

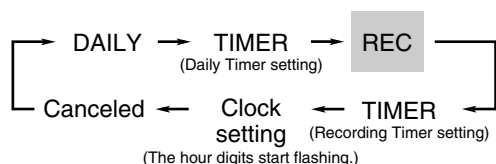



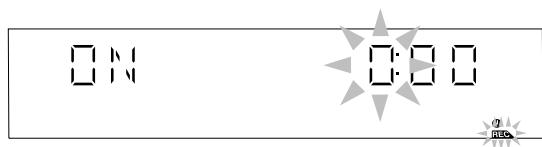

3 Press CLOCK/TIMER again.

"TIMER" appears for about 2 seconds, then the unit enters on-time setting mode.





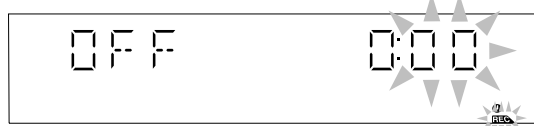
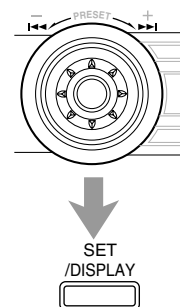

4 Set the on-time you want the unit to turn on at.





- Turn  /  to set the hour, then press SET/DISPLAY.
- Turn  /  to set the minute, then press SET/DISPLAY. "SET" appears for about 1 second, then the unit enters off-time setting mode.



5 Set the off-time you want the unit to turn off (standby) at.

- Turn  /  to set the hour, then press SET/DISPLAY.
- Turn  /  to set the minute, then press SET/DISPLAY. "SET" appears for about 1 second, then the unit enters preset station selecting mode.

6 Select the preset station.

- Turn  /  to select the band ("TUNER FM" or "TUNER AM"), then press SET/DISPLAY. "SET" appears for about 1 second.
- Turn  /  to select a preset channel number, then press SET/DISPLAY. The REC (Recording Timer) indicator stops flashing and remains lit. "OK ✓" appears on the display for about 2 seconds. The settings you have done are shown on the display in sequence for your confirmation.

7 Press / I to turn off the unit (standby) if necessary.

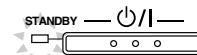

- If you want to listen to another source while recording**
Press REC START/STOP or  to stop recording. Without stopping it, you cannot change the source.
- Even if you unplug the AC power cord or if a power failure occurs**
Once you set the timer, the timer setting may remain stored in memory for a few days. Check whether or not the timer setting still remains.

To turn on or off Recording Timer after it has been set

1 Press CLOCK/TIMER repeatedly until "REC" appears on the display.

The REC (Recording Timer) indicator starts flashing on the display and the  (Timer) indicator remains lit.



2 To turn off the Recording Timer, press CANCEL/DEMO.

The REC (Recording Timer) indicator goes off from the display ("REC OFF" appears on the display for about 2 seconds).

The Recording Timer is canceled, but the setting for the Recording Timer remains in memory.



— Or —

To turn on the Recording Timer, press SET/DISPLAY.

"OK ✓" appears on the display for about 2 seconds.

The settings you have done are shown on the display in sequence for your confirmation.



Using Sleep Timer

With Sleep Timer, you can fall asleep to music. You can set Sleep Timer only while the unit is turned on.

How Sleep Timer actually works

The unit automatically turns off after the specified time length passes.

On the remote control ONLY:

1 Press SLEEP.

The time length until the shut-off time appears and the SLEEP indicator starts flashing on the display.

- Each time you press the button, the time length changes as follows:

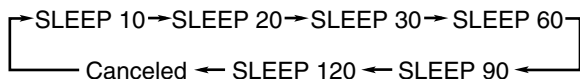

- If the built-in clock has not been set, "CLOCK ADJUST" appears on the display.

2 Wait for about 5 seconds after specifying the time length.

The SLEEP indicator flashes slowly until Sleep Timer activates.



To check the remaining time until the shut-off time, press SLEEP once so that the remaining time (minutes) until the shut-off time appears for about 5 seconds.

To change the shut-off time, press SLEEP repeatedly until the desired time length appears on the display.

To cancel the setting, press SLEEP repeatedly so that the SLEEP indicator goes off.

- Sleep Timer is also canceled when you turn off the unit.

Timer Priority

Since each timer can be set separately, you may wonder what happens if the settings for these timers overlap.

Recording Timer has priority over Daily Timer and Sleep Timer. Below are some examples.

- If Daily Timer is set to come on while Recording Timer is operating, Daily Timer will not come on at all.

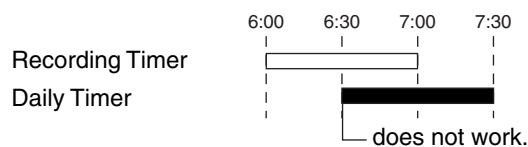

- If Sleep Timer is set to come on while Recording Timer is operating, Sleep Timer will not come on at all.

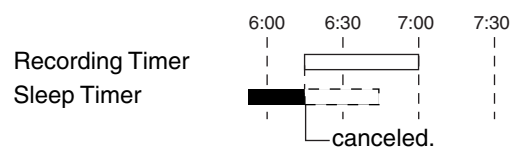

- If Recording Timer and Daily Timer are set to come on at the same time, Recording Timer will activate.

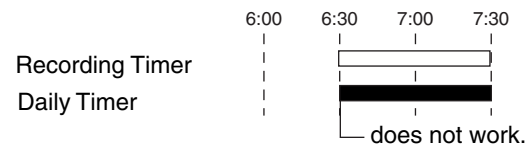

Maintenance

To get the best performance from the unit, keep your discs, tapes, and mechanism clean.

General Notes

In general, you will have the best performance by keeping your discs and the mechanism clean.

- Store discs in their cases, and keep them in cabinets or on shelves.
- Keep the unit's disc trays closed when not in use.

Handling discs



- Remove the disc from its case by holding it at the edge while pressing the center hole lightly.
- Do not touch the shiny surface of the disc, or bend the disc.
- Put the disc back in its case after use to prevent warping.

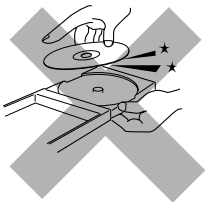

- Be careful not to scratch the surface of the disc when placing it back in its case.
- Avoid exposure to direct sunlight, temperature extremes, and moisture.



To clean the disc

Wipe the disc with a soft cloth in a straight line from center to edge.

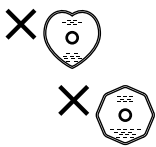

Continued use of irregular shape discs (heart-shape, octagonal, etc.) can damage the unit.



DO NOT use any solvent—such as conventional record cleaner, spray, thinner, or benzene—to clean the disc.

Handling cassette tapes

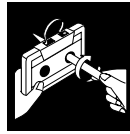

- If the tape is loose in its cassette, take up the slack by inserting a pencil in one of the reels and rotating.
- If the tape is loose, it may get stretched, cut, or caught in the cassette.

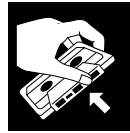

- Be careful not to touch the tape surface.



- Avoid the following places to store the tape:
 - In dusty places
 - In direct sunlight or heat
 - In moist areas
 - Near a magnet

Cleaning the unit

Stains on the unit

Should be wiped off with a soft cloth. If the unit is heavily stained, wipe it with a cloth soaked in water diluted neutral detergent and wrung well, then wipe clean with a dry cloth.

Since the unit may deteriorate in quality, become damaged or get its paint peeled off, be careful about the following:

- DO NOT wipe it with a hard cloth.
- DO NOT wipe it strong.
- DO NOT wipe it with thinner or benzene.
- DO NOT apply any volatile substance such as insecticides to it.
- DO NOT allow any rubber or plastic to remain in contact with it for a long time.

Troubleshooting

If you are having a problem with your unit, check this list for a possible solution before calling for service. If you cannot solve the problem from the hints given here, or the unit has been physically damaged, call a qualified person, such as your dealer, for service.

	Symptom	Cause	Action
GENERAL	Unable to cancel the demonstration.	A button other than CANCEL/DEMO has been pressed to cancel the demonstration temporarily.	Press CANCEL/DEMO on the unit. (See page 8.)
	No sound is heard.	Connections are incorrect or loose.	Check all connections and make corrections. (See pages 6 to 8.)
	Operations are disabled.	The built-in microprocessor may malfunction due to external electrical interference.	Unplug the AC power cord and then plug it back in.
	Unable to operate the unit from the remote control.	<ul style="list-style-type: none"> The path between the remote control and the remote sensor on the unit is blocked. The batteries are used up. 	<ul style="list-style-type: none"> Remove the obstruction. Replace the batteries.
TUNER	Hard to listen to broadcasts because of noise.	<ul style="list-style-type: none"> Antennas are disconnected. 	<ul style="list-style-type: none"> Reconnect the antennas correctly and securely.
		<ul style="list-style-type: none"> The AM loop antenna is too close to the unit. The FM antenna is not properly extended and positioned. 	<ul style="list-style-type: none"> Change the position and direction of the AM loop antenna. Extend the FM antenna to the best position.
AUDIO CD	The disc sound is discontinuous.	The disc is scratched or dirty.	Clean or replace the disc. (See page 27.)
	The disc trays will not open or close.	<ul style="list-style-type: none"> The AC power cord is not plugged in. Trays are locked. 	<ul style="list-style-type: none"> Plug in the AC power cord. Unlock the trays. (See page 19.)
MP3 DISCS	The disc does not play.	The disc is placed upside down.	Place the disc with the label side up.
	The disc does not play.	<ul style="list-style-type: none"> No MP3 files are recorded on the disc. MP3 files do not have the file extension—.MP3, .Mp3, .mP3, or .mp3, in their file names. MP3 files are not recorded in a format compliant with ISO 9660 Level 1 or Level 2. 	Replace the disc.
TAPE	The disc readout time is too long.	The readout time varies with the complexity of the recording configuration.	Do not use too many hierarchies and folders when recording. Also, do not record any other types of audio tracks together with MP3 files.
		Power supply from the AC power cord has been cut off while the tape was running.	Turn on the unit.
REC	Impossible to record.	Small tabs on the back of the cassette are removed.	Cover the holes with adhesive tape. (See page 21.)

Specifications

CA-HXZ30

Amplifier section

Output Power (IEC 268-3)

SUBWOOFERS: 135 W per channel, min. RMS, driven into 6 Ω at 63 Hz with no more than 10% total harmonic distortion.

MAIN SPEAKERS: 55 W per channel, min. RMS, driven into 6 Ω at 1 kHz with no more than 10% total harmonic distortion.

Audio input sensitivity/impedance

(Measured at 1 kHz, with tape recording signal 300 mV)

AUX: 300 mV/47 k Ω

Speakers/impedance:

SUBWOOFERS: 6 Ω – 16 Ω

MAIN SPEAKERS: 6 Ω – 16 Ω

Tuner

FM tuning range: 87.50 MHz – 108.00 MHz

AM tuning range: At 9 kHz intervals: 531 kHz – 1 710 kHz
At 10 kHz intervals: 530 kHz – 1 710 kHz

CD player

Disc capacity: 5 discs

Dynamic range: 87 dB

Signal-to-noise ratio: 90 dB

Wow and flutter: Immeasurable

MP3 recording format: MPEG 1/2 Audio Layer 3

Max. Bit rate: 320 kbps

Cassette deck

Frequency response

Normal (type I): 50 Hz – 14 000 Hz

Wow and flutter: 0.15% (WRMS)

General

Power requirement: AC 110 V/AC 127 V/AC 220 V/
AC 230 V – AC 240 V \wedge (adjustable with the
voltage selector), 50 Hz / 60 Hz

Power consumption: 210 W (in operation)
28 W (on standby)

Dimensions (approx.): 205 mm x 370 mm x 380.5 mm (W/H/D)

Mass (approx.): 10.5 kg

Supplied accessories

See page 6.

Design and specifications are subject to change without notice.

CA-HXZ10

Amplifier section

Output Power (IEC 268-3)

SUBWOOFERS: 125 W per channel, min. RMS, driven into 6 Ω at 63 Hz with no more than 10% total harmonic distortion.

MAIN SPEAKERS: 35 W per channel, min. RMS, driven into 6 Ω at 1 kHz with no more than 10% total harmonic distortion.

Audio input sensitivity/impedance

(Measured at 1 kHz, with tape recording signal 300 mV)

AUX: 300 mV/47 k Ω

Speakers/impedance:

SUBWOOFERS: 6 Ω – 16 Ω

MAIN SPEAKERS: 6 Ω – 16 Ω

Tuner

FM tuning range: 87.50 MHz – 108.00 MHz

AM tuning range: At 9 kHz intervals: 531 kHz – 1 710 kHz

At 10 kHz intervals: 530 kHz – 1 710 kHz

CD player

Disc capacity: 5 discs

Dynamic range: 87 dB

Signal-to-noise ratio: 90 dB

Wow and flutter: Immeasurable

MP3 recording format: MPEG 1/2 Audio Layer 3

Max. Bit rate: 320 kbps

Cassette deck

Frequency response

Normal (type I): 50 Hz – 14 000 Hz

Wow and flutter: 0.15% (WRMS)

General

Power requirement: AC 110 V/AC 127 V/AC 220 V/
AC 230 V – AC 240 V \sim (adjustable with the
voltage selector), 50 Hz / 60 Hz

Power consumption: 165 W (in operation)
27 W (on standby)

Dimensions (approx.): 205 mm x 370 mm x 380.5 mm (W/H/D)

Mass (approx.): 10.5 kg

Supplied accessories

See page 6.

Design and specifications are subject to change without notice.

Mains (AC) Line Instruction (not applicable for Europe, U.S.A., Canada, Australia, and U.K.)

Instrucción sobre la línea de la red (CA) (no aplicable para Europa, EE.UU., Canadá, Australia, ni el Grã-Bretanha)

Instrução sobre a tensão da rede eléctrica (CA) (não aplicável para a Europa, os E.U.A., o Canadá, a Austrália e o Reino Unido)

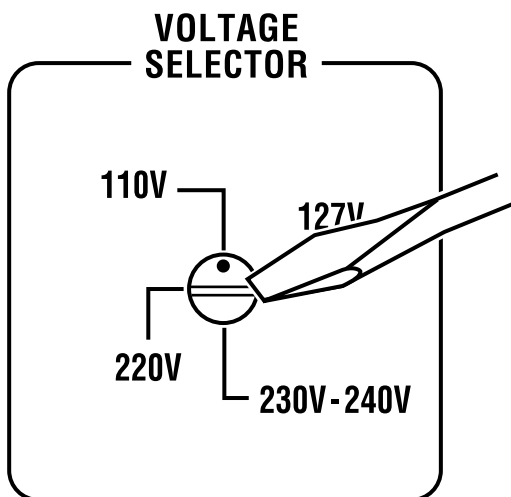

IMPORTANT for mains (AC) line

BEFORE PLUGGING IN, do check that your mains (AC) line voltage corresponds with the position of the voltage selector switch provided on the outside of this equipment and, if different, reset the voltage selector switch, to prevent from damage or risk of fire/electric shock.

IMPORTANTE para la línea de la red (CA)

ANTES DE ENCHUFAR EL EQUIPO, compruebe si la tensión de la línea de la red (CA) corresponde con la posición del selector de tensión situado en la parte exterior del equipo, y si es diferente, reajuste el selector de tensión para evitar el riesgo de incendios/descargas eléctricas.

IMPORTANTE para a ligação à tensão da rede (CA)

ANTES DE LIGAR O APARELHO A UMA TOMADA DA REDE, verifique se a tensão da rede CA corresponde à posição do seletor de voltagem localizado na parte externa deste equipamento. Caso não corresponda, reajuste o seletor de voltagem a fim de evitar avarias ou riscos de incêndio e choque elétrico.

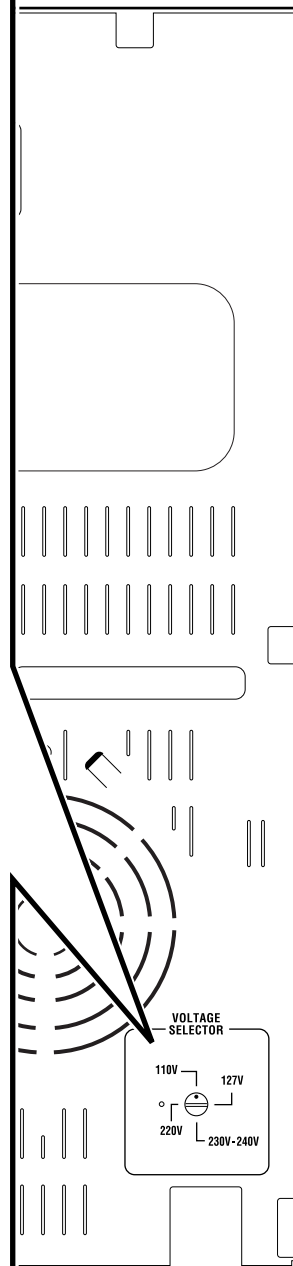

JVC

VICTOR COMPANY OF JAPAN, LIMITED

JVC INSTRUCTIONS



SPEAKER SYSTEM SP-HXZ10

MANUAL DE INSTRUCCIONES: SISTEMA DE ALTAVOCES

INSTRUÇÕES: SISTEMA DE ALTIFALANTES

說明書：揚聲器系統

دليل التعليمات: لنظام السماعات

Thank you for purchasing JVC speakers.

Before you begin using them, please read the instructions carefully to be sure you get the best possible performance. If you have any questions, consult your JVC dealer.

Le estamos muy agradecidos por haber adquirido estos altavoces de JVC. Antes de utilizarlos, sírvase leer las instrucciones detenidamente a fin de obtener el mejor rendimiento posible. Si tienenaluna pregunta, acuda a su agente de JVC.

Gratos pela aquisição dos altifalantes JVC.

Antes de desfrutar este sistema, leia atentamente as instruções que o acompanham, de modo a assegurar-se da obtenção do melhor desempenho possível. Caso surjam dúvidas concernentes a este sistema, consulte o seu agente JVC.

感謝您惠購 JVC 揚聲器。

在開始使用之前，請您仔細閱讀本使用說明書，以確保您獲得揚聲器的最佳性能。如有疑問，請與 JVC 代理銷售商聯系。

نشكرك على شراء سماعات جي في سي JVC.

قبل أن تبدأ استعمالها، يرجى قراءة هذه التعليمات بعناية حتى تتأكد من حصولك على أفضل أداء ممكن. إذا كان عندك أية أسئلة، عندها راجع موزع JVC لديك.

— SAFETY INSTRUCTIONS —

“SOME DOS AND DON'TS ON THE SAFE USE OF EQUIPMENT”

This equipment has been designed and manufactured to meet international safety standards but, like any electrical equipment, care must be taken if you are to obtain the best results and safety is to be assured.

Do read the operating instructions before you attempt to use the equipment.

Do ensure that all electrical connections (including the mains plug, extension leads and interconnections between pieces of equipment) are properly made and in accordance with the manufacturer's instructions. Switch off and withdraw the mains plug when making or changing connections.

Do consult your dealer if you are ever in doubt about the installation, operation or safety of your equipment.

Do be careful with glass panels or doors on equipment.

DON'T continue to operate the equipment if you are in any doubt about it working normally, or if it is damaged in any way — switch off, withdraw the mains plug and consult your dealer.

DON'T remove any fixed cover as this may expose dangerous voltages.

DON'T leave equipment switched on when it is unattended unless it is specifically stated that it is designed for unattended operation or has a standby mode.

Switch off using the switch on the equipment and make sure that your family know how to do this.

Special arrangements may need to be made for infirm or handicapped people.

DON'T use equipment such as personal stereos or radios so that you are distracted from the requirements of traffic safety. It is illegal to watch television whilst driving.

DON'T listen to headphones at high volume as such use can permanently damage your hearing.

DON'T obstruct the ventilation of the equipment, for example with curtains or soft furnishing.

Overheating will cause damage and shorten the life of the equipment.

DON'T use makeshift stands and NEVER fix legs with wood screws — to ensure complete safety always fit the manufacturer's approved stand or legs with the fixings provided according to the instructions.

DON'T allow electrical equipment to be exposed to rain or moisture.

ABOVE ALL

- NEVER let anyone, especially children, push anything into holes, slots or any other opening in the case.
- this could result in a fatal electrical shock;
- NEVER guess or take chances with electrical equipment of any kind
- it is better to be safe than sorry!

Connection

Conexión

Ligaçao

接線

التوصيل

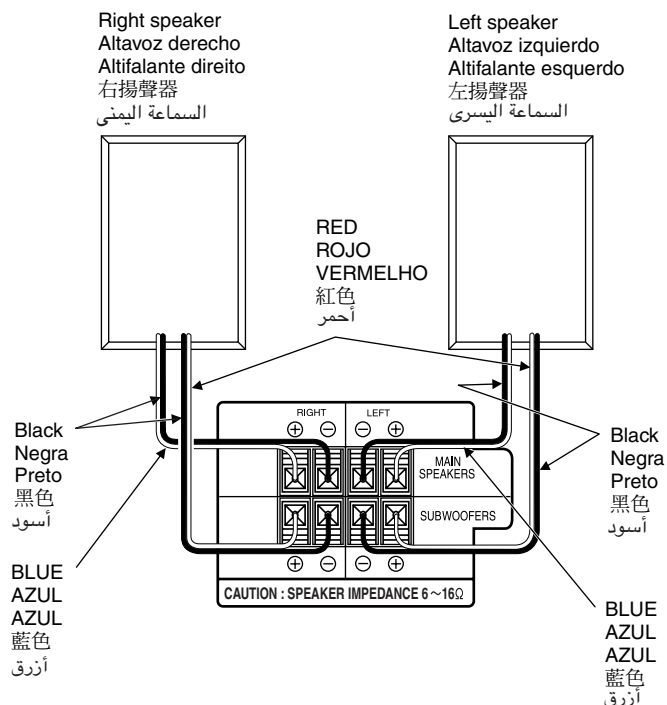

Amplifier output terminals
Terminales de salida de amplificador
Terminais de saída do amplificador
放大器輸出端子
نهايات خرج المضخم

CONNECTION

- DON'T use other amplifier to operate this speaker system except for CA-HXZ10.
- Turn off power to the whole system before connecting the speakers to the amplifier.
- The maximum power handling capacity of the SP-HXZ10 main speaker is 75 W/Subwoofer is 165 W. Excessive input will result in abnormal noise and possible damage.

In cases where the signals described below are applied to the speakers, even if the signals are below the maximum allowable input, they may cause an overload and burn the wiring of the speakers. Be sure to lower the amplifier volume beforehand.

- 1) Noise during FM tuning.
- 2) High level signals containing high frequency components produced by a tape deck in the fast forward mode.
- 3) Click noise produced when turning power of other components on and off.
- 4) Click noise produced when connecting or disconnecting cords with the power on.
- 5) Click noise produced when the cartridge is replaced with the power on.
- 6) Click noise produced when operating amplifier switches.
- 7) Continuous high frequency oscillation or high pitch electronically produced musical instrument sound.
- 8) Howling when using a microphones.

CAUTION

Do not drag or push the speakers on the floor or table. Otherwise, the four feet at the bottom side of each speaker may peel off or drop from the speaker.

SPECIFICATIONS

Type	: 3-way 4-speaker Bass-Reflex Type Twin Hyper Power-Drive Subwoofer and Front Twin Woofer
Speakers	
Subwoofer	: 16.0 cm (6-5/16 in.) cone × 1
Main woofer	: 10.0 cm (3-15/16 in.) cone × 2
Tweeter	: 5.0 cm (2 in.) cone × 1
Power Handling Capacity	
Subwoofer	: 165 W
Main Speaker	: 75 W
Impedance	
Subwoofer	: 6 Ω
Main Speaker	: 6 Ω
Frequency Range	
Subwoofer	: 30 Hz ~ 325 Hz
Main Speaker	: 70 Hz ~ 32 000 Hz
Sound Pressure Level	
Subwoofer	: 78 dB/W·m
Main Speaker	: 86 dB/W·m
Dimensions (W × H × D)	: 220 mm × 432 mm × 357 mm (8-11/16 in. × 17-1/16 in. × 14-1/16 in.)
Mass	: 8.2 kg (18.1 lbs) each

Design and specifications subject to change without notice.

CONEXIÓN

- NO utilice ningún otro amplificador para operar este sistema de altavoces excepto CA-HXZ10.
- Desactive la alimentación de todo el sistema antes de conectar los altavoces al amplificador.
- La capacidad máxima de potencia del altavoz principal del SP-HXZ10 es de 75 W y la del altavoz de subgraves es de 165 W. En casos donde las señales descritas más abajo se apliquen a los altavoces, aunque las mismas resulten menores que la entrada máxima permisible, pueden causar una sobrecarga y quemar el cableado de los altavoces. Asegúrese de disminuir el volumen del amplificador con anterioridad.
 - 1) Ruido durante la sintonía en FM.
 - 2) Señales de alto nivel que contengan componentes de alta frecuencia producidos por un magnetófono en el modo de avance rápido.
 - 3) Ruidos de conmutación provocados al encender y apagar otros componentes.
 - 4) Ruido de conmutación al conectar o desconectar cables con los componentes encendidos.
 - 5) Ruido de conmutación cuando se reemplaza la cápsula con los componentes encendidos.
 - 6) Ruido de conmutación provocados por la operación de los selectores del amplificador.
 - 7) Continua oscilación de alta frecuencia o de sonidos de tonos altos provocados por instrumentos electrónicos.
 - 8) Aullidos al utilizar micrófonos.

PRECAUCIÓN

No arrastre ni empuje los altavoces sobre el piso o la mesa. De lo contrario, las cuatro patas del lado inferior de cada altavoz se podrían desprender o salir del altavoz.

ESPECIFICACIONES

Tipo	: Reflex bajo con 4-altavoces y 3 vías Twin Hyper Power-Drive Subwoofer and Front Twin Woofer
Altavoces	
De subgraves	: Tipo cónico de 16,0 cm × 1
Principal	: Tipo cónico de 10,0 cm × 2
De agudos	: Tipo cónico de 5,0 cm × 1
Capacidad de potencia	
De subgraves	: 165 W
Principal	: 75 W
Impedancia	
De subgraves	: 6 Ω
Principal	: 6 Ω
Gama de frecuencias	
De subgraves	: 30 Hz – 325 Hz
Principal	: 70 Hz – 32 000 Hz
Nivel de presión acústica	
De subgraves	: 78 dB/W·m
Principal	: 86 dB/W·m
Dimensiones (An × Al × Prf)	: 220 mm × 432 mm × 357 mm
Peso	: 8,2 kg cada uno

El diseño y las especificaciones están sujetos a cambio sin previo aviso.

LIGAÇÃO

- NÃO use outro amplificador para operar este sistema de altifalantes à exceção do CA-HXZ10.
- Desligue a alimentação de todo o sistema antes de iniciar as ligações dos altifalantes ao amplificador.
- A potência efectiva máxima do altifalante principal do SP-HXZ10 é de 75 W; a do subwoofer é de 165 W. Uma entrada excessiva resultará em ruídos anormais e possíveis avarias. Nos casos em que os sinais descritos abaixo apresentem-se nos altifalantes, mesmo que os sinais estejam abaixo do nível de entrada permíssivel, poderão causar uma sobrecarga e o curto-circuito dos fios dos altifalantes. Certifique-se de reduzir o volume do amplificador de antemão.
 - 1) Interferências durante a sintonia de FM.
 - 2) Sinais com níveis elevados e com componentes de alta frequência produzidos pelo deck de cassetes durante o modo do avanço rápido.
 - 3) Estalidos produzidos quando do ligar/desligar da alimentação de outros componentes.
 - 4) Estalidos produzidos ao se ligar/desligar cabos de ligação com a alimentação ligada.
 - 5) Estalidos produzidos quando da troca da célula fonocaptadora com a alimentação ligada.
 - 6) Estalidos produzidos quando do activar/desactivar dos interruptores do amplificador.
 - 7) Oscilação contínua das altas frequências ou altas tonalidades electronicamente produzidas por sons de músicas instrumentais.
 - 8) Efeito de realimentação acústica (microfonia) quando da utilização de microfone.

PRECAUÇÃO

Não arraste nem empurre as caixas acústicas no chão ou na mesa, do contrário os quatro pés da parte inferior de cada uma delas podem se desprender ou cair.

ESPECIFICAÇÕES

Tipo	: Reflector de graves de 3 vías e 4 altifalantes Twin Hyper Power-Drive Subwoofer and Front Twin Woofer
Altifalantes	
Subwoofer	: Cónico de 16,0 cm × 1
Woofer principal	: Cónico de 10,0 cm × 2
Tweeter	: Cónico de 5,0 cm × 1
Potência efectiva	
Subwoofer	: 165 W
Altifalante principal	: 75 W
Impedância	
Subwoofer	: 6 Ω
Altifalante principal	: 6 Ω
Amplitude de frequência	
Subwoofer	: 30 Hz – 325 Hz
Altifalante principal	: 70 Hz – 32 000 Hz
Nível da pressão sonora	
Subwoofer	: 78 dB/W·m
Altifalante principal	: 86 dB/W·m
Dimensões (larg. × alt. × prof.)	: 220 mm × 432 mm × 357 mm
Peso	: 8,2 kg cada

Desenho e especificações sob reserva de alterações sem aviso prévio.

التوصيل

- لا تستعمل مضخم صوت آخر لتشغيل نظام السماعات هذا باستثناء للموديل CA-HXZ10.
- افضل الطاقة لكل النظام قبل توصيل السماعات بالمضخم.
- أقصى سعة للقدرة لتشغيل السماعة الرئيسية لنظام السماعات SP-HXZ10 هي ٧٥ واط وللمجهر الفرعي للترددات المنخفضة هي ١٦٥ واط. الدخل الزائد سيؤدي الى تشويش شاذ وامكانية حدوث تلف.
- في الحالات التي تنطبق فيها الاشارات الموصوفة أدناه على السماعات، حتى لو كانت الاشارات دون أقصى دخل مسموح به، فانها قد تسبب حملاً زائداً وحرق اسلاك السماعات. لهذا تأكد من تخفيض جهازة صوت المضخم مقدماً.
- ١) تشويش أثناء موالفة البث FM.
- ٢) اشارات ذات مستوى مرتفع تحوي مركبات تردد عال ناتجة عن جهاز كاسيت في وضع التقديم السريع.
- ٣) صوت طقطقة ينتج عند تشغيل وإيقاف الطاقة على الاجهزة الاخرى.
- ٤) صوت طقطقة ينتج عند وصل أو فصل الاسلاك بينما تكون الطاقة موصلة.
- ٥) صوت طقطقة ينتج عند استقبال الكارتريديج بينما تكون الطاقة موصلة.
- ٦) صوت طقطقة ينتج عند تشغيل مفاتيح المضخم.
- ٧) ذبذبة مستمرة ذات تردد مرتفع أو نغمة عالية ناتجة إلكترونياً عن صوت آلة موسيقية.
- ٨) زعيق عند استخدام ميكروفون.

تنبيه

لا تعتمد الى جر أو دفع السماعات على الأرضية أو على طاولة. إذا فعلت ذلك فقد تنقلت الأقدام الأربعة الموجودة على الجهة الجانبية لقاغ كل سماعة أو تسقط من موضعها على السماعة.

接线

- 請勿使用其他放大器操作 CA-HXZ10 以外的揚聲器系統。
- 要將揚聲器連接到放大器時，須關掉全裝置系統的電源。
- SP-HXZ10 主揚聲器的最大功率儲備容量為 75 W (瓦)，副低音喇叭的為 165 W (瓦)。過大的輸入，將造成異常噪聲，甚至損壞揚聲器。當下列信號輸入揚聲器時，即使該信號低於最大容許輸入，仍有可能造成過載而燒毀揚聲器導線，故請預先調低放大器的音量控製，以籍安全。
- 1) 在 FM 調諧中產生的噪聲。
- 2) 磁帶錄音機的快進模式中產生的含有高頻成分的高電平信號。
- 3) 開關其它組成部分電源時產生的卡嗒噪聲。
- 4) 接通著電源進行接線或斷線時產生的卡嗒噪聲。
- 5) 接通著電源更換卡盤時產生的卡嗒噪聲。
- 6) 操作放大器開關時產生的卡嗒噪聲。
- 7) 連續的高頻率振蕩或高音調電子裝置產生的樂器聲。
- 8) 使用麥克風時發生的嘯聲。

小心

切勿拖拉放在地板或桌面上的揚聲器。
否則，各揚聲器底部的四個支腳可能會剝離或脫落。

規格

類型	: 3 通道 4 揚聲器低音反射型 Twin Hyper Power-Drive Subwoofer and Front Twin Woofer
揚聲器	
副低音喇叭	: 錐型 16.0 cm × 1
主喇叭	: 錐型 10.0 cm × 2
高音喇叭	: 錐型 5.0 cm × 1
最大功率	
副低音喇叭	: 165 W (瓦)
主揚聲器	: 75 W (瓦)
阻抗	
副低音喇叭	: 6 Ω (歐姆)
主揚聲器	: 6 Ω (歐姆)
頻率範圍	
副低音喇叭	: 30 Hz - 325 Hz
主揚聲器	: 70 Hz - 32 000 Hz
聲壓級	
副低音喇叭	: 78 dB/W · m
主揚聲器	: 86 dB/W · m
尺寸 (W×H×D)	: 220 mm × 432 mm × 357 mm
質量	: 每個 8.2 kg

設計與規格如有變更，恕不另行通知。

المواصفات

النوع	: ٤ سماعات بـ ٣ مسارات عاكسة لجهير Twin Hyper Power-Drive Subwoofer and Front Twin Woofer
السماعات	
المجهر الفرعي للترددات المنخفضة	: نوع مخروطي ١٦,٠ سم × ١
المجهر الرئيسي للترددات المنخفضة	: نوع مخروطي ١٠,٠ سم × ٢
مجهر الترددات العالية	: نوع مخروطي ٥,٠ سم × ١
سعة تشغيل القدرة	
المجهر الفرعي للترددات المنخفضة	: ١٦٥ واط
السماعة الرئيسية	: ٧٥ واط
المقاومة	
المجهر الفرعي	: ٦ أوم
السماعة الرئيسية	: ٦ أوم
مجال الترددات	
المجهر الفرعي	: ٣٠ - ٣٢٥ هرتز
السماعة الرئيسية	: ٧٠ - ٣٢٠٠٠ هرتز
مستوى ضغط الصوت	
المجهر الفرعي	: ٧٨ ديسيبل/واط-متر
السماعة الرئيسية	: ٨٦ ديسيبل/واط-متر
الابعاد	: ٢٢٠ مم × ٤٣٢ مم × ٣٥٧ مم
الوزن	: ٨,٢ كجم لكل وحدة

التصميم والمواصفات عرضة للتغيير دون إشعار.

JVC

VICTOR COMPANY OF JAPAN, LIMITED

— 4 —

Free Manuals Download Website

<http://myh66.com>

<http://usermanuals.us>

<http://www.somanuals.com>

<http://www.4manuals.cc>

<http://www.manual-lib.com>

<http://www.404manual.com>

<http://www.luxmanual.com>

<http://aubethermostatmanual.com>

Golf course search by state

<http://golfingnear.com>

Email search by domain

<http://emailbydomain.com>

Auto manuals search

<http://auto.somanuals.com>

TV manuals search

<http://tv.somanuals.com>