

JVC



English

COMPACT COMPONENT SYSTEM SISTEMAS DE COMPONENTES COMPACTOS SISTEMA DE COMPONENTE COMPACTO

Español

CA-HXZ9

Português

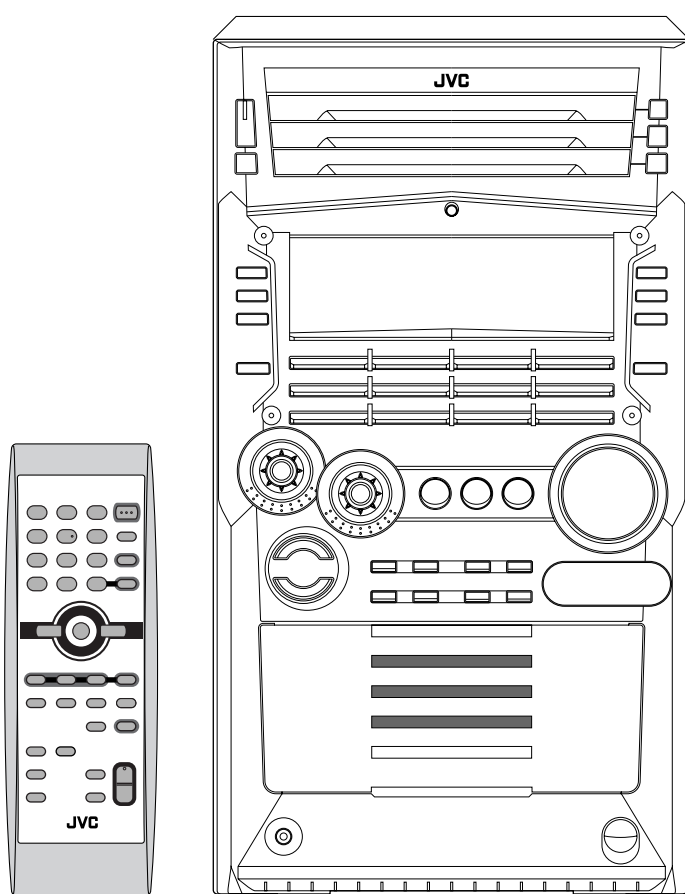

COMPACT
disc
DIGITAL AUDIO

INSTRUCTIONS MANUAL DE INSTRUCCIONES INSTRUÇÕES

For Customer Use:

Enter below the Model No. and Serial No. which are located either on the rear, bottom or side of the cabinet. Retain this information for future reference.

Model No. _____

Serial No. _____

GVT0099-012A
[UW]

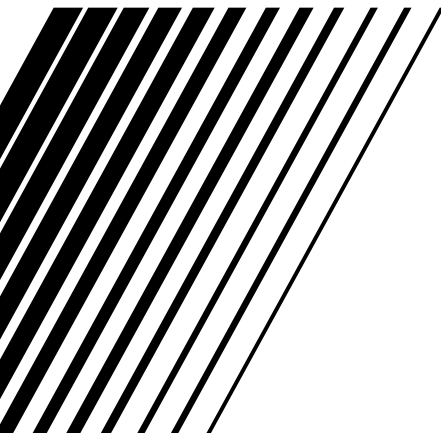

Warnings, Cautions and Others **Avisos, precauciones y otras notas** **Advertências, precauções e outras notas**

Caution— ϕ /I (standby/on) button!

Disconnect the mains plug to shut the power off completely. The ϕ /I (standby/on) button in any position does not disconnect the mains line. The power can be remote controlled.

Precaución—Interruptor ϕ /I (encendido/apagado)!

Desconectar el cable de alimentación para desactivar la alimentación totalmente. Cualquiera que sea la posición de ajuste del interruptor ϕ /I (encendido/apagado), la alimentación no es cortada completamente. La alimentación puede ser controlada remotamente.

Precaução—Interruptor ϕ /I (esperar/ligar)!

Desconectar o cabo de alimentação para desligar a alimentação por completo. Qualquer que seja a posição de ajuste do interruptor ϕ /I (esperar/ligar), a alimentação não é completamente cortada. A alimentação pode ser controlada remotamente.

CAUTION

To reduce the risk of electrical shocks, fire, etc.:

1. Do not remove screws, covers or cabinet.
2. Do not expose this appliance to rain or moisture.

CAUTION

- Do not block the ventilation openings or holes. (If the ventilation openings or holes are blocked by a newspaper or cloth, etc., the heat may not be able to get out.)
- Do not place any naked flame sources, such as lighted candles, on the apparatus.
- When discarding batteries, environmental problems must be considered and local rules or laws governing the disposal of these batteries must be followed strictly.
- Do not expose this apparatus to rain, moisture, dripping or splashing and that no objects filled with liquids, such as vases, shall be placed on the apparatus.

PRECAUCIÓN

Para reducir riesgos de choques eléctricos, incendio, etc.:

1. No extraiga los tornillos, los cubiertas ni la caja.
2. No exponga este aparato a la lluvia o a la humedad.

PRECAUCIÓN

- No obstruya las rendijas o los orificios de ventilación. (Si las rendijas o los orificios de ventilación quedan tapados con un periódico, un trozo de tela, etc., no se podrá disipar el calor).
- No ponga sobre el aparato ninguna llama al descubierto, como velas encendidas.
- Cuando tenga que descartar las pilas, tenga en cuenta los problemas ambientales y observe estrictamente los reglamentos o las leyes locales sobre disposición de las pilas.
- No exponga este aparato a la lluvia, humedad, goteos o salpicaduras. Tampoco ponga recipientes conteniendo líquidos, como floreros, encima del aparato.

PRECAUÇÃO

Para reduzir riscos de choques elétricos, incêndio, etc.:

1. Não remova parafusos e tampas ou desmonte a caixa.
2. Não exponha este aparelho à chuva nem à umidade.

AVISO

- Não obstrua as aberturas e orifícios de ventilação. (Se os orifícios ou aberturas de ventilação estiverem obstruídos por qualquer papel ou tecido, não haverá circulação do ar quente.)
- Não coloque nenhum objeto com chamas, como velas acesas, sobre o aparelho.
- Ao descartar as baterias, leve em consideração os problemas que possam ser causados ao meio ambiente e os regulamentos e leis locais e governamentais sobre recolhimento dessas baterias devem ser rigorosamente seguidos.
- Não exponha este aparelho à chuva, umidade, pingos ou esguichos de água, nem coloque em cima do mesmo qualquer tipo de recipiente que contenha líquidos, como por exemplo vasos.

Caution: Proper Ventilation

To avoid risk of electric shock and fire, and to prevent damage, locate the apparatus as follows:

- 1 Front: No obstructions and open spacing.
- 2 Sides/ Top/ Back: No obstructions should be placed in the areas shown by the dimensions below.
- 3 Bottom: Place on the level surface. Maintain an adequate air path for ventilation by placing on a stand with a height of 10 cm or more.

Precaución: El aparato debe estar bien ventilado

Para evitar posibles riesgos de descargas eléctricas e incendios y prevenir cualquier posible daño, coloque el aparato del modo siguiente:

- 1 Parte delantera: No ponga nada delante, deje el espacio libre.
- 2 Laterales/ parte superior/ parte trasera: No se debería colocar nada en las áreas y las distancias que se detallan a continuación.
- 3 Parte inferior: Coloque el aparato sobre una superficie recta. Debe haber buena circulación de aire; para ello, coloque el aparato sobre una base a una altura mínima de 10 cm.

Precaução: Ventilação adequada

Para evitar riscos de choques elétricos e incêndios, e prevenir avarias, instale o aparelho como segue:

- 1 Parte frontal: Sem obstruções e espaços abertos.
- 2 Partes laterais/ Tampa/ Posterior: Nenhuma obstrução deverá ser colocada entre as áreas cujas dimensões são indicadas abaixo.
- 3 Parte inferior: Instale-o sobre uma superfície plana. Deverá ser mantido espaço suficiente para a ventilação se este for instalado numa posição que tenha uma altura de 10 cm ou mais.

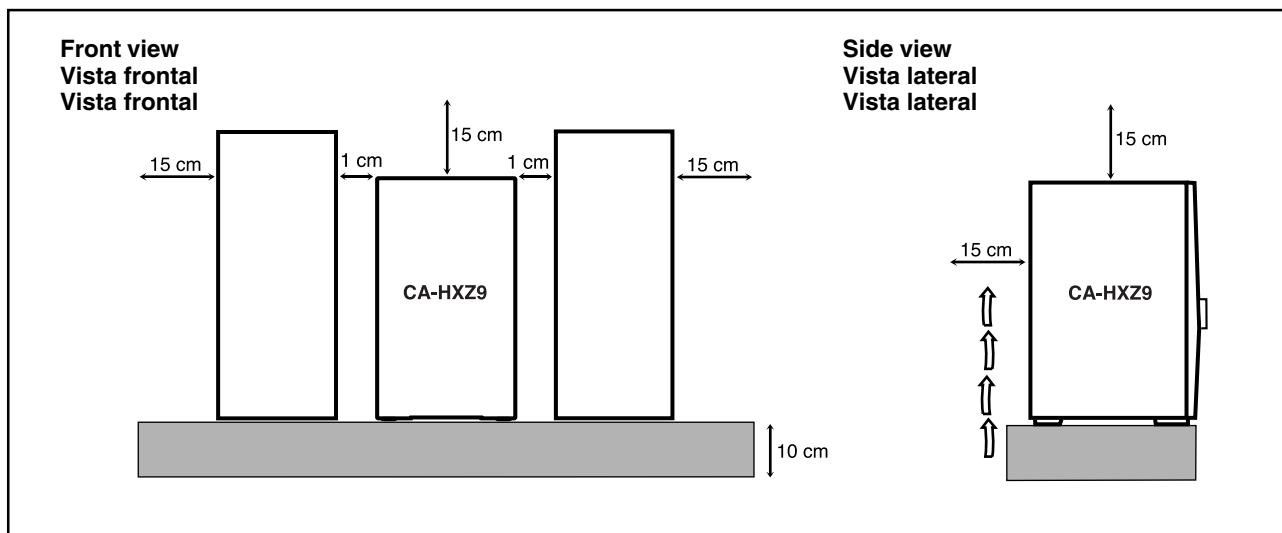

**IMPORTANT FOR LASER PRODUCTS
IMPORTANTE PARA PRODUCTOS LÁSER
IMPOTANTE PARA PRODUTOS LASER**

REPRODUCTION OF LABELS / REPRODUCCIÓN DE ETIQUETAS / REPRODUÇÃO DE ETIQUETAS

- | | |
|--|--|
| ① CLASSIFICATION LABEL ON EXTERIOR SURFACE | ② WARNING LABEL INSIDE THE UNIT |
| ① ETIQUETA DE CLASIFICACIÓN SOBRE LA SUPERFICIE EXTERIOR | ② ETIQUETA DE ADVERTENCIA DEL INTERIOR DE LA UNIDAD |
| ① ETIQUETA DE CLASSIFICAÇÃO LOCALIZADA NA SUPERFÍCIE EXTERNA | ② ETIQUETA DE ADVERTÊNCIA LOCALIZADA NA PARTE INTERNA DA UNIDADE |

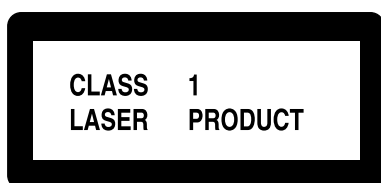

DANGER : Invisible laser radiation when open and interlock failed or defeated. AVOID DIRECT EXPOSURE TO BEAM. (e)

WARNING : Osynlig laserstrålning när denna del är öppnad och spärren är urkopplad. Betrakta ej strålen. (s)

ADVARSEL : Usynlig laserstrålning ved åbning, når sikkerhedsafbrydere er ude af funktion. Undgåudsætelse for stråling. (d)

VARO : Avattaessa ja suojalukitus ohitettaessa olet alltiina näkymättömälle lasersäteilylle. Älä katso säteeseen. (f)

1. CLASS 1 LASER PRODUCT
2. **DANGER**: Invisible laser radiation when open and interlock failed or defeated. Avoid direct exposure to beam.
3. **CAUTION**: Do not open the top cover. There are no user serviceable parts inside the Unit; leave all servicing to qualified service personnel.

1. PRODUCTO LÁSER CLASE 1
2. **PELIGRO**: En el interior hay radiación láser invisible. Evite el contacto directo con el haz.
3. **PRECAUCIÓN**: No abra la tapa superior. En el interior de la unidad no existen piezas reparables por el usuario; deje todo servicio técnico en manos de personal calificado.

1. PRODUTO LASER CLASSE 1
2. **PERIGO**: O laser emite uma radiação invisível que é perigosa, caso o aparelho esteja aberto e a trava inoperante ou danificada. Evite exposição direta ao feixe dos raios.
3. **CUIDADO**: Não abra a caixa do aparelho. Não existem peças reparáveis pelo usuário na parte interna da unidade. Solicite assistência técnica somente a pessoal técnico qualificado.

Introduction

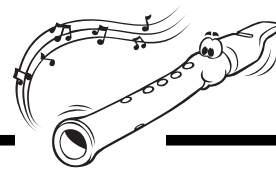

We would like to thank you for purchasing one of our JVC products. Before operating this unit, read this manual carefully and thoroughly to obtain the best possible performance from your unit, and retain this manual for future reference.

About This Manual

This manual is organized as follows:

- The manual mainly explains operations using the buttons and controls on the unit. You can also use the buttons on the remote control if they have the same or similar names (or marks) as those on the unit. If operation using the remote control is different from that using the unit, it is then explained.
- Basic and common information that is the same for many functions is grouped in one place, and is not repeated in each procedure. For instance, we do not repeat the information about turning on/off the unit, setting the volume, changing the sound effects, and others, which are explained in the section "Common Operations" on pages 9 to 12.
- The following marks are used in this manual:



Gives you warnings and cautions to prevent from damage or risk of fire/electric shock. Also gives you information which is not good for obtaining the best possible performance from the unit.



Gives you information and hints you had better know.

Precautions

Installation

- Install in a place which is level, dry and neither too hot nor too cold—between 5°C and 35°C.
- Install the unit in a location with adequate ventilation to prevent internal heat buildup in the unit.
- Leave sufficient distance between the unit and the TV.
- Keep the speakers away from the TV to avoid interference with TV.



DO NOT install the unit in a location near heat sources, or in a place subject to direct sunlight, excessive dust or vibration.

Power sources

- When unplugging from the wall outlet, always pull the plug, not the AC power cord.



DO NOT handle the AC power cord with wet hands.

Moisture condensation

Moisture may condense on the lens inside the unit in the following cases:

- After heating starts in the room
 - In a damp room
 - If the unit is brought directly from a cold to a warm place
- Should this occur, the unit may malfunction. In this case, leave the unit turned on for a few hours until the moisture evaporates, unplug the AC power cord, and then plug it in again.

Internal heat

A cooling fan is mounted on the rear panel to prevent heat buildup inside the unit.



For safety, observe the following carefully:

- Make sure there is good ventilation around the unit. Poor ventilation could overheat and damage the unit.
- DO NOT block the cooling fan and the ventilation openings or holes. If they are blocked by a newspaper or cloth, etc., the heat may not be able to get out.

Others

- Should any metallic object or liquid fall into the unit, unplug the unit and consult your dealer before operating any further.
- If you are not going to operate the unit for an extended period of time, unplug the AC power cord from the wall outlet.



DO NOT disassemble the unit since there are no user serviceable parts inside.

If anything goes wrong, unplug the AC power cord and consult your dealer.

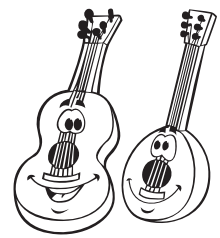

Location of the Buttons and Controls	3
Front Panel	3
Remote Control	5
Getting Started	6
Supplied Accessories	6
Putting the Batteries into the Remote Control	6
Connecting Antennas	6
Connecting Speakers	7
Connecting Other Equipment	8
Adjusting the Voltage Selector	8
Common Operations	9
Turning On or Off the Power	9
Canceling the Demonstration	9
Turning On or Off the Key-touch Tone	9
Saving the Power Consumption while on Standby	
—Ecology Mode	9
Selecting the Sources	9
Setting the Clock	10
Adjusting the Volume	10
Reinforcing the Bass Sound	11
Reinforcing the Heavy Sound	11
Selecting the Sound Modes	11
Creating Your Own Sound Mode—User Mode	12
Setting the AM Tuner Interval Spacing	12
Listening to FM and AM Broadcasts	13
Tuning in to a Station	13
Presetting Stations	13
Tuning in to a Preset Station	13
Playing Back Discs	14
Loading Discs	14
Playing Back the Entire Discs—Continuous Play ...	15
Basic Disc Operations	15
Programming the Playing Order of the Tracks	
—Program Play	16
Playing at Random—Random Play	17
Repeating Tracks or Discs—Repeat Play	18
Prohibiting Disc Ejection—Tray Lock	18
Playing Back Tapes	19
Playing Back a Tape	19
Locating the Beginning of a Song—Music Scan	19
Recording	20
Recording on a Tape	20
Synchronized Recording	21
Using the Timers	22
Using Daily Timer	22
Using Recording Timer	24
Using Sleep Timer	25
Timer Priority	25
Maintenance	26
Troubleshooting	27
Specifications	28

Location of the Buttons and Controls

Become familiar with the buttons and controls on your unit.

Front Panel

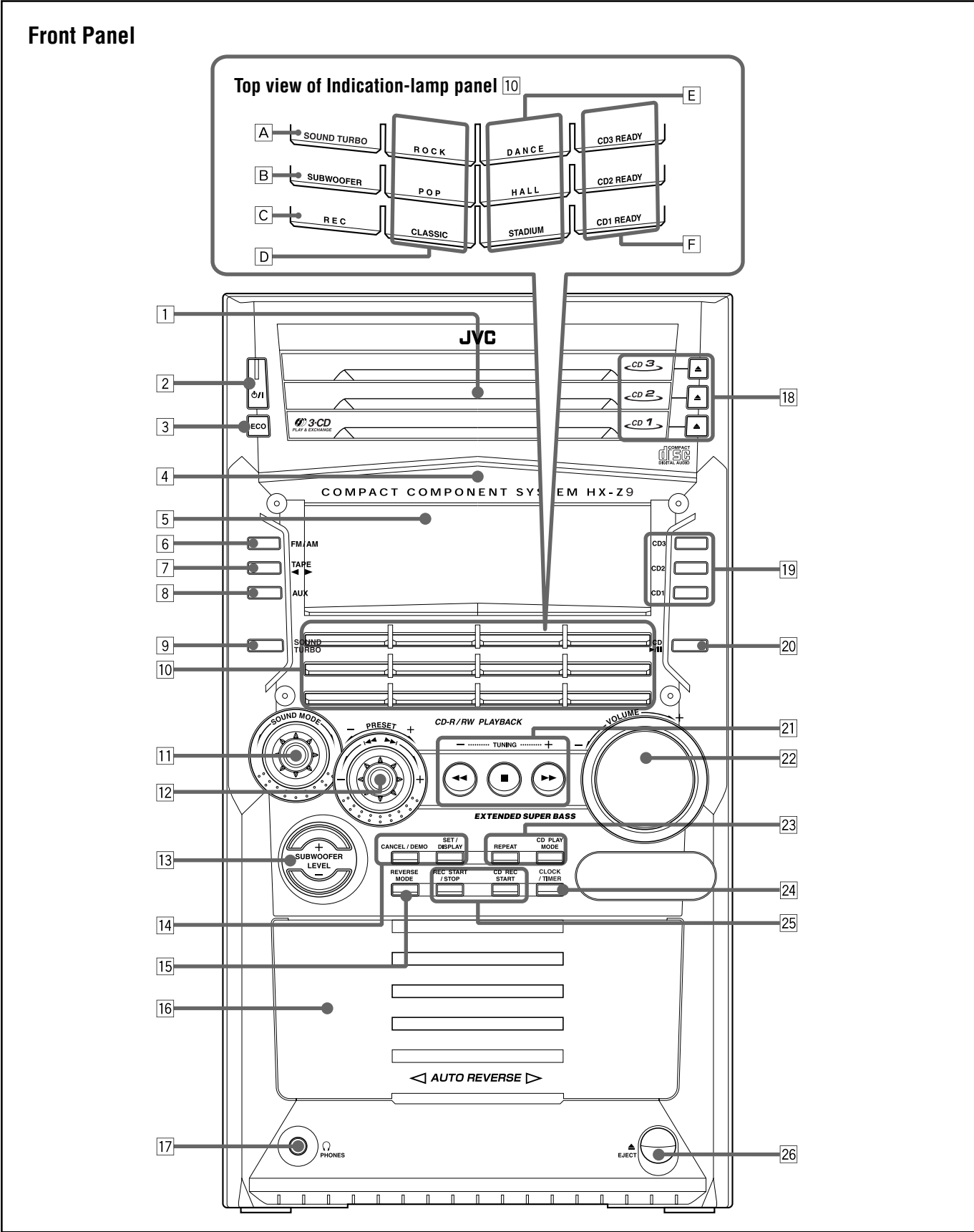



Remote Control

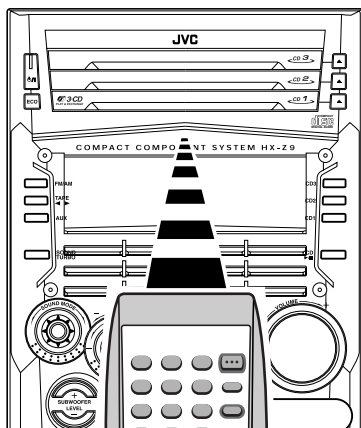
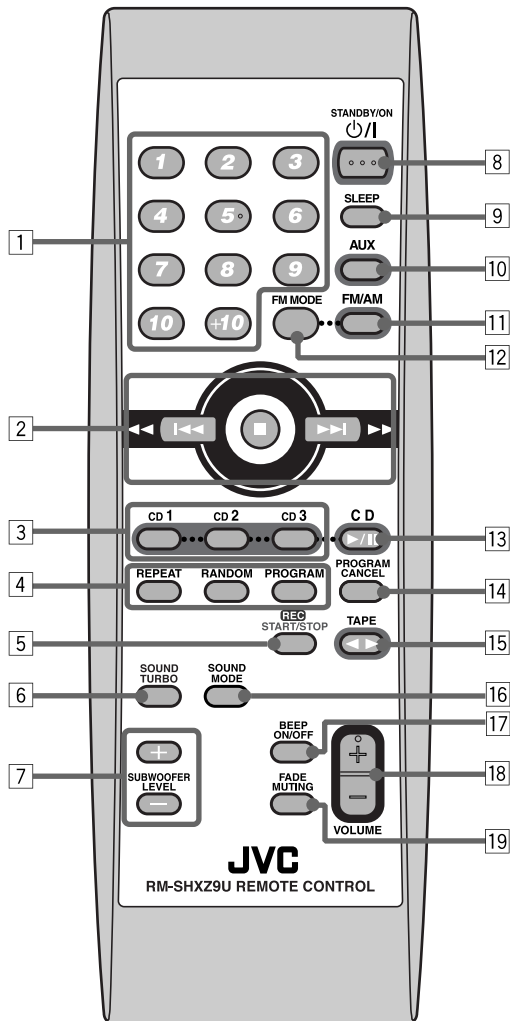

When using the remote control, point it at the remote sensor on the front panel.

Remote Control

- 1 Number buttons (13, 15, 16)
- 2 ◀◀ (◀◀) (reverse skip/reverse search) button (13, 15, 17, 19)
 - (stop) button (16, 17, 19 – 21, 24)
 - ▶▶ (▶▶) (forward skip/forward search) button (13, 15, 17, 19)
- 3 Disc number (CD1, CD2, and CD3) buttons (15 – 17)
Pressing one of these buttons also turns on the unit.
- 4 Disc play mode buttons (16 – 18)
 - REPEAT, RANDOM, and PROGRAM buttons
- 5 REC START/STOP button (20, 24)
- 6 SOUND TURBO button (11)
- 7 SUBWOOFER LEVEL + / – buttons (11)
- 8 STANDBY/ON ⏻/⏻ button (9)
- 9 SLEEP button (25)
- 10 AUX button (9)
Pressing this button also turns on the unit.
- 11 FM/AM button (9, 13)
Pressing this button also turns on the unit.
- 12 FM MODE button (13)
- 13 CD ▶/⏻ button (9, 15 – 17)
Pressing this button also turns on the unit.
- 14 PROGRAM CANCEL button (17)
- 15 TAPE ◀▶ button (9, 19, 20)
Pressing this button also turns on the unit.
- 16 SOUND MODE button (11)
- 17 BEEP ON/OFF button (9)
- 18 VOLUME + / – button (10)
- 19 FADE MUTING button (10)

Supplied Accessories

Make sure that you have all the following items.
The number in the parentheses indicates the quantity of the pieces supplied.

- AM loop antenna (1)
- FM antenna (1)
- Remote control (1)
- Batteries (2)
- AC plug adaptor (1)

If anything is missing, consult your dealer immediately.

Putting the Batteries into the Remote Control

Insert the batteries—R6(SUM-3)/AA(15F)—into the remote control, by matching the polarity (+ and -) on the batteries with the + and - markings on the battery compartment. When the remote control can no longer operate the unit, replace both batteries at the same time.

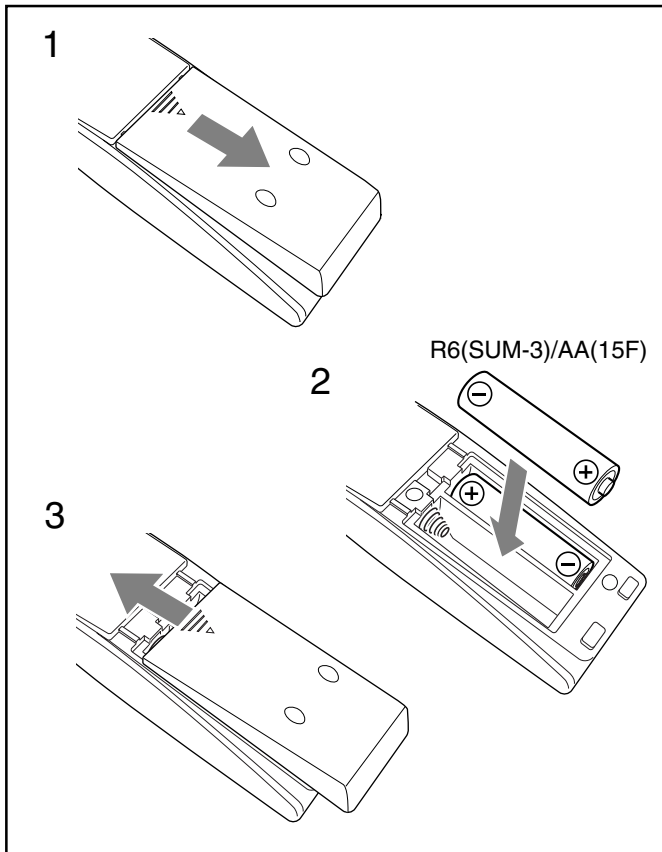

- DO NOT use an old battery together with a new one.
- DO NOT use different types of batteries together.
- DO NOT expose batteries to heat or flame.
- DO NOT leave the batteries in the battery compartment when you are not going to use the remote control for an extended period of time. Otherwise, it will be damaged from battery leakage.

Connecting Antennas

FM antenna

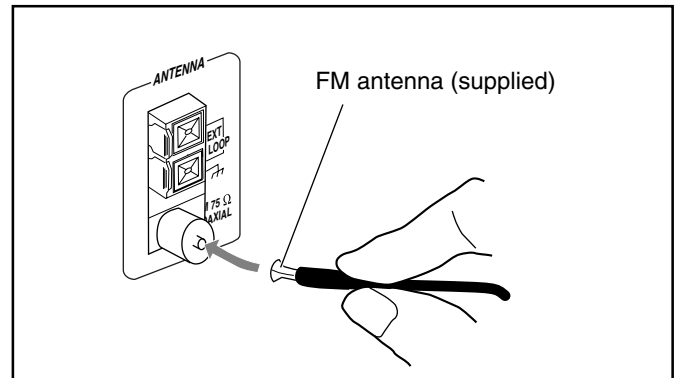

- 1 Attach the FM antenna to the FM 75 Ω COAXIAL terminal.
- 2 Extend the FM antenna.
- 3 Fasten it up in the position which gives you the best reception, then fix it on the wall, etc.



About the supplied FM antenna

The FM antenna supplied with this unit can be used as temporary measure. If reception is poor, you can connect an outdoor FM antenna.

To connect an outdoor FM antenna

Before connecting it, disconnect the supplied FM antenna.

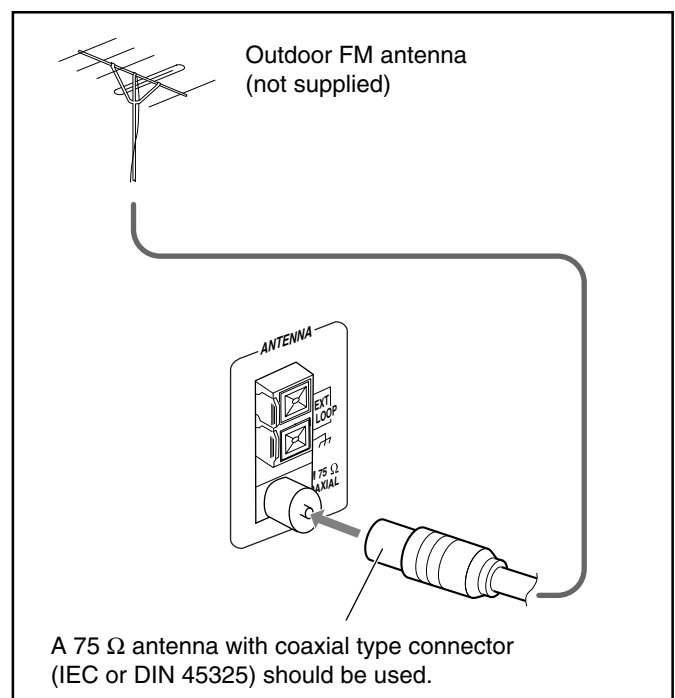

AM antenna

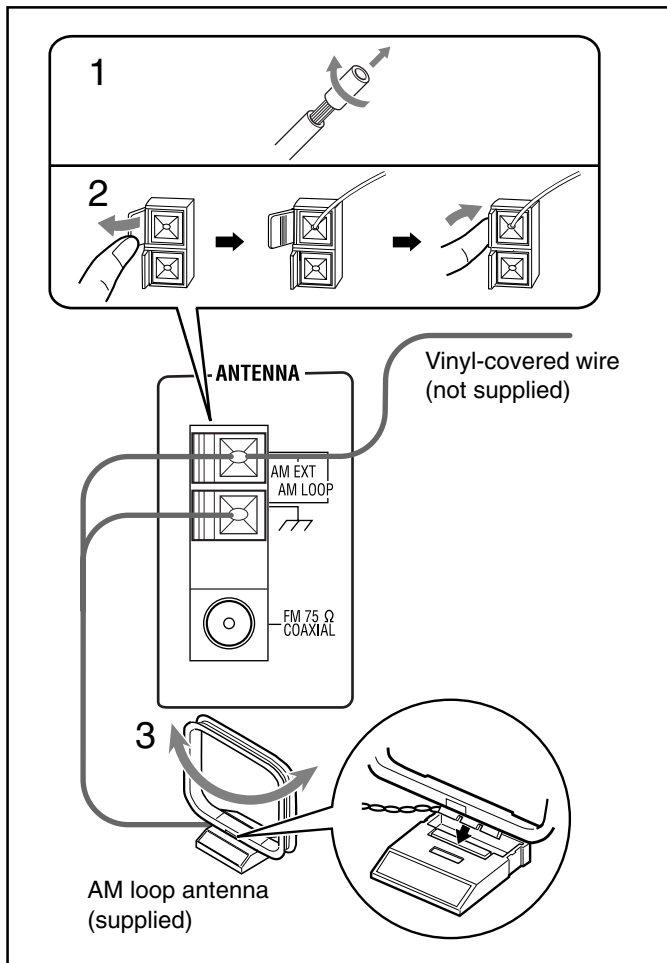

- 1 If cords are covered with insulation, twist the core of the cord at the end of each cord, then remove the insulation.
- 2 Connect the AM loop antenna to the AM LOOP terminals as illustrated.
- 3 Turn the AM loop antenna until you have the best reception.

To connect an outdoor AM antenna

When reception is poor, connect a single vinyl-covered wire to the AM EXT terminal and extend it horizontally. The AM loop antenna must remain connected.



For better reception of both FM and AM

- Make sure the antenna conductors do not touch any other terminals and connecting cords.
- Keep the antennas away from metallic parts of the unit, connecting cords, and the AC power cord.

Connecting Speakers

To connect front speakers and subwoofer

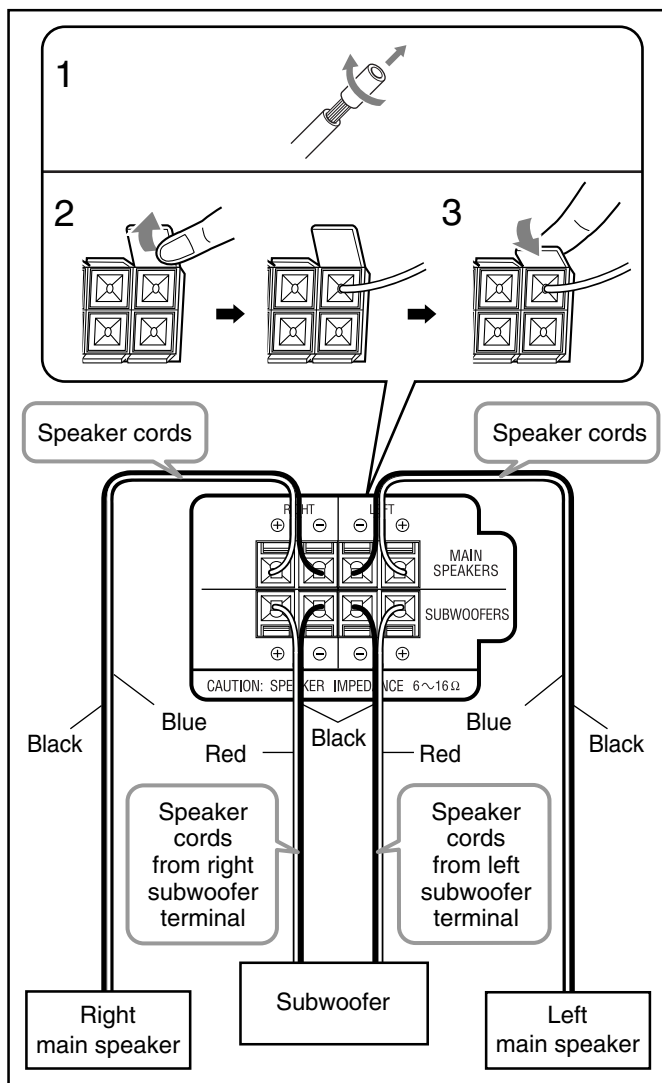

- 1 If cords are covered with insulation, twist the core of the cord at the end of each cord, then remove the insulation.
- 2 Insert the end of the speaker cord into the terminal as illustrated.
Match the same polarity: (+) to (+) and (-) to (-).
- 3 Close the speaker terminals.

IMPORTANT: Use only speakers with the same speaker impedance as indicated by the speaker terminals on the rear of the unit.



- DO NOT connect more than one speaker to each speaker terminal.
- DO NOT push or pull the speakers as this will damage the foot spacers at the bottom of the speakers.



To connect surround speakers

By connecting surround speakers to the SURROUND SPEAKERS jacks, you can enjoy surround effect.

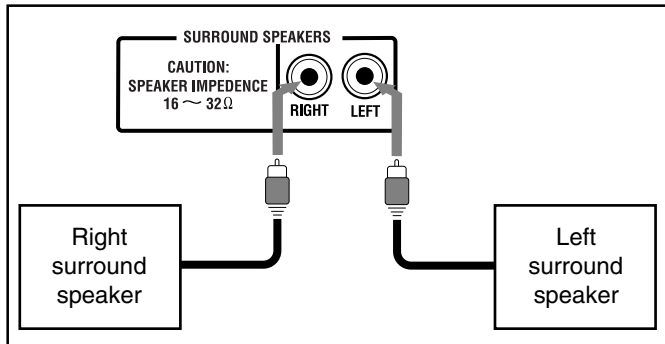

- Connect the right surround speaker to the RIGHT jack.
- Connect the left surround speaker to the LEFT jack.

Ideal speaker layout

To enjoy multichannel sound, locate speakers as follows.

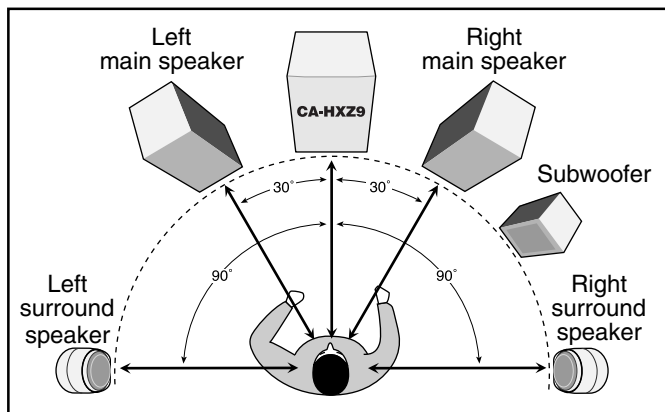

Connecting Other Equipment

You can connect audio equipment—used only as a playback device.

STOP!

- DO NOT connect any equipment while the power is on.
- DO NOT plug in any equipment until all connections are complete.

Be sure that the plugs of the audio cords are colored: White plugs and jacks are for left audio signals, and red ones for right audio signals.

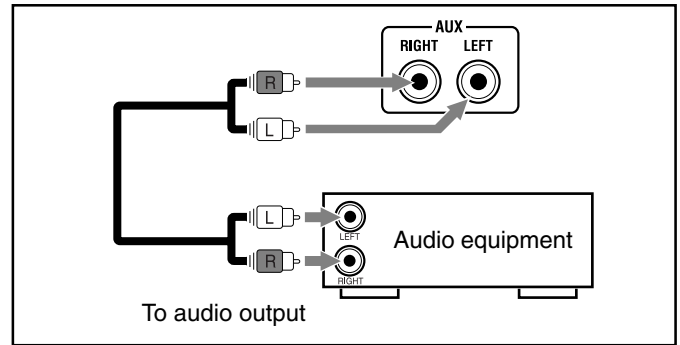

For playing the other equipment through this unit, connect between the audio output jacks on the other equipment and AUX jacks by using an audio cord (not supplied).

Adjusting the Voltage Selector

Before plugging in the unit, set the correct voltage for your area with the voltage selector on the rear of the unit.

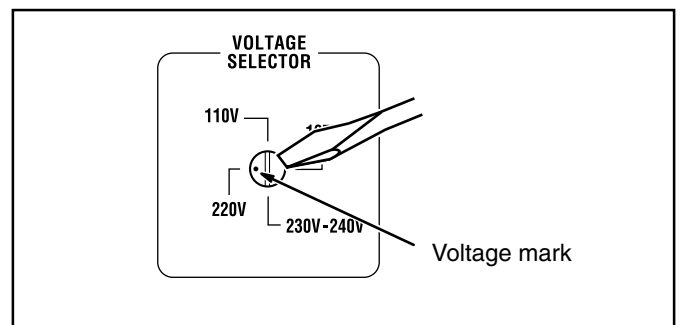

Use a screwdriver to rotate the voltage selector so that the voltage mark is pointing at the same voltage as where you are plugging in the unit. (See the back cover page.)

STOP! DO NOT plug in before setting the voltage selector on the rear of the unit and all connection procedures are complete.

Now, you can plug the AC power cord.

- If the wall outlet does not match the AC plug, use the supplied AC plug adaptor.
- When you connect the AC power cord into a wall outlet, the unit automatically starts the demonstration. To cancel the demonstration, see “Canceling the Demonstration” on page 9.

IMPORTANT: Be sure to check all connections to be done before plugging the AC power cord into a wall outlet.

Common Operations

Turning On or Off the Power

To turn on the unit, press $\phi/1$ (or STANDBY/ON $\phi/1$ on the remote control) so that the lamp on the button goes off.

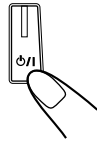

POWER ON

To turn off the unit (on standby), press $\phi/1$ (or STANDBY/ON $\phi/1$ on the remote control) again so that the lamp on the button lights up.

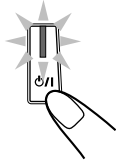

- A little power is always consumed even while the unit is on standby.

To switch off the power supply completely, unplug the AC power cord from the AC outlet.



When you unplug the AC power cord or if a power failure occurs

The clock is reset to "0:00" right away, while the tuner preset stations (see page 13) will be erased in a few days.

Canceling the Demonstration

When connecting the AC power cord into a wall outlet, the unit automatically starts the demonstration.

To cancel the demonstration, press and hold CANCEL/DEMO until "DEMO OFF" appears on the display.



- To cancel only beep sounds during the demonstration, press BEEP ON/OFF on the remote control.



When you press other buttons

The demonstration stops temporarily. It will start automatically again (if no operation is done for 2 minutes) unless you cancel it by pressing CANCEL/DEMO.

To start the demonstration manually

Press and hold CANCEL/DEMO again until "DEMO START" appears on the display.

Turning On or Off the Key-touch Tone

If you do not want the key-touch tone to beep each time you press a button, you can deactivate it.

On the remote control ONLY:

Press BEEP ON/OFF.



BEEP OFF

- Each time you press the button, the key-touch tone turns on ("BEEP ON") and off ("BEEP OFF") alternately.

BEEP OFF \longleftrightarrow BEEP ON

Saving the Power Consumption while on Standby —Ecology Mode

You can save the power consumption while the unit is turned off (on standby).

- You can set Ecology Mode whether the unit is on or off.

On the unit ONLY:

To activate the Ecology Mode, press ECO. "ECO" appears on the display for about 2 seconds (and the demonstration is canceled if you have pressed the button while the unit is off).



ECO

To deactivate the Ecology Mode, press ECO again. "NORMAL" appears on the display for about 2 seconds.

NORMAL

- Each time you press the button, "ECO" and "NORMAL" appear alternately on the display.



When you turn off the unit with Ecology Mode activated "ECO" flashes on the display, and the clock time will not be shown while the unit is turned off.

Selecting the Sources

To listen to the FM/AM broadcasts, press FM/AM. (See page 13.)

To play back discs, press CD $\blacktriangleright/||$. (See pages 14 – 18.)

To play back tapes, press TAPE $\blacktriangleleft\blacktriangleright$. (See page 19.)

To select the external equipment as the source, press AUX.



When you press the play button for a particular source (FM/AM, CD $\blacktriangleright/||$, TAPE $\blacktriangleleft\blacktriangleright$, and AUX), the unit turns on and the unit starts playing the source if it is ready.

Setting the Clock

You can set the clock whether the unit is on or off; however, if Ecology Mode is activated, you cannot set the clock while the unit is off (on standby).

If Ecology Mode is not in use while the unit is turned off (on standby), "0:00" flashes on the display until you set the clock.

On the unit ONLY:

1 Press CLOCK/TIMER.

The hour digits start flashing on the display.

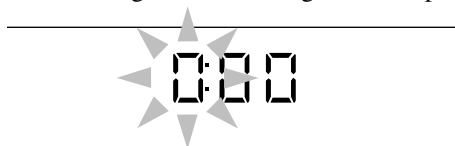

2 Turn ◀◀/▶▶ to adjust the hour, then press SET/DISPLAY.

The minute digits start flashing on the display.

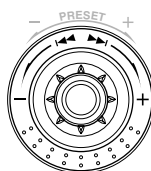

If you want to correct the hour after pressing SET/DISPLAY, press CANCEL/DEMO. The hour digits start flashing again.

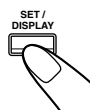
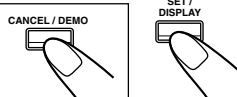

3 Turn ◀◀/▶▶ to adjust the minute, then press SET/DISPLAY.



To check the clock time while playing a source

Press and hold SET/DISPLAY.

- Each time you press and hold the button, the source indication and the clock time alternate on the display.

To adjust the clock again

If you have set the clock before, press CLOCK/TIMER repeatedly until the clock setting mode is selected.

- Each time you press the button, the clock/timer setting modes change as follows:

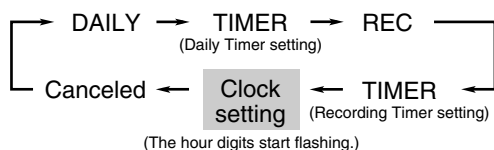

When you unplug the AC power cord or if a power failure occurs

The clock loses the setting and is reset to "0:00." If this happens, set the clock again.

Adjusting the Volume

You can adjust the volume level only while the unit is turned on. The volume level can be adjusted in 32 steps (VOLUME MIN, VOLUME 1 – VOLUME 30, and VOLUME MAX).

Turn VOLUME + / – clockwise (+) to increase the volume or counterclockwise (–) to decrease it.

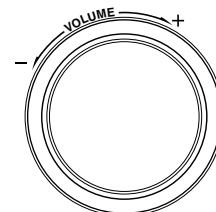

When using the remote control, press VOLUME + to increase the volume or VOLUME – to decrease it.



For private listening

Connect a pair of headphones to the PHONES (Ω) jack. No sound comes out of the speakers. Be sure to turn down the volume before connecting or putting on headphones.



DO NOT turn off (on standby) the unit with the volume set to an extremely high level; otherwise, a sudden blast of sound can damage your hearing, speakers and/or headphones when you turn on the unit or start playing any source next time. REMEMBER, you cannot adjust the volume level while the unit is off (on standby).

To turn down the volume level temporarily

On the remote control ONLY:

Press FADE MUTING.

The volume level gradually decreases to "VOLUME MIN."



To restore the sound, press the button again.

Reinforcing the Bass Sound

You can select one of the 5 subwoofer levels. This function only affects the playback sound, but does not affect your recording. The subwoofer level can be adjusted in 5 steps—LEVEL 0 (MIN LEVEL), LEVEL 1, LEVEL 2, LEVEL 3, and LEVEL 4 (MAX LEVEL).

Press **SUBWOOFER LEVEL +** to increase the subwoofer level or **SUBWOOFER LEVEL -** to decrease it.



SUBWOOFER lamp lights up in red.

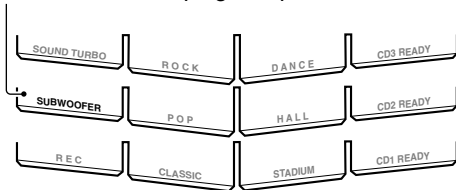

- The SUBWOOFER lamp lights up in red when LEVEL 1 to LEVEL 4 (MAX LEVEL) is selected. The lamp turns off when LEVEL 0 (MIN LEVEL) is selected.

Reinforcing the Heavy Sound

You can enjoy the heavy sound by using Sound Turbo. Sound Turbo function boosts the low and high frequency sound. This function only affects the playback sound, but does not affect your recording.

Press **SOUND TURBO**.

“TURBO ON” appears on the display and the SOUND TURBO lamp and the SUBWOOFER lamp light up.

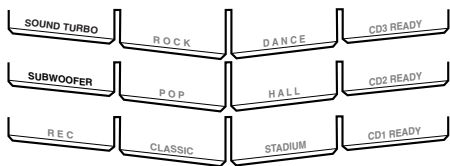

- Each time you press SOUND TURBO, Sound Turbo is turned on or off.



When you press SUBWOOFER LEVEL + / -, or when you select any sound mode while turning on Sound Turbo Sound Turbo is canceled.

Selecting the Sound Modes

You can select one of the 6 preset sound modes (3 surround modes and 3 SEA—Sound Effect Amplifier—modes) and 3 user modes. This function only affects the playback sound, but does not affect your recording. Each Sound Mode has its own illumination display.

To select the sound modes, turn **SOUND MODE** (or press SOUND MODE on the remote control) until the sound mode you want appears on the display.

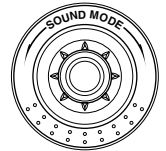

- When a sound mode is selected, the lamp for the selected sound mode (in this example, DANCE) flashes while the other sound mode lamps light up.

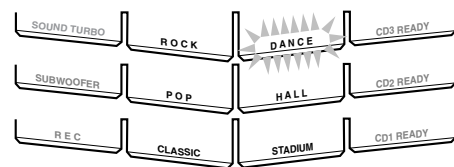

- When one of the user modes (USER1, USER2, or USER3) or “OFF” is selected, all sound mode lamps go off.

The sound modes change as follows:

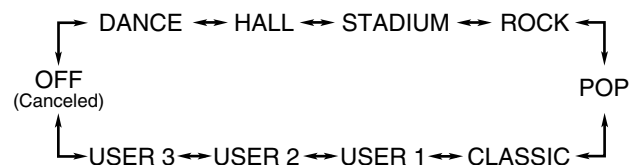

When using the remote control, the sound mode changes only clockwise in the above sequence.

Surround modes*

DANCE: Increases resonance and bass.

HALL: Adds depth and brilliance to the sound.

STADIUM: Adds clarity and spreads the sound, like in an outdoor stadium.

SEA (Sound Effect Amplifier) modes

ROCK: Boosts low and high frequency. Good for acoustic music.

POP: Good for vocal music.

CLASSIC: Good for classical music.

User Modes

USER 1/2/3: Your individual mode stored in memory. See “Creating Your Own Sound Mode—User Mode” on page 12.

OFF: The sound mode is canceled.

* Surround elements are added to the SEA elements to create a being-there feeling in your room.

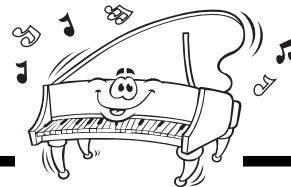

Creating Your Own Sound Mode—User Mode

You can change SEA (Sound Effect Amplifier) pattern to suit your preference. The SEA (Sound Effect Amplifier) pattern can be adjusted into 5 frequency ranges—LOW1, LOW2, MID, HIGH1, and HIGH2. These changed settings can be stored in the USER 1, USER 2, and USER 3 modes.

- There is a time limit in doing the following steps. If the setting is canceled before you finish, start from step 1 again.

On the unit ONLY:

1 Select one of the preset sound modes.

- If you want to add the surround elements in your SEA (Sound Effect Amplifier) pattern, select one of the surround modes (DANCE, HALL, or STADIUM) before starting the procedure below. (See “Selecting the Sound Modes” on page 11.)

2 Press SET/DISPLAY while the selected sound mode is still shown on the display.

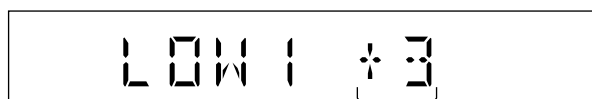
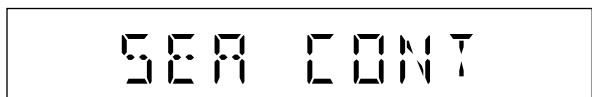
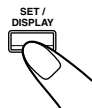

Current level appears.

3 Adjust the SEA (Sound Effect Amplifier) pattern.

- 1) Turn ◀◀ / ▶▶ to select the frequency range (LOW1, LOW2, MID, HIGH1, or HIGH2).
- 2) Press ◀◀ or ▶▶ to adjust the level (-3 to +3) of the selected frequency range.
- 3) Repeat steps 1) and 2) to adjust the level of the other frequency ranges.

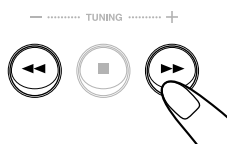
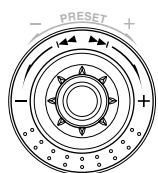

4 Press SET/DISPLAY again.

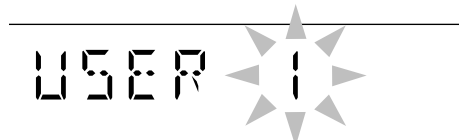
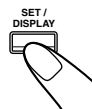

5 Turn ◀◀ / ▶▶ to select one of the user modes (USER 1, USER 2, or USER 3) in which you want to store your SEA (Sound Effect Amplifier) pattern.

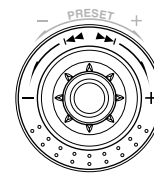

6 Press SET/DISPLAY again.

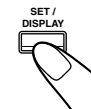

MEMORY

The SEA (Sound Effect Amplifier) pattern you have created are stored into the user mode selected in step 5.

To use your own sound mode

Select USER 1, USER 2, or USER 3 mode when using the sound modes. See “Selecting the Sound Modes” on page 11.



When you unplug the AC power cord or if a power failure occurs

The setting will be erased in a few days. If this happens, set the user modes again.

Setting the AM Tuner Interval Spacing

Some countries space AM stations 9 kHz apart, and some countries use 10 kHz spacing.

On the unit ONLY:

You can only change the AM tuner interval spacing while tuning in to an AM station. (See page 13.)

Press ◻/I while holding down ■.

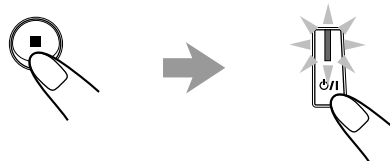

- Each time you press these buttons, the AM tuner interval spacing alternates between 9 kHz and 10 kHz.

Listening to FM and AM Broadcasts



Tuning in to a Station

1 Press FM/AM.

The unit automatically turns on and tunes in to the previously received station (either FM or AM).

- Each time you press the button, the band alternates between FM and AM.

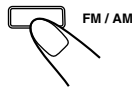

2 Start searching for stations.

On the unit:

Press and hold TUNING + or TUNING – for more than 1 second.

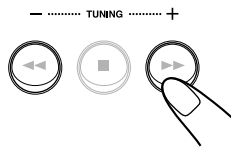

On the remote control:

Press and hold >>> (▶▶▶) or <<< (◀◀◀) for more than 1 second.

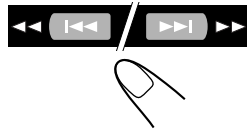

The unit starts searching for stations and stops when a station of sufficient signal strength is tuned in.

- If a program is broadcast in stereo, the ST (stereo) indicator lights up.

To stop searching, press TUNING + or TUNING – (or >>> (▶▶▶) / <<< (◀◀◀) on the remote control).



When you press TUNING + or TUNING – (or >>> (▶▶▶) / <<< (◀◀◀) on the remote control) briefly and repeatedly

The frequency changes step by step.

To change the FM reception mode

On the remote control ONLY:

When an FM stereo broadcast is hard to receive or noisy, press FM MODE so that the MONO indicator lights up on the display. Reception improves.

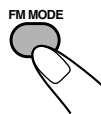

To restore the stereo effect, press FM MODE again so that the MONO indicator goes off. In this stereo mode, you can hear stereo sounds when a program is broadcasted.

Presetting Stations

You can preset 30 FM and 15 AM stations.

In some cases, test frequencies have been already memorized for the tuner since the factory examined the tuner preset function before shipment. This is not a malfunction. You can preset the stations you want into memory by following the presetting method.

- There is a time limit in doing the following steps. If the setting is canceled before you finish, start from step 2 again.

On the unit ONLY:

1 Tune in to the station you want to preset.

- See “Tuning in to a Station.”

2 Press SET/DISPLAY.

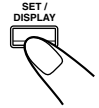
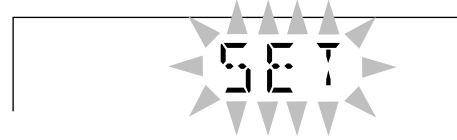

3 Turn PRESET + / – to select a preset number.

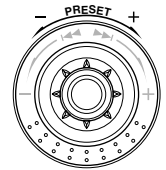
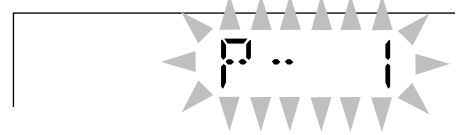

4 Press SET/DISPLAY again.

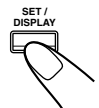
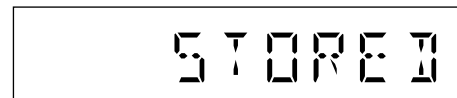

The tuned station in step 1 is stored in the preset number selected in step 3.

- Storing a new station on a used number erases the previously stored one.



When you unplug the AC power cord or if a power failure occurs

The preset stations will be erased in a few days. If this happens, preset the stations again.

Tuning in to a Preset Station

1 Press FM/AM.

The unit automatically turns on and tunes in to the previously received station (either FM or AM).

- Each time you press the button, the band alternates between FM and AM.

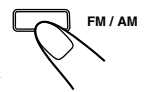

2 Select a preset number.

On the unit:

Turn PRESET + / –.

On the remote control:

Press the number buttons.

Ex.: For preset number 5, press 5.

For preset number 15, press +10, then 5.

For preset number 25, press +10, +10, then 5.

For preset number 30, press +10, +10, then 10.

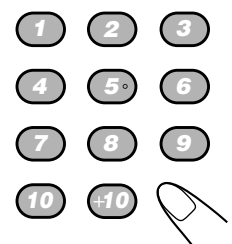
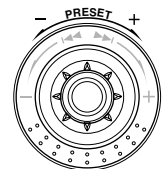

This unit has been designed to play back the following discs:

- CD (Audio CD)
- CD-R (CD-Recordable)
- CD-RW (CD-ReWritable)

When playing a CD-R or CD-RW

User-edited CD-Rs (CD-Recordable) and CD-RWs (CD-ReWritable) can be played back only if they are already “finalized.”

- You can play back your original CD-Rs or CD-RWs recorded in music CD format. (However, they may not be played back depending on their characteristics or recording conditions.)
- Before playing back CD-Rs or CD-RWs, read their instructions or cautions carefully.
- Some CD-Rs or CD-RWs may not be played back on this unit because of their disc characteristics, damage or stain on them, or if the player’s lens is dirty.
- CD-RWs may require a longer readout time. This is caused by the fact that the reflectance of CD-RWs is lower than for regular discs.

About the CD ready lamps

Each CD ready lamp corresponds to the disc tray of the same number.

- **When they light up?**
 - When you turn on the unit for the first time after plugging into a wall outlet, all CD ready lamps (CD1 READY, CD2 READY, and CD3 READY) light up. From the next time on, CD ready lamp(s) light(s) up according to the previous condition.
 - Each time you press the disc tray open/close buttons —▲ (CD1, CD2, and CD3), the corresponding CD ready lamp lights up.
- **When they go off?**

Only when the unit detects there is no disc loaded on a certain tray, the corresponding CD ready lamp goes off. (“NO DISC 1,” “NO DISC 2,” or “NO DISC 3” appears on the display.)
- **When they flash?**

The corresponding CD ready lamp flashes during playback and pause.

Loading Discs

On the unit ONLY:

- 1 Press ▲ for the disc tray (CD1, CD2, or CD3) you want to load a disc onto.**

The unit automatically turns on and the disc tray comes out.

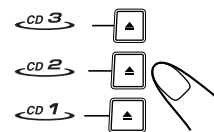

- 2 Place a disc correctly on the circle of the disc tray, with its label side up.**

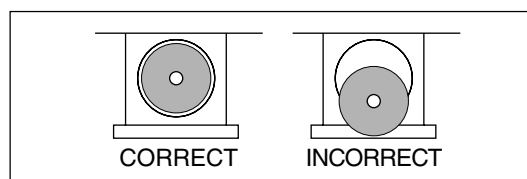

- When using a CD single (8 cm), place it on the inner circle of the disc tray.

- 3 Press the same ▲ you have pressed in step 1.**

The disc tray closes.

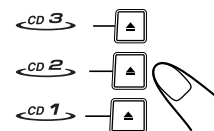

- 4 Repeat steps 1 to 3 to place other discs.**



When loading more than one disc

When you press ▲ for the next tray you want to place another disc onto, the first disc tray automatically closes and then the next tray comes out.

Playing Back the Entire Discs—Continuous Play

You can play discs continuously.

1 Load discs.

2 Press one of the disc number (CD1, CD2, or CD3) buttons for the disc you want to play.

The unit searches for the disc, and starts playing with the first track of the selected disc.

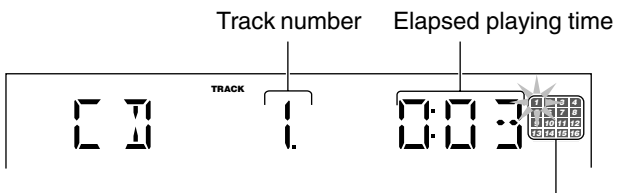
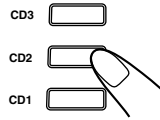

Tracks of the currently playing disc (Track numbers exceeding 16 are not displayed.)

- Pressing CD ►/|| instead of the disc number buttons starts playing back the currently selected disc.
- If no disc is placed on the selected disc tray, "NO DISC 1," "NO DISC 2," or "NO DISC 3" appears on the display. Then, the unit continues searching for a disc from the next disc tray.

To stop playing, press ■.

To remove the disc, press ▲ for the corresponding disc tray.

Disc playback sequence

When 3 discs* are loaded on the disc trays, they are played in one of the following sequences.

- When CD1 is pressed: CD1 ⇒ CD2 ⇒ CD3 (then stops)
- When CD2 is pressed: CD2 ⇒ CD3 ⇒ CD1 (then stops)
- When CD3 is pressed: CD3 ⇒ CD1 ⇒ CD2 (then stops)

* When only 2 discs are loaded, they are played in the same order, but the disc tray without a disc is skipped.

Basic Disc Operations

While playing a disc, you can do the following operations.

To exchange discs during playback of another

Press ▲ corresponding to a disc, not playing or selected currently, to eject and exchange the disc.

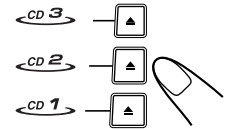

If you exchange discs during play, the current play will not stop until all discs you have exchanged are played.

To stop play for a moment

Press CD ►/||.

While pausing, the elapsed playing time flashes on the display.



To resume playing, press CD ►/|| again.

To go to another track

Before or during play, turn ◀◀◀/▶▶▶ (or press ◀◀◀ (◀◀◀)/▶▶▶ (▶▶▶) on the remote control).

- ◀◀◀ (or ◀◀◀ (◀◀◀)): Goes back to the beginning of the current or previous tracks.
- ▶▶▶ (or ▶▶▶ (▶▶▶)): Skips to the beginning of the next or succeeding tracks.

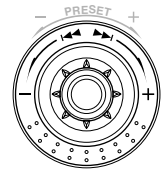

To locate a particular point in a track

During play, press and hold ◀◀ or ▶▶ (or ◀◀◀ (◀◀◀)/▶▶▶ (▶▶▶) on the remote control).

- ◀◀ (or ◀◀◀ (◀◀◀)): Fast-reverses the disc.
- ▶▶ (or ▶▶▶ (▶▶▶)): Fast-forwards the disc.

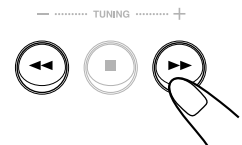

To go to another track directly using the number buttons

On the remote control ONLY:

Pressing the number button(s) before or during play allows you to start playing the track number you want.

Ex.: For track number 5, press 5.

For track number 15, press +10, then 5.

For track number 20, press +10, then 10.

For track number 32, press +10 three times, then 2.

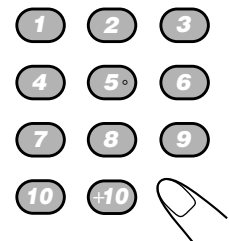

Programming the Playing Order of the Tracks —Program Play

You can arrange the playing order of the tracks before you start playing. **You can program up to 32 tracks.**

- To use Repeat Play (see page 18) for Program Play, press REPEAT after starting Program Play. Only REPEAT 1 and REPEAT ALL can be selected for Program Play.
- There is a time limit in doing the following steps. If the setting is canceled before you finish, start from step 2 again.

1 Load discs.

- If the current playing source is not the CD player, press CD ►/II, then ■ before going to the next step.

2 Activate the Program Play mode.

On the unit:

Press CD PLAY MODE repeatedly until “CD PROGRAM” appears on the display.



- Each time you press the button, the play mode changes as follows:

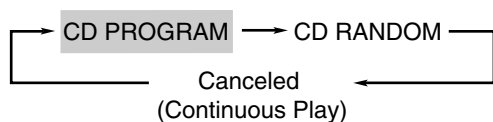

On the remote control:

Press PROGRAM so that “CD PROGRAM” appears on the display.

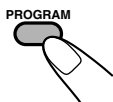

- The PRGM (program) indicator lights up on the display.

If a program has been stored in memory, the program is called up.

3 Press one of the disc number (CD1, CD2, or CD3) buttons to select the disc you want to play.

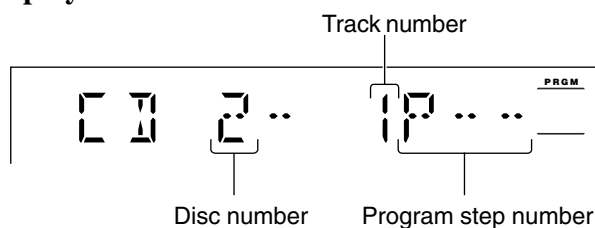
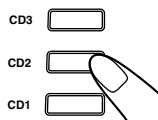

4 Select a track from the selected disc in step 3.

On the unit:

Turn |◀◀ / ▶▶| to select the track number, then press SET/DISPLAY.

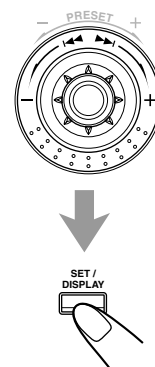

On the remote control:

Press the number buttons.

- For how to use the number buttons, see “To go to another track directly using the number buttons” on page 15.

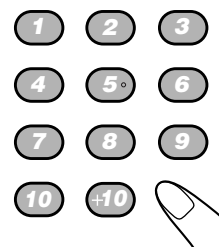

5 Program other tracks you want.

- To program tracks from the same disc, repeat step 4.
- To program tracks from a different disc, repeat steps 3 and 4.

6 Press CD ►/II.

The tracks are played in the order you have programmed.



To stop playing, press ■.

To exit from Program Play mode, press CD PLAY MODE repeatedly until the PRGM (program) indicator goes off (or press PROGRAM on the remote control) after playback stops.



- If you try to program a 33rd track, “CD FULL” will appear on the display.
- If you have tried to program a track from an empty tray, “NO DISC 1,” “NO DISC 2,” or “NO DISC 3” will appear on the display for about 2 seconds.
- If the track number you have programmed does not exist on the disc, it will be skipped during play.

To check the program contents

On the remote control ONLY:

Before playing, you can check the program contents by pressing

◀◀◀ (◀◀◀) or ▶▶▶ (▶▶▶).

- ◀◀◀ (◀◀◀) : Shows the programmed tracks in the reverse order.
- ▶▶▶ (▶▶▶) : Shows them in the programmed order.

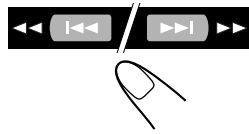

To modify the program

Before or after playing, you can erase the last programmed tracks by pressing CANCEL/DEMO (or press PROGRAM CANCEL on the remote control).

- Each time you press the button, the last programmed track is erased from the program.

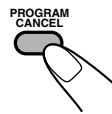

To add tracks in the program before playing, simply select the track numbers you want to add by following step 4 of the programming procedure. If you want to add tracks from another disc, follow steps 3 and 4.

To erase the entire program before or after playing, press and hold ■ until “CD PROGRAM” appears on the display.

- The program you have made will be erased,
 - when you unplug the AC power cord, or
 - when a power failure occurs.

Playing at Random—Random Play

The tracks of the currently selected disc will be played at random.

- To use Repeat Play (see page 18) for Random Play, press REPEAT after starting Random Play. Only REPEAT 1 and REPEAT ALL can be selected for Random Play.

1 Load a disc.

2 Press the corresponding disc number (CD1, CD2, or CD3) button where the disc is loaded in step 1, then press ■.

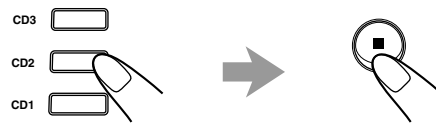

3 Activate the Random Play mode.

On the unit:

Press CD PLAY MODE repeatedly until “CD RANDOM” appears on the display.



- Each time you press the button, the play mode changes as follows:

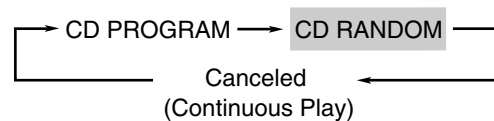

On the remote control:

Press RANDOM so that “CD RANDOM” appears on the display.



- The RANDOM indicator also lights up on the display.

4 Press CD ▶/■.

The tracks are randomly played.

Random Play ends when all the tracks of the all loaded discs are played once.



To skip the currently playing track, turn ◀◀◀ / ▶▶▶ to the right (or press ▶▶▶ (▶▶▶) on the remote control).



notes If you turn ◀◀◀ / ▶▶▶ to the left (or press ◀◀◀ (◀◀◀) on the remote control)

You cannot go back to the previous tracks during Random Play.

To stop playing, press ■.

To exit from Random Play mode, press CD PLAY MODE repeatedly until the RANDOM indicator goes off (or press RANDOM on the remote control) after playback stops.



Repeating Tracks or Discs—Repeat Play

You can have all the discs, the program or the individual track currently playing repeat as many times as you like.

To repeat playing, press REPEAT during or before play.

- Each time you press the button, Repeat Play mode changes as follows:

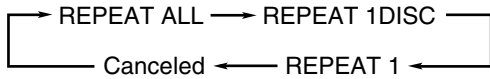

The Repeat Play mode indicator lights up on the display.

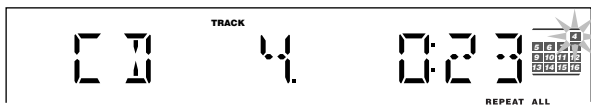

- REPEAT ALL:** During Continuous Play
Repeats all the tracks on all the loaded discs continuously.
- During Program Play
Repeats the program.
- During Random Play
Repeats all the tracks on all the loaded discs randomly.

REPEAT 1DISC: Repeats all the tracks on the current disc continuously.

REPEAT 1: Repeats the currently playing track.

To cancel Repeat Play, press REPEAT repeatedly until the Repeat Play mode indicators go off from the display.



“REPEAT 1DISC” cannot be selected for Program Play or Random Play

It is canceled when you select Program Play or Random Play.

Prohibiting Disc Ejection—Tray Lock

You can prohibit disc ejection from the unit and lock discs.

- This operation is possible only when the source is the CD player.

On the unit ONLY:

To prohibit disc ejection, press ▲ for any disc tray while holding down ■. (If there is any disc tray opened, close it first.)

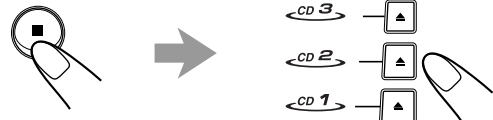

“LOCKED” appears for a while on the display, and the loaded discs are locked.



To cancel the prohibition and unlock the discs, press ▲ for any disc tray while holding down ■.

“UNLOCKED” appears for a while on the display, and the loaded discs are unlocked.



If you try to eject discs while Tray Lock is in use “LOCKED” appears to inform you that the disc trays are locked.

Playing Back Tapes

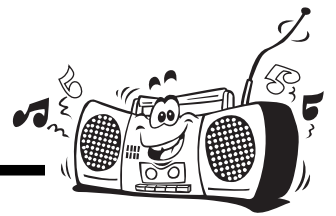

You can play back type I tapes without changing any settings.

Playing Back a Tape

1 Press **EJECT** for the cassette deck.

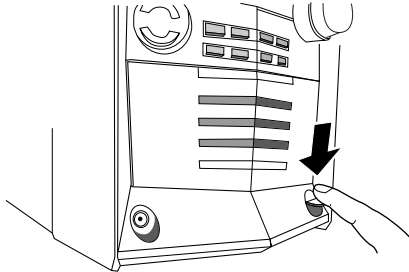



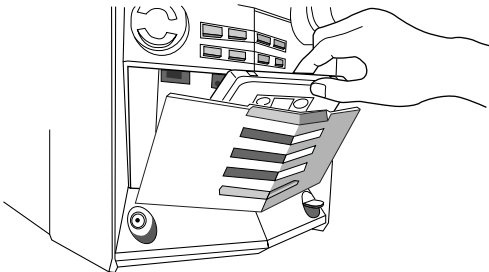

2 Insert a cassette with the exposed part of the tape down.



3 Close the cassette holder gently.





4 Press **TAPE** .



The tape play starts and the tape direction indicator ( or ) starts flashing slowly to indicate the tape running direction.

- Each time you press the button, the tape direction changes and “REVERSE” appears for a while on the display.
 -  : plays the front side.
 -  : plays the reverse side.
- If no cassette is inserted, “NO TAPE” appears on the display.

When the tape plays to the end, the deck automatically stops if the Reverse Mode is off. (See “To play both sides repeatedly—Reverse Mode.”)

To stop playing, press .

To fast-wind to the left or to the right, press  or  (or  / ) on the remote control) while the tape is not running.

The tape direction indicator ( or ) starts flashing quickly on the display.

To remove the cassette, press **EJECT** to open the cassette holder only while the tape is not running.

To play both sides repeatedly—Reverse Mode

When using Reverse Mode, the tape automatically reverses at the end of one side, starts playing the other side of the tape, and repeats the same process.

On the unit ONLY:





To use Reverse Mode, press REVERSE MODE so that the Reverse Mode indicator lights up on the display like— .

To cancel Reverse Mode, press the button again so that the Reverse Mode indicator lights up on the display like— .

Locating the Beginning of a Song—Music Scan

You can use Music Scan to locate the beginning of a song. Music Scan searches for blank portions that usually separate recorded songs, then plays the next song.





To find the beginning of the current song

During play, press  or  (or  / ) on the remote control in the **opposite direction** to the tape play.

The tape direction indicator of the opposite direction to the tape play starts flashing intermittently.

Searching stops automatically at the beginning of the current song, and it starts automatically.

To find the beginning of the next song

During play, press  or  (or  / ) on the remote control in the **same direction** as the tape play.

The tape direction indicator of the same direction as the tape play starts flashing intermittently.

Searching stops automatically at the beginning of the next song, and it starts automatically.



Music Scan works by detecting a 4-second long blank between each song, so it will not work well in the following cases

- No blank at the beginning of a song.
- Noise (often caused by much use or poor quality dubbing) which fills the blank.
- Long, very soft passages or pauses in a song.



The use of the C-120 or thinner tape is not recommended, since characteristic deterioration may occur and this tape easily jams in the pinch-rollers and the capstans.

IMPORTANT:

- It may be unlawful to record or play back copyrighted material without the consent of the copyright owner.
- The recording level is automatically set correctly, so it is not affected by the VOLUME, the SUBWOOFER LEVEL, and the SOUND MODE controls, or the SOUND TURBO button. Thus, during recording you can adjust the sound you are actually listening to without affecting the recording level.
- If there are excessive noise or static in the recording you have made, the unit may be too close to a TV. Increase the distance between the TV and the unit.
- You can use type I tape for recording.

To protect your recording

Cassettes have two small tabs on the back to protect from unexpected erasure or re-recording.

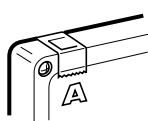

To protect your recording, remove these tabs.

To re-record on a protected tape, cover the holes with adhesive tape.

To keep the best recording and playback sound quality

If the heads, capstans, and pinch rollers of the cassette deck become dirty, the following will occur:

- Impaired sound quality
- Discontinuous sound
- Fading
- Incomplete erasure
- Difficulty in recording

To clean the heads, capstans, and pinch rollers

Use a cotton swab moistened with alcohol.

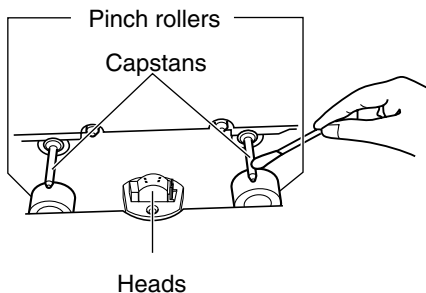

To demagnetize the heads

Turn off the unit, and use a head demagnetizer (available at electronics and audio shops).

Recording on a Tape

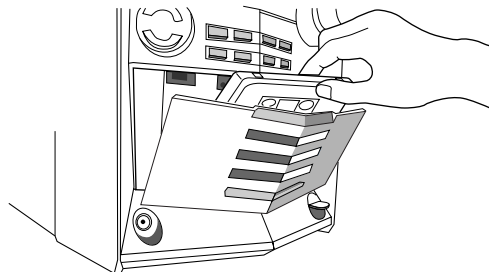

- 1 Press  EJECT and insert a recordable cassette with the exposed part of the tape down.



- 2 Close the cassette holder gently.

- If you want to record on both sides of a tape, see “To record on both sides—Reverse Mode.”

- 3 Check the tape direction of the cassette deck.

- If the tape direction is not correct, press TAPE   twice then  to change the tape direction.

- 4 Start playing the source—FM, AM, CD player or auxiliary equipment connected to AUX jacks.

- When the source is the CD player, you can also use Synchronized Recording (see page 21).

- 5 Start recording.



On the unit:

Press REC START/STOP.

On the remote control:

Press and hold REC START/STOP for more than 1 second.



The REC (recording) lamp flashes when recording starts, and the tape direction indicator ( or ) starts flashing slowly.

- If no cassette is inserted, “NO TAPE” appears on the display. If a protected tape is inserted, “NO REC” appears on the display.

To stop recording immediately, press REC START/STOP on the unit or  (or press and hold REC START/STOP on the remote control for more than 1 second).

To remove the cassette, press  EJECT to open the cassette holder only while the tape is not running.

To record on both sides—Reverse Mode

On the unit ONLY:

Press REVERSE MODE so that the Reverse Mode indicator lights up on the display like— .



- When using the Reverse Mode for recording, start recording in the forward () direction first. Otherwise, recording will stop when only one side (reverse) of the tape is recorded.

To cancel Reverse Mode, press the button again so that the Reverse Mode indicator lights up on the display like— .

Synchronized Recording

By using the Synchronized Recording method, everything on the disc goes onto the tape in the same order as it is on the disc, or according to the order you have set in Program Play. You can start or stop both disc play and tape recording at the same time.

On the unit ONLY:

1 Press ▲ EJECT and insert a recordable cassette with the exposed part of the tape down.

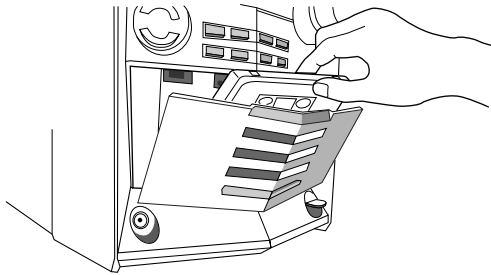

2 Load a disc.

3 Select a disc.

Press the corresponding disc number (CD1, CD2, or CD3) button where a disc is loaded in step 2, then press ■.

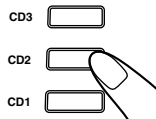

4 Press CD REC START.

“CD REC” appears on the display and the REC (recording) lamp flashes when recording starts.

The cassette deck starts recording while the CD player starts playing.

When the recording is done, “CD REC FINISHED” appears scrolling on the display, and the REC (recording) lamp turns off. Both the cassette deck and the CD player stop automatically.

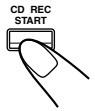

To stop recording, press ■ to create a 4-second blank portion on the recording tape. (Remember, a 4-second blank is important when using Music Scan—see page 19.)

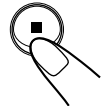

To remove the cassette, press ▲ EJECT to open the cassette holder only while the tape is not running.

To record on both sides—Reverse Mode

On the unit ONLY:

Press REVERSE MODE so that the Reverse Mode indicator lights up on the display like— (Z).

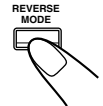

- When using the Reverse Mode for Synchronized Recording, start recording in the forward (▶) direction first. When the tape reaches its end while recording a song in the forward direction (▶), the last song will be re-recorded at the beginning of the reverse side (◀).

If you start recording on the reverse side (◀) first, recording will stop when only one side (reverse) of the tape is recorded.

To cancel Reverse Mode, press the button again so that the Reverse Mode indicator lights up on the display like— Z.

There are three timers available—DAILY (Daily Timer), REC (Recording Timer), and SLEEP (Sleep Timer).

You can set the timers whether the unit is on or off; however, if Ecology Mode is activated, you cannot set the timers while the unit is off.

Before using the timers, set the clock built in the unit. (See page 10.)

Using Daily Timer

With Daily Timer, you can be wake up with your favorite music or radio program.

How Daily Timer actually works

The unit automatically turns on, sets the volume level to the preset level, and starts playing the specified source when the on-time comes. (“DAILY” and the DAILY indicator flash just before the on-time, and the DAILY indicator continues flashing while the timer is operating.) Then, when the off-time comes (“DAILY OFF” flashes just before the off-time), the unit automatically turns off (on standby).

The Daily Timer works everyday automatically. If you do not want to use the Daily Timer, turn it off. (See “To turn on or off Daily Timer after its setting is done” on page 23.) The timer setting remains in memory until you change it.

- There is a time limit in doing the following steps. If the setting is canceled before you finish, start from step 1 again.
- To correct a misentry while setting the timer, press CANCEL/DEMO.

Before you start...

- When using a disc as the source to play—
 - Make sure there is a disc on the selected disc tray.
- When using a tape as the source to play—
 - Make sure that a tape is in the cassette deck.
 - Make sure that the tape direction is correct.
- When using the external component as the source to play—
 - Set the timer equipped on the external component at the same time.

On the unit ONLY:

1 Press CLOCK/TIMER repeatedly until “DAILY” appears on the display.



The  (Timer) indicator lights up and the DAILY (Daily Timer) indicator also starts flashing on the display.



- Each time you press the button, the timer setting modes change as follows:

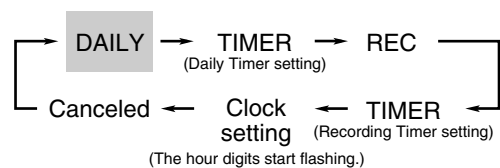





2 Press CLOCK/TIMER again.

“TIMER” appears for about 2 seconds, then the unit enters on-time setting mode.



3 Set the on-time you want the unit to turn on at.

- 1) Turn   to set the hour, then press SET/DISPLAY.
 - 2) Turn   to set the minute, then press SET/DISPLAY.
- “SET” appears for about 1 second, then the unit enters off-time setting mode.

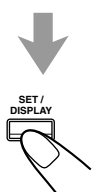
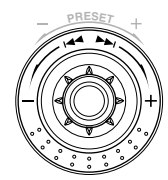

4 Set the off-time you want the unit to turn off (on standby) at.

- 1) Turn **◀◀ / ▶▶** to set the hour, then press **SET/DISPLAY**.
- 2) Turn **◀◀ / ▶▶** to set the minute, then press **SET/DISPLAY**.
“SET” appears for about 1 second, then the unit enters source selecting mode.

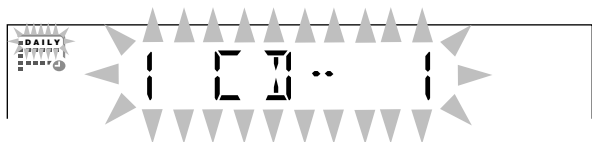

5 Turn **◀◀ / ▶▶** to select the source to play, then press **SET/DISPLAY**.

- “SET” appears for about 1 second.
- The source changes as follows:

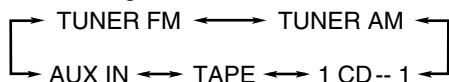

TUNER FM: tunes in to a specified preset FM station.

→ Go to step 6.

TUNER AM: tunes in to a specified preset AM station.

→ Go to step 6.

1 CD-- 1: plays from a specified track of a specified disc. → Go to step 6.

TAPE: plays a tape in the cassette deck.

→ Go to step 7.

AUX IN: plays an external source. → Go to step 7.

6 When selecting “TUNER FM” or “TUNER AM”

Turn **◀◀ / ▶▶** to select the preset station number, then press **SET/DISPLAY**.

The unit enters volume setting mode.

When selecting “1 CD-- 1”

- 1) Turn **◀◀ / ▶▶** to select the disc number, then press **SET/DISPLAY**.
“SET” appears for about 1 second.
- 2) Turn **◀◀ / ▶▶** to set the track number, then press **SET/DISPLAY**.
“SET” appears for about 1 second, then the unit enters volume setting mode.

7 Turn **◀◀ / ▶▶** to set the volume level.

- The volume level changes as follows:

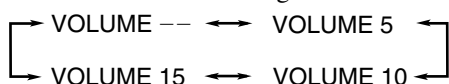

- If you select “VOLUME --,” the volume is set to the last level when the unit has been turned off.

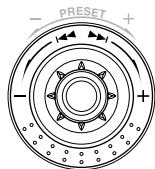

8 Press **SET/DISPLAY** to complete the Daily Timer setting.

The DAILY (Daily Timer) indicator stops flashing and remains lit. “OK ✓” appears on the display for about 2 seconds.

The settings you have done are shown on the display in sequence for your confirmation.

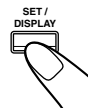

9 Press **⏻/|** to turn off the unit (on standby) if you have set the Daily Timer with the unit turned on.



- If the unit is turned on before the on-time comes Daily Timer does not work.
- Even if you unplug the AC power cord or if a power failure occurs

Once you set the timer, the timer setting may remain stored in memory in a few days. (Check whether the timer setting still remains or not.)

To turn on or off Daily Timer after its setting is done

1 Press **CLOCK/TIMER** repeatedly until “DAILY” appears on the display.

The DAILY (Daily Timer) indicator starts flashing on the display and **⏻** (Timer) indicator remains lit.



2 To turn off the Daily Timer, press **CANCEL/DEMO**.

The DAILY (Daily Timer) and **⏻** (Timer) indicators go off from the display (“DAILY OFF” appears for a while).

The Daily Timer is canceled, but the setting for the Daily Timer remains in memory.



Or

To turn on the Daily Timer, press **SET/DISPLAY**.

“OK ✓” appears on the display for about 2 seconds.

The settings you have done are shown on the display in sequence for your confirmation.

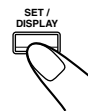

Using Recording Timer

With Recording Timer, you can make a tape of a radio broadcast automatically.

How Recording Timer actually works

The unit automatically turns on, tunes in to the specified station, sets the volume level to "VOLUME MIN," and starts recording when the on-time comes ("REC" and the REC indicator flash just before the on-time, and the REC indicator continues flashing while the timer is operating). Then, when the off-time comes ("REC OFF" flashes just before the off-time), the unit automatically turns off (on standby).

The timer setting remains in memory until you change it.

- There is a time limit in doing the following steps. If the setting is canceled before you finish, start from step 2 again.
- To correct a misentry while setting the timer, press CANCEL/DEMO.

On the unit ONLY:

1 Insert a recordable cassette with the exposed part of the tape down.

2 Press CLOCK/TIMER repeatedly until "REC" appears on the display.



The (Timer) indicator lights up and the REC (Recording Timer) indicator also starts flashing on the display.

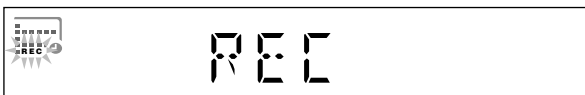

- Each time you press the button, the timer setting modes change as follows:

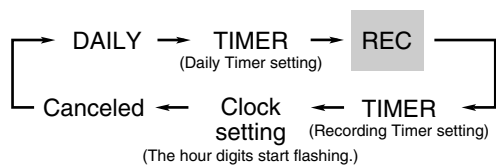

3 Press CLOCK/TIMER again.

"TIMER" appears for about 2 seconds, then the unit enters on-time setting mode.

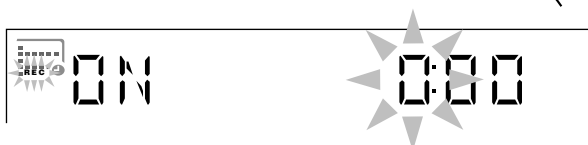

4 Set the on-time you want the unit to turn on at.

- 1) Turn |◀◀/▶▶| to set the hour, then press SET/DISPLAY.
- 2) Turn |◀◀/▶▶| to set the minute, then press SET/DISPLAY. "SET" appears for about 1 second, then the unit enters off-time setting mode.

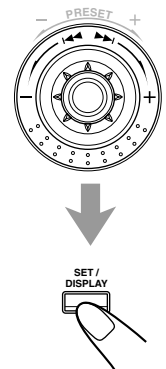

5 Set the off-time you want the unit to turn off (on standby) at.

- 1) Turn |◀◀/▶▶| to set the hour, then press SET/DISPLAY.
- 2) Turn |◀◀/▶▶| to set the minute, then press SET/DISPLAY. "SET" appears for about 1 second, then the unit enters preset station selecting mode.

6 Select the preset station.

- 1) Turn |◀◀/▶▶| to select the band ("TUNER FM" or "TUNER AM"), then press SET/DISPLAY. "SET" appears for about 1 second.
- 2) Turn |◀◀/▶▶| to select a preset channel number, then press SET/DISPLAY. The REC (Recording Timer) indicator stops flashing and remains lit. "OK ✓" appears on the display for about 2 seconds. The settings you have done are shown on the display in sequence for your confirmation.

7 Press ⏻/| to turn off the unit (on standby) if necessary.

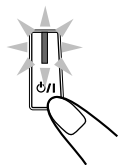

- **If you want to listen to another source while recording**
Press REC START/STOP or ■ to stop recording. Without stopping it, you cannot change the source.
- **Even if you unplug the AC power cord or if a power failure occurs**
Once you set the timer, the timer setting may remain stored in memory for a few days. (Check whether the timer setting still remains or not.)



To turn on or off Recording Timer after its setting is done

1 Press CLOCK/TIMER repeatedly until "REC" appears on the display.

The REC (Recording Timer) indicator starts flashing on the display and the  (Timer) indicator remains lit.



2 To turn off the Recording Timer, press CANCEL/DEMO.

The REC (Recording Timer) indicator goes off from the display ("REC OFF" appears on the display for about 2 seconds).

The Recording Timer is canceled, but the setting for the Recording Timer remains in memory.

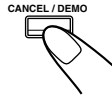

Or

To turn on the Recording Timer, press SET/DISPLAY.

"OK ✓" appears on the display for about 2 seconds.

The settings you have done are shown on the display in sequence for your confirmation.

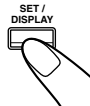

To check the remaining time until the shut-off time, press SLEEP once so that the remaining time (minute) until the shut-off time appears for about 5 seconds.

To change the shut-off time, press SLEEP repeatedly until the desired time length appears on the display.

To cancel the setting, press SLEEP repeatedly so that the SLEEP indicator goes off.

- Sleep Timer is also canceled when you turn off the unit.

Timer Priority

Since each timer can be set separately, you may wonder what happens if the settings for these timers overlap.

Below are some examples.

Recording Timer has priority over Daily Timer and Sleep Timer.

- If Daily Timer is set to come on while Recording Timer is operating, Daily Timer will not come on at all.

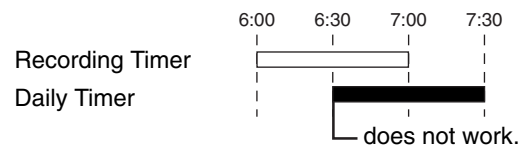

- If Recording Timer is set to come on while Sleep Timer is operating, Sleep Timer will be canceled.

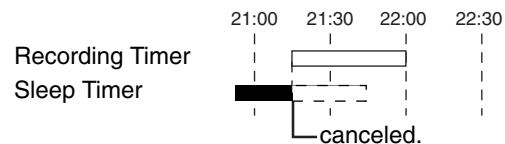

Using Sleep Timer

With Sleep Timer, you can fall asleep to music. You can set Sleep Timer only while the unit is turned on.

How Sleep Timer actually works

The unit automatically turns off after the specified time length passes.

On the remote control ONLY:

1 Press SLEEP.

The time length until the shut-off time appears and the SLEEP indicator starts flashing on the display.

- Each time you press the button, the time length changes as follows:

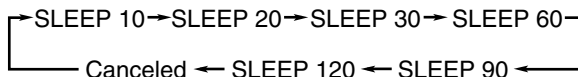

- If the built-in clock has not been set, "CLOCK ADJUST" appears on the display.

2 Wait for about 5 seconds after specifying the time length.

The SLEEP indicator flashes slowly until Sleep Timer works.





To get the best performance of the unit, keep your discs, tapes, and mechanism clean.

General Notes

In general, you will have the best performance by keeping your discs and the mechanism clean.

- Store discs in their cases, and keep them in cabinets or on shelves.
- Keep the unit's disc trays closed when not in use.

Handling discs



- Remove the disc from its case by holding it at the edge while pressing the center hole lightly.
- Do not touch the shiny surface of the disc, or bend the disc.
- Put the disc back in its case after use to prevent warping.

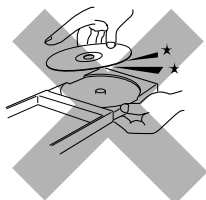

- Be careful not to scratch the surface of the disc when placing it back in its case.
- Avoid exposure to direct sunlight, temperature extremes, and moisture.

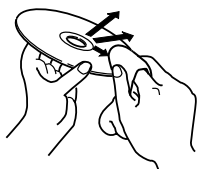

To clean the disc

Wipe the disc with a soft cloth in a straight line from center to edge.

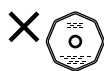
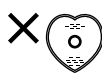

Continued use of irregular shape discs (heart-shape, octagonal, etc.) can damage the unit.



DO NOT use any solvent—such as conventional record cleaner, spray, thinner, or benzine—to clean the disc.

Handling cassette tapes

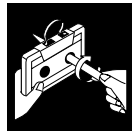

- If the tape is loose in its cassette, take up the slack by inserting a pencil in one of the reels and rotating.
- If the tape is loose, it may get stretched, cut, or caught in the cassette.



- Be careful not to touch the tape surface.



- Avoid the following places to store the tape:
 - In dusty places
 - In direct sunlight or heat
 - In moist areas
 - Near a magnet

Cleaning the unit

Stains on the unit

Should be wiped off with a soft cloth. If the unit is heavily stained, wipe it with a cloth soaked in water diluted neutral detergent and wrung well, then wipe clean with a dry cloth.

Since the unit may deteriorate in quality, become damaged or get its paint peeled off, be careful about the following:

- DO NOT wipe it with a hard cloth.
- DO NOT wipe it strong.
- DO NOT wipe it with thinner or benzene.
- DO NOT apply any volatile substance such as insecticides to it.
- DO NOT allow any rubber or plastic to remain in contact with it for a long time.

Troubleshooting



If you are having a problem with your unit, check this list for a possible solution before calling for service.

If you cannot solve the problem from the hints given here, or the unit has been physically damaged, call a qualified person, such as your dealer, for service.

	Symptom	Cause	Action
GENERAL	Unable to cancel the demonstration.	The button other than CANCEL/DEMO is pressed to cancel the demonstration temporarily.	Press CANCEL/DEMO on the unit. (See page 9.)
	No sound is heard.	Connections are incorrect or loose.	Check all connections and make corrections. (See pages 6 to 8.)
	Operations are disabled.	The built-in microprocessor may malfunction due to external electrical interference.	Unplug the AC power cord and then plug it back in.
	Unable to operate the unit from the remote control.	<ul style="list-style-type: none"> The path between the remote control and the remote sensor on the unit is blocked. The batteries are exhausted. 	<ul style="list-style-type: none"> Remove the obstruction. Replace the batteries.
TUNER	Hard to listen to broadcasts because of noise.	<ul style="list-style-type: none"> Antennas are disconnected. The AM loop antenna is too close to the unit. The FM antenna is not properly extended and positioned. 	<ul style="list-style-type: none"> Reconnect the antennas correctly and securely. Change the position and direction of the AM loop antenna. Extend the FM antenna at the best position.
AUDIO CD	The disc sound is discontinuous.	The disc is scratched or dirty.	Clean or replace the disc. (See page 26.)
	The disc tray does not open or close.	<ul style="list-style-type: none"> The AC power cord is not plugged in. Trays are locked. 	<ul style="list-style-type: none"> Plug the AC power cord. Unlock the trays. (See page 18.)
	The disc does not play.	The disc is placed upside down.	Place the disc with the label side up.
TAPE	The cassette holders cannot be opened.	Power supply from the AC power cord has been cut off while the tape was running.	Turn on the unit.
REC	Impossible to record.	Small tabs on the back of the cassette are removed.	Cover the holes with adhesive tape. (See page 20.)

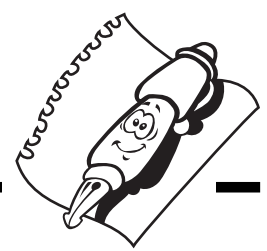

Amplifier section

Output Power (IEC 268-3)

SUBWOOFERS: 75 W per channel, min. RMS, both channels driven into 6 Ω at 63 Hz with no more than 0.9% total harmonic distortion.

MAIN SPEAKERS: 30 W per channel, min. RMS, both channels driven into 6 Ω at 1 kHz with no more than 0.9% total harmonic distortion.

Audio input sensitivity/Impedance

(Measured at 1 kHz, with tape recording signal 300 mV)

AUX: 390 mV/50 k Ω

Speakers/Impedance:

SUBWOOFERS: 6 Ω – 16 Ω

MAIN SPEAKERS: 6 Ω – 16 Ω

SURROUND SPEAKERS: 16 Ω – 32 Ω

Tuner

FM tuning range: 87.50 MHz – 108.00 MHz

AM tuning range: At 9 kHz intervals: 531 kHz – 1 710 kHz
At 10 kHz intervals: 530 kHz – 1 710 kHz

CD player

CD capacity: 3 CDs

Dynamic range: 85 dB

Signal-to-noise ratio: 90 dB

Wow and flutter: Immeasurable

Cassette deck

Frequency response

Normal (type I): 50 Hz – 14 000 Hz

Wow and flutter: 0.15% (WRMS)

General

Power requirement: AC 110 V / AC 127 V / AC 220 V /
AC 230 V – AC 240 V \sim (adjustable
with the voltage selector), 50 Hz / 60 Hz

Power consumption: 205 W (in operation)
23 W (on standby with Ecology Mode off)
Less than 3.5 W (on standby with
Ecology Mode on)

Dimensions (approx.): 205 mm \times 370 mm \times 370 mm (W/H/D)

Mass (approx.): 10.0 kg

Supplied accessories

See page 6.

Design and specifications are subject to change without notice.

Mains (AC) Line Instruction (not applicable for Europe, U.S.A., Canada, Australia, and U.K.)

Instrucción sobre la línea de la red (CA) (no aplicable para Europa, EE.UU., Canadá, Australia, ni el Grã-Bretanha)

Instrução sobre a tensão da rede eléctrica (CA) (não aplicável para a Europa, os E.U.A., o Canadá, a Austrália e o Reino Unido)

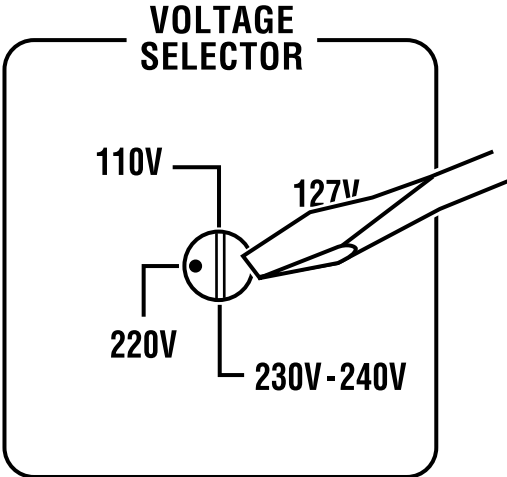

VOLTAGE SELECTOR

110V
127V
220V
230V-240V

IMPORTANT for mains (AC) line
BEFORE PLUGGING IN, do check that your mains (AC) line voltage corresponds with the position of the voltage selector switch provided on the outside of this equipment and, if different, reset the voltage selector switch, to prevent from damage or risk of fire/electric shock.

IMPORTANTE para la línea de la red (CA)
ANTES DE ENCHUFAR EL EQUIPO, compruebe si la tensión de la línea de la red (CA) corresponde con la posición del selector de tensión situado en la parte exterior del equipo, y si es diferente, reajuste el selector de tensión para evitar el riesgo de incendios/descargas eléctricas.

IMPORTANTE para a ligação à tensão da rede (CA)
ANTES DE LIGAR O APARELHO A UMA TOMADA DA REDE, verifique se a tensão da rede CA corresponde à posição do seletor de voltagem localizado na parte externa deste equipamento. Caso não corresponda, reajuste o seletor de voltagem a fim de evitar avarias ou riscos de incêndio e choque elétrico.

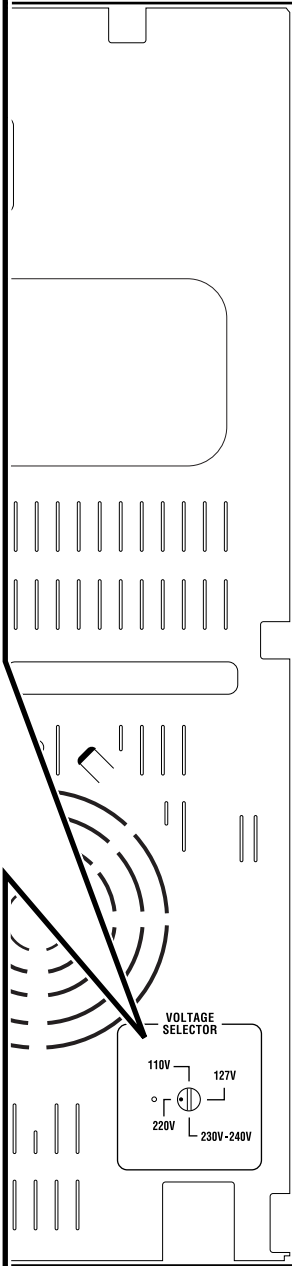

VOLTAGE SELECTOR

110V
127V
220V
230V-240V

JVC
VICTOR COMPANY OF JAPAN, LIMITED

Free Manuals Download Website

<http://myh66.com>

<http://usermanuals.us>

<http://www.somanuals.com>

<http://www.4manuals.cc>

<http://www.manual-lib.com>

<http://www.404manual.com>

<http://www.luxmanual.com>

<http://aubethermostatmanual.com>

Golf course search by state

<http://golfingnear.com>

Email search by domain

<http://emailbydomain.com>

Auto manuals search

<http://auto.somanuals.com>

TV manuals search

<http://tv.somanuals.com>