

JVC



COMPACT COMPONENT MD SYSTEM

MD-KOMPAKT-KOMPONENTEN-SYSTEM

SYSTEME MD DE COMPOSANTS COMPACT

COMPACTO COMPONENT MD-SYSTEEM

SISTEMAS MD DE COMPONENTES COMPACTOS

IMPIANTO A COMPONENTI COMPATTO MD

CA-MD70R

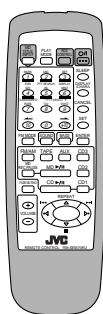

R-D-S EON



**COMPACT
disc**
DIGITAL AUDIO

INSTRUCTIONS
BEDIENUNGSANLEITUNG
MANUEL D'INSTRUCTIONS
GEBRUIKSAANWIJZING
MANUAL DE INSTRUCCIONES
ISTRUZIONI

For Customer Use:

Enter below the Model No. and Serial No. which are located either on the rear, bottom or side of the cabinet. Retain this information for future reference.

Model No. _____

Serial No. _____

LVT0074-002B

[E]

Introduction



We would like to thank you for purchasing one of our JVC products. Before operating this unit, read this manual carefully and thoroughly to obtain the best possible performance from your unit, and retain this manual for future reference.

About This Manual

This manual is organized as follows:

- The manual mainly explains operations using the buttons and controls on the unit. You can also use the buttons on the remote control if they have the same or similar names (or marks) as those on the unit.

If operation using the remote control is different from that using the unit, it is then explained.

- Basic and common information that is the same for many functions is grouped in one place, and is not repeated in each procedure. For instance, we do not repeat the information about turning on/off the unit, setting the volume, changing the sound effects, and others, which are explained in the section “Basic Settings” and “Common Operations” on pages 10, 11, and 12.
- The following marks are used in this manual:



Gives you warnings and cautions to prevent from a damage or risk of fire/electric shock.

Also gives you information which is not good for obtaining the best possible performance from the unit.



Gives you information and hints you had better know.

Precautions

Installation

- Install in a place which is level, dry and neither too hot nor too cold — between 5°C (41°F) and 35°C (95°F).
- Install the unit in a location with adequate ventilation to prevent internal heat built-up in the unit.
- Leave sufficient distance between the unit and the TV.
- Keep the speakers away from the TV to avoid interference with TV.



DO NOT install the unit in a location near heat sources, or in a place subject to direct sunlight, excessive dust or vibration.

Power sources

- When unplugging from the wall outlet, always pull the plug, not the AC power cord.



DO NOT handle the AC power cord with wet hands.

Moisture condensation

Moisture may condense on the lens inside the unit in the following cases:

- After starting heating in the room
- In a damp room
- If the unit is brought directly from a cold to a warm place

Should this occur, the unit may malfunction. In this case, leave the unit turned on for a few hours until the moisture evaporates, unplug the AC power cord, and then plug it in again.

Others

- Should any metallic object or liquid fall into the unit, unplug the unit and consult your dealer before operating any further.
- If you are not going to operate the unit for an extended period of time, unplug the AC power cord from the wall outlet.



DO NOT disassemble the unit since there are no user serviceable parts inside.

If anything goes wrong, unplug the AC power cord and consult your dealer.

Contents



Location of the Buttons and Controls	3	Playing Back an MD	23
Front Panel	4	Playing Back the Entire MD	
Remote Control	5	— Continuous Play	23
Getting Started	6	Basic MD Operations	23
Unpacking	6	Programming the Playing Order of the Tracks	
Putting the Batteries into the Remote Control	6	— Program Play	24
Connecting Antennas	6	Playing at Random — Random Play	26
Connecting Speakers	7	Repeating Tracks — Repeat Play	26
Connecting Other Equipment	8	Recording onto an MD	27
Basic Settings	10	Things to Know Before You Start Recording	27
Setting the Clock	10	Recording FM/AM Broadcasts or from the	
Changing the Display Pattern	10	Cassette Deck	28
Common Operations	11	Recording from the External (AUX) Equipment ...	29
Turning On the Power and Selecting the Sources ..	11	Recording CDs	30
Adjusting the Volume	11	Editing MDs	32
Reinforcing the Bass Sound	12	Introducing MD Editing Functions	32
Selecting the Sound Modes	12	DIVIDE Function	33
Creating Your Own Sound Mode — MANUAL		JOIN Function	34
Mode	12	MOVE Function	35
Listening to FM and AM Broadcasts	13	ERASE Function	36
Tuning in a Station	13	ALL ERASE Function	37
Presetting Stations	13	Erasing a Portion of a Track	37
Tuning in a Preset Station	14	Assigning Titles to MDs	38
Receiving FM Stations with RDS	15	Assigning a Title Using the Unit	38
Changing the RDS Information	15	Assigning a Title Using the Remote Control	41
Searching for Programs by PTY Codes (PTY		Using the Timers	43
Search)	16	Using Recording Timer	43
Switching to a Program Type of Your Choice		Using Daily Timer	44
Temporarily	16	Using Sleep Timer	46
Temporarily	16	Timer Priority	46
Playing Back CDs	19	Maintenance	47
Loading CDs	19	Additional Information	48
Playing Back the Entire Discs		MD Disc Types	48
— Continuous Play	20	ATRAC (Adaptive TRansform Acoustic Coding) ..	48
Basic CD Operations	20	UTOC (User Table Of Contents)	48
Programming the Playing Order of the Tracks		Serial Copy Management System (SCMS)	48
— Program Play	20	Sound Skip Guard Memory	49
Playing at Random — Random Play	22	Troubleshooting	50
Repeating Tracks or CDs — Repeat Play	22	MD Messages	51
Prohibiting Disc Ejection — Disc Lock	22	Specifications	52

Location of the Buttons and Controls

Become familiar with the buttons and controls on your unit.

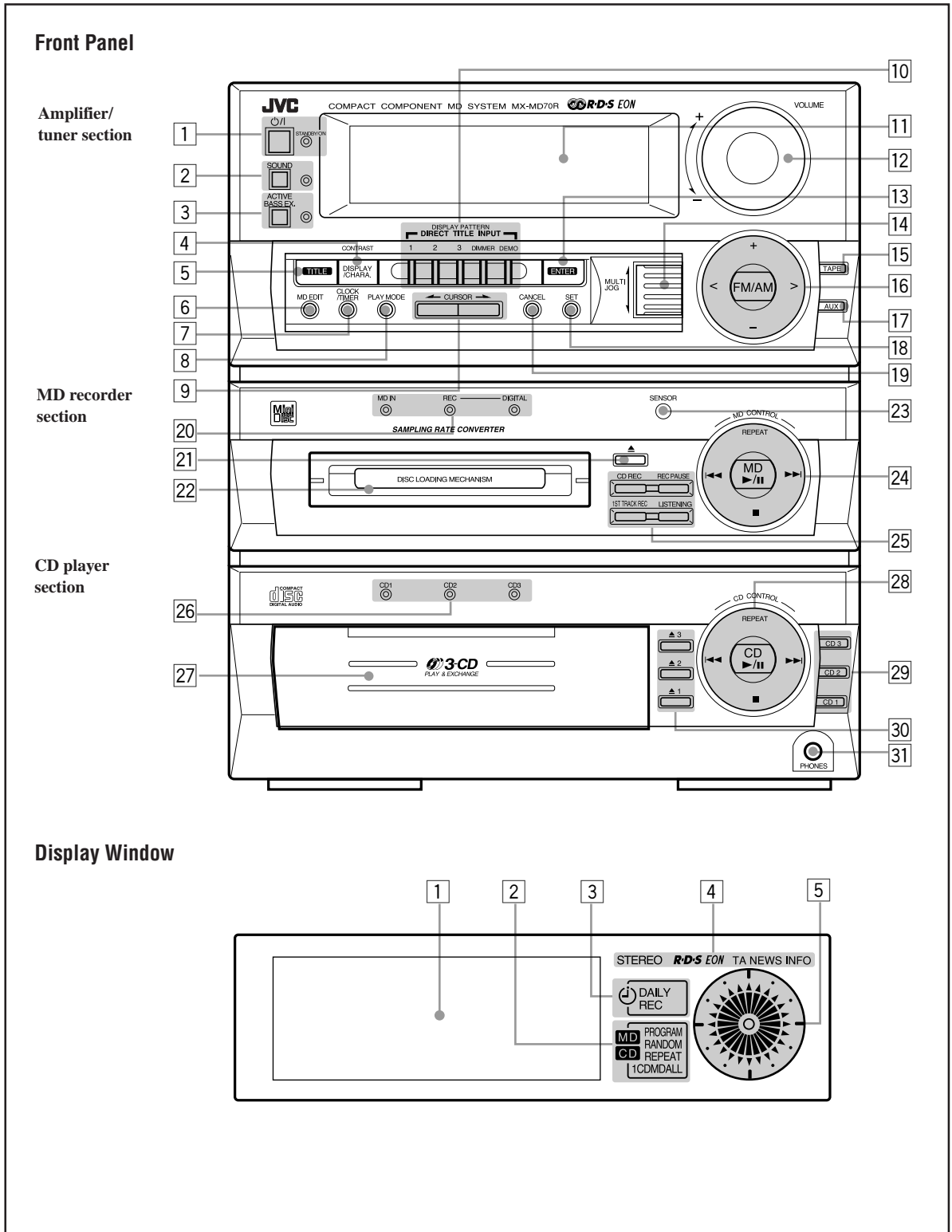

See pages in the parentheses for details.

Front Panel

Amplifier/tuner section

- 1 \odot /I button and STANDBY/ON lamp (11)
- 2 SOUND button and lamp (12)
- 3 ACTIVE BASS EX. (extension) button and lamp (12)
- 4 CONTRAST/DISPLAY/CHARA. (character) button (10, 24, 38)
- 5 TITLE button (38)
- 6 MD EDIT button (33)
- 7 CLOCK/TIMER button (10, 43)
- 8 PLAY MODE button (20, 22, 24, 26)
- 9 CURSOR \leftarrow / \rightarrow buttons (12, 39)
- 10 DISPLAY PATTERN buttons (10)
 - 1, 2, 3, DIMMER, and DEMO buttons

Pressing DEMO also turns on the unit.
- DIRECT TITLE INPUT buttons (39)
- 11 Display window
- 12 VOLUME control (11)
- 13 ENTER button (39)
- 14 MULTI JOG dial
- 15 TAPE button (11)

Pressing this button also turns on the unit.
- 16 Tuner control buttons (13)
 - FM/AM, + / -, and < / > buttons

Pressing FM/AM also turns on the unit.
- 17 AUX button (11, 29)

Pressing this button also turns on the unit.
- 18 SET button
- 19 CANCEL button

MD recorder section

- 20 MD recorder operation lamps
 - MD IN, REC, and DIGITAL lamps
- 21 \blacktriangle (eject) button (23)

Pressing this button also turns on the unit.
- 22 MD loading slot
- 23 SENSOR (remote sensor)
- 24 MD CONTROL buttons (23)
 - MD \blacktriangleright /II, REPEAT, I \blacktriangleleft / \blacktriangleright I, and ■ buttons

Pressing MD \blacktriangleright /II also turns on the unit.
- 25 Recording buttons (28 – 31)
 - CD REC, REC PAUSE, 1ST TRACK REC, and LISTENING buttons

CD player section

- 26 Disc number lamps
 - CD 1, CD 2, and CD 3 lamps
- 27 Disc compartment
- 28 CD CONTROL buttons (19)
 - CD \blacktriangleright /II, REPEAT, I \blacktriangleleft / \blacktriangleright I, and ■ buttons

Pressing CD \blacktriangleright /II also turns on the unit.
- 29 Disc number buttons (20)
 - CD 1, CD 2, and CD 3 buttons

Pressing one of these buttons also turns on the unit.
- 30 \blacktriangle (open/close) buttons (19)
 - \blacktriangle 1, \blacktriangle 2, and \blacktriangle 3 buttons

Pressing one of these buttons also turns on the unit.
- 31 PHONES jack (11)

Display window

- 1 Main display
- 2 MD/CD playback mode indicators
 - PROGRAM, RANDOM, REPEAT mode indicators
- 3 Timer mode indicators
 - DAILY (daily timer) and REC (recording timer) indicators
- 4 Tuner mode indicators
 - STEREO, RDS, EON, and TA/NEWS/INFO indicators
- 5 Analog clock



About the indications in the main display

When operating the unit using the remote control, the indications in the main display appear enlarged (without the audio level indicator), then become diminished (with the audio level indicator). On the other hand, they do not appear enlarged when using the buttons on the unit.

Ex. When using the remote control

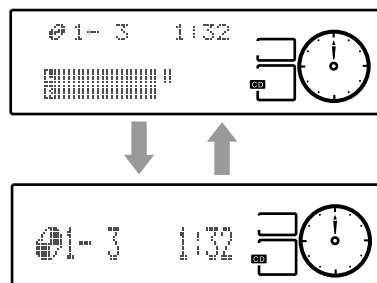

The illustrations of the main display used in this manual are of those shown by using the buttons on the unit.



Remote Control

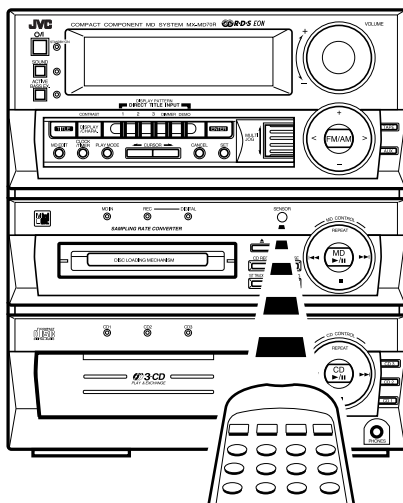
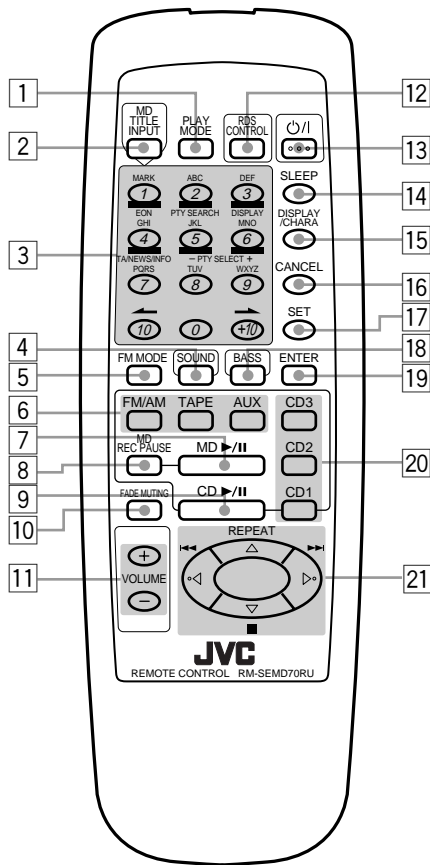

When using the remote control, point it at the remote sensor on the front panel.

Remote Control

- 1 PLAY MODE button (20, 22, 24, 26)
- 2 MD TITLE INPUT button (41)
- 3 Number buttons*
 - 1 – 10, +10 buttons (14, 20, 24)
 - Character entry buttons (A – Z) (41)
 - ← / → buttons (41)
 - RDS operation buttons (15):
EON, PTY SEARCH, DISPLAY, TA/NEWS/
INFO, PTY SELECT – / + buttons
- 4 SOUND button (12)
- 5 FM MODE button (13)
- 6 Source selecting buttons (11, 13, 29)
 - FM/AM, TAPE, and AUX buttons
 - Pressing one of these buttons also turns on the unit.*
- 7 MD ►/|| button (23)
 - Pressing this button also turns on the unit.*
- 8 MD REC PAUSE button (29)
- 9 CD ►/|| button (19)
 - Pressing this button also turns on the unit.*
- 10 FADE MUTING button (11)
- 11 VOLUME + / – button (11)
- 12 RDS CONTROL button (15)
- 13 ⏻/⏷ button (11)
- 14 SLEEP button (46)
- 15 DISPLAY/CHARA (character) button (24, 38)
- 16 CANCEL button
- 17 SET button
- 18 BASS button (12)
- 19 ENTER button (39)
- 20 Disc number buttons (20)
 - CD 1, CD 2, and CD 3 buttons
 - Pressing one of these buttons also turns on the unit.*
- 21 CD/MD/tuner control buttons*
 - REPEAT, ◀◀ / ▶▶, ■, and ◀ / ▶ / △ / ▽ buttons

* Before using these buttons:

For tuner operations, press FM/AM on the remote control first.

For CD operations, press one of the disc number buttons (CD 1, CD 2, and CD 3) or CD ►/|| on the remote control first.

For MD operations, press MD ►/|| on the remote control first.

• *The number buttons are also used for the following:*

To operate RDS function, press RDS CONTROL on the remote control first.

To enter an MD title, press MD TITLE INPUT on the remote control first.



To operate the unit correctly using the remote control

Make sure that the operation mode for the unit is the same for the remote control.

Unpacking

After unpacking, check to be sure that you have all the following items.

The number in the parentheses indicates the quantity of the pieces supplied.

- AM loop antenna (1)
- FM antenna (1)
- Remote control (1)
- Batteries (2)

If any is missing, consult your dealer immediately.

Putting the Batteries into the Remote Control

Insert the batteries — R6P(SUM-3)/AA(15F) — into the remote control, by matching the polarity (+ and -) on the batteries with the + and - markings on the battery compartment.

When the remote control can no longer operate the unit, replace both batteries at the same time.

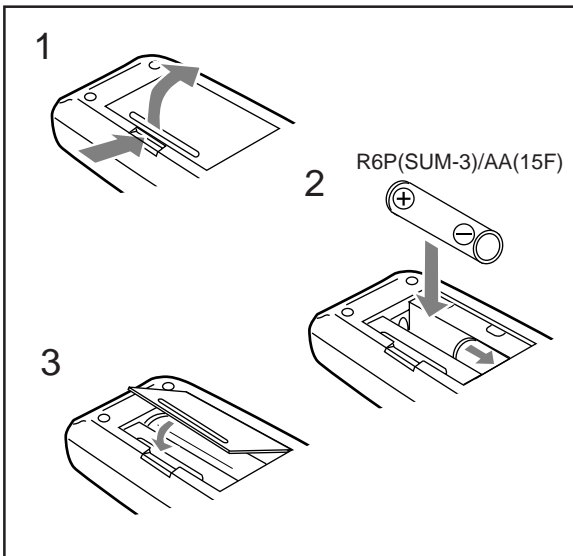

- DO NOT use an old battery together with a new one.
- DO NOT use different types of batteries together.
- DO NOT expose batteries to heat or flame.
- DO NOT leave the batteries in the battery compartment when you are not going to use the remote control for an extended period of time. Otherwise, it will be damaged from battery leakage.

Connecting Antennas

FM antenna

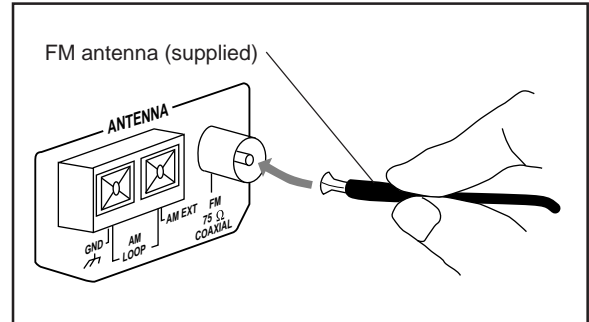

- 1 Attach the FM antenna to the FM 75 Ω COAXIAL terminal.
- 2 Extend the FM antenna.
- 3 Fasten it up in the position which gives you the best reception.



About the supplied FM antenna

The FM antenna supplied with this unit can be used as temporary measure. If reception is poor, you can connect an outside FM antenna.

To connect an outside FM antenna

Before connecting it, disconnect the supplied FM antenna.

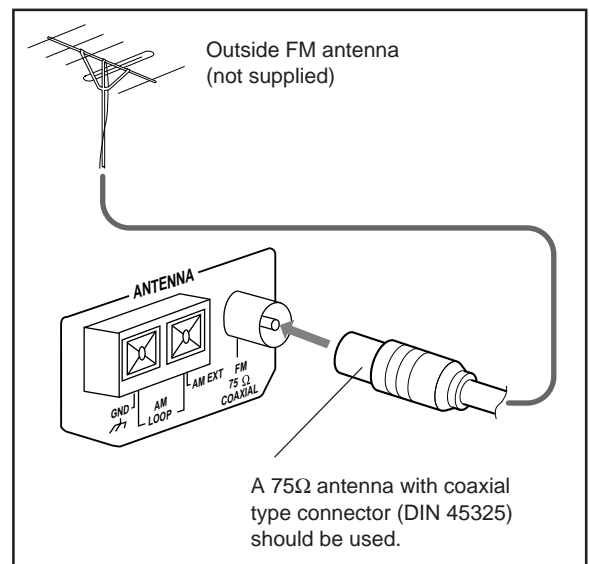

AM antenna

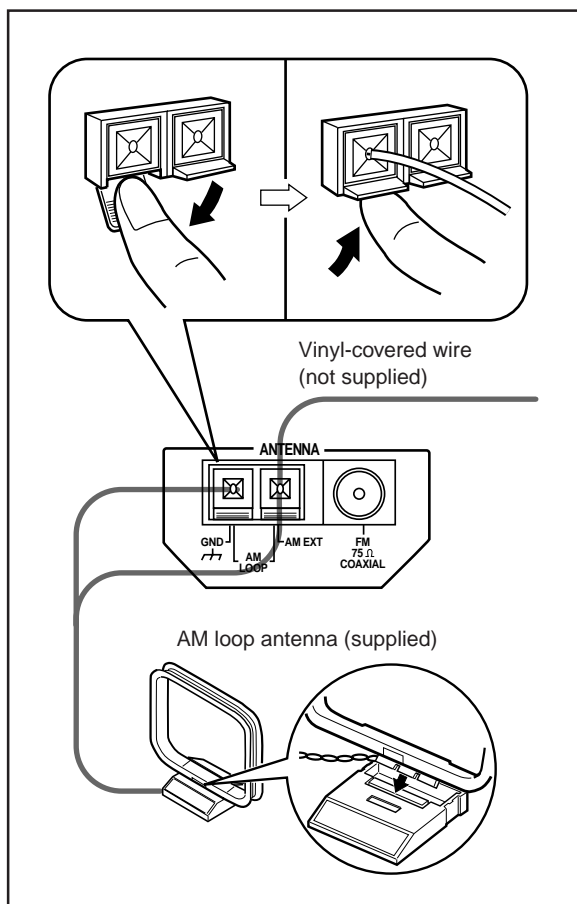

- 1 Connect the AM loop antenna to the AM LOOP terminals as illustrated.
- 2 Turn the AM loop antenna until you have the best reception.

To connect an outside AM antenna

When reception is poor, connect a single vinyl-covered wire to the AM EXT terminal and extend it horizontally. (The AM loop antenna must remain connected.)



For better reception of both FM and AM

- Make sure the antenna conductors do not touch any other terminals and connecting cords.
- Keep the antennas away from metallic parts of the unit, connecting cords, and the AC power cord.

Connecting Speakers

You can connect the speakers using the speaker cords.

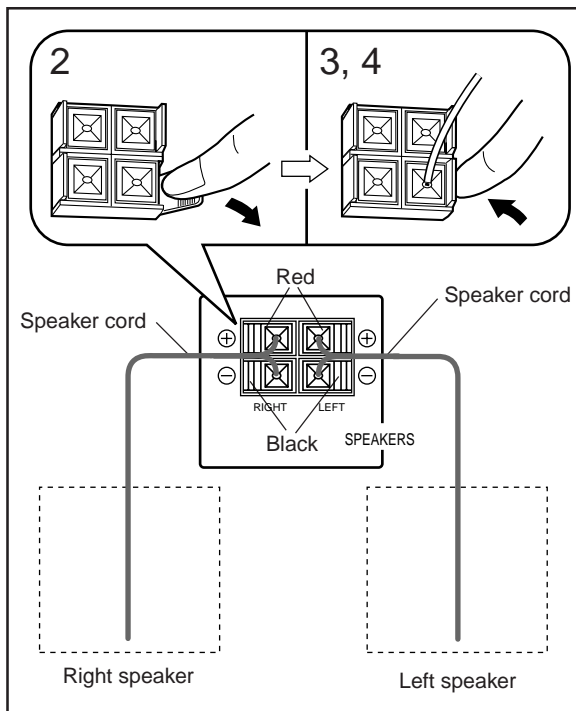

- 1 Twist the core of the cord at the end of each cord, then remove the insulation.
- 2 Open the speaker terminal.
- 3 Insert the end of the speaker cord to the terminal. Match the polarity of the speaker terminals: Red (+) to red (+) and black (-) to black (-).
- 4 Close the speaker terminal on the rear of the unit.

Use only speakers with the same speaker impedance as indicated by the speaker terminals on the rear of the unit.

Connecting Other Equipment

You can connect the following equipment to this unit:

- Cassette deck — used as a playback and recording device.
- Audio equipment — used only as an analog playback device.
- Audio equipment with an optical digital output terminal — used only as a digital playback device.

When you connect and use these equipment, refer also to the manuals supplied with them.

Be sure that the plugs of the audio cords and the jacks on the rear of the unit are color coded: White plugs and jacks are for left audio signals, and red ones for right audio signals.



- DO NOT connect other equipment while the power is on.
- DO NOT plug in any equipment until all connections are complete.

To connect a cassette deck

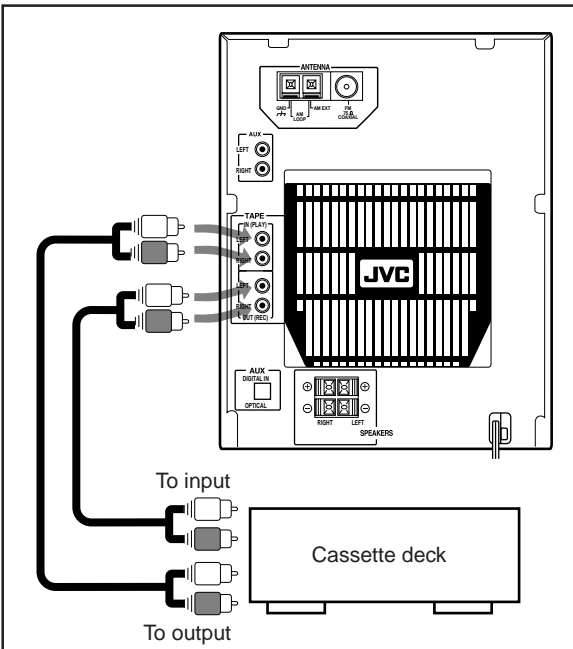

By using audio cords (not supplied), connect:

- Between the audio input jacks on the cassette deck and the TAPE OUT (REC) jacks.
- Between the audio output jacks on the cassette deck and the TAPE IN (PLAY) jacks.

To connect audio equipment without a digital output terminal

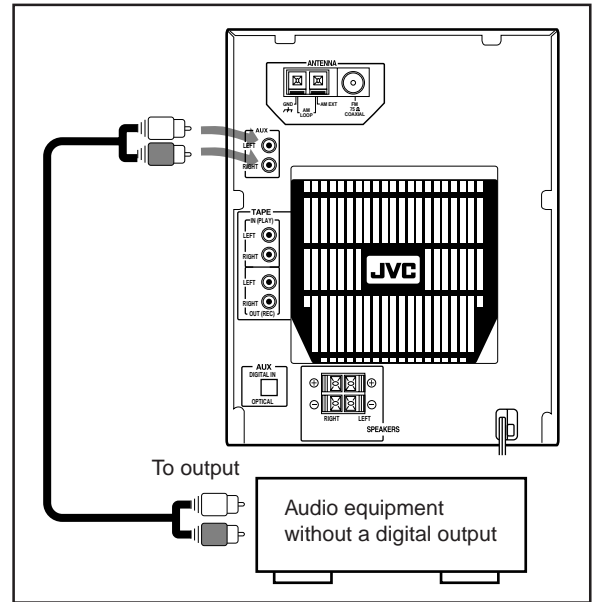

Connect the audio output jacks on the other equipment and the AUX jacks, using an audio cord (not supplied).

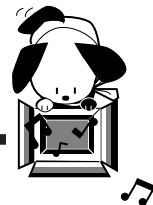

To connect audio equipment with an optical digital output terminal

NOW, you can plug in the unit and other connected equipment **FINALLY!**

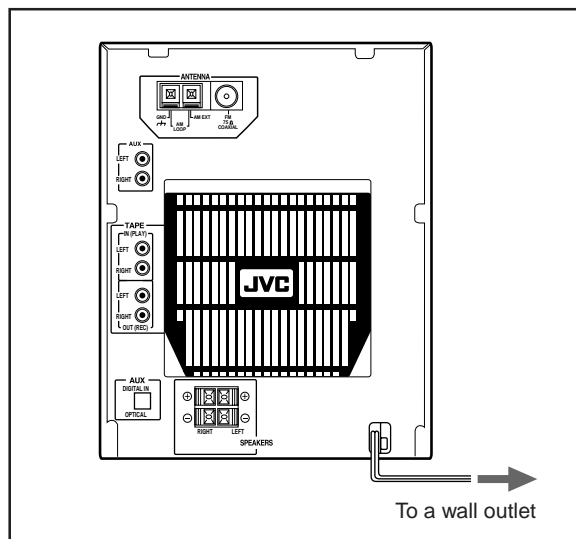
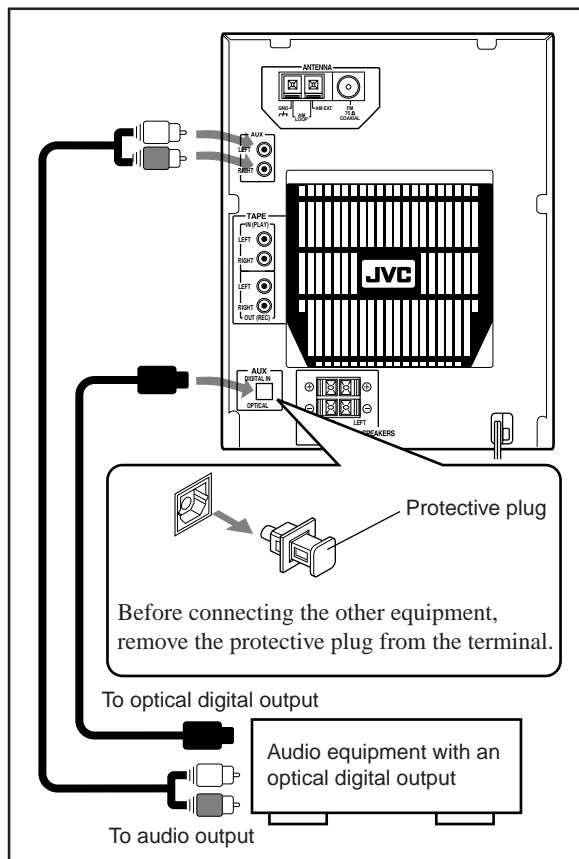

When connecting the AC power cord into a wall outlet, the unit automatically starts display demonstration.

To stop the display demonstration, press any button on the unit or the remote control.

By using both an optical digital cord (not supplied) and an audio cord (not supplied), connect:

- Between the optical digital output terminal on the other equipment and the AUX DIGITAL IN OPTICAL terminal.
- Between the audio output jacks on the other equipment and the AUX jacks.



Amplifier/Tuner

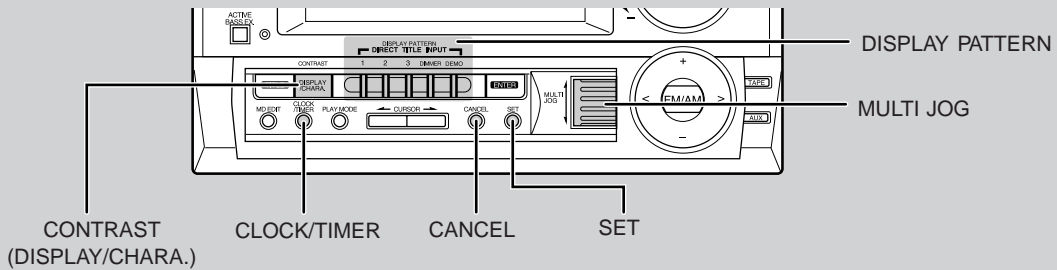

Before operating the unit any further, first set the clock built in this unit, then some other basic settings.

Setting the Clock

You can set the clock whether the unit is turned on or in standby mode.

1 Press CLOCK/TIMER.

The hour digit in the main display starts flashing.



2 Rotate MULTI JOG to adjust the hour, then press SET.

- If you want to correct the hour after pressing SET, press CANCEL. The hour digit starts flashing again.



3 Rotate MULTI JOG to adjust the minute, then press SET.



After completing the clock setting...

The analog clock in the display window shows the current time. This analog clock advances its long hand twice every 5 minutes. (When 3 minutes pass, it advances once. Then 2 minutes pass, it advances again.)



If there is a power failure



The clock loses the setting and is reset to "0:00." You need to set the clock again.

Changing the Display Pattern

To change the display pattern of the audio level indicator

The audio level indicator appears in the main display only while playing a source.

Press 1, 2 or 3.

- 1: For the following pattern: 
- 2: For the following pattern: 
- 3: For erasing the audio level indicator:
The audio level indicator is not shown, and other indications — the disc number or track number, playing time — become enlarged in the main display. **To restore the previous audio level indicator, press 3 again.** (The other indications in the main display are diminished.)

To dim the display window

Press DIMMER.

Each time you press the button, the display window and the MULTI JOG dial dim and brighten alternately.

To start the display demonstration

Press DEMO.

- If the unit is in standby mode, the power turns on automatically.

To stop the demonstration, press any button. "DEMO OFF" appears.

To adjust the contrast of the display window

1 Press and hold CONTRAST (DISPLAY/CHARA.) for more than 2 seconds.

The contrast adjustment display appears.

2 Rotate MULTI JOG to adjust the contrast.

After completing contrast adjustment...

Pressing any button restores the previous display.

Common Operations

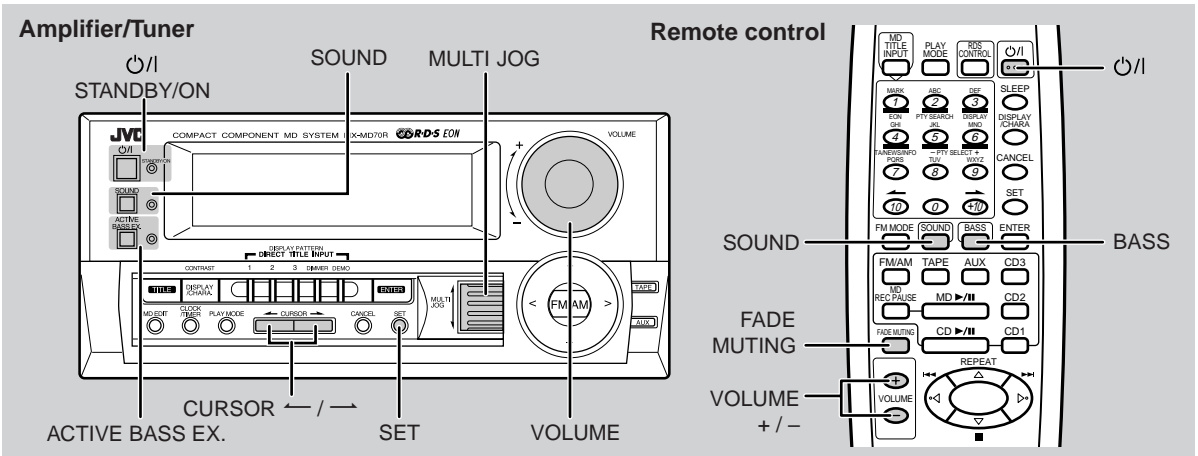

Here are basic and common things that apply to all the functions of the unit.

Turning On the Power and Selecting the Sources

When you press the play button for a particular source, the unit automatically turns on (and starts playing the source).

To select the external equipment as the source, press TAPE or AUX so that the unit automatically turns on.

To turn on the unit without playing, press O/I so that the STANDBY/ON lamp lights orange.

To turn off the unit (on standby), press O/I again so that the STANDBY/ON lamp lights red.

A little power is always consumed even while the unit is in standby mode.

To switch off the power supply completely, unplug the AC power cord from the AC outlet.

The STANDBY/ON lamp goes off.



When you unplug the AC power cord or if a power failure occurs

The clock is reset to 0:00 right away, while the tuner preset stations will be erased in a few days.

Adjusting the Volume

You can adjust the volume level only while the unit is turned on.

Turn VOLUME clockwise to increase the volume or counterclockwise to decrease it.

When using the remote control, press VOLUME + to increase the volume or press VOLUME - to decrease it.



For private listening

Connect a pair of headphones to the PHONES jack. No sound comes out of the speakers. Be sure to turn down the volume before connecting or putting headphones.

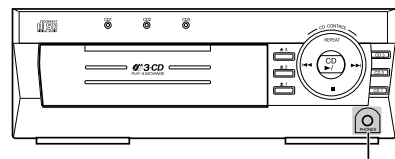

PHONES jack



DO NOT turn off (on standby) the unit with the volume set to an extremely high level; otherwise, the sudden blast of sound can damage your hearing, speakers and/or headphones when you turn on the unit or start playing any source.

REMEMBER you cannot adjust the volume level while the unit is in standby mode.

To turn down the volume level temporarily

Press FADE MUTING on the remote control.

To restore the sound, press the button again.



Reinforcing the Bass Sound

The richness and fullness of the bass sound is maintained regardless of how low you set the volume.

You can use this effect only for playback.

To get the effect, press ACTIVE BASS EX. (extension) on the unit or BASS on the remote control so that the ACTIVE BASS EX. lamp lights on the unit.

ACTIVE BASS
EX. ON

(In the main display)

To cancel the effect, press the button again so that the lamp goes off.

Selecting the Sound Modes

You can select one of the 6 preset sound modes. The sound modes can be applied only to playback sounds, and cannot be used for recording.

To select the sound modes, press SOUND so that the SOUND lamp lights on the unit.

- Each time you press the button, the sound modes change as follows:

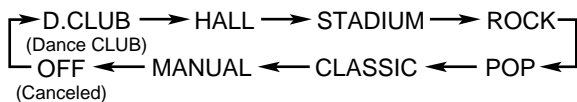

- D.CLUB:** Increases resonance and bass.
- HALL:** Adds depth and brilliance to the sound.
- STADIUM:** Adds clarity and spreads the sound, like in an outdoor stadium.
- ROCK:** Boosts low and high frequency. Good for acoustic music.
- POP:** Good for vocal music.
- CLASSIC:** Good for classical music.
- MANUAL:** Your individual mode stored in memory. See "Creating Your Own Sound Mode — MANUAL Mode."
- OFF:** Cancels the sound mode.

Creating Your Own Sound Mode — MANUAL Mode

You can create and store your own sound mode only by using the buttons and controls on the unit.

- There is a time limit in doing the following steps. If the setting is canceled before you finish, start from step 1 again.

1 Press SOUND repeatedly until "MANUAL" appears in the main display.

MANUAL

Equalizer pattern



2 Press SET.

LOW 0

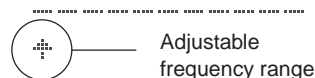

3 Adjust the equalizer pattern.

- 1) Press CURSOR ← / → to select the frequency range to adjust (LOW, MID, HIGH).
- 2) Rotate MULTI JOG to adjust the level (-3 to +3) of the selected frequency range.

HIGH +2

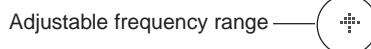

- 3) Repeat steps 1) and 2) to adjust the level of the other frequency ranges.

4 Press SET again.

The equalizer pattern you have created are stored in memory.

MANUAL



To use your own sound mode

Select MANUAL when using the sound modes. See "Selecting the Sound Modes."

Listening to FM and AM Broadcasts

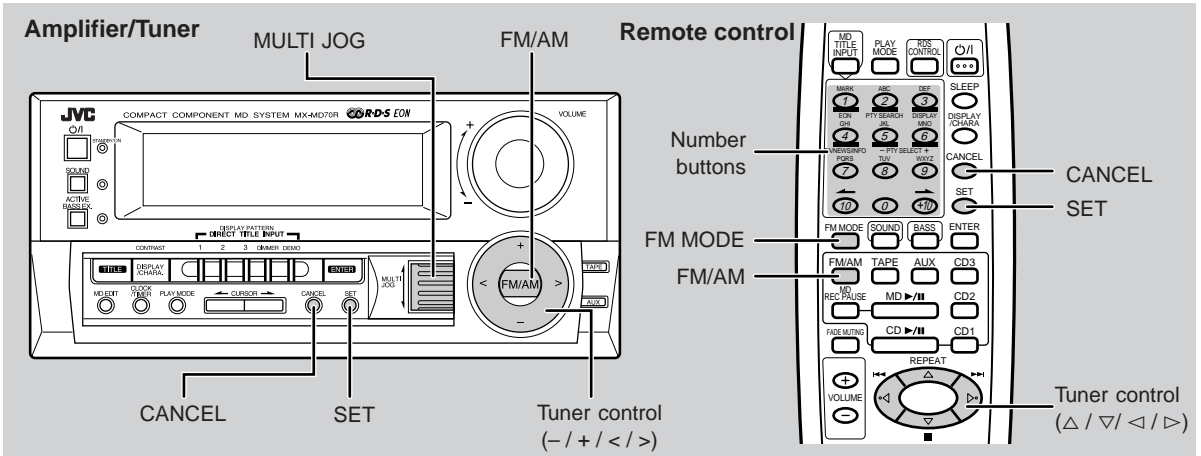

When using the number buttons on the remote control, make sure that they are ready for tuner operations.

- Pressing FM/AM on the remote control makes the number buttons ready for tuner operations.

Tuning in a Station

1 Press FM/AM.

The unit automatically turns on and tunes in the previously tuned station (either FM or AM).

- Each time you press the button, the band alternates between FM and AM.

2 On the unit:

Press and hold + or – of the tuner control buttons.

On the remote control:

Press and hold Δ or ∇ of the tuner control buttons.

The unit starts searching stations and stops when a station of sufficient signal strength is tuned in.

If a program is broadcast in stereo, the STEREO indicator also lights.

To stop during searching, press + / – (or Δ / ∇) of the tuner control buttons again.



notes When you press + / – (or Δ / ∇) briefly and repeatedly

The frequency changes step by step.

To change the FM reception mode

When an FM stereo broadcast is hard to receive or noisy, press FM MODE on the remote control so that “MONO” appears in the main display. Reception improves.

To restore the stereo effect, press FM MODE again so that “AUTO” appears in the main display.

In this stereo mode, you can hear stereo sounds when a program is broadcast in stereo.

Presetting Stations

You can preset 30 FM and 15 AM (MW/LW) stations at random.

In some cases, test frequencies have been already memorized for the tuner since the factory examined the tuner preset function before shipment. This is not a malfunction. You can preset the stations you want into memory by following the presetting method.

- There is a time limit in doing the following steps. If the setting is canceled before you finish, start from step 1 again.

1 Tune in the station you want to preset.

- See “Tuning in a Station.”

FM 1 87.50

2 Press SET.

The current preset number starts flashing.

FM 1 87.50



3 Select a preset number.

On the unit:

Rotate **MULTI JOG**, or press < or > of the tuner control buttons.

On the remote control:

Press < or > of the tuner control buttons.

- You can also use the number buttons. (Make sure that you have pressed FM/AM on the remote control before pressing the Number buttons.)

For preset number 5, press 5.

For preset number 15, press +10 then 5.

For preset number 20, press +10, then 10.

For preset number 30, press +10, +10, then 10.

4 Press SET again.

The tuned station in step 1 is stored in the preset number selected in step 3.

- Storing a new station on a used number erases the previously stored one.

```
FM12  87.50
└───┬───┘
    MEMORY
```

“MEMORY” does not appear if you press SET on the remote control.



When you unplug the AC power cord or if a power failure occurs

The preset stations will be erased in a few days. If this happens, preset the stations again.

Tuning in a Preset Station

1 Press FM/AM.

The unit automatically turns on and tunes in the previously tuned station (either FM or AM).

- Each time you press the button, the band alternates between FM and AM.

2 Select a preset number.

On the unit:

Rotate **MULTI JOG**, or press < or > of the tuner control buttons.

On the remote control:

Press < or > of the tuner control buttons.

- You can also use the number buttons. (Make sure that you have pressed FM/AM on the remote control before pressing the Number buttons.)

For preset number 5, press 5.

For preset number 15, press +10 then 5.

For preset number 20, press +10, then 10.

For preset number 30, press +10, +10, then 10.

To erase a preset station

The following procedure is only possible on the unit.

1 Select a preset station number you want to erase.

2 Press CANCEL.

The preset number starts flashing in the main display.

3 Press SET.

“CANCEL” appears in the main display, and the station frequency stored in the preset number is erased.

Receiving FM Stations with RDS

Remote control

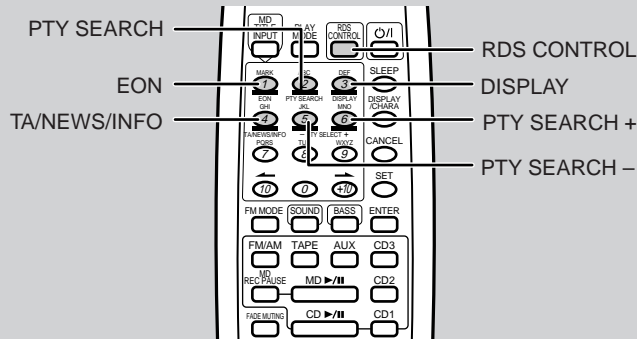

RDS allows FM stations to send an additional signal along with their regular program signals. For example, the stations send their station names, as well as information about what type of program they broadcast, such as sports or music, etc.

When tuned to an FM station which provides the RDS service, the RDS indicator lights up on the display.

With the unit, you can receive the following types of RDS signals.

PS (Program Service):

Shows commonly known station names.

PTY (Program Type):

Shows types of broadcast programs.

RT (Radio Text):

Shows text messages the station sends.

EON (Enhanced Other Networks):

Provides the information about the types of the programs sent by other RDS stations than the one being received.



More about RDS

- Not all FM stations provide RDS signals, nor do all RDS stations provide the same services. If in doubt, check with local radio stations for details on RDS in your area.
- RDS may not work correctly if the received station is not transmitting the signals properly or if the signal strength is weak.

Changing the RDS Information

You can see RDS information on the display while listening to an FM station.

- RDS operations are possible only using the remote control.

1 Press **RDS CONTROL**.

2 Press **DISPLAY**.

- Each time you press the button, the display changes to show the following information:

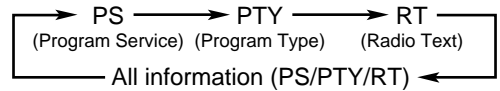

If No PS, PTY, or RT signals are sent by a station "NO PS," "NO PTY" or "NO RT" appears in the main display.



If the unit takes time to show the RDS information received from a station

"WAIT PS", "WAIT PTY", or "WAIT RT" may appear on the display.

Searching for Programs by PTY Codes (PTY Search)

One of the advantages of RDS is that you can locate a particular kind of program by specifying the PTY codes.

- The PTY Search is applicable only to preset stations.
- There is a time limit in doing the following steps. If the setting is canceled before you finish, start from step 1 again.

To search for a program using the PTY codes, use the remote control:

1 Press **RDS CONTROL**.

2 Press **PTY SEARCH**.

“PTY SELECT” flashes in the main display.

3 Press **PTY SELECT - / +** to select a PTY code while “PTY SELECT” is flashing.

Each time you press the button, the PTY codes change as follows (refer also to the list on page 18):

NEWS ⇄ AFFAIRS ⇄ INFO ⇄ SPORT ⇄ EDUCATE ⇄ DRAMA ⇄ CULTURE ⇄ SCIENCE ⇄ VARIED ⇄ POP M ⇄ ROCK M ⇄ M.O.R. M ⇄ LIGHT M ⇄ CLASSICS ⇄ OTHER M ⇄ WEATHER ⇄ FINANCE ⇄ CHILDREN ⇄ SOCIAL A ⇄ RELIGION ⇄ PHONE IN ⇄ TRAVEL ⇄ LEISURE ⇄ JAZZ ⇄ COUNTRY ⇄ NATIONAL ⇄ OLDIES ⇄ FOLK M ⇄ DOCUMENT ⇄ TRAFFIC ⇄ NONE ⇄ (back to the beginning)

4 Press **PTY SEARCH** again.

While searching, “SEARCH” and the selected PTY code alternate on the display.

The unit searches 30 preset FM stations, stops when it finds the one you have selected, and tunes in that station.

To continue searching after the first stop:

Press PTY SEARCH again while the indications on the display are flashing.

If no program is found, “NOT FOUND” appears on the display and the unit returns to the last received station.

To stop searching any time during the process:

Press PTY SEARCH while searching.

Switching to a Program Type of Your Choice Temporarily

The EON function allows the unit to switch temporarily to a broadcast program of your choice (NEWS, TA, and/or INFO) from a different station except when you are listening to a non-RDS stations – some FM stations and AM (MW/LW) stations.

- The EON indicator lights while receiving a station with the EON code.
- EON function is applicable only to preset stations.

To activate the EON function, use the remote control:

1 Press **RDS CONTROL**.

2 Press **EON**.

The last EON data type selected — TA/NEWS/INFO — lights on the display window.

3 Press **TA/NEWS/INFO** repeatedly until the EON data type you want is selected.

Each time you press the button, the EON data types change as follows:

TA NEWS INFO → TA → NEWS → INFO → TA NEWS → NEWS INFO → TA INFO → (back to the beginning)
--

TA: Traffic announcement

NEWS: News

INFO: Program the purpose of which is to impart advice in the widest sense.

To cancel the EON function, press EON again so that the TA/NEWS/INFO indicator goes off.

- If you cancel the EON function while receiving a program selected by the EON function, the unit goes back to the previously tuned station.

Continued

How the EON function actually works:**CASE 1****If there is no station broadcasting the program you have selected**

The unit continues tuning in the current station.



When a station starts broadcasting the program you have selected, the unit automatically switches to the station. The indicator of received PTY code starts flashing.



When the program is over, “EON END” appears in the main display, and the unit goes back to the previously tuned station, but the EON function still remains activated.

CASE 2**If there is a station broadcasting the program you have selected**

The unit tunes in the program. The indicator of received PTY code starts flashing.



When the program is over, “EON END” appears in the main display, and the unit goes back to the previously tuned station, but the EON function still remains activated.

CASE 3**If the FM station you are listening to is broadcasting the program you have selected**

The unit continues to receive the station but the indicator of received PTY code starts flashing.



When the program is over, the indicator of received PTY code stops flashing and remains lit, but the EON function still remains activated.

**More about the EON function**

- EON data sent from some stations may not be compatible with this unit.
- While listening to a program tuned in by the EON function, the station does not change even if another network station starts broadcasting a program of the same EON data.
- While listening to a program tuned in by the EON function, you can only use the EON and DISPLAY buttons as the tuner operation buttons.
- If the stations alternate intermittently between the station tuned by the EON function and the currently tuned station (“WAITING” flashes in the main display), press EON to cancel the EON function.
If you do not press the button, the currently tuned station is received finally, and the indication of the EON data type flashing on the display disappears.
- While receiving a station with the EON code (the EON indicator lights on the display window), you cannot erase a preset station.

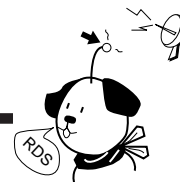
**Description of the PTY codes:**

NEWS:	News.
AFFAIRS:	Topical program expanding or enlarging upon the news — debate, or analysis.
INFO:	Program the purpose of which is to impart advice in the widest sense.
SPORT:	Program concerned with any aspect of sports.
EDUCATE:	Educational programs.
DRAMA:	All radio plays and serials.
CULTURE:	Programs concerning any aspect of national or regional culture, including language, theatre, etc.
SCIENCE:	Programs about natural sciences and technology.
VARIED:	Used for mainly speech-based programs like quizzes, panel games and personality interviews.
POP M:	Commercial music of current popular appeal.
ROCK M:	Rock music.
M.O.R. M:	Current contemporary music considered to be “easy-listening.”
LIGHT M:	Instrumental music, and vocal or choral works.
CLASSICS:	Performances of major orchestral works, symphonies, chamber music, etc.
OTHER M:	Music not fitting into any of the other categories.
WEATHER:	Weather reports and forecasts.

FINANCE:	Stock Market reports, commerce, trading etc.
CHILDREN:	Programs targeted at a young audience.
SOCIAL A:	Programs about sociology, history, geography, psychology and society.
RELIGION:	Religious programs.
PHONE IN:	Involving members of the public expressing their views either by phone or at a public forum.
TRAVEL:	Travel information.
LEISURE:	Programs about recreational activities.
JAZZ:	Jazz music.
COUNTRY:	Songs which originate from, or continue the musical tradition of the American Southern States.
NATIONAL:	Current popular music of the nation or region in that country’s language.
OLDIES:	Music from the so-called “golden age” of popular music.
FOLK M:	Music which has its roots in the musical culture of a particular nation.
DOCUMENT:	Program concerning factual matters, presented in an investigative style.
TRAFFIC:	Traffic announcement.
NONE:	Undefined.

Classification of the PTY codes for some FM stations may be different from the above list.

Playing Back CDs

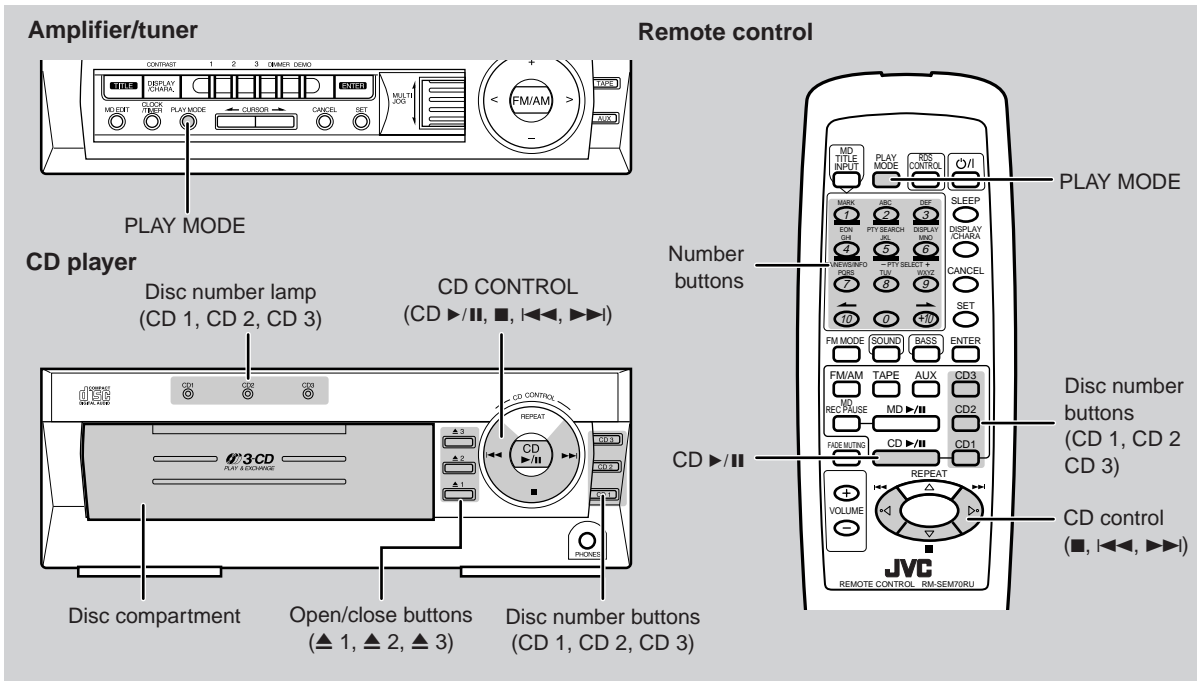

When using the remote control, make sure that it is ready for CD operations.

- Pressing CD 1, CD 2, CD 3, or CD ►/II on the remote control makes the remote control ready for CD operations.

3 Press the same open/close button (▲ 1 to ▲ 3) you have pressed in step 1.

The disc compartment closes, and the corresponding disc number lamp (CD 1 to CD 3) lights.

4 Repeat steps 1 to 3 to place other CDs.



When loading more than one CD continuously
Press the open/close button (▲ 1 to ▲ 3) for the next tray you want to place a CD onto, the disc compartment automatically closes and then opens with the next tray on the top.



About the disc number lamps (CD 1 to CD 3)
Each disc number lamp corresponds to the disc tray of the same number.

- It lights orange when the unit has recognized that there is a CD on the corresponding disc tray.
- It lights green when a CD on the corresponding disc tray is selected as the current disc or played back.

Loading CDs

1 Press one of the open/close buttons (▲ 1 to ▲ 3) for the disc tray (CD 1 to 3) you want to load a CD onto.

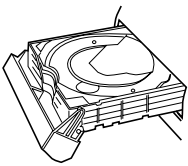

The unit automatically turns on and the disc compartment comes out with the specified disc tray on the top.

○ CD1 OPEN

2 Place a disc correctly on the circle of the disc tray, with its label side up.

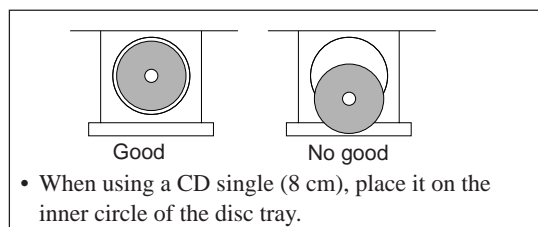

Playing Back the Entire Discs — Continuous Play

You can play CDs continuously.

- 1 Load CDs.
- 2 Press one of the disc number buttons (CD 1, CD 2 and CD 3) for the disc you want to play.
CD playback starts from the first track of the selected disc.



 Disc No. Track No. Elapsed playing time

- Pressing CD ►/|| instead of the disc number buttons starts playing back the CD whose disc number lamp lights green.

To stop during play, press ■ of the CD control.

To remove the disc, press the corresponding open/close buttons (▲ 1 to ▲ 3).



CD playback sequence

When 3 CDs are loaded in the disc compartment, they are played in one of the following sequences.

- When CD 1 is pressed : CD 1 ⇒ CD 2 ⇒ CD 3 (then stops)
- When CD 2 is pressed : CD 2 ⇒ CD 3 ⇒ CD 1 (then stops)
- When CD 3 is pressed : CD 3 ⇒ CD 1 ⇒ CD 2 (then stops)

* When only 2 CDs are loaded, they are played in the same order, but the disc tray without a CD is skipped.

Basic CD Operations

While playing a CD, you can do the following operations.

To exchange CDs during playback of another

Press the open/close button (▲ 1 to ▲ 3) corresponding to a disc number whose disc number lamp is lit orange to eject that disc tray and exchange the CD.

When CDs are exchanged during playback, playback stops after playing the last exchanged CD.

To stop playback for a moment

Press CD ►/||.

To resume play, press CD ►/|| again.

To locate a particular point in a track

During play, press and hold ◀◀ or ▶▶ of the CD control.

- ◀◀ : Fast reverses the disc.
- ▶▶ : Fast forwards the disc.

To go to another track

Press ◀◀ or ▶▶ of the CD control repeatedly before or during playback.

- ◀◀ : Goes back to the beginning of the current or previous tracks.
- ▶▶ : Skips to the beginning of the next or succeeding tracks.

Rotating MULTI JOG on the unit also changes the tracks.

To go to another track directly using the number buttons

Pressing the number button(s) allows you to start playing the track number you want. (Make sure that you have pressed one of the following buttons — disc number buttons (CD 1, CD 2, CD 3) and CD ►/|| — on the remote control before using the number buttons.)

Ex.: For track number 5, press 5.

For track number 15, press +10 then 5.

For track number 20, press +10, then 10.

For track number 32, press +10, +10, +10, then 2.

Programming the Playing Order of the Tracks — Program Play

You can arrange the order in which the tracks play before you start playing. You can program up to 32 tracks.

- 1 Load discs.

- If the current playing source is not the CD player, press CD ►/||, then ■ of the CD control before going to the next step.

- 2 Press PLAY MODE so that “PROGRAM” appears in the main display.

- Each time you press the button, play mode changes as follows:

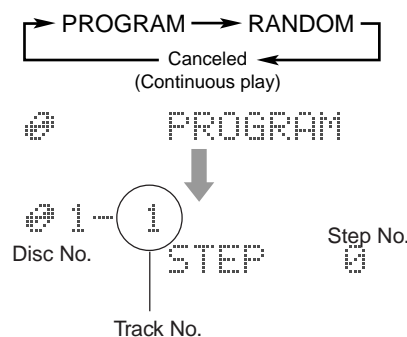

Continued

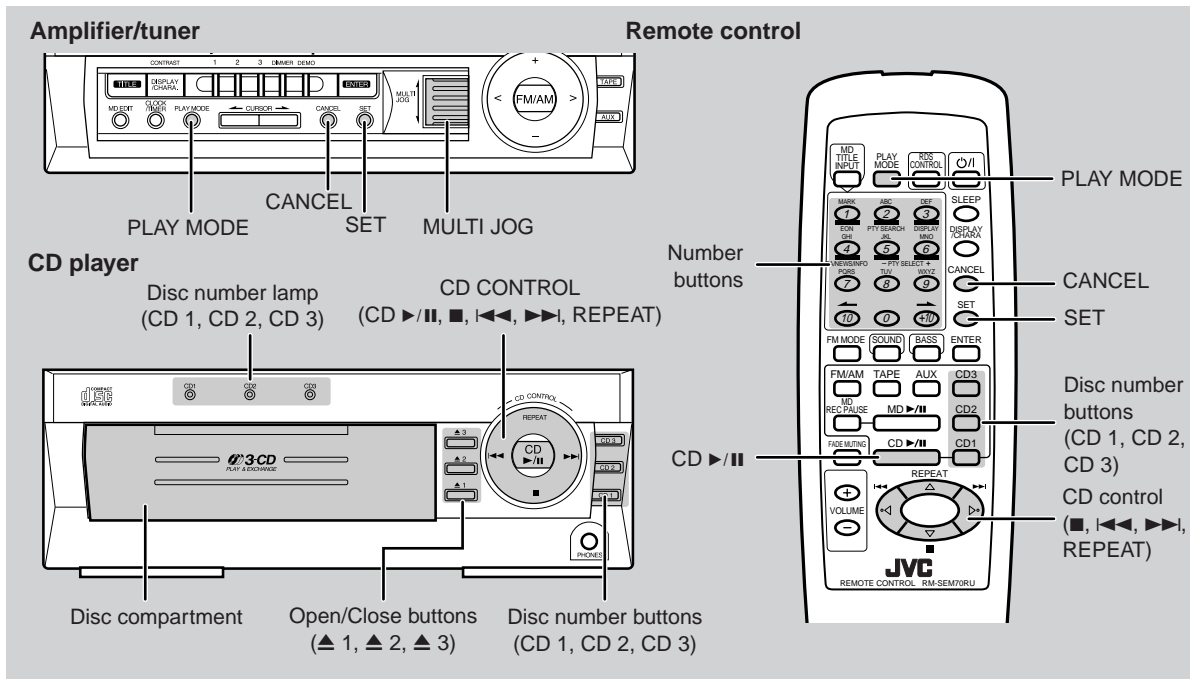

Continued

- 3** Press one of the disc number buttons (CD 1, CD 2, and CD 3) to select the disc number you want to play.



- 4** Select the track from the CD selected in the above step.

On the unit:

Rotate MULTI JOG to select the track number, then press SET.

On the remote control:

Press the number buttons.

- For how to use the number buttons, see "To go to another track directly using the number buttons" on page 20.

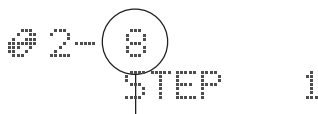

- 5** Program other tracks you want.

- To program tracks from the same disc, repeat step 4.
- To program tracks from a different disc, repeat steps 3 and 4.

- 6** Press CD ▶/||.

The tracks are played in the order you have programmed.

To stop during play, press ■ of the CD control.

To exit from program play mode, press PLAY MODE once or twice so that the unit enters another playback mode (Random play or Continuous play mode).

To check the program contents

Before playing, you can check the program contents by pressing ◀◀ or ▶▶ of the CD control.

- ▶▶: Shows the programmed tracks in the programmed order.
- ◀◀: Shows them in the reverse order.

To modify the program

Before playing, you can erase the last programmed track by pressing CANCEL.

Each time you press the button, the last programmed track is erased from the program.

To add tracks in the program before you start play, simply select track numbers you want to add.



If you try to program a 33rd step
“PROGRAM FULL” will appear in the main display.



If your entry is ignored
You have tried to program a track from an empty tray,
or a track number that does not exist on the CD (for example,
selecting track 14 on a CD that only has 12 tracks). Such entries
are ignored.

Playing at Random — Random Play

The tracks of all loaded CDs will play at random.

1 Prepare discs.

- If the current playing source is not the CD player,
press CD ►/II, then ■ of the CD control before going
to the next step.

2 Press PLAY MODE repeatedly until “RANDOM” appears in the main display.

- Each time you press the button, play mode changes
as follows:

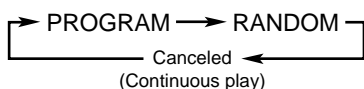

RANDOM

3 Press CD ►/II.

The tracks are played at random.

Random play ends when all the tracks are played once.

- Random play also ends when the disc compartment is
opened.

To stop during play, press ■ of the CD control.

To exit from Random play mode, press PLAY MODE
once or twice so that the unit enters another playback mode
(Continuous play or Program play mode).

Repeating Tracks or CDs — Repeat Play

You can have all the CDs, the program or the individual
track currently playing repeat as many times as you like.

To repeat play, press REPEAT during or before playing.
Each time you press the button, Repeat play mode changes
as follows, and appears in the main display:

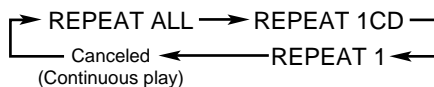

REPEAT ALL: Repeats all the tracks on all the CDs
(continuously or at random), or all the
tracks in the program.

REPEAT 1CD*: Repeats all the tracks on one CD.

REPEAT 1: Repeats one track on one CD.

- * REPEAT 1CD is not used for Program play and
Random Play.

To cancel Repeat play, press REPEAT repeatedly until no
REPEAT indication (REPEAT ALL, REPEAT 1CD, or
REPEAT 1) lights on the display window.

- REPEAT 1CD is also canceled when you press PLAY
MODE to change the play mode.

Prohibiting Disc Ejection — Disc Lock

You can prohibit CD and MD ejection from the unit and
can lock discs.

- This operation is only possible using the unit.

To prohibit disc ejection, press ▲ 1 while holding ■ of
the CD control with the unit set in standby mode.

“LOCKED” appears for a while, and the loaded discs (both
CDs and MD) are locked.

LOCKED



If you try to eject the locked discs

“LOCKED” appears to inform you that the Disc Lock is in use.

To cancel the prohibition and unlock the discs, press ▲ 1
again while holding ■ of the CD control with the unit set in
standby mode.

“UNLOCKED” appears for a while, and the loaded discs
(both CDs and MD) are unlocked.

UNLOCKED

Playing Back an MD

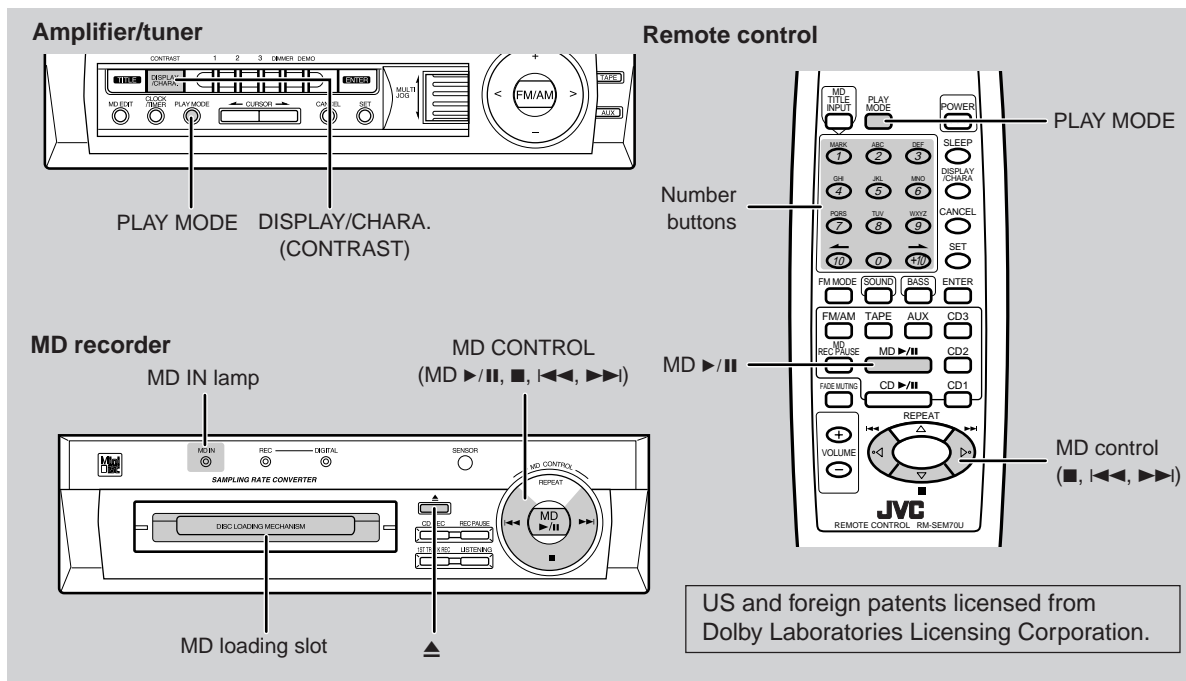

When using the remote control, make sure that it is ready for MD operations.

- Pressing MD >|| on the remote control makes the remote control ready for MD operations.

Playing Back the Entire MD — Continuous Play

You can play an MD continuously.

1 Insert an MD into the MD loading slot.

The MD is pulled in automatically.
The MD IN lamp lights.

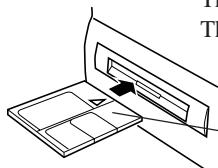

Insert an MD in the same way as indicated on the MD.

24 65:24
Total Track No. Total Playing time
TOTAL

(After a few seconds)

1 3:14
Current Track No. Playing time of the current track

2 Press MD >||.

MD playback starts from the first track.

1 0:03
Track No. Elapsed playing time

To stop during play, press ■ of the MD control.

To remove the disc, press ▲.



If the MD or track has a title

The title will be shown at the lower portion of the main display. (If a title is long and cannot be shown at a time, the unit scrolls the title to show the entire title.)

Basic MD Operations

While playing an MD, you can do the following operations.

To stop playback for a moment

Press MD >||.

To resume play, press MD >|| again.

To locate a particular point in a track

During play, press and hold ◀◀ or ▶▶ of the MD control.

- ◀◀: Fast reverses the disc.
- ▶▶: Fast forwards the disc.

To go to another track

Press ◀◀ or ▶▶ of the MD control repeatedly before or during playback.

- ◀◀: Goes back to the beginning of the current or previous tracks.
- ▶▶: Skips to the beginning of the next or succeeding tracks.

Rotating MULTI JOG on the unit also changes the tracks.

To go to another track directly using the number buttons

Pressing the number button(s) allows you to start playing the track number you want. (Make sure that you have pressed MD ▶/|| on the remote control before using the Number buttons.)

- Ex.: For track number 5, press 5.
 For track number 15, press +10 then 5.
 For track number 20, press +10, then 10.
 For track number 32, press +10, +10, +10, then 2.

To change the display Indications

The main display can show 4 track titles at a time. Each time you press DISPLAY/CHARA. (CONTRAST), the indications in the main display changes as follows:

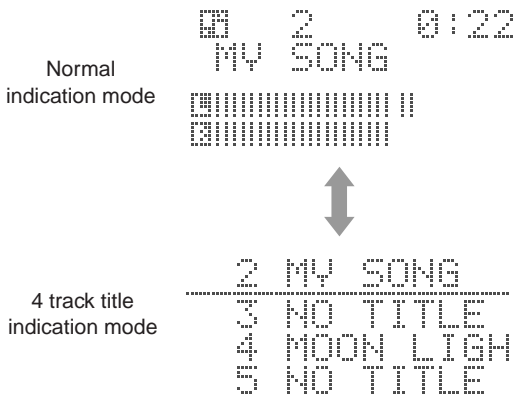

If a track title cannot be shown at a time while in 4 track title indication mode

The unit scrolls the title. However, if it consists of more than 32 characters, the entire title cannot be shown.



If you change the tracks quickly while in 4 track title indication mode

The unit cannot catch up with the changing speed and, therefore, cannot show the track titles correctly.

Programming the Playing Order of the Tracks — Program Play

You can arrange the order in which the tracks play before you start playing. You can program up to 32 tracks.

1 Insert an MD.

- If the current playing source is not the MD recorder, press MD ▶/||, then ■ of the MD control before going to the next step.

2 Press PLAY MODE so that “PROGRAM” appears in the main display.

- Each time you press the button, play mode changes as follows:

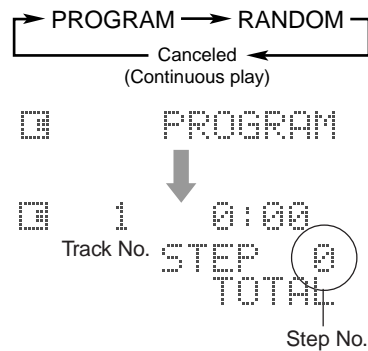

3 Select the track.

On the unit:

Rotate MULTI JOG to select the track number, then press SET.

On the remote control:

Press the number buttons.

- For how to use the number buttons, see “To go to another track directly using the number buttons.”

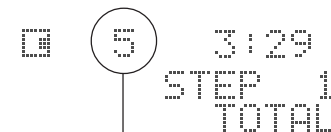

Ex. Track No. 5 is selected

- If the selected track has a title, it will be shown at the lower portion of the main display. (If the title is long and cannot be shown at a time, the unit scrolls the title to show the entire title)

Continued

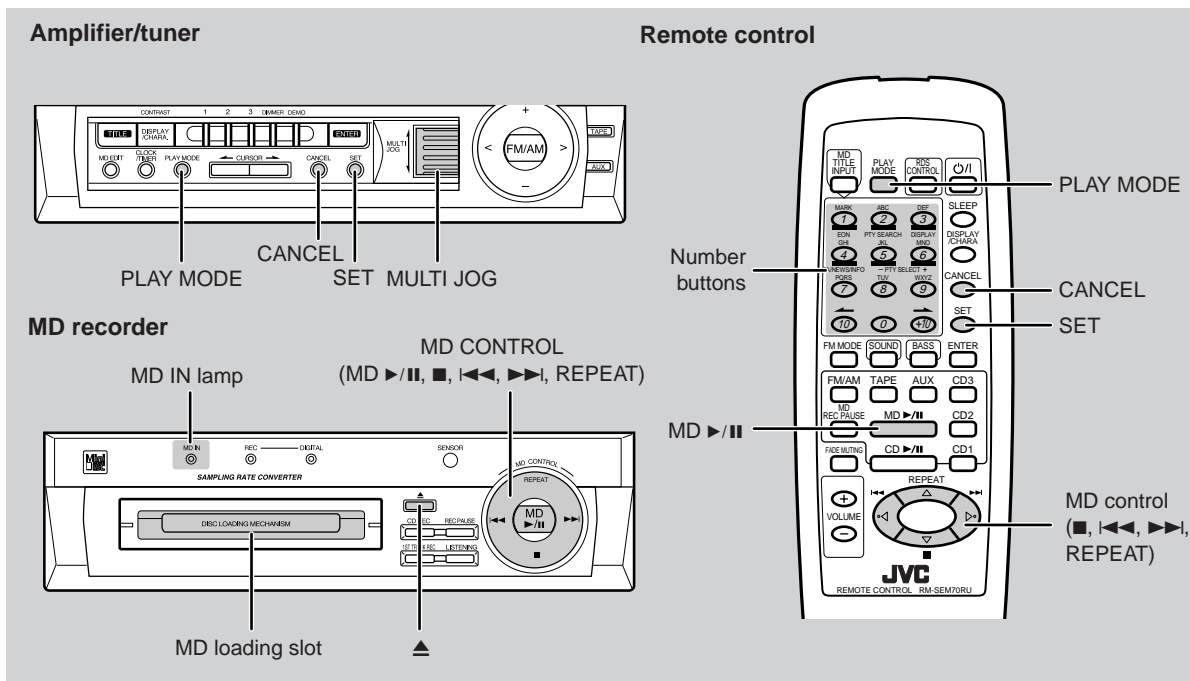

Continued

4 Repeat step 3 to program other tracks you want.

5 Press MD >||.

The tracks are played in the order you have programmed.

To stop during play, press ■ of the MD control.

To exit from Program play mode, press PLAY MODE once or twice so that the unit enters another playback mode (Random play or Continuous play mode).

To check the program contents

Before playing, you can check the program contents by pressing <<< or >>> of the MD control.

- >>> : Shows the programmed tracks in the programmed order.
- <<< : Shows them in the reverse order.

To modify the program

Before playing, you can erase the last programmed track by pressing CANCEL.

Each time you press the button, the last programmed track is erased from the program.

To add tracks in the program before you start play, simply select track numbers you want to add.



If you try to program a 33rd step
“PROGRAM FULL” will appear on the display.



If your entry is ignored

You have tried to program a track that does not exist on the MD (for example, selecting track 14 on an MD that only has 12 tracks). Such entries are ignored.



Playing at Random — Random Play

The tracks of the loaded MD will play at random.

1 Insert an MD.

- If the current playing source is not the MD recorder, press MD ►/II, then ■ of the MD control before going to the next step.

2 Press PLAY MODE repeatedly until “RANDOM” appears in the main display.

- Each time you press the button, play mode changes as follows:

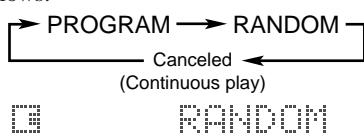

3 Press MD ►/II.

The tracks are played at random.

Random play ends when all the tracks are played once.

- Random play also ends when the MD is ejected.

To stop during play, press ■ of the MD control.

To exit from Random play mode, press PLAY MODE once or twice so that the unit enters another playback mode (Continuous play or Program play mode).

Repeating Tracks — Repeat Play

You can have all the tracks, the program or the individual track currently playing repeat as many times as you like.

To repeat play, press REPEAT during or before playing. Each time you press the button, Repeat play mode changes as follows, and appears in the main display:

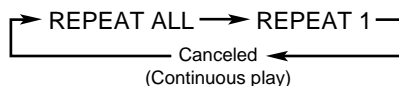

REPEAT ALL: Repeats all the tracks in the MD (continuously or at random), or all the tracks in the program.

REPEAT 1: Repeats one track.

To cancel Repeat play, press REPEAT repeatedly until no REPEAT indication (REPEAT ALL or REPEAT 1) lights on the display window.

To prohibit disc ejection — Disc Lock

You can prohibit CD and MD ejection from the unit, and can lock discs.

See page 22 for details.

Recording onto an MD

Things to Know Before You Start Recording

- **It may be unlawful to record or play back copyrighted material without the consent of the copyright owner.**
- When you record onto partially recorded MD, its contents are not erased or overwritten. The recording starts from the point following the last recorded track of the MD.
If you want to record on such an MD from the beginning, you have to erase its contents first (see “ALL ERASE Function” on page 37).
- The recording level is automatically set correctly, so it is not affected by the VOLUME control. Thus, during recording you can adjust the sound you are actually listening to without affecting the recording level.
- While recording, you can hear sound modes and/or the active bass extension effect through the speakers or headphones. However, the sound is recorded without these effects (see page 12).

About the track marks

When playing an MD, you can move among the tracks using MULTI JOG or ◀◀ / ▶▶ of the MD control, or even select directly a track using the remote control. You can do this because there is a mark recorded at the front of each track enabling you to locate the track. This mark is called a “**track mark**” and the portion between two adjacent track marks is called a “**track**.”

- **When recording from a digital source such as the CD player,** a track mark is recorded automatically at the beginning of each track.
- **When recording from an analog source such as FM/AM broadcasts,** no track mark is recorded on the MD. This means that, when playing this MD, the MD recorder will regard the entire recording as one track (track 1). You will not be able to select directly a song or navigate through songs.

However, if there is a blank of 3 seconds or more, the MD recorder will consider it as a blank separating 2 tracks and consequently put a track mark.

To put a track mark manually while recording an analog source, press SET at the place you want to put a track mark.

To add a track mark after recording is over, you can use the DIVIDE function (see page 33).

To avoid erasing important recordings

Recordable MDs have an erasure prevention tab so that important recordings are not accidentally erased. When you finish recording or editing, slide open the erasure prevention tab on the cartridge side surface. New recording or editing is now no longer possible.

To do re-recording or editing, return the tab to the closed position.

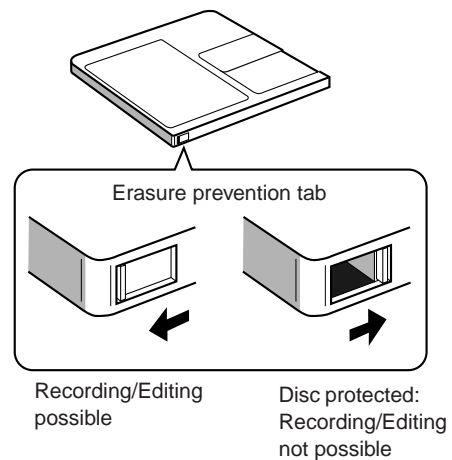

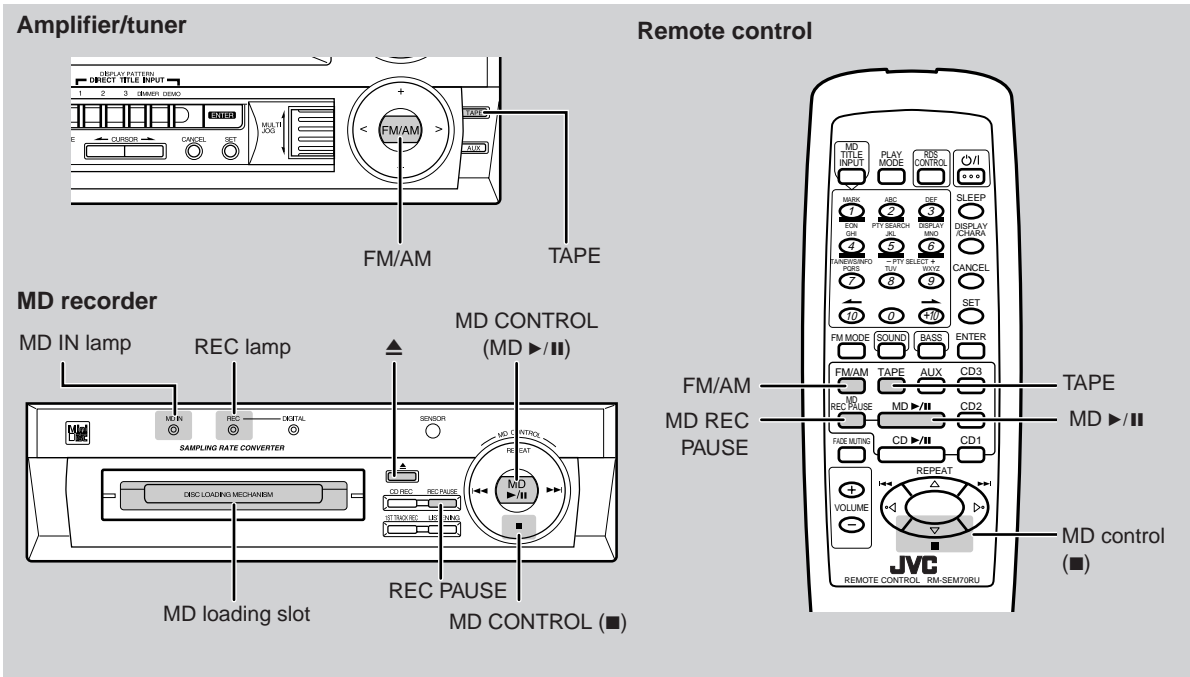

When using the remote control, make sure that it is ready for MD operations.

- Pressing MD >|| on the remote control makes the remote control ready for MD operations.

Recording FM/AM Broadcasts or from the Cassette Deck

You can record FM/AM broadcasts or sounds from the cassette deck connected to the TAPE jacks on the rear.

- 1 Insert a recordable MD.**
The MD IN lamp lights.
- 2 Start playing the source — FM, AM, or cassette deck connected to the TAPE jacks.**
 - When recording an FM/AM broadcast, press FM/AM, then tune into a station you want.
 - When recording from the cassette deck, press TAPE to select it as the playback source.
- 3 Press REC PAUSE on the unit (or MD REC PAUSE on the remote control).**
The REC lamp on the unit starts flashing.

Ex.: When recording an FM station



- 4 Press MD >||.**
The REC lamp stops flashing and remains lit, and recording starts.

To stop recording, press ■ of the MD control.

To stop recording temporarily, press REC PAUSE (or MD REC PAUSE) again.

To resume recording, press MD >|| again.

To remove the MD, press ▲.

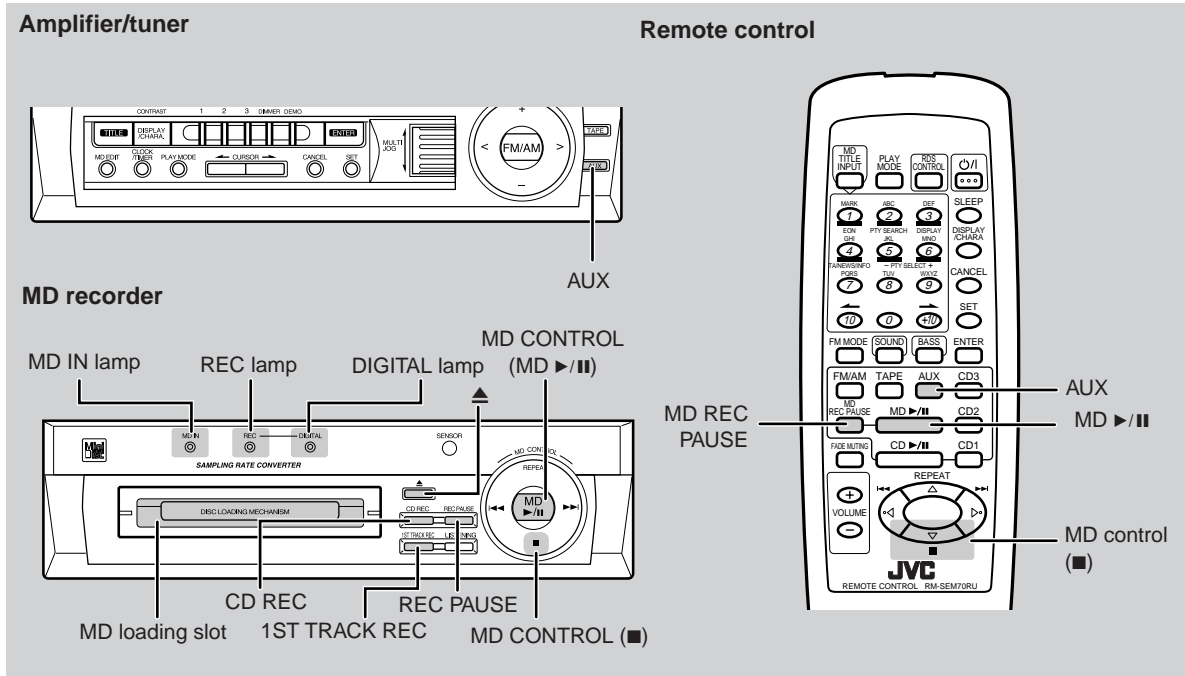

Recording from the External (AUX) Equipment

Both analog and digital recording is possible from the external equipment connected to the AUX jacks.

For digital recording: Connect;

- Between the optical digital output terminal on the other equipment and the AUX DIGITAL IN OPTICAL terminal, by using an optical digital cord (not supplied).
- Between the audio output jacks on the other equipment and the AUX jacks, by using an audio cord (not supplied).

1 Insert a recordable MD.

The MD IN lamp lights.

2 Press AUX once, then start playing the source.

3 Press REC PAUSE on the unit (or MD REC PAUSE on the remote control).

The REC lamp on the unit starts flashing.

4 Press AUX again.

- Each time you press the button, analog or digital input is selected alternately.

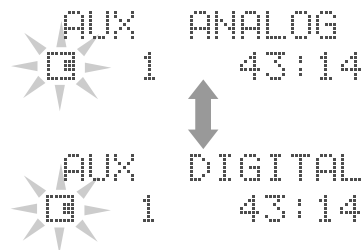

- If you select the digital input, the DIGITAL lamp on the unit lights.

DIGITAL: Enables digital recording through the optical digital cord connected to the AUX DIGITAL IN OPTICAL terminal. A sampling rate converter built in this unit allows you to record from a digital device whose sampling frequency is 32 kHz, 44.1 kHz, or 48 kHz.

ANALOG: Enables analog recording through the audio cord connected to the AUX jacks.

5 Press MD >||.

The REC lamp stops flashing and remains lit, and recording starts.

To stop recording, press ■ of the MD control.

To stop recording temporarily, press REC PAUSE (or MD REC PAUSE) again.

To resume recording, press MD ►/|| again.

To remove the MD, press ▲.

Recording CDs

You have 3 methods to record from a CD onto an MD.

- **Synchronized Recording** — Records the entire CD or the program you have made.
- **First Track Recording** — Records the first track of each CD.
- **Listening Edit Recording** — Allows you to make a program while listening to the CD.

Synchronized Recording

This is the easiest way of CD recording. Only by pressing CD REC, you can start playing a CD and recording on an MD.

1 Insert a recordable MD.
The MD IN lamp lights.

2 Prepare a CD.
• Place a CD on one of the disc tray (CD 1, CD 2, or CD 3), press the corresponding Disc Number button (CD 1, CD 2, or CD 3), then ■ of the CD control before going to the next step. Make sure that the correct Disc Number lamp lights on the unit.
• You can make a program if you want (see page 20).

3 Press CD REC on the unit.
The REC and DIGITAL lamps on the unit light.

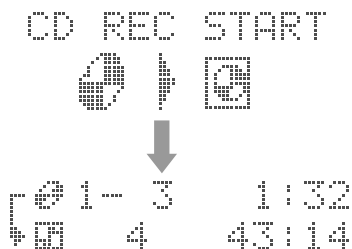

To stop recording, press ■ (of either the CD control or the MD control).

To record a single track while playing a CD

Press CD REC while playing back a CD track you want to record.

The playback of that CD track is stopped, and the same track starts playing from the beginning again. This time, the MD recorder starts recording the CD track.

First Track Recording

First Track Recording allows you to record the first track of each loaded CD. You can, for example, make a directory of all your best CDs.

1 Prepare CDs, and a recordable MD.

- Always place a CD on the CD 1 tray. If not, this function does not work.

2 Press 1ST TRACK REC.

The REC and DIGITAL lamps light, and First Track Recording starts from the CD on the CD 1 tray.



When the first track of the CD on the CD 1 tray is recorded, the first track of the CD on the CD 2 tray will be recorded. Recording continues until the first track of each loaded CD is recorded.



3 Replace the CDs on the trays whose disc number lamp does not light green.

- You can change CDs to continue the First Track Recording using more than 3 CDs.

When the first track of the last loaded CD is recorded, First Track Recording stops.

To stop recording, press ■ (of either the CD control or the MD control).



Amplifier/tuner

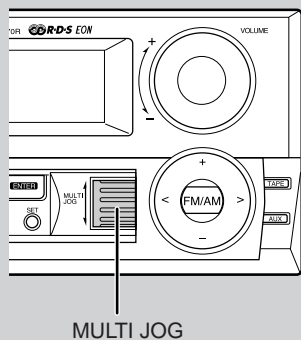

MD recorder

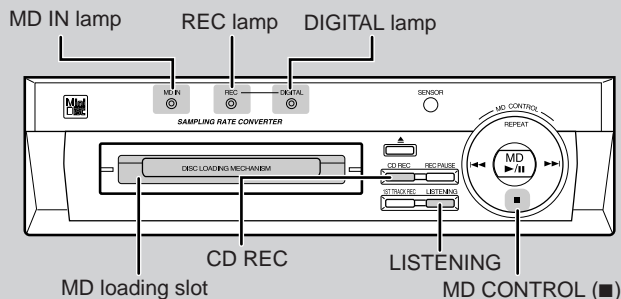

Listening Edit Recording

Listening Edit Recording allows you to make a program while listening and checking each track of the loaded CDs, then to start recording the program.

- You can program up to 32 tracks.

1 Prepare CDs, and a recordable MD.

- Always place a CD on the CD 1 tray. If not, this function does not work.

2 Press LISTENING.

Listening Edit starts from the CD on the CD 1 tray.

LISTENING EDIT



⊗ 1- 3 1:32
 □ 1 43:14

Remaining time
for recording

3 Decide if you want to include the current track in the program or skip it.

- To include the current playing track in the program,** press LISTENING again. The current track is programmed ("Memory" appears for a while) and the next track starts playing. (If the last track of a CD is programmed, the first track of the next CD starts playing.)
- To skip the current track,** rotate MULTI JOG downward or press ►► of the CD control. The current playing track is not programmed and the next track starts playing.

If you do not either press the button or rotate MULTI JOG, the unit will play the same track repeatedly.

4 Repeat step 3 to program other tracks.

When you finish checking all CDs or if there is no more remaining time for recording on the MD, Listening Edit Recording starts automatically. The REC and DIGITAL lamps light.

To stop any time during editing process and start recording, press CD REC.

To stop recording, press ■ (of either the CD control or the MD control).

To erase the program, press ■ of the CD control while checking the contents of the loaded CDs.

To modify the program

Before you start recording (or move to the next disc programming), you can go back to a previous track of the currently programming disc by pressing ◀◀ of the CD control (programmed tracks, up to the track you have returned to, are erased from the program). Start programming from that track again.

- By rotating MULTI JOG downward, you can also go back to a previous track of the currently programming disc.

Introducing MD Editing Functions

A recorded MD can be edited in many ways. The MD editing functions include dividing, joining, moving, erasing a single track, erasing the entire disc, and more than one of them can be combined as required.

Dividing a track (DIVIDE) : Page 33

This function divides a track by adding a track marking(s) in the desired point(s) in the middle or where you want to search later.

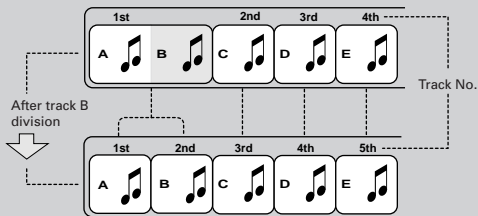

Erasing all tracks (ALL ERASE) : Page 37

This function erases data in a disc entirely.

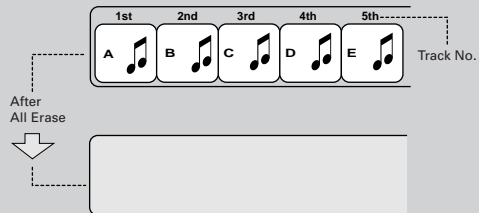

Joining a track (JOIN) : Page 34

This function joins two adjacent tracks into a single track by deleting a track marking.

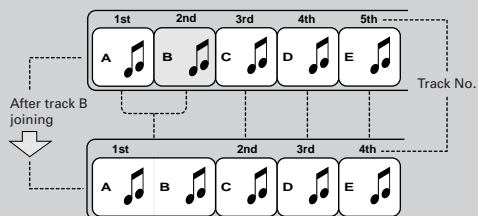

Combining MD editing functions

By combining "DIVIDE", "ERASE" and "JOIN", for example, it is possible to erase only a part of an existing track.

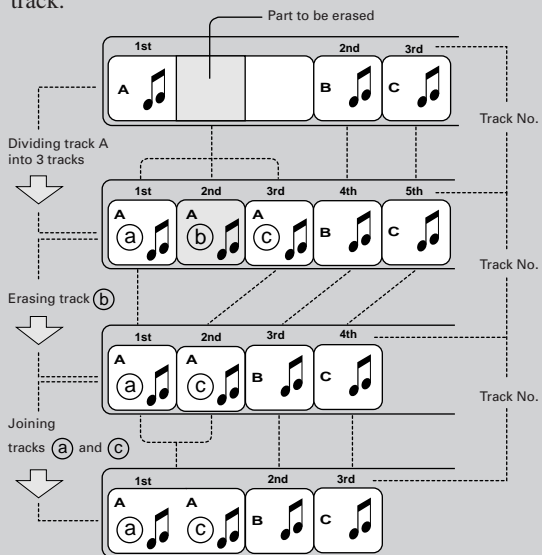

Moving a track (MOVE) : Page 35

This function moves a track by reordering the track numbers.

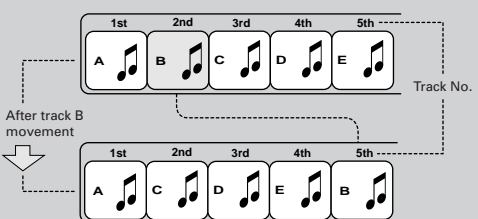

Erasing a track (ERASE) : Page 36

This function erases a specified track. After the erasure, the subsequent tracks are justified and their track numbers are decremented automatically.

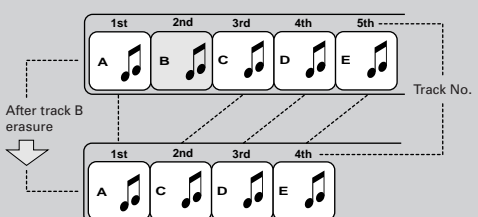

You can also assign titles to MDs and/or tracks (See page 38.)

A title can be assigned to a track or disc. Once a title is assigned, it is displayed in later playback for confirmation.

Each title can be composed of up to 64 characters, and can be input using alphabetic characters (uppercase and lowercase), symbols and numerals.

Amplifier/tuner

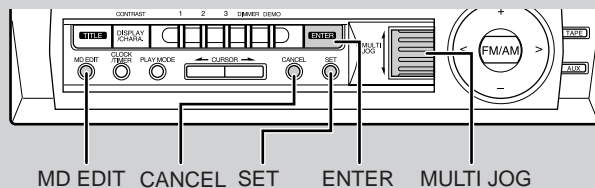

MD recorder

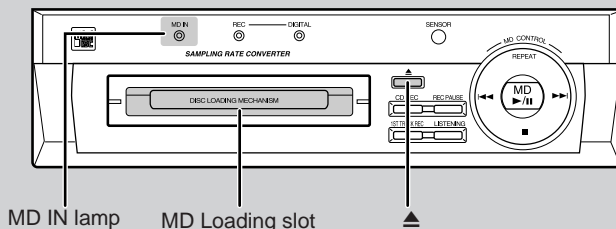

DIVIDE Function

This function allows you to divide one track into two separate tracks. It is useful, for example, when you want to add track marks at a certain point within a track or if you want to separate a recording.

- To do the following procedures, use the buttons and controls on the unit.
- To stop any time during editing process, press MD EDIT.

1 Insert an MD you want to edit into the MD loading slot.

The MD IN lamp lights.

2 Press MD EDIT.

The MD recorder enters editing mode (with DIVIDE function selected).

```

  [ ] MD EDIT
  -----
  [ ] ALL ERASE
  [ ] DIVIDE
  [ ] JOIN
  
```

3 Press SET.

The information of the first track (or the current track, if during play) of the MD appears in the main display, and playback starts.

4 Rotate MULTI JOG to select the track you want to divide.

Ex. When you want to divide track 3

```

  [ ] 3 3:14
  MY SONG
  
```

```

  <DIVIDE>
  
```

- If you have selected a wrong track, press CANCEL then select the correct track.

5 Press SET when you find the point where you want to divide the track.

The MD recorder repeats the selected point — a portion of 3 seconds length following the dividing point.

```

  [ ] 3 0:00
  MY SONG
  POSITION 0
  <DIVIDE>
  
```

- If the dividing point is satisfactory, go to step 7.
- If the dividing point is not satisfactory, go to the next step.

6 Rotate MULTI JOG to precisely adjust the dividing point.

- You can shift the dividing point up to ± 128 . This range (± 128) corresponds to approximately ± 8 seconds from the original point (Position 0).

```

  [ ] 3 0:00
  MY SONG
  POSITION+ 15
  <DIVIDE>
  
```

When you stop rotating the MULTI JOG dial, the unit repeats the newly selected dividing point.

- When you find the right position, go to the next step.

7 Press SET.

```

      OK?
YES→ ENTER
NO→CANCEL
<DIVIDE>
  
```

- If you want to cancel the editing, press CANCEL.

8 Press ENTER to finish the editing procedures.

```

EDITING
<DIVIDE>
  
```

9 Press ▲ to eject the MD.

- “WRITING” appears while the editing you have made is being recorded on the MD.

To join the divided tracks again, see the JOIN function.

JOIN Function

This function allows you to join two adjacent tracks into one track.

- To do the following procedures, use the buttons and controls on the unit.
- To stop any time during editing process, press MD EDIT.

1 Insert an MD you want to edit into the MD loading slot.

- The MD IN lamp lights.

2 Press MD EDIT.

- The MD recorder enters editing mode (with DIVIDE function selected).

```

  MD EDIT
-----
ALL ERASE
  DIVIDE
  JOIN
  
```

3 Rotate MULTI JOG until “JOIN” is selected.

```

  MD EDIT
-----
  DIVIDE
  JOIN
  MOVE
  
```

4 Press SET.

5 Rotate MULTI JOG to select the two adjacent tracks you want to join.

- Ex.: When joining tracks 1 and 2

```

  1 MINI
  2 MOON LIGHT
  3 NO TITLE
  <JOIN>
  
```

6 Press SET.

```

1+ 2 OK?
YES→ ENTER
NO→CANCEL
<JOIN>
  
```

- If you have selected wrong tracks, press CANCEL, then select the correct tracks by rotating MULTI JOG.

- If you want to cancel the editing, press CANCEL.

7 Press ENTER to finish the editing procedures.

```

EDITING
<JOIN>
  
```

8 Press ▲ to eject the MD.

- “WRITING” appears while the editing you have made is being recorded on the MD.

To divide the joined tracks, see the DIVIDE function.

Amplifier/tuner

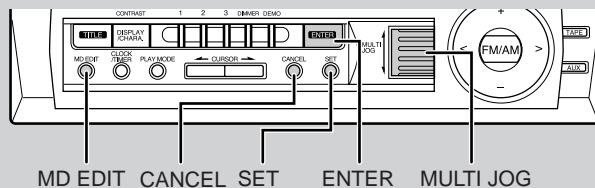

MD recorder

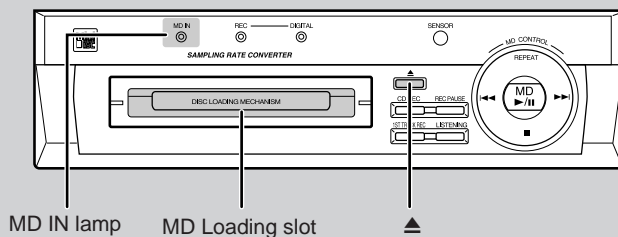

MOVE Function

This function allows you to move a track to the position you prefer. It is useful to change the order of the tracks as you like.

- To do the following procedures, use the buttons and controls on the unit.
- To stop any time during editing process, press MD EDIT.

1 Insert an MD you want to edit into the MD loading slot.

The MD IN lamp lights.

2 Press MD EDIT.

The MD recorder enters editing mode (with DIVIDE function selected).

```

┌───┐
│ MD EDIT │
├───┤
│ ALL ERASE │
│ DIVIDE │
│ JOIN │
└───┘

```

3 Rotate MULTI JOG until "MOVE" is selected.

```

┌───┐
│ MD EDIT │
├───┤
│ JOIN │
│ MOVE │
│ ERASE │
└───┘

```

4 Press SET.

5 Rotate MULTI JOG to select the track you want to move.

Ex.: When moving track 2

```

1 MINI
2 MOON LIGHT
3 NO TITLE
<MOVE>

```

6 Press SET.

```

1 MINI
2 MOON LIGHT
3 NO TITLE
<MOVE>

```

- If you have selected a wrong track number, press CANCEL, then select the correct track number again.

7 Rotate MULTI JOG to select the position where you want to move the track.

Ex.: When moving to the track 4 position

```

3 NO TITLE
4 EVE
5 HOW EVER
<MOVE>

```

8 Press SET.

```

2→ 4 OK?
YES→ ENTER
NO→CANCEL
<MOVE>

```

- If you have selected wrong tracks, press CANCEL, then select the correct tracks by rotating MULTI JOG.
- If you want to cancel the editing, press CANCEL.

9 Press ENTER to finish the editing procedures.

```

EDITING

```

```

<MOVE>

```

10 Press \blacktriangle to eject the MD.

“WRITING” appears while the editing you have made is being recorded on the MD.

3 Rotate MULTI JOG until “ERASE” is selected.

```

MD EDIT
-----
MOVE
ERASE
ALL ERASE

```

4 Press SET.

```

1 MINI
2 MOON LIG
<ERASE>

```

5 Rotate MULTI JOG to select the track you want to erase.**6** Press SET.

```

1 MINI
2 MOON LIG
3 NO TITLE
<ERASE>

```

- If you have selected a wrong track number, press CANCEL, then select the correct track number.

7 Repeat steps 5 and 6 if you want to erase more tracks (up to 16).**8** Press ENTER to finish your selection of tracks to erase.

```

OK?
YES→ ENTER
NO→CANCEL

```

- If you want to cancel the editing, press CANCEL.

9 Press ENTER again.

```

EDITING
<ERASE>

```

10 Press \blacktriangle to eject the MD.

“WRITING” appears while the editing you have made is being recorded on the MD.

ERASE Function

This function allows you to erase an unwanted track.

- To do the following procedures, use the buttons and controls on the unit.
- To stop any time during editing process, press MD EDIT.

1 Insert an MD you want to edit into the MD loading slot.

The MD IN lamp lights.

2 Press MD EDIT.

The MD recorder enters editing mode (with DIVIDE function selected).

```

MD EDIT
-----
ALL ERASE
DIVIDE
JOIN

```

Amplifier/tuner

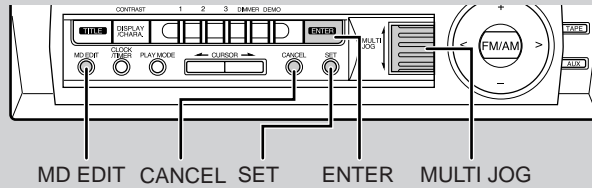

MD recorder

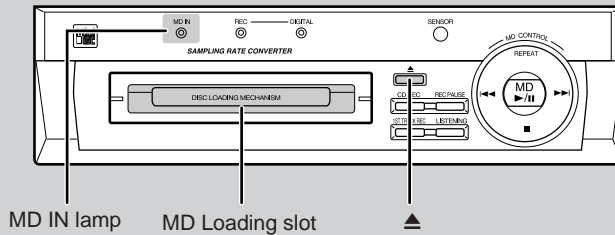

ALL ERASE Function

This function allows you to erase all the tracks on an MD.

- To do the following procedures, use the buttons and controls on the unit.
- To stop any time during editing process, press MD EDIT.

1 Insert an MD you want to edit into the MD loading slot.

The MD IN lamp lights.

2 Press MD EDIT.

The MD recorder enters editing mode (with DIVIDE function selected).

3 Rotate MULTI JOG until "ALL ERASE" is selected.

```

  [ ] MD EDIT
  -----
  ERASE
  > ALL ERASE <
  DIVIDE
  
```

4 Press SET.

```

  OK?
  YES-> ENTER
  NO->CANCEL
  
```

- If you want to cancel the editing, press CANCEL.

5 Press ENTER.

```

  EDITING
  <ALL ERASE>
  
```

6 Press \blacktriangle to eject the MD.

"WRITING" appears while the editing you have made is being recorded on the MD.

Erasing a Portion of a Track

You can erase just a portion of one track by using the DIVIDE, ERASE and JOIN functions.

- To do the following procedures, use the buttons and controls on the unit.
- To stop any time during editing process, press MD EDIT.

1 Insert an MD you want to edit into the MD loading slot.

The MD IN lamp lights.

2 Press MD EDIT.

The MD recorder enters editing mode (with DIVIDE function selected).

3 Divide a track into 3 portions to isolate the portion to erase.

- Use the DIVIDE function by referring to page 33.

4 Erase the middle portion.

- Use the ERASE function by referring to page 36.

5 Join the two remaining portions.

- Use the JOIN function by referring to page 34.

Assigning Titles to MDs

Continued

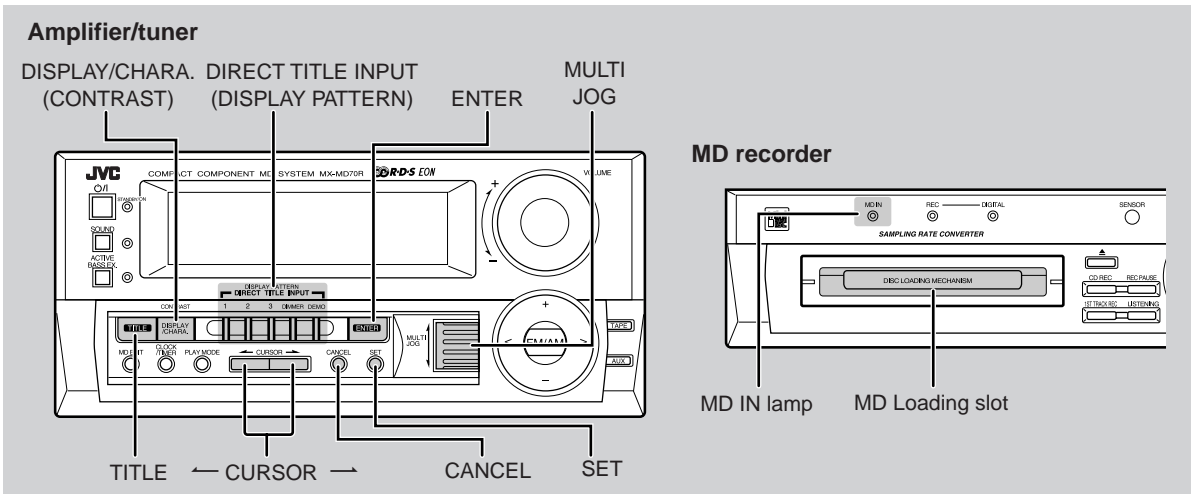

You can assign a name to each MD and to each track. Once a title is assigned, it is displayed in later playback for confirmation. Each title can be composed of up to 64 characters, and can be input using alphabetic characters (uppercase and lowercase), symbols and numerals.

Assigning a Title Using the Unit

- To stop any time during the process, press TITLE.

1 Insert an MD you want to edit into the MD loading slot.
The MD IN lamp lights.

2 Press TITLE.
The MD recorder enters title entry mode.

- Disc title entry indication (mode):** appears when you press TITLE while the disc information is shown in the main display.

DISC NOTITLE

<DISC TITLE?>

- Track title entry indication (mode):** appears when you press TITLE while the track information is shown in the main display.

TR. NOTITLE

< 1 TITLE?>

3 Rotate MULTI JOG to change the title entry mode.

- Title entry mode changes as follows:

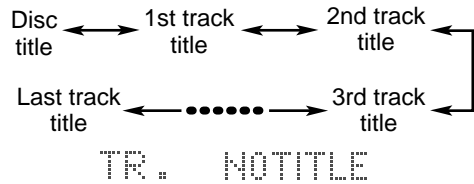

Ex.: When selecting 3rd track title entry mode

< 3 TITLE?>

4 Press SET to enter the selected title entry mode.

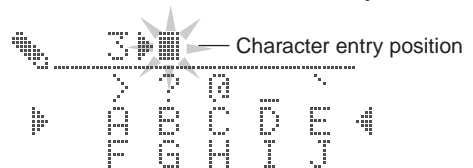

5 Press DISPLAY/CHARA. (CONTRAST) to select the character set you want.

- Each time you press the button, the character sets change as follows:

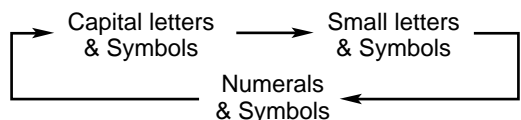

See the character set table on page 40 to know what characters and symbols you can use.

Continued

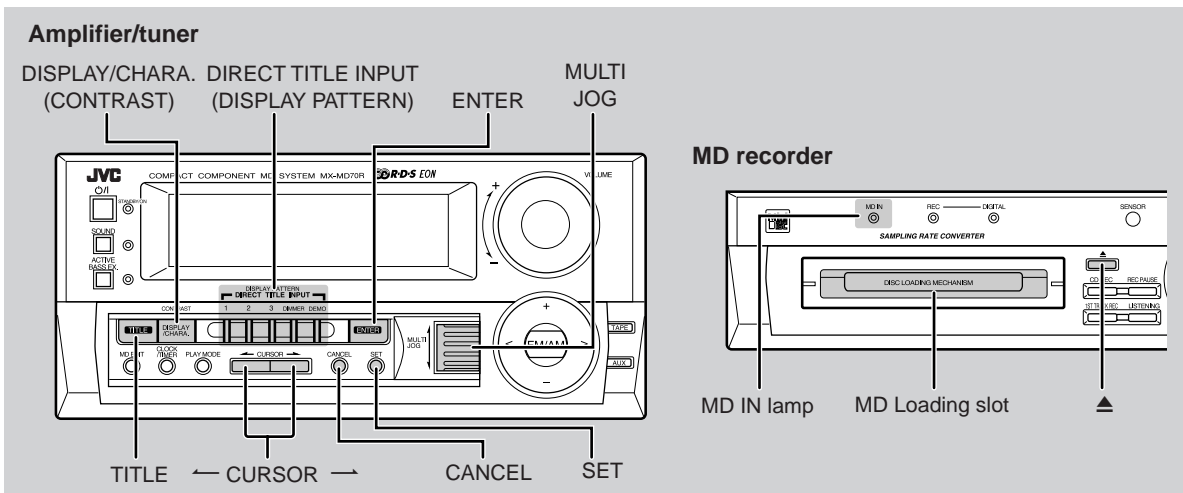

Continued

6 Input a character.

- EX. When entering "H"
- 1) Rotate **MULTI JOG** to select the row where a character you want exists.
 - In this example, select the row of "F G H I J."

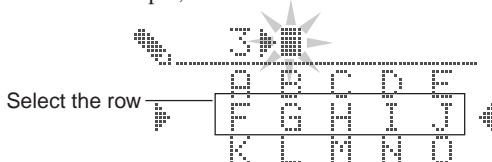

- 2) Press one of the **DIRECT TITLE INPUT** buttons to select the character position in the row.

The selected character is input, and the character entry position moves to the next.

- In this example, press 3 which corresponds to "H" in the row of "F G H I J."

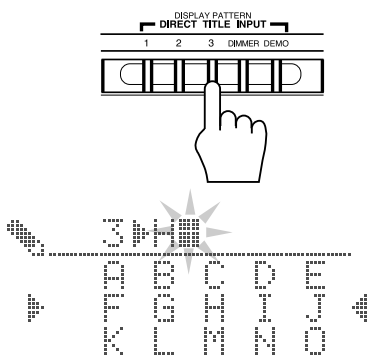

- To move the character entry position while entering a title, press ← CURSOR →.
- If you have entered an incorrect character, press CANCEL to cancel the last entry.

7 Repeat steps 5 and 6 to input other characters.

- The main display can only show 7 characters at a time. If you enter the 8th character, the first character disappears, and so on.

8 Press ENTER twice to finish title entry.

- If you want to cancel the editing, press TITLE after pressing ENTER once in this step.

9 Press ▲ to eject the MD.

- "WRITING" appears while the editing you have made is being recorded on the MD.



You can assign titles during play or recording

- **During play: Entering a track title**
The MD recorder repeats playback of the current track until you press ENTER twice in step 8 above. When you press it twice, MD stops play.
Entering a disc title
The MD recorder repeats playback of all tracks of the MD until you press ENTER twice in step 8 above. When you press it twice, MD stops play.
- **During recording: Entering a track title**
The MD recorder continues recording even after you press ENTER twice in step 8 above. When you press it twice, a track title is assigned to the track where you have started the title entry.

Changing the Title

You can make a correction or change the title.

- 1** Follow steps 1 to 4 of page 38.
- 2** Press ← CURSOR → to select the character you want to correct.
 - Make sure that the character you want to change is flashing.
- 3** Press CANCEL to delete the character you have selected in the above step.
- 4** Input the correct character.
 - 1) Press DISPLAY/CHARA. (CONTRAST) to select the character set you want.
 - 2) Rotate MULTI JOG then press one of the DIRECT TITLE INPUT buttons.

- 5** Repeat steps 2 to 4 of the current procedure to correct more characters.

- 6** Press ENTER twice to finish correcting the title.
 - If you want to cancel the correction, press TITLE after pressing ENTER once in this step.

- 7** Press ▲ to eject the MD.

“WRITING” appears while the editing you have made is being recorded on the MD.

To erase all the characters

Press CANCEL repeatedly in step 3 above to erase all the characters, then go to step 6.

Available Characters

Capital letters & Symbols

A	B	C	D	E
F	G	H	I	J
K	L	M	N	O
P	Q	R	S	T
U	V	W	X	Y
Z		(Blank)		
(Blank)	!	"	#	\$
%	&	'	()	
*	+	,	-	.
/	:	;	<	=
>	?	@	_	`

Small letters & Symbols

a	b	c	d	e
f	g	h	i	j
k	l	m	n	o
p	q	r	s	t
u	v	w	x	y
z		(Blank)		
(Blank)	!	"	#	\$
%	&	'	()	
*	+	,	-	.
/	:	;	<	=
>	?	@	_	`

Numerals & Symbols

0	1	2	3	4
5	6	7	8	9
(Blank)	!	"	#	\$
%	&	'	()	
*	+	,	-	.
/	:	;	<	=
>	?	@	_	`

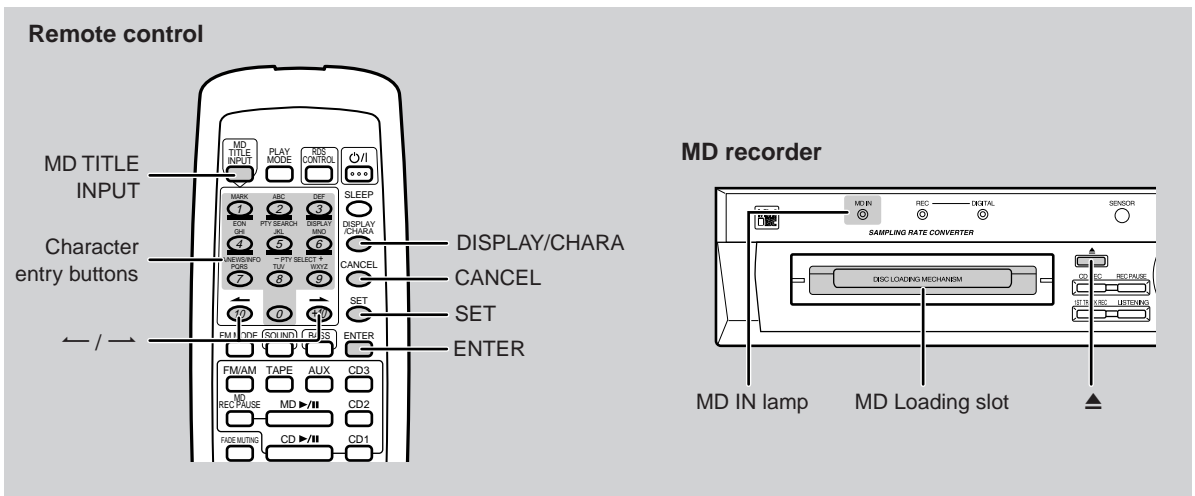

Assigning a Title Using the Remote Control

- To stop any time during the following process, press MD TITLE INPUT.

1 Insert an MD you want to edit into the MD loading slot on the unit.
The MD IN lamp lights.

2 Press MD TITLE INPUT.
The MD recorder enters title entry mode.

- Disc title entry indication (mode):** appears when you press MD TITLE INPUT while the disc information is shown in the main display.



- Track title entry indication (mode):** appears when you press MD TITLE INPUT while the track information is shown in the main display.



3 Press ← or → to change the title entry mode.

- Title entry mode changes as follows:

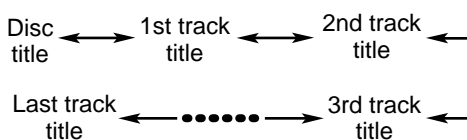

4 Press SET to enter the selected title entry mode.

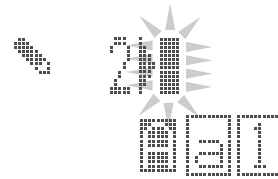

5 Press DISPLAY/CHARA. to select the character set you want.

- Each time you press the button, the character sets change as follows:

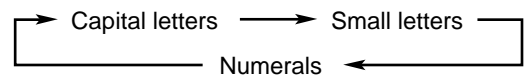

6 Input a character.

1) Press the character entry button for a character you want to input.

Examples:

- To input an "A" or "a," press ABC once.
- To input a "B" or "b," press ABC twice.
- To input a "C" or "c," press ABC three times.
- To input a "D" or "d," press DEF once.
- To input an "E" or "e," press DEF twice.
- To input an "F" or "f," press DEF three times.
-

- To input a symbol, press MARK repeatedly until the desired mark appears.
- To move the character entry position while entering a title, press ← or →.
- If you have entered an incorrect character, press CANCEL to cancel the last entry.

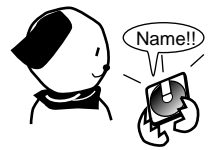

2) Press the button for the next character you want to input.

- If the next character you want to input is assigned to the same button you have just pressed in step 6-1), press \rightarrow first to move the character entry position to right.

7 Repeat steps 5 and 6 to input other characters.

- The main display can only show 8 characters at a time. If you enter the 9th character, the first character disappears, and so on.

8 Press ENTER twice to finish the title entry.

- If you want to cancel the editing, press MD TITLE INPUT after pressing ENTER once in this step.

9 Press Δ on the unit to eject the MD.

“WRITING” appears while the editing you have made is being recorded on the MD.



You can assign titles during play or recording

• **During play: Entering a track title**

The MD recorder repeats playback of the current track until you press ENTER twice in step 8 above. When you press it twice, MD stops play.

Entering a disc title

The MD recorder repeats playback of all tracks of the MD until you press ENTER twice in step 8 above. When you press it twice, MD stops play.

• **During recording: Entering a track title**

The MD recorder continues recording even after you press ENTER twice in step 8 above. When you press it twice, a track title is assigned to the track where you have started the title entry.

Changing the Title

You can make a correction or change the title.

1 Follow steps 1 to 4 of page 41.

2 Press \leftarrow or \rightarrow to select the character you want to correct.

- Make sure that the character you want to change is flashing.

3 Press CANCEL to delete the character you have selected in the above step.

4 Input the correct character by pressing one of the text entry buttons.

5 Repeat steps 2 to 4 of the current procedure to correct more characters.

6 Press ENTER twice to finish correcting the title.

- If you want to cancel the correction, press MD TITLE INPUT after pressing ENTER once in this step.

7 Press Δ on the unit to eject the MD.

“WRITING” appears while the editing you have made is being recorded on the MD.

To erase all the characters

Press CANCEL repeatedly in step 3 above to erase all the characters, then go to step 6.

Available Characters

Capital letters

A	B	C	D	E
F	G	H	I	J
K	L	M	N	O
P	Q	R	S	T
U	V	W	X	Y
Z				

Small letters

a	b	c	d	e
f	g	h	i	j
k	l	m	n	o
p	q	r	s	t
u	v	w	x	y
z				

Numerals

0	1	2	3	4
5	6	7	8	9

Symbols

(Blank)	!	"	#	\$
%	&	'	()	
*	+	,	-	.
/	:	;	<	=
>	?	@	_	`

Using the Timers

Amplifier/tuner

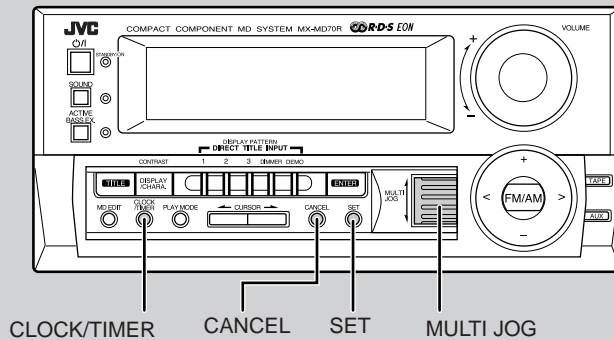

There are three timers available — Recording Timer, Daily Timer, and Sleep Timer. Before using these timers, you need to set the clock built in the unit. (See page 10.)

Using Recording Timer

With Recording Timer, you can make an MD of a radio broadcast automatically.

- You can set Recording Timer whether the unit is turned on or off.
- To correct a mis-entry any time during the setting process, press CANCEL.

How Recording Timer actually works

The unit automatically turns on, tunes into the specified station, turns off the volume, and starts recording on the MD recorder when the timer-on time comes. Then, when the timer-off time comes, the unit automatically turns off (stands by).

The timer settings remain stored in memory until you reset them or disconnect the AC power cord.

- 1** Press **CLOCK/TIMER** repeatedly until “REC SET” appears in the main display.

- Each time you press the button, the timer mode changes as follows:

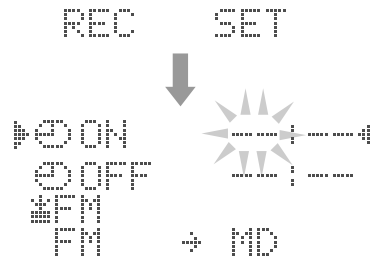
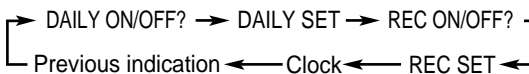

- 2** Rotate **MULTI JOG** to set the hour of the timer-on time, then press **SET**.

- 3** Rotate **MULTI JOG** to set the minute of the timer-on time, then press **SET**.

- 4** Rotate **MULTI JOG** to set the hour of the timer-off time, then press **SET**.

- 5** Rotate **MULTI JOG** to set the minute of the timer-off time, then press **SET**.

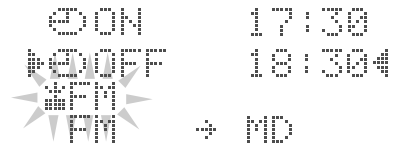

- 6** Rotate **MULTI JOG** to select either “FM” or “AM,” then press **SET**.

- 7** Rotate MULTI JOG to select a preset channel, then press SET.

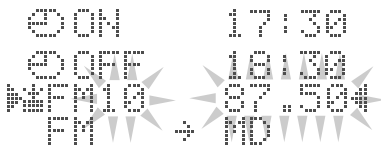

After completing the settings...

The REC indicator lights on the display window, and Recording Timer is ready for unattended recording.

After a timer recording is complete...

Set the volume to an appropriate listening level.



If you press a certain button while Recording Timer is operating

Recording will stop.

To use the same Recording timer settings repeatedly

Once you have set Recording Timer, it remains stored in memory until you change it.

To activate Recording Timer with the previous settings recalled, follow the procedure below:

- 1** Press CLOCK/TIMER repeatedly until “REC ON/OFF?” appears in the main display.



- 2** Press SET to use the previous settings for next timer recording.

The REC indicator lights on the display window.

- To deactivate Recording Timer, press CANCEL in this step.

Using Daily Timer

With Daily Timer, you can wake up to your favorite music or radio program.

- You can set Daily Timer whether the unit is turned on or off.

How Daily Timer actually works

The unit automatically turns on, and starts playing the specified source when the timer-on time comes. Then, when the timer-off time comes, the unit automatically turns off (stands by).

The timer settings remain stored in memory until you reset them or disconnect the AC power cord.

- 1** Press CLOCK/TIMER repeatedly until “DAILY SET” appears in the main display.

- Each time you press the button, the timer mode changes as follows:

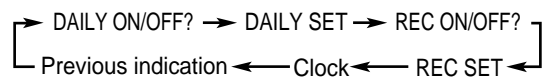

DAILY SET

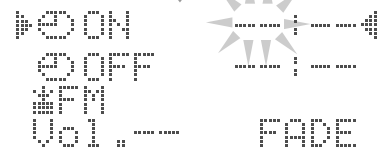

- 2** Rotate MULTI JOG to set the hour of the timer-on time, then press SET.

- 3** Rotate MULTI JOG to set the minute of the timer-on time, then press SET.

- 4** Rotate MULTI JOG to set the hour of the timer-off time, then press SET.

- 5** Rotate MULTI JOG to set the minute of the timer-off time, then press SET.



Continued

Amplifier/tuner

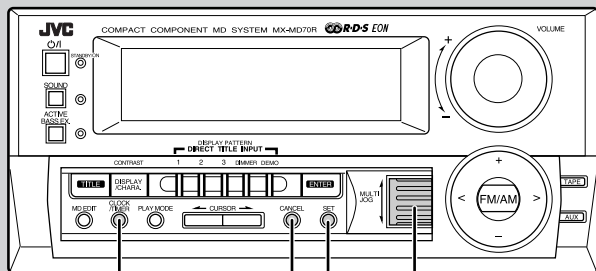

CLOCK/TIMER

CANCEL

SET

MULTI JOG

Remote control

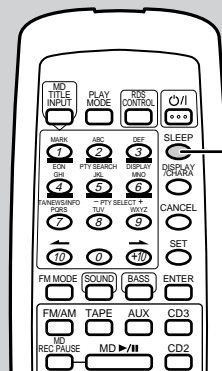

SLEEP

Continued

- 6** Rotate MULTI JOG to set the source, then press SET.

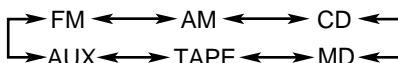

- FM:** Tunes into a preset FM station. Go to step 7.
AM: Tunes into a preset AM station. Go to step 7.
CD: Plays a CD. Prepare a CD, then go to step 7.
MD: Plays an MD. Prepare an MD.
TAPE*: Selects "TAPE" as the source. Make the cassette deck ready for playback.
AUX*: Selects "AUX" as the source. Make the external equipment ready for playback.

* To use these equipment with the Daily Timer, they also have the timer function.

- 7** If you have selected FM or AM as the source in the above step, select a preset channel.

- 1) Rotate MULTI JOG to select a preset channel.
- 2) Press SET.

If you have selected CD as the source in the above step, select a disc.

- 1) Rotate MULTI JOG to select a disc.
- 2) Press SET.

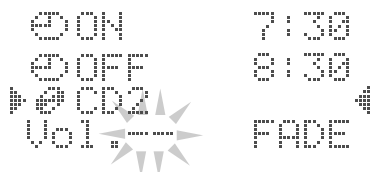

Ex.: When selecting "CD 2"

- 8** Rotate MULTI JOG to set the volume level, then press SET.

- You can adjust the volume within the range of "00" to "50." If you select "--," the volume is set to the previous level when the unit is turned off.

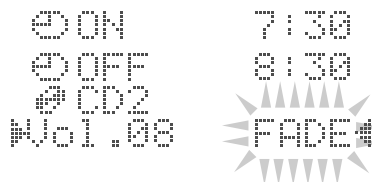

- 9** Rotate MULTI JOG to select either "FADE" or "NO FADE," then press SET.

FADE: Volume fades in (gradually becomes louder and is set to the specified level) when the timer-on time comes.

NO FADE: No fade-in effect. Volume is set to the specified level when the timer-on time comes.

After completing the settings...

The DAILY indicator lights on the display window.

Turns off the unit (on standby) if you have set Daily Timer with the unit turned on.



If you press a certain button while Daily Timer is operating
The unit will not turn off automatically.

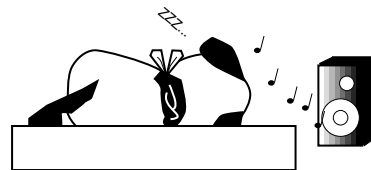

To use the same Recording timer settings repeatedly

Once you have set Daily Timer, it remains stored in memory until you change it.

To activate Daily Timer with the previous settings recalled, follow the procedure below:

- 1 Press **CLOCK/TIMER** repeatedly until **"DAILY ON/OFF?"** appears in the main display.

```

DAILY ON/OFF?
ON+   SET
OFF+  CANCEL
  
```

- 2 Press **SET** to activate Daily timer.

- To deactivate Daily Timer, press **CANCEL** in this step.

Using Sleep Timer

With Sleep Timer, you can fall asleep to your favorite music.

You can set Sleep Timer when the unit is turned on.

How Sleep Timer actually works

The unit automatically turns off after the specified time length passes.

- 1 Press **SLEEP** on the remote control.

- Each time you press the button, the time length changes as follows:

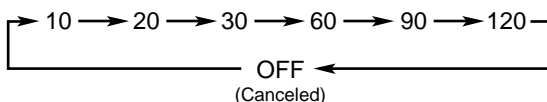

- 2 Wait for about 3 seconds after specifying the time length.

The display window dims.

To check the remaining time until the shut-off time, press **SLEEP** once. The remaining time until the shut-off time appears for about 5 seconds.

To change the shut-off time, press **SLEEP** repeatedly until the desired time length appears.

To cancel the setting, press **SLEEP** repeatedly until **"SLEEP OFF"** appears.

- Turning off the unit also cancels Sleep Timer

Timer Priority

Since each timer can be set separately, you may wonder what happens if the setting for these timers overlaps. Here are the priorities for each timer.

- **Recording Timer has priority over Daily Timer and Sleep Timer.**

If Daily Timer is set to come on while Recording Timer is operating, Daily Timer will not come on at all.

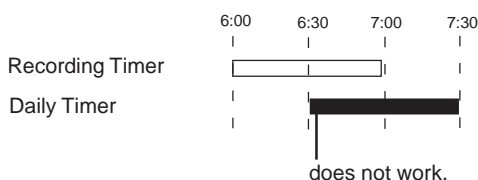

If Recording Timer is set to come on while Sleep Timer is operating, Sleep Timer will be canceled several seconds before Recording Timer comes on.

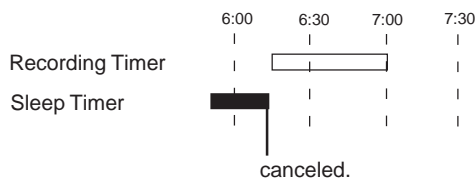

- **Sleep Timer has priority over Daily Timer.**

If Daily Timer is set to come on while Sleep Timer is operating, Daily Timer will not come on at all.

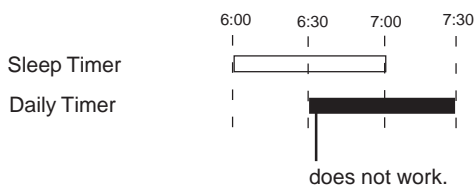

Therefore, the equation is like this —

Recording Timer > Sleep Timer > Daily Timer

Maintenance



To get the best performance of the unit, keep your discs and mechanism clean.

General Notes

In general, you will have the best performance by keeping your CDs, MDs and the mechanism clean.

- Store CDs and MDs in their cases, and keep them in cabinets or on shelves.
- Keep the CD disc compartment, and the MD loading slot cover closed when not in use.

Handling CDs



- Remove the CD from its case by holding it at the edge while pressing the center hole lightly.
- Do not touch the shiny surface of the disc, or bend the CD.
- Put the CD back in its case after use to prevent warping.

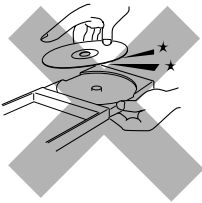

- Be careful not to scratch the surface of the CD when placing it back in its case.
- Avoid exposure to direct sunlight, temperature extremes, and moisture.



To clean the CD

Wipe the CD with a soft cloth in a straight line from center to edge.



DO NOT use any solvent — such as conventional record cleaner, spray, thinner, or benzine — to clean the CD.

Handling MDs



- Do not open the shutter.
 - The shutter is locked so that it will not open. Trying to force it open will break the MD. If the shutter opens accidentally, close it again quickly without touching the MD inside.

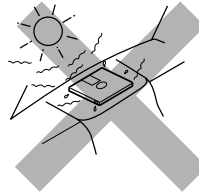

- Do not place MDs in the following places:
 - High temperature areas such as in direct sunlight or inside a car.
 - High humidity areas, e.g. in a bathroom.
 - On a beach or sandy area.

- Clean MDs regularly.
 - If dust or dirt gets on cartridge, wipe it off with a soft dry cloth.

Additional Information

MD Disc Types

There are two types of MDs: Premastered (prerecorded) and Recordable (blank).

Premastered MDs

Premastered MDs, which have been recorded at music studio, can be played back like regular CDs. On an MD of this type, data is recorded as the presence or absence of tiny pits. A laser beam focuses on the pits on the surface of the MD and reflects the detection back to the lens in the MD recorder. The MD recorder then decodes the signals and plays them back as music. This type of MD is called an “optical disc.”

Recordable MDs

Recordable MDs, which use magneto-optical technology, can be recorded and played back repeatedly. The laser inside the MD recorder applies heat to the MD, demagnetizing the magnetic layer of the MD for recording and playback. This type of MD is called an “magnetic-optical disc.”

ATRAC (Adaptive TTransform Acoustic Coding)

The MD provides 74 minutes recording and playback time, the same as an audio CD, but in a diameter of only 64 mm. This ability to store such a large amount of data is the result of ATRAC, an audio compression technique developed for MD. This technology cuts out faint sounds that would not be heard by the human beings. This technology, based on human sensitivity to sounds, reduces recorded data volume up to about one-fifth of that of the original data.

UTOC (User Table Of Contents)

Found only on recordable MDs, this area contains sub-data (track number, recording data, etc.) which can be rewritten by the user.

UTOC enables us to search tracks quickly and edit tracks on the MD.

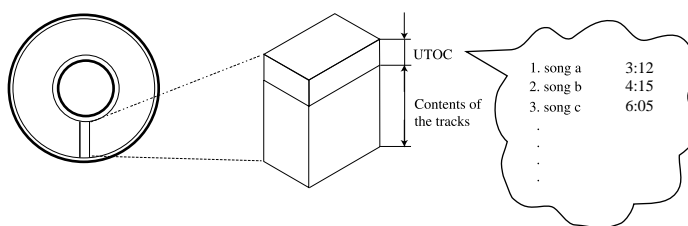

Serial Copy Management System (SCMS)

The MD recorder integrated to this unit uses the Serial Copy Management System which allows only first-generation digital copies to be made of premastered software (like CDs or prerecorded MDs).

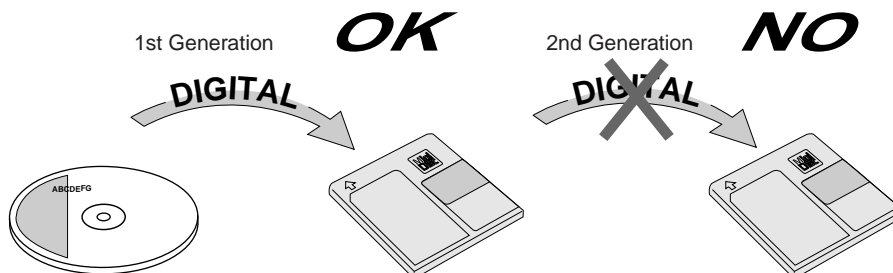



Sound Skip Guard Memory

The biggest weakness of discs is their susceptibility to vibration. The “Sound Skip Guard Memory” has been developed to cope with this weakness.

With this function, a few seconds of signals read by the optical read head from the disc are first stored in memory before being reproduced as audio signals. Thus, even when vibration or shock interrupts signals being read, these stored signals can continue to reproduce sounds for the few seconds. Thus, the user will enjoy uninterrupted music.

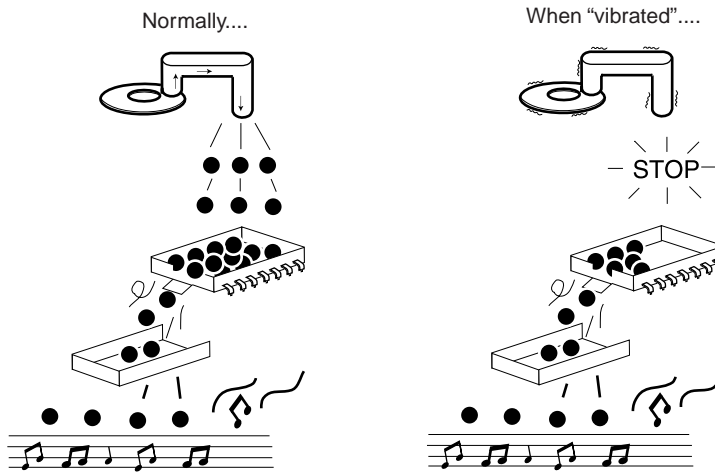

MD limitations

The MD records data in an original format that differs from that of conventional cassette tapes or DATs. Since there are some limitations with this recording format, the following types of symptoms may occur. These symptoms are not malfunctions.

Symptoms	Cause
“DISC FULL” appears, even though there is still enough remaining time on an MD.	There is a maximum number of tracks which can be recorded, regardless of recording time. More than 254 tracks cannot be recorded on an MD.
“DISC FULL” appears even though the number of tracks and recording time do not reach the limit.	<ul style="list-style-type: none"> Repeating erasure and recording on the same MD creates many blank portions sparsely on the MD. When recording on such an MD, a track is recorded on these blank portions sparsely. If a track is divided and recorded into so many portions, “DISC FULL” appears. If a divided portion of less than 8 seconds is made while a track is recorded on the MD, that track cannot be joined to another track using the JOIN function. Furthermore, if that track is erased, the remaining time of the MD may not increase exactly by the erased amount. If a track has been divided into many portions while being recorded on the MD, sounds will drop out while fast forwarding or reversing such an MD.
The JOIN function sometimes does not work.	
The remaining time on the MD does not increase even when tracks are erased.	
The sound drops out during fast forward or fast rewind.	
The amount of recorded time on the MD added to the amount of remaining time is shorter than the MD’s total possible recording time.	

Troubleshooting

If you are having a problem with your unit, check this list for a possible solution before calling for service. If you cannot solve the problem from the hints given here, or the unit has been physically damaged, call a qualified person, such as your dealer, for service.

Symptom	Possible Cause	Action
No sound is heard.	Connections are incorrect, or loose.	Check all connections and make corrections. (See pages 6 – 9.)
Unable to record on an MD.	<ul style="list-style-type: none"> You are using a prerecorded MD. The MD is write-protected. 	<ul style="list-style-type: none"> Change it with a recordable MD. Unprotect the MD. (See page 51.)
Poor radio reception.	<ul style="list-style-type: none"> The antenna is not connected correctly. The AM loop antenna is too close to the unit. The FM antenna is not properly extended and positioned. 	<ul style="list-style-type: none"> Reconnect the antenna securely. Change the position and direction of the AM loop antenna. Extend FM antenna to the best reception position.
The CD skips.	The CD is dirty or scratched.	Clean or replace the CD. (See page 47.)
Unable to operate the remote control.	<ul style="list-style-type: none"> The path between the remote control and the remote sensor on the unit is blocked. The batteries have lost their charge. 	<ul style="list-style-type: none"> Remove the obstruction. Replace the batteries.
The number buttons and CD/MD/tuner control buttons on the remote control do not function correctly.	The operation modes for the unit and for the remote control do not match.	Match them correctly.
Loaded CDs and MD cannot be ejected.	<ul style="list-style-type: none"> The main AC power cord is not plugged in. The Disc Lock function is turned on. 	<ul style="list-style-type: none"> Plug in the AC power plug. Turn off the Disc Lock function. (See page 22.)
The CD does not play.	The CD is upside down.	Put the CD in with the label side up.
Operations are disabled.	The built-in microprocessor has malfunctioned due to external electrical interference.	Unplug the unit then plug it back in.



MD Messages

Message	Signification	Solution
BLANK DISC	The disc is blank.	Change the MD with another if you want to enjoy playback.
CANNOT JOIN	You are trying to join tracks which cannot be joined.	This is not a malfunction. (See MD limitations on page 49.)
DISC ERROR	There is a problem with this MD.	Change the MD.
DISC FULL	There is no more space on the MD or there are over 254 tracks.	Use another recordable MD or erase some tracks.
EMERGENCY STOP	A malfunction has occurred during the recording.	Eject the MD and re-insert it.
MD NO DISC	There is no MD.	Put an MD.
NON-AUDIO CANNOT COPY	You are trying to copy a non-audio disc like a CD-ROM or a Video CD.	Stop recording.
PLAYBACK MD	You are trying to edit or record on a playback-only MD.	Use a recordable MD.
DISC PROTECTED	The MD is write-protected.	Unprotect the MD or use another. (See page 27.)
SCMS CANNOT COPY	Digital copy of the 2nd generation is prohibited.	Use an analog recording method.
DIGITAL IN UNLOCK	There is no digital device connected to the AUX DIGITAL IN OPTICAL terminal.	Connect a digital device using digital optical cord.

Specifications



Amplifier

Output Power (IEC 268-3/DIN)

37 watts per channel, min. RMS, both channels driven into 6 ohms at 1 kHz with no more than 0.9% total harmonic distortion.

Audio input sensitivity/Impedance (at 1 kHz)

Analog input:

TAPE 200 mV/47 kohms

AUX 500 mV/47 kohms

Digital input:

AUX: Optical

Signal wave length: 660 nm

Input level: -23 dBm to -15 dBm

(With the built-in sampling rate converter, corresponding to 32 kHz/44.1 kHz/48 kHz)

Audio output level/Impedance (at 1 kHz)

TAPE 170 mV/3.9 kohms

Speakers/Impedance: 6 ohms

Tuner

FM tuning range: 87.50 – 108.00 MHz

AM tuning range: MW: 522 – 1,629 kHz

LW: 144 – 288 kHz

CD player

CD Capacity: 3 CDs

Dynamic range: 92 dB

Signal-to-noise ratio: 100 dB

Wow and flutter: Immeasurable

MD recorder

Audio playing system: MiniDisc digital audio system

Recording system: Magneto-optical overwrite system

Reading system: Non-contact, semiconductor laser pickup ($\lambda=780$ nm)

Error correction system: CIRC (Cross Interleave Reed-Solomon Code)

Sampling frequency: 44.1 kHz
(With sampling rate converter for recording — 32 kHz/44.1 kHz/48 kHz)

Audio compression system:

ATRAC (Adaptive TRansform Acoustic Coding)

General

Power requirement: AC 230 V \sim , 50 Hz

Power consumption: 105 watts (at operation)

11 watts (on standby: with Demo off)

15 watts (on standby: with Demo on)

Dimensions (approx.): 245 x 280 x 346 mm (W/H/D)
(9¹¹/₁₆ x 11¹/₁₆ x 13³/₈ in.)

Mass (approx.): 7.8 kg (17.2 lbs)

Supplied accessories

See page 6.

Design and specifications are subject to change without notice.

Free Manuals Download Website

<http://myh66.com>

<http://usermanuals.us>

<http://www.somanuals.com>

<http://www.4manuals.cc>

<http://www.manual-lib.com>

<http://www.404manual.com>

<http://www.luxmanual.com>

<http://aubethermostatmanual.com>

Golf course search by state

<http://golfingnear.com>

Email search by domain

<http://emailbydomain.com>

Auto manuals search

<http://auto.somanuals.com>

TV manuals search

<http://tv.somanuals.com>