

# JVC

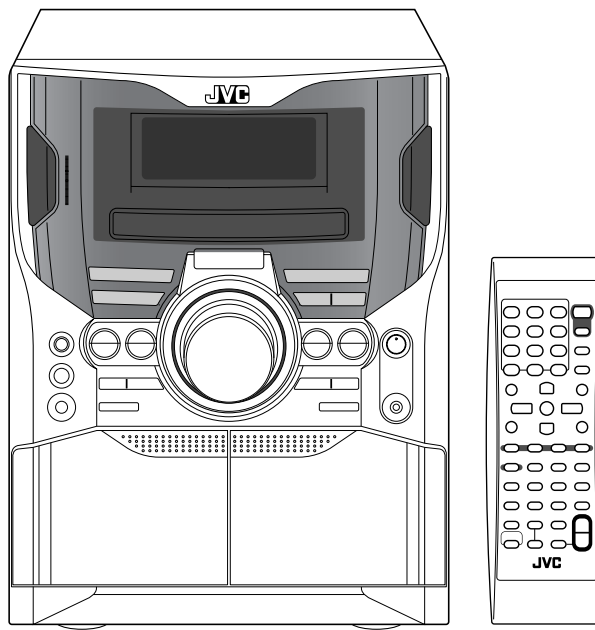

## COMPACT COMPONENT SYSTEM

# CA-MXDK11



**ACTIVE BASS EXTENSION**

## INSTRUCTIONS

GVT0205-001A  
[UN,UG,UX,A,UW]

# Warnings, Cautions and Others

## Caution— ⏻/I (standby/on) button!

Disconnect the mains plug to shut the power off completely (the STANDBY lamp goes off). When installing the apparatus, ensure that the plug is easily accessible. The ⏻/I (standby/on) button in any position does not disconnect the mains line.

- When the System is on standby, the STANDBY lamp lights red.
- When the System is turned on, the STANDBY lamp goes off.

The power can be remote controlled.

## CAUTION

To reduce the risk of electrical shocks, fire, etc.:

1. Do not remove screws, covers or cabinet.
2. Do not expose this appliance to rain or moisture.

## CAUTION

- Do not block the ventilation openings or holes.  
(If the ventilation openings or holes are blocked by a newspaper or cloth, etc., the heat may not be able to get out.)
- Do not place any naked flame sources, such as lighted candles, on the apparatus.
- When discarding batteries, environmental problems must be considered and local rules or laws governing the disposal of these batteries must be followed strictly.
- Do not expose this apparatus to rain, moisture, dripping or splashing and that no objects filled with liquids, such as vases, shall be placed on the apparatus.

## IMPORTANT FOR LASER PRODUCTS

1. CLASS 1 LASER PRODUCT
2. **CAUTION:** Do not open the top cover. There are no user serviceable parts inside the unit; leave all servicing to qualified service personnel.
3. **CAUTION:** Visible and/or invisible class 1M laser radiation when open. Do not view directly with optical instruments.
4. REPRODUCTION OF LABEL: CAUTION LABEL, PLACED INSIDE THE UNIT.

<b>CAUTION</b> VISIBLE AND/OR INVISIBLE CLASS 1M LASER RADIATION WHEN OPEN, DO NOT VIEW DIRECTLY WITH OPTICAL INSTRUMENTS. IEC60825-1:2001 (ENG)	<b>ATTENTION</b> RAYONNEMENT LASER VISIBLE ET/OU INVISIBLE DE CLASSE 1M UNE FOIS OUVERT, NE PAS REGARDER DIRECTEMENT AVEC DES INSTRUMENTS OPTIQUES. (FRA)	<b>AVISO</b> RADIACION LÁSER DE CLASE 1M VISIBLE Y/O INVISIBLE CUANDO ESTA ABIERTO, NO MIRAR DIRECTAMENTE CON INSTRUMENTAL ÓPTICO. (ESP)	<b>VARNING</b> SYNLIG OCH/ELLER OSYNLIG LASERSTRÅLNING, KLASS 1M, NÄR DENNA ÄR ÖPPNAD. BETRAKTA EJ STRÅLEN MED OPTISKA INSTRUMENT. (SWE)	<b>注意</b> ここを開くと可視 及び/または不可視 のクラス1M レーザー放射が 出ます。 光学装置で直接 見ないでください。 (JPN)	<b>CAUTION</b> VISIBLE AND/OR INVISIBLE CLASS II LASER RADIATION WHEN OPEN, DO NOT STARE INTO BEAM. FDA 21 CFR (ENG) LV44603-003A
--	--	---	---	--	---

**Caution: Proper Ventilation**

To avoid risk of electric shock and fire, and to prevent damage, locate the apparatus as follows:

1. Front: No obstructions and open spacing.
2. Sides/ Top/ Back: No obstructions should be placed in the areas shown by the dimensions below.
3. Bottom: Place on the level surface. Maintain an adequate air path for ventilation by placing on a stand with a height of 10 cm or more.

The minimal clearance is shown as below:

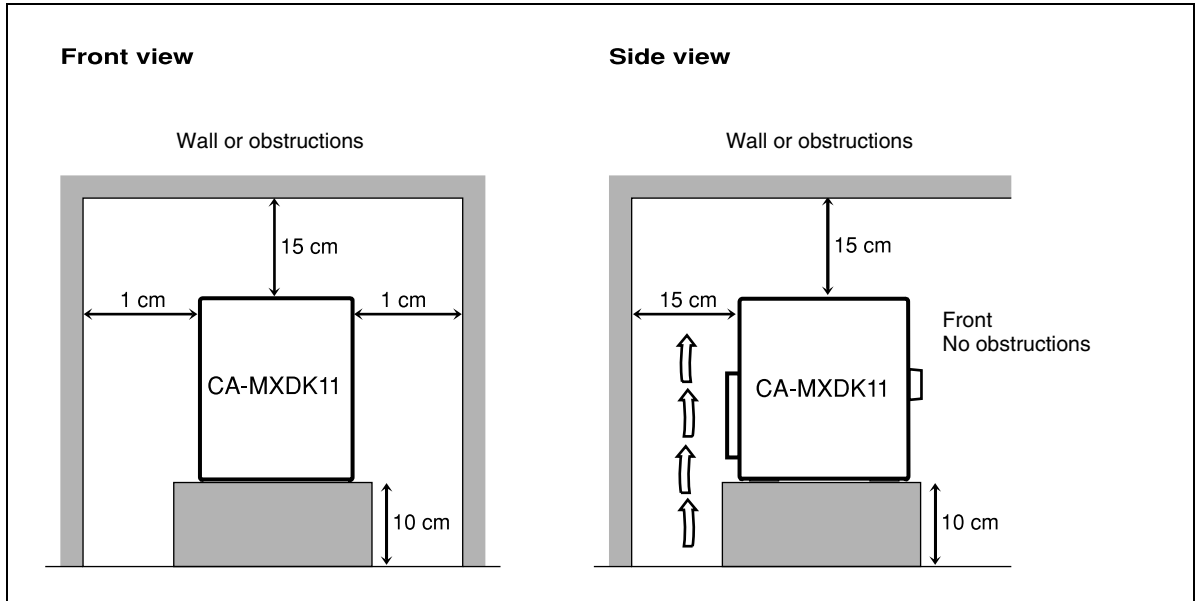

# Introduction

## Precautions

### Installation

- Install the System in a location with adequate ventilation to prevent internal heat buildup in the System.



DO NOT install the System in a location near heat sources, or in a place subject to direct sunlight, excessive dust or vibration.

- Install in a place which is level, dry and neither too hot nor too cold—between 5°C and 35°C.
- Leave sufficient distance between the System and the TV.
- Keep the speakers away from the TV to avoid interference with the TV.

### Power sources

- When unplugging the System from the wall outlet, always pull on the plug, not the AC power cord.



DO NOT handle the AC power cord with wet hands.

### Moisture condensation

Moisture may condense on the lenses inside the System in the following cases:

- After starting to heat the room
- In a damp room
- If the System is brought directly from a cold to a warm place.

Should this occur, the System may malfunction. In this case, leave the System turned on for a few hours until the moisture evaporates, unplug the AC power cord, then plug it in again.

### Internal heat

- Make sure there is good ventilation around the unit. Poor ventilation could overheat and damage the unit.



DO NOT block the ventilation openings or holes. If they are blocked by a newspaper or cloth, etc., the heat may not be able to get out.

### Others

- Should any metallic object or liquid fall into the System, unplug the AC power cord and consult your dealer before operating any further.



DO NOT disassemble the System since there are no user serviceable parts inside.

- If you are not going to operate the System for an extended period of time, unplug the AC power cord from the wall outlet.

If anything goes wrong, unplug the AC power cord and consult your dealer.

## Playable Disc Types

INFO



Video CD



DVD Logo is a trademark of DVD Format/Logo Licensing Corporation.

• CD-R/-RW/-ROM: Recorded in the Audio CD(CD-DA), Video CD and SVCD formats. MP3, WMA, JPEG, MPEG-1 and MPEG-2 files written in accordance with the “ISO 9660” format can also be played.

• DVD-R/-RW: Recorded in the DVD Video format or the DVD Video Recording (VR) format. MP3, WMA, JPEG, MPEG-1 and MPEG-2 files written in the UDF-Bridge format can also be played.

In addition to the above discs, this System can play back audio data recorded on CD Text, and CD-Extra.

- It is possible to play back finalized +R/+RW (DVD Video format only) discs. “DVD” lights on the front display panel when a +R/+RW disc is loaded.
- The following discs cannot be played back: DVD-ROM, DVD-RAM, CD-I (CD-I Ready), CD-G (CD Graphics), Photo CD, etc. Playing back these discs will generate noise and damage the speakers.
- This unit cannot play back DVD-VR discs with CPRM (Content Protection for Recordable Media).
- In this manual, “file” and “track” are interchangeably used for MP3/WMA/JPEG/MPEG-1/MPEG-2 operations.

### About color system

This System accommodates both NTSC and PAL system and can play back discs recorded with either system. To change the color system, see page 6.

### Note on Region Code

DVD players and DVDs have their own Region Code numbers. This System can play back only DVDs with Region Code numbers including “4” for Australia and Central and South America, “3” for Southeast Asia, and “2” for the Middle East. For your available Region code, check the rear panel of your main unit.

EX.: For Southeast Asia



If a DVD with the improper Region Code numbers is loaded, “REGION ERR” appears on the display and playback will not start.

The System can play back the following digital audio formats.

- **LPCM** (Linear PCM), **Dolby DIGITAL** (Dolby Digital), **DTS** (Digital Theater Systems)

### Caution for DualDisc playback

The Non-DVD side of a “DualDisc” does not comply with the “Compact Disc Digital Audio” standard. Therefore, the use of Non-DVD side of a DualDisc on this product may not be recommended.







#### **IMPORTANT: Before playing a disc, make sure of the following...**

- Turn on the TV and select an appropriate input mode on the TV to view the pictures or on-screen displays on the TV screen.
- For disc playback, you can change the initial setting to your preference. See “Setup Menu Operations” on page 34.

If “” appears on the TV screen when you press a button, the disc cannot perform the operation you have tried to do, or data required for that operation is not recorded on the disc.

## How to Read This Manual

- Button and control operations are explained in the table below.
- **Some related tips and notes are explained later in the sections “Learning More about This System” and “Troubleshooting,” but not in the same section explaining the operations (  indicates that the content has some information).**

	Indicates that you press the button <b>briefly</b> .
	Indicates that you press the button <b>briefly and repeatedly</b> until an option you want is selected.
	Indicates that you press one of the buttons.
	Indicates that you <b>press and hold</b> the button for a specified period. The number inside the arrow indicates the time to hold (in the example, 2 seconds).
	Indicates that you turn the control toward the specified direction(s).
	Indicates that this operation is only possible using the remote control.
	Indicates that this operation is only possible using the buttons and controls on the main unit.

## Contents

<b>Connections</b> .....	<b>3</b>
Preparing the Remote Control .....	6
Changing the Color System .....	6
Canceling the Demonstration .....	6
<b>Display Indication</b> .....	<b>7</b>
<b>Daily Operations—Playback</b> .....	<b>8</b>
<b>Daily Operations—Sound &amp; Other Adjustments</b> ....	<b>12</b>
Reinforcing the Bass Sound .....	12
Presetting Automatic DVD Video Sound	
Increase Level .....	12
Creating 3-dimensional Sound Field—3D Phonic .....	13
Selecting the Sound Modes .....	13
Creating Your Own Sound Modes—User Mode .....	13
Changing the Picture Tone .....	14
Changing the Display Brightness .....	14
Setting the Clock .....	14
<b>Unique DVD/VCD Operations</b> .....	<b>15</b>
Selecting the Sound Track .....	15
Selecting the Subtitle Language .....	16
Selecting the View Angle .....	16
Special Picture Playback .....	17
<b>Advanced Disc Operations</b> .....	<b>18</b>
Programming the Playing Order—Program Play .....	18
Playing at Random—Random Play .....	19
Playing Repeatedly .....	20
Prohibiting Disc Ejection—Child Lock .....	20
<b>On-Screen Bar Operations</b> .....	<b>21</b>
<b>Recording Operations</b> .....	<b>26</b>
<b>Enjoying Karaoke</b> .....	<b>28</b>
Singing Along (Karaoke) .....	28
Adjusting the key (disc playback only) .....	29
Applying an echo to your voice .....	29
Singing Along Using Stereo Discs—Vocal Masking .....	29
Microphone Mixing .....	30
Reserving Karaoke Songs—Karaoke Program Play .....	31
<b>Timer Operations</b> .....	<b>32</b>
<b>Setup Menu Operations</b> .....	<b>34</b>
<b>Operating the TV</b> .....	<b>36</b>
<b>Additional Information</b> .....	<b>37</b>
Learning More about This System .....	37
Troubleshooting .....	40
Maintenance .....	41
Specifications .....	42
OPTICAL DIGITAL OUTPUT Signals .....	43
<b>Parts Index</b> .....	<b>44</b>

# Connections

**Do not connect the AC power cord until all other connections have been made.**

- Connect VIDEO OUT directly to the video input of your TV. Connecting VIDEO OUT to a TV via a VCR may cause a monitor problem when playing back a copy-protected disc. You may also have a monitor problem when connecting the player to an integrated TV/Video system.

## Supplied Accessories

- FM antenna (1)
  - AM loop antenna (1)
  - Composite video cord (1)
  - Remote control (1)
  - Batteries (2)
  - AC plug adaptor (1) (not supplied for the Middle East and Australia)
- If any item is missing, consult your dealer immediately.

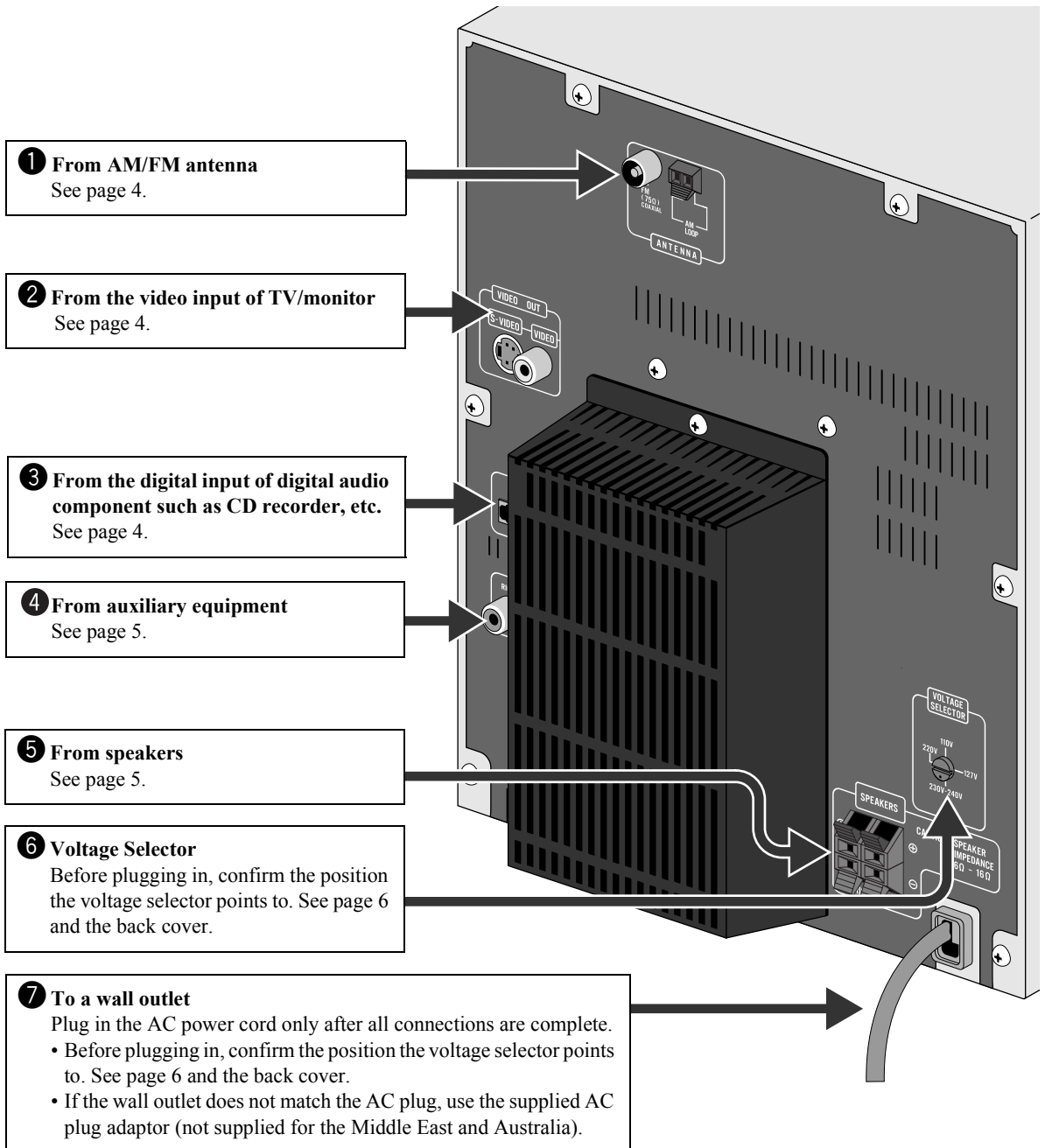

## 1 AM/FM antenna

To assemble the AM loop antenna

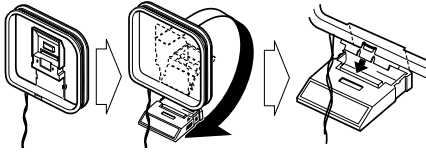

To connect AM/FM antenna

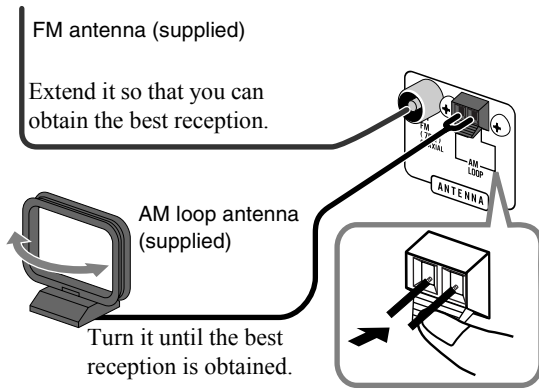

For better FM reception

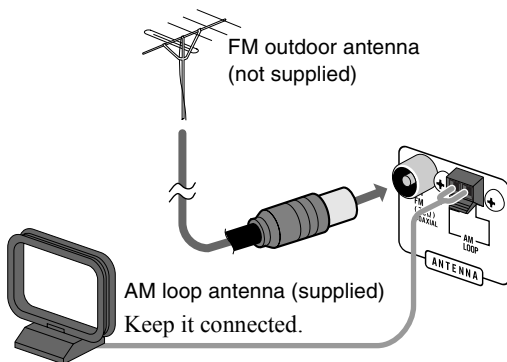

- Disconnect the supplied FM antenna, and connect to an outdoor FM antenna using a 75  $\Omega$  wire with coaxial type connector (IEC or DIN45325).
- Make sure the antenna conductors do not touch any other terminals, connecting cords or the power cord. Also, keep the antennas away from metallic parts of the System, connecting cords, and the AC power cord. This could cause poor reception.

## 2 TV/monitor

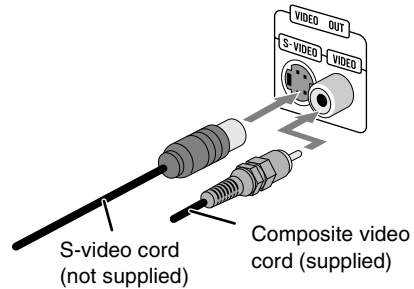

- Connect the VIDEO jack or S-VIDEO jack whichever you want to use. If your TV is equipped with the S-VIDEO input jack, S-VIDEO connection gives you better quality pictures.
- To select the video output to match the color system of your TV (PAL or NTSC), see page 6.

## 3 Digital audio component

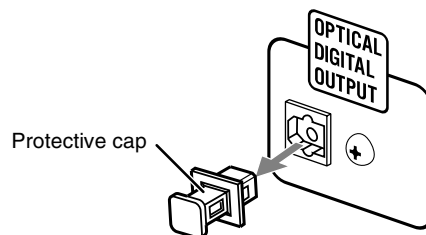

- Set "DIGITAL AUDIO OUTPUT" in the "AUDIO" preference display correctly according to the connected digital audio equipment (see page 35). Digital audio signals are output from this System only when "DVD/CD" is selected as the source.

## 4 Auxiliary equipment

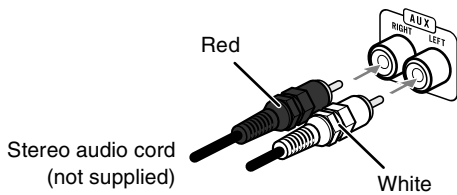

### For the Australian model

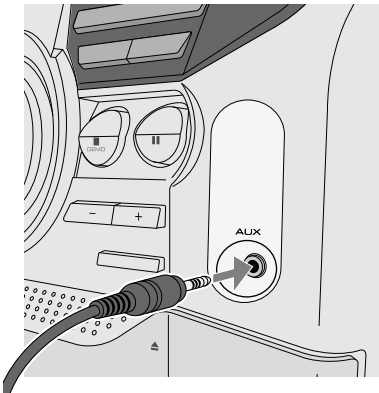

Stereo mini plug  
(not supplied)

## 5 Speakers

- When connecting the speaker cords, match the polarity of the speaker terminals: (+) to (+) and (-) to (-).

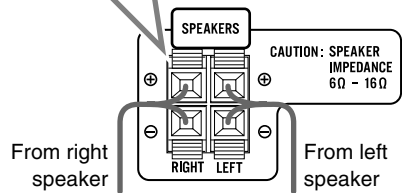
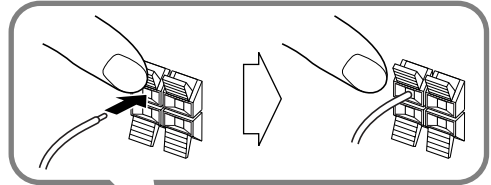

- Use only speakers with the same speaker impedance as indicated by the speaker terminals on the rear of the unit.
  - The speakers are magnetically shielded to avoid color distortions on TVs. However, if not installed properly, it may cause color distortions. So, pay attention to the following when installing the speakers.
    - When placing the speakers near a TV set, turn off the TV's main power switch or unplug it before installing the speakers.
- Then wait at least 30 minutes before turning on the TV's main power switch again.

Some TVs may still be affected even though you have followed the above. If this happens, move the speakers away from the TV.



- DO NOT connect more than one speaker to each terminal.
- DO NOT push or pull the speakers as this will damage the foot spacers at the bottom of the speakers.



## 6 Voltage Selector

Use a screwdriver to rotate the voltage selector so that the voltage mark is pointing to the same voltage as where you are plugging in the unit. (See also the back cover page.)

When your mains lead (AC) line voltage is 230-240 V

When your mains lead (AC) line voltage is 220 V

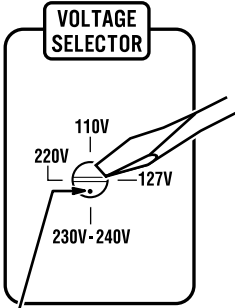

Voltage mark

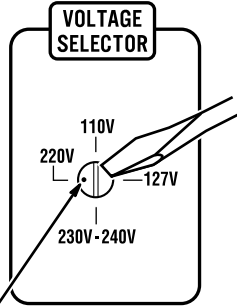

Voltage mark

When your mains lead (AC) line voltage is 110 V

When your mains lead (AC) line voltage is 127 V

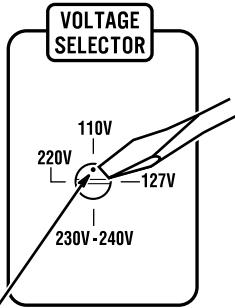

Voltage mark

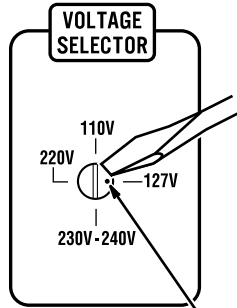

Voltage mark



DO NOT plug in before setting the voltage selector on the rear of the unit and all connection procedures are complete.

## Preparing the Remote Control

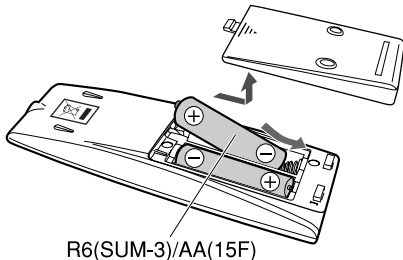

R6(SUM-3)/AA(15F)

### When using the remote control

Point the top of the remote control toward the remote sensor as directly as possible. If you operate it from a diagonal position, the operating range (approx. 5 m) may be shorter.

If the range or effectiveness of the remote control decreases, replace both batteries.

### Caution

Do not expose batteries to heat or flame.

## Changing the Color System



You can select the video output to match the color system of your TV (PAL or NTSC).

### 1 Enter the color system setting mode.

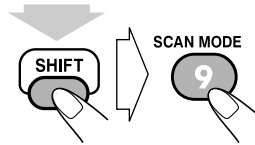

(While holding...)

### 2 Select the color system.

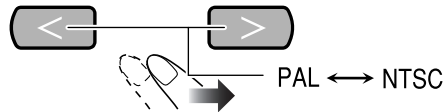

### 3 Store the setting.

ENTER/SET



## Canceling the Demonstration



When you plug in the AC power cord to a wall outlet, the System automatically starts the display demonstration.

2 sec.

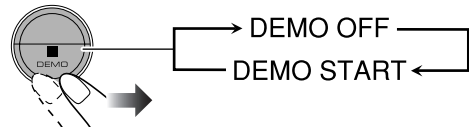

To start the demonstration, select DEMO START.

# Display Indication

The indications on the display tell you a lot of things while you are operating the System.

**Before operating the System, be familiar with when and how the indicator illuminates on the display.**

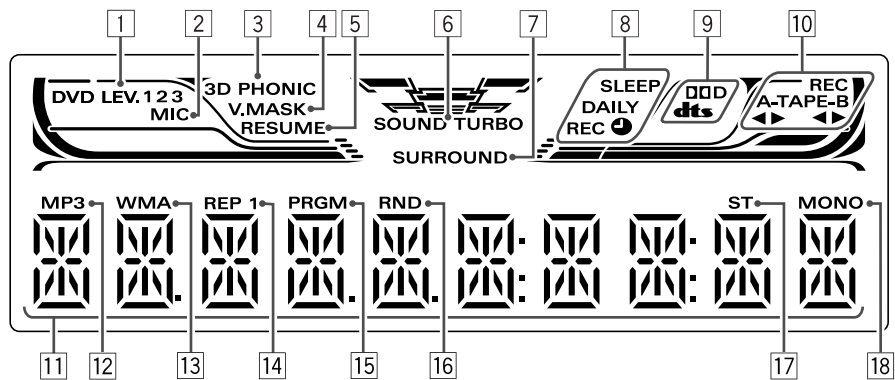

- 1 DVD LEV. 1/2/3 indicators
  - Lights to indicate the DVD increase level (see page 12).
- 2 MIC indicator
  - Lights when the Karaoke mode is activated (see page 28).
- 3 3D PHONIC indicator
  - Lights when 3D Phonic is activated (see page 13).
- 4 V.MASK indicator
  - Lights when the Vocal Masking mode is activated (see page 29).
- 5 RESUME indicator
  - Lights when the Resume function is activated (see page 10).
- 6 SOUND TURBO indicator
  - Lights when SOUND TURBO II is activated (see page 12).
- 7 SURROUND indicator
  - Lights when Surround mode is activated (see page 13).
- 8 Timer indicators (see pages 32 and 33)
  - SLEEP: flashes when the Sleep Timer is activated.
  - DAILY: lights when the Daily Timer is on standby; flashes while working or being set.
  - REC: lights when the Recording Timer is on standby; flashes while working or being set.
  - : lights when Sleep Timer is working or when Daily Timer or Recording Timer is on standby, working or being set.
- 9 Source signal indicators
  - D: lights when a source signal is Dolby Digital.
  - DTS: lights when a source signal is DTS.
- 10 Tape operation indicators
  - REC: lights while recording (see pages 26 and 27).
  - TAPE-A: lights when TAPE-A is selected.
  - TAPE-B: lights when TAPE-B is selected.
  - (tape direction):
    - Lights to indicate the current tape running direction.
    - Flashes slowly during playback and recording.
    - Flashes quickly while rewinding a tape.
- 11 Main display
- 12 MP3 indicator
  - Lights while playing back an MP3 track.
- 13 WMA indicator
  - Lights while playing back a WMA track.
- 14 Repeat Mode indicators
  - REP: lights when Repeat Play mode is activated.
  - 1: lights when One Track/Chapter/Step Repeat is activated.
- 15 PRGM indicator
  - Lights when Program Play mode is activated.
- 16 RND indicator
  - Lights when Random Play is activated.
- 17 ST (stereo) indicator
  - Lights while an FM stereo station with sufficient signal strength is tuned in (see page 9).
- 18 MONO indicator
  - Lights while receiving an FM stereo station in monaural (see page 9).

# Daily Operations—Playback

In this manual, the operations using the remote control are mainly explained; however, you can use the buttons and controls on the main unit if they have the same (or similar) name and marks.

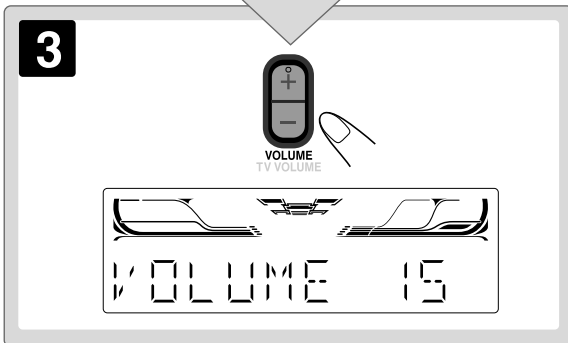
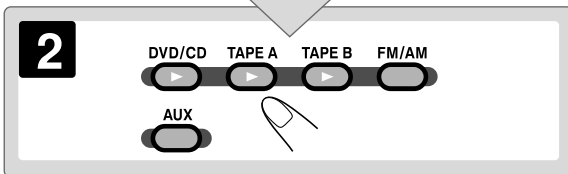
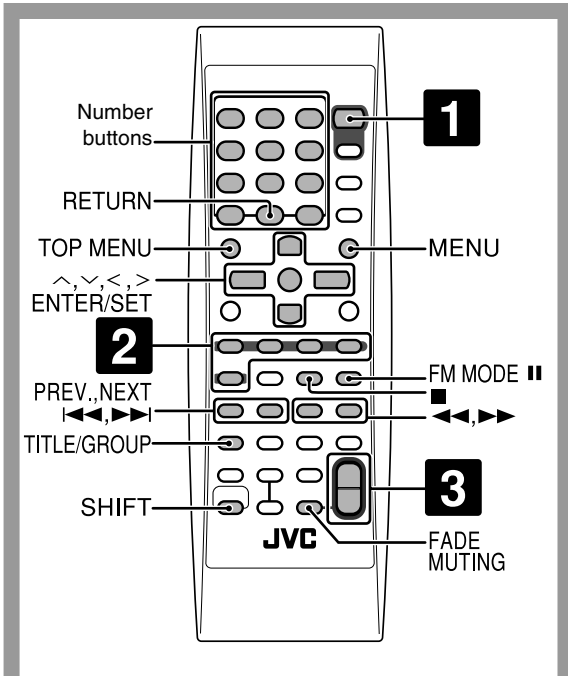

## 1 Turn on the power.

The STANDBY lamp on the main unit goes off.

- Without pressing **⏻/AUDIO**, the System also turns on by pressing one of the source selecting buttons in the next step.

## 2 Select the source.

Playback automatically starts if the selected source is ready to start playback.

- If you press **AUX**, start playback on the external component.

## 3 Adjust the volume.

## 4 Operate the target source as explained later.

### To turn off (standby) the System



The STANDBY lamp on the main unit lights in red.

- A small amount of power is always consumed even while on standby.

### For private listening

Connect a pair of headphones to the PHONES jack on the main unit. The sound will no longer come out of the speakers. **Be sure to turn down the volume before connecting or putting on the headphones.**

- Disconnecting the headphones will activate the speakers again.

**STOP!**

DO NOT turn off (standby) the System with the volume set to an extremely high level; otherwise, the sudden blast of sound can damage your hearing, speakers and/or headphones when you turn on the System or start playback.

### Adjusting the Volume

The volume level can be adjusted in 32 steps (VOLUME MIN, VOLUME 1 – VOLUME 30, and VOLUME MAX).

Remote control:	Main unit:
<p>VOLUME TV VOLUME</p>	<p>VOLUME</p>

Continued on the next page...

## To drop the volume in a moment



To restore the volume, press again, or adjust the volume level.

## Listening to the Radio

INFO

### To select the AM tuner interval spacing



Some countries space AM stations 9 kHz apart, and other countries use 10 kHz spacing.

#### 1 Select "AM," then turn off (standby) the System.

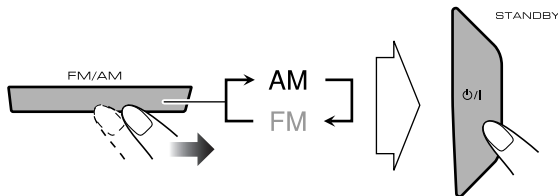

#### 2 Select the appropriate AM space interval for your area.

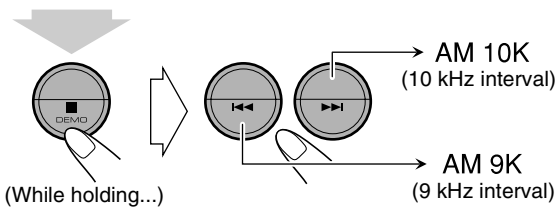

### To select the band (FM/AM)

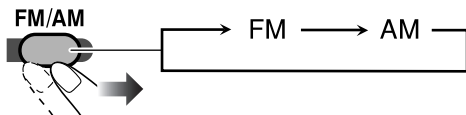

### To tune in to a station



While FM or AM is selected...

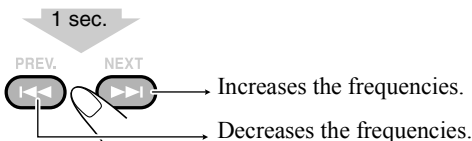

Frequency starts changing on the display.

When a station (frequency) with sufficient signal strength is tuned in, the frequency search stops.

- When you repeatedly press the button, the frequency changes step by step.

To stop searching manually, press either button.

### If the FM reception is poor



The MONO indicator lights on the display. Reception will improve though stereo effect is lost—monaural reception mode. To restore the stereo effect, press the button again (the MONO indicator goes off).

### To preset stations



You can preset 30 FM and 15 AM stations.

#### 1 Tune in to a station you want to preset.

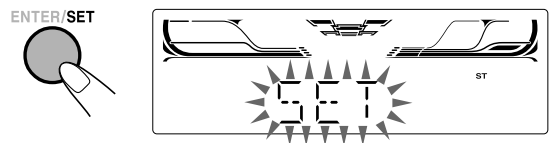

#### 2 Select a preset number.

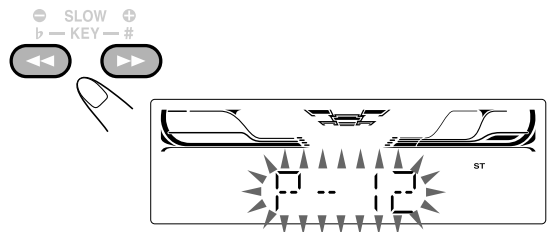

#### 3 Store the station.



### To tune in to a preset station

#### 1 Select the band (FM or AM).

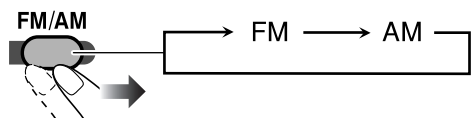

#### 2 Select the preset number for the preset station.

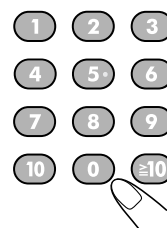

#### Examples:

To select number 5, press 5.

To select number 10, press 10.

To select number 15, press  $\geq 10$ , 1, then 5.

To select number 30, press  $\geq 10$ , 3, then 0.

- You can also use  $\lll$  or  $\ggg$  buttons.

## Playing Back a Disc INFO

Before operating a disc, be familiar how a disc is recorded.

- DVD Video/DVD-VR consist of “Titles” which include “Chapters,” MP3/WMA/MPEG-1/MPEG-2 consist of “Groups” which include “Tracks,” JPEG consist of “Groups” which include “Files,” and CD/SVCD/VCD consist of only “Tracks.”
- For DVD-VR/MP3/WMA/JPEG/MPEG-1/MPEG-2 playback, see also “Operations on the Control Screen” on page 24.

### To insert discs

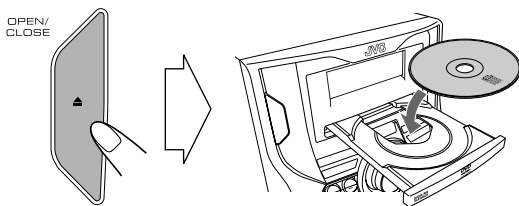

- When using an 8 cm disc, place it on the inner circle of the disc tray.

To close the disc tray, press OPEN/CLOSE ▲ again. If you press DVD/CD ►, disc tray closes automatically and playback starts.

To start:	To pause:	To stop:
	 To release it, press DVD/CD ►.	

### On-screen guide icons

• During disc playback, the following icons may appear for a while on the TV screen:

- Appears at the beginning of a scene containing multi-angle views.
- Appears at the beginning of a scene containing multi-audio languages.
- Appears at the beginning of a scene containing multi-subtitle languages.

• The following icons will be also shown on the TV screen to indicate your current operation.



- To deactivate the on-screen guide icons, see “ON SCREEN GUIDE” on page 35.

- When playing a multi-channel encoded DVDs, the System properly converts these multi-channel signals into 2 channels, and emits the downmixed sound from the speakers.

- To enjoy the powerful sound of these multi-channel encoded DVDs, connect a proper decoder or an amplifier with a proper built-in decoder to the OPTICAL DIGITAL OUT terminal on the rear.

**While playing a disc except CDs:** This System can store the stop point, and when you start playback again by pressing DVD/CD ► (even while on standby), it starts from the position where you have stopped—Resume Play. (RESUME appears on the display when you stop playback.)

To stop completely while Resume is activated, press ■ twice. (To cancel Resume, see “RESUME” on page 35.)

### To select a title/group Remote ONLY >>>

While playing a disc...

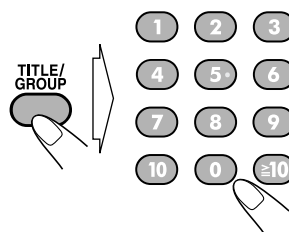

#### Examples:

- To select number 5, press 5.
- To select number 10, press 10.
- To select number 15, press ≧10, 1, then 5.
- To select number 30, press ≧10, 3, then 0.

### To select a chapter/track

While playing a disc...

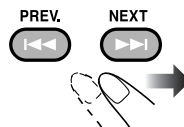

### To locate a particular portion Remote ONLY >>>

While playing a disc except MP3/WMA disc...

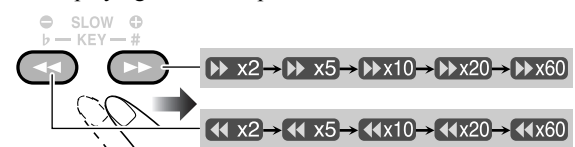

- For MP3/WMA discs, search speed and the indications on the TV are different.
- No sound comes out while searching on DVD/SVCD/VCD.

To return to normal playback, press DVD/CD ►.

## To select an item directly



You can select a title/chapter/track directly and start playback.

For DVD Video, you can select a **title before starting playback**, while you can select a **chapter after starting playback**.

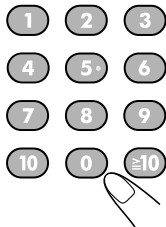

### Examples:

- To select number 5, press 5.
- To select number 10, press 10.
- To select number 15, press  $\equiv$ 10, 1, then 5.
- To select number 30, press  $\equiv$ 10, 3, then 0.

## To play back using the disc menu



You can operate the disc play—DVD and SVCD/VCD with Playback Control (PBC)—using the disc menu shown on the TV screen.

### ■ For DVD Video:

#### 1 Show the disc menu.

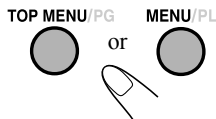

#### 2 Select an item on the disc menu.

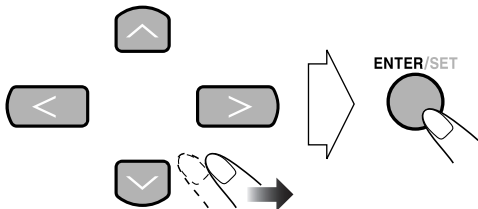

- With some discs, you can also select items by entering the number using the number buttons.

### ■ For SVCD/VCD with PBC:

While playing a disc with PBC, “PBC” appears on the display instead of the playing time.

When disc menu appears on the TV screen, select an item on the menu. Playback of the selected item starts.

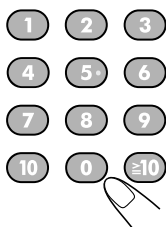

### Examples:

- To select number 5, press 5.
- To select number 10, press 10.
- To select number 15, press  $\equiv$ 10, 1, then 5.
- To select number 30, press  $\equiv$ 10, 3, then 0.

**To move to the next or previous page of the current menu:**

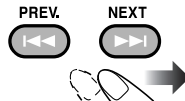

**To return to the previous menu:**

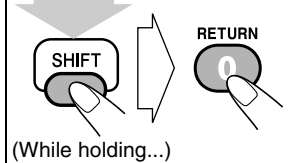

### To cancel PBC

Before playback...



You can also cancel PBC function by pressing the number button to select a track.

To reactivate PBC, press  $\lll$ .

## Playing Back a Tape

### To insert a tape

You can play back type I tapes.

- The use of C-120 or longer tapes is not recommended.

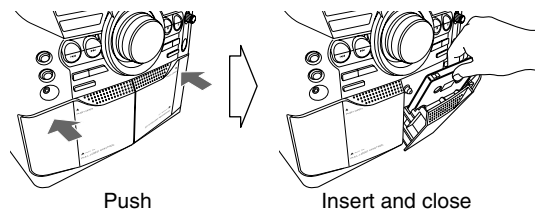

**To start:**

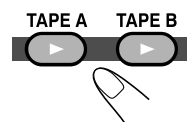

**To stop:**



**To fast-forward or rewind:**

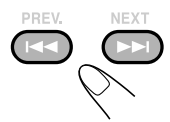

To remove the tape, press PUSH OPEN  $\blacktriangle$  on the main unit.

# Daily Operations—Sound & Other Adjustments

## Remote Control

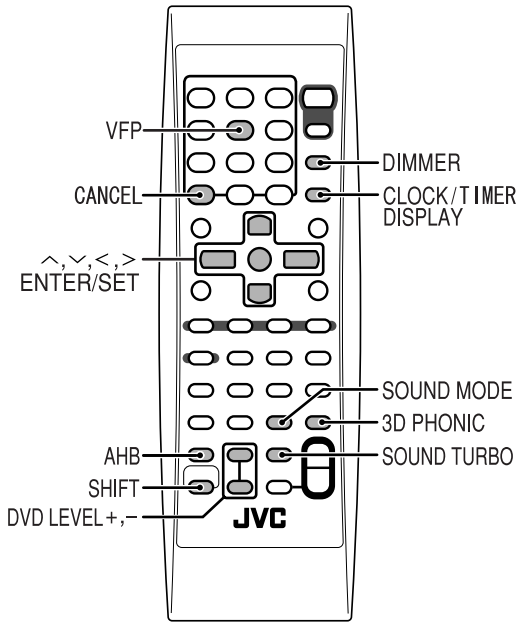

## Main unit

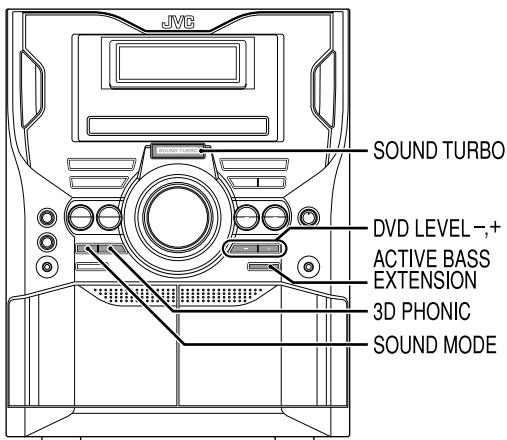

## Reinforcing the Bass Sound

### To change the bass level

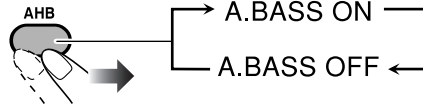

- You can also use ACTIVE BASS EXTENSION on the main unit.

## To reinforce the heavy sound—SOUND TURBO II

You can boost the low and high frequency sound.



## Presetting Automatic DVD Video Sound

### Increase Level

The DVD Video sound is sometimes recorded at a lower level than for other discs and sources. You can preset the increase level for the currently loaded DVD Video, so you do not have to adjust the volume when you change the source.



As the number is higher, sound increase level is also reinforced.

## Creating 3-dimensional Sound Field

### —3D Phonic

INFO

While playing a disc...

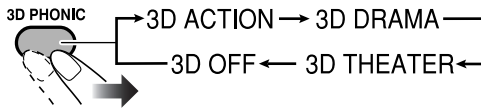

3D PHONIC ACTION On the TV screen

<b>3D ACTION</b>	Suitable for action movies and sports programs.
<b>3D DRAMA</b>	Creates natural and warm sound. Enjoy movies in a relaxed mood.
<b>3D THEATER</b>	Enjoy sound effects like in a major movie theater.

## Selecting the Sound Modes

You can select one of the preset Sound Modes.

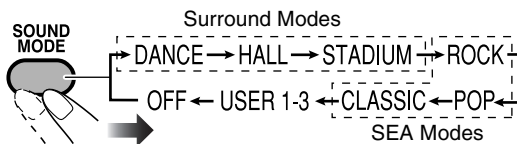

Surround Modes*	
<b>DANCE</b>	Increases resonance and bass.
<b>HALL</b>	Adds depth and brilliance to the sound.
<b>STADIUM</b>	Adds clarity and spreads the sound, as in an outdoor stadium.
SEA (Sound Effect Amplifier) Modes	
<b>ROCK</b>	Boosts low and high frequency. Good for acoustic music.
<b>POP</b>	Good for vocal music.
<b>CLASSIC</b>	Good for classical music.
User Modes	
<b>USER 1/2/3</b>	Your individual mode stored in memory. See the next column "Creating Your Own Sound Modes—User Mode."
<b>OFF</b>	No Sound Mode effect.

\* Surround elements are added to the SEA elements to create being-there feeling in your room.

## Creating Your Own Sound Modes

### —User Mode

Remote ONLY

INFO

You can create your own Sound Modes to make sounds suit your taste. The changed settings can be stored as the USER 1, USER 2 and USER 3 Modes.

#### 1 Select one of the preset Sound Modes.

- If you want to add surround elements to your Sound Mode, select one of the Surround Modes.

#### 2 Enter the SEA Control Mode.

ENTER/SET



#### 3 Adjust the SEA pattern.

- ① Select—BASS or TRE (treble).



- ② Adjust the level.

- You can adjust the bass and treble level from -3 to +3.



- ③ Repeat steps ① and ② to adjust the level of the other.

- ④ Finish the SEA pattern setting.

ENTER/SET



#### 4 Select one of the User Modes.



#### 5 Store the setting.

ENTER/SET





## Changing the Picture Tone



While showing a playback picture on the TV, you can select the preset picture tone, or adjust it and store your own settings.

### To select a preset picture tone

#### 1 While playing, display VFP setting screen.

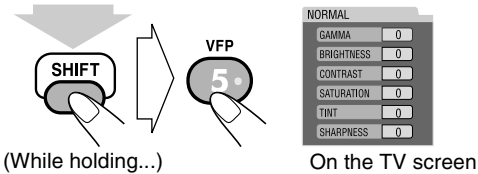

#### 2 Select a preset picture tone.

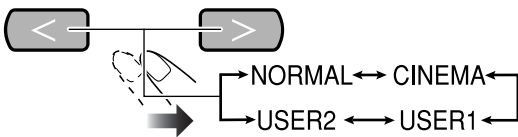

<b>NORMAL</b>	Normally select this.
<b>CINEMA</b>	Suitable for a movie source.
<b>USER1/USER2</b>	You can adjust parameters and can store the settings (see below).

### To adjust the picture tone

#### 1 Select "USER1" or "USER2."

- Follow steps 1 and 2 explained above.

#### 2 Select a parameter you want to adjust.

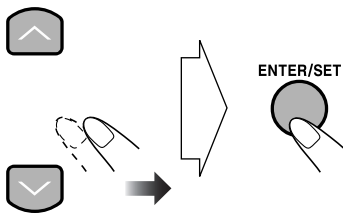

<b>GAMMA</b>	Adjust if the neutral color is bright or dark (-3 to +3).
<b>BRIGHTNESS</b>	Adjust if the picture is bright or dark as a whole (-8 to +8).
<b>CONTRAST</b>	Adjust if the far and near positions are unnatural (-7 to +7).
<b>SATURATION</b>	Adjust if the picture is whitish or blackish (-7 to +7).
<b>TINT</b>	Adjust if human skin color is unnatural (-7 to +7).
<b>SHARPNESS</b>	Adjust if the picture is indistinct (-8 to +8).

#### 3 Adjust the parameter.

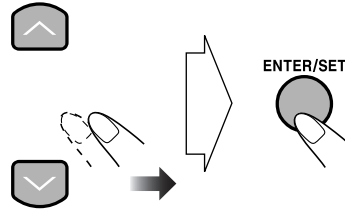

#### 4 Repeat steps 2 to 3 to adjust other parameters.

To remove the setting screen, press VFP again while holding SHIFT. The screen will automatically be erased after 9 seconds even if you do not press VFP.

## Changing the Display Brightness



You can dim the display window.

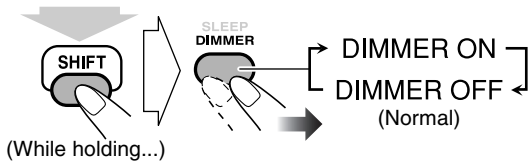

## Setting the Clock



- To exit from the clock setting, press CLOCK/TIMER as required.
- To go back to the previous step, press CANCEL while holding SHIFT.

#### 1 Activate clock setting mode.

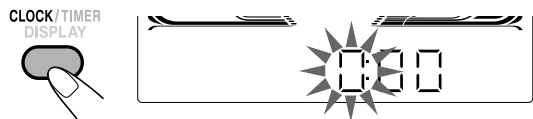

- If you have already adjusted the clock before, press the button repeatedly until the clock time starts flashing.

#### 2 Adjust the hour, then minute.

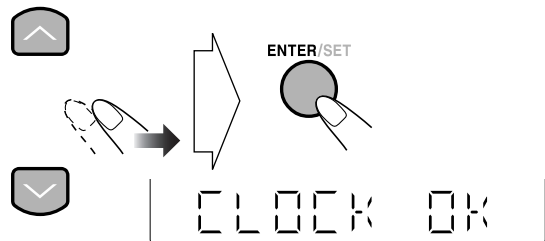

To check the current time when the System is turned on

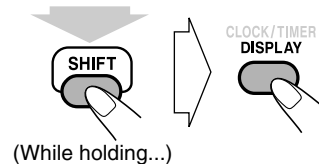

# Unique DVD/VCD Operations

## Remote Control

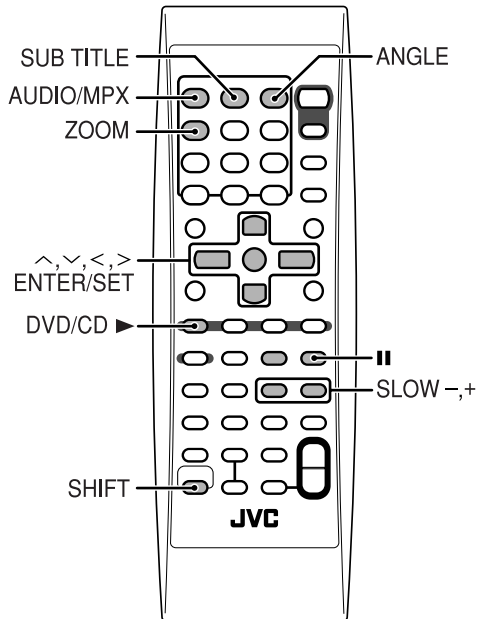

## Selecting the Sound Track Remote ONLY »»» INFO

**For DVD Video:** While playing back a chapter containing audio languages, you can select the language to listen to.

**For DVD-VR or SVCD/VCD:** When playing back a track, you can select the audio channel to play.

- You can also select the audio track using the on-screen bar (see page 21).

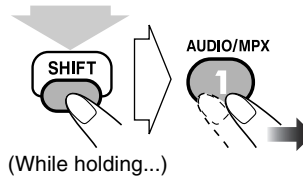

**While playing a DVD Video...**

**Ex.:**

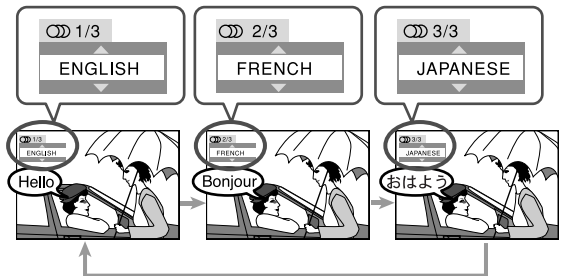

**While playing a DVD-VR or SVCD/VCD...**

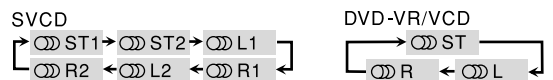

**ST1/ST2/ST** To listen to normal stereo (2 channel) playback.

**L1/L2/L** To listen to the left audio channel.

**R1/R2/R** To listen to the right audio channel.

- SVCD can have 4 audio channels. Karaoke SVCD usually uses these 4 channels to record two 2-channel recordings (ST1/ST2).

## Selecting the Subtitle Language Remote ONLY

**For DVD Video:** While playing back a chapter containing subtitles in different languages, you can select the subtitle language to display on the TV screen.

**For SVCD:** While playing, you can select the subtitles even if no subtitles are recorded on the disc.

**For DVD-VR:** While playing, you can turn the subtitle on or off.

- You can also select the subtitle language using the on-screen bar (see page 21).

**While playing a DVD Video...**

### 1 Display the subtitle selection window.

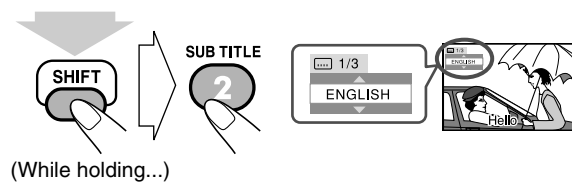

### 2 Select the subtitle language.

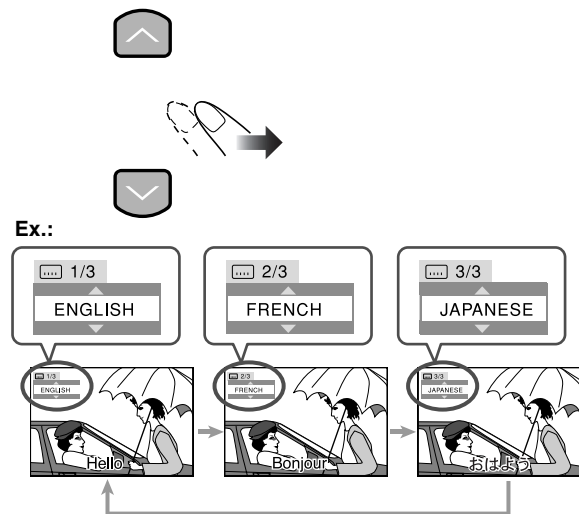

**While playing a DVD-VR...**

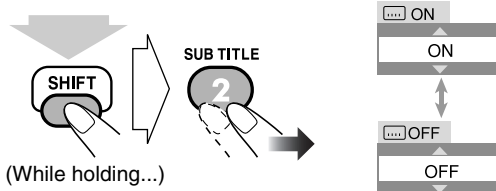

## Selecting the View Angle Remote ONLY

**For DVD Video only:** While playing back a chapter containing multi-view angles, you can view the same scene from different angles.

- You can also select the view angle using the on-screen bar (see page 21).

**While playing...**

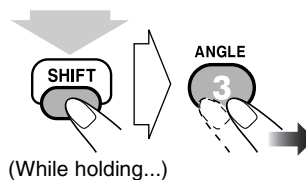

**Ex.:**

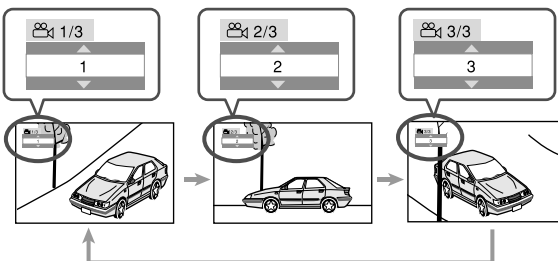

**While playing an SVCD...**

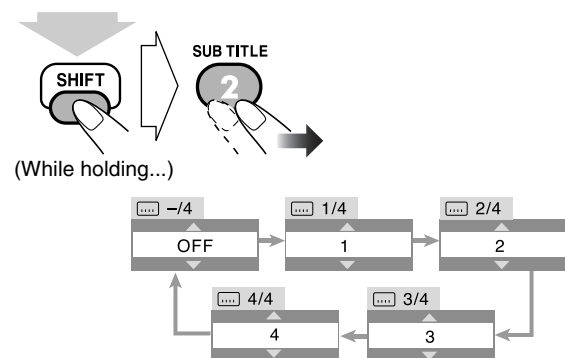

## Special Picture Playback

INFO

### Still picture playback

To start still picture playback:	To resume normal playback:
While playing... FM MODE 	DVD/CD 

### Frame-by-frame playback

#### 1 While playing...



Still picture playback starts.

#### 2 Advance the still picture frame by frame.

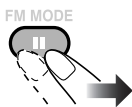

To resume normal playback, press DVD/CD ►.

### Slow-motion playback

Remote ONLY >>>

• This does not function for MPEG-1/MPEG-2 discs.

#### 1 While playing...



Still picture playback starts.

#### 2 Select slow motion speed.

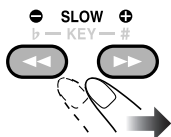

\*Only available for DVD Video.

To resume normal playback, press DVD/CD ►.

### Zoom

Remote ONLY >>>

To zoom in JPEG file, see page 25.

#### 1 While playing...

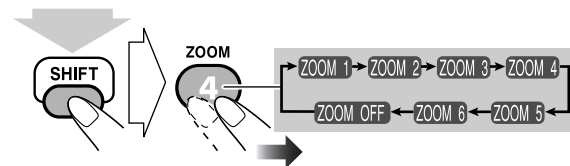

(While holding...)

As the number increases, magnification also increases.

#### 2 Move the zoomed-in position.

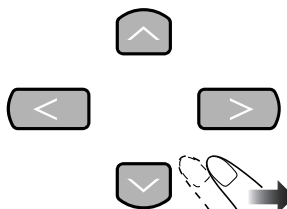

To cancel zoom, press ZOOM repeatedly while holding SHIFT until “ZOOM OFF” appears on the TV.

# Advanced Disc Operations

## Remote Control

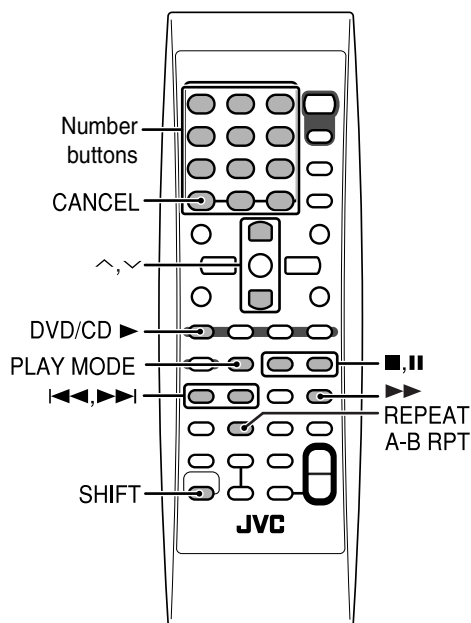

## Main unit

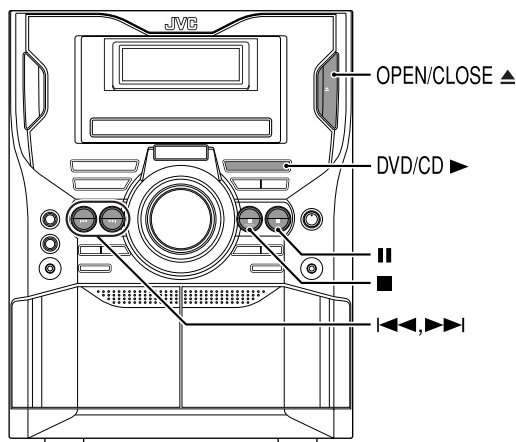

## Programming the Playing Order Remote ONLY >>>

### —Program Play INFO

You can arrange the playing order of the chapters or tracks (up to 99) before you start playback.

- Program play cannot be used for DVD-VR/JPEG/MPEG-1/MPEG-2 discs.
- Resume does not work for Program Play.

#### 1 Before starting playback, activate Program Play.

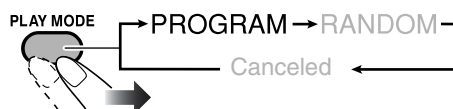

On the display



On the TV

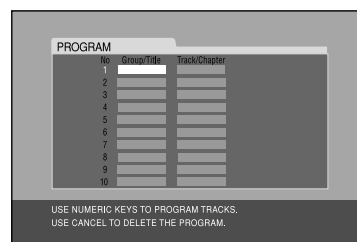

#### 2 Select a chapter or a track you want for Program Play.

•For DVD Video/MP3/WMA:

- ① Select a title or group number.
- ② Select a chapter or track number.

•For SVCD/VCD/CD:

- ① Select a track number.

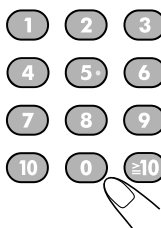

#### Examples:

To select number 5, press 5.

To select number 10, press 10.

To select number 15, press  $\geq 10$ , 1, then 5.

To select number 30, press  $\geq 10$ , 3, then 0.

#### 3 Repeat step 2 above until you program all chapters or tracks you want.

#### 4 Start playback.



Playback starts in the order you have programmed.

Continued on the next page...

## To check the programmed contents

Before playback...

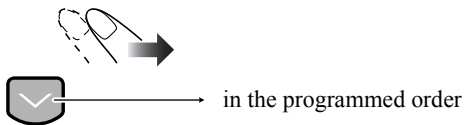
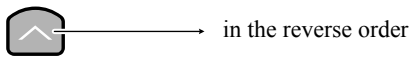

## To modify the program

Before or after playback...

**To erase the last chapter/  
track:**

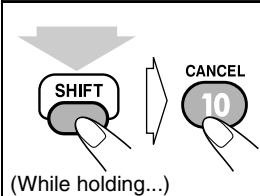

**To erase the entire  
program:**

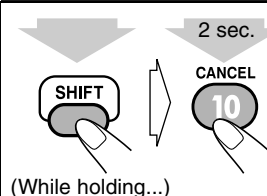

**To add chapters/tracks to the program:**

Repeat step 2 on page 18.

## To exit from Program Play

Before or after playback...



## Playing at Random—Random Play

You can play the contents of all chapters and tracks at random.

- Random Play cannot be used for DVD-VR, JPEG, MPEG-1, MPEG-2 and some DVDs.

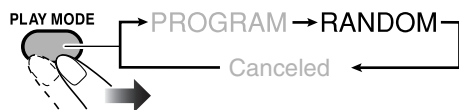

### 1 Before starting playback, activate Random Play.



### 2 Start playback.

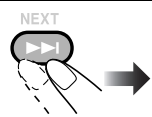

Playback starts in a random order. Random Play ends when all chapters/tracks are played.

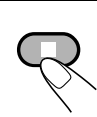
To skip:	To pause:	To stop:
 <p>To go to the beginning of the current chapter/track, press <b>⏮</b>.</p>	 <p>To release, press DVD/CD <b>▶</b>.</p>	

## To exit from Random Play

Before or after playback...



## Playing Repeatedly

Remote ONLY

INFO

- You can also select the repeat mode using the on-screen bar (see page 22).
- For DVD-VR/JPEG, see page 25.

### • For DVD Video:

While playing...

On the TV:

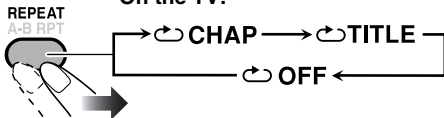

### • For MP3/WMA/MPEG-1/MPEG-2:

While playing or before playback...

On the TV:

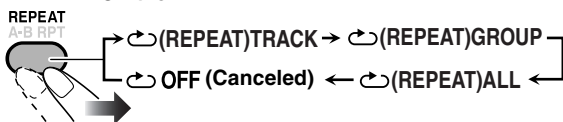

### • For CD/SVCD/VCD:

While playing or before playback (without PBC for SVCD/VCD)...

On the TV:

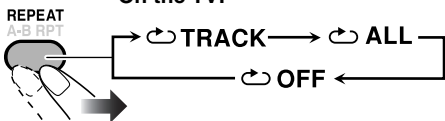

### • For Program Play/Random Play mode:

While playing or before playback...

On the TV:

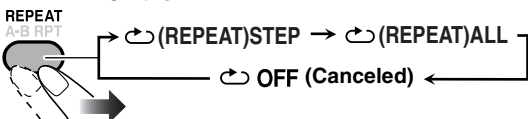

↺ CHAP	Repeats the current chapter.
↺ TITLE	Repeats the current title.
↺ TRACK (REPEAT TRACK)	Repeats the current track.
↺ GROUP (REPEAT GROUP)	Repeats the current group.
↺ ALL (REPEAT ALL)	Repeats all chapters/tracks or programmed tracks.
↺ STEP (REPEAT STEP)	Repeats the current chapter/track.
↺ OFF	Cancels Repeat Play mode.

## A-B Repeat

You can repeat playback of a desired portion by specifying the beginning (point A) and the ending (point B).

- A-B Repeat cannot be used for MP3/WMA/MPEG-1/MPEG-2 and for some DVDs.

### 1 While playing (without PBC for SVCD/VCD), select the start point (A).

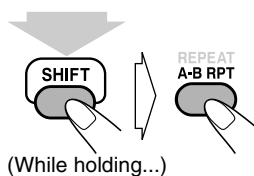

- ↺ A- appears on the TV if the TV is turned on.

### 2 Select the end point (B).

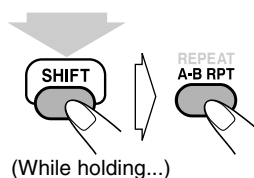

- ↺ A-B appears on the TV.
- You can search for the end point using the ►► button.

To cancel A-B Repeat, press A-B RPT again while holding SHIFT.

- A-B Repeat will also be canceled when you stop play or skip the chapter or track.

## Prohibiting Disc Ejection

### —Child Lock



You can lock the disc tray so that no one can eject the loaded disc.

- This is possible while the System is on standby.

While the disc tray is closed...

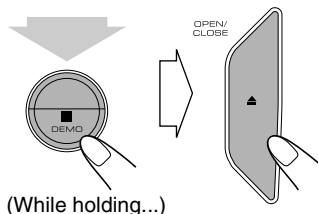

LOCKED

To cancel the prohibition, repeat the same procedure. "UNLOCKED" appears on the display.

# On-Screen Bar Operations

## Remote control

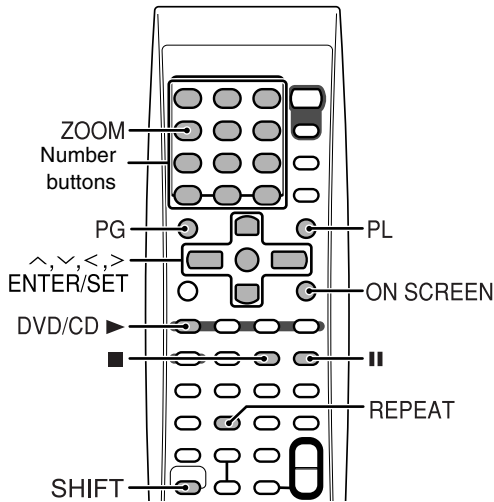

## On-screen bars

### DVD Video

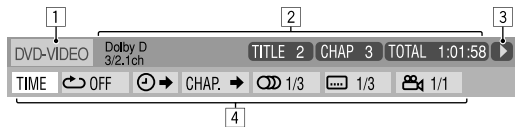

### DVD-VR

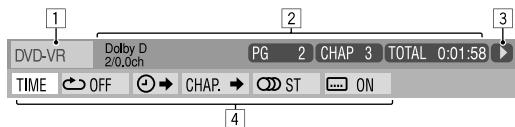

### SVCD

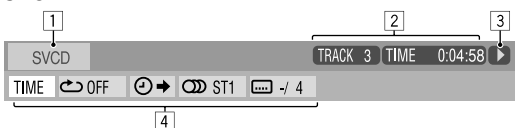

### VCD



### CD



### MPEG-1/MPEG-2



## On-screen Bar Information

You can check the information on a disc (except for MP3/WMA/JPEG disc) and use some functions through the on-screen bar.

### 1 Disc type

### 2 Playback information

Indication	Meanings
Dolby D, LPCM	Audio format
3/2.1ch, 2/0.0ch	Channel number
TITLE 2	Current title
CHAP 3	Current chapter
GROUP 14	Current group
TRACK 23	Current track
PG 2	Current title
PL 2	Current play list
TOTAL 1:25:58	Time indications

### 3 Playback conditions

Indication	Meanings
▶	Playback
▶▶ / ◀◀	Forward/Reverse search
▶▶ / ◀◀ (slow)	Forward/Reverse slow-motion
⏸	Pause
■	Stop

### 4 Operation icons (on the pull-down menu)

Indication	Meanings
TIME	Select to change the time indication.
↺ OFF	Select to repeat playback.
⌚	Select for time search.
CHAP. →	Select for chapter search.
TRACK →	Select for track search.
🔊 1/3	Select to change the audio language or channel (see also page 15).
🗣️ 1/3	Select to change subtitle language (see also page 16).
👁️ 1/3	Select to change the view angle (see also page 16).



## Operations Using the On-screen Bar



INFO

Basic operation procedures through the on-screen bar are as follows:

Ex.: Selecting a subtitle (French) for DVD Video:

While a disc is selected as the source...

### 1 Display the on-screen bar with the pull-down menu.

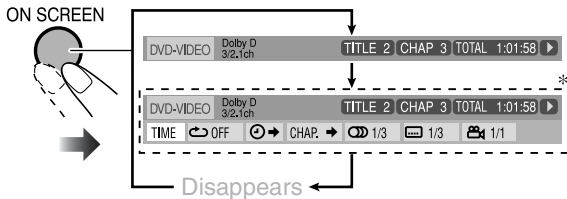

\* This does not appear for MPEG-1/MPEG-2 discs.

### 2 Select (highlight) the item you want.



### 3 Display the pop-up window.

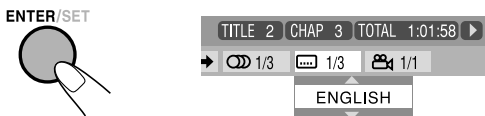

### 4 Select the desired option in the pop-up window.

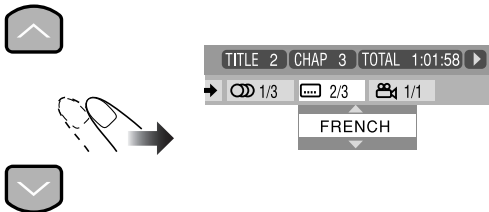

### 5 Finish the setting.

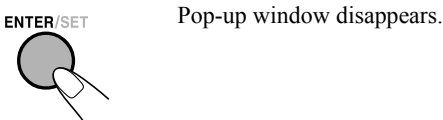

### To remove the on-screen bar

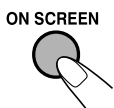

For detailed operations of the following functions, see also "Operations Using the On-screen Bar" on this page.

## Time information

You can change the time information in the on-screen bar and the display window on the main unit.

### 1 While playing, display the on-screen bar with the pull-down menu.



### 2 Make sure [TIME] is selected (highlighted).

### 3 Change the time indication.

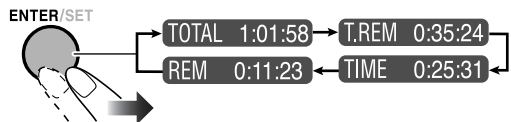

<b>TOTAL</b>	Elapsed disc/title time.
<b>T.REM</b>	Remaining disc time.
<b>TIME</b>	Elapsed playing time of the current chapter/track (not applicable for DVD-VR).
<b>REM</b>	Remaining time of the current chapter/track (not applicable for DVD-VR).

## Repeat Play

• See also page 20.

### 1 While playing a disc (without PBC for SVCD/VCD), display the on-screen bar with the pull-down menu.

• Repeat play can be selected before starting playback, not applicable for DVD Video.

### 2 Select [OFF].

### 3 Display the pop-up window.



<b>ALL</b>	Repeats the disc (not applicable for DVD Video).
<b>A-B</b>	Repeats a desired portion (see page 23).
<b>TITLE<sup>*1</sup></b>	Repeats the current title.
<b>GROUP</b>	Repeats the current group.
<b>CHAPTER<sup>*2</sup></b>	Repeats the current chapter.
<b>TRACK<sup>*2</sup></b>	Repeats the current track.
<b>OFF</b>	Cancels Repeat Play.

\*1 While playing DVD-VR discs, "PG" or "PL" appears.

\*2 During Program Play or Random Play, "STEP" appears.



## Operations on the Control Screen



**For DVD-VR/MP3/WMA/JPEG/MPEG-1/MPEG-2:**  
You can search for and play the desired items through the control screen.

### Control screen for DVD-VR

The control screen is superimposed on the TV screen when you call up Program List (PG) or Play List (PL).

#### To select playback type

To select the Program List:	To select the Play List:
<p>TOP MENU/PG</p>	<p>MENU/PL</p>

When Program List is selected.

ORIGINAL PROGRAM				
No	Date	Ch	Time	Title
1	25/04/06	4ch	19:00	JVC DVD World 2004
2	17/05/06	8ch	10:30	
3	22/05/06	8ch	17:00	Music Festival
4	26/05/06	L-1	13:19	children 001
5	20/06/06	4ch	22:00	
6	25/06/06	L-1	8:23	children 002

When Play List is selected.

PLAY LIST				
No	Date	Chap	Length	Title
1	25/05/06	001	1:03:16	My JVC World
2	17/06/06	005	1:35:25	
3	20/06/06	003	0:10:23	Favorite music
4	25/06/06	001	0:07:19	children001-002

- ① List number
- ② Recording date
- ③ Recording source (TV station, the input terminal of the recording equipment, etc.)
- ④ Start time of recording
- ⑤ Title of the program/play list\*
- ⑥ Highlight bar (current selection)
- ⑦ Creating date of play lists
- ⑧ Number of chapters
- ⑨ Playback time

\*The title of the Program List or Play List may not be displayed depending on the recording equipment.

### Control screen for MP3/WMA/JPEG/MPEG-1/MPEG-2 discs

The control screen automatically appears on the TV screen when you load an MP3, WMA, JPEG, MPEG-1 or MPEG-2 disc.

If files of different types are recorded on a disc, select the file type to play (see "FILE TYPE" on page 35).

Ex.: When an MP3 disc is loaded.

- ① Current group number/total group number
- ② Current group
- ③ Group list
- ④ Current track
- ⑤ Track information (ID3 Tag Version 1.0: only for MP3/WMA)
- ⑥ Repeat Play setting
- ⑦ Elapsed playing time of the current track (only for MP3/WMA/MPEG-1/MPEG-2)
- ⑧ Operation mode icon
- ⑨ Current track number/total number of tracks in the current group (total number of tracks on the loaded disc)
- ⑩ Highlight bar
- ⑪ Track list

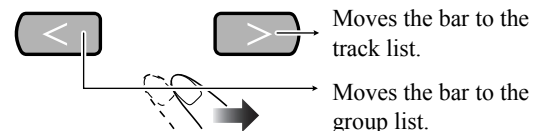

#### To move the highlight bar between group list and track list (for MP3/WMA/JPEG/MPEG-1/MPEG-2)



#### To select an item in the list

- Move the highlight bar to a desired item.
- If you select an item while playing back a DVD-VR/MP3/WMA/MPEG-1/MPEG-2 disc, the selected item starts playback automatically.

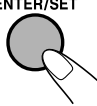
## To start playback

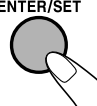
For JPEG:	
	The selected track (still picture) is displayed until you change it.
	Slide-show playback starts. Each track (still picture) is shown on the screen for a few seconds, then changes one after another.
For the other discs:	
	Playback starts with the selected track. <ul style="list-style-type: none"> <li>Pressing DVD/CD ► also starts playback.</li> </ul>

- While playing DVD-VR/JPEG/MPEG-1/MPEG-2 tracks, the control screen disappears.
- For JPEG discs, to cancel slide-show and display the current still picture, press **II**.

## To stop playback



## To repeat title/play list for DVD-VR

### While playing a program in Program List

On the TV:

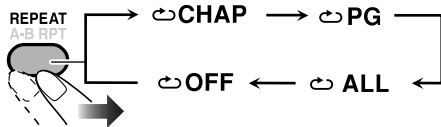

### While playing an item in Play List

On the TV:

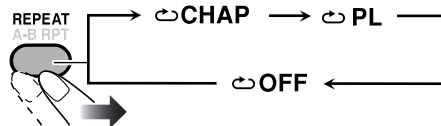

↺ CHAP Repeats the current chapter.

↺ PG/PL Repeats the current title/play list.

↺ ALL Repeats all programs in the disc.

↺ OFF Cancels Repeat Play Mode.

## To repeat slide-show for JPEG

While playing or before playback...

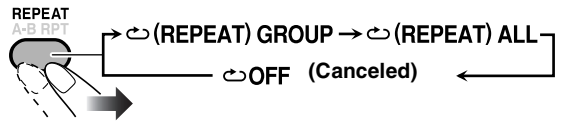

### ↺ GROUP

**(REPEAT GROUP)**

Repeats the current group.

### ↺ ALL

**(REPEAT ALL)**

Repeats all files in the disc.

### ↺ OFF

Cancels Repeat Play mode.

- For Repeat Play of MP3/WMA/MPEG-1/MPEG-2, see page 20.

## To zoom in the still picture (for JPEG)

- You cannot zoom in the still picture during slide-show.

### 1 While playback is paused...

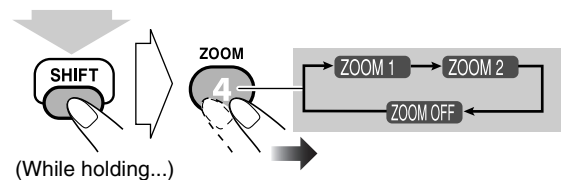

As the number increases, magnification also increases.

### 2 Move the zoomed-in position.

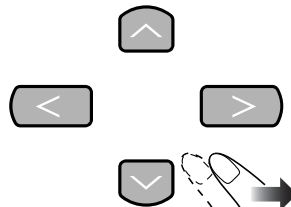

To cancel zoom, press ZOOM repeatedly while holding SHIFT until "ZOOM OFF" appears on the TV.

# Recording Operations

## Main unit

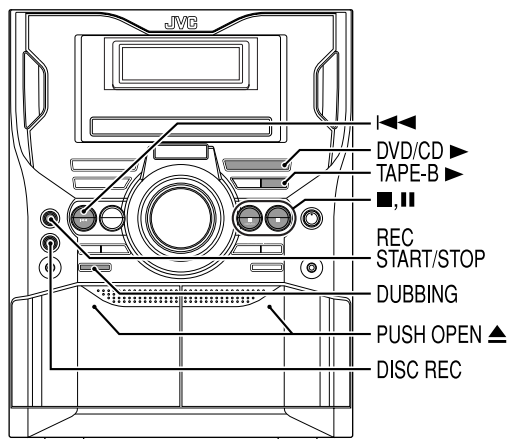

## IMPORTANT

It may be unlawful to record or play back copyrighted material without the consent of the copyright owner.

## Recording on a Tape



INFO

You can use type I tapes for recording.

- To play a tape, see page 11.

### 1 Insert a recordable cassette in deck B.

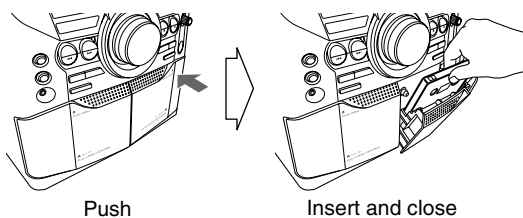

### 2 Start playing the source—"FM," "AM," "DVD/CD," "TAPE-A" or "AUX."

- When recording from TAPE-A, you can also use dubbing function (see page 27).
- When recording from a disc, you can also use Synchronized Disc Recording (see page 27).

### 3 Start recording.



### To stop recording

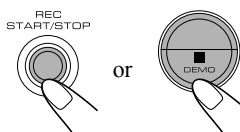

## Dubbing Tapes



### 1 Change the source to TAPE-B.

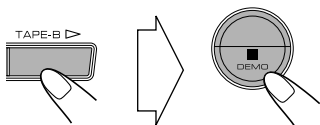

### 2 Insert the source cassette in deck A, and a recordable cassette in deck B.

### 3 Start dubbing.

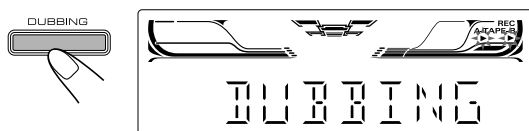

- When either tape playback or recording ends, both cassette decks stop at the same time.

### To stop dubbing



## To record without creating 4-second blanks

- 1 Press DVD/CD ►, then press II.
- 2 Press ◀◀ to go back to the beginning of the track.
- 3 Press DISC REC to start recording.

### To protect your recording

Cassettes have two small tabs on the back to protect from unexpected erasure or re-recording.

To protect your recording, remove these tabs.



To re-record on a protected tape, cover the holes with adhesive tape.

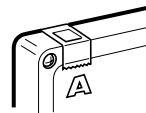

## Synchronized Disc Recording



INFO

You can start and stop both disc play and tape recording at the same time.

### 1 Load a disc and insert a recordable cassette in deck B.

- If the current playing source is not the disc player, press DVD/CD ►, then ■ (twice if resume is turned “ON”).

#### For recording desired tracks from discs:

You can program tracks to record with your preferred order.

- Select Program Play (and make a program: see page 18) without starting playback.

### 2 Start recording.



The System automatically creates 4-second blanks between the tunes recorded on the tape.

- When either disc play or recording ends, both disc player and the cassette deck stop at the same time.

# Enjoying Karaoke

## Remote control

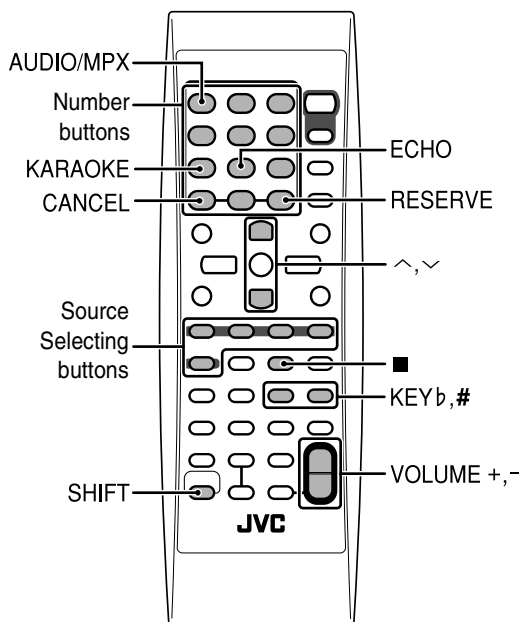

## Main unit

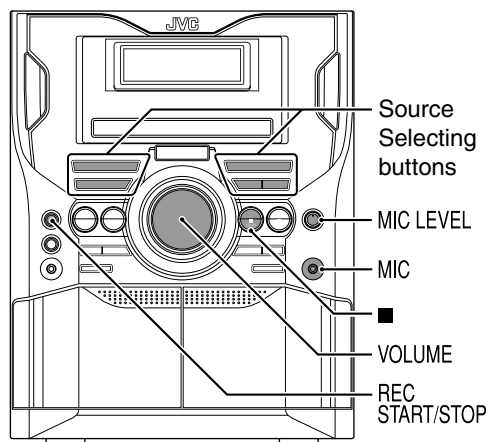

### NOTE

- This function is not available in the Australian model.

### IMPORTANT

- Always set MIC LEVEL to MIN when connecting or disconnecting the microphone.



DO NOT keep the microphone connected while it is not in use.

## Singing Along (Karaoke)

INFO

You can enjoy singing along (Karaoke) by using the microphone.

### To sing along using Karaoke discs

You can enjoy Karaoke using Karaoke discs (except Karaoke CD).

- By pressing REC START/STOP, you can record your singing-along.

#### 1 Turn MIC LEVEL to MIN.



#### 2 Connect the microphone (not supplied) to the MIC jack.

#### 3 Activate the Karaoke Mode.

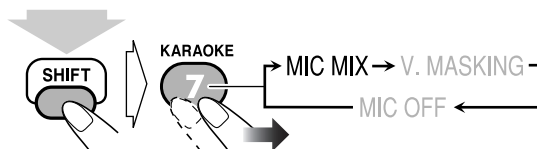

(While holding...)

#### 4 Insert and start playing a Karaoke disc.



Continued on the next page...

Karaoke function is not available in the Australian model.

**5** Select the desired audio channel (see page 15).

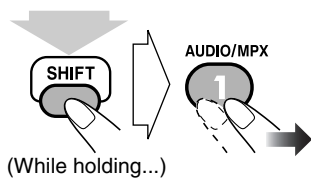

**6** Sing into the microphone.

**7** Adjust the MIC LEVEL and VOLUME.

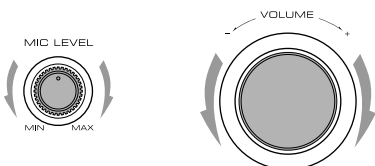

To cancel the Karaoke Mode, select “MIC OFF” in step 3.

### Adjusting the key (disc playback only)

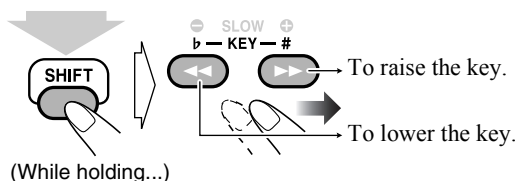

To cancel the adjustment, set the number shown on the display to “0.”

### Applying an echo to your voice

During Karaoke Play...

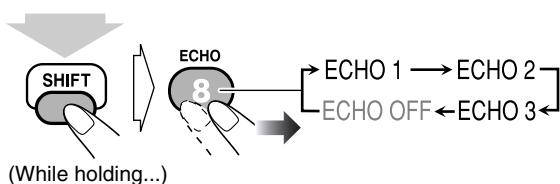

• As the number increases, echo level also increases.

## Singing Along Using Stereo Discs

### Vocal Masking

INFO

You can enjoy singing along while playing a stereo disc. Vocal Masking reduces the lead vocal of a disc.

- You can use this function only with DVD/CD sources.
- When playing a Karaoke disc in Vocal Masking Mode, the vocal may not be reduced or the volume may be lower.
- By pressing REC START/STOP, you can record your singing-along.

**1** Turn MIC LEVEL to MIN.



**2** Connect the microphone (not supplied) to the MIC jack.

**3** Insert and start playing a stereo disc.



**4** Activate Vocal Masking Mode.

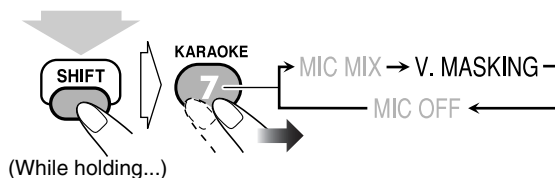

**5** Sing into the microphone.

**6** Adjust the MIC LEVEL and VOLUME.

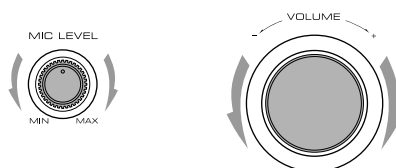

To cancel the Vocal Masking Mode, select “MIC OFF” in step 4 or change the source to play.

Karaoke function is not available in the Australian model.



## Microphone Mixing

You can enjoy microphone mixing by using the microphone.

- By pressing REC START/STOP, you can record your singing-along.

### 1 Turn MIC LEVEL to MIN.



### 2 Connect the microphone (not supplied) to the MIC jack.

### 3 Start playing the source—FM, AM, disc player, tape, or auxiliary equipment connected to the AUX jack.

### 4 Activate the Karaoke Mode.

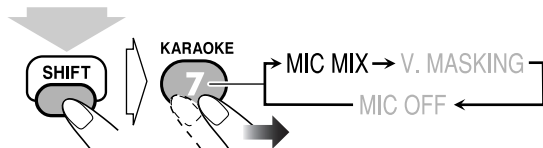

(While holding...)

### 5 Sing into the microphone.

### 6 Adjust the MIC LEVEL and VOLUME.

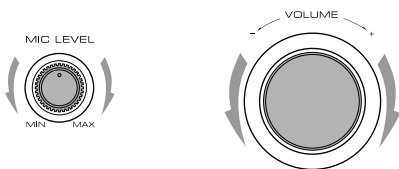

## To use microphone only

### 1 Turn MIC LEVEL to MIN.



### 2 Connect the microphone (not supplied) to the MIC jack.

### 3 Select DVD/CD as the source, then stop playback.



### 4 Activate the Karaoke mode.

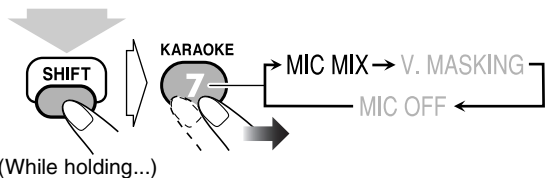

(While holding...)

### 5 Sing into the microphone.

### 6 Adjust the MIC LEVEL and VOLUME.

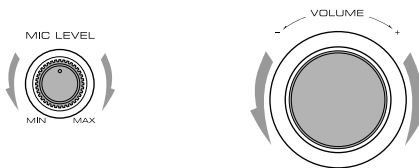

### To cancel the Karaoke Mode, select “MIC OFF” in step 4.

- When you change the source to play, the Karaoke Mode is canceled. Repeat step 4 to activate the Karaoke Mode again.

### To cancel the Karaoke mode, select “MIC OFF” in step 4.

Karaoke function is not available in the Australian model.

## Reserving Karaoke Songs



### —Karaoke Program Play

INFO

You can determine the playback order of up to 12 chapters or tracks on the disc player.

Karaoke Program Play cannot be used for DVD-VR.

#### 1 Turn MIC LEVEL to MIN.



#### 2 Connect the microphone (not supplied) to the MIC jack.

#### 3 Change the source to the “DVD/CD.”

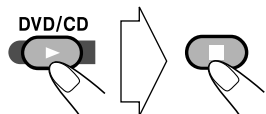

#### 4 Activate Karaoke Program Play.

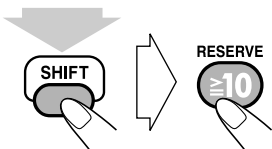

(While holding...)

No	Gr/Tt	Tr/Chap
1		
2		
3		
4		
5		

On the TV screen

- PRGM indicator flashes during this mode.

#### 5 Select songs you want for Karaoke Program Play.

**For DVD Video/MP3/WMA/MPEG-1/MPEG-2:**

- Press the number buttons to select a title or group.
- Repeat step ① to select a chapter or track.

**For SVCD/VCD/CD:**

Press the number buttons to select a track.

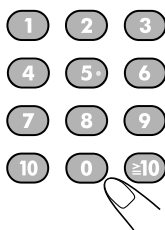

#### Examples:

- To select number 5, press 5.
- To select number 10, press 10.
- To select number 15, press ≧10, 1, then 5.
- To select number 30, press ≧10, 3, then 0.

#### 6 Activate the Karaoke Mode.

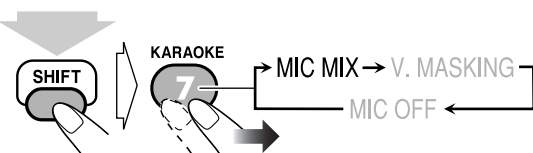

(While holding...)

#### 7 Start playback.



#### 8 Sing into the microphone.

#### 9 Adjust the MIC LEVEL and VOLUME.

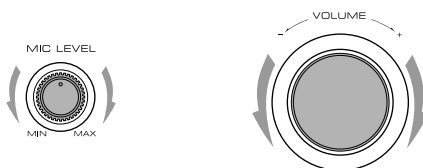

#### To check the programmed contents

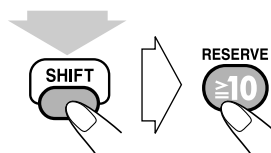

(While holding...)

The Karaoke reserve screen appears.

#### To modify the program

While the Karaoke reserve screen is shown on the TV...

##### To erase the unwanted chapter/track:

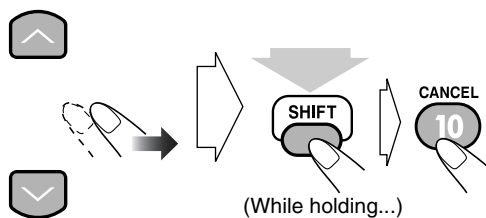

(While holding...)

##### To erase the entire program:

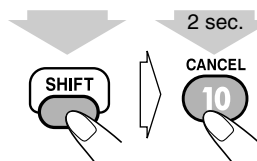

(While holding...)

##### To add chapters/tracks to the program:

Repeat step 5 on the left.

Karaoke function is not available in the Australian model.

# Timer Operations

## Remote Control

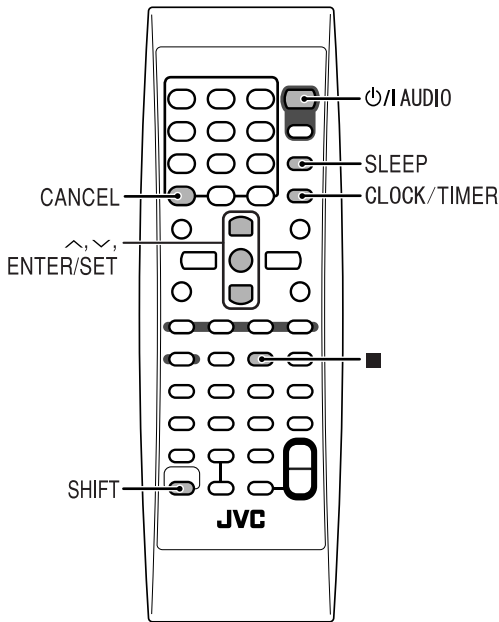

You need to set the built-in clock before using timer functions (see page 14) except Sleep Timer.

## Setting the Timer



INFO

Using Daily Timer, you can wake up with your favorite music. On the other hand, with Recording Timer, you can make a tape of a radio broadcast.

- To go back to the previous step, press CANCEL while holding SHIFT.

### 1 Select one of the timer setting modes—ON for Daily Timer or Recording Timer.

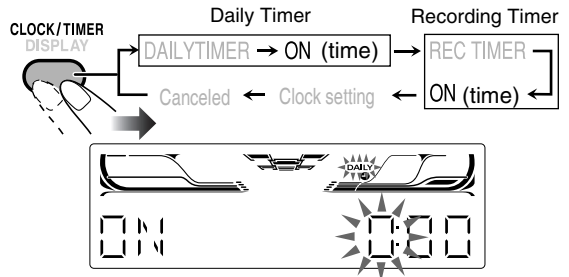

Ex.: Daily Timer

### 2 Make the timer setting as you want.

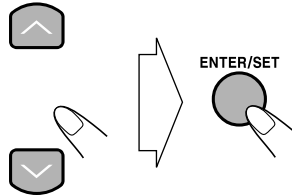

Repeat the procedure for the following settings until finished:

- ① Set the hour then minute for on-time.
- ② Set the hour then minute for off-time.
- ③ Select the playback source.
  - For Daily Timer, you can select from "TUNER FM," "TUNER AM," "DISC," "TAPE-A," "TAPE-B" and "AUX."
  - For Recording Timer, you can select from "TUNER FM" and "TUNER AM."

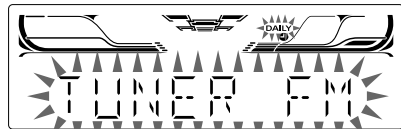

EX.: When "TUNER FM" is selected for Daily Timer.

- ④ Select a preset station for "TUNER FM" and "TUNER AM," or select a group and track number for "DISC."
- ⑤ For Daily Timer: Select the volume level.
  - You can select the volume level ("VOLUME 5," "VOLUME 10," "VOLUME 15" and "VOLUME --"). If you select "VOLUME --," the volume is set to the last level when the System has been turned off.

Continued on the next page...

**3 Turn off the System (on standby) if you have set the timer with the System turned on.**



**How Daily Timer works**

Once the Daily Timer has been set, the timer indicator (⏰) and DAILY indicator are lit on the display. Daily Timer is activated at the same time everyday until the timer is turned off manually (see below).

**When the on-time comes**

The System turns on, starts playing the specified source (except "AUX"), and increases the volume level gradually to the preset level for about 30 seconds.

**When the off-time comes**

The System stops playback, and turns off (standby) automatically.

- The timer setting remains in memory until you change it.
- Daily Timer will not start working if the system has been turned on.

**How Recording Timer works**

When Recording Timer has been set, the timer indicator (⏰) and the REC indicator are lit on the display. Recording Timer works only once.

**When the on-time comes**

The System turns on, tunes in to the specified station, sets the volume level to "VOLUME MIN," and starts recording.

**When the off-time comes**

The System stops recording, and turns off (standby).

- The timer setting remains in memory until you change it.

Recording Timer will start working even if the System has been turned on.

**To turn off the Timer after the setting is done**

You can turn off the timer after it has been set.

- Since Daily Timer is activated at the same time everyday, you may need to cancel it on some particular days.

**1 Select the timer you want to cancel (DAILYTIMER or REC TIMER).**

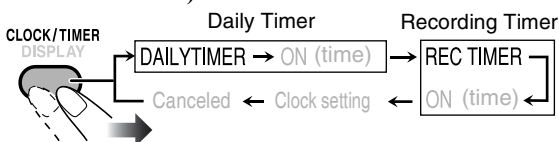

**2 Turn off the selected timer.**

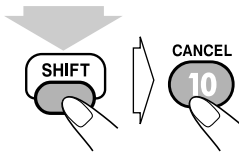

(While holding...)

The timer indicator (⏰) goes off.

To turn on the timer again, repeat step 1 and press ENTER/SET in step 2.

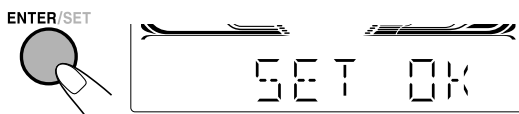

**Turning Off the Power Automatically**

**Sleep Timer**



With Sleep Timer, you can fall asleep listening to music.

**1 Specify the time (in minutes).**



**2 Wait until the set time goes off.**

**To check the time remaining until the shut-off time**



- If you press the button repeatedly, you can change the shut-off time.

**Timer Priority**



Recording Timer has priority over the Daily Timer and Sleep Timer.

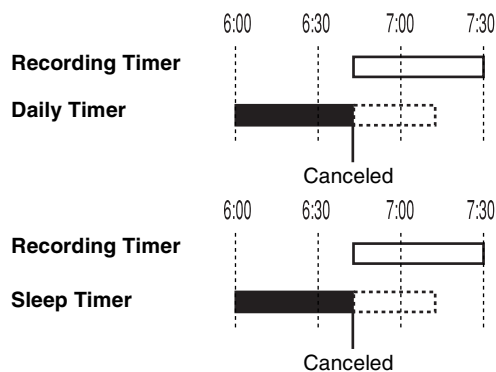

# Setup Menu Operations INFO

## Initial Settings

The Setup Menu cannot be activated during playback.

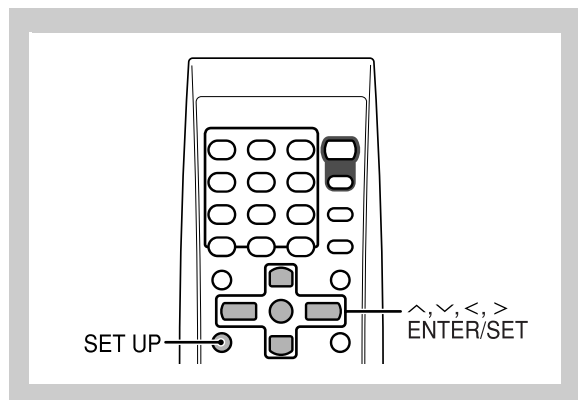

## How to set the Initial Settings

### 1 Press SET UP.

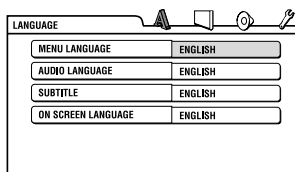

### 2 Press > (or <) to select the menu.

### 3 Press ∨ (or ∧) to move to select the item.

### 4 Press ENTER/SET.

### 5 Press ∨ (or ∧) to select the options, then press ENTER/SET.

- For settings of the LANGUAGE menu, see “Language Code List” on page 41.

### To erase a preference display

Press SET UP.



## LANGUAGE menu

Item	Contents
<b>MENU LANGUAGE</b>	You can select the initial menu language of DVD Video. See page 41.
<b>AUDIO LANGUAGE</b>	You can select the initial audio language of DVD Video. See page 41.
<b>SUBTITLE</b>	You can select the initial subtitle language of DVD Video. See page 41.
<b>ON SCREEN LANGUAGE</b>	You can select “ENGLISH,” “CHINESE,” or “SPANISH” as the on-screen language.



## PICTURE menu

Item	Contents
<b>MONITOR TYPE</b> <div style="display: flex; justify-content: space-around;"> <div style="text-align: center;"> <b>16:9</b>  </div> <div style="text-align: center;"> <b>4:3 LB</b>  </div> </div> <div style="margin-top: 10px;"> <b>4:3 PS</b>  </div>	<p>You can select the monitor type to match your TV when you play back DVD Video discs recorded for wide-screen televisions.</p> <p>When you use a multi-color system TV, you can change the color system of the System automatically by selecting “MULTI” options as the monitor type.</p> <p><b>16:9/16:9MULTI (Wide television screen):</b> For a wide-screen (16:9) TV.</p> <p><b>4:3 LB/4:3MULTI LB (Letter Box conversion):</b> For a conventional (4:3) TV. Displays a wide-screen picture to fit the width of the TV screen keeping the aspect ratio.</p> <p><b>4:3 PS/4:3MULTI PS (Pan Scan conversion):</b> For a conventional (4:3) TV. The picture is zoomed in to fill the screen vertically and the left and right sides of the picture are cut off.</p>
<b>PICTURE SOURCE</b>	<p>You can obtain optimal picture quality by selecting the source type of the disc contents.</p> <p><b>AUTO:</b> Normally, select this option. The System recognizes the picture type (film or video source) of the current disc according to the disc information.</p> <p><b>FILM:</b> For a film source disc.</p> <p><b>VIDEO:</b> For a video source disc.</p>

Continued on the next page...



Item	Contents
<b>SCREEN SAVER</b>	You can set the screen saver function to <b>ON</b> or <b>OFF</b> . <b>ON:</b> The on-screen display on the TV becomes dark when no operation is done for about 5 minutes. <b>OFF:</b> To cancel the screen saver.
<b>FILE TYPE</b>	You can select the file type to play. <b>AUDIO:</b> To play MP3/WMA files. <b>STILL PICTURE:</b> To play JPEG files. <b>VIDEO:</b> To play MPEG-1/MPEG-2 files.



### AUDIO menu

Item	Contents
<b>DIGITAL AUDIO OUTPUT</b>	Set this item correctly when using the OPTICAL DIGITAL OUTPUT terminal on the rear. <b>PCM ONLY:</b> When connecting to audio equipment which can decode only linear PCM signals. <b>DOLBY DIGITAL/PCM:</b> When connecting to a Dolby Digital decoder or an amplifier with a built-in Dolby Digital decoder. <b>STREAM/PCM:</b> When connecting to a DTS decoder or an amplifier with a built-in DTS, MPEG Multichannel or Dolby Digital decoder.
<b>DOWN MIX</b>	This setting is effective for digital audio output if “DIGITAL AUDIO OUTPUT” is set to “PCM ONLY.” <b>DOLBY SURROUND:</b> Select this when connecting to a surround decoder. <b>STEREO:</b> Select this when connecting to a stereo receiver, MD player, TV, etc.
<b>D. RANGE COMPRESSION</b>	Set this item to listen to DVD Video recorded in Dolby Digital format at low volume. <b>AUTO:</b> You can enjoy powerful playback sound with full dynamic range. <b>ON:</b> Select this when you want to fully apply the compression effect to make the sound at lower volume clear (useful at midnight).



### OTHERS menu

Item	Contents
<b>RESUME</b>	You can select Resume (not applicable for CDs). <b>ON:</b> The System resumes playback from the position where playback has been stopped if the disc is still in the disc tray. <b>OFF:</b> Resume is deactivated.
<b>ON SCREEN GUIDE</b>	Activate or deactivate the on-screen guide. <b>ON:</b> To activate the on-screen guide. <b>OFF:</b> To deactivate the on-screen guide.

# Operating the TV



## Remote control

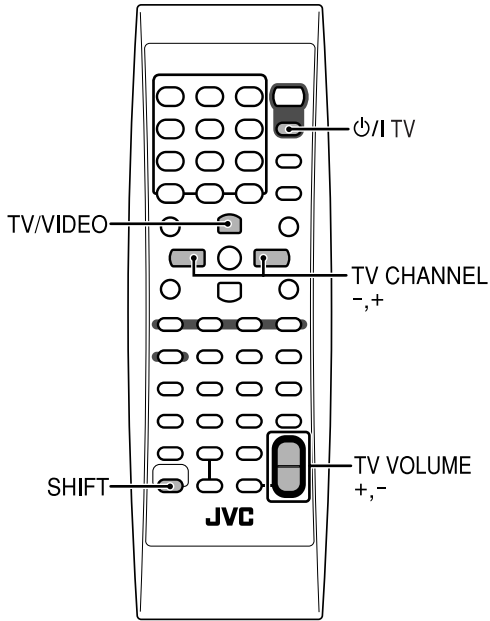

## Operating TV

You can operate JVC's TV using this remote control.

To turn on or off the TV:	To select the input mode (either TV or VIDEO):
	<p>(While holding...)</p>
To adjust TV volume:	
<p>(While holding...)</p>	<p>VOLUME TV VOLUME</p>
To select the TV channel:	
<p>(While holding...)</p>	<p>TV CHANNEL -      TV CHANNEL +</p>

# Additional Information

## Learning More about This System ● ● ●

### Introduction (see pages 1 and 2)

#### Playable Disc Types:

- If you play back an NTSC disc with the color system set to “PAL,” you can watch the playback picture (the disc will be reproduced using “PAL 60” format), but the TV screen may not display properly.
- If you play back a PAL disc with the color system set to “NTSC,” you can watch the playback picture, but the following symptoms may occur:
  - The items on the disc menu will be blurred, and be shown slightly shifted when highlighted.
  - The aspect ratio of the picture may differ from the original aspect ratio.
  - The picture movement is not smooth.

#### About audio format

- **Linear PCM:** Uncompressed digital audio, the same format used for CDs and most studio masters.
- **Dolby Digital:** Compressed digital audio, developed by Dolby Laboratories, which enables multi-channel encode to create the realistic surround sound.
- **DTS (Digital Theater Systems):** Compressed digital audio, developed by Digital Theater Systems, Inc., which enables multi-channel like Dolby Digital. As the compression ratio is lower than for Dolby Digital, it provides wider dynamic range and better separation.

### Daily Operations—Playback (see pages 8 to 11)

#### Listening to the Radio:

- If you store a new station into an occupied preset number, the previously stored station in that number will be erased.
- When you unplug the AC power cord or if a power failure occurs, the preset stations will be erased in a few days. If this happens, preset the stations again.

#### Playing Back a Disc:

- On some DVD, SVCD, or VCD discs, the actual operations may be different from what is explained in this manual, due to the programming and disc structure; such differences are not a malfunction of this System.
- This System can recognize up to 4 000 files in a disc. Also, the System can recognize up to 150 files per group and up to 99 groups in a disc.
  - If there are any unplayable files in a folder, those files are also counted in the total file number.
  - Playable files which do not belong to any groups are handled as Group 1.
- For DVD-VR playback...
  - When making a disc, use the UDF-Bridge format.
  - For details about DVD-VR format and playlist, refer to the manual of the recording equipment.
  - You cannot use reverse Slow-motion playback, Program Play or Random Play.

#### • For MP3/WMA playback...

- This System can play back MP3/WMA files with the extension code <.mp3> or <.wma> (regardless of the letter case—upper/lower).
- MP3 discs require a longer readout time than regular CDs depending on the complexity of the group/file configuration.
- Some MP3/WMA files cannot be played back and will be skipped. This results from their recording processes and conditions.
- When making MP3/WMA discs, use ISO 9660 Level 1 or Level 2 for the disc format.
- It is recommended that you make each MP3/WMA file at a sampling rate of 44.1 kHz and at bit rate of 128 kbps. This System cannot play back files made at a bit rate of less than 64 kbps.

#### • For MPEG-1/MPEG-2 playback...

- The stream format should conform to MPEG system/program stream.
- 720 x 576 pixels (25 fps)/720 x 480 pixels (30 fps) is recommended for the highest resolution.
- This System also supports the resolutions of 352 x 576/480 x 576/352 x 288 pixels (25 fps) and 352 x 480/480 x 480/352 x 240 pixels (30 fps).
- The file format should be MP@ML (Main Profile at Main Level)/SP@ML (Simple profile at Main Level)/MP@LL (Main Profile at Low Level).
- Audio streams should conform to MPEG1 Audio layer-2 or MPEG2 Audio Layer-2.

#### • For JPEG files playback...

- This System can play back JPEG files with the extension code <.jpg> or <.jpeg> (regardless of the letter case—upper/lower).
- It is recommended that you record a file at 640 x 480 resolution. (If a file has been recorded at a resolution of more than 640 x 480, it will take a long time to be shown.)
- This System can play only baseline JPEG files\*. Progressive JPEG files\* or lossless JPEG files\* cannot be played.

\* Baseline JPEG format: Used for digital cameras, web, etc.

Progressive JPEG format: Used for web.

Lossless JPEG format: An old type and rarely used now.

- This System may not play back JPEG files properly if they are recorded on devices other than digital still camera.



## Daily Operations—Sound & Other Adjustments (see pages 12 to 14)

### Creating 3-dimensional Sound Field—3D Phonic:

- While you use the headphones, 3D Phonic mode is canceled temporary.
- When you activate the Karaoke Mode, 3D Phonic mode is canceled temporary.
- 3D Phonic setting is also applied to the optical digital output signals through the OPTICAL DIGITAL OUTPUT terminal.

### Creating Your Own Sound Modes —User Mode:

- When you unplug the AC power cord or if a power failure occurs, the User Mode settings will be erased in a few days. If this happens, set the User Mode again.

### Setting the Clock:

- “0:00” will flash on the display until you set the clock.
- The clock may gain or lose 1 to 2 minutes per month. If this happens, reset the clock.

## Unique DVD/VCD Operations (see pages 15 to 17)

### Selecting the Sound Track:

- On some DVD Video discs, you cannot change audio languages while playing back.

### Special Picture Playback:

- During slow-motion playback, no sound will be reproduced.
- While zoomed in, the picture may look coarse.

## Advanced Disc Operations (see pages 18 to 20)

### Programming the Playing Order—Program Play:

- While programming steps...  
Your entry will be ignored if you have tried to program an item number that does not exist on the disc (for example, selecting track 14 on a disc that only has 12 tracks).

### Playing Repeatedly:

- A-B Repeat cannot be used on some DVDs.
- A-B Repeat is possible only within the same title or within the same track.

## Recording Operations (see pages 26 and 27)

### Recording on a Tape:

- The recording level is automatically set correctly. Thus, you can adjust the sound you are actually listening to without affecting the recording level.
- There is leader tape which cannot be recorded onto at the start and the end of cassette tapes. Thus, when recording discs or radio broadcasts, wind the leader tape first to ensure that the recording will be made without any music part lost.
- If no cassette or a protected tape is inserted, “NO REC” appears on the display.
- You cannot change the source during recording.

### Synchronized Disc Recording:

- While recording, you cannot use ►►/◄◄, ►►/◄◄, DVD LEVEL, 3D PHONIC and source selecting buttons.
- You can adjust volume control, sound setting (Active Bass Extension and Sound Turbo II) and sound mode but the settings do not affect the recording sound.
- You cannot use Repeat Play during synchronized recording (Repeat Play will be canceled).

## Enjoying Karaoke (see pages 28 to 31)

### Singing Along Using Stereo Discs—Vocal Masking:

- Vocal Masking Mode setting is also applied to the optical digital output signals through the OPTICAL DIGITAL OUTPUT terminal.
- On some music, Vocal Masking does not provide the correct effect.

## Timer Operations (see pages 32 and 33)

### Setting the Timer:

- If you do not specify the preset station or track number correctly while setting a timer, the currently selected station or the first track will be played when the timer is activated.
- When you unplug the AC power cord or if a power failure occurs, the timer will be canceled. You need to set the clock first, then the timer again.
- Without stopping the recording, you cannot change the source after Recording Timer starts recording.
- If you set DVD Video/MPEG-1/MPEG-2 as the source, Daily Timer may not work correctly.

### Timer Priority:

- If you set the Sleep Timer after Daily Timer starts playing the selected source, Daily Timer is canceled.
- If you set the Sleep Timer after Recording Timer starts recording, Recording Timer is canceled, but recording continues until Sleep Timer shuts off the power.

## Setup Menu Operations (see pages 34 and 35)

### How to set the Initial Settings:

- If the upper and lower parts of the menu are cut off, adjust the picture size control of the TV.

### LANGUAGE menu:

- When the language you have selected for MENU LANGUAGE, AUDIO LANGUAGE, or SUBTITLE is not recorded on a disc, the original language is used as the initial language.

### PICTURE menu—MONITOR TYPE:

- Even if “4:3 PS/4:3 MULTIPS” is selected, the screen size may become 4:3 letter box with some DVD Video discs. This depends on how the discs are recorded.
- When you select “16:9/16:9 MULTI” for a picture whose aspect ratio is 4:3, the picture slightly changes due to the process for converting the picture width.

### AUDIO menu—DOWN MIX:

- This setting is not effective when DTS multi-channel software is played back.

### OTHERS menu—ON SCREEN GUIDE:

- The setup menu and on-screen bar will be displayed (and recorded) even though this function is set to “OFF.” Subtitles and the information for zoom-in always appear on the display regardless of this setting.

## Troubleshooting

If you are having a problem with your System, check this list for a possible solution before calling for service.

### General:

#### Adjustments or settings are suddenly canceled before you finish.

⇒ There is a time limit. Repeat procedure again.

#### Operations are disabled.

⇒ The built-in microprocessor may malfunction due to external electrical interference. Unplug the AC power cord and then plug it back in.

#### Unable to operate the System from the remote control.

⇒ The path between the remote control and the remote sensor on the System is blocked.

⇒ The batteries are exhausted.

#### No sound is heard.

⇒ Speaker connections are incorrect or loose.

⇒ Headphones are connected.

#### No picture appears on the screen.

⇒ The video cord connections are incorrect or loose.

#### No picture is displayed on the TV screen, the picture is blurred, or the picture is divided into two parts.

⇒ Incorrect color system is selected (see “Changing the Color System” on page 6).

#### The left and right edges of the picture are missing on the screen.

⇒ Select “4:3 LB/4:3 MULTI LB” for “MONITOR TYPE” (see page 34).

### Radio Operations:

#### Hard to hear broadcasts because of noise.

⇒ Antennas connections are incorrect or loose.

⇒ The AM loop antenna is too close to the System.

⇒ The FM antenna is not properly extended and positioned.

### Disc Operations:

#### The disc does not play.

⇒ You have inserted a DVD Video whose Region Code is not correct. (“REGION ERR” appears on the display.)

⇒ The disc is placed upside down. Place the disc with the label side up.

#### ID3 Tag on an MP3/WMA disc cannot be shown.

⇒ There are two types of ID3 Tag—Version 1 and Version 2. This System can only show ID3 Tag Version 1.

#### Groups and tracks are not played back as you expect.

⇒ The playing order is determined when the disc was recorded. It depends on the writing application.

#### MP3, WMA, JPEG, MPEG-1 or MPEG-2 files are not played back.

⇒ The inserted disc may include multiple types of tracks (ex. MP3/WMA files and JPEG files). In this case, you can only play back the files selected by the “FILE TYPE” setting (see page 35).

⇒ You have changed the “FILE TYPE” (see page 35) setting after you inserted a disc. In this case, reload the disc.

#### The disc sound is discontinuous.

⇒ The disc is scratched or dirty.

#### The disc playback sounds strange.

⇒ Cancel key adjustment (see page 29).

#### No subtitle appears on the display though you have selected the initial subtitle language.

⇒ Some DVDs are programmed to always display no subtitle initially. If this happens, press SUB TITLE while holding SHIFT after starting play (see page 16).

#### Audio language is different from the one you have selected as the initial audio language.

⇒ Some DVDs are programmed to always use the original language initially. If this happens, press AUDIO/MPX after starting play (see page 15).

#### The disc tray does not open or close.

⇒ The AC power cord is not plugged in.

⇒ Child Lock is in use. “LOCKED” appears in the display window (see page 20).

### Tape Operations:

#### The cassette holder cannot be opened.

⇒ Power supply from the AC power cord has been cut off while the tape was running. Turn on the System.

### Recording Operations:

#### Impossible to record.

⇒ Small tabs on the back of the cassette are removed. Cover the holes with adhesive tape.

### Timer Operations:

#### Daily Timer does not work.

⇒ The System has been turned on when the on-time comes. Timer starts working only when the System is turned off.

## Maintenance

To get the best performance of the System, keep your discs, tapes, and mechanism clean.

### Handling discs

- Remove the disc from its case by holding it at the edge while pressing the center hole lightly.
- Do not touch the shiny surface of the disc, or bend the disc.
- Put the disc back in its case after use to prevent warping.
- Be careful not to scratch the surface of the disc when placing it back in its case.
- Avoid exposure to direct sunlight, extreme temperatures, and moisture.

#### To clean the disc:

Wipe the disc with a soft cloth in a straight line from center to edge.

### Handling cassette tapes

- If the tape is loose in its cassette, take up the slack by inserting a pencil in one of the reels and rotate it.
  - If the tape is loose, it may get stretched, cut, or caught in the cassette.
- Be careful not to touch the tape surface.

- Avoid the following places to store the tape—in dusty places, in direct sunlight or heat, in moist areas, on a TV or speaker, or near a magnet.

#### To keep the best recording and playback sound quality:

- Use a cotton swab moistened with alcohol to clean the heads, capstans, and pinch rollers.
- Use a head demagnetizer (available at electronics and audio shops) to demagnetize the heads (when the System is turned off).

### Cleaning the System

- Stains should be wiped off with a soft cloth. If the System is heavily stained, wipe it with a cloth soaked in water-diluted neutral detergent and wrung well, then wipe clean with a dry cloth.
- Since the System may deteriorate in quality, become damaged or get its paint peeled off, be careful about the following:
  - DO NOT wipe it with a hard cloth.
  - DO NOT wipe it forcefully.
  - DO NOT wipe it with thinner or benzene.
  - DO NOT apply any volatile substance such as insecticides to it.
  - DO NOT allow any rubber or plastic to remain in contact for a long time.

## Language Code List

<b>AA</b> Afar	<b>FA</b> Persian	<b>KM</b> Cambodian	<b>OM</b> (Afan) Oromo	<b>SV</b> Swedish
<b>AB</b> Abkhazian	<b>FI</b> Finnish	<b>KN</b> Kannada	<b>OR</b> Oriya	<b>SW</b> Swahili
<b>AF</b> Afrikaans	<b>FJ</b> Fiji	<b>KO</b> Korean (KOR)	<b>PA</b> Panjabi	<b>TA</b> Tamil
<b>AM</b> Ameharic	<b>FO</b> Faroese	<b>KS</b> Kashmiri	<b>PL</b> Polish	<b>TE</b> Telugu
<b>AR</b> Arabic	<b>FY</b> Frisian	<b>KU</b> Kurdish	<b>PS</b> Pashto, Pushto	<b>TG</b> Tajik
<b>AS</b> Assamese	<b>GA</b> Irish	<b>KY</b> Kirghiz	<b>PT</b> Portuguese	<b>TH</b> Thai
<b>AY</b> Aymara	<b>GD</b> Scots Gaelic	<b>LA</b> Latin	<b>QU</b> Quechua	<b>TI</b> Tigrinya
<b>AZ</b> Azerbaijani	<b>GL</b> Galician	<b>LN</b> Lingala	<b>RM</b> Rhaeto-Romance	<b>TK</b> Turkmen
<b>BA</b> Bashkir	<b>GN</b> Guarani	<b>LO</b> Laothian	<b>RN</b> Kirundi	<b>TL</b> Tagalog
<b>BE</b> Byelorussian	<b>GU</b> Gujarati	<b>LT</b> Lithuanian	<b>RO</b> Rumanian	<b>TN</b> Setswana
<b>BG</b> Bulgarian	<b>HA</b> Hausa	<b>LV</b> Latvian, Lettish	<b>RW</b> Kinyarwanda	<b>TO</b> Tonga
<b>BH</b> Bihari	<b>HI</b> Hindi	<b>MG</b> Malagasy	<b>SA</b> Sanskrit	<b>TR</b> Turkish
<b>BI</b> Bislama	<b>HR</b> Croatian	<b>MI</b> Maori	<b>SD</b> Sindhi	<b>TS</b> Tsonga
<b>BN</b> Bengali, Bangla	<b>HU</b> Hungarian	<b>MK</b> Macedonian	<b>SG</b> Sangho	<b>TT</b> Tatar
<b>BO</b> Tibetan	<b>HY</b> Armenian	<b>ML</b> Malayalam	<b>SH</b> Serbo-Croatian	<b>TW</b> Twi
<b>BR</b> Breton	<b>IA</b> Interlingua	<b>MN</b> Mongolian	<b>SI</b> Singhalese	<b>UK</b> Ukrainian
<b>CA</b> Catalan	<b>IE</b> Interlingue	<b>MO</b> Moldavian	<b>SK</b> Slovak	<b>UR</b> Urdu
<b>CO</b> Corsican	<b>IK</b> Inupiak	<b>MR</b> Marathi	<b>SL</b> Slovenian	<b>UZ</b> Uzbek
<b>CS</b> Czech	<b>IN</b> Indonesian	<b>MS</b> Malay (MAY)	<b>SM</b> Samoan	<b>VI</b> Vietnamese
<b>CY</b> Welsh	<b>IS</b> Icelandic	<b>MT</b> Maltese	<b>SN</b> Shona	<b>VO</b> Volapuk
<b>DA</b> Danish	<b>IW</b> Hebrew	<b>MY</b> Burmese	<b>SO</b> Somali	<b>WO</b> Wolof
<b>DZ</b> Bhutani	<b>JI</b> Yiddish	<b>NA</b> Nauru	<b>SQ</b> Albanian	<b>XH</b> Xhosa
<b>EL</b> Greek	<b>JW</b> Javanese	<b>NE</b> Nepali	<b>SR</b> Serbian	<b>YO</b> Yoruba
<b>EO</b> Esperanto	<b>KA</b> Georgian	<b>NL</b> Dutch	<b>SS</b> Siswati	<b>ZU</b> Zulu
<b>ET</b> Estonian	<b>KK</b> Kazakh	<b>NO</b> Norwegian	<b>ST</b> Sesotho	
<b>EU</b> Basque	<b>KL</b> Greenlandic	<b>OC</b> Occitan	<b>SU</b> Sundanese	

## Specifications

### Amplifier section

#### Output Power:

90 W per channel, min. RMS, driven into 6  $\Omega$  at 1 kHz with no more than 10% total harmonic distortion.

#### Digital output:

##### OPTICAL DIGITAL OUTPUT:

-21 dBm to -15 dBm (660 nm  $\pm$ 30 nm)

#### Audio input sensitivity/Impedance

(Measured at 1 kHz, with tape recording signal 400 mV)

AUX: 400 mV/47 k $\Omega$

MIC: 3.0 mV/50 k $\Omega$

#### VIDEO OUT:

Color system: NTSC/PAL selectable

VIDEO (composite): 1 V(p-p)/75  $\Omega$

S-VIDEO: Y (luminance) 1 V(p-p)/75  $\Omega$

C (chrominance, burst) 0.286 V(p-p)/75  $\Omega$

**Speaker Terminals:** 6  $\Omega$  – 16  $\Omega$

### Tuner section

FM tuning range: 87.50 MHz – 108.00 MHz

AM (MW) tuning range: 531 kHz – 1 710 kHz (at 9 kHz)

530 kHz – 1 710 kHz (at 10 kHz)

For Saudi Arabia only: 531 kHz – 1 602 kHz (at 9 kHz)

530 kHz – 1 600 kHz (at 10 kHz)

### Disc player section

Playable disc: DVD Video/CD/VCD/SVCD

CD-R/-RW/-ROM (CD/VCD/SVCD/MP3/WMA/  
JPEG/MPEG-1/MPEG-2 format)

DVD-R/-RW (DVD Video/DVD Video Recording  
(VR)/MP3/WMA/JPEG/MPEG-1/MPEG-2 format)  
+R/+RW (DVD Video format)

Dynamic range: 90 dB

Horizontal resolution: 500 lines

Wow and flutter: Immeasurable

### Cassette deck section

Frequency response

Normal (type I): 50 Hz – 14 000 Hz

Wow and flutter: 0.15% (WRMS)

### General

Power requirement: AC 110 V / AC 127 V / AC 220 V /  
AC 230 V – AC 240 V  $\sim$ , (adjustable  
with the voltage selector), 50 Hz / 60 Hz

Power consumption: at operation: 95 W  
on standby: 17 W

Dimensions (approx.): 265 mm x 337 mm x 370 mm (W/H/D)

Mass (approx.): 7.9 kg

*Design and specifications are subject to change without notice.*

- Manufactured under license from Dolby Laboratories. “Dolby”, “Pro Logic”, and the double-D symbol are trademarks of Dolby Laboratories.
  - “DTS” is a registered trademark of DTS, Inc. and “DTS 2.0+Digital Out” is a trademark of DTS, Inc.
  - Microsoft and Windows Media are either registered trademarks or trademarks of Microsoft Corporation in the United States and/or other countries.
  - This product incorporates copyright protection technology that is protected by U.S. patents and other intellectual property rights. Use of this copyright protection technology must be authorized by Macrovision, and is intended for home and other limited viewing uses only unless otherwise authorized by Macrovision. Reverse engineering or disassembly is prohibited.
- “CONSUMERS SHOULD NOTE THAT NOT ALL HIGH DEFINITION TELEVISION SETS ARE FULLY COMPATIBLE WITH THIS PRODUCT AND MAY CAUSE ARTIFACTS TO BE DISPLAYED IN THE PICTURE. IN CASE OF 525 OR 625 PROGRESSIVE SCAN PICTURE PROBLEMS, IT IS RECOMMENDED THAT THE USER SWITCH THE CONNECTION TO THE ‘STANDARD DEFINITION’ OUTPUT. IF THERE ARE QUESTIONS REGARDING OUR TV SET COMPATIBILITY WITH THIS MODEL 525p AND 625p DVD PLAYER, PLEASE CONTACT OUR CUSTOMER SERVICE CENTER.”



## OPTICAL DIGITAL OUTPUT Signals

DIGITAL AUDIO OUTPUT Playback disc	Output Signals		
	STREAM/PCM	DOLBY DIGITAL/PCM	PCM ONLY
<b>DVD Video</b>			
with 48 kHz, 16/20/24 bit Linear PCM	48 kHz, 16 bit Linear PCM*		
with 96 kHz, Linear PCM	48 kHz, 16 bit Linear PCM		
with Dolby Digital	Dolby Digital bitstream		48 kHz, 16 bit Linear PCM
with DTS	DTS bitstream	48 kHz, 16 bit Linear PCM	
<b>DVD-VR format discs</b>			
with 48 kHz, 16/20/24 bit Linear PCM	48 kHz, 16 bit Linear PCM*		
with Dolby Digital	Dolby Digital bitstream		48 kHz, 16 bit Linear PCM
<b>SVCD, VCD, CD</b>	44.1 kHz, 16 bit Linear PCM/48 kHz, 16 bit Linear PCM		
<b>CD with DTS</b>	DTS bitstream	44.1 kHz, 16 bit Linear PCM	
<b>MP3/WMA/MPEG-1/MPEG-2 disc</b>	32/44.1/48 kHz, 16 bit Linear PCM		

\* While playing some DVDs, digital signals may be emitted at 20 bits or 24 bits (at their original bit rate) through the OPTICAL DIGITAL OUTPUT terminal if the discs are not copy-protected.

# Parts Index

## Remote control

Button	Page	Button	Page
⊕/I AUDIO	14	DVD/CD ▶	5
⊕/I TV	15		8, 10, 17, 18, 19, 25, 28-31
^/~/</>	19	ECHO	1
	6, 11, 13, 14, 16, 17, 19, 22-25, 31, 32, 34	ENTER/SET	19
			6, 9, 11, 13, 14, 22, 23, 25, 32, 33, 34
◀◀/▶▶	8	FADEMUTING	29
	9-11, 19		9
◀◀/▶▶	24	FM MODE	23
	9, 10, 17		9
■	22	FM/AM	21
	10, 11, 19, 25, 30, 31	KARAOKE*1	1
			28-31
	23	KEY b/#*1	24
	10, 17, 19, 25		29
Number buttons	1	MENU	18
	9, 10, 11, 18, 23, 31	ON SCREEN	20
			22, 23
3D PHONIC	26	PG	2
	13		24
A-B RPT	9	PL	18
	20		24
AHB	11	PLAY MODE	6
	12		18, 19
ANGLE	1	PREV./NEXT	8
	16		10, 11
AUDIO/MPX	1	REPEAT	9
	15, 29		20, 25
AUX	7	RESERVE*1	1
	8		31
CANCEL	1	RETURN	1
	14, 19, 31, 32, 33		11
CLOCK/TIMER	17	SCAN MODE	1
	14, 32, 33		6
DIMMER	16	SET UP	3
	14		34
DISPLAY	17	SHIFT	12
	14		6, 11, 14, 15-17, 19, 20, 25, 28-31, 36
DVD LEVEL +/-	13	SLEEP	16
	12		33
SLOW +/-	24	TOP MENU	2
	17		11

Button	Page	Button	Page
SOUND MODE	25	TV CHANNEL +/-	19
SOUND TURBO	27	TV VOLUME	28
SUB TITLE	1	TV/VIDEO	19
TAPE A ▶	4	VFP	1
TAPE B ▶	4	VOLUME	28
TITLE/GROUP	10	ZOOM	1
	10		17, 25

## Main unit

Button	Page	Button	Page
⊕/I	①	DUBBING	⑨
◀◀/▶▶	④	DVD/CD ▷	⑮
	9, 10, 11, 27		10, 17, 27, 28-30
■	⑮	DVD LEVEL +/-	⑲
	9, 10, 11, 20, 26, 27, 30		12
		FM/AM	③
			8, 9
	⑰	MIC jack*1	⑳
	10, 17, 27		28-31
OPEN/CLOSE ▲	⑬	MIC LEVEL	⑱
	10, 20		28-31
PUSH OPEN ▲	⑩	PHONES jack	⑦
	11, 26		8
3D PHONIC	⑪	REC START/STOP	⑤
	13		26
ACTIVE BASS EXTENSION	⑳	Remote sensor	②
	12		6
		SOUND MODE	⑧
			13
AUX	③	SOUND TURBO	⑭
	8		12
AUX jack*2	⑳	TAPE A ▷	⑮
	5		8, 11
DEMO	⑯	TAPE B ▷	⑮
	6		8, 11, 27
DISC REC	⑥	VOLUME	⑳
	27		8, 29, 30
Display	⑫		
	7		

\*1 Not on the Australian model. \*2 The Australian model only.

## Remote Control

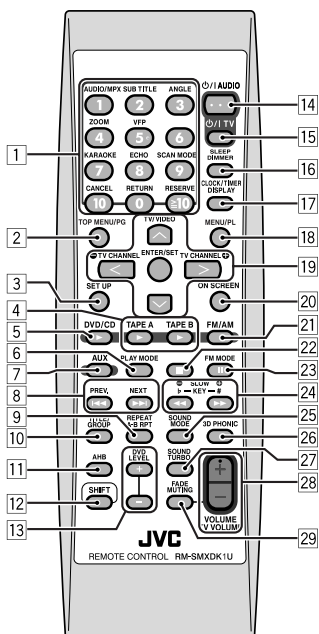

## Main Unit

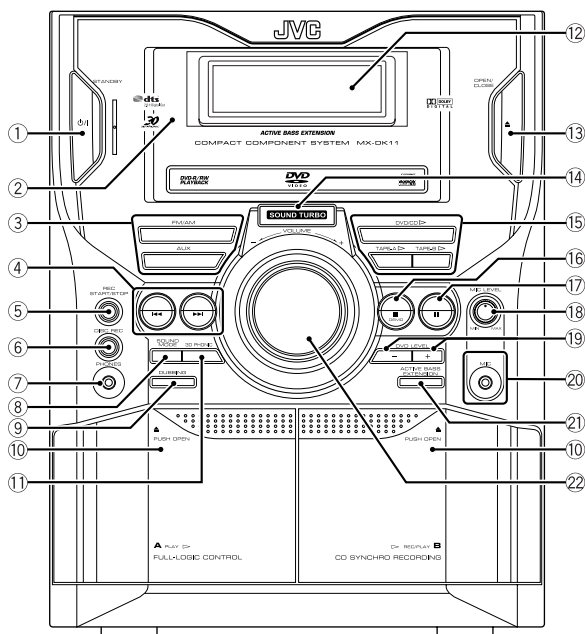

# Mains (AC) Line Instruction (not applicable for Europe, U.S.A., Canada and U.K.)

## CAUTION for mains (AC) line

BEFORE PLUGGING IN, do check that your mains (AC) line voltage corresponds with the position of the voltage selector switch provided on the outside of this equipment and, if different, reset the voltage selector switch, to prevent from a damage or risk of fire/electric shock.

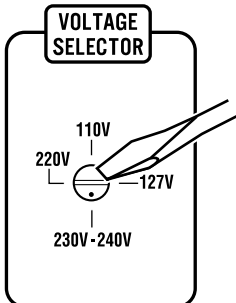

When your mains (AC) line voltage is 230-240 V

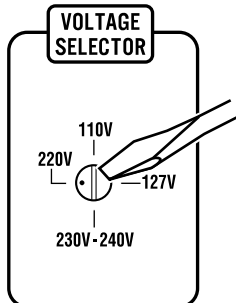

When your mains (AC) line voltage is 220 V

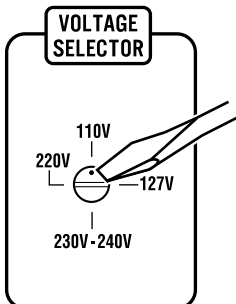

When your mains (AC) line voltage is 110 V

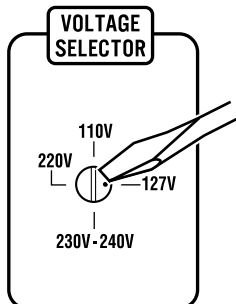

When your mains (AC) line voltage is 127 V

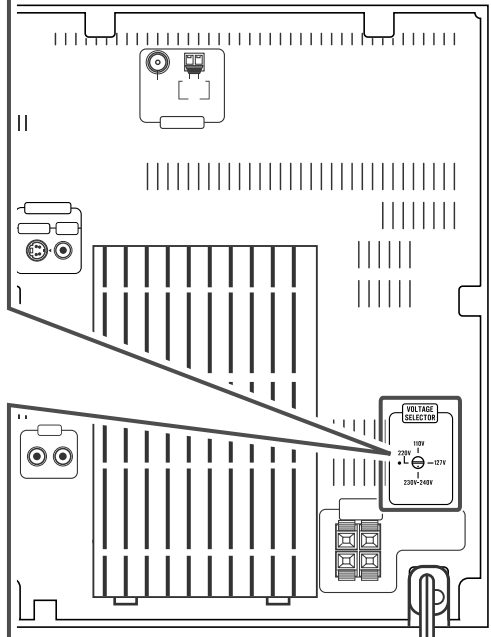

# JVC



## Free Manuals Download Website

<http://myh66.com>

<http://usermanuals.us>

<http://www.somanuals.com>

<http://www.4manuals.cc>

<http://www.manual-lib.com>

<http://www.404manual.com>

<http://www.luxmanual.com>

<http://aubethermostatmanual.com>

Golf course search by state

<http://golfingnear.com>

Email search by domain

<http://emailbydomain.com>

Auto manuals search

<http://auto.somanuals.com>

TV manuals search

<http://tv.somanuals.com>