

# JVC



## COMPACT COMPONENT SYSTEM

# CA-MXGT91R CA-MXG71R

### CA-MXGT91R

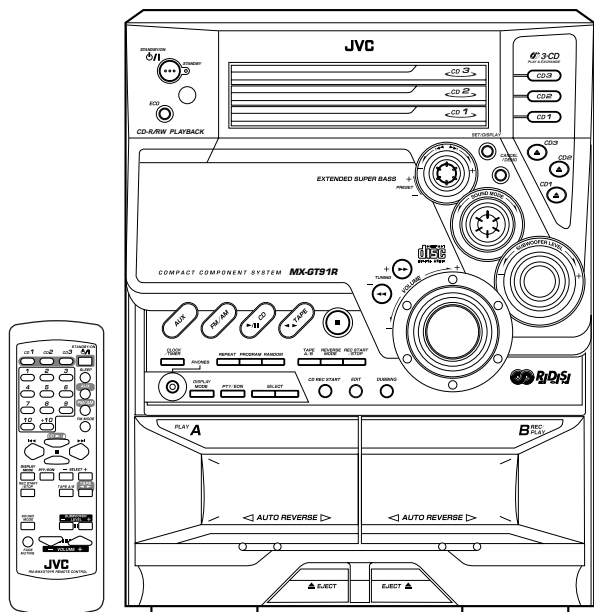

### CA-MXG71R

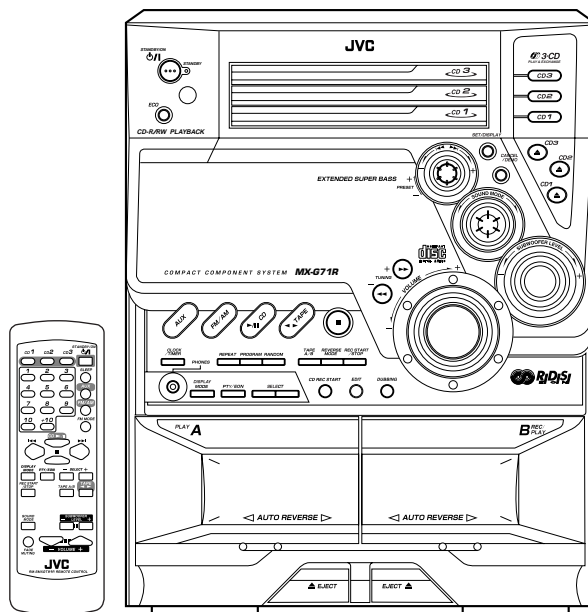

COMPACT  
**disc**  
DIGITAL AUDIO



COMPACT  
**disc**  
DIGITAL AUDIO



## INSTRUCTIONS

### For Customer Use:

Enter below the Model No. and Serial No. which are located either on the rear, bottom or side of the cabinet. Retain this information for future reference.

Model No. \_\_\_\_\_

Serial No. \_\_\_\_\_

GVT0052-008A  
[B]

# Warnings, Cautions and Others

## IMPORTANT for the U.K.

**DO NOT** cut off the mains plug from this equipment. If the plug fitted is not suitable for the power points in your home or the cable is too short to reach a power point, then obtain an appropriate safety approved extension lead or consult your dealer.

**BE SURE** to replace the fuse only with an identical approved type, as originally fitted.

If nonetheless the mains plug is cut off ensure to remove the fuse and dispose of the plug immediately, to avoid a possible shock hazard by inadvertent connection to the mains supply.

If this product is not supplied fitted with a mains plug then follow the instructions given below:

### IMPORTANT:

**DO NOT** make any connection to the terminal which is marked with the letter E or by the safety earth symbol or coloured green or green-and-yellow.

The wires in the mains lead on this product are coloured in accordance with the following code:

Blue : Neutral  
Brown : Live

As these colours may not correspond with the coloured markings identifying the terminals in your plug proceed as follows:

The wire which is coloured blue must be connected to the terminal which is marked with the letter N or coloured black.

The wire which is coloured brown must be connected to the terminal which is marked with the letter L or coloured red.

**IF IN DOUBT - CONSULT A COMPETENT ELECTRICIAN.**

### Caution — STANDBY/ON button!

Disconnect the mains plug to shut the power off completely. The STANDBY/ON  button in any position does not disconnect the mains line. The power can be remote controlled.

### CAUTION

To reduce the risk of electrical shocks, fire, etc.:

1. Do not remove screws, covers or cabinet.
2. Do not expose this appliance to rain or moisture.

## IMPORTANT FOR LASER PRODUCTS

### REPRODUCTION OF LABELS

- ① CLASSIFICATION LABEL, PLACED ON REAR ENCLOSURE

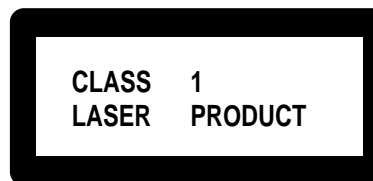

- ② WARNING LABEL, PLACED INSIDE THE UNIT

<b>DANGER:</b> Invisible laser radiation when open and interlock failed or defeated. AVOID DIRECT EXPOSURE TO BEAM. (e)	<b>WARNING:</b> Osynlig laserstrålning när denna del är öppenad och spärren är urkopplad. Betrakta ej strålen. (s)	<b>ADVARSEL:</b> Usynlig laserstrålning ved åbning, når sikkerhedsafbrydere er ude af funktion. Undgå udsættelse for stråling (d)	<b>VARO:</b> Avattaessa ja suojaluukitus ohitettaessa olet allittina näkymättömälle lasersäteilylle. Älä katso säteeseen. (f)
---	--	---	---

1. CLASS 1 LASER PRODUCT
2. **DANGER:** Invisible laser radiation when open and interlock failed or defeated. Avoid direct exposure to beam.
3. **CAUTION:** Do not open the top cover. There are no user serviceable parts inside the Unit; leave all servicing to qualified service personnel.

### CAUTION

- Do not block the ventilation openings or holes. (If the ventilation openings or holes are blocked by a newspaper or cloth, etc., the heat may not be able to get out.)
- Do not place any naked flame sources, such as lighted candles, on the apparatus.
- When discarding batteries, environmental problems must be considered and local rules or laws governing the disposal of these batteries must be followed strictly.
- Do not use this apparatus in a bathroom or places with water. Also do not place any containers filled with water or liquids (such as cosmetics or medicines, flower vases, potted plants, cups, etc.) on top of this apparatus.

### Caution: Proper Ventilation

To avoid risk of electric shock and fire, and to prevent damage, locate the apparatus as follows:

#### 1 Front:

No obstructions and open spacing.

#### 2 Sides/ Top/ Back:

No obstructions should be placed in the areas shown by the dimensions below.

#### 3 Bottom:

Place on the level surface. Maintain an adequate air path for ventilation by placing on a stand with a height of 10 cm or more.

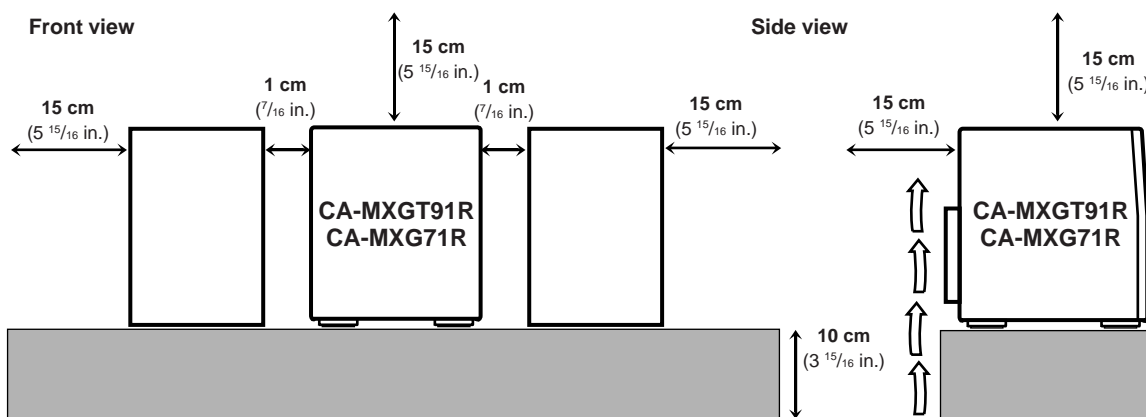

## **SAFETY INSTRUCTIONS**

### **“SOME DOS AND DON'TS ON THE SAFE USE OF EQUIPMENT”**

This equipment has been designed and manufactured to meet international safety standards but, like any electrical equipment, care must be taken if you are to obtain the best results and safety is to be assured.

\*\*\*\*\*

Do read the operating instructions before you attempt to use the equipment.

Do ensure that all electrical connections (including the mains plug, extension leads and interconnections between pieces of equipment) are properly made and in accordance with the manufacturer's instructions. Switch off and withdraw the mains plug when making or changing connections.

Do consult your dealer if you are ever in doubt about the installation, operation or safety of your equipment.

Do be careful with glass panels or doors on equipment.

\*\*\*\*\*

DON'T continue to operate the equipment if you are in any doubt about it working normally, or if it is damaged in any way — switch off, withdraw the mains plug and consult your dealer.

DON'T remove any fixed cover as this may expose dangerous voltages.

DON'T leave equipment switched on when it is unattended unless it is specifically stated that it is designed for unattended operation or has a standby mode.

Switch off using the switch on the equipment and make sure that your family know how to do this.

Special arrangements may need to be made for infirm or handicapped people.

DON'T use equipment such as personal stereos or radios so that you are distracted from the requirements of traffic safety. It is illegal to watch television whilst driving.

DON'T listen to headphones at high volume as such use can permanently damage your hearing.

DON'T obstruct the ventilation of the equipment, for example with curtains or soft furnishings.

Overheating will cause damage and shorten the life of the equipment.

DON'T use makeshift stands and NEVER fix legs with wood screws — to ensure complete safety always fit the manufacturer's approved stand or legs with the fixings provided according to the instructions.

DON'T allow electrical equipment to be exposed to rain or moisture.

ABOVE ALL

- NEVER let anyone, especially children, push anything into holes, slots or any other opening in the case — this could result in a fatal electrical shock.
- NEVER guess or take chances with electrical equipment of any kind — it is better to be safe than sorry!

# Introduction

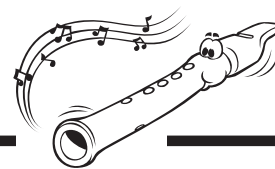

We would like to thank you for purchasing one of our JVC products. Before operating this unit, read this manual carefully and thoroughly to obtain the best possible performance from your unit, and retain this manual for future reference.

## About This Manual

This manual is organized as follows:

- The manual mainly explains operations using the buttons and controls on the unit. You can also use the buttons on the remote control if they have the same or similar names (or marks) as those on the unit. If operation using the remote control is different from that using the unit, it is then explained.
- Basic and common information that is the same for many functions is grouped in one place, and is not repeated in each procedure. For instance, we do not repeat the information about turning on/off the unit, setting the volume, changing the sound effects, and others, which are explained in the section “Common Operations” on pages 9 to 11.
- The following marks are used in this manual:



Gives you warnings and cautions to prevent from damage or risk of fire/electric shock. Also gives you information which is not good for obtaining the best possible performance from the unit.



Gives you information and hints you had better know.

## Precautions

### Installation

- Install in a place which is level, dry and neither too hot nor too cold — between 5°C (41°F) and 35°C (95°F).
- Install the unit in a location with adequate ventilation to prevent internal heat buildup in the unit.
- Leave sufficient distance between the unit and the TV.
- Keep the speakers away from the TV to avoid interference with TV.



DO NOT install the unit in a location near heat sources, or in a place subject to direct sunlight, excessive dust or vibration.

### Power sources

- When unplugging from the wall outlet, always pull the plug, not the AC power cord.



DO NOT handle the AC power cord with wet hands.

### Moisture condensation

Moisture may condense on the lens inside the unit in the following cases:

- After starting heating in the room
  - In a damp room
  - If the unit is brought directly from a cold to a warm place
- Should this occur, the unit may malfunction. In this case, leave the unit turned on for a few hours until the moisture evaporates, unplug the AC power cord, and then plug it in again.

### Others

- Should any metallic object or liquid fall into the unit, unplug the unit and consult your dealer before operating any further.
- If you are not going to operate the unit for an extended period of time, unplug the AC power cord from the wall outlet.



DO NOT disassemble the unit since there are no user serviceable parts inside.

If anything goes wrong, unplug the AC power cord and consult your dealer.

# Contents

---

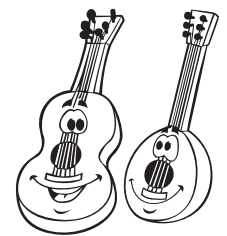

<b>Location of the Buttons and Controls .....</b>	<b>3</b>	<b>Playing Back CDs (CD/CD-R/CD-RW) .....</b>	<b>15</b>
Front Panel .....	3	Loading CDs .....	15
Remote Control .....	5	Playing Back the Entire Discs	
<b>Getting Started .....</b>	<b>6</b>	— Continuous Play .....	16
Supplied Accessories .....	6	Basic CD Operations .....	16
Putting the Batteries into the Remote Control .....	6	Programming the Playing Order of the Tracks	
Connecting Antennas .....	6	— Program Play .....	17
Connecting Speakers .....	7	Playing at Random — Random Play .....	18
Connecting Other Equipment .....	8	Repeating Tracks or CDs — Repeat Play .....	18
Canceling the Display Demonstration .....	8	Prohibiting Disc Ejection — Tray Lock .....	18
<b>Common Operations .....</b>	<b>9</b>	<b>Playing Back Tapes .....</b>	<b>19</b>
Turning On or Off the Power .....	9	Playing Back a Tape .....	19
Saving the Power Consumption While on Standby		Locating the Beginning of a Song — Music Scan ...	19
— Ecology Mode .....	9	<b>Recording .....</b>	<b>20</b>
Setting the Clock .....	9	Recording a Tape on Deck B .....	20
Selecting the Sources .....	10	Dubbing Tapes .....	21
Adjusting the Volume .....	10	CD Direct Recording .....	21
Reinforcing the Bass Sound .....	10	Auto Edit Recording .....	22
Selecting the Sound Modes .....	10	<b>Using the Timers .....</b>	<b>23</b>
Creating Your Own Sound Mode		Using Daily Timer .....	23
— Manual Mode .....	11	Using Recording Timer .....	25
<b>Listening to FM and AM (MW/LW) Broadcasts ...</b>	<b>12</b>	Using Sleep Timer .....	26
Tuning in a Station .....	12	Timer Priority .....	26
Presetting Stations .....	12	<b>Additional Information .....</b>	<b>27</b>
Tuning in a Preset Station .....	12	<b>Troubleshooting .....</b>	<b>28</b>
<b>Receiving FM Stations with RDS .....</b>	<b>13</b>	<b>Maintenance .....</b>	<b>29</b>
Changing the RDS Information .....	13	<b>Specifications .....</b>	<b>30</b>
Searching for Programs by PTY Codes			
(PTY Search) .....	13		
Switching to a Program Type			
of Your Choice Temporarily .....	14		

# Location of the Buttons and Controls

Become familiar with the buttons and controls on your unit.

## Front Panel

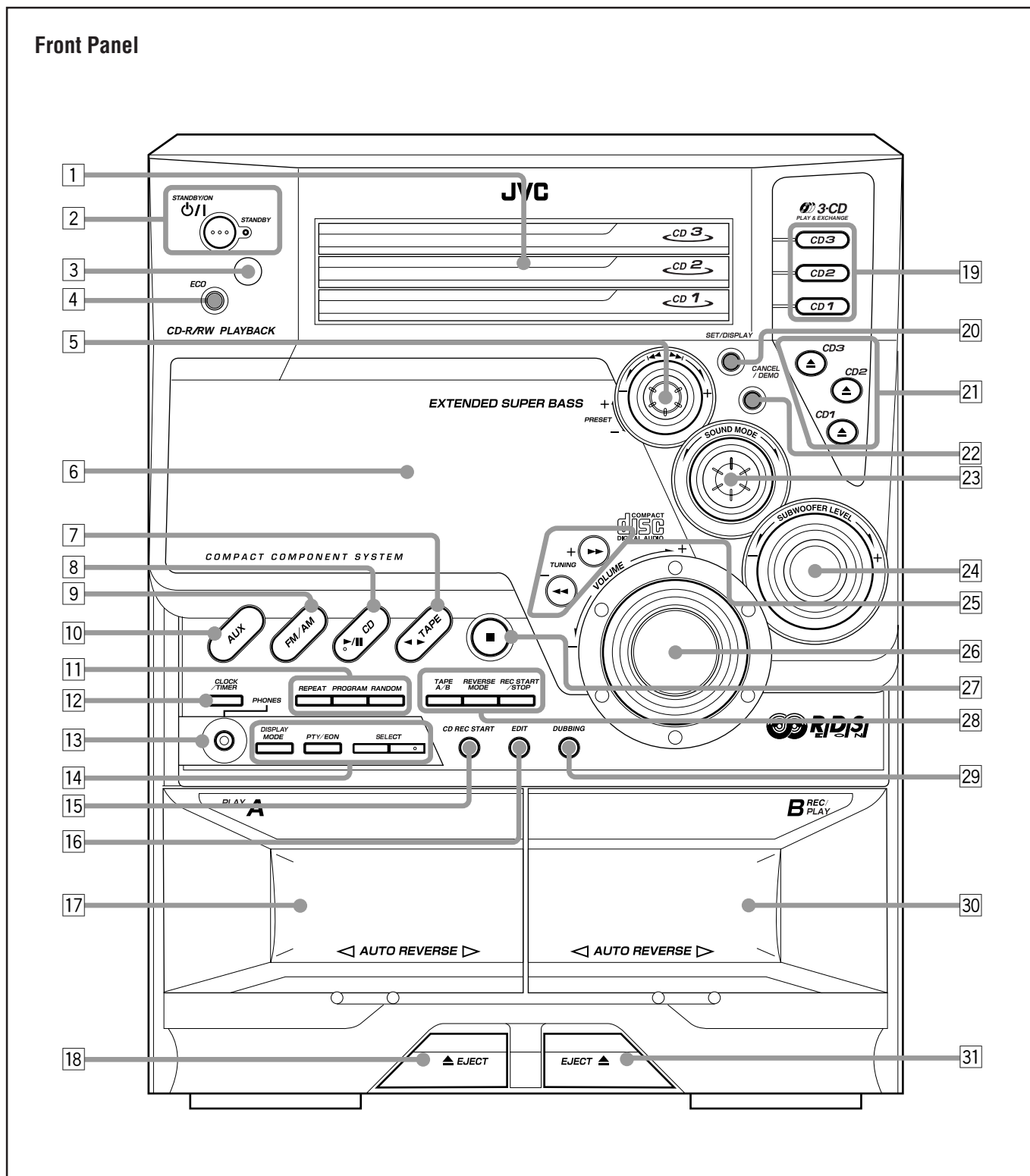

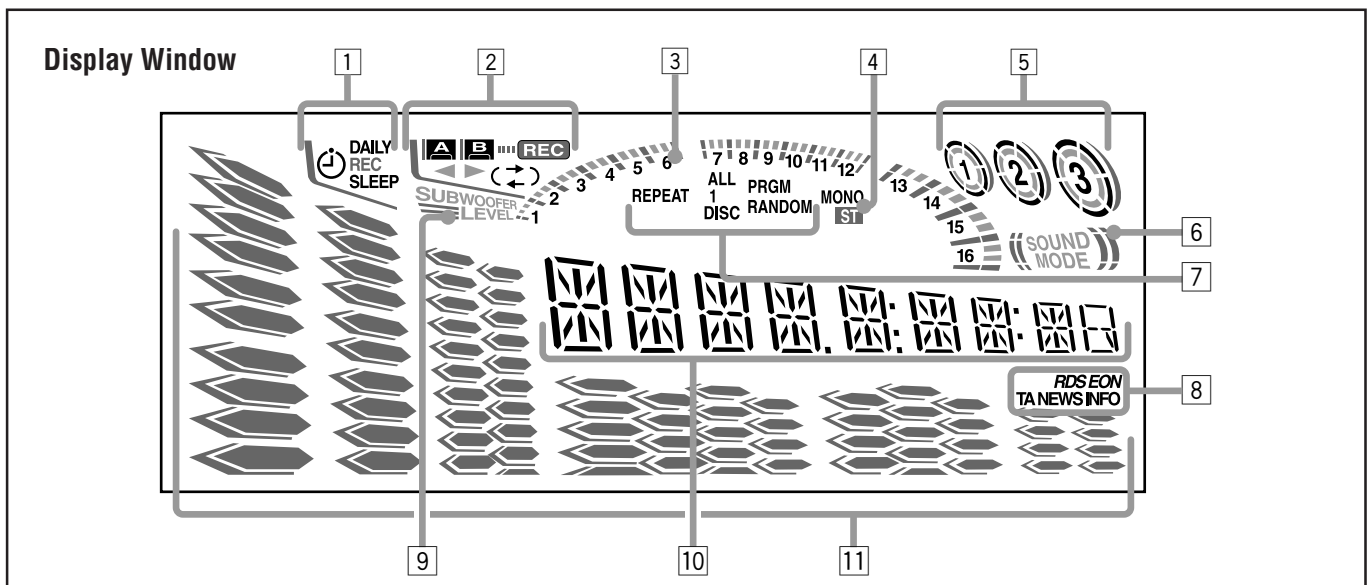

See pages in the parentheses for details.

### Front Panel

- 1 Disc trays
- 2 STANDBY/ON  $\text{\textcircled{I}}$  button and STANDBY lamp (9, 24, 25)
- 3 Remote sensor
- 4 ECO button (9)
- 5 PRESET + / - control (12)  
◀◀ / ▶▶ (reverse search/forward search) control (9, 11, 16 – 18, 22 – 25)
- 6 Display window
- 7 TAPE ◀▶ button and lamp (9, 19 – 21)  
*Pressing this button also turns on the unit.*
- 8 CD ▶/|| (play/pause) button and lamp (9, 16 – 18, 22)  
*Pressing this button also turns on the unit.*
- 9 FM/AM button and lamp (9, 12)  
*Pressing this button also turns on the unit.*
- 10 AUX button and lamp (9)  
*Pressing this button also turns on the unit.*
- 11 CD play mode buttons
  - REPEAT button (18)
  - PROGRAM button (17)
  - RANDOM button (18)
- 12 CLOCK/TIMER button (9, 23 – 26)
- 13 PHONES jack (10)
- 14 RDS operation buttons
  - DISPLAY MODE button (13)
  - PTY/EON button (13, 14)
  - SELECT + / - buttons (13, 14)
- 15 CD REC START button (21, 22)
- 16 EDIT button (22)
- 17 Deck A cassette holder (19)
- 18 ▲ EJECT button for deck A (19)
- 19 Disc number buttons and lamps (CD1, CD2, and CD3) (16, 17, 21, 22)  
*Pressing one of these buttons also turns on the unit.*
- 20 SET/DISPLAY button (9, 11, 12, 17, 22 – 26)

- 21 ▲ (Disc tray open/close) (CD1, CD2, and CD3) buttons (15, 16, 18)  
*Pressing one of these buttons also turns on the unit.*
- 22 CANCEL/DEMO button (8, 9, 17, 19, 22 – 26)
- 23 SOUND MODE control (10)
- 24 SUBWOOFER LEVEL + / - control (10)
- 25 TUNING + / - buttons (12)  
◀◀ / ▶▶ (fast left/fast right) buttons (11, 16, 19)
- 26 VOLUME + / - control (10)
- 27 ■ (stop) button (16 – 22, 25)
- 28 Tape operation buttons
  - TAPE A/B button (19)
  - REVERSE MODE button (19, 21, 22)
  - REC START/STOP button (20 – 22, 25)
- 29 DUBBING button (21)
- 30 Deck B cassette holder (19 – 22, 25)
- 31 EJECT ▲ button for deck B (19, 20)

### Display Window

- 1 Timer indicators
  - $\text{\textcircled{I}}$  (Timer), DAILY (Daily Timer), REC (Recording Timer), and SLEEP (Sleep Timer) indicators
- 2 Tape operation indicators
  - A/B (operating deck), REC (recording), ◀▶ (tape direction), and  $\text{\textcircled{I}}$  (reverse mode) indicators
- 3 CD track number (1 – 16) indicators
- 4 Tuner operation indicators
  - MONO and ST (stereo) indicators
- 5 Disc indicators
- 6 SOUND MODE indicator
- 7 CD play mode indicators
  - REPEAT (ALL/1/DISC), PRGM (program), and RANDOM indicators
- 8 RDS operation indicators
  - RDS, EON, and TA/NEWS/INFO indicators
- 9 SUBWOOFER LEVEL indicator
- 10 Main display
  - Shows the source name, frequency, etc.
- 11 Audio level indicator





## Remote Control

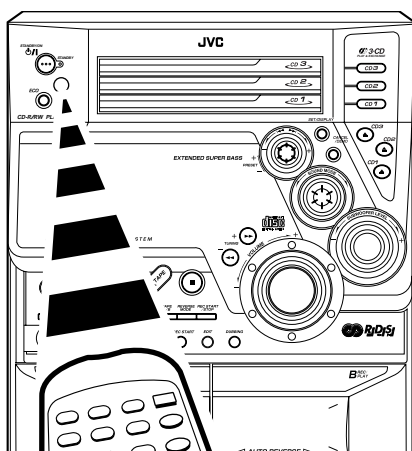
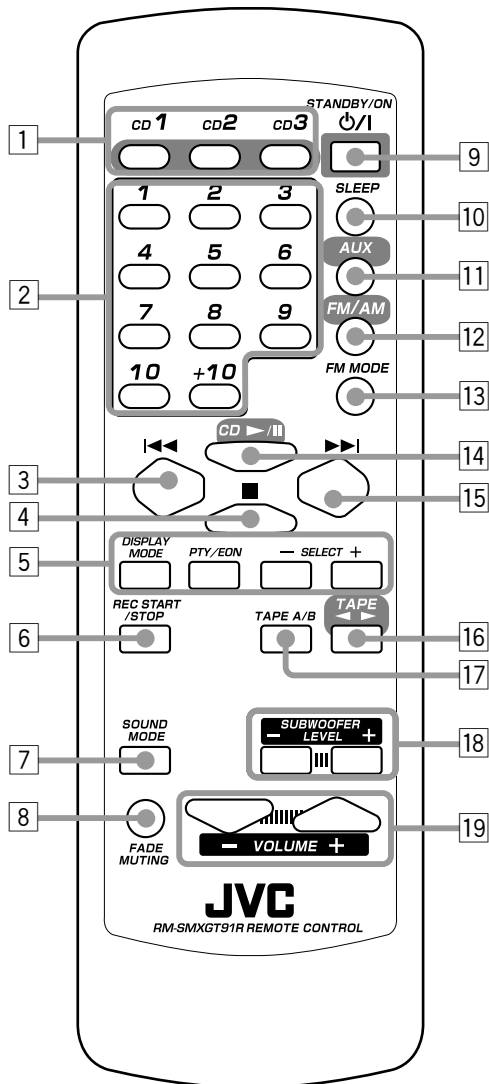

When using the remote control, point it at the remote sensor on the front panel.

## Remote Control

- 1 Disc number buttons (CD1, CD2, and CD3) (16, 17)  
*Pressing one of these buttons also turns on the unit.*
- 2 Number buttons (12, 16, 17)
- 3 ◀◀ (reverse search) button (12, 16, 17, 19)
- 4 ■ (stop) button (16 – 22, 25)
- 5 RDS operation buttons
  - DISPLAY MODE button (13)
  - PTY/EON button (13, 14)
  - SELECT + / – buttons (13, 14)
- 6 REC START/STOP button (20 – 22, 25)
- 7 SOUND MODE button (10)
- 8 FADE MUTING button (10)
- 9 STANDBY/ON ⏻/⏻ button (9)
- 10 SLEEP button (26)
- 11 AUX button (9)  
*Pressing this button also turns on the unit.*
- 12 FM/AM button (9, 12)  
*Pressing this button also turns on the unit.*
- 13 FM MODE button (12)
- 14 CD ▶/|| button (9, 16 – 18)  
*Pressing this button also turns on the unit.*
- 15 ▶▶ (forward search) button (12, 16 – 19)
- 16 TAPE ◀▶ button (9, 19, 20)  
*Pressing this button also turns on the unit.*
- 17 TAPE A/B button (19)
- 18 SUBWOOFER LEVEL + / – buttons (10)
- 19 VOLUME + / – buttons (10)



## Supplied Accessories

Make sure that you have all the following items. The number in the parentheses indicates the quantity of the pieces supplied.

- AM (MW/LW) loop antenna (1)
- FM antenna (1)
- Remote control (1)
- Batteries (2)

If anything is missing, consult your dealer immediately.

## Putting the Batteries into the Remote Control

Insert the batteries — R6(SUM-3)/AA(15F) — into the remote control, by matching the polarity (+ and –) on the batteries with the + and – markings on the battery compartment.

When the remote control can no longer operate the unit, replace both batteries at the same time.

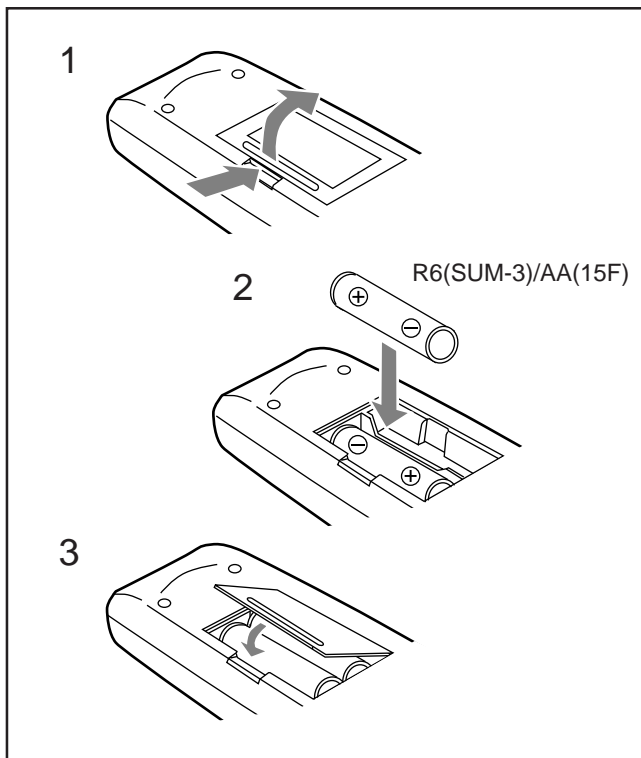

- DO NOT use an old battery together with a new one.
- DO NOT use different types of batteries together.
- DO NOT expose batteries to heat or flame.
- DO NOT leave the batteries in the battery compartment when you are not going to use the remote control for an extended period of time. Otherwise, it will be damaged from battery leakage.

## Connecting Antennas

### FM antenna

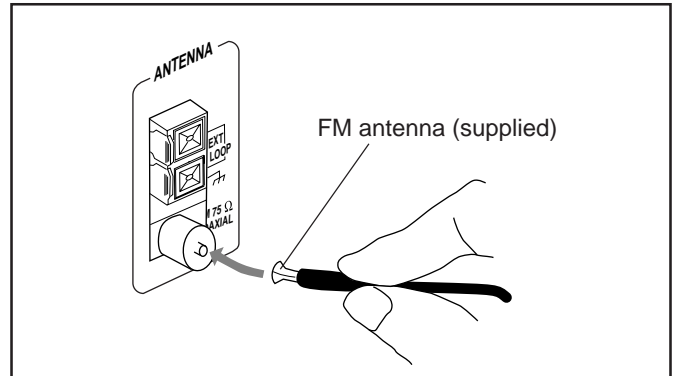

- 1 Attach the FM antenna to the FM 75 Ω COAXIAL terminal.
- 2 Extend the FM antenna.
- 3 Fasten it up in the position which gives you the best reception, then fix it on the wall, etc.



#### About the supplied FM antenna

The FM antenna supplied with this unit can be used as temporary measure. If reception is poor, you can connect an outdoor FM antenna.

### To connect an outdoor FM antenna

Before connecting it, disconnect the supplied FM antenna.

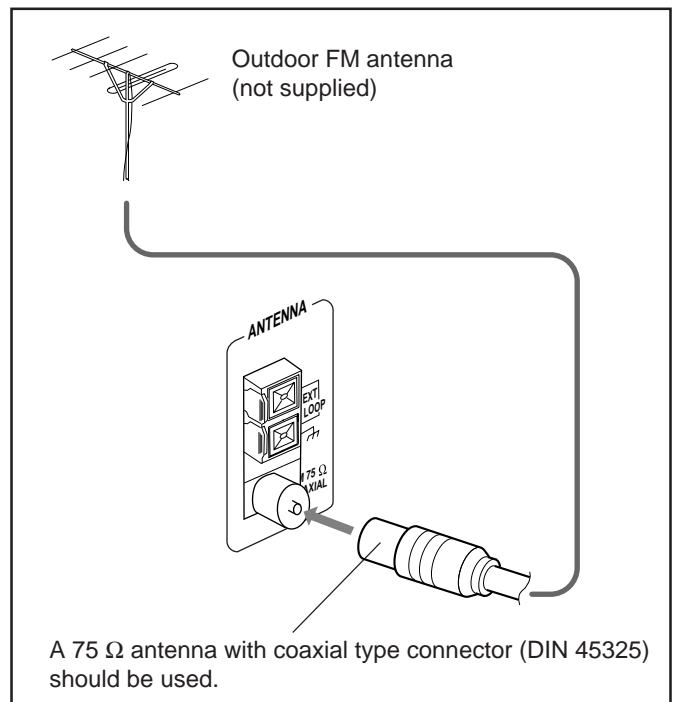

A 75 Ω antenna with coaxial type connector (DIN 45325) should be used.

## AM (MW/LW) antenna

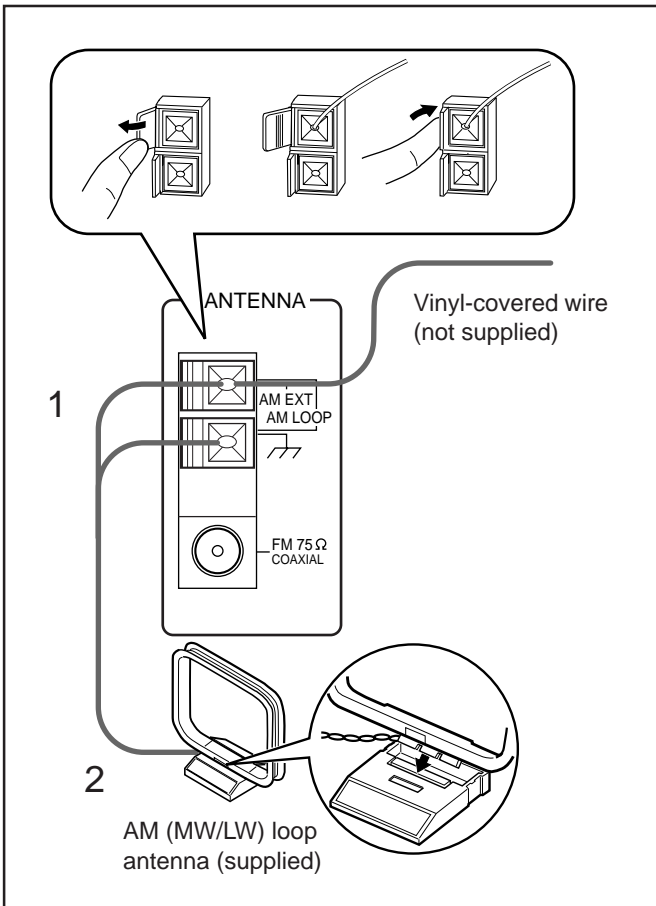

### 1 Connect the AM (MW/LW) loop antenna to the AM LOOP terminals as illustrated.

- If the AM (MW/LW) loop antenna wire is covered with vinyl, remove the vinyl by twisting it as shown in the diagram.

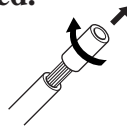

### 2 Turn the AM (MW/LW) loop antenna until you have the best reception.

### To connect an outdoor AM (MW/LW) antenna

When reception is poor, connect a single vinyl-covered wire to the AM EXT terminal and extend it horizontally. The AM (MW/LW) loop antenna must remain connected.



#### For better reception of both FM and AM (MW/LW)

- Make sure the antenna conductors do not touch any other terminals and connecting cords.
- Keep the antennas away from metallic parts of the unit, connecting cords, and the AC power cord.

## Connecting Speakers

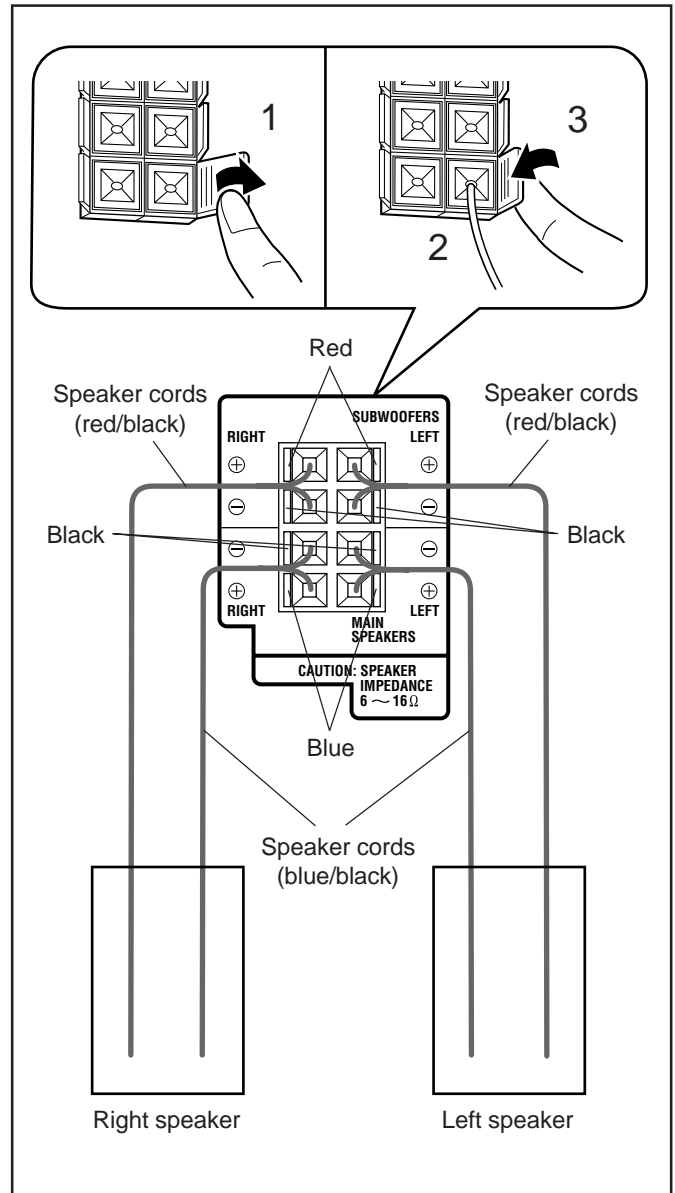

### 1 Open the speaker terminals on the rear of the unit.

### 2 Insert the end of the speaker cord into the terminal.

Match the polarity (colors) of the speaker terminals: Red (+) to red (+) and black (-) to black (-); Blue (+) to blue (+) and black (-) to black (-).

### 3 Close the speaker terminals.

**IMPORTANT:** Use only speakers with the same speaker impedance as indicated by the speaker terminals on the rear of the unit.



## Connecting Other Equipment

You can connect both analog and digital equipment.



- DO NOT connect any equipment while the power is on.
- DO NOT plug in any equipment until all connections are complete.

### To connect an analog component

Be sure that the plugs of the audio cords are colored: White plugs and jacks are for left audio signals, and red ones for right audio signals.

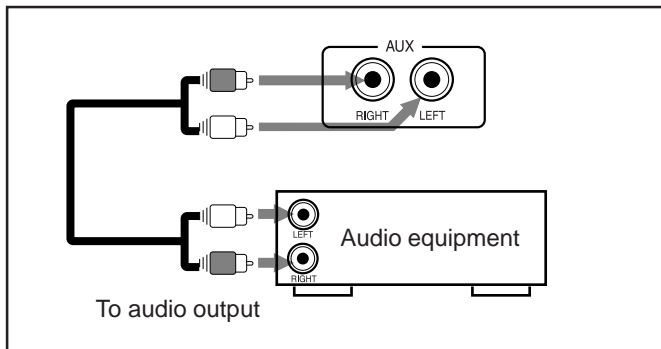

For playing the other equipment through this unit, connect between the audio output jacks on the other equipment and AUX jacks by using audio cords (not supplied).

### To connect audio equipment with an optical digital input terminal

You can record CD sound onto the connected digital equipment.

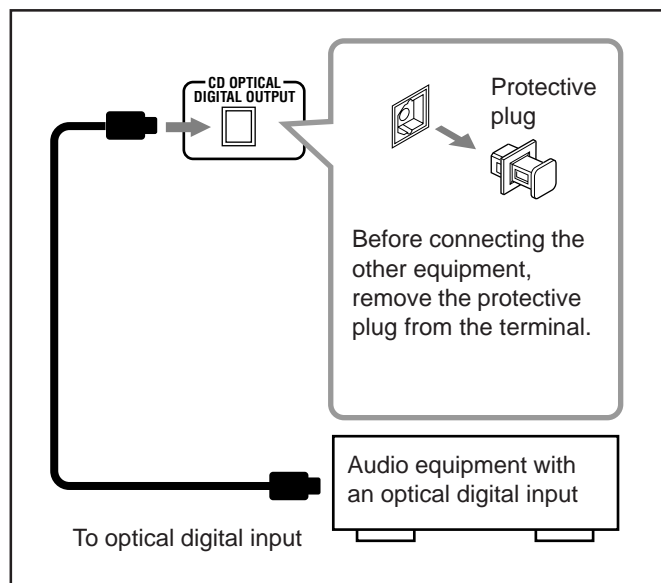

Connect an optical digital cord (not supplied) between the optical digital input terminal on the other equipment and the CD OPTICAL DIGITAL OUTPUT terminal.

## Now, you can plug the AC power cord.

When connecting the AC power cord into a wall outlet, the unit automatically starts display demonstration.

**IMPORTANT:** Be sure to check all connections to be done before plugging the AC power cord into a wall outlet.

## Canceling the Display Demonstration

### On the unit ONLY:

To cancel the display demonstration, press CANCEL/DEMO until "DEMO OFF" appears on the display.



### When you press other buttons

The display demonstration stops temporarily. It will start automatically again (if no operation is done for 2 minutes) unless you cancel it by pressing CANCEL/DEMO.

### To start the display demonstration manually

Press and hold CANCEL/DEMO again for more than 1 second (while Ecology Mode is deactivated).

# Common Operations

## Turning On or Off the Power

To turn on the unit, press STANDBY/ON  so that the STANDBY lamp goes off.

WELCOME

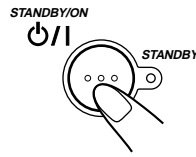

To turn off the unit (on standby), press STANDBY/ON  again so that the STANDBY lamp lights up.

- The clock appears on the display (if Ecology Mode is not activated).

GOODBYE

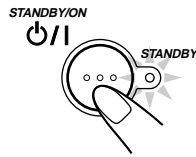

- A little power is always consumed even while the unit is on standby.

To switch off the power supply completely, unplug the AC power cord from the AC outlet.



**When you unplug the AC power cord or if a power failure occurs**

The clock is reset to "0:00" right away, while the tuner preset stations (see page 12) will be erased in a few days.

## Saving the Power Consumption While on Standby — Ecology Mode

You can save the power consumption only while the unit is turned off (on standby).

To activate the Ecology Mode, press ECO. "ECO" appears and the display illumination (including the display demonstration) disappears from the display.

- Each time you press the button, "ECO" and "NORMAL" appear alternately on the display.



To deactivate the Ecology Mode, press ECO again. "NORMAL" appears and the display illumination appears on the display.



**About Ecology Mode**

- You can also activate and deactivate Ecology Mode while the unit is on, but it takes effect only when the unit is on standby.
- While Ecology Mode is activated, the display demonstration is canceled temporarily.

## Setting the Clock

Before operating the unit any further, first set the clock built in this unit. You can set the clock whether the system is on or off.

**On the unit ONLY:**

### 1 Press CLOCK/TIMER.

The hour digits start flashing on the display.



### 2 Turn / to adjust the hour, then press SET/DISPLAY.

The minute digits start flashing on the display.

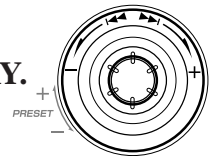

- If you want to correct the hour after pressing SET/DISPLAY, press CANCEL/DEMO.



The hour digits start flashing again.

### 3 Turn / to adjust the minute, then press SET/DISPLAY.

CLOCK OK



### To check the clock time

Press and hold SET/DISPLAY while playing any source.

- Each time you press and hold the button, the source indication and the clock time alternate on the display.

### To adjust the clock again

If you have adjusted the clock before, you need to press CLOCK/TIMER repeatedly until the clock setting mode is selected.

- Each time you press the button, the clock/timer setting modes change as follows:

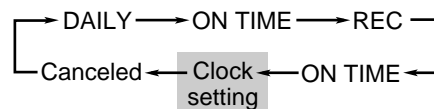

(The hour digits start flashing.)



**When you unplug the AC power cord or if a power failure occurs**

The clock loses the setting and is reset to "0:00." You need to set the clock again.

## Selecting the Sources

To listen to the FM/AM (MW/LW) broadcasts, press FM/AM. (See page 12.)

To play back CDs, press CD ►/II. (See pages 15 – 18.)

To play back tapes, press TAPE ◀▶. (See page 19.)

To select the external equipment as the source, press AUX.



When you press the play button for a particular source (FM/AM, CD ►/II, TAPE ◀▶, and AUX), the unit turns on (and the unit starts playing the source if it is ready — COMPU PLAY CONTROL).



### About the audio level indicator

All the audio level indicators light up when no signals come in.

## Adjusting the Volume

You can adjust the volume level only while the unit is turned on. The volume level can be adjusted in 32 steps (VOL MIN, VOL 01 — VOL 30, and VOL MAX).

Turn VOLUME + / – clockwise (+) to increase the volume or counterclockwise (–) to decrease it.

VOL 15

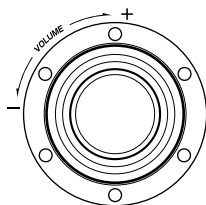

When using the remote control, press VOLUME + to increase the volume or press VOLUME – to decrease it.



### For private listening

Connect a pair of headphones to the PHONES jack. No sound comes out of the speakers. Be sure to turn down the volume before connecting or putting on headphones.



DO NOT turn off (on standby) the unit with the volume set to an extremely high level; otherwise, a sudden blast of sound can damage your hearing, speakers and/or headphones when you turn on the unit or start playing any source next time. REMEMBER you cannot adjust the volume level while the unit is on standby.

### To turn down the volume level temporarily

Press FADE MUTING on the remote control. The volume level gradually decreases to “VOL MIN.”



To restore the sound, press the button again.

## Reinforcing the Bass Sound

You can select one of the 4 subwoofer levels. This function only affects the playback sound, but does not affect your recording. The subwoofer level can be adjusted in 4 steps — LEVEL 1, LEVEL 2, LEVEL 3, and LEVEL 4 (MAX LEVEL).

Turn SUBWOOFER LEVEL + / – clockwise (+) to increase the subwoofer sound or counterclockwise (–) to decrease it.

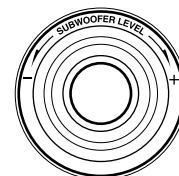

When using the remote control, press SUBWOOFER LEVEL + to increase the subwoofer volume or press SUBWOOFER LEVEL – to decrease it.

SUBWOOFER indicator always lights up when the unit is on.

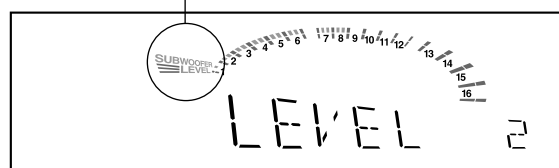

## Selecting the Sound Modes

You can select one of the 6 preset sound modes (3 surround modes and 3 SEA — Sound Effect Amplifier — modes). This function only affects the playback sound, but does not affect your recording.

To select the sound modes, turn SOUND MODE (or press SOUND MODE on the remote control) until the sound mode you want appears on the display.

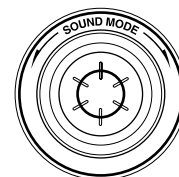

The SOUND MODE indicator also lights up on the display.

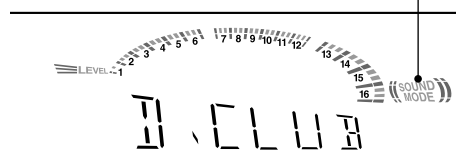

- The sound modes change as follows:

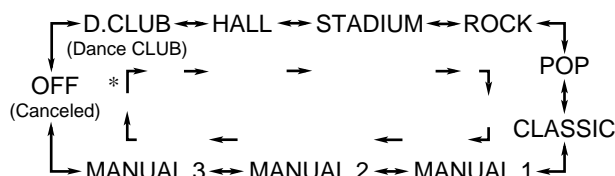

\* When using the remote control, the sound mode changes in only one way.

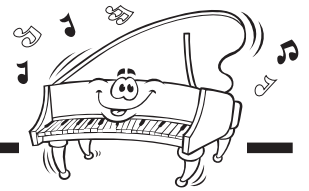

**Surround modes\*\*:**

- D.CLUB:** Increases resonance and bass.
- HALL:** Adds depth and brilliance to the sound.
- STADIUM:** Adds clarity and spreads the sound, like in an outdoor stadium.

**SEA (Sound Effect Amplifier) modes:**

- ROCK:** Boosts low and high frequency. Good for acoustic music.
- POP:** Good for vocal music.
- CLASSIC:** Good for classical music.

**Manual modes:**

**MANUAL 1/2/3:** Your individual mode stored in memory. See “Creating Your Own Sound Mode — Manual Mode.”

**OFF:** The sound mode is canceled. The SOUND MODE indicator goes off.

\*\* Surround elements are added to the SEA elements to create a being-there feeling in your room.

When one of these modes is selected, the SOUND MODE indicator lights up as — 

While one of the SEA modes including manual modes (SEA elements without surround elements) is selected, the SOUND MODE indicator lights up as — 

**Creating Your Own Sound Mode — Manual Mode**

You can change SEA pattern to suit your preference. These changed settings can be stored in the MANUAL 1, MANUAL 2, and MANUAL 3 modes.

- There is a time limit in doing the following steps. If the setting is canceled before you finish, start from step 1 again.

**On the unit ONLY:**

**1 Select one of the preset sound modes.**

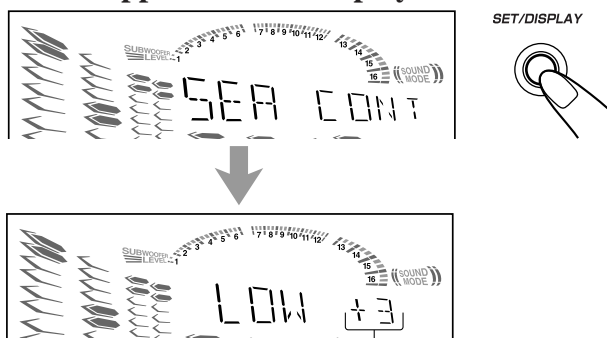

- If you want to add the surround elements in your SEA pattern, select one of the surround modes (D.CLUB, HALL, or STADIUM) before starting the procedure below. (See “Selecting the Sound Modes” on page 10.)

**2 Press and hold SET/DISPLAY until “SEA CONT” appears on the display.**



Current level appears.

**3 Adjust the SEA pattern.**

- 1) Turn  to select the frequency range to adjust (LOW, MID, HIGH).
- 2) Press  to adjust the level (-3 to +3) of the selected frequency range.
- 3) Repeat steps 1) and 2) to adjust the level of the other frequency ranges.

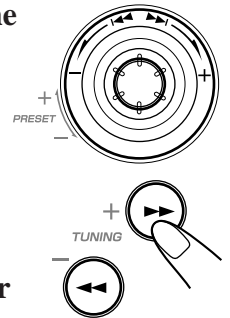

**4 Press SET/DISPLAY again.**

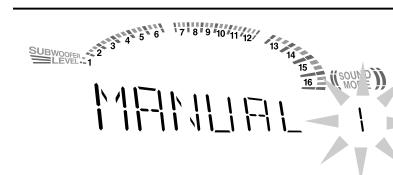

**5 Turn  to select one of the MANUAL 1, MANUAL 2, and MANUAL 3 modes into which you want to store the SEA pattern.**

**6 Press SET/DISPLAY again.**

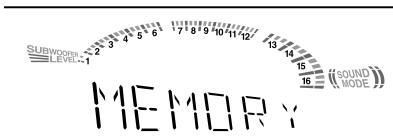

The SEA pattern you have created are stored into the MANUAL mode selected in the above step.

**To use your own sound mode**

Select MANUAL 1, MANUAL 2, or MANUAL 3 mode when using the sound modes. See “Selecting the Sound Modes” on page 10.



**When you unplug the AC power cord or if a power failure occurs**

The setting will be erased in a few days. If this happens, set the manual sound modes again.





# Listening to FM and AM (MW/LW) Broadcasts

## Tuning in a Station

### 1 Press FM/AM.

The unit automatically turns on and tunes in the previously tuned station (either FM or AM — MW/LW).

- Each time you press the button, the band alternates between FM and AM (MW/LW).



### 2 Start searching for stations.

#### On the unit:

Press and hold TUNING + or TUNING – for more than 1 second.

#### On the remote control:

Press and hold ►►► or ◄◄◄ for more than 1 second.

The unit starts searching for stations and stops when a station of sufficient signal strength is tuned in.

- If a program is broadcast in stereo, the ST (stereo) indicator lights up.

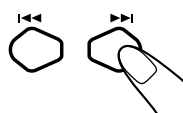
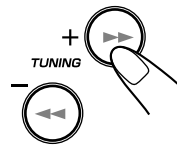

To stop searching, press TUNING + or TUNING – (or ►►► / ◄◄◄ on the remote control).



When you press TUNING + or TUNING – (or ►►► / ◄◄◄ on the remote control) briefly and repeatedly

The frequency changes step by step.

### To change the FM reception mode

When an FM stereo broadcast is hard to receive or noisy, press FM MODE on the remote control so that the MONO indicator lights up on the display. Reception improves.

To restore the stereo effect, press FM MODE again so that the MONO indicator goes off. In this stereo mode, you can hear stereo sounds when a program is broadcast.

FM MODE



## Presetting Stations

You can preset 30 FM and 15 AM (MW/LW) stations.

In some cases, test frequencies have been already memorized for the tuner since the factory examined the tuner preset function before shipment. This is not a malfunction. You can preset the stations you want into memory by following the presetting method.

- There is a time limit in doing the following steps. If the setting is canceled before you finish, start from step 1 again.

### On the unit ONLY:

### 1 Tune in the station you want to preset.

- See “Tuning in a Station.”

### 2 Press SET/DISPLAY.



SET/DISPLAY



### 3 Turn PRESET + / – to select a preset number.

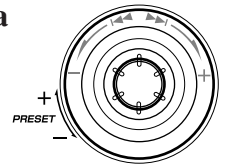

### 4 Press SET/DISPLAY again.



SET/DISPLAY



The tuned station in step 1 is stored in the preset number selected in step 3.

- Storing a new station on a used number erases the previously stored one.



When you unplug the AC power cord or if a power failure occurs

The preset stations will be erased in a few days. If this happens, preset the stations again.

## Tuning in a Preset Station

### 1 Press FM/AM.

The unit automatically turns on and tunes in the previously tuned station (either FM or AM — MW/LW).

- Each time you press the button, the band alternates between FM and AM (MW/LW).



### 2 Select a preset number.

#### On the unit:

Turn PRESET + / –.

#### On the remote control:

Press the number buttons.

Ex.: For preset number 5, press 5.

For preset number 15, press +10, then 5.

For preset number 20, press +10, then 10.

For preset number 25, press +10, +10, then 5.

For preset number 30, press +10, +10, then 10.

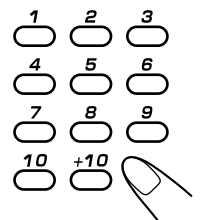
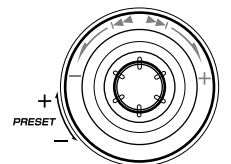



# Receiving FM Stations with RDS

RDS (Radio Data System) allows FM stations to send an additional signal along with their regular program signals. For example, the stations send their station names, as well as information about what type of program they broadcast, such as sports or music, etc.

When tuned to an FM station which provides the RDS service, the RDS indicator lights up on the display.

With the unit, you can receive the following types of RDS signals.

## PS (Program Service):

Shows commonly known station names.

## PTY (Program Type):

Shows types of broadcast programs.

## RT (Radio Text):

Shows text messages the station sends.

## EON (Enhanced Other Networks):

Provides the information about the types of the programs sent by other RDS stations.



### More about RDS

- Some FM stations do not provide RDS signals.
- RDS services vary among FM RDS stations. For details on RDS services in your area, check with local radio stations.
- RDS may not work correctly if the received station is not transmitting the signals properly or if the signal strength is weak.

## Changing the RDS Information

You can see RDS information on the display while listening to an FM station.

### Press DISPLAY MODE.

- Each time you press the button, the display changes to show the following information:

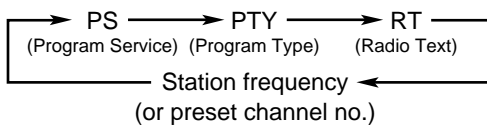
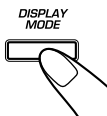

- If no PS, PTY, or RT signals are sent by a station “NO PS,” “NO PTY,” or “NO RT” appears in the main display.
- If the unit takes time to show the RDS information received from a station “WAIT PS,” “WAIT PTY,” or “WAIT RT” may appear on the display.

## Searching for Programs by PTY Codes (PTY Search)

One of the advantages of RDS is that you can locate a particular kind of program by specifying the PTY codes.

- For details on the PTY codes, see “Additional Information” on page 27.

### To search for a program using the PTY codes

REMEMBER you must preset FM RDS stations to use the PTY codes. If not yet done, see page 12.

- There is a time limit in doing the following steps. If the setting is canceled before you finish, start from step 1 again.

### 1 Press PTY/EON until “PTY” and “SELECT” alternately appear on the display.

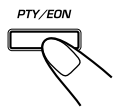

- Each time you press the button, RDS operation mode changes as follows:

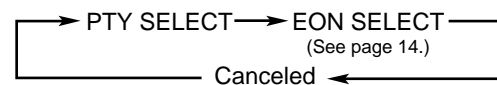

### 2 Press SELECT + or SELECT - until the PTY code you want appears on the display.

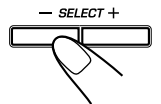

- Each time you press the button, the PTY codes change as follows:

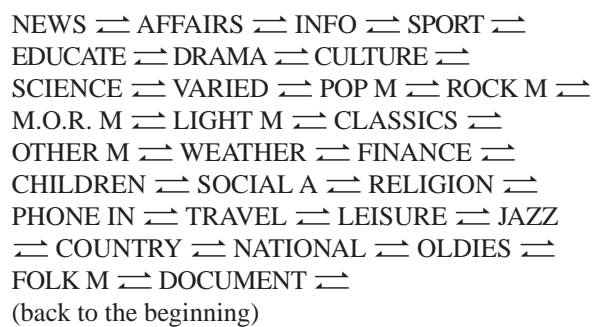

### 3 Press PTY/EON once again.

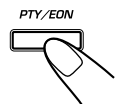

While searching, “SEARCH” and the selected PTY code alternate on the display.

The unit searches 30 preset FM stations, stops when it finds the one you have selected (“FOUND” appears), and tunes in that station.

- If no program is found, “NOT” and “FOUND” appear on the display and the unit returns to the last received station.

### To stop searching any time during the process

Press PTY/EON while searching.

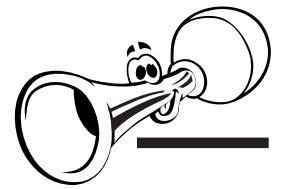

## Switching to a Program Type of Your Choice Temporarily

By receiving EON (Enhanced Other Networks) data sent by FM RDS stations, the EON function allows the unit to switch temporarily to a broadcast program of your choice (TA, NEWS, or INFO) from a different station.

- The EON function only works when you are listening to a preset FM RDS stations providing EON data.
- The EON indicator lights while receiving a station with the EON data.

### To activate the EON function

REMEMBER you must preset FM RDS stations to use the EON function. If not yet done, see page 12.

- There is a time limit in doing the following steps. If the setting is canceled before you finish, start from step 1 again.

### 1 Press **PTY/EON** until “EON” and “SELECT” alternately appear on the display.

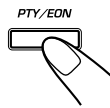

- Each time you press the button, RDS operation mode changes as follows:

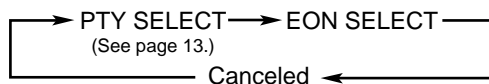

### 2 Press **SELECT +** or **SELECT -** until the EON data type you want appears on the display.

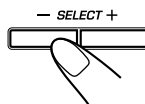

The selected EON data type indicator also flashes.

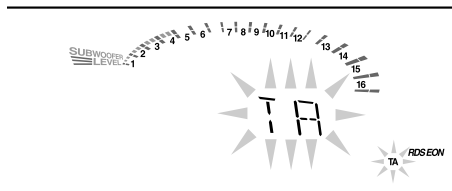

- Each time you press the button, the EON data types change as follows:

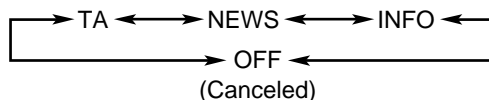

- TA:** Traffic announcement
- NEWS:** News
- INFO:** Program the purpose of which is to impart advice in the widest sense.
- OFF:** The EON function is canceled. The EON data type indicator (TA, NEWS, INFO) goes off.

### 3 Press **PTY/EON** once again.

The EON data type indicator stops flashing and remains lit.

Now, the EON function is activated. See “How the EON function actually works.”

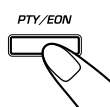

## How the EON function actually works:

### CASE 1

#### If there is no station broadcasting the program you have selected

The unit continues tuning in the current station.



When a station starts broadcasting the program you have selected, the unit automatically switches to the station. The indicator of received PTY code starts flashing.



When the program is over, “EON END” appears on the display, and the unit goes back to the previously tuned station, but the EON function still remains activated.

### CASE 2

#### If there is a station broadcasting the program you have selected

The unit tunes in the program. The indicator of received PTY code starts flashing.



When the program is over, “EON END” appears on the display, and the unit goes back to the previously tuned station, but the EON function still remains activated.

### CASE 3

#### If the FM station you are listening to is broadcasting the program you have selected

The unit continues to receive the station but the indicator of received PTY code starts flashing.



When the program is over, “EON END” appears on the display, and the indicator of received PTY code stops flashing and remains lit, but the EON function still remains activated.



### More about the EON function

- The EON data sent from some stations may not be compatible with this unit. In this case, the EON function may not work correctly.
- While listening to a program tuned in by the EON function, the station does not change even if another network station starts broadcasting a program of the same EON data.
- The EON function is canceled when you change the source to CD, TAPE, or AUX, while it is temporarily canceled when you change the source to AM.

# Playing Back CDs (CD/CD-R/CD-RW)

This unit has been designed to playback the following CDs:

- CD (Audio CD)
- CD-R (CD-Recordable)
- CD-RW (CD-ReWritable)

Continued use of irregular shape CDs (heart-shape, octagonal, etc.) can damage the System.

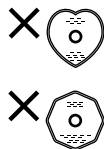

## General Notes

In general, you will have the best performance by keeping your CDs and the mechanism clean.

- Store CDs in their cases, and keep them in cabinets or on shelves.
- Keep the system's disc trays closed when not in use.

## When playing a CD-R or CD-RW

User-edited CD-Rs (CD-Recordable) and CD-RWs (CD-ReWritable) can be played back only if they are already "finalized."

- You can play back your original CD-Rs or CD-RWs recorded in music CD format. (However, they may not be played back depending on their characteristics or recording conditions.)
- Before playing back CD-Rs or CD-RWs, read their instructions or cautions carefully.
- Some CD-Rs or CD-RWs may not be played back on this unit because of their disc characteristics, damage or stain on them, or the player's lens is dirty.
- CD-RWs may require a longer readout time. This is caused by the fact that the reflectance of CD-RWs is lower than for regular CDs.

## Loading CDs

### On the unit ONLY:

**1** Press **▲** for the disc tray (CD1, CD2, and CD3) you want to load a CD onto.

The unit automatically turns on and the disc tray comes out.

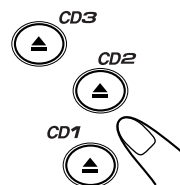

**2** Place a disc correctly on the circle of the disc tray, with its label side up.

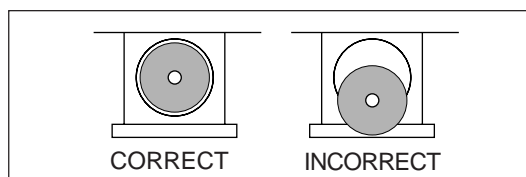

- When using a CD single (8 cm), place it on the inner circle of the disc tray.

**3** Press the same **▲** you have pressed in step 1.

The disc tray closes, and the corresponding disc number lamp and disc indicator light up on the display (CD1, CD2, and CD3).

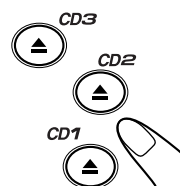

**4** Repeat steps 1 to 3 to place other CDs.



### When loading more than one CD continuously

When you press **▲** for the next tray you want to place another CD onto, the first disc tray automatically closes and then the next tray comes out.



### About the disc indicators

Each disc indicator corresponds to the disc tray of the same number.

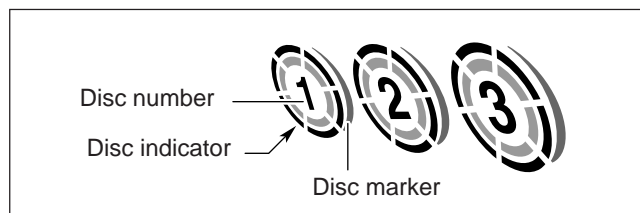

- The disc marker lights up for the disc number you have selected.
- The disc indicator flashes while the corresponding CD is being played.
- The disc indicators goes off when the unit has detected that there is no CD on the corresponding disc tray.

## Playing Back the Entire Discs — Continuous Play

### 1 Load CDs.

### 2 Press one of the disc number buttons (CD1, CD2, and CD3) for the disc you want to play.

CD play starts from the first track of the selected disc and the disc number lamp starts flashing.

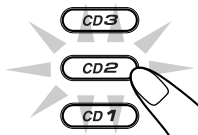

Tracks of the currently playing disc  
(Track numbers exceeding 16 are not displayed.)

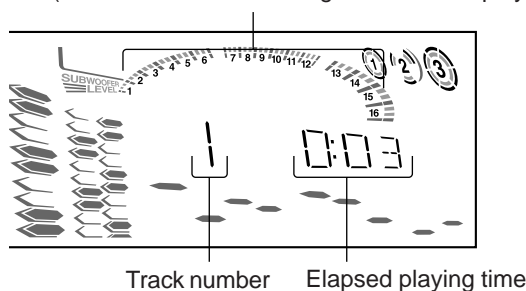

- Pressing CD ►/|| instead of the disc number buttons starts playing back if a CD is on the trays.
- If no CD is placed on the selected disc tray, "NO DISC" appears on the display.

**To stop playing,** press ■.

**To remove the disc,** press ▲ for the corresponding disc tray.



#### CD playback sequence

When 3 CDs\* are loaded on the disc trays, they are played in one of the following sequences.

- When CD1 is pressed: CD1 ⇒ CD2 ⇒ CD3 (then stops)
- When CD2 is pressed: CD2 ⇒ CD3 ⇒ CD1 (then stops)
- When CD3 is pressed: CD3 ⇒ CD1 ⇒ CD2 (then stops)

\* When only 2 CDs are loaded, they are played in the same order, but the disc tray without a CD is skipped.

## Basic CD Operations

While playing a CD, you can do the following operations.

### To exchange CDs during playback of another

Press ▲ corresponding to a CD, not playing or selected currently, to eject and exchange the CD.

If you exchange CDs during play, the current play will not stop until all CDs you have exchanged are played.

### To stop play for a moment

Press CD ►/||.

While pausing, the elapsed playing time flashes on the display.

**To resume playing,** press CD ►/||.



### To go to another track

Turn ◀◀ / ▶▶ before or during playback (or press ◀◀ / ▶▶ on the remote control).

- ◀◀: Goes back to the beginning of the current or previous tracks.
- ▶▶: Skips to the beginning of the next or succeeding tracks.

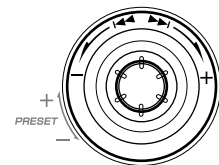

**If you turn ◀◀ / ▶▶ (or press ◀◀ / ▶▶ on the remote control) before playing**

You can change the tracks continuously.

### To locate a particular point in a track

During play, press and hold ◀◀ or ▶▶ (or ◀◀ / ▶▶ on the remote control).

- ◀◀ (or ◀◀): Fast reverses the disc.
- ▶▶ (or ▶▶): Fast forwards the disc.

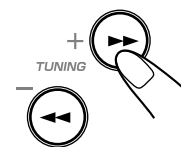

### To go to another track directly using the number buttons

Pressing the number button(s) on the remote control before or during play allows you to start playing the track number you want.

Ex.: For track number 5, press 5.

For track number 15, press +10, then 5.

For track number 20, press +10, then 10.

For track number 32, press +10, +10, +10, then 2.

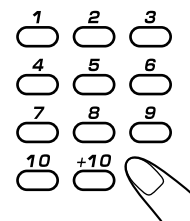

## Programming the Playing Order of the Tracks — Program Play

You can arrange the order in which tracks play before you start playing. **You can program up to 32 tracks.**

- To use Repeat play (see page 18) for Program play, press REPEAT after starting Program play.
- There is a time limit in doing the following steps. If the setting is canceled before you finish, start from step 2 again.

### 1 Load CDs.

- If the current playing source is not the CD player, press CD ►/II, then ■ before going to the next step.

### 2 Press PROGRAM so that “PROGRAM” appears on the display.

The PRGM (program) indicator also lights up on the display.

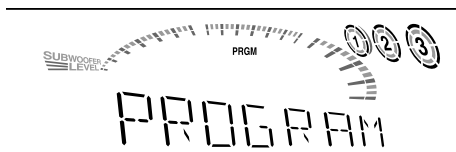

- If a program has been stored in memory, the program is called up.

### 3 Press one of the disc number buttons (CD1, CD2, and CD3) to select the disc number you want to play.

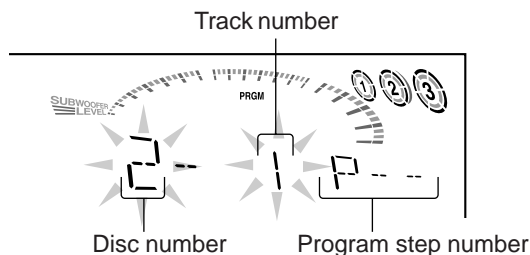

### 4 Select a track from the CD selected in the above step.

#### On the unit:

Turn ◀◀ / ▶▶ to select the track number and press SET/DISPLAY.

#### On the remote control:

Press the number buttons.

- For how to use the number buttons, see “To go to another track directly using the number buttons” on page 16.

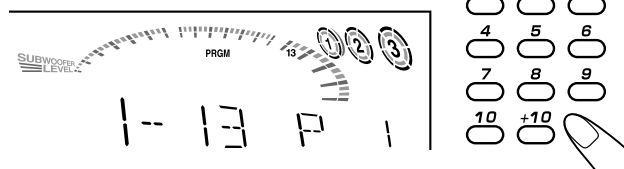

### 5 Program other tracks you want.

- To program tracks from the same disc, repeat step 4.
- To program tracks from a different disc, repeat steps 3 and 4.

### 6 Press CD ►/II.

The tracks are played in the order you have programmed.

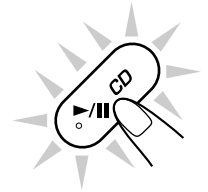

To stop playing, press ■.

To exit from Program play mode, press PROGRAM again before or after play. The PRGM (program) indicator goes off. The program you have made is stored in memory.



- If you try to program a 33rd track

“FULL” will appear on the display.

- If your entry is ignored

You have tried to program a track from an empty tray, or a track number that does not exist on the CD (for example, selecting track 14 on a CD that only has 12 tracks). Such entries are ignored.

- If the total playing time is 100 minutes or more

“-- : --” will appear on the display.

### To check the program contents

Before playing, you can check the program contents by pressing ▶▶I or I◀◀ on the remote control.

- ▶▶I : Shows the programmed tracks in the programmed order.

- I◀◀ : Shows them in the reverse order.

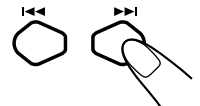

### To modify the program

Before or after playing, you can erase the last programmed tracks by pressing CANCEL/DEMO.

- Each time you press the button, the programmed track shown on the display is erased from the program.
- Ejecting a CD will also erase the track numbers programmed from the ejected CD.



To add tracks in the program before playing, simply select the track numbers you want to add by following step 4 of the programming procedure.

To erase the entire program before or after playing, press ■.

“PROGRAM” appears on the display.

The program you have made will be also erased,

- when you eject all the CDs.
- when you unplug the AC power cord.
- when a power failure occurs.





## Playing at Random — Random Play

The tracks of all loaded CDs will play at random.

- To use Repeat play for Random play, press REPEAT after starting Random play.

### 1 Load CDs.

- If the current playing source is not the CD player, press CD ►/||, then ■ before going to the next step.

### 2 Press RANDOM so that “RANDOM” appears on the display.

The RANDOM indicator also lights up on the display.

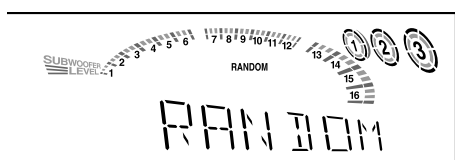

### 3 Press CD ►/||.

The tracks are played at random. Random play ends when all the tracks are played once.

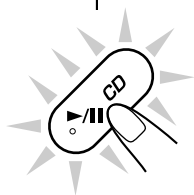

To skip the currently playing track, turn ◀◀ / ▶▶ to the right (or press ▶▶ on the remote control).



Even if you turn ◀◀ / ▶▶ to the left (or press ◀◀ on the remote control)

You cannot go back to the previous tracks during Random play.

To stop playing, press ■.

- Random play also stops when one of the disc trays is opened.

To exit from Random play mode, press RANDOM again before or after play.

## Repeating Tracks or CDs — Repeat Play

You can have all the CDs, the program or the individual track currently playing repeat as many times as you like.

### On the unit ONLY:

To repeat playing, press REPEAT during or before play. To use Repeat play for Program play and Random play, press the button after starting playback.

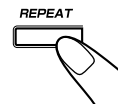

- Each time you press the button, Repeat play mode changes as follows, and the following indicator lights up on the display:

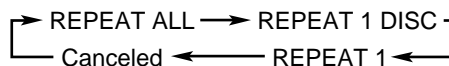

- REPEAT ALL:** Repeats all the tracks on all the CDs (continuously or at random), or all the tracks in the program.
- REPEAT 1 DISC:** Repeats all the tracks on one CD.
- REPEAT 1 DISC is not used for Program play and Random play.
- REPEAT 1:** Repeats one track on one CD.

To cancel Repeat play, press REPEAT repeatedly until the REPEAT indicators go off from the display.

- Repeat play is also canceled when you select Program play or Random play.

## Prohibiting Disc Ejection — Tray Lock

You can prohibit CD ejection from the unit and lock CDs.

- This operation is possible only when the source is the CD player.

### On the unit ONLY:

To prohibit disc ejection, press ▲ for any disc tray while holding down ■. (If there is any disc tray opened, close it first.)

“LOCKED” appears for a while, and the loaded CDs are locked.

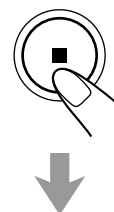

To cancel the prohibition and unlock the CDs, press ▲ for any disc tray while holding down ■.

“UNLOCKED” appears for a while, and the loaded CDs are unlocked.

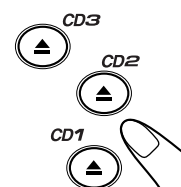

If you try to eject CDs

“LOCKED” appears to inform you that the Tray Lock is in use.

# Playing Back Tapes



You can play back type I, type II, and type IV tapes without changing any settings.

## Playing Back a Tape

- 1** Press EJECT (▲) for the deck you want to use.

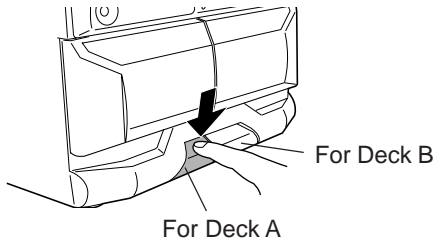

- 2** Put a cassette in with the exposed part of the tape down.

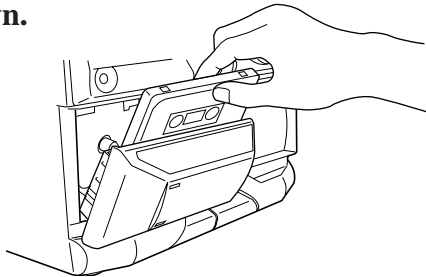

- 3** Close the cassette holder gently.

If you put cassettes in both decks A and B, the last deck you have put a cassette into is selected.

To select the other deck, press TAPE A/B.

- 4** Press TAPE ◀▶.

The tape play starts and the tape direction indicator (▶ or ◀) starts flashing slowly to indicate the tape running direction.

- Each time you press the button, the tape direction changes.
  - ▶ : plays the front side.
  - ◀ : plays the reverse side.
- If no cassette is inserted, “NO TAPE” appears on the display.

When the tape plays to the end, the deck automatically stops if the Reverse Mode is off. (See “To play both sides repeatedly — Reverse Mode.”)



To stop playing, press ■.

To operate the other deck, press TAPE A/B, then TAPE ◀▶.

To fast-wind to the left or to the right, press ◀◀ or ▶▶ (◀◀ or ▶▶ on the remote control) while the tape is not running.

The tape direction indicator (▶ or ◀) starts flashing quickly on the display.

To remove the cassette, press ▲ EJECT for deck A or EJECT ▲ for deck B.

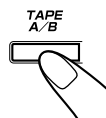

## To play both sides repeatedly — Reverse Mode

Reverse Mode works for both decks at the same time.

When it is in use, the tape automatically reverses at the end of a side and the unit starts playing for the other side of the tape, and repeats the same process.

To use Reverse Mode, press REVERSE MODE so that the Reverse Mode indicator on the display lights up like — (↔).

To cancel Reverse Mode, press the button again so that the Reverse Mode indicator on the display lights up like — ↔.

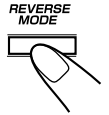

**notes** When Reverse Mode is on with cassettes in both decks A and B

After the reverse (◀) side of the tape finishes playing, the tape in the other deck starts playing.

## Locating the Beginning of a Song — Music Scan

You can use Music Scan to locate the beginning of a song. Music Scan searches for blank portions that usually separate recorded songs, then plays the next song.

### To find the beginning of the current song

During play, press ◀◀ or ▶▶ (◀◀ or ▶▶ on the remote control) in the **opposite direction** to the tape play.

The tape direction indicator of the opposite direction to the tape play starts flashing slowly.

Searching stops automatically at the beginning of the current song, and the current song starts automatically.

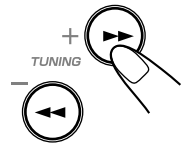

### To find the beginning of the next song

During play, press ◀◀ or ▶▶ (◀◀ or ▶▶ on the remote control) in the **same direction** as the tape play.

The tape direction indicator of the same direction as the tape play starts flashing slowly and quickly alternately.

Searching stops automatically at the beginning of the next song, and the next song starts automatically.

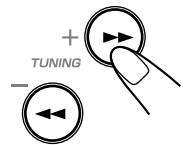

**notes** Music Scan works by detecting a 4-second long blank between each song, so it will not work well in the following cases

- No blank at the beginning of a song.
- Noise (often caused by much use or poor quality dubbing) which fills the blank.
- Long, very soft passages or pauses in a song.



The use of the C-120 or thinner tape is not recommended, since characteristic deterioration may occur and this tape easily jams in the pinch-rollers and the capstans.



## IMPORTANT:

- It should be noted that it may be unlawful to re-record pre-recorded tapes, records, or discs without the consent of the owner of copyright in the sound or video recording, broadcast or cable programme and in any literary, dramatic, musical, or artistic embodied therein.
- The recording level is automatically set correctly, so it is not affected by the VOLUME, the SUBWOOFER LEVEL, and the SOUND MODE controls. Thus, during recording you can adjust the sound you are actually listening to without affecting the recording level.
- If recordings you have made have excessive noise or static, the unit may be too close to a TV. Increase the distance between the TV and the unit.
- You can use type I tape for recording.

## To protect your recording

Cassettes have two small tabs on the back to protect from unexpected erasure or re-recording.

To protect your recording, remove these tabs.

To re-record on a protected tape, cover the holes with adhesive tape.

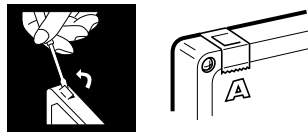

## To keep the best recording and playback sound quality

If the heads, capstans, and pinch rollers of the cassette decks become dirty, the following will occur:

- Impaired sound quality
- Discontinuous sound
- Fading
- Incomplete erasure
- Difficulty in recording

## To clean the heads, capstans, and pinch rollers

Use a cotton swab moistened with alcohol.

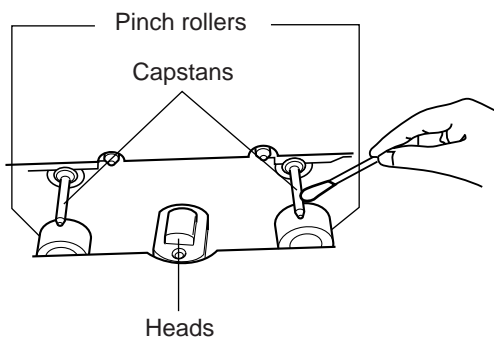

## To demagnetize the heads

Turn off the unit, and use a head demagnetizer (available at electronics and audio shops).

## Recording a Tape on Deck B

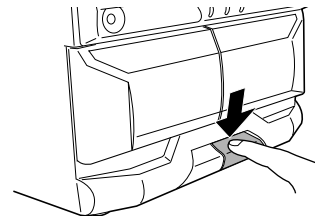

### 1 Press EJECT for the deck B.



### 2 Put a recordable cassette into deck B.

### 3 Close the cassette holder gently.

### 4 Check the tape direction of deck B.

- If the tape direction is not correct, press TAPE   twice then  to change the tape direction.

### 5 Start playing the source — FM, AM (MW/LW), CD player, deck A, or auxiliary equipment connected to AUX jacks.

- When the source is CD, you can also use CD Direct Recording (see page 21) and Auto Edit Recording (see page 22).
- When the source is deck A, you can also use the dubbing method. (See “Dubbing Tapes” on page 21.)

### 6 Start recording.

#### On the unit:

Press REC START/STOP.

#### On the remote control:

Press and hold REC START/STOP for more than 1 second.

The **REC** (recording) indicator lights up on the display and recording starts.

- If no cassette is inserted, “NO TAPE” appears on the display. If a protected tape is inserted, “NO REC” appears on the display.

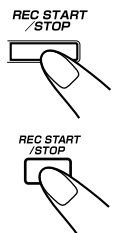

To stop recording immediately, press .

To remove the cassette, press EJECT  for deck B.

### To record on both sides — Reverse Mode

Press REVERSE MODE so that the Reverse Mode indicator lights up like — (↔).



- When using the Reverse Mode for recording, start recording in the forward (▶) direction first. Otherwise, recording will stop when recording is done only on one side (reverse) of the tape.

**To cancel Reverse Mode**, press the button again so that the Reverse Mode indicator lights up like — ↔.

## Dubbing Tapes

You can record from one tape to another.

### On the unit ONLY:

- 1 Press TAPE ◀▶, then ■.

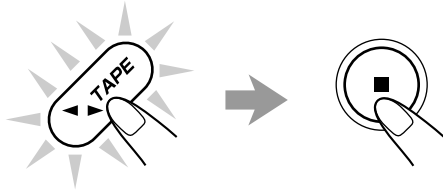

- 2 Put the source cassette in deck A, and a recordable cassette into deck B.

- Put the cassettes in both decks so that the tapes will run in the forward (▶) direction.

- 3 Press DUBBING.

The **REC** (recording) indicator lights up on the display and dubbing starts.



**To stop dubbing**, press ■ so that both decks (A and B) stop.

### To record on both sides — Reverse Mode

Press REVERSE MODE so that the Reverse Mode indicator lights up like — (↔).

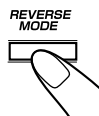

**To cancel Reverse Mode**, press the button again so that the Reverse Mode indicator lights up like — ↔.

## CD Direct Recording

Everything on the CD goes onto the tape in the order it is on the CD, or according to the order you have made for Program play.

### On the unit ONLY:

- 1 Put a recordable cassette into deck B.

- 2 Load CDs.

- 3 Press one of the disc number buttons (CD1, CD2, and CD3) to select the disc, then ■.

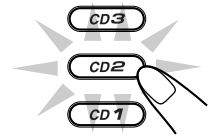

- If you want to make a program, perform steps 2 to 5 on page 17. After making a program, go to the next step.

- 4 Press CD REC START.

“CD REC” appears, and the **REC** (recording) indicator lights up on the display.



Deck B starts recording and the CD player starts playing. When the recording is done, “CD REC FINISHED” appears on the display, and the CD player and deck B stop.

**To stop recording**, press REC START/STOP or ■. So that a 4-second blank portion is created on the recording tape. (Remember a 4-second blank is important when using Music Scan — see page 19.)



### To record on both sides — Reverse Mode

Press REVERSE MODE so that the Reverse Mode indicator lights up like — (↔).

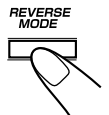

- When using the Reverse Mode for CD Direct Recording, start recording in the forward (▶) direction first. When the tape reaches its end while recording a song in the forward direction (▶), the last song will be re-recorded at the beginning of the reverse side (◀). If you start recording on the reverse side (◀), recording will stop when recording is done only on one side (reverse) of the tape.

**To cancel Reverse Mode**, press the button again so that the Reverse Mode indicator lights up like — ↔.



## Auto Edit Recording

By using Auto Edit Recording, you can record the CD tracks to fit the tape. Auto Edit Recording makes a program by selecting the CD tracks in numerical order. However, to prevent the end of the last track on the front side from being cut off, the last track is selected so as to fit on the remaining tape length.

### On the unit ONLY:

#### 1 Load CDs.

- If the current playing source is not the CD player, press CD ►/■, then ■ before going to the next step.

#### 2 Press EDIT.

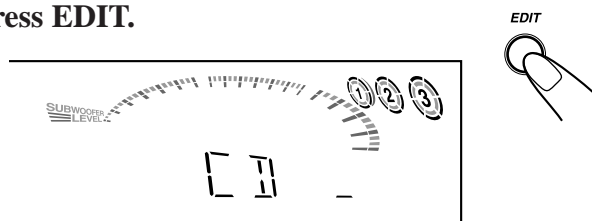

#### 3 Press the disc number button (CD1, CD2, and CD3) for the disc you want to record from.

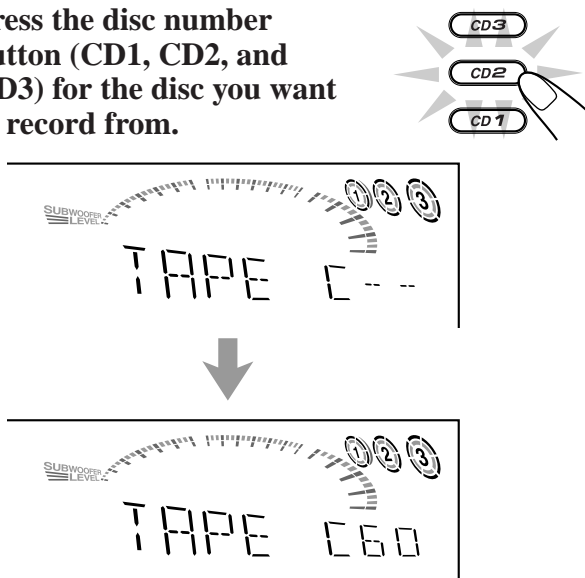

The optimum tape length for the disc appears.

#### To change the tape length manually

If the tape length selected is not satisfactory, you can change the tape length by turning ◀◀ / ▶▶ on the unit. You can select the tape length among the following — 40, 46, 50, 54, 60, 64, 70, 74, 80, 84, and 90.

#### 4 Press SET/DISPLAY.

- Each time you press the button, the tracks to be recorded on the front side (“SIDE-A”) and on the reverse side (“SIDE-B”) alternate.

SET/DISPLAY



Tracks to be recorded on the reverse side (SIDE-B) appear.

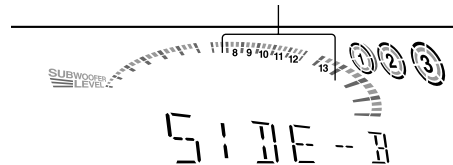

#### 5 Put a recordable cassette of appropriate length into deck B.

#### 6 Press REVERSE MODE so that the Reverse Mode indicator lights up like (↔).

- Without turning on the Reverse Mode (↔), recording will stop when the front side of the tape is recorded.

REVERSE MODE

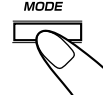

#### 7 Press CD REC START.

“TAPE SIDE-A STAND-BY” appears, and the REC (recording) indicator lights up on the display.

Deck B starts recording then, about 10 seconds later, the CD player starts playing.

When the recording is done, “CD REC FINISHED” appears on the display, and the CD player and deck B stop.

- If a tape has not been rewound, deck B will rewind the tape before it starts recording.
- A 10-second blank portion is automatically created at the beginning of each side of the tape.

CD REC START



#### To stop during Auto Edit Recording

Press REC START/STOP or ■. So that a 4-second blank portion is created on the recording tape. (Remember a 4-second blank is important when using Music Scan — see page 19.)

#### To cancel Auto Edit Recording

Press CANCEL/DEMO or ■ before or after play.

# Using the Timers

There are three timers available — Daily Timer, Recording Timer, and Sleep Timer.

Before using the timers, you need to set the clock built in the unit. (See page 9.)

## Using Daily Timer

With Daily Timer, you can wake to your favorite music or radio program. You can set the timer whether the unit is on or off.

### How Daily Timer actually works

The unit automatically turns on, set the volume level to the preset level, and starts playing the specified source when the on-time comes (the ☀ indicator flashes just before the on-time, and continues flashing while the timer is operating). Then, when the off-time comes (“OFF” flashes just before the off-time), the unit automatically turns off (on standby).

The Daily timer works everyday automatically. If you do not want to use the Daily timer, turn off the Daily timer. (See “To turn on or off Daily Timer after its setting is done” on page 24.) The timer setting remains in memory until you change it.

- There is a time limit in doing the following steps. If the setting is canceled before you finish, start from step 1 again.
- To correct a mis-entry while setting the timer, press CANCEL/DEMO.

#### Before you start...

- *When using a CD as the source to play* —
  - Make sure there is a CD on the selected disc number tray.
- *When using a tape as the source to play* —
  - Make sure that a tape is in the deck whose deck indicator (A or B) is lit on the display.
  - Make sure that the tape direction is correct.
- *When using the external component as the source to play* —
  - Set the timer equipped on the external component at the same time.

### On the unit ONLY:

- 1 Press CLOCK/TIMER repeatedly until “DAILY” appears on the display.**

☀ indicator lights up and DAILY (Daily Timer) indicator also starts flashing on the display.

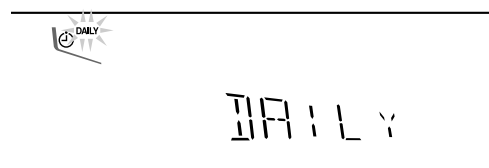

- Each time you press the button, the timer setting modes change as follows:

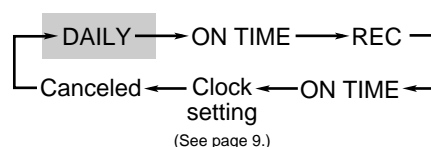

- 2 Press CLOCK/TIMER again.**

“ON TIME” appears for 2 seconds, then the unit enters on-time setting mode.



- 3 Set the on-time you want the unit to turn on at.**

- 1) Turn ◀◀ / ▶▶ to set the hour, then press SET/DISPLAY.
- 2) Turn ◀◀ / ▶▶ to set the minute, then press SET/DISPLAY. “OFF TIME” appears for 2 seconds on the display, then the unit enters off-time setting mode.

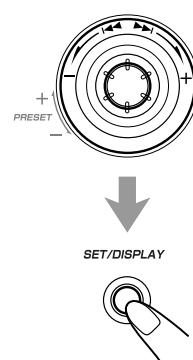

- 4 Set the off-time you want the unit to turn off (on standby) at.**

- 1) Turn ◀◀ / ▶▶ to set the hour, then press SET/DISPLAY.
- 2) Turn ◀◀ / ▶▶ to set the minute, then press SET/DISPLAY. The unit enters source selecting mode.

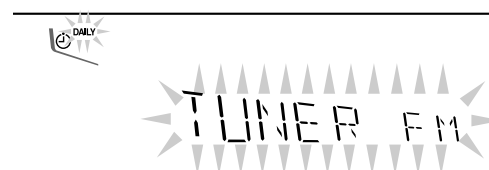

## 5 Turn to select the source to play, then press SET/DISPLAY.

- The source changes as follows:

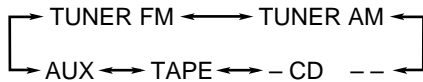

TUNER FM: tunes into a specified preset FM station.

→ Go to step 6.

TUNER AM: tunes into a specified preset

AM (MW/LW) station. → Go to step 6.



- CD --: plays a disc from a specified track of a specified disc. → Go to step 6.

TAPE: plays a tape in deck A or B.

→ Go to step 7.



AUX: plays an external source. → Go to step 7.



## 6 When selecting “TUNER FM” or “TUNER AM”

Turn   to select the preset station number, then press SET/DISPLAY.

The unit enters volume setting mode.

### When selecting “- CD --”

1) Turn   to select the disc number, then press SET/DISPLAY.

2) Turn   to set the track number, then press SET/DISPLAY.

The unit enters volume setting mode.

## 7 Turn to set the volume level.

- The volume level changes as follows:

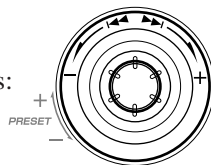
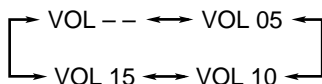

- If you select “VOL --,” the volume is set to the last level when the unit has been turned off.

## 8 Press SET/DISPLAY to complete the Daily Timer setting.

The DAILY (Daily Timer) indicator stops flashing and remains lit. The settings you have done are shown on the display in sequence.

SET/DISPLAY



## 9 Press STANDBY/ON to turn off the unit (on standby) if you have set the Daily Timer with the unit turned on.

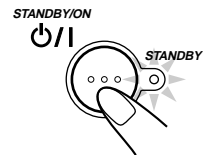

- If the unit is turned on when the on-time comes Daily Timer does not work.
- Even if you unplug the AC power cord or if a power failure occurs

Once you set the timer, the timer setting may remain stored in memory in a few days. In this case, check whether the timer setting still remains or not.

### To turn on or off Daily Timer after its setting is done

1 Press CLOCK/TIMER repeatedly until “DAILY” appears on the display.



2 To turn off the Daily Timer, press CANCEL/DEMO.

 indicator and the DAILY (Daily Timer) indicator go off from the display (“OFF” appears for a while).

The Daily Timer is canceled, but the setting for the Daily Timer remains in memory.



To turn on the Daily Timer, press SET/DISPLAY.

 indicator and the DAILY (Daily Timer) indicator light up on the display. The settings you have done are shown on the display in sequence for your confirmation.



## Using Recording Timer

With Recording Timer, you can make a tape of a radio broadcast automatically. You can set the timer whether the system is on or off.

### How Recording Timer actually works

The unit automatically turns on, tunes into the specified station, sets the volume level to "VOL MIN," and starts recording when the on-time comes (the ☺ indicator flashes just before the on-time, and continues flashing while the timer is operating). Then, when the off-time comes ("OFF" appears just before the off-time), the unit automatically turns off (on standby).

The timer setting remains in memory until you change it.

- There is a time limit in doing the following steps. If the setting is canceled before you finish, start from step 1 again.
- To correct a mis-entry while setting the timer, press CANCEL/DEMO.

### On the unit ONLY:

#### 1 Put a recordable cassette into deck B.

#### 2 Press CLOCK/TIMER repeatedly until "REC" appears on the display.

The REC (Recording Timer) indicator also starts flashing on the display.

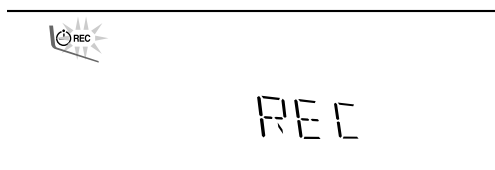

- Each time you press the button, the timer setting modes change as follows:

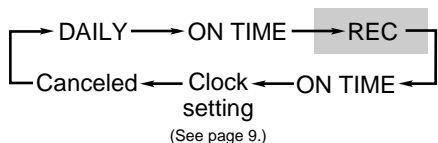

#### 3 Press CLOCK/TIMER again.

"ON TIME" appears for 2 seconds, then the unit enters on-time setting mode.



#### 4 Set the on-time you want the unit to turn on at.

- 1) Turn ◀◀ / ▶▶ to set the hour, then press SET/DISPLAY.
- 2) Turn ◀◀ / ▶▶ to set the minute, then press SET/DISPLAY. "OFF TIME" appears for 2 seconds, then the unit enters off-time setting mode.

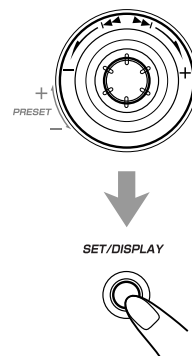

#### 5 Set the off-time you want the unit to turn off (on standby) at.

- 1) Turn ◀◀ / ▶▶ to set the hour, then press SET/DISPLAY.
- 2) Turn ◀◀ / ▶▶ to set the minute, then press SET/DISPLAY. The unit enters preset station selecting mode.

#### 6 Select the preset station.

- 1) Turn ◀◀ / ▶▶ to select the band ("TUNER FM" or "TUNER AM"), then press SET/DISPLAY.
- 2) Turn ◀◀ / ▶▶ to select a preset channel number, then press SET/DISPLAY. The REC (Recording Timer) indicator stops flashing and remains lit. The settings you have done are shown on the display in sequence.

#### 7 Press STANDBY/ON ⏻/⏻ to turn off the unit (on standby) if necessary.

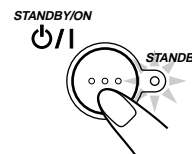

- **If you want to listen to another source while recording**  
Press REC START/STOP or ■ to stop recording. Without stopping it, you cannot change the source.
- **Even if you unplug the AC power cord or if a power failure occurs**

Once you set the timer, the timer setting may remain stored in memory in a few days. In this case, check whether the timer setting still remains or not.





## To turn on or off Recording Timer after its setting is done

1 Press **CLOCK/TIMER** repeatedly until “REC” appears on the display.



2 To turn off the Recording Timer, press **CANCEL/DEMO**.

The REC (Recording Timer) indicator goes off from the display.

The Recording Timer is canceled, but the setting for the Recording Timer remains in memory.



To turn on the Recording Timer, press **SET/DISPLAY**.

The REC (Recording Timer) indicator lights up on the display. The settings you have done are shown on the display in sequence for your confirmation.



## Using Sleep Timer

With Sleep Timer, you can fall asleep to music. You can set Sleep Timer only while the unit is turned on.

### How Sleep Timer actually works

The unit automatically turns off after the specified time length passes.

### On the remote control ONLY:

1 Press **SLEEP**.

The time length until the shut-off time appears and the SLEEP indicator starts flashing on the display.

- Each time you press the button, the time length changes as follows:

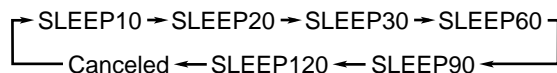

2 Wait for about 5 seconds after specifying the time length.

The SLEEP indicator stops flashing and remains lit.

To check the remaining time until the shut-off time, press SLEEP once so that the remaining time until the shut-off time appears for about 5 seconds.

To change the shut-off time, press SLEEP repeatedly until the desired time length appears on the display.

To cancel the setting, press SLEEP repeatedly so that the SLEEP indicator goes off.

- Sleep Timer is also canceled when you turn off the unit.

## Timer Priority

Since each timer can be set separately, you may wonder what happens if the setting for these timers overlaps. Here are examples.

### Recording Timer has priority over Daily Timer and Sleep Timer.

- If Daily Timer is set to come on while Recording Timer is operating, Daily Timer will not come on at all.

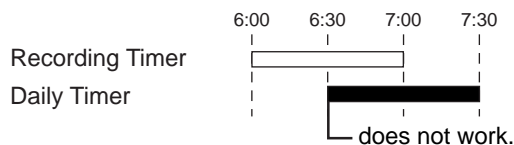

- If Recording Timer is set to come on while Sleep Timer is operating, Sleep Timer will not work (the SLEEP indicator does not go off).

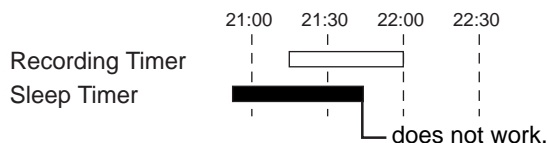



# Additional Information



## Description of the PTY codes:

<b>NEWS:</b>	News.
<b>AFFAIRS:</b>	Topical program expanding or enlarging upon the news — debate, or analysis.
<b>INFO:</b>	Program the purpose of which is to impart advice in the widest sense.
<b>SPORT:</b>	Program concerned with any aspect of sports.
<b>EDUCATE:</b>	Educational programs.
<b>DRAMA:</b>	All radio plays and serials.
<b>CULTURE:</b>	Programs concerning any aspect of national or regional culture, including language, theatre, etc.
<b>SCIENCE:</b>	Programs about natural sciences and technology.
<b>VARIED:</b>	Used for mainly speech-based programs like quizzes, panel games and personality interviews.
<b>POP M:</b>	Commercial music of current popular appeal.
<b>ROCK M:</b>	Rock music.
<b>M.O.R. M:</b>	Current contemporary music considered to be “easy-listening.”
<b>LIGHT M:</b>	Instrumental music, and vocal or choral works.
<b>CLASSICS:</b>	Performances of major orchestral works, symphonies, chamber music, etc.
<b>OTHER M:</b>	Music not fitting into any of the other categories.
<b>WEATHER:</b>	Weather reports and forecasts.

<b>FINANCE:</b>	Stock Market reports, commerce, trading etc.
<b>CHILDREN:</b>	Programs targeted at a young audience.
<b>SOCIAL A:</b>	Programs about sociology, history, geography, psychology and society.
<b>RELIGION:</b>	Religious programs.
<b>PHONE IN:</b>	Involving members of the public expressing their views either by phone or at a public forum.
<b>TRAVEL:</b>	Travel information.
<b>LEISURE:</b>	Programs about recreational activities.
<b>JAZZ:</b>	Jazz music.
<b>COUNTRY:</b>	Songs which originate from, or continue the musical tradition of the American Southern States.
<b>NATIONAL:</b>	Current popular music of the nation or region in that country’s language.
<b>OLDIES:</b>	Music from the so-called “golden age” of popular music.
<b>FOLK M:</b>	Music which has its roots in the musical culture of a particular nation.
<b>DOCUMENT:</b>	Program concerning factual matters, presented in an investigative style.

**Classification of the PTY codes for some FM stations may be different from the above list.**

# Troubleshooting



If you are having a problem with your unit, check this list for a possible solution before calling for service. If you cannot solve the problem from the hints given here, or the unit has been physically damaged, call a qualified person, such as your dealer, for service.

Symptom	Cause	Action
Unable to cancel the display demonstration.	Other buttons will pressed to cancel the display demonstration.	Press CANCEL/DEMO on the unit. (See page 8.)
No sound is heard.	Connections are incorrect or loose.	Check all connections and make corrections. (See pages 6 to 8.)
Hard to listen to broadcasts because of noise.	<ul style="list-style-type: none"> <li>Antennas are disconnected.</li> <li>The AM (MW/LW) loop antenna is too close to the unit.</li> <li>The FM antenna is not properly extended and positioned.</li> </ul>	<ul style="list-style-type: none"> <li>Reconnect the antennas correctly and securely.</li> <li>Change the position and direction of the AM (MW/LW) loop antenna.</li> <li>Extend the FM antenna at the best position.</li> </ul>
The disc sound is discontinuous.	The disc is scratched or dirty.	Clean or replace the disc. (See page 29.)
The disc tray does not open or close.	<ul style="list-style-type: none"> <li>The AC power cord is not plugged in.</li> <li>Trays are locked.</li> </ul>	<ul style="list-style-type: none"> <li>Plug the AC power cord.</li> <li>Unlock the trays. (See page 18.)</li> </ul>
The disc does not play.	The disc is placed upside down.	Place the disc with the label side up.
The cassette holders cannot be opened.	Power supply from the AC power cord has been cut off while the tape was running.	Turn on the unit.
Impossible to record.	Small tabs on the back of the cassette are removed.	Cover the holes with adhesive tape.
Operations are disabled.	The built-in microprocessor may malfunction due to external electrical interference.	Unplug the AC power cord and then plug it back in.
Unable to operate the unit from the remote control.	<ul style="list-style-type: none"> <li>The path between the remote control and the remote sensor on the unit is blocked.</li> <li>The batteries are exhausted.</li> </ul>	<ul style="list-style-type: none"> <li>Remove the obstruction.</li> <li>Replace the batteries.</li> </ul>

# Maintenance



To get the best performance of the unit, keep your discs, tapes, and mechanism clean.

## Handling discs



- Remove the disc from its case by holding it at the edge while pressing the center hole lightly.
- Do not touch the shiny surface of the disc, or bend the disc.
- Put the disc back in its case after use to prevent warping.

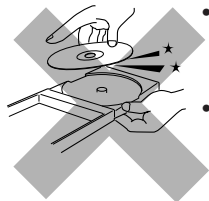

- Be careful not to scratch the surface of the disc when placing it back in its case.
- Avoid exposure to direct sunlight, temperature extremes, and moisture.

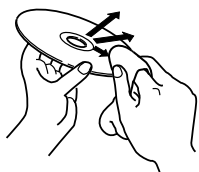

### To clean the disc

Wipe the disc with a soft cloth in a straight line from center to edge.



DO NOT use any solvent — such as conventional record cleaner, spray, thinner, or benzine — to clean the disc.

## Handling cassette tapes

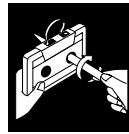

- If the tape is loose in its cassette, take up the slack by inserting a pencil in one of the reels and rotating.
- If the tape is loose, it may get stretched, cut, or caught in the cassette.

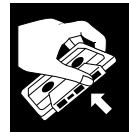

- Be careful not to touch the tape surface.



- Avoid the following places to store the tape:
  - In dusty places
  - In direct sunlight or heat
  - In moist areas
  - Near a magnet

## Cleaning the unit

### • Stains on the unit

Should be wiped off with a soft cloth. If the unit is heavily stained, wipe it with a cloth soaked in water diluted neutral detergent and wrung well, then wipe clean with a dry cloth.

### • Since the unit may deteriorate in quality, become damaged or get its paint peeled off, be careful about the followings.

- DO NOT wipe it with a hard cloth.
- DO NOT wipe it strong.
- DO NOT wipe it with thinner or benzine.
- DO NOT apply any volatile substance such as insecticides to it.
- DO NOT allow any rubber or plastic to remain in contact with it for a long time.

# Specifications

Design and specifications are subject to change without notice.

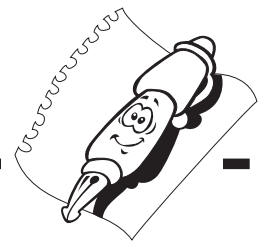

## CA-MXGT91R

### Amplifier section

Output Power (IEC 268-3/DIN)

SUBWOOFERS: 86 W per channel, min. RMS, both channels driven into 6  $\Omega$  at 63 Hz with no more than 0.9% total harmonic distortion.

MAIN SPEAKERS: 21 W per channel, min. RMS, both channels driven into 6  $\Omega$  at 1 kHz with no more than 0.9% total harmonic distortion.

Audio input sensitivity/Impedance

(Measured at 1 kHz, with tape recording signal 300 mV)

AUX: 390 mV/50 k $\Omega$

Digital output: CD OPTICAL DIGITAL OUTPUT

Signal wave length: 660 nm

Output level: -15 dBm to -12 dBm

Speakers/Impedance:

SUBWOOFERS: 6  $\Omega$  - 16  $\Omega$

MAIN SPEAKERS: 6  $\Omega$  - 16  $\Omega$

### Tuner

FM tuning range: 87.50 MHz - 108.00 MHz

AM tuning range: MW: 522 kHz - 1 629 kHz

LW: 144 kHz - 288 kHz

### CD player

CD capacity: 3 CDs

Dynamic range: 85 dB

Signal-to-noise ratio: 90 dB

Wow and flutter: Immeasurable

### Cassette deck

Frequency response

Normal (type I): 50 Hz - 14 000 Hz

Wow and flutter

0.15% (WRMS)

### General

Power requirement: AC 230 V  $\sim$ , 50 Hz

Power consumption:

160 W (at operation)

20 W (on standby; with power saving off — Normal Mode)

1.1 W (on standby; with power saving on — Ecology Mode)

Dimensions (approx.): 265 mm x 335 mm x 401 mm (W/H/D)

(10<sup>7</sup>/<sub>16</sub> in. x 13<sup>1</sup>/<sub>4</sub> in. x 15<sup>13</sup>/<sub>16</sub> in.)

Mass (approx.): 10.0 kg (22.1 lbs)

### Supplied accessories

See page 6.

## CA-MXG71R

### Amplifier section

Output Power (IEC 268-3/DIN)

SUBWOOFERS: 80 W per channel, min. RMS, both channels driven into 6  $\Omega$  at 63 Hz with no more than 0.9% total harmonic distortion.

MAIN SPEAKERS: 21 W per channel, min. RMS, both channels driven into 6  $\Omega$  at 1 kHz with no more than 0.9% total harmonic distortion.

Audio input sensitivity/Impedance

(Measured at 1 kHz, with tape recording signal 300 mV)

AUX: 390 mV/50 k $\Omega$

Digital output: CD OPTICAL DIGITAL OUTPUT

Signal wave length: 660 nm

Output level: -15 dBm to -12 dBm

Speakers/Impedance:

SUBWOOFERS: 6  $\Omega$  - 16  $\Omega$

MAIN SPEAKERS: 6  $\Omega$  - 16  $\Omega$

### Tuner

FM tuning range: 87.50 MHz - 108.00 MHz

AM tuning range: MW: 522 kHz - 1 629 kHz

LW: 144 kHz - 288 kHz

### CD player

CD capacity: 3 CDs

Dynamic range: 85 dB

Signal-to-noise ratio: 90 dB

Wow and flutter: Immeasurable

### Cassette deck

Frequency response

Normal (type I): 50 Hz - 14 000 Hz

Wow and flutter

0.15% (WRMS)

### General

Power requirement: AC 230 V  $\sim$ , 50 Hz

Power consumption:

140 W (at operation)

20 W (on standby; with power saving off — Normal Mode)

1.1 W (on standby; with power saving on — Ecology Mode)

Dimensions (approx.): 265 mm x 335 mm x 401 mm (W/H/D)

(10<sup>7</sup>/<sub>16</sub> in. x 13<sup>1</sup>/<sub>4</sub> in. x 15<sup>13</sup>/<sub>16</sub> in.)

Mass (approx.): 10.0 kg (22.1 lbs)

### Supplied accessories

See page 6.







# NOTICE/ BEMERKUNG/ AVIS/ OPMERKING/ NOTIS/ HUOMIO/ BEMÆRKE/ AVISO/ AVVISO

## English

### Note on Recording an RDS FM Station

If you start recording an FM station while its RDS information is shown on the display, the RDS information will be changed and its station frequency, "NO PS," "NO PTY" or "NO RT" will appear on the display. When you finish recording, RDS information will appear again.

## Deutsch

### Hinweis zur Aufnahme von einem RDS-FM-Sender

Wenn Sie die Aufnahme des Programms eines FM-Senders starten, während die RDS-Information im Display angezeigt wird, ändert sich die Display-Anzeige, und es erscheint die Senderfrequenz, "NO PS", "NO PTY" oder "NO RT". Nach Abschluß der Aufnahme erscheint wieder die RDS-Information.

## Français

### Remarques pour l'enregistrement d'une station FM RDS

Si vous commencez l'enregistrement d'une station FM pendant l'affichage des informations RDS, ces informations disparaissent et sont remplacées par la fréquence de la station ou les mentions "NO PS", "NO PTY" ou "NO RT". A la fin de l'enregistrement, les informations RDS s'affichent à nouveau.

## Nederlands

### Opmerking bij Opnemen van een RDS FM Station

Wanneer u een FM station begint op te nemen terwijl de RDS informatie ervan op het display wordt getoond, zal de RDS informatie worden veranderd en zal de frequentie van het bijbehorende station, "NO PS", "NO PTY" of "NO RT" op het display verschijnen. Wanneer u klaar bent met opnemen verschijnt RDS informatie weer op het display.

## Svenska

### Anmärkning angående inspelning av RDS FM-stationer

Om en FM-station börjar spelas in när RDS-information visas på displayen, kommer RDS-informationen att ändras och dess stationsfrekvens, "NO PS", "NO PTY" eller "NO RT" visas på displayen. När inspelningen avslutats, visas RDS-informationen igen.

## Suomi

### Registrering af en FM station med RDS

Hvis man starter registrering af en FM-station mens RDS-informationen vises på display'et, ændres RDS-informationen og frekvensen, "NO PS", "NO PTY" eller "NO RT" vises på display'et. Når registreringen afsluttes, vises RDS-informationen igen.

## Dansk

### Huomautus nauhoittaessasi RDS-FM-aseman lähetystä

Jos ryhdyt nauhoittamaan FM-radioaseman lähetystä, kun RDS-tiedotuksia on näytössä, RDS-tietojen näyttö peruuntuu ja sen taajuus, "NO PS", "NO PTY" tai "NO RT" ilmestyy näyttöön. Kun nauhoitus päättyy, RDS-tiedotukset palaavat näyttöön uudelleen.

## Español

### Nota: cuando grabe de una emisora FM con RDS

Si inicia la grabación de una emisora FM mientras aparece en pantalla la información RDS, ésta cambiará y se mostrará la frecuencia, "NO PS", "NO PTY" o "NO RT". La información RDS volverá a aparecer en pantalla cuando finalice la grabación.

## Italiano

### Nota relativa alla registrazione di una stazione FM RDS

Se si comincia a registrare una stazione FM mentre l'informazione RDS è visualizzata sul display, tale informazione cambierà. Il display visualizzerà allora la frequenza della stazione, "NO PS", "NO PTY" o "NO RT". Una volta terminata la registrazione, l'informazione RDS sarà di nuovo visualizzata sul display.

GV40234-001A

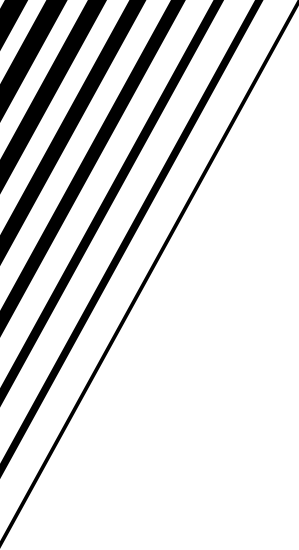

**JVC**

VICTOR COMPANY OF JAPAN, LIMITED

# JVC INSTRUCTIONS

## SPEAKER SYSTEM

### SP-MXGT91R

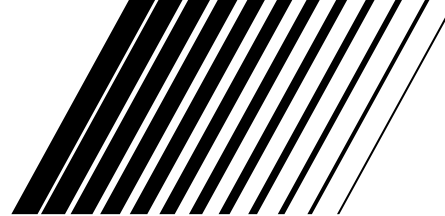

**BEDIENUNGSANLEITUNG: LAUTSPRECHERSYSTEM**  
**MANUEL D'INSTRUCTIONS: SYSTEME DES ENCEINTES**  
**GEBRUIKSAANWIJZING: LUIDSPREKERSYSTEEM**  
**MANUAL DE INSTRUCCIONES: SISTEMA DE ALTAVOCES**  
**ISTRUZIONI: SISTEMA DI ALTOPARLANTI**  
**BRUKSANVISNING: HÖGTALARSYSTEM**  
**VEJLEDNING: HØJTTALERSYSTEM**  
**KÄYTTÖOHJE: KAIUTINJÄRJESTELMÄ**

Thank you for purchasing JVC speakers.  
Before you begin using them, please read the instructions carefully to be sure you get the best possible performance. If you have any questions, consult your JVC dealer.

Vielen Dank für den Kauf dieser JVC-Lautsprecher.  
Lesen Sie bitte diese Bedienungsanleitung vor Ingebrauchnahme sorgfältig durch, um stets optimale Ergebnisse zu erzielen. Wenden Sie sich bei etwaigen Fragen bitte an Ihren JVC Händler.

Nous vous remercions pour l'achat de ces enceintes JVC.  
Avant de les utiliser, lire ces instructions avec attention pour en obtenir les meilleures performances possibles. En cas de questions, consultez votre revendeur JVC.

Dank u voor de aanschaf van deze luidsprekers.  
Lees alvorens over te gaan tot aansluiten, deze gebruiksaanwijzing door zodat u de best mogelijke prestaties zult verkrijgen. Neem contact op met de JVC dealer indien u vragen heeft.

Le estamos muy agradecidos por haber adquirido estos altavoces de JVC.  
Antes de utilizarlos, sírvase leer las instrucciones detenidamente a fin de obtener el mejor rendimiento posible. Si tienen alguna pregunta, acuda a su agente de JVC.

Grazie per aver acquistato questi altoparlanti della JVC.  
Prima di cominciare l'uso degli altoparlanti, leggete attentamente le istruzioni per assicurare le migliori prestazioni. Qualora sorgessero dei dubbi, rivolgetevi al vostro rivenditore JVC.

Tack för ditt val av dessa JVC-högtalare.  
Innan du kopplar in högtalarna i din ljudanläggning bör du för att få maximala prestanda från högtalarna läsa igenom bruksanvisningen noggrant. Kontakta din JVC-återförsäljare om du har frågor eller känner dig osäker.

Tak for købet af JVC-højttalerne.  
Gennemlæs venligst vejledningen omhyggeligt før de tages i brug, så De kan opnå den bedst mulige ydelse. Forhør hos Deres JVC forhandler hvis De har nogen spørgsmål.

Kiitos siitä että päädyit valinnassasi JVC-kaiuttimiin.  
Ennen kuin alat käyttää niitä, lue käyttöohje huolellisesti, jotta ne toimisivat parhaalla mahdollisella tavalla. Jos Sinulla on kysyttävää ota yhteys JVC-edustajaan.

#### — SAFETY INSTRUCTIONS — “SOME DOS AND DON'TS ON THE SAFE USE OF EQUIPMENT”

This equipment has been designed and manufactured to meet international safety standards but, like any electrical equipment, care must be taken if you are to obtain the best results and safety is to be assured.

Do read the operating instructions before you attempt to use the equipment.

Do ensure that all electrical connections (including the mains plug, extension leads and interconnections between pieces of equipment) are properly made and in accordance with the manufacturer's instructions. Switch off and withdraw the mains plug when making or changing connections.

Do consult your dealer if you are ever in doubt about the installation, operation or safety of your equipment.

Do be careful with glass panels or doors on equipment.

DON'T continue to operate the equipment if you are in any doubt about it working normally, or if it is damaged in any way — switch off, withdraw the mains plug and consult your dealer.

DON'T remove any fixed cover as this may expose dangerous voltages.

DON'T leave equipment switched on when it is unattended unless it is specifically stated that it is designed for unattended operation or has a standby mode.

Switch off using the switch on the equipment and make sure that your family know how to do this.

Special arrangements may need to be made for infirm or handicapped people.

DON'T use equipment such as personal stereos or radios so that you are distracted from the requirements of traffic safety. It is illegal to watch television whilst driving.

DON'T listen to headphones at high volume as such use can permanently damage your hearing.

DON'T obstruct the ventilation of the equipment, for example with curtains or soft furnishing.

Overheating will cause damage and shorten the life of the equipment.

DON'T use makeshift stands and NEVER fix legs with wood screws — to ensure complete safety always fit the manufacturer's approved stand or legs with the fixings provided according to the instructions.

DON'T allow electrical equipment to be exposed to rain or moisture.

ABOVE ALL

- NEVER let anyone, especially children, push anything into holes, slots or any other opening in the case.
- this could result in a fatal electrical shock;
- NEVER guess or take chances with electrical equipment of any kind
- it is better to be safe than sorry!

**Connection**  
**Anschluß**  
**Raccordement**  
**Aansluiting**  
**Conexión**  
**Collegamento**  
**Ansluiting**  
**Tilslutning**  
**Liitântä**

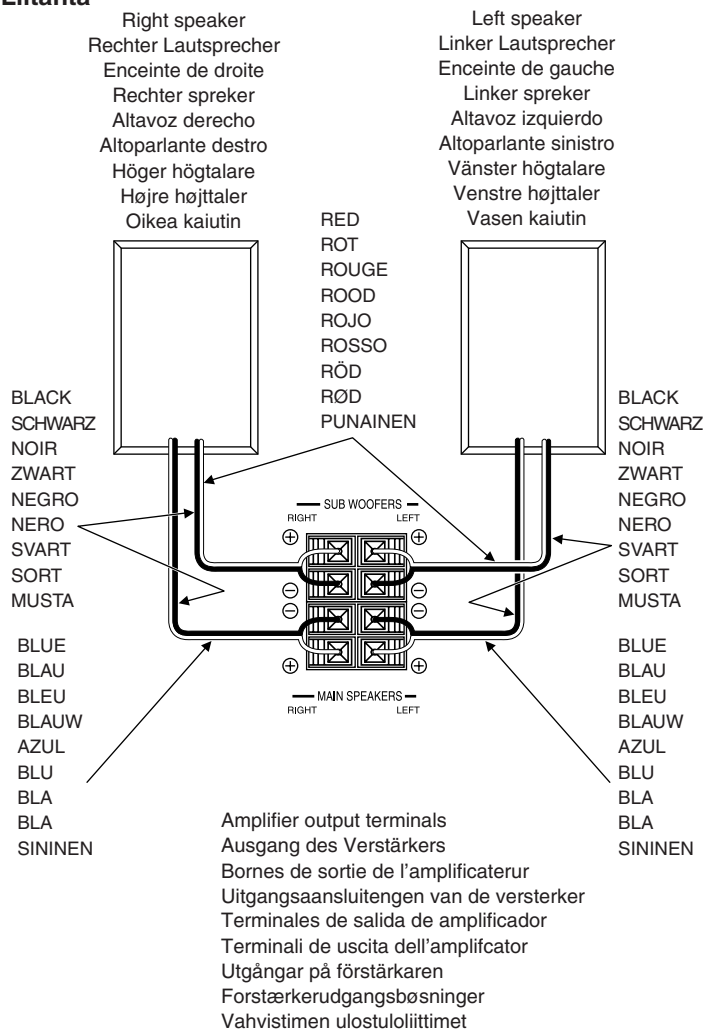

**CONNECTION**

- DON'T use other amplifier to operate this speaker system except for CA-MXGT91R.
- Turn off power to the whole system before connecting the speakers to the amplifier.
- The maximum power handling capacity of the SP-MXGT91R main speaker is 55 W/Subwoofer is 130 W. Excessive input will result in abnormal noise and possible damage. In cases where the signals described below are applied to the speakers, even if the signals are below the maximum allowable input, they may cause an overload and burn the wiring of the speakers. Be sure to lower the amplifier volume beforehand.
  - 1) Noise during FM tuning.
  - 2) High level signals containing high frequency components produced by a tape deck in the fast forward mode.
  - 3) Click noise produced when turning power of other components on and off.
  - 4) Click noise produced when connecting or disconnecting cords with the power on.
  - 5) Click noise produced when the cartridge is replaced with the power on.
  - 6) Click noise produced when operating amplifier switches.
  - 7) Continuous high frequency oscillation or high pitch electronically produced musical instrument sound.
  - 8) Howling when using a microphones.

**SPECIFICATIONS**

Type	: 3-way 3-speaker Bass-Reflex Type Dual Giga-Tube Band-Pass Subwoofers
Speakers	
Subwoofer	: 16.0 cm (6-5/16 in.) cone × 1
Main woofer	: 10.0 cm (3-15/16 in.) cone × 1
Tweeter	: 5 cm (2 in.) cone × 1
Power Handling Capacity	
Subwoofer	: 130 W
Main Speaker	: 55 W
Impedance	
Subwoofer	: 6 Ω
Main Speaker	: 6 Ω
Frequency Range	
Subwoofer	: 30 Hz ~ 120 Hz
Main Speaker	: 75 Hz ~ 29 000 Hz
Sound Pressure Level	
Subwoofer	: 78 dB/W·m (Average of 50 Hz ~ 100 Hz)
Main Speaker	: 85 dB/W·m (Average of 400 Hz ~ 800 Hz)
Dimensions (W × H × D)	: 230 mm × 439 mm × 340 mm (9-1/16 in. × 17-5/16 in. × 13-7/16 in.)
Mass	: 7.2 kg (15.9 lbs) each

*Design and specifications subject to change without notice.*

## ANSCHLUSS

- Verwenden Sie zum Betrieb dieses Lautsprechersystems keinen anderen Verstärker, ausgenommen CA-MXGT91R.
- Schalten Sie vor dem Anschluß der Lautsprecher an den Verstärker die Spannungsversorgung des gesamten Systems aus.
- Die maximale Belastbarkeit des SP-MXGT91R-Hauptlautsprechers ist 55 W und die des Subwoofers ist 130 W. Eine Überlastung führt zu Verzerrungen und möglicherweise zu Beschädigungen. Signale der unten beschriebenen Art können, auch wenn sie unter dem maximal zulässigen Eingang liegen, eine Überlastung verursachen und die Lautsprecherwicklungen durchbrennen. Verringern Sie vorher die Lautstärke des Verstärkers.
  - 1) Geräusche beim Einstellen von UKW-Sendern.
  - 2) Hochpegelige Signale mit Hochfrequenz-Anteilen, die von Tonbanddecks beim Schnellvorspulen erzeugt werden.
  - 3) Klickgeräusche, wenn die Spannungsversorgung anderer Komponenten ein- und ausgeschaltet wird.
  - 4) Klickgeräusche, wenn Kabel angeschlossen oder abgetrennt werden, während die Spannungsversorgung eingeschaltet ist.
  - 5) Klickgeräusche, wenn der Tonabnehmer des Plattenspielers ausgewechselt wird, während die Spannungsversorgung eingeschaltet ist.
  - 6) Klickgeräusche, die beim Betätigen von Schaltern des Verstärkers erzeugt werden.
  - 7) Ständige Hochfrequenzschwingungen oder elektronisch erzeugte Töne von Musikinstrumenten mit hohen Tonhöhen.
  - 8) Rückkopplungen von Mikrofonen.

## TECHNISCHE DATEN

Typ	: 3-Weg, 3-Lautsprecher-Baßreflexbox Dual Giga-Tube Band-Pass Subwoofers
Lautsprecher	
Subwoofer	: 16.0 cm Konus × 1
Hauptwoofer	: 10.0 cm Konus × 1
Hochtöner	: 5 cm konus × 1
Belastbarkeit:	
Subwoofer	: 130 W
Hauptlautsprecher	: 55 W
Impedanz:	
Subwoofer	: 6 Ω
Hauptlautsprecher	: 6 Ω
Frequenzbereich:	
Subwoofer	: 30 Hz bis 120 Hz
Hauptlautsprecher	: 75 Hz bis 29 000 Hz
Schalldruckpegel:	
Subwoofer	: 78 dB/W·m (Durchschnitt von 50 Hz bis 100 Hz)
Hauptlautsprecher	: 85 dB/W·m (Durchschnitt von 400 Hz bis 800 Hz)
Abmessungen (B × H × T)	: 230 mm × 439 mm × 340mm
Gewicht	: Je 7,2 kg

Technische Änderungen vorbehalten.

## RACCORDEMENT

- NE PAS utiliser d'autre amplificateur que le CA-MXGT91R pour faire fonctionner les enceintes.
- Mettre hors circuit tout le système avant de raccorder les enceintes à l'amplificateur.
- La puissance maximale admissible par le haut-parleur principal du SP-MXGT91R est de 55 W, celle admissible par le haut-parleur d'extrêmes graves est de 130 W. En dépassant la puissance admissible, cela provoquera des bruits anormaux et détériorera les enceintes. Au cas où les signaux décrits ci-dessous sont envoyés aux enceintes, et même si ces signaux sont inférieurs à la puissance d'entrée maximum admissible, ils risquent de provoquer une surcharge ou même un incendie. S'assurer de bien diminuer le volume sonore de l'amplificateur.
  - 1) Parasites durant une syntonisation FM.
  - 2) Signaux de niveau élevé contenant des composants à haute fréquence, comme ceux générés par une platine d'enregistrement en mode avance rapide.
  - 3) Cliquetis se produisant lorsque d'autres appareils sont mis en ou hors circuit.
  - 4) Cliquetis se produisant lorsque des appareils sont branchés ou dé-branchés alors que leur alimentation est en circuit.
  - 5) Cliquetis se produisant lorsque la cellule d'une platine tourne-disque est changée alors que l'alimentation est en circuit.
  - 6) Cliquetis se produisant lorsque les commandes de l'amplificateur sont manipulées.
  - 7) Oscillations continues à haute fréquence ou sons très aigus provenant d'instruments de musique électroniques.
  - 8) Hurlements dus à l'utilisation de micros.

## CARACTÉRISTIQUES

Typ	: Enceinte 3 voices, 3 haut-parleurs type à réflexion des basses Dual Giga-Tube Band-Pass Subwoofers
Haut-parleurs	
Extrêmes graves	: conique de 16.0 cm × 1
Principal	: conique de 10.0 cm × 1
Aigus	: conique de 5 cm × 1
Puissance maximale admissible	
Haut-parleur d'extrêmes graves	: 130 W
Haut-parleur principal	: 55 W
Impédance	
Haut-parleur d'extrêmes graves	: 6 Ω
Haut-parleur principal	: 6 Ω
Bande passante	
Haut-parleur d'extrêmes graves	: 30 Hz–120 Hz
Haut-parleur principal	: 75 Hz–29 000 Hz
Pression sonore	
Haut-parleur d'extrêmes graves	: 78 dB/W·m (Moyenne de 50 Hz à 100 Hz)
Haut-parleur principal	: 85 dB/W·m (Moyenne de 400 Hz à 800 Hz)
Dimensions (L × H × P)	: 230 mm × 439 mm × 340mm
Masse	: 7,2 kg chaque

Présentation et caractéristiques modifiables sans préavis.

## AANSLUITINGEN

- Gebruik GEEN andere versterker dan de CA-MXGT91R om dit luidsprekersysteem aan te sturen.
- Schakel de spanning van alle aangesloten componenten uit alvorens de luidsprekers met de versterker te verbinden.
- Het maximale vermogen van de SP-MXGT91R hoofd-luidspreker is 55 W en van de subwoofer 130 W. Te hoge ingang kan in abnormale geluidsreproductie en in beschadigingen resulteren. Overbelasting en verbranding van de bedrading kan worden veroorzaakt, wanneer de hieronder beschreven signalen naar de luidsprekers worden gevoed, zelfs wanneer de signalen onder het maximaal toegestane ingangsvermogen zijn. Verminder eerst het volume van de versterker.
  - 1) Ruis, zoals dit optreedt tijdens afstemming op een FM-zender.
  - 2) Hoogfrequentie signalen van een hoog niveau, zoals die tijdens het vooruitspoelen van een tapedeck worden geproduceerd.
  - 3) Klikkende geluiden, die worden veroorzaakt door het in- en uitschakelen van de netspanning van andere componenten.
  - 4) Klikkende geluiden, zoals die worden geproduceerd bij het tot stand brengen of verbreken van aansluitingen terwijl de netspanning is ingeschakeld.
  - 5) Klikkende geluiden, zoals die optreden bij het vervangen van het element van een draaitafel terwijl de netspanning is ingeschakeld.
  - 6) Klikkende geluiden, zoals die worden geproduceerd door bediening van de schakelaars van de versterker.
  - 7) Voortdurende hoogfrequentie-oscillatie, of hoogtonige, elektronisch geproduceerde geluiden van muziekinstrumenten.
  - 8) Rondzingend geluid bij gebruik van microfoons.

## TECHNISCHE GEGEVENS

Type	: 3-weg 3-luidsprekers 4 bass reflex Dual Giga-Tube Band-Pass Subwoofers
Luidsprekers	
Subwoofer	: 16.0 cm kegeltype × 1
Hoofdwoofer	: 10.0 cm kegeltype × 1
Tweeter	: 5 cm kegeltype × 1
Maximale vermogen	
Subwoofer	: 130 W
Hoofd-luidspreker	: 55 W
Impedantie	
Subwoofer	: 6 Ω
Hoofd-luidspreker	: 6 Ω
Frekwentiëbereik	
Subwoofer	: 30 Hz–120 Hz
Hoofd-luidspreker	: 75 Hz–29 000 Hz
Geluidsdrumniveau	
Subwoofer	: 78 dB/W·m (Gemiddeld 50 Hz–100 Hz)
Hoofd-luidspreker	: 85 dB/W·m (Gemiddeld 400 Hz–800 Hz)
Afmetingen (B × H × D)	: 230 mm × 439 mm × 340mm
Gewicht	: Elk 7,2 kg

Veranderingen in technische gegevens et ontwerp onder voorbehoud.

## CONEXIÓN

- NO utilice ningún otro amplificador para operar este sistema de altavoces excepto CA-MXGT91R.
- Desactive la alimentación de todo el sistema antes de conectar los altavoces al amplificador.
- La capacidad máxima de potencia del altavoz principal del SP-MXGT91R es de 55 W y la del altavoz de subgraves es de 130 W.

Uná entrada excesiva resultará en ruido anormal y posibles daños.

En casos donde las señales descritas más abajo se apliquen a los altavoces, aunque las mismas resulten menores que la entrada máxima permisible, pueden causar una sobrecarga y quemar el cableado de los altavoces. Asegúrese de disminuir el volumen del amplificador con anterioridad.

  - 1) Ruido durante la sintonía en FM.
  - 2) Señales de alto nivel que contengan componentes de alta frecuencia producidos por un magnetófono en el modo de avance rápido.
  - 3) Ruidos de conmutación provocados al encender y apagar otros componentes.
  - 4) Ruido de conmutación al conectar o desconectar cables con los componentes encendidos.
  - 5) Ruido de conmutación cuando se reemplaza la cápsula con los componentes encendidos.
  - 6) Ruido de conmutación provocados por la operación de los selectores del amplificador.
  - 7) Continua oscilación de alta frecuencia o de sonidos de tonos altos provocados por instrumentos electrónicos.
  - 8) Aullidos a utilizar micrófonos.

## ESPECIFICACIONES

Tipo	: Reflex bajo con 3-altavoces y 3 vías Dual Giga-Tube Band-Pass Subwoofers
Altavoces	
De subgraves	: Tipo cónico de 16.0 cm × 1
Principal	: Tipo cónico de 10.0 cm × 1
De agudos	: Tipo cónico de 5 cm × 1
Capacidad de potencia	
De subgraves	: 130 W
Principal	: 55 W
Impedancia	
De subgraves	: 6 Ω
Principal	: 6 Ω
Gama de frecuencias	
De subgraves	: 30 Hz–120 Hz
Principal	: 75 Hz–29 000 Hz
Nivel de presión acústica	
De subgraves	: 78 dB/W·m (Promedio de 50Hz–100Hz)
Principal	: 85 dB/W·m (Promedio de 400Hz–800Hz)
Dimensiones (An × Al × Prf)	: 230 mm × 439 mm × 340mm
Peso	: 7,2 kg cada uno

El diseño y las especificaciones están sujetos a cambio sin aviso.



## COLLEGAMENTO

- NON usare un amplificatore diverso dal modello CA-MXGT91R per utilizzare questo sistema di altoparlanti.
- Spegnete la corrente dell'intero sistema prima di collegare gli altoparlanti all'amplificatore.
- La capacità di potenza massima dell'altoparlante principale del modello SP-MXGT91R è di 55 W e quella del subwoofer è di 130 W. Un ingresso eccessivo causerà un suono anormale e possibili danni.

Nel caso in cui i segnali descritti qui sotto vengono applicati agli altoparlanti, possono causare un sovraccarico e bruciare il cablaggio degli altoparlanti, anche se i segnali siano al di sotto dell'ingresso massimo ammesso.

Assicuratevi di diminuire il livello del volume dell'altoparlante prima di procedere.

- 1) Generazione di rumore durante la sintonizzazione FM.
- 2) Segnali di alto livello che contengono dei componenti ad alta frequenza riprodotti da una piastra a cassette nel modo di avanzamento rapido.
- 3) Si sentirà uno scatto quando accendete o spegnete la corrente degli altri componenti.
- 4) Si sentirà uno scatto quando collegate o scollegate i cavi con la corrente accesa.
- 5) Si sentirà uno scatto quando viene sostituita la cartuccia con la corrente accesa.
- 6) Si sentirà uno scatto quando vengono usati gli interruttori dell'amplificatore.
- 7) Oscillazione continua ad alta frequenza o suoni acuti da strumenti musicali elettronici.
- 8) Ululato quando usate i microfoni.

## SPECIFICAZIONI

Tipo	: Reflex basso con 3-altoparlanti e 3 vie Dual Giga-Tube Band-Pass Subwoofers
Altoparlanti	
Subwoofer	: Cono da 16.0 cm × 1
Woofer principale	: Cono da 10.0 cm × 1
Tweeter	: Cono da 5 cm × 1
Capacità di potenza	
Subwoofer	: 130 W
Altoparlante principale	: 55 W
Impedenza	
Subwoofer	: 6 Ω
Altoparlante principale	: 6 Ω
Gamma di frequenza	
Subwoofer	: 30 Hz–120 Hz
Altoparlante principale	: 75 Hz–29 000 Hz
Livello di pressione sonora	
Subwoofer	: 78 dB/W·m (Gamma di frequenza: 50–100 Hz)
Altoparlante principale	: 85 dB/W·m (Gamma di frequenza: 400–800 Hz)
Dimensioni (L × A × P)	: 230 mm × 439 mm × 340mm
Massa	: 7,2 kg ciascuno

## ANSLUTNING

- Använd INTE någon annan förstärkare än CA-MXGT91R till att driva detta högtalarsystem med.
- Slå av strömmen i alla apparater i ljudanläggningen innan högtalarna ansluts till förstärkaren.
- Maximal effekthanteringskapacitet för SP-MXGT91R är 55 W för huvudhögtalare/130 W för lågbashögtalare. Brus uppstår i ljudet och högtalarna kan skadas om de matas med för hög effekt. I situationerna som beskrivs nedan kan högtalarna också överbelastas och kabeltråden inne i högtalarna brännas sönder, fastän högtalarnas effekt inte har överskridits. Sänk därför ljudstyrkan på förhand.
  - 1) Brus under inställning av FM-radiostationer.
  - 2) Starka, högfrekventa signaler från ett kassettdäck under snabbspolning framåt.
  - 3) Ljudbangar som uppstår när andra apparater i anläggningen slås till och från.
  - 4) Skrapljud som uppstår när anslutningskablar ansluts eller kopplas från medan strömmen är på.
  - 5) Skrapljud som uppstår när pickupelementet på en skivspelare byts medan strömmen är på.
  - 6) Ljudbangar som uppstår när du använder förstärkarens omkopplare.
  - 7) Kontinuerliga, högfrekvenssvängningar eller högfrekvent ljud från elektroniska musikinstrument.
  - 8) Akustisk återkoppling (tjutande ljud) vid bruk av mikrofoner.

## TEKNISKA DATA

Typ	: 3-vägs, 3-elements basreflexhögtalare Dual Giga-Tube Band-Pass Subwoofers
Högtalarelement	
Lågbaselement	: 16.0 cm kon × 1
Huvudbaselement	: 10.0 cm kon × 1
Diskantelement	: 5 cm kon × 1
Effekthanteringskapacitet	
Lågbashögtalare	: 130 W
Huvudhögtalare	: 55 W
Impedans	
Lågbashögtalare	: 6 Ω
Huvudhögtalare	: 6 Ω
Frekvensomfång	
Lågbashögtalare	: 30 Hz–120 Hz
Huvudhögtalare	: 75 Hz–29 000 Hz
Ljudtrycksnivå	
Lågbashögtalare	: 78 dB/W·m (50–100 Hz i genomsnitt)
Huvudhögtalare	: 85 dB/W·m (400–800 Hz i genomsnitt)
Yttermått (B × H × D)	: 230 mm × 439 mm × 340mm
Vikt	: 7,2kg perst.

*Il disegno e le specificazioni sono soggetti a cambiamenti senza preavviso.*

*Rätt till ändringar av utförande och specifikationer förbehålles utan föregående meddelande.*

## TILSLUTNING

- Anvend IKKE anden forstærker end CA-MXGT91R til drift af dette højttalersystem.
- Sluk for strømmen til hele systemet før højttalerne forbindes til forstærkeren.
- Den maksimale belastningskapacitet for SP-MXGT91R hovedhøjttaleren er 55 W/for subwooferen 130 W.

For kraftigt indgangssignal vil resultere i unormal støj og muligvis beskadigelse.

I tilfælde hvor højttalerne udsættes for signaler beskrevet nedenfor, kan der forekomme overbelastning og overbrænding af ledningerne i højttalerne selv om signalstyrken er under den maksimale tilladte værdi. Husk derfor at sænke højttalerlydstyrken i forvejen.

- 1) Støj under FM-afstemning.
- 2) Signaler med høje niveauer der indeholder højfrekvente komponenter dannet af en båndoptager der er indstillet til hurtig fremspoling.
- 3) Klikstøj dannet når der tændes eller slukkes for strømmen til andre komponenter.
- 4) Klikstøj der dannes når ledninger tilsluttes eller tages ud af forbindelse mens der er tændt for strømmen.
- 5) Klikstøj der dannes når pickuppen udskiftes mens der er tændt for strømmen.
- 6) Klikstøj der dannes når forstærkerens omskiftere betjenes.
- 7) Fortsat høj frekvenssvingning, eller en højlyd dannet af et elektronisk instrument.
- 8) Hyletoner når der anvendes en mikrofon.

## SPECIFIKATIONER

Type	: 3-vejs basrefleks-højttaler med 3-elementer Dual Giga-Tube Band-Pass Subwoofers
Højttalere	
Subwoofer	: 16,0 cm membran × 1
Hoved-bashøjttaler	: 10,0 cm membran × 1
Diskantenhed	: 5 cm membran × 1
Belastningskapacitet	
Subwoofwer	: 130 W
Hovedhøjttaler	: 55 W
Impedans	
Subwoofwer	: 6 Ω
Hovedhøjttaler	: 6 Ω
Frekvensområde	
Subwoofwer	: 30 Hz–120 Hz
Hovedhøjttaler	: 75 Hz–29 000 Hz
Lydtryksniveau	
Subwoofwer	: 78 dB/W·m (Gennemsnit på 50 Hz–100 Hz)
Hovedhøjttaler	: 85 dB/W·m (Gennemsnit på 400 Hz–800 Hz)
Mål (B × H × D)	: 230 mm × 439 mm × 340mm
Vægt	: 7,2 kg hver

*Design og specifikationer kan blive ændret uden varsel.*

## LIITÄNTÄ

- ÄLÄ käytä muuta vahvistinta tämän kaiutinjärjestelmän käyttöön paitsi mallille CA-MXGT91R.
- Katkaise koko järjestelmän virta ennen kuin suoritat liitännät kaiuttimista vahvistimeen.
- Mallin SP-MXGT91R pääkaiuttimen enimmäisteho on 55 W, apubassokaiuttimen 130 W. Liiallinen antoteho aiheuttaa epänormaalia kohinaa ja jopa vahinkoa.  
Tapauksissa, missä kaiuttimet joutuvat alla kuvattujen signaalien kohteeksi, vaikka signaalit olisivat alle sallitun maksimi antotehon, ne saattavat aiheuttaa ylikuormitusta ja polttaa kaiuttimien johdot.  
Vähennä siis vahvistimen äänenvoimakkuutta jo ennalta.
  - 1) Kohinaa FM-virityksen aikana.
  - 2) Kasettidekistä eteenpäinkelauksen aikana muodostuneet vahvat, korkeataajuuksisia komponentteja sisältävät signaalit.
  - 3) Klik-ääni, joka syntyy silloin kun toisten osien virta kytketään ja katkaistaan.
  - 4) Klik-ääni, joka syntyy silloin kun kytketään tai irrotetaan johtoja virran ollessa päällä.
  - 5) Klik-ääni, joka syntyy silloin kun vaihdetaan hylsy virran ollessa päällä.
  - 6) Klik-ääni, joka syntyy silloin kun käytetään vahvistimen kytkimiä.
  - 7) Jatkuva korkea värähtely tai elektronisesti tuotettu korkea soittimen ääni.
  - 8) Ulinaa mikrofonia käytettäessä.

## TEKNISET TIEDOT

Tyyppi	: 3-tie, 3 kaiuttimen bassorefleksi Dual Giga-Tube Band-Pass Subwoofers
Kaiuttimet	
Apubasso	: 16,0 cm karitomuotoinen × 1
Pääbasso	: 10,0 cm karitomuotoinen × 1
Diskantti	: 5,0 cm karitomuotoinen × 1
Enimmäisteho	
Apubasso	: 130 W
Pääkaiutin	: 55 W
Impedanssi	
Apubasso	: 6 Ω
Pääkaiutin	: 6 Ω
Taajuusala	
Apubasso	: 30 Hz–120 Hz
Pääkaiutin	: 75 Hz–29 000 Hz
Äänenpainetaso	
Apubasso	: 78 dB/W·m (Keskimäärin 50 Hz–100 Hz)
Pääkaiutin	: 85 dB/W·m (Keskimäärin 400 Hz–800 Hz)
Mitat (L × K × S)	: 230 mm × 439 mm × 340 mm
Paino	: 7,2 kg perst.

*Oikeudet muutoksiin pidätetään.*

## Free Manuals Download Website

<http://myh66.com>

<http://usermanuals.us>

<http://www.somanuals.com>

<http://www.4manuals.cc>

<http://www.manual-lib.com>

<http://www.404manual.com>

<http://www.luxmanual.com>

<http://aubethermostatmanual.com>

Golf course search by state

<http://golfingnear.com>

Email search by domain

<http://emailbydomain.com>

Auto manuals search

<http://auto.somanuals.com>

TV manuals search

<http://tv.somanuals.com>